

RADIOACTIVE SUBSTANCES
AND THEIR
RADIATIONS

CAMBRIDGE UNIVERSITY PRESS

London: FETTER LANE, E.C.

C. F. CLAY, MANAGER



Edinburgh: 100, PRINCES STREET

London: H. K. LEWIS, 136, GOWER STREET, W.C.

Berlin: A. ASHER AND CO.

Leipzig: F. A. BROCKHAUS

Leipzig: AKADEMISCHE VERLAGSGESELLSCHAFT m. b. H.

New York: G. P. PUTNAM'S SONS

Bombay and Calcutta: MACMILLAN AND CO., LTD.

All rights reserved

RADIOACTIVE SUBSTANCES
AND THEIR
RADIATIONS

BY

E. RUTHERFORD, D.Sc., Ph.D., LL.D., F.R.S.

— NOBEL LAUREATE

LANGWORTHY PROFESSOR OF PHYSICS, UNIVERSITY OF MANCHESTER

Cambridge :
at the University Press

1913

Cambridge :

PRINTED BY JOHN GLAY, M.A.

AT THE UNIVERSITY PRESS

PREFACE

IN 1904 I published through the Cambridge University Press a collected account of radio-active phenomena entitled *Radio-activity*. This was followed a year later by a revised and enlarged edition. In the seven years that have elapsed since the latter publication there has been a steady and rapid growth of our knowledge of the properties of the radiations from active substances, and of the remarkable series of transformations that occur in them. In the present work I have endeavoured to give an accurate and concise account of the whole subject as it stands to-day within the compass of a single volume. A few pages from the earlier book have been utilised, but, otherwise, the present volume is an entirely new work.

It is of interest to signalise some of the main directions of advance since the publication of the second edition of my *Radio-activity*. There has been a very great increase in the amount and accuracy of our knowledge of the radiations from active substances, the nature of their absorption by matter, and of their connection with the transformations. The discovery of methods of counting single α particles has proved of great service not only in extending our knowledge of the α rays, but also in obtaining accurate data for the calculation of a number of important radio-active quantities and atomic magnitudes. The discovery of the recoil of radio-active atoms resulting from the expulsion of α particles has proved

very valuable as a means of separation of radio-active substances, and has also added another very interesting type of corpuscular radiation for study. Our knowledge of the series of transformations in active substances has been much extended. In 1905 twenty of these were known; the number is now thirty-two, and there is some evidence that a few still remain undetected.

The study of radio-activity is concerned not only with the radiations and transformations of active substances, but also with the distribution of active matter and the products of its transformation in minerals and throughout the earth's crust and atmosphere. The researches of Strutt, Joly, and others, have added greatly to our knowledge of the amount and distribution of active matter in typical rocks, and have indicated that the accompanying heating effect has an important bearing on the duration of the earth's internal heat and on geological changes in general. The investigations of Elster and Geitel, Eve, and others have brought out clearly that the electrical state of our atmosphere is undoubtedly influenced greatly by the distribution of active matter throughout it. The use of radio-active substances for therapeutic purposes has been widely extended, but a consideration of this question is outside the scope of the present volume.

In one respect the treatment of the subject has necessitated very little change; for the transformation theory advanced in explanation of radio-active phenomena has undergone no essential modification in the interval. This theory has been found not only to give a reasonable explanation of all the facts that are at present known, but has suggested many lines of investigation resulting in a wide extension of our knowledge.

The passages in my previous work, which I have found it desirable to retain are, mainly, those dealing with the ionisation of gases and the methods of radio-active measurement, for it seemed to me that the book was in no sense complete without

a brief reference to these important subjects. I have added three short Appendixes, the subject-matter of which could not be conveniently included in the main body of the volume. In the first an account is given of the methods of measurement of quantities of radium. In the second a brief statement is given of the remarkable method devised by C. T. R. Wilson for rendering visible the trails of single α and β particles. I am much indebted to Mr C. T. R. Wilson for permission to reproduce two of the admirable photographs obtained by him. A short account is also given of improvements in methods for registering the effects produced by single α particles, and for counting the number emitted by radio-active substances.

I desire to express my sincere thanks to Professor B. B. Boltwood of Yale University, and Dr H. Geiger for the great care and trouble they have taken in the correction of proofs, and for many helpful suggestions. I am also greatly indebted to Dr Geiger for undertaking the laborious task of revising the great number of references to original work which are included in the volume.

E. RUTHERFORD.

UNIVERSITY OF MANCHESTER,

October, 1912.

TABLE OF CONTENTS

CHAP.	PAGE
I. ✓ Radio-active Substances	1
II. Ionisation of Gases	26
III. Methods of Measurement	87
IV. ✓ The Alpha Rays	114
V. ✓ The Beta Rays	193
VI. ✓ The Gamma or Very Penetrating Rays	257
VII. ✓ Properties of the Radiations	296
VIII. ✓ Continuous Production and Decay of Radio-active Matter	329
IX. Radio-active Gases	347
X. Active Deposits	391
XI. ✓ Theory of Successive Transformations	410
XII. Uranium, Ionium, and the Origin of Radium	444
XIII. Radium and its Emanation	469
XIV. Active Deposit of Radium	486
XV. Actinium and its Products	519
XVI. Thorium and its Products	534
XVII. Production of Helium and Emission of Heat	553
XVIII. General Results and Relations	587
XIX. Radio-activity of the Earth and Atmosphere	624
Appendix A. Comparison of quantities of Radium and International Radium Standard	657
Appendix B. The Tracks of Ionising Particles in Gases ; Counting of α Particles	663
Appendix C. Tables	665
Index	671

Figures printed as Plates

Figures 70 A, B, C	<i>to face p.</i> 253
Figure 81	" <i>p.</i> 303
Figures 82 A, B }	" <i>p.</i> 310
Figures 83 A, B }	" <i>p.</i> 310
Figure 109	" <i>p.</i> 482
Figures 1, 2, 3	" <i>p.</i> 664

CHAPTER I.

RADIO-ACTIVE SUBSTANCES.

1. **Introduction.** The close of the old and the beginning of the new century have been marked by a very rapid increase of our knowledge of that most important but comparatively little known subject—the connection between electricity and matter. No study has been more fruitful in surprises to the investigator, both from the remarkable nature of the phenomena exhibited and from the laws controlling them. The more the subject is examined, the more complex must we suppose the constitution of matter in order to explain the remarkable effects observed. While the experimental results have led to the view that the constitution of the atom itself is very complex, at the same time they have confirmed the old theory of the discontinuous or atomic structure of matter. The study of the radio-active substances and of the discharge of electricity through gases has supplied very strong experimental evidence in support of the fundamental ideas of the existing atomic theory. It has also indicated that the atom itself is not the smallest unit of matter, but is a complicated structure made up of a number of smaller bodies.

A great impetus to the study of this subject was initially given by the experiments of Lenard on the cathode rays, and by Röntgen's discovery of the X rays. An examination of the conductivity imparted to a gas by the X rays led to a clear view of the mechanism of the transport of electricity through gases by means of charged ions. This ionisation theory of gases has been shown to afford a satisfactory explanation not only of the passage of electricity through flames and vapours, but also of the

complicated phenomena observed when a discharge of electricity passes through a vacuum tube. At the same time, a further study of the cathode rays showed that they consisted of a stream of charged particles, projected with great velocity, and possessing an apparent mass small compared with that of the hydrogen atom. The connection between the cathode and Röntgen rays and the nature of the latter were also closely examined. Much of this admirable experimental work on the nature of the electric discharge has been done by Professor Sir J. J. Thomson and his students in the Cavendish Laboratory, Cambridge.

An examination of natural substances, in order to see if they gave out dark radiations similar to X rays, led to the discovery of the radio-active bodies which possess the property of spontaneously emitting radiations, invisible to the eye, but readily detected by their action on photographic plates and by their power of discharging electrified bodies. A detailed study of the radio-active bodies has revealed many new and surprising phenomena which have thrown much light, not only on the nature of the radiations themselves, but also on the processes occurring in those substances. Notwithstanding the complex nature of the phenomena, the knowledge of the subject has advanced with great rapidity, and a large amount of experimental data has now been accumulated.

In order to explain the phenomena of radio-activity, Rutherford and Soddy in 1903 advanced a theory which regards the atoms of the radio-active elements as suffering spontaneous disintegration, and giving rise to a series of radio-active substances which differ in chemical properties from the parent elements. The radiations accompany the breaking-up of the atoms, and afford a comparative measure of the rate at which the disintegration takes place. This theory is found to account in a satisfactory way for all the known facts of radio-activity, and welds a mass of disconnected facts into one homogeneous whole. On this view, the continuous emission of energy from the active bodies is derived from the internal energy inherent in the atom itself, and does not in any way contradict the law of the conservation of energy. At the same time, however, it indicates that an enormous store of latent energy is resident in the atoms

themselves. This store of energy had not been observed previously, on account of the impossibility of breaking up into simpler forms the atoms of the elements by the action of the chemical or physical forces at our command.

On this theory we are witnessing in the radio-active bodies a veritable transformation of matter. This process of disintegration was initially investigated, not by direct chemical methods, but by means of the property possessed by the radio-active bodies of giving out specific types of radiation. In the case of weak radio-active substances like uranium and thorium, the process of disintegration takes place so slowly that it would only be possible by working with large quantities in a limited time to obtain direct evidence of the transformation by means of the balance or spectroscope. In the case, however, of a very active substance like radium, the process of disintegration is sufficiently rapid to obtain convincing evidence of transformation with quantities of material weighing only a fraction of a gram. In illustration, we may refer to the isolation and determination of the physical and chemical properties of that most remarkable gas, known as the radium emanation, which is a product of the transformation of radium. The proof of the continuous production from radium and other radio-active substances of the rare gas helium has added a strong link in the chain of evidence in support of the transformation theory. Several products of the transformation of the radio-active bodies have been obtained in sufficient quantity to examine by ordinary chemical methods, and a further study of these and other radio-active substances opens up new and important fields of chemical enquiry.

In this book the experimental facts of radio-activity and the connection between them are interpreted on the disintegration theory. Most of the phenomena observed can be investigated in a quantitative manner, and prominence has been given to work of this character, for the agreement of any theory with the facts, which it attempts to explain, must ultimately depend upon the results of accurate measurement.

The value of any working theory depends upon the number of experimental facts it serves to correlate, and upon its power of suggesting new lines of work. In these respects the disintegration

theory, whether or not it may ultimately be proved to be correct, has already been completely justified by its results.

Not only has it served as a reliable guide to the investigator in tracing the long series of transformations taking place in radio-active matter, but it has predicted numerous relations which have afterwards been verified by experiment. It is safe to say that the rapidity of growth of accurate knowledge of radio-active phenomena has been largely due to the influence of the disintegration theory.

2. Radio-active substances. The term "radio-active" is now generally applied to a class of substances, such as uranium, thorium, radium, and their compounds, which possess the property of *spontaneously* emitting radiations capable of passing through plates of metal and other substances opaque to ordinary light. The characteristic property of these radiations, besides their penetrating power, is their action on a photographic plate and their power of discharging electrified bodies. In addition, a strongly radio-active body like radium is able to cause marked phosphorescence and fluorescence on some substances placed near it. In the above respects the radiations possess properties analogous to Röntgen rays, but it will be shown that, for the major part of the radiations emitted, the resemblance is only superficial.

The most remarkable property of the radio-active bodies like uranium and thorium is their power of radiating energy spontaneously and continuously at a constant rate, without, as far as is known, the action upon them of any external exciting cause. The phenomena at first sight appear to be in direct contradiction to the law of conservation of energy, since no obvious change with time occurs in the radiating material. The phenomena appear still more remarkable when it is considered that the radio-active bodies must have been steadily radiating energy since the time of their formation in the earth's crust.

It is difficult to give at this stage a short and rigorous definition of the term "radio-active." It is not sufficient to say that a radio-active substance emits a type of penetrating radiation, for we shall see that a few substances which are

ordinarily called radio-active either emit no specific radiation or, at any rate, emit radiations of such small penetrating power that they are difficult to detect. At the same time, each of these so-called "rayless" products exhibits the main characteristic of radio-active substances, *i.e.* it undergoes spontaneous atomic transformation and gives rise to a new substance, which itself may emit characteristic penetrating radiations. From this point of view, it is desirable to restrict the term "radio-active" to substances which undergo spontaneous atomic transformation, without regard to the character of the radiation emitted.

The discharging and photographic action alone cannot be taken as a criterion as to whether a substance is radio-active or not. It is necessary in addition to examine the radiations, and to test whether the actions take place through appreciable thicknesses of all kinds of matter opaque to ordinary light. For example, a body giving out short waves of ultra-violet light could be made to behave in many respects like a radio-active body. As Lenard* has shown, short waves of ultra-violet light will ionise the gas in their path, and will be absorbed rapidly in the gas. They will produce strong photographic action, and may pass through *some* substances opaque to ordinary light. The similarity to a radio-active body is thus fairly complete as regards these properties. On the other hand, the emission of these light waves, unlike that of the radiations from an active body, will depend largely on the molecular state of the compound, or on temperature and other physical conditions. But the great point of distinction lies in the nature of the radiations from the bodies in question. In one case the radiations behave as transverse waves, obeying the usual laws of light waves, while in the case of a naturally active body, they consist for the most part of a continuous flight of material particles projected from the substance with great velocity.

Several substances have been found which are able under certain conditions to discharge positive and negative electricity at a rapid rate. For example, a freshly cut surface of phosphorus brought near to an electrified body is able to discharge it. This discharging power, however, is not due to an ionisation of the gas

* Lenard, *Annal. d. Phys.* 1, p. 498; 3, p. 298, 1900.

by a penetrating radiation, as in the case of uranium, but rather to chemical action taking place at its surface. The compounds of phosphorus do not exhibit any effect, and in this respect phosphorus differs completely from uranium and the other radio-active bodies where the activity is an atomic property.

Le Bon* has also observed that quinine sulphate, if heated and then allowed to cool, possesses for a short time the property of discharging both positively and negatively electrified bodies. It is necessary, however, to draw a sharp line of distinction between phenomena of this kind and those exhibited by the naturally radio-active bodies. While both, under special conditions, possess the property of ionising the gas, the laws controlling the phenomena are quite distinct in the two cases. For example, only one compound of quinine shows the property, and that compound only when it has been subjected to a preliminary heating. The action of phosphorus depends on the nature of the gas, and varies with temperature. On the other hand, the activity of the naturally radio-active bodies is spontaneous and is exhibited by all compounds, and is not altered by change in the chemical or physical conditions.

3. Discovery of radio-activity. The discovery by Röntgen in 1895 of the X rays and their remarkable properties created the most intense interest throughout the scientific world. It occurred to several physicists to try whether ordinary bodies emitted a similar radiation, which was able to pass through matter opaque to ordinary light. Since the production of X rays by a discharge through a vacuum tube appeared to be connected with the strong phosphorescence and fluorescence excited on the glass by the cathode rays, it was natural at first to examine those substances which phosphoresced brightly under the action of light. Several observers at first affirmed the presence of such a penetrating radiation from phosphorescent calcium sulphide; but these results have not stood the test of more rigorous experiment. Following out the same idea, Professor Henri Becquerel exposed a number of phosphorescent substances enveloped in black paper under a photographic plate. The results

* Le Bon, *C. R.* 130, p. 891, 1900.

were entirely negative. It then occurred to him to try experiments with the salts of uranium, the phosphorescence of which had been previously investigated by him. Among these salts were some fine crystals of the double sulphate of uranium and potassium, which he had prepared about fifteen years before. The crystals were first exposed to light and then enveloped with two layers of black paper, and placed below the photographic plate with a small plate of silver between. After an exposure of several hours and development, a distinct photographic effect was observed. The experiment was at once repeated with a plate of glass 0.1 mm. thick between the uranium salt and the photographic plate in order to cut off effects due to possible vapours. A distinct but slightly feebler photographic impression was again obtained.

The results of these experiments, which were communicated to the Academy of Sciences at Paris on February 24th, 1896, indicated that the salt of uranium emitted a type of radiation capable of penetrating through a considerable thickness of matter opaque to ordinary light. These simple experiments mark the discovery of a new property of matter—radio-activity—the further investigation of which was to lead to such remarkable consequences*.

It was at first natural to suppose that the emission of penetrating rays was in some way connected with the power of phosphorescence, but later observations by Becquerel† showed that there was no connection whatever between them. The uranic salts are phosphorescent, while the uranous salts are not. The uranic salts, when exposed to ultra-violet light in the phosphoroscope, give a phosphorescent light lasting about .01 second. When the salts are dissolved in water, the duration is still less. The non-phosphorescent are equally active with the phosphorescent compounds. The amount of radiation given out is unaltered if the uranium salt be kept continuously in darkness. The rays are given out by solutions, and by crystals which have been deposited from solutions in the dark and never exposed to light. This shows that the radiation cannot be due in any way

* Becquerel, *C. R.* **122**, pp. 420, 501, 559, 689, 762, 1086. 1896.

† Becquerel, *C. R.* **122**, p. 504, 1896.

to the gradual emission of energy stored up in the crystal in consequence of exposure to a source of light.

The property of emitting a type of penetrating radiation was found to be exhibited by all the compounds of uranium and by the metal itself. The photographic effect of any given compound depends on the thickness of the layer employed and the proportion of uranium present.

The power of giving out penetrating rays thus seems to be a specific property of the element uranium, since it is exhibited by the metal as well as by all its compounds. These radiations from uranium are persistent, and, as far as observations have yet gone, are unchanged, either in intensity or character, with lapse of time. Observations to test the constancy of the radiations for long periods of time were initially made by Becquerel by the photographic method and Mme Curie by the electric method, but no appreciable variation was observed over an interval of five years. This result is to be expected in view of our later knowledge, for it will be seen later that, while the activity of uranium itself must decrease with the time, the variation is so slow that an interval measured by millions of years would be required to show any detectable change. The comparative permanency of the radiation from uranium itself must not be confused with the fact that the activity of ordinary compounds of uranium can be temporarily reduced by separation of one or more of its radio-active constituents.

The activity of uranium is unaffected by changes of temperature, or by the action of any physical or chemical agency. No definite proof has yet been given that the radio-active processes occurring in uranium or in any radio-active substance can be altered in any way by the most drastic physical or chemical treatment. The energy radiated in various forms from uranium and its compounds is derived from the uranium itself, and accompanies the transformation of the uranium atoms.

In addition to the action of the rays from uranium on a photographic plate, Becquerel* showed that uranium rays, like Röntgen rays, possessed the important property of discharging both positively and negatively electrified bodies. This effect is

* Becquerel, *C. R.* **122**, p. 559, 1896.

most simply shown by bringing an uncovered uranium compound near the charged plate of an electroscope. The dissipation of the charge is shown by the rapid collapse of the gold leaves. The results obtained by Becquerel were confirmed and extended by Lord Kelvin, Smolan and Beattie*. The writer† made a detailed comparison of the nature of the discharge produced by uranium rays, and showed that in both cases the dissipation of an electric charge is due to the production of charged ions by the radiations throughout the volume of the gas. This electric property of the radiations is of great importance, and has formed the basis of a qualitative and quantitative examination of the radiations from radio-active bodies. A detailed account of this method is given in Chapter II.

From his earlier experiments, Becquerel concluded that the rays from uranium were intermediate in properties between ordinary light and X rays, since he observed some evidence of reflection, refraction, and polarisation. The results were not confirmed by later experiments of Le Bon, Rutherford and Becquerel himself. While there is no evidence of direct reflection, there is always a diffuse reflection of the penetrating radiation striking an obstacle, so that the shadow of an absorbing screen is always surrounded by a diffuse border. The absence of the properties of light waves necessarily follows from our present knowledge of the nature of the uranium rays; for the radiation, mainly responsible for the photographic effects, consists of a flight of charged particles projected with great velocity.

The radiations from uranium are complex in character, and will be shown later to consist of three distinct types known as the alpha, beta and gamma rays (α , β , γ). The α rays, which are very easily absorbed by thin sheets of metal foil or by gases, consist of a stream of positively charged particles projected with great velocity. The β rays are far more penetrating and are identical with the negatively charged particles constituting the cathode rays. The γ rays, which are very penetrating, appear to be analogous in properties to the X rays. With a thin layer of any uranium compound, the electric discharge is due mainly to

* *Phil. Mag.* **43**, p. 418, 1897; **45**, p. 277, 1898.

† Rutherford, *Phil. Mag.* **47**, p. 109, 1899.

the α rays. The electric effect due to the γ rays is very feeble in comparison and is difficult to detect unless several hundred grams of material are employed as a source of radiation.

The radiations from uranium are thus analogous, as regards their photographic and electrical actions, to X rays, but compared with the rays from an ordinary X ray tube, these actions are extremely feeble. While with X rays a strong impression is produced on a photographic plate in a few minutes or even by a single discharge, a day's exposure to the uranium rays is required to produce a well-marked action, even though the uranium compound, enveloped in black paper, is placed close to the plate. The discharging action, while very easily measurable by suitable methods, is also small compared with that produced by X rays from an ordinary focus tube.

4. Thorium. Following the discovery of the activity of uranium, the question naturally arose whether this property was confined to uranium and its compounds or whether it was exhibited to an appreciable extent by other substances. In the course of an examination of a number of substances by the electric method, G. C. Schmidt*, and independently Mme Curie†, found that thorium and its compounds and also thorium minerals possessed properties similar to those of uranium. The rays from thorium compounds, like those from uranium, possess the property of discharging bodies and acting on a photographic plate. Under the same conditions, the discharging action of the rays is about equal to that of uranium, but the photographic effect due to the β rays is distinctly weaker. Thorium like uranium emits α , β and γ rays, but the γ rays from thorium are more intense and more penetrating than those from uranium.

The presence of thorium in a substance can be readily determined by its property of emitting a radio-active emanation, which has all the properties of a radio-active gas. The emanation can be removed from the thorium compound by means of a current of air, and its activity can be detected at a distance. The activity of the emanation is not permanent but practically disappears in the course of ten minutes.

* Schmidt, *Ann. d. Phys.* **65**, p. 141, 1898.

† Mme Curie, *C. R.* **126**, p. 1101, 1898.

A detailed examination of thorium has shown that it contains a number of radio-active substances which are derived from the transformation of thorium itself. Two of these products, discovered by Hahn* and called *meso-thorium* and *radio-thorium*, retain a considerable fraction of their activity for some years. Meso-thorium, which has chemical properties very similar to those of radium, can be separated from the thorium on a commercial scale, and preparations of this substance, which have an activity comparable with that of pure radium, are now sold commercially. An account of the chemical properties of the numerous radio-active substances derived from thorium will be discussed in detail later.

The activity of compounds of thorium which have been separated from thorium minerals is initially not constant. The activity measured by the α rays decreases slowly for several years, passes through a minimum, and finally after a long interval reaches a maximum value which is equal to that in an equal weight of thorium in the mineral before separation. This variation of activity is not due to any variation of the activity of thorium itself, but is due to the growth in the thorium of new radio-active substances which had been left behind in the isolation of thorium by commercial methods. There is reason to believe that thorium in radio-active equilibrium ultimately decreases in activity at a rate even slower than that of uranium.

5. Potassium. By the electrical method, using a suitable electroscope or electrometer, it is possible to measure easily the activity of any substance which shows an effect of 1/1000 of that of uranium. With special precautions it is possible to detect and measure still smaller activities. Mme Curie made a detailed examination by the electric method of a great majority of known substances, including the very rare elements, in order to see if they showed any activity. In many cases several compounds of the elements were examined. With the exception of thorium already mentioned and phosphorus, none of the other substances possessed an activity of even 1/100 of that of uranium. It has

* Hahn, *Proc. Roy. Soc.* **76**, p. 115, 1905; *Phys. Zeit.* **8**, p. 277, 1907; **9**, p. 392, 1908.

already been pointed out in section 2 that the discharging effect of phosphorus is due to a surface chemical action, and is not due to radio-activity.

The examination of substances of very feeble activity is complicated by the fact that ordinary materials show a minute activity. As a result of a detailed examination of the activity of ordinary matter, N. R. Campbell* discovered in 1907 that the compounds of potassium and of rubidium showed an activity considerably greater than the majority of ordinary substances. The investigation of this property of potassium is very difficult on account of the smallness of the electrical effects. There seems, however, little doubt but that potassium has a specific radio-activity, for it is shown by all the compounds of potassium, whether obtained from potassium deposits in the earth or from wood ashes. Unlike the majority of radio-active bodies, potassium apparently emits only β rays of penetrating power about equal to those of uranium. The small electrical effect, due to potassium, may be judged from the observation that the activity is only about 1/1000 that of the β rays of an equal weight of uranium compound.

This property of potassium and of rubidium is of great interest, for besides the elements of high atomic weight, uranium, thorium, radium and their products, they are the only other chemical substances of small atomic weight that show radio-activity. In some cases, other substances have been found to show a trace of activity, but no proof has been given that it is due to the element itself, and not to some radio-active impurity present. Taking into account the wide dissemination of radio-active materials throughout the earth's crust, it would not be surprising to find that some of the numerous radio-active substances would be separated in minute amount with some of the permanent elements. For example, it is to be anticipated that both lanthanum and cerium would show a slight activity, since it is known that the radio-active substance, actinium, is normally separated with them.

6. The discovery of radium. Mme Curie examined the radio-activity of a large number of minerals containing uranium

* Campbell and Wood, *Proc. Camb. Phil. Soc.* **14**, p. 15, 1907. Campbell, *Proc. Camb. Phil. Soc.* **14**, p. 211, 1907.

and thorium. The electrical method was used, was measured between two parallel plates 8 cms. in 3 cms. apart, when one plate was covered with a uniform layer of the active matter in a powdered state. On account of the importance of these measurements, some of her determinations are given below; the numbers give the order of the saturation maximum current i in amperes.

					i
Pitchblende from	Johanngeorgenstadt				8.3×10^{-11}
„	Joachimsthal	7.0 „
„	Pzibran	6.5 „
„	Cornwall	1.6 „
Clevite	1.4 „
Chalcolite	5.2 „
Autunite	2.7 „
Carnotite	6.2 „
Thorite	from 0.3 to 1.4	„
Orangite	2.0 „

Some activity is to be expected in these minerals, since they all contain either uranium or thorium or a mixture of both. An examination of the action of the uranium compounds with the same apparatus and under the same conditions led to the following results:

					i
Uranium (containing a little carbon)					2.3×10^{-11} amperes
Black oxide of uranium	2.6 „
Green „	„	„	1.8 „
Sulphate of uranium and potassium					0.7 „
Acetate	0.7 „
Phosphate of copper and uranium					0.9 „

The interesting point in connection with these results is that some specimens of pitchblende have about four times the activity of the metal uranium; chalcolite, the crystallised phosphate of copper and uranium, is twice as active as uranium; and autunite, a phosphate of calcium and uranium, is as active as uranium. From the previous considerations, none of the substances should have shown as much activity as uranium or thorium. In order to be sure that the large activity was not due to the particular chemical combination, Mme Curie prepared chalcolite artificially, starting with pure products. This artificial chalcolite had the

pected from its composition, viz. about 0.4 of the uranium. The natural mineral chalcocite is thus times as active as the artificial mineral.

From her observations of the activity of different compounds of uranium Mme Curie concluded that the radio-activity of uranium is an atomic property, *i.e.* that the total radiation emitted from a compound was proportional to the amount of uranium element present, and independent of its combination with other inactive substances. The observed activity of thick layers of the compound is, of course, to some extent affected by the amount of inactive elements present. On this view, it seemed probable that the large activity of some of these minerals compared with uranium and thorium must be due to the presence of small quantities of an unknown element or elements of activity greater than uranium and thorium. Relying on this hypothesis, M. and Mme Curie proceeded to examine whether it was possible to separate this unknown active substance from uranium minerals. Their work was completely successful, and led immediately to the discovery of two new substances called polonium and radium, the latter of which in the pure state is now known to have an activity of several million times that shown by an equal weight of uranium.

This important discovery was due entirely to the property of radio-activity possessed by the new bodies. The only guide in their separation was the activity of the products obtained. In this respect the discovery of these bodies is quite analogous to the discovery of rare elements by the methods of spectrum analysis. The method employed in the separation consisted in examining the relative activity of the products after chemical treatment. In this way it was seen whether the radio-activity was confined to one or another of the products, or divided between both, and in what ratio such division occurred.

The activity of the specimens thus served as a basis of rough qualitative and quantitative analysis, and in some respects to the indication of the spectroscopist. To obtain comparative data it was necessary to test all the products in the dry state. The chief difficulty lay in the fact that pitchblende is a very complex mineral, and contains in varying quantities nearly all the known metals.

Following the procedure sketched above M. and Mme Curie made a systematic chemical examination of the constituents of pitchblende. The mineral was first obtained in solution and then put through a regular course of chemical analysis. On precipitating with sulphuretted hydrogen, it was found that an active substance was separated with the bismuth. By special methods, preparations of bismuth were obtained of high activity. The name polonium was given by Mme Curie to this new active substance present in bismuth in honour of the country of her birth.

It was next observed that another active substance was separated with barium, and to this was given the name of radium †. This name was a happy inspiration of the discoverers, for radium in a pure state shows the radio-active property to an astonishing degree. Radium is extracted from pitchblende and uranium minerals generally by the same process required to separate barium, to which radium is very closely allied in chemical properties. After the removal of inactive impurities, the radium remains behind mixed with the barium. It can be partially separated from the latter by the difference in solubility of the chlorides in water, alcohol, or hydrochloric acid. The chloride of radium is less soluble than that of barium, and can be separated from it by the method of fractional crystallisation. After a large number of fractionations, the radium can be freed almost completely from the barium. Giesel ‡ observed later that separation of radium from barium proceeded much more rapidly if the bromide were used instead of the chloride. He found that six or eight crystallisations of the bromide are sufficient to free the radium almost completely from the barium.

In order to obtain sufficient radium to determine its atomic weight and other properties, it was necessary to carry out the chemical work on a large scale, for radium is present in very minute amount in pitchblende. It will be shown later that the weight of radium in most radio-active minerals is always proportional to the weight of uranium. The amount of radium present

* P. and S. Curie, *C. R.* **127**, p. 175, 1898.

† M. and Mme Curie and G. Bémont, *C. R.* **127**, p. 1215, 1898.

‡ Giesel, *Ann. d. Phys.* **69**, p. 91, 1890; *Ber. d. D. Chem. Ges.* p. 3608, 1902.

is about 3·4 parts in 10,000,000 of uranium element*. Consequently in a mineral containing 3 kilograms of uranium there is present 1 milligram of radium. In 1000 kilograms of Joachimsthal pitchblende, which contains about 60 per cent. of uranium, there is present about 200 milligrams of radium. Mme Curie was indebted for her first working material to the Austrian Government, who generously presented her with a ton of uranium residues from the state mine of Joachimsthal in Bohemia. At this place there are considerable deposits of pitchblende or uraninite, which are mined for the uranium they contain. In addition, financial assistance was given by scientific societies and private individuals to defray the expenses of the long and laborious work of the separation of the radium from these residues. It would be out of place in a physical treatise of this kind to give the chemical details of working up the uranium residues. An excellent account was initially given by Mme Curie† and later by Haitinger and Ulrich‡, who were responsible for separation of the radium and other radio-active constituents from the uranium residues obtained from Joachimsthal.

Mme Curie states that after treatment of the residues the activity of the radiferous barium is 30 to 60 times as great as uranium. The radium is then separated by fractional crystallisation, by the methods described above. Mme Curie finally succeeded in separating about a decigram of pure radium salt; the atomic weight was determined, and found initially to be 225 and later 226·5.

Radium was found to give a characteristic bright line spectrum. Recently Mme Curie and Dr. Debierne have succeeded in preparing metallic radium. There is thus no doubt that radium is a new chemical element of high atomic weight, with chemical properties closely allied to those of barium. It differs, however, from ordinary elements in possessing the radio-active property to an intense degree.

It has been thought desirable to give a complete and collected account of the properties of radium, and the other radio-active

* Rutherford and Boltwood, *Amer. Journ. Sci.* **22**, p. 1, 1906; **25**, p. 269, 1908.

† Mme Curie, *Thèses présentée à la Faculté des Sciences de Paris*, 1903.

‡ Haitinger and Ulrich, *Wien. Ber.* **117**, p. 619, 1908.

substances in the chapters devoted to that subject later in the book. At this stage a preliminary account only will be given. Radium like uranium and thorium emits α , β , and γ rays. On account of its great activity the photographic, phosphorescent and electric effects produced by the radiations are exceedingly intense. A few milligrams of radium salt produce a well-marked photographic action in less than a minute on a plate brought near it. The α rays light up brightly a screen of phosphorescent zinc sulphide or of willemite, while the β and γ rays produce a well-marked phosphorescence in barium-platino-cyanide and willemite. The discharging effects are on a very marked scale. 1/1000 of a milligram of radium causes an almost instantaneous discharge of an electroscope, when it is brought near the charged plate. A few milligrams of radium surrounded by a lead screen several millimetres thick, so as to stop the α and β rays, causes a rapid discharge of the electroscope due to the γ rays alone.

We shall see later that the emission of γ rays from radium in equilibrium has been utilised as an accurate method of determining the quantity of radium present, even though it is contained in a sealed tube. Pure radium compounds give a weak phosphorescence under the influence of their own radiations. This luminosity is more marked in barium-radium preparations than in radium itself.

Shortly after the discovery of radium, the Curies arranged that preparations of barium containing radium could be bought commercially through the Société Centrale de Produits Chimiques. This company under the direction of Debierne initially undertook the work of treatment of pitchblende residues for the Curies. Many of the initial experiments on the properties and radiations from radium were made with this material. We are indebted to Dr Giesel, Chemist of the Chininfabrik, Braunschweig, for first putting preparations of nearly pure radium salt on the market. Many scientific workers in this way obtained nearly pure radium bromide at a price initially of less than one-tenth of the prices to-day. The exceedingly high prices of radium at the present day (about £16 per milligram pure radium bromide) bear no relation to the cost of separation of the radium from uranium minerals. The present price is artificial and has resulted in

part from the comparative rarity of deposits of pitchblende or of uranium minerals containing a fairly high percentage of uranium. The extensive use of radium for medical purposes, as well as for physical and chemical experiments, has so far absorbed the output. At the same time, the undoubtedly large profits to be realised at the present prices have led to a very careful search for uranium deposits in various countries. It is known that there are extensive deposits of low grade uranium ores in various parts of the world, and it is to be hoped that in the immediate future methods will be devised of treatment of such ores. There seems to be no reason why the present abnormally high prices of radium should be ultimately maintained.

It is known that radium is only one of a number of highly active substances that can be separated from uranium minerals. The prominence of radium as a source of intense radiations is due to the fact that it can be isolated easily in nearly a pure state from uranium minerals. It should be noted that the radiations from radium as ordinarily used are due largely not to the radium itself but to the radio-active products produced in it. For example, radium itself emits only α rays and has only about one-fifth of the α ray activity of radium which is about one month old. The penetrating β and γ rays arise entirely from the products of radium. Radium, like thorium, produces a radio-active emanation, which can be released from the radium by heating or dissolving it. This intensely radio-active gas, which contains more than three-quarters of the activity of the radium from which it is derived, has been widely used as a source of radiation in place of radium itself. The use of the emanation possesses many advantages as a source of radiation, for it can be readily transferred from one vessel to another and highly concentrated. The radium itself is then merely used as a source for production of the emanation, and is not disseminated and lost by use in a multitude of experiments. The activity of the emanation is not permanent but decays to half value in 3.85 days, and becomes very small after a month's interval.

7. Actinium. The discovery of radium in pitchblende gave a great impetus to the chemical examination of this mineral,

and a systematic search early led to the detection of several new radio-active bodies. Debierne* in 1899, while working up the uranium residues for M. and Mme Curie, discovered the presence of a new active substance which he stated was precipitated with the iron group of elements, and had chemical properties closely allied to thorium, but the activity of the preparation was found to be many thousand times greater than that of thorium. This new substance was called by him actinium. After the announcement of his discovery several years elapsed before any definite results upon it were published by Debierne. In the meantime, Giesel† had found that a very active substance was separated from pitchblende which seemed similar in some respects to the actinium of Debierne. This active substance was separated with the rare earths, and after chemical treatment the active substance was associated mainly with lanthanum. Giesel early observed a very striking property of such preparations for they continuously emit a radio-active emanation, the activity of which decays to half value in a few seconds. For this reason he initially gave it the name "emanating substance," and later "emanium." It is not necessary here to enter into the details of the discussion which took place in regard to the identity of actinium with emanium. Ultimately, it was shown that the preparations of Debierne and Giesel were identical in radio-active properties, and the name actinium was retained for the new substance. The emanating property of actinium observed by Giesel can be illustrated by a very striking experiment. A highly active preparation of actinium enclosed in thin tissue paper is placed on a screen of phosphorescent zinc sulphide. In a dark room a brilliant phosphorescence, marked by characteristic scintillations, extends for some distance from the active preparation. On directing a slight current of air across the screen, the phosphorescence is displaced in the direction of the air current, and becomes much feebler. A large part of the phosphorescence observed initially was due to the actinium emanation which diffused through the thin paper over the surface of the screen. When the air current ceases, the emanation which is constantly supplied by

* Debierne, *C. R.* **129**, p. 593, 1899; **130**, p. 206, 1900.

† Giesel, *Ber. d. D. Chem. Ges.* p. 3608, 1902; p. 342, 1903.

the actinium, rapidly diffuses over the screen and lights it up again brightly.

There seems to be no doubt that actinium is a new element which possesses the radiating property to a degree at least comparable with that of radium. Although by special methods very active preparations of actinium have been obtained, it has not yet been found possible to isolate it; consequently neither the atomic weight nor spectrum of this element is yet known.

In addition to the emission of a characteristic emanation, actinium preparations some months old emit α , β , and γ rays. The γ rays, however, are less penetrating than those from radium or thorium. It will be shown later that actinium, like radium, gives rise to a series of active products.

8. Polonium. We have already mentioned that polonium was the first active substance separated by Mme Curie* from uranium minerals. In chemical properties, it is allied to bismuth, and is ordinarily separated with it. Mme Curie showed that it was possible to concentrate the polonium by several methods and to obtain preparations of polonium of high activity. Polonium possesses the peculiarity of emitting only α rays; its activity is not permanent but decays with the time, falling to half value in about 140 days. Consequently, a few years after separation, polonium preparations have lost the greater part of their activity.

In 1903 Marckwald† found that a very active substance could be separated from the residues of uranium minerals by placing a polished bismuth plate in a suitably prepared solution. The active matter deposited on the bismuth plate was found to be associated with tellurium, and for this reason was initially called "radio-tellurium." By special methods Marckwald separated the polonium from the residues corresponding to 15 tons of pitchblende, and finally obtained several milligrams of a preparation far more active, weight for weight, than pure radium. He found that the active matter had no connection with tellurium, and could be completely isolated from it. Marckwald initially thought that his preparations did not, like polonium, lose their activity with time. In later

* M. and Mme Curie, *C. R.* **127**, p. 175, 1898.

† Marckwald, *Phys. Zeit.* **4**, p. 51, 1903; *Ber. d. D. Chem. Ges.* p. 2662, 1903.

investigations by himself and others it was shown that the rate of decay of radio-tellurium was identical with that of the polonium of Mme Curie, and there is now no doubt that the radio-active substances were identical. Highly active preparations of polonium on a polished bismuth disc or rod were, some years ago, placed on the market. Recently, Mme Curie has made further experiments to isolate polonium, obtaining preparations of very great activity, and has determined some of the lines of its spectrum. The quantity of polonium in pitchblende is only about 1/5000 of that of radium, and it will be a matter of great difficulty to obtain a sufficient quantity of this substance to determine its atomic weight. It will be shown later that polonium itself is one of the series of products resulting from the transformation of radium.

9. Radio-lead. Several observers* noted that the lead separated from pitchblende showed considerable activity. This was at first ascribed to the presence of small quantities of radium and polonium. Hofmann and Strauss†, however, concluded that lead separated from uranium minerals contained a new active substance which they called radio-lead. Later work has shown that this active material has a slow rate of transformation, and is identical with the product radium *D* derived from the transformation of radium. It has not so far been found possible to concentrate to any degree the active matter separated with the lead. It is of interest to note that preparations of radio-lead serve as very convenient sources of polonium. In a solution of radio-lead, polonium is produced at a constant rate. The polonium present at any time can be separated by placing a bismuth plate in the solution.

10. Ionium. Boltwood‡ in 1907 discovered the presence of another radio-active substance in uranium minerals, which he called ionium. This substance has chemical properties so closely allied with thorium that it has not been found possible to separate

* Elster and Geitel, *Ann. d. Phys.* **69**, p. 83, 1899. Giesel, *Ber. d. D. Chem. Ges.* p. 3775, 1901.

† Hofmann and Strauss, *Ber. d. D. Chem. Ges.* p. 3035, 1901.

‡ Boltwood, *Amer. Journ. Sci.* **24**, p. 370, 1907; **25**, pp. 365, 493, 1908; and *Phys. Zeit.* **8**, p. 884, 1907.

them from each other. Ionium emits only α rays, and has apparently a very slow period of transformation. Commercial preparations of actinium have been found in most cases to contain ionium. There is reason to believe that ionium exists in greater quantity in uranium minerals than radium, but it has not yet been found possible to isolate it. Ionium has a special interest, as it is a direct parent of radium. A preparation of ionium initially freed from radium is found to grow radium at a rapid rate.

11. Other radio-active substances. A brief account has so far been given of the radio-activity of thorium and of uranium, and of the radio-active substances separated from uranium minerals. With the exception of ionium, the presence of these substances was detected early in the history of radio-activity. In addition to these, however, a large number of other radio-active substances are now known. Substances like uranium, thorium, radium, and ionium show a fairly permanent activity, for no change can be detected over an interval of several years. Most of the other substances show only a temporary activity, and their activity largely disappears in the course of a few hours or months. It may be not out of place here to summarize briefly the general properties of these bodies. Each of these substances has distinctive chemical and physical properties and emits radiations of a characteristic type, and loses its activity at a distinctive rate. These substances undergo spontaneous transformation and are to be regarded as transition elements, that is, elements which exist only for a short time. The law of transformation is the same for all these substances, although the rate varies in each individual case. This is expressed by the statement that the element is transformed according to an exponential law. For example, if N_0 be the number of atoms of the substance present initially and N_t the number after an interval t then $N_t/N_0 = e^{-\lambda t}$ where λ is a definite constant characteristic of the element and e is the base of natural logarithms. It is convenient to express the rate of transformation in terms of the half value period, that is, the time required for half the matter to be transformed. For example, if T be the half value period, half of the matter remains untransformed after a time T ,

one-quarter after $2T$, one-eighth after a time $3T$, and so on. Including the primary active substances, more than thirty of these transition elements are now known. From the purely scientific point of view, each of these elements of short life is intrinsically as important as radium or the other elements which are transformed more slowly, for the production of each substance marks a definite stage in the series of transformations which take place in the atoms. All the radio-active substances, whether of long or short life, are undergoing spontaneous atomic transformation. For example, radium itself is a transition element which is produced by the transformation of ionium, which in turn is derived from uranium.

These new substances are most conveniently tabulated as products of the more permanent element from which they originate. In the following tables, the products of uranium, thorium, and actinium, are tabulated for convenience of reference in later chapters. The radiation emitted from the product and its half value period are also added. In each of these series the product under consideration is produced from the one above it and is transformed into the one succeeding it. The tables also show the connection between uranium, ionium, and radium. The properties and mode of separation of these series of products are discussed in detail in later chapters. In the tables, the names of products which have a half value period larger than 100 days are given in larger print.

The problem of giving specific names to such a large number of new substances has been very difficult. It is obviously important that the name of the series to which the element belongs should be given. It will be seen that the products of the emanations of thorium, actinium, and radium are called by the letters *A*, *B*, *C*, or *D*, etc. added to that of the parent element. The nomenclature of the earlier products is not so systematic, many of these products have been discovered comparatively late, and it has been difficult to arrange for the uniformity of the nomenclature of the different series without producing confusion.

It may be mentioned that there is as yet no certainty that all the products present have been detected. At the same time there is reason to believe that no product emitting α rays in the main

line of descent remains undiscovered, but there is still some doubt in regard to possible β ray products and products which may appear as lateral branches of the main series.

List of radio-active substances.

Element	Radiation	Half value period
URANIUM	α	6×10^9 years
Uranium X }	$\beta + \gamma$	24.6 days
Uranium Y }	β	1.5 days
IONIUM	α	greater than 20,000 years
RADIUM	$\alpha + \text{slow } \beta$	2000 years
Emanation	α	3.85 days
Radium A	α	3 minutes
Radium B	$\beta + \gamma$	26.8 minutes
Radium C { C_1	$\alpha + \beta + \gamma$	19.5 minutes
{ C_2	β	1.4 minutes
RADIUM D }	slow β	16.5 years
RADIO-LEAD }		
Radium E	$\beta + \gamma$	5 days
RADIUM F }	α	136 days
POLONIUM }		
ACTINIUM	no rays	?
Radio-actinium	$\alpha + \beta$	19.5 days
Actinium X	α	10.5 days
Emanation	α	3.9 seconds
Actinium A	α	.002 second
Actinium B	slow β	36 minutes
Actinium C	α	2.1 minutes
Actinium D	$\beta + \gamma$	3.47 minutes

List of radio-active substances (continued).

Element	Radiation	Half value period
THORIUM	α	3×10^{10} years
MESOTHORIUM 1	no rays	5.5 years
Mesothorium 2 ...	$\beta + \gamma$	6.2 hours
RADIOTHORIUM	α	2 years
Thorium X	$\alpha + \beta$	3.64 days
Emanation	α	54 seconds
Thorium A	α	0.14 second
Thorium B	slow β	10.6 hours
Thorium C $\left\{ \begin{array}{l} C_1 \\ C_2 \end{array} \right.$	α	60 minutes
	α	very rapid?
Thorium D	$\beta + \gamma$	3.1 minutes

CHAPTER II.

IONISATION OF GASES.

12. Ionisation of gases by radiation. The most important property possessed by the radiations from radio-active matter is their power of discharging bodies whether positively or negatively electrified. As this property has been made the basis of a method for an accurate quantitative analysis and comparison of the radiations, the variation of the rate of discharge under different conditions and the processes underlying it will be considered in some detail.

In order to explain the similar discharging power of Röntgen rays, the theory* has been put forward that the rays produce positively and negatively charged carriers throughout the volume of the gas surrounding the charged body, and that the rate of production is proportional to the intensity of the radiation. These carriers, or ions† as they have been termed, move with a uniform velocity through the gas under a constant electric field, and their velocity varies directly as the strength of the field.

Suppose we have a gas between two metal plates *A* and *B* (Fig. 1) exposed to the radiation, and that the plates are kept

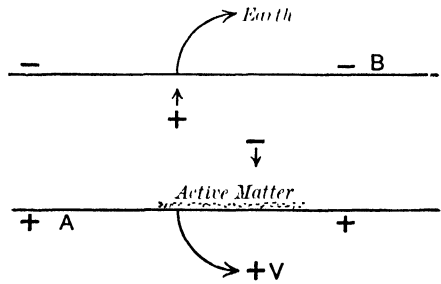

Fig. 1.

* J. J. Thomson and Rutherford, *Phil. Mag.* **42**, p. 392, 1896.

† The word ion has now been generally adopted in the literature of the subject. In using this word, it is not assumed that the ions in gases are the same as the corresponding ions in the electrolysis of solutions.

at a constant difference of potential. A definite number of ions will be produced per second by the radiation, and the number produced will depend in general upon the nature and pressure of the gas. In the electric field the positive ions travel towards the negative plate, and the negative ions towards the positive, and consequently a current will pass through the gas. Some of the ions will also recombine, the rate of recombination being proportional to the square of the number present. For a given intensity of radiation, the current passing through the gas will increase at first with the potential difference between the plates, but it will reach a limit when all the ions are removed by the electric field before any recombination occurs.

This theory accounts also for all the characteristic properties of gases made conducting by the rays from active substances, though there are certain differences observed between the conductivity phenomena produced by active substances and by X rays. These differences are in part the result of unequal absorption of the two types of rays. Unlike Röntgen rays, a large proportion of the radiation from active bodies consists of rays which are absorbed in their passage through a few centimetres of air. The ionisation of the gas is thus not uniform, but falls off rapidly with increase of distance from the active substance. In addition, there are marked differences in the distribution of ions produced by X rays and by α rays.

13. Variation of the current with voltage. Suppose that a layer of radio-active matter is spread uniformly on the lower of two horizontal plates *A* and *B* (Fig. 1). The lower plate *A* is connected with one pole of a battery of cells the other pole of which is connected with earth. The plate *B* is connected with one pair of quadrants of an electrometer, the other pair being connected with earth.

The current* between the plates, determined by the rate of movement of the electrometer needle, is observed at first to increase rapidly with the voltage, then more slowly, finally reaching

* A minute current is observed between the plates even if no radio-active matter be introduced. This has been found to be due mainly to a slight natural radio-activity of the matter composing them.

a value which increases very slightly with a large increase in the voltage. This, as we have indicated, is simply explained on the ionisation theory.

The radiation produces ions at a constant rate, and, before the electric field is applied, the number per unit volume increases until the rate of production of fresh ions is exactly balanced by the recombination of the ions already produced. On application of a small electric field, the positive ions travel to the negative electrode and the negative to the positive.

Since the velocity of the ions between the plates is directly proportional to the strength of the electric field, in a weak field the ions take so long to travel between the electrodes that most of them recombine on the way.

The current observed is consequently small. With increase of the voltage there is an increase of speed of the ions and a smaller number recombine. The current consequently increases, and will reach a maximum value when the electric field is sufficiently strong to remove all the ions before appreciable recombination has occurred. The value of the current will then remain constant even though the voltage is largely increased.

This maximum current will be called the "saturation" current, and the value of the potential difference required to give this maximum current, the "saturation P.D."* or "saturation voltage."

The general shape of the current-voltage curve is shown in Fig. 2, where the ordinates represent current and the abscissae volts.

Although the variation of the current with voltage depends only on the velocity of the ions and their rate of recombination, the full mathematical analysis is intricate, and the equations, expressing the relation between current and voltage, are only integrable for the case of uniform ionisation. The question is complicated by the inequality in the velocity of the ions and by the disturbance of the potential gradient between the plates

* This nomenclature has arisen from the similarity of the shape of the current-voltage curves to the magnetization curves for iron. Since, on the ionisation theory, the maximum current is a result of the *removal* of all the ions from the gas, before recombination occurs, the terms are not very suitable. They have however now come into general use and will be retained throughout this work.

by the movement of the ions. J. J. Thomson* has worked out the case for uniform production of ions between two parallel plates, and has found that the relation between the current i and the applied potential difference V is expressed by

$$Ai^2 + Bi = V$$

where A and B are constants for a definite intensity of radiation and a definite distance between the plates.

In certain cases of unsymmetrical ionisation, which arise in the study of the radiations from active bodies, the relation between current and voltage is very different from that expressed by the above equation. Some of these cases will be considered in section 28.

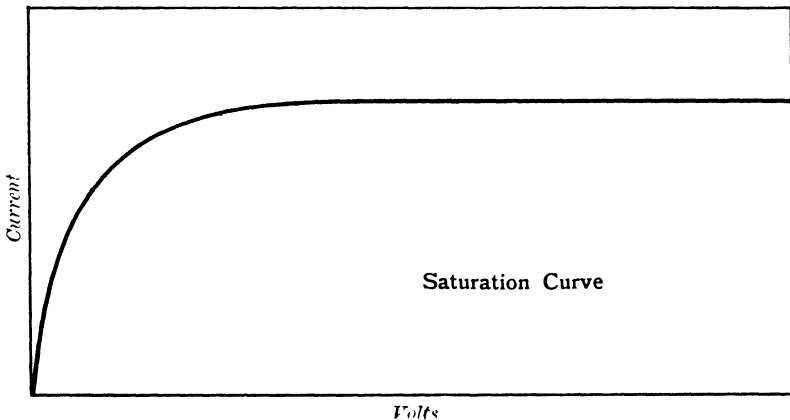

Fig. 2.

While the equation expressing the relation between the current and the voltage is very complicated even in the case of a uniform rate of production of ions between the plates, an approximate theory, which is of utility in interpreting the experimental results, can be simply deduced if the disturbance of the potential gradient is disregarded, and the ionisation assumed uniform between the plates.

Suppose that the ions are produced at a constant rate q per cubic centimetre per second in the gas between parallel plates distant l cms. from each other. When no electric field is applied,

* J. J. Thomson, *Phil. Mag.* 47, p. 253, 1899; *Conduction of Electricity through Gases*, chapter III, 2nd edition.

the number N present per c.c., when there is equilibrium between the rates of production and recombination, is given by $q = \alpha N^2$, where α is a constant.

If a small potential difference V is applied, which gives only a small fraction of the maximum current, and consequently has not much effect on the value of N , the current i per sq. cm. of the plate, is given by

$$i = \frac{NeuV}{l},$$

where u is the sum of the velocity of the ions for unit potential gradient, and e is the charge carried by an ion. $\frac{uV}{l}$ is the velocity of the ions in the electric field of strength $\frac{V}{l}$.

The number of ions produced per second in a prism of length l and unit area of cross-section is ql . The maximum or saturation current I per sq. cm. of the plate is obtained when all of these ions are removed to the electrodes before any recombination has occurred.

Thus
$$I = q \cdot l \cdot e,$$

and
$$\frac{i}{I} = \frac{NuV}{ql^2} = \frac{uV}{l^2 \sqrt{q\alpha}}.$$

This equation expresses the fact previously noted that, for small voltages, the current i is proportional to V .

Let
$$\frac{i}{I} = \rho,$$

then
$$V = \frac{\rho \cdot l^2 \sqrt{q\alpha}}{u}.$$

It is of importance in many experiments to determine the saturation current through an ionised gas, as this is a direct measure of the rate of production of ions in the volume of gas considered. The potential required to produce saturation depends upon a number of conditions—upon the intensity of ionisation, the distance between the plates, and the nature and pressure of the gas. The value of the saturation P.D. is in general difficult

to calculate, and it is desirable in all cases to determine it experimentally. From the equation given above, the variation of the saturation voltage with conditions can be simply deduced. The greater the value of V required to obtain a given value of ρ , supposed small compared with unity, the greater is the saturation voltage. It follows from this that for a given intensity of ionisation the saturation voltage increases with the distance between the plates. In the equation for small values of ρ , V varies as l^2 . This holds for uniform ionisation, but only approximately for non-uniform ionisation.

For a given distance between the plates, the saturation voltage increases with the intensity of ionisation. Using a very active material, for example, a radium preparation, the ionisation close to the radium is so intense that very large voltages are required to produce even approximate saturation. On the other hand, a potential gradient of a few volts per centimetre is sufficient to produce very approximate saturation in a gas when the ionisation is very small. This is especially the case when the ionisation is produced by the β and γ rays. The difficulty of saturation for a gas ionised by α rays is discussed in the next section.

For a given intensity of radiation, the saturation voltage decreases rapidly with the lowering of the pressure of the gas. This is due to two causes operating in the same direction, viz. a decrease in the intensity of the ionisation and an increase in the velocity of the ions. The ionisation varies directly as the pressure, while the velocity varies inversely as the pressure. This will obviously have the effect of causing more rapid saturation, since the rate of recombination is slower and the time taken for the ions to travel between the electrodes is less.

The saturation curves observed for the gases hydrogen and carbon dioxide* are very similar in shape to those obtained for air. For a given intensity of radiation, saturation is more readily obtained in hydrogen than in air, since the ionisation is less than in air while the velocity of the ions is greater. Carbon dioxide on the other hand requires a greater P.D. to produce saturation than does air, since the ionisation is more intense and the velocity of the ions less than in air.

* Rutherford, *Phil. Mag.* 47, p. 109, 1899.

14. Difficulty of saturation with α rays. When the ionisation of a gas is produced by the β or γ rays from an active substance or by Röntgen rays, almost complete saturation is readily obtained if the ionisation is not too intense and the current-voltage curve is similar to that shown in Fig. 2. On the other hand, it is in general very difficult to obtain complete saturation when the ionisation is produced by α rays from active matter, even when the average ionisation is very weak. It was noticed by Rutherford* in his initial experiments with the α rays of uranium that

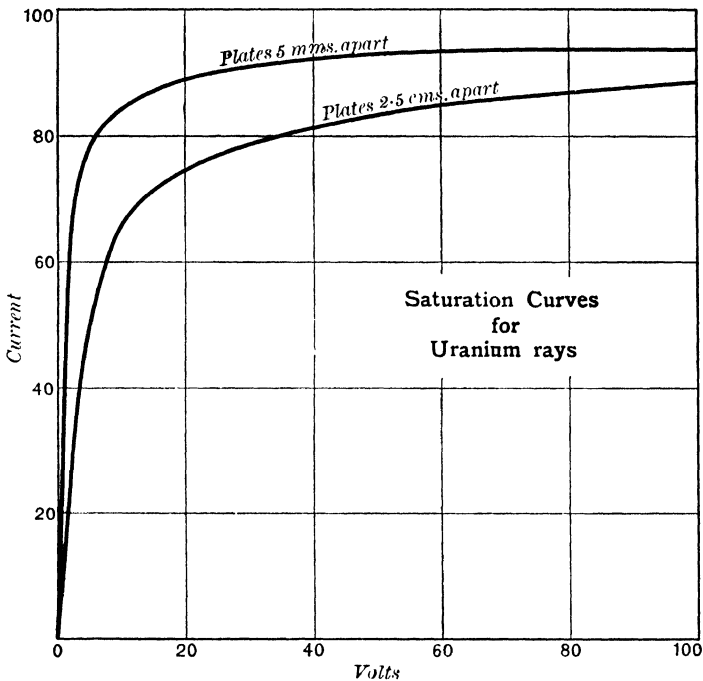

Fig. 3.

it was difficult to obtain complete saturation even if a very strong electric field was applied. The results are shown in Fig. 3 for parallel plates 2.5 and 25 mms. apart respectively. A thin layer of uranium oxide was spread uniformly on the lower of the two plates and the ionisation was mainly due to the α rays. It is seen that at first the current increases rapidly and then more slowly; but there is no evidence of complete saturation even for large

* Rutherford, *Phil. Mag.* 47, p. 109, 1899.

voltages. Taking into consideration the early part of the curves the current does not reach its maximum value nearly so rapidly as should be expected on the ionisation theory.

In the course of their work on the α rays, Bragg and Kleeman* observed that it was very difficult to obtain saturation for gases ionised by α rays. This was especially marked near the end of the path of a pencil of α rays. This effect was ascribed to initial recombination of the ions. On this view, the process of ionisation by the α rays led to the production of positive and negative ions, which were only separated a short distance from each other. These ions consequently had a greater tendency to recombine with each other than with the ions distributed throughout the volume of the gas. A strong electric field would be required to draw the ions apart from each other before recombination occurred. Kleeman† later investigated the question, and found that this initial recombination, while marked in the case of α rays, was small for ionisation by X rays, and by β and γ rays.

A somewhat different explanation of the difficulty of saturation with α rays was put forward later by Moulin‡, who made a detailed study of the question. The α rays are projected particles, and travel nearly in straight lines through the gas, producing about 40,000 ions per centimetre of their path in air. In a gas traversed by α rays, the ionisation will consequently at any moment not be equally distributed, but restricted to a number of columns where the ionisation is exceedingly intense. The difficulty of saturation is ascribed to the density of the ionisation along the path of the α particle, and consequent rapid recombination.

In support of this view Moulin showed that saturation was more readily obtained if the electric field was perpendicular instead of parallel to the path of the α rays. In the former case, the ions of opposite sign are rapidly separated from each other by the electric field.

The ease of saturation depends on the pressure and nature of the gas. For example, saturation is more readily obtained in

* Bragg and Kleeman, *Phil. Mag.* **11**, p. 466, 1906.

† Kleeman, *Phil. Mag.* **12**, p. 273, 1906.

‡ Moulin, *C. R.* **148**, p. 1757, 1909; *Thesis Faculty of Sciences, Paris*, 1910.

hydrogen than in air, and less readily in carbonic acid than in air. The saturation voltage rapidly diminishes with lowering of the pressure.

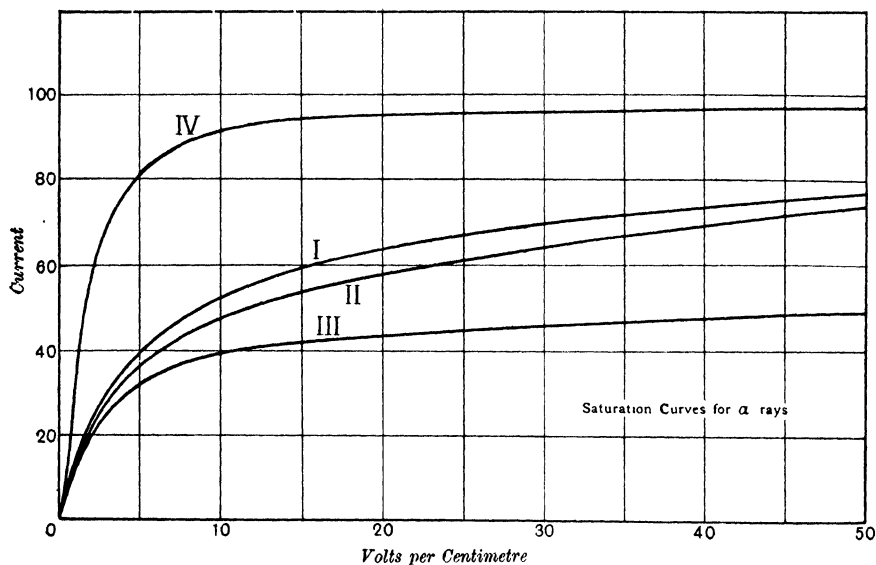

Fig. 4 A.

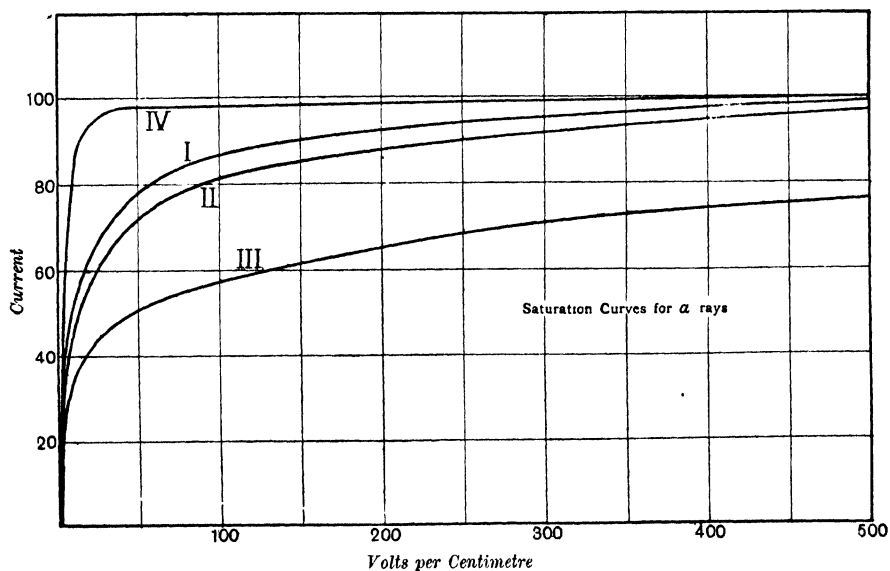

Fig. 4 B.

The difficulty of saturation with α rays is well illustrated by the curves (Fig. 4) obtained by Moulin. Curve I is obtained when the α rays are perpendicular to the field, Curve II at an angle of 45° , Curve III parallel to the field, Curve IV was obtained for about the same ionisation produced by β and γ rays. It is seen that saturation is far more easily reached in the latter case. The upper figure gives the initial part of the saturation curve for weak fields, the lower for fields up to 500 volts per centimetre.

The subject was taken up again by Wheelock* who concluded that the variation of the current with voltage was not completely explained by this columnar ionisation. The problem is complicated; but it appears that the difficulty of saturation is to be ascribed mainly to the density of the ionisation along the path of the α particle. This offers a reasonable explanation of the greater difficulty of obtaining saturation near the end of the range of the α particle, where we know the ionisation of the α particle per unit path is most intense. At the same time, especially in complex gases and vapours, it is quite possible that a type of initial recombination as suggested by Bragg may play some part.

The difficulty of obtaining complete saturation holds even when the average ionisation due to α rays is very weak. It is practically not possible to obtain complete saturation unless an electric field of about 1500 volts per centimetre is applied. It is generally necessary to reduce the pressure of the gas in order to obtain saturation with the potential differences available. At the same time, approximate saturation is reached for much weaker electric fields, and the relative currents observed under such conditions bear nearly the same relation to one another as the true saturation currents. Consequently comparisons of activity due to the α rays can be made with accuracy, for example, with an ordinary α ray electroscopes, even when the voltage is only sufficient to give about 85 per cent. of the true saturation current.

This difficulty of saturation has been discussed in some detail, as it has an important bearing on accurate measurements of ionisation in radio-active work †.

* Wheelock, *Amer. Journ. Sci.* **30**, p. 233, 1910; *Le Radium*, **7**, p. 374, 1910.

† See Regener, *Verh. d. D. Phys. Ges.* **13**, p. 1065, 1911.

15. Ionisation by collision. Townsend* has shown that, for low pressures, the variation of the current with the voltage is very different from that observed at atmospheric pressure. If the increase of current with the voltage is determined for gases, exposed to Röntgen rays, at a pressure of a few mms. of mercury, it is found that for small voltages the ordinary saturation curve is obtained; but when the voltage applied increases beyond a certain value, depending on the pressure and nature of the gas and the distance between the electrodes, the current commences to increase slowly at first but very rapidly as the voltage is raised to the sparking value. The general shape of the current curve is shown in Fig. 5.

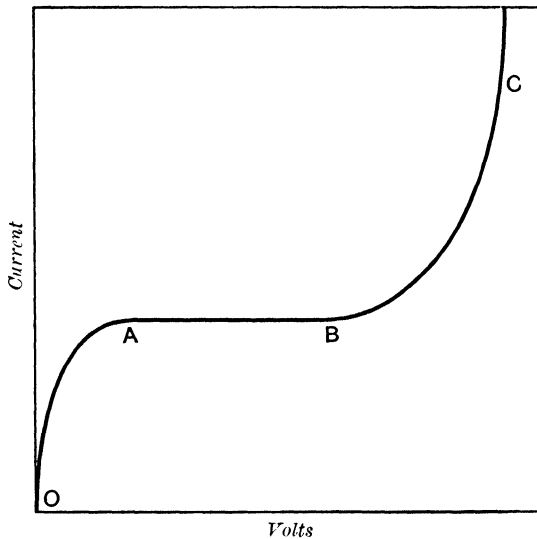

Fig. 5.

The portion OAB of the curve corresponds to the ordinary saturation curve. At the point B the current commences to increase. This increase of current has been shown to be due to the action of the negative ions at low pressures in producing fresh ions by collision with the molecules in their path.

In many of the experiments of Townsend, negative ions were liberated by the action of ultra-violet light from the surface of a metal plate A , which was charged negatively. The current

* Townsend, *Phil. Mag.* 1, p. 79, 1901; 3, p. 557, 1902.

passing between this plate and a parallel plate B was measured for different voltages and for different distances between the plates. Consider a space bounded by two planes distant x and $x + dx$ from the plate A and parallel to it. If n be the number of negative ions passing across this plane, the number dn formed in the space is given by $dn = \alpha n dx$, where α is a constant for a given electric field but varies with the pressure and nature of the gas and the strength of the electric field. Integrating this equation $\log n = \alpha x + k$ where k is a constant. If n_0 ions are liberated per second from the surface of the plate A by the ultra-violet light, $n = n_0$ when $x = 0$, and $k = \log n_0$. If the plates are distant d apart, the number n of negative ions reaching the plate B is given by $n = n_0 e^{\alpha d}$.

The value of n_0 is determined by measuring the value of the saturation current for a voltage too small to produce ions by collision. The value of n thus increases rapidly with increase of the distance d . This relation with distance was found by Townsend to hold very closely for weak electric fields; but as the electric field approached the sparking value, the value of n increased far more rapidly than was given by the simple theory outlined above. Townsend showed that this increase was due to production of fresh ions by the collision of the *positive ions* with the molecules. Although for a given electric field, the positive ions are far less efficient than the negative in generating ions by collision, the net result of this additional ionisation is to cause a very rapid increase of the current with the voltage. Finally, the current reaches so large a value that a spark or electric discharge takes place.

There is thus a marked difference between the positive and negative ions in their power of generating ions by collision. The results indicate that the negative ion at low pressures is identical with the electron which has an apparent mass small compared with that of the atom of hydrogen, while the positive ion is always of atomic magnitude. Experiment shows that the negative ion is able to produce fresh ions by collision when it acquires a velocity equivalent to that gained in moving freely between two points differing in potential by about 20 volts. If m be the mass of the electron, e its charge, the velocity u acquired in moving between

two points at a difference of potential V is given by

$$\frac{1}{2}mu^2 = Ve \text{ or } u = \sqrt{2V \cdot \frac{e}{m}}.$$

Taking the value $e/m = 1.7 \times 10^7$ e.m. units for the electron at low speeds and $V = 20$ volts $= 2 \times 10^9$ e.m. units, $u = 2.6 \times 10^8$ cms. per second. This velocity is very large compared with the velocity of agitation of the gas molecules themselves. The mean free path of the electron is about four times as long as that of the molecule of the gas in which it is moving. The number of ions produced by the collision of the negative ions increases with the electric field to a maximum when each collision results in the production of a new pair of ions. Under these conditions, one ion produces 21 new ions by collision for each millimetre of path in air at a pressure of one millimetre of mercury*.

Apart from the importance of this effect in electrical conduction, the principle of ionisation by collision affords a very convenient means of magnifying weak ionisation currents. By adjusting a voltage just below the sparking value, the number of ions produced in the gas by an external agency can be increased several thousand times by collision. Using this method, it has been found possible to detect the presence of a single α particle by its electrical effect, and to count the number emitted by radio-active substances.

16. Rate of recombination of the ions. A gas ionised by the radiation preserves its conducting power for some time after it is removed from the presence of the active body. A current of air blown over an active body will thus discharge an electrified body some distance away. The duration of this after conductivity can be examined very conveniently in an apparatus similar to that shown in Fig. 6.

A dry current of air or any other gas is passed at a constant rate through a long metal tube TL . After passing through a quantity of cotton-wool to remove dust particles, the current of air passes over a vessel T containing a radio-active body such as

* An excellent account of the theory and experiments on this subject has been given by Townsend in a book entitled *The theory of ionisation of gases by collision* (Constable and Co., London), 1910.

uranium, which does not give off a radio-active emanation. By means of insulated electrodes *A* and *B*, charged to a suitable potential, the current between the tube and one of these electrodes can be tested at various points along the tube.

A gauze screen, placed over the cross-section of the tube at *D*, serves to prevent any direct action of the electric field in abstracting ions from the neighbourhood of *T*.

If the electric field is sufficiently strong, all the ions travel to the electrode at *A*, and no current is observed at the electrode *B*. If the current is observed successively at different distances along the tube, all the electrodes except the one under consideration being connected with earth, it is found that the current diminishes with the distance from the active body. If the tube is of fairly wide bore, the loss of the ions due to diffusion is small, and the decrease in conductivity of the gas is due to recombination of the ions alone.

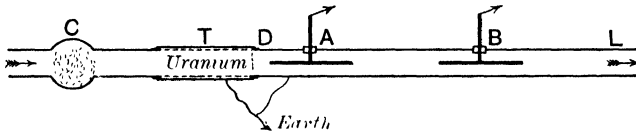

Fig. 6.

The rate of recombination is proportional to the product of the number of positive and negative ions per unit volume. The number dn of ions per unit volume which recombine in the time dt is given by

$$\frac{dn}{dt} = -\alpha n_1 n_2$$

where α is a constant. Equal numbers of positive and negative ions are formed per unit volume, and in the absence of an electric field $n_1 = n_2$

Consequently in this case

$$\frac{dn}{dt} = -\alpha n^2.$$

Integrating this equation,

$$\frac{1}{n} - \frac{1}{N} = \alpha t,$$

if N is the initial number of ions, and n the number after a time t .

The experimental results obtained* have been shown to agree very well with this equation.

In an experiment similar to that illustrated in Fig. 6, using uranium oxide as a source of ionisation, it was found that half the number of ions present in the gas recombined in 2.4 seconds, and that at the end of 8 seconds one-fourth of the ions were still uncombined.

Since the rate of recombination is proportional to the square of the number present, the time taken for half of the ions present in the gas to recombine decreases very rapidly with the intensity of the ionisation. If radium is used, the ionisation is so intense that the rate of recombination is extremely rapid. It is on account of this rapidity of recombination that large voltages are necessary to produce saturation in the gases exposed to very active preparations of radium. It has already been pointed out in section 14 that the ionisation produced by α rays is initially not uniform. In this case the initial rate of recombination is more rapid than if an equal amount of ionisation were uniformly distributed.

The value of α , which may be termed the *coefficient of recombination*, has been determined in absolute measure by Townsend†, M^cClung‡ and Langevin§ by different experimental methods but with very concordant results. Suppose, for example, with the apparatus of Fig. 6, the time T , taken for half the ions to recombine after passing by the electrode A , has been determined experimentally. Then $\frac{1}{N} = \alpha T$, where N is the number of ions per c.c. present at A . If the saturation current i is determined at the electrode A , $i = NVe$, where e is the charge on an ion and V is the volume of uniformly ionised gas carried by the electrode A per second. Then $\alpha = \frac{Ve}{iT}$.

The following table shows the value of α obtained for different gases.

* Rutherford, *Phil. Mag.* **44**, p. 422, 1897; **47**, p. 109, 1899.

† Townsend, *Phil. Trans. Roy. Soc. A*, **193**, p. 157, 1899.

‡ M^cClung, *Phil. Mag.* **3**, p. 283, 1902.

§ Langevin, *Thesis presented to Faculty of Sciences, Paris*, p. 151, 1902.

Value of α .

Gas	Townsend	M ^c Clung	Langevin
Air	3420 $\times e$	3384 $\times e$	3200 $\times e$
Carbon Dioxide	3500 $\times e$	3492 $\times e$	3400 $\times e$
Hydrogen ...	3020 $\times e$		

Assuming that the value of e (see section 20) is 4.65×10^{-10} e.s. units, $\alpha = 1.5 \times 10^{-6}$.

Using this value, it can readily be shown from the equation of recombination that, if 10^6 ions are present per c.c., half of them recombine in about 0.7 sec. and 99% in 70 secs.

The effect of pressure of the gas on the recombination constant has been examined by M^cClung and Langevin. The results indicate that the rate of recombination diminishes rapidly with lowering of the pressure. Erikson* and Phillips† have shown that the value of α decreases rapidly with rise of temperature.

In experiments on recombination it is essential that the gas should be free from dust or other suspended particles. In dusty air, the coefficient of recombination is much greater than in dust-free air, as the ions diffuse rapidly to the comparatively large dust particles distributed throughout the gas. The effect of the suspension of small particles in a conducting gas is very well illustrated by an experiment of Owens‡. If tobacco smoke is blown between two parallel plates as in Fig. 1, the current at once diminishes to a small fraction of its former value, although a voltage is applied sufficient to produce saturation under ordinary conditions. A much larger voltage is then necessary to produce saturation. If the smoke particles are removed by a stream of air, the current returns at once to its original value.

17. Mobility of the ions. Determinations of the mobility of the ions, *i.e.* the velocity of the ions under a potential gradient of 1 volt per cm., have been made by a number of observers for gases exposed to Röntgen rays. Although widely different methods have been employed, the results have been very concordant, and fully support the view that the ions move with a velocity proportional to the strength of the field. On the application of a

* Erikson, *Phil. Mag.* **18**, p. 328, 1909.

† Phillips, *Proc. Roy. Soc. A.* **83**, p. 246, 1910.

‡ Owens, *Phil. Mag.* **48**, p. 360, 1899.

uniform electric field, the ions almost instantly attain the velocity corresponding to the field and then move with a uniform speed.

Zeleny* first drew attention to the fact that the positive and negative ions in most cases have different velocities. The velocity of the negative ion is in most cases greater than that of the positive, and varies with the amount of water vapour present in the gas.

The results, previously discussed, of the variation of the current with voltage and of the rate of recombination of the ions do not of themselves imply that the ions produced in gases by the radiations from active bodies are identical with those produced by Röntgen rays under similar conditions. They merely show that the conductivity under various conditions can be satisfactorily explained by the view that charged ions are produced throughout the volume of the gas. The same general relations would be observed if the ions differed considerably in size and velocity from those produced by Röntgen rays. The most satisfactory method of determining whether the ions are identical in the two cases is to determine the velocity of the ions under similar conditions. This can be done by a number of methods, but a brief account will be given of the flow method which was used by the writer and also by Zeleny.

In order to compare the velocity of the ions†, the writer used an apparatus similar to that shown in Fig. 6 on p. 39.

The ions were carried with a rapid constant stream of air past the charged electrode *A*, and the conductivity of the gas was tested immediately afterwards at an electrode *B*, which was placed close to *A*. The insulated electrodes *A* and *B* were fixed centrally in the metal tube *L*, which was connected with earth.

For convenience of calculation, it is assumed that the electric field between the cylinders is the same as if the cylinders were infinitely long.

Let *a* and *b* be the radii of the electrode *A*, and of the tube *L* respectively, and let *V* = potential of *A*.

The electric force *X* (without regard to sign) at a distance *r* from the axis of the tube is given by

$$X = \frac{V}{r \log_e \frac{b}{a}}.$$

* Zeleny, *Phil. Mag.* **46**, p. 120, 1898.

† Rutherford, *Phil. Mag.* **47**, p. 109, 1899.

Let K_1 and K_2 be the velocities of the positive and negative ions for a potential gradient of 1 volt per cm. If the velocity is proportional to the electric force at any point, the distance dr traversed by the negative ion in the time dt is given by

$$dr = XK_2 dt,$$

or

$$dt = \frac{\log_e \frac{b}{a} r dr}{VK_2}.$$

Let r_2 be the greatest distance measured from the axis of the tube from which the negative ion can just reach the electrode A in the time t taken for the air to pass along the electrode.

Then

$$t = \frac{(r_2^2 - a^2)}{2VK_2} \log_e \frac{b}{a}.$$

If ρ_2 be the ratio of the number of the negative ions that reach the electrode A to the total number passing by, then

$$\rho_2 = \frac{r_2^2 - a^2}{b^2 - a^2}.$$

Therefore

$$K_2 = \frac{\rho_2 (b^2 - a^2) \log_e \frac{b}{a}}{2Vt} \dots\dots\dots(1).$$

Similarly the ratio ρ_1 of the number of positive ions that give up their charge to the external cylinder to the total number of positive ions is given by

$$K_1 = \frac{\rho_1 (b^2 - a^2) \log_e \frac{b}{a}}{2Vt}.$$

In the above equations it is assumed that the current of air is uniform over the cross-section of the tube, and that the ions are uniformly distributed over the cross-section; also, that the movement of the ions does not appreciably disturb the electric field. Since the value of t can be calculated from the velocity of the current of air and the length of the electrode, the values of the velocities of the ions under unit potential gradient can at once be determined.

The equation (1) shows that ρ_2 is proportional to V ,—i.e. that the rate of discharge of the electrode A varies directly as the

potential of A , provided that the value of V is not large enough to remove all the ions from the gas as it passes by the electrode. This was found experimentally to be the case.

In the comparison of the velocities, the potential V was adjusted to such a value that ρ_2 was about one half, when uranium oxide was placed in the tube at L . The active substance was then removed, and an aluminium cylinder substituted for the brass tube. X rays were allowed to fall on the centre of this aluminium cylinder, and the strength of the rays adjusted to give about the same conductivity to the gas as the uranium had done. Under these conditions the value of ρ_2 was found to be the same as for the first experiment.

This experiment shows conclusively that the ions produced by Röntgen rays and by uranium move with the same velocity and are probably identical in all respects. The method described above is not very suitable for an accurate determination of the velocities, but gave values for the positive ions of about 1.4 cms. per second per volt per centimetre, and slightly greater values for the negative ions.

Determinations of the mobility of the ions produced by Röntgen rays were first made by Rutherford*, Zeleny† and Langevin‡. Zeleny used a method similar in principle to that explained above. His results are shown in the following table, where $K+$ is the mobility of the positive ion and $K-$ that of the negative ion.

Gas	$K+$	$K-$	$\frac{K+}{K-}$	Temperature
Air, dry	1.36	1.87	1.375	13°·5 C.
„ moist	1.37	1.51	1.10	14°
Oxygen, dry	1.36	1.80	1.32	17°
„ moist	1.29	1.52	1.18	16°
Carbon dioxide, dry	0.76	0.81	1.07	17°·5
„ „ moist	0.81	0.75	0.915	17°
Hydrogen, dry	6.70	7.95	1.15	20°
„ moist	5.30	5.60	1.05	20°

* Rutherford, *Phil. Mag.* **44**, p. 422, 1897.

† Zeleny, *Phil. Trans. Roy. Soc. A*, **195**, p. 193, 1900.

‡ Langevin, *C. R.* **134**, p. 646, 1902, and *Thesis Faculty of Sciences, Paris*, p. 191, 1902.

Langevin determined the velocity of the ions by a direct method not involving a current of air. The gas was ionised by a flash of X rays, and the time taken for the positive or negative ion to travel over a known distance was observed. The principle of this method which has been used in many later investigations, was employed by Wellisch* to measure the velocities of the ions in gases and vapours. His results are given in the following table for atmospheric temperature and for a pressure of 760 mms. of mercury. It will be noted that in some of the vapours the negative ion has a smaller mobility than the positive.

Gas or vapour	Formula	Molecular weight	$K+$	$K-$
			cm./sec.	cm./sec.
Air	--	—	1·54	1·78
Carbon monoxide	CO	28	1·10	1·14
„ dioxide ...	CO ₂	44	0·81	0·85
Nitrous oxide ...	N ₂ O	44	0·82	0·90
Ammonia	NH ₃	17	0·74	0·80
Aldehyde	C ₂ H ₄ O	44	0·31	0·30
Ethyl alcohol ...	C ₂ H ₆ O	46	0·34	0·27
Aceton	C ₃ H ₆ O	58	0·31	0·29
Sulphur dioxide ...	SO ₂	64	0·44	0·41
Ethyl chloride ...	C ₂ H ₅ Cl	64·5	0·33	0·31
Pentane	C ₅ H ₁₂	72	0·36	0·35
Methyl acetate ...	C ₃ H ₆ O ₂	74	0·33	0·36
Ethyl formate ...	C ₃ H ₆ O ₂	74	0·30	0·31
„ ether	C ₄ H ₁₀ O	74	0·29	0·31
„ acetate	C ₄ H ₈ O ₂	88	0·31	0·28
Methyl bromide ...	CH ₃ Br	95	0·29	0·28
„ iodide	CH ₃ I	142	0·21	0·22
Carbon tetrachloride	CCl ₄	154	0·30	0·31
Ethyl iodide	C ₂ H ₅ I	156	0·17	0·16

The velocity of the ions in the monatomic gas, helium, have been measured by Franck and Pohl†. The value of $K+$ was 5·09 and $K-$ 6·31 cms. per second, velocities somewhat lower than those observed in hydrogen.

Measurements of the velocity of the ions have also been made by Prziham‡ for a number of vapours near their condensation

* Wellisch, *Phil. Trans. Roy. Soc. A*, 209, p. 249, 1909.

† Franck and Pohl, *Verh. d. D. Phys. Ges.* 9, p. 194, 1907.

‡ Prziham, *Wien. Ber.* 11a, 117, p. 665, 1908.

point. The values obtained are somewhat less than those to be expected from measurements at lower pressures of the vapour.

P. Phillips* using Langevin's method has shown that the velocity of the ion depends on temperature, and found that for the range of temperature between 94° C. and 411° C. absolute the velocity of the positive and negative ion was nearly proportional to the absolute temperature.

A number of observations have been made by Wellisch† of the velocity of the ions through gaseous mixtures, and no indication was found that ions of two distinct mobilities were present. Such experiments have an important bearing on the question of the size and nature of the ions produced in different gases.

The velocity of the ions varies inversely as the pressure of the gas. This was shown by Rutherford‡ for the negative ions produced by ultra-violet light, and by Langevin§ for both the negative and positive ions produced by Röntgen rays. Experiments on this question have also been made by Kovarik||. The general results show that below a pressure of about 200 mms. of mercury the velocity of the negative ion increases far more rapidly than that of the positive ion. This indicates that on the average the mass of the negative ion is diminishing. At low pressures the negative ion does not attach itself to the atom or molecule of matter but is identical with the electron.

18. Condensation experiments. Some experiments will now be described which have verified in a direct way the theory that the conductivity produced in gases by the various types of radiation is due to the production of charged ions throughout the volume of the gas. Under certain conditions, the ions form nuclei for the condensation of water, and this property allows us to show the presence of the individual ions in the gas, and also to count the number present.

It has long been known that, if air saturated with water-vapour

* Phillips, *Proc. Roy. Soc. A*, **78**, p. 167, 1906.

† Wellisch, *Proc. Roy. Soc. A*, **82**, p. 500, 1909.

‡ Rutherford, *Proc. Camb. Phil. Soc.* **9**, pt. VIII, p. 401, 1898.

§ Langevin (*loc. cit.*).

|| Kovarik, *Phys. Rev.* **30**, p. 415, 1910.

be suddenly expanded, a cloud of small globules of water is formed. These drops are formed round the dust particles present in the gas, which act as nuclei for the condensation of water around them. The experiments of R. von Helmholtz and Richarz* had shown that chemical reactions, for example the combustion of flames, taking place in the neighbourhood, affected the condensation of a steam-jet. Lenard showed that a similar action was produced when ultra-violet light fell on a negatively charged zinc surface placed near the steam-jet. These results suggested that the presence of electric charges in the gas facilitated condensation.

A very complete study of the conditions of condensation of water on nuclei has been made by C. T. R. Wilson†. An apparatus was constructed which allowed a very sudden expansion of the air over a wide range of pressure. The amount of condensation was observed in a small glass vessel. A beam of light was passed into the apparatus which allowed the drops formed to be readily observed by the eye.

Preliminary small expansions caused a condensation of the water round the dust nuclei present in the air. These dust nuclei were removed by allowing the drops to settle. After a number of successive small expansions, the air was completely freed from dust, so that no condensation was produced.

Let v_1 = initial volume of the gas in the vessel,

v_2 = volume after expansion.

If $\frac{v_2}{v_1} < 1.25$ no condensation is produced in dust-free air. If

however $\frac{v_2}{v_1} > 1.25$ and < 1.38 , a few drops appear. This number is

roughly constant until $\frac{v_2}{v_1} = 1.38$, when the number suddenly increases and a very dense cloud of fine drops is produced.

If the radiation from an X ray tube or a radio-active substance is now passed into the condensation vessel, a new series of phenomena is observed. As before, if $\frac{v_2}{v_1} < 1.25$ no drops are formed, but if

* Helmholtz and Richarz, *Annal. d. Phys.* **40**, p. 161, 1890.

† Wilson, *Phil. Trans. Roy. Soc. A*, **189**, p. 265, 1897; **192**, p. 403, 1899; **193**, p. 289, 1899.

$\frac{v_2}{v_1} = 1.25$ there is a sudden production of a cloud. The water drops of which this cloud is formed are finer and more numerous the greater the intensity of the rays. The point at which condensation begins is very marked, and a slight variation of the amount of expansion causes either a dense cloud or no cloud at all.

It now remains to be shown that the formation of a cloud by the action of the rays is due to the production of ions in the gas. If the expansion vessel is provided with two parallel plates between which an electric field can be applied, it is seen that the number of drops, formed by the expansion with the rays acting, decreases with increase of the electric field. The stronger the field the smaller the number of drops formed. This result is to be expected if the ions are the centres of condensation; for in a strong electric field the ions are carried at once to the electrodes, and thus disappear from the gas. If no electric field is acting, a cloud can be produced some time after the rays have been cut off; but if a strong electric field is applied, under the same conditions, no cloud is formed. This is in agreement with experiments showing the time required for the ions to disappear by recombination. In addition it can be shown that each one of the fine drops carries an electric charge and can be made to move in a strong uniform electric field.

The small number of drops produced without the action of the rays when $\frac{v_2}{v_1} > 1.25$ is due to a very slight natural ionisation of the gas. The existence of this ionisation has been clearly shown by electrical methods.

The evidence is thus complete that the ions themselves serve as centres for the condensation of water around them. These experiments show conclusively that the passage of electricity through a gas is due to the presence of charged ions distributed throughout the volume of the gas, and verify in a remarkable way the hypothesis of the discontinuous structure of the electric charges carried by matter.

This property of the ions of acting as nuclei of condensation gives a very delicate method of detecting the presence of ions in the gas. If only a few ions are present per c.c., their presence

after expansion is at once observed by the drops formed. In this way the ionisation due to a small quantity of uranium held a yard away from the condensation vessel is at once made manifest.

C. T. R. Wilson* has recently employed this property to render visible the effect of a single α or β particle. The path of the individual α particle is shown by the condensation of water on the ions formed in its path, and is seen as a straight luminous trail which can be photographed. A similar effect is observed for a β particle, but the trail is not nearly so intense on account of the smaller ionisation. These experiments are of great importance in showing that the β particle is a definite entity. The development of this method promises to be of great value in throwing light on the fundamental processes involved in the ionisation of gases.

19. Difference between the positive and negative ions.

In the course of experiments to determine the charge carried by an ion, J. J. Thomson† observed that the cloud formed under the influence of X rays increased in density when the expansion was about 1·31, and explained in explanation that the positive and negative ions had different condensation points.

This difference in behaviour of the positive and negative ions was investigated in detail by C. T. R. Wilson‡ in the following way. X rays were made to pass in a narrow beam on either side of a plate AB (Fig. 7) dividing the condensation vessel into two equal parts. The opposite poles of a battery of cells were connected with two parallel plates C and D , placed symmetrically with regard to A . The middle point of the battery and the plate A were connected with earth. If the plate C is positively charged, the ions in the space CA at a short distance from A are all negative in sign. Those to the right are all positive. It was found that condensation occurred only for the negative ions in AC when $\frac{v_2}{v_1} = 1\cdot25$ but did not occur in AD for the positive ions until $\frac{v_2}{v_1} = 1\cdot31$.

* C. T. R. Wilson, *Proc. Roy. Soc. A*, **85**, p. 285, 1911.

† Thomson, *Phil. Mag.* **46**, p. 528, 1898.

‡ Wilson, *Phil. Trans. A*, **193**, p. 289, 1899.

Thus the negative acts more readily than the positive ion as a centre of condensation. This is not the case with all vapours, for Przibram has shown that for some organic vapours condensation takes place more easily on the positive than on the negative ion. The greater effect of the negative ion in causing condensation of water has been suggested as an explanation of the positive charge always observed in the upper atmosphere. The negative ions under certain conditions become centres for the formation of small drops of water and are removed to the earth by the action of gravity, while the positive ions remain suspended.

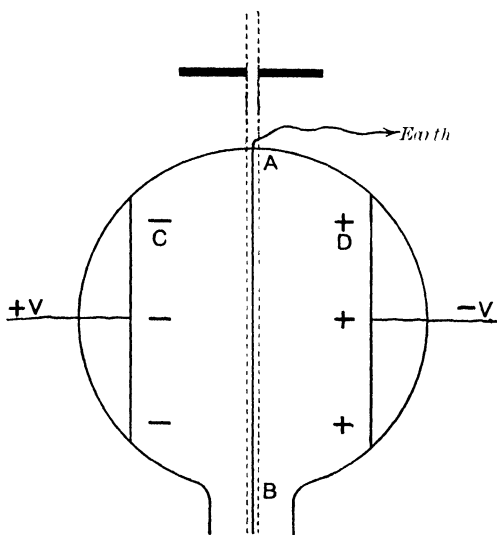

Fig. 7.

With the apparatus described above, it has been shown that the positive and negative ions are equal in number. If the expansion is large enough to ensure condensation on both ions, the drops formed on the right and left of the vessel in Fig. 7 are equal in number and fall at the same rate, *i.e.* are equal in size.

Since the ions are produced in equal numbers from a gas electrically neutral, this experiment shows that the charges on positive and negative ions are equal in value but opposite in sign.

20. Charge carried by an ion. For a known sudden expansion of a gas saturated with water vapour, the amount of water precipitated on the ions can be calculated readily. The size of the

drops can be determined by observing the rate at which the cloud settles under the action of gravity. From Stokes' equation, the terminal velocity u of a small sphere of radius r and density ρ falling through a gas of which the coefficient of viscosity is μ is given by

$$u = \frac{2}{9} \frac{\rho g r^2}{\mu},$$

where g is the acceleration due to gravity. The radius of the drop and consequently the weight of water in each drop can thus be determined. Since the total weight of water precipitated is known, the number of drops present is obtained at once.

This method was initially used by J. J. Thomson* to determine the charge carried by an ion. If the expansion exceeds the value 1.31, both positive and negative ions become centres of condensation. From the rate of fall it can be shown that approximately the drops are all of the same size.

The condensation vessel was similar to that employed by C. T. R. Wilson. Two parallel horizontal plates were fitted in the vessel, and the radiation from an X ray tube or a radio-active substance ionised the gas uniformly between them. A difference of potential, small compared to that required to saturate the gas, was applied, and from the measurement of this current the number of ions present in the gas at the moment of expansion was determined. In this way, the charge carried by the drop formed round the ion was measured. In his last determination Sir J. J. Thomson found that the value of the ionic charge $e = 3.4 \times 10^{-10}$ electrostatic units. Experiments by a somewhat different method were made by H. A. Wilson† who found $e = 3.1 \times 10^{-10}$. The rate of fall of the drops was determined when a strong electric field was applied between the parallel plates. The general evidence indicates that the ion formed in different gases has initially the same charge. Wilson, however, observed that some of the drops formed by condensation carried multiples of two or more ionic charges. This no doubt is to be ascribed to the coalescence of two or more drops.

* Thomson, *Phil. Mag.* **46**, p. 528, 1898; **5**, p. 346, 1903; *Conduction of Electricity through Gases*, Camb. Univ. Press, 2nd edit., p. 150, 1906.

† H. A. Wilson, *Phil. Mag.* **5**, p. 429, 1903.

The value of e , which other evidence shows to be identical with the positive charge carried by the atom of hydrogen liberated in the electrolysis of water, is a fundamental constant of great importance, and represents the smallest unit into which a quantity of electricity is divisible. A large number of different principles and methods have been employed in recent years to determine the value of e with the greatest possible accuracy. Millikan* has made a number of accurate measurements, employing a similar principle to that used by H. A. Wilson. The main difficulty of experiment with water drops is their rapid evaporation with time. To overcome this, Millikan used minute drops of oil. These charged drops were introduced between the parallel plates in which a strong electric field was applied, and the movements of individual drops were followed by a microscope. By adjusting the value of the field which acted against gravity, it was found possible to keep an ion suspended in nearly the same position in the gas for an hour at a time. The experiment showed that each of these drops of oil carried a definite multiple of the smallest charge. A number of experiments were made to test the validity of Stokes' law for drops of different sizes, and a suitable correction was made from the observations. The final result obtained gave a value $e = 4.90 \times 10^{-10}$ electrostatic units. On the other hand, Perrin† from an examination of the equilibrium and distribution in a solution of fine particles which show the Brownian movement, concludes that the value of $e = 4.1 \times 10^{-10}$.

A determination of e from radio-active data was made by Rutherford and Geiger‡, of which an account is given in section 61. The number of α particles passing into a vessel were directly counted, and the total charge carried by the particles determined. It was found that each α particle carried a charge 9.3×10^{-10} units, and from various evidence it was concluded that this was twice the unit charge. Observations of a somewhat similar character were made by Regener§. In this case, the α particles were determined

* Millikan, *Phil. Mag.* **19**, p. 209, 1910; *Science*, **32**, p. 436, 1910.

† Perrin, *Le Radium*, **6**, p. 353, 1909; *Ann. d. Chem. et Phys.* Sept. 1909. See also *Brownian Movement*, Taylor and Francis, 1910 (translated by F. Soddy, F.R.S.).

‡ Rutherford and Geiger, *Proc. Roy. Soc. A*, **81**, p. 162, 1908.

§ Regener, *Ber. d. k. Preuss. Akad. d. Wiss.* **38**, p. 948, 1909.

by noting the number of scintillations produced on a diamond. The value found by him was $e = 4.79 \times 10^{-10}$. Observations by a number of other methods have also been made, and in practically all cases the value for e lies between 4×10^{-10} and 5×10^{-10} units. In the present book the value of $e = 4.65 \times 10^{-10}$ electrostatic units is taken. This value, as we have seen, was determined by radio-active measurements, and is about a mean value of the results obtained by different methods.

21. Diffusion of the ions. Early experiments with ionised gases showed that the conductivity was removed from the gas by passage through a finely divided substance like cotton-wool, or by bubbling through water. This loss of conductivity is due to the fact that the ions in passing through narrow spaces diffuse to the sides of the boundary, to which they either adhere or give up their charge.

A direct determination of the coefficient of diffusion of the ions produced in gases by Röntgen rays or by the rays from active substances has been made by Townsend*. The general method employed was to pass a stream of ionised gas through a diffusion vessel made up of a number of fine metal tubes arranged in parallel. Some of the ions in their passage through the tubes diffuse to the sides, the proportion being greater the slower the motion of the gas and the narrower the tube. Observations were made of the conductivity of the gas before and after passage through the tubes. In this way, correcting if necessary for the recombination during the time taken to pass through the tubes, the proportion R of either positive or negative ions which are abstracted can be deduced. The value of R can be expressed mathematically in terms of the coefficient of diffusion D , the length and radius of the tube and the velocity of the gas current.

The following table shows the results obtained by Townsend when X rays were used. Almost identical results were obtained later, when the radiations from active substances replaced the X rays.

The moist gases were saturated with water vapour at a temperature of 15° C.

* Townsend, *Phil. Trans. Roy. Soc. A*, **193**, p. 129, 1899.

Coefficients of diffusion of ions into gases.

Gas	D for + ions	D for - ions	Mean value of D	Ratio of values of D
Air, dry	·028	·043	·0347	1·54
„ moist	·032	·035	·0335	1·09
Oxygen, dry	·025	·0396	·0323	1·58
„ moist	·0288	·0358	·0323	1·24
Carbonic acid, dry	·023	·026	·0245	1·13
„ moist	·0245	·0255	·025	1·04
Hydrogen, dry ...	·123	·190	·156	1·54
„ moist ...	·128	·142	·135	1·11

It is seen that the negative ion in all cases diffuses faster than the positive. This difference in the rate of diffusion of the ions at once explains an interesting experimental result. If ionised gases are blown through a metal tube, the tube gains a negative charge while the gas itself retains a positive charge. The number of positive and negative ions present in the gas is originally the same, but, in consequence of the more rapid diffusion of the negative ions, more of the negative ions than the positive give up their charges to the tube. The tube consequently gains a negative and the gas a positive charge.

From a comparison of the coefficient of diffusion of the ions in various gases with the mobility of the ions, it is seen that they are directly proportional to each other. The negative ion in the simple gases travels faster than the positive ion, and also diffuses faster. This relation is to be expected theoretically and can be deduced from simple considerations*. According to the definition of diffusion, the number of ions which in unit time cross unit area of a plane perpendicular to the axis of x is $D \frac{dn}{dx}$, where n is the number of ions per unit volume. The ions may consequently be supposed to move in the direction of x with an average velocity of $\frac{1}{n} D \frac{dn}{dx}$. Since the ions exist in the gaseous state, they will produce a partial pressure p proportional to their concentration.

* See J. J. Thomson, *Conduction of Electricity through Gases*, 1906, p. 42.

This average velocity is therefore $\frac{1}{p} D \frac{dp}{dx}$. Now $\frac{dp}{dx}$ is the force acting on unit volume of the gas parallel to x . It follows from this that we may regard the ions to move with an average velocity D/p along the axis of x when the force dp/dx is unity. If now an electric force X along the axis of x be supposed to act on the ionised gas, the force on the ions per unit volume is Xen . If u be the average velocity of the ions along the axis of x , then

$$u = Xen \cdot \frac{D}{p}.$$

Let N be the number of molecules in unit volume of the gas at the pressure P and the temperature (15° C.) for which the values of D have been determined. Since the ion is supposed to act like the molecules of a perfect gas N/P may be substituted for n/p and is a constant for all gases at the same temperature. When X is equal to one volt ($1/300$ e.s. unit) per cm., u is the same as the mobility K of the ions. Taking P at atmospheric pressure = 10^6 dynes per sq. cm., $Ne = \frac{3 \times 10^8 \cdot K}{D}$. This result shows that the values of K and D should be proportional to each other for all gases, and this we have seen is very approximately the case.

Townsend (*loc. cit.*) has shown that another conclusion of great importance can be deduced from this relation by comparing the value of Ne for the ions with the corresponding value for the charged atoms of hydrogen obtained from the electrolysis of water.

It is known that one absolute electromagnetic unit of electricity in passing through water liberates 1.23 c.c. of hydrogen at a temperature of 15° C. and standard pressure. The number of atoms in this volume is $2.46 N$, and, if e' is the charge on the hydrogen atom in the electrolysis of water,

$$2.46 Ne' = 3 \times 10^{10} \text{ e.s. units,}$$

$$\text{and} \quad Ne' = 1.22 \times 10^{10} \text{ e.s. units.}$$

$$\text{Thus} \quad \frac{e}{e'} = 2.46 \times 10^{-2} \frac{K}{\bar{E}}.$$

For example, substituting the values of K and D determined in moist air for the positive ion,

$$\frac{e}{e'} = \frac{2.46}{100} \times \frac{1.37}{.032} = 1.04.$$

Values of this ratio, not very different from unity, are obtained for the positive and negative ions of the gases hydrogen, oxygen, and carbon dioxide. Taking into consideration possible experimental errors in the values of K and D , these results indicate that the *charge carried by an ion in all gases is the same and is equal to that carried by the hydrogen ion in the electrolysis of liquids.*

22. Size and nature of the ions. An approximate estimate of the mass of an ion, compared with the mass of the molecule of the gas in which it is produced, can be made from the determination of the coefficient D of inter-diffusion of the ions into gases. The value of D for the positive ions in moist carbon dioxide has been shown to be .0245, while the corresponding value of D for the inter-diffusion of carbon dioxide with air is .14. The value of D for different gases is approximately inversely proportional to the square root of the products of the masses of the molecules of the two inter-diffusing gases; thus, the positive ion in carbon dioxide behaves as if its mass were large compared with that of the molecule. Similar results hold for the negative as well as for the positive ion, and for other gases besides carbon dioxide.

This early led to the view that the ion consists of a charged centre surrounded by a cluster of molecules travelling with it, which are kept in position round the charged nucleus by electrical forces*. A rough estimate shows that this cluster consists of about 30 molecules of the gas. This idea is supported by the variation in velocity, *i.e.* the variation of the size of the negative ion, in the presence of water vapour; for the negative ion undoubtedly appears to have in most cases a greater mass in moist than in dry gases. At the same time it is possible that the apparently large size of the ion, as determined by diffusion methods, may be in part a result of the charge carried by the ion. The presence of

* Rutherford, *Phil. Mag.* **44**, p. 422, 1897.

a charge on a moving body would increase the frequency of collision with the molecules of the gas, and consequently diminish the rate of diffusion. The ion on this view may not actually be of greater size than the molecule from which it is produced.

Theories to take into account the effect of the charge of the ion on its rate of diffusion have been advanced by Langevin* and Wellisch†. The latter concludes that the experimental results can be explained by assuming that the ions have the same mass as a molecule of the gas in which they are formed. From physical considerations, however, it appears very probable that a charged ion would become the centre of an aggregate of neutral molecules which travel with it. The apparent mass of the ion may be due to the combined effects of the charge and of the attendant cluster. It is of interest to note that the velocity of the positively charged recoil atoms from radio-active matter which have a molecular weight of over 200 travel in an electric field in hydrogen with the same velocity as the hydrogen ion‡. Such a result indicates that the initial mass of the positive ion has little, if any, effect on its velocity.

It has already been pointed out that the negative and positive ions differ in size, and this difference becomes very pronounced for low pressures of the gas. For example, at atmospheric pressure, the negative ion liberated by the action of ultra-violet light from a metal surface is identical with the ion produced in the same gas by X rays. At low pressures, J. J. Thomson showed the negative ion set free by ultra-violet light is identical with the electron. It thus appears that the negative ion at low pressures sheds its attendant cluster. The general evidence indicates that the electron retains its individuality for some time in a gas at low pressure, but at high pressures it rapidly becomes attached to a molecule of the gas and moves with it.

It is generally supposed that the process of ionisation in gases consists in the removal of a negative corpuscle or electron from the molecule of the gas. At ordinary pressure, the electron attaches to itself a molecule or group of molecules, and becomes

* Langevin, *Ann. d. Phys. et Chimie*, vii. 28, p. 335, 1903.

† Wellisch, *Phil. Trans. Roy. Soc. A*, 209, p. 249, 1909.

‡ J. Franck, *Verh. d. D. Phys. Ges.* 11, p. 397, 1909.

the negative ion. After removal of the negative corpuscle, the molecule retains a positive charge, and possibly becomes also the centre of a cluster of neutral molecules.

Although the above view of the mechanism of ionisation does not assume that a complex molecule is dissociated, the process of ionisation is undoubtedly accompanied by marked chemical action. This is well illustrated by the rapid decomposition of water by α rays into hydrogen and oxygen, and also by the reverse process of recombination of these gases when exposed to the same rays. This dissociation of complex molecules by the radiation may be a secondary and not a primary effect. The amount of chemical action produced by the α rays is of the right magnitude to be expected if the ionisation of each molecule was accompanied by its dissociation (see section 115).

From consideration of the action of various agents in producing ionisation in gases, Sir J. J. Thomson and also Bragg have suggested that the process of ionisation may be more complex than ordinarily supposed, and that the initial process of ionisation consists in the removal of a neutral doublet. This breaks up into a positive and negative charge, each of which becomes attached under ordinary conditions to the molecules of the gas and moves with them.

23. The number and distribution of the ions. The main part of the radiation from active bodies consists of a stream of charged particles projected with great velocity. Of this radiation, the α particles, which under ordinary conditions produce most of the ionisation in the gas, consist of charged atoms of helium projected with a velocity of about $1/15$ of the velocity of light. The β rays are identical with the cathode rays produced in a vacuum tube, and in general move with a velocity of the same order as that of light. The α particles travel nearly in straight lines, and produce a very intense ionisation along their path. The number of ions produced in air at atmospheric pressure depends on the speed of the α particle, and varies between 2000 and 6000 per millimetre of path. The high speed β particle is in general a much less efficient ioniser, and does not produce more than 20 or 30 ions per millimetre of path (see section 93). It is

thus seen that the ionisation produced by each of these radiations is not uniform, but is initially confined to columns in the gas of a small cross-section. When a large number of particles pass each second through the gas, the process of diffusion tends to equalise to some extent the distribution of ions in the volume considered. In most cases the number of ions produced per second in the gas is minute compared with the number of molecules present. For example, by the electric method, it is possible to detect in a volume of about one litre the production of one or two ions per c.c. per second. Since the number of molecules in one c.c. of a gas at standard temperature and pressure is 2.7×10^{19} , about one molecule in 10^{19} is ionised per second.

If i be the saturation current through a volume of a gas which is uniformly ionised, the number of ions q produced per second is given by $q = i/e$ where e is the charge carried by the ion which is equal to 4.65×10^{-10} e.s. units. In dealing with very active substances like radium, the ionisation near its surface due to the α rays is very intense. It is of interest to calculate the rate of production of ions in an extreme case which can be realised experimentally. Suppose that the emanation from 100 milligrams of radium is purified and confined in a small glass sphere one millimetre in diameter, the walls of which are so thin that the α particles are projected through it with little absorption. The number of α particles emitted per second from the emanation in equilibrium is 10^{10} . Each α particle will produce about 2000 ions per millimetre of its path near the sphere. A simple calculation shows that the fraction of the molecules ionised per second near the surface of the sphere is about 2×10^{-4} . In the course of a few days, it is evident that a large proportion of the molecules of the gas present would have undergone ionisation and consequent recombination. In such a case as we have been considering, the ionisation of the air would have been accompanied by chemical action resulting in the formation of ozone and of the oxides of nitrogen.

24. Variation of the current under different conditions.

It is now necessary to consider the variation of the current through ionised gases under different experimental conditions.

With unscreened active material, the ionisation of the gas is in most cases mainly due to the α rays which are absorbed in their passage through a few centimetres of air. In consequence of this rapid absorption, the ionisation decreases rapidly from the surface of the active body, and this gives rise to the conductivity phenomena different in character from those observed in cases where the ionisation is more uniform. The full expression of the variation of the ionisation with distance from a large plane surface of active matter is very complicated. It has been found experimentally, however, that the intensity of the ionisation in many cases falls off approximately according to an exponential law with distance from the plate. For simplicity of calculation, this law of decrease will be assumed as it brings out clearly the main points under consideration. The ionisation q per unit volume at a distance x from the surface of the plate is given by $q = q_0 e^{-\lambda x}$, where λ is a constant, x the distance from the plate, and q_0 the intensity of the ionisation at the surface of the plate. Suppose, for example, the saturation current is measured between two parallel plates distant d apart, when the lower plate is uniformly covered with radio-active matter. The saturation current i per unit area of the plate is given by

$$i = q_0 e \int_0^d e^{-\lambda x} dx = \frac{q_0 e}{\lambda} (1 - e^{-\lambda d}),$$

where e is the charge carried by the ions. When λd is small, *i.e.* when the ionisation is nearly constant between the plates, $i = qed$; when λd is large the saturation current $i_0 = \frac{q_0 e}{\lambda}$, and is independent of further increase in the value of d . In such a case, the radiation is completely absorbed in producing ions between the plates and $i/i_0 = 1 - e^{-\lambda d}$. In the case of a thick layer of uranium, thorium or radium, the average ionisation per unit volume decreases to half value after traversing less than 1 centimetre of air, at atmospheric pressure.

25. Variation of the current with pressure. The rate of production of ions by the radiations from active substances is directly proportional to the pressure of the gas. The absorption of

the radiation in the gas also varies directly as the pressure. The latter result necessarily follows if the energy required to produce an ion is independent of the pressure.

In cases where the ionisation is uniform between two parallel plates, the current will vary directly as the pressure; when however the ionisation is not uniform, on account of the absorption of the radiation in the gas, the current does not decrease directly as the pressure until the pressure is reduced so far that the ionisation is sensibly uniform. Consider the variation with pressure of the saturation current i between two large parallel plates, one of which is covered with a uniform layer of active matter.

Let λ_1 = absorption constant of the radiation in the gas for unit pressure.

For a pressure p , the ionisation q at any point x is given by $q/q_0 = e^{-p\lambda_1 x}$. The saturation current i is thus proportional to

$$\int_0^d p q dx = \int_0^d p q_0 e^{-p\lambda_1 x} \cdot dx = \frac{q_0}{\lambda_1} (1 - e^{-p\lambda_1 d}).$$

If r be the ratio of the saturation currents for the pressures p_1 and p_2 ,

$$r = \frac{1 - e^{-p_1 \lambda_1 d}}{1 - e^{-p_2 \lambda_1 d}}.$$

The ratio is thus dependent on the distance d between the plates and the absorption of the radiation by the gas.

The difference in the shape of the pressure-current curves* is well illustrated in Fig. 8, where curves are given for hydrogen, air, and carbonic acid for plates 3.5 cms. apart.

For the purpose of comparison, the current at atmospheric pressure and temperature in each case is taken as unity. The actual value of the current was greatest in carbonic acid and least in hydrogen. In hydrogen, where the absorption is small, the current over the whole range is nearly proportional to the pressure. In carbonic acid, where the absorption is large, the current diminishes at first slowly with the pressure, but is nearly proportional to it below the pressure of 235 mms. of mercury. The curve for air occupies an intermediate position.

* Rutherford, *Phil. Mag.* **47**, p. 109, 1899.

In cases where the distance between the plates is large, the saturation current will remain constant with diminution of pressure until the absorption is so reduced that the radiation reaches the other plate.

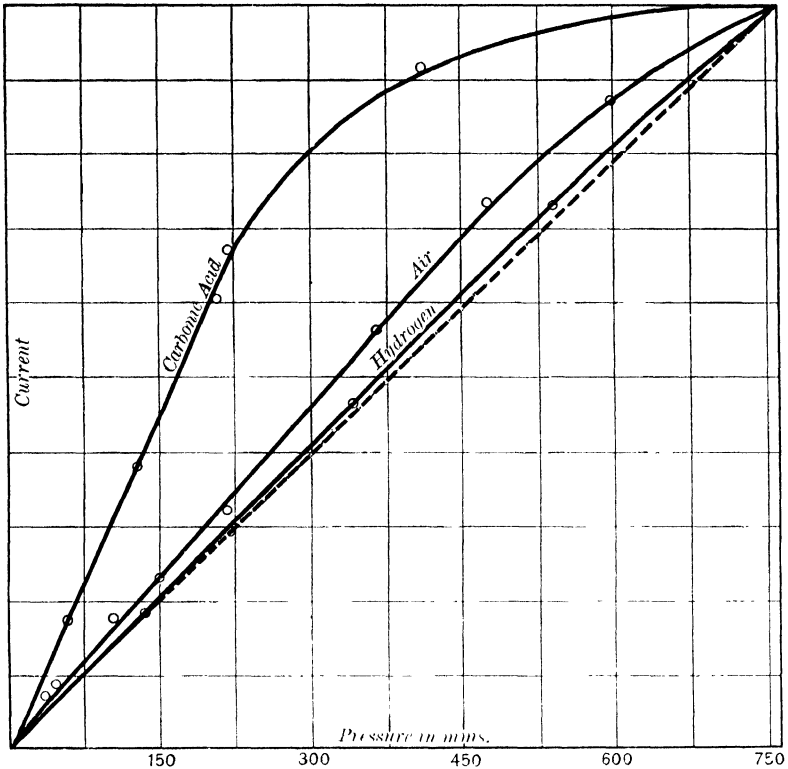

Fig. 8.

26. Conductivity of different gases. For a given intensity of radiation, the rate of production of ions in a gas varies for different gases and increases with the density of the gas. Strutt* and later Kleeman† have made a very complete examination of the relative conductivity of gases exposed to the different types of rays emitted by active substances. To avoid correction for any difference of absorption of the radiation in the various gases, the pressure of the gas was always reduced until the ionisation was directly proportional to the pressure, when, as we have seen above,

* Strutt, *Phil. Trans. A*, 196, p. 507, 1901 and *Proc. Roy. Soc. A*, 74, p. 208, 1903.

† Kleeman, *Proc. Roy. Soc. A*, 79, p. 220, 1907.

he ionisation must everywhere be uniform throughout the gas. For each type of rays, the ionisation of air is taken as unity. The currents through the gases were determined at different pressures, and were reduced to a common pressure by assuming that the ionisation was proportional to the pressure.

With unscreened active material, the ionisation is almost entirely due to α rays. When the active substance is covered with a layer of aluminium 0.01 cm. in thickness, the ionisation is mainly due to the β or cathodic rays, and when covered with 1 mm. of lead, the ionisation is solely due to the γ or very penetrating rays. The following table gives the relative conductivities of gases exposed to various kinds of ionising radiations.

*Relative ionisation produced in various gases by
 α , β , and γ rays.*

Gas	Relative density	α	β	γ	X rays (Strutt)
Air ...	1.00	1.00	1.00	1.00	1.00
H ...	0.069	0.24	0.115	0.160	0.114
O ...	1.11	1.15	1.17	1.16	1.39
N ₂ O ...	1.53	1.53	1.55	1.55	—
CO ₂ ...	1.53	1.59	1.60	1.58	1.60
NH ₃ ...	0.590	0.81	0.888	0.898	—
SO ₂ ...	2.19	2.01	2.25	2.27	7.97
CS ₂ ...	2.64	2.99	3.62	3.66	—
C ₄ H ₁₀ O ...	2.57	4.40	4.39	4.29	—
C ₅ H ₁₂ ...	2.50	1.85	4.55	4.53	—
C ₂ H ₄ O ...	1.53	2.12	2.14	2.17	—
C ₂ H ₅ Cl ...	2.24	3.12	3.24	3.19	—
CHCl ₃ ...	4.15	4.08	4.94	4.93	—
CCl ₄ ...	5.35	5.28	6.28	6.33	45.3
Ni(Co) ₄ ...	5.99	—	—	5.98	—
CH ₃ Br ...	3.30	2.75	3.73	3.81	—
CH ₃ I ...	4.93	3.43	5.11	5.37	—
C ₂ H ₅ I ...	5.41	4.00	5.90	6.47	—

In the above table, taken from Kleeman, the relative ionisation is expressed in terms of air taken as unity. Some of the values for Röntgen rays, obtained by Strutt, are added for comparison. The ionisation by the β and γ rays is, in many cases, nearly proportional to the density of the gas or vapour. This relation does not hold for the α rays, where the absorption of the radiations by

the gas follows a different law. Kleeman has shown that for the three types of the radiation, the values obtained are consistent with the view that the ionisation for a complex molecule is additive, and can be deduced from a knowledge of the ionisation due to its component atoms. In the case of X rays, the ionisation, especially for heavy gases and vapours, increases much more rapidly than the density. It should be pointed out, however, that the relative ionisation of gases due to X rays is not a constant, but depends very greatly upon the penetrating power of the radiation employed. The large ionisation observed appears to be connected with the emission of marked secondary radiation from the gas. Eve* has shown, using very penetrating X rays, that the relative ionisation tends to approach the values observed for penetrating γ rays. The conductivity of gases is approximately proportional to the absorption of the energy of the radiation by the gas.

In order to determine the relative energy required to produce a pair of ions in different gases, it is necessary to measure the total ionisation produced in gases by the complete absorption of the radiation. This has been done by Rutherford† and by Laby‡ by using a sufficient volume of gas to absorb completely the α rays from uranium and by measuring the saturation currents. Bragg§ and Kleeman|| have investigated the question by a more indirect method. The ionisation at a definite point of the range of a pencil of homogeneous α rays was determined for gases and vapours at suitable pressures. Knowing the variation of ionisation of the α particle at different points of its range, the total ionisation produced by a complete absorption of the α particle can be deduced. Some of the results obtained by various observers are given in the table on the next page.

For the simple gases the total ionisation is approximately the same, indicating that about the same energy is required in each case to produce a pair of ions. For complex gases and vapours

* Eve, *Phil. Mag.* **8**, p. 610, 1904.

† Rutherford, *Phil. Mag.* **47**, p. 109, 1899.

‡ Laby, *Proc. Roy. Soc. A*, **79**, p. 206, 1907.

§ Bragg, *Phil. Mag.* **13**, p. 333, 1907.

|| Kleeman, *Proc. Roy. Soc. A*, **79**, p. 220, 1907.

however, it is seen that the total ionisation is in some cases about 30 per cent. greater than in air. There is a possible source of error in some of the values deduced by Bragg. It was supposed at the time of the experiments that the relative ionisation at different points of the range of an α particle was the same for all gases. More recent experiments by Taylor*, however, show that this is not correct. This question is discussed in more detail later (section 67). The question whether the amount of energy absorbed in the process of ionisation is dependent on the nature of the gas is very important. As we have seen, the process of ionisation for complex molecules may not only result in the initial expulsion of an electron but also in a chemical dissociation of the molecule into two charged components. The energy required for the two types of dissociation may be quite different in magnitude.

Total ionisation due to α rays.

Gas	Rutherford	Laby	Bragg
Air . . .	1.00	1.00	1.00
Hydrogen . . .	0.95	—	—
Nitrogen . . .	—	—	0.96
Nitrous oxide . . .	—	0.99	1.05
Ammonia . . .	1.01	0.90	—
Carbonic acid . . .	0.96	1.03	1.08
Acetylene . . .	—	1.27	1.26
Pentane . . .	—	1.345	1.35
Ether . . .	—	1.29	1.31
Ethyl chloride . . .	—	1.18	1.30

27. Potential Gradient. The normal potential gradient between two charged electrodes is always disturbed when the gas is ionised in the space between them. If the gas is uniformly ionised between two parallel plates, Child and Zeleny have shown that there is a sudden drop of potential near the surface of both plates, and that the electric field is sensibly uniform for the intermediate space between them. The disturbance of the potential gradient depends upon the difference of potential applied, and is different at the surface of the two plates.

* Taylor, *Amer. Journ. Sci.* **28**, p. 357, 1909; *Phil. Mag.* **21**, p. 571, 1911.

In most measurements of radio-activity the material is spread over one plate only. In such a case the ionisation is to a large extent confined to the volume of the air close to the active plate. The potential gradient* in such a case is shown in Fig. 9. The dotted line shows the variation of potential at any point between the plates when no ionisation is produced between the plates; curve *A* for weak ionisation, such as is produced by uranium, curve *B* for the intense ionisation produced by a very active substance. In both cases the potential gradient is least near

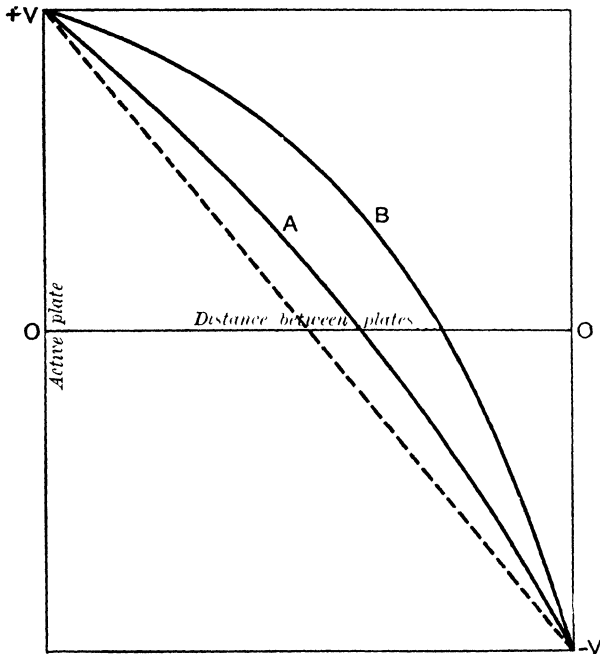

Fig. 9.

the active plate, and greatest near the opposite plate. For very intense ionisation it is very small near the active surface. The potential gradient varies slightly according as the active plate is charged positively or negatively.

28. Variation of current with voltage for surface ionisation. Some very interesting results, giving the variation of the current with voltage, are observed when the ionisation is intense, and confined to the space near the surface of one of two parallel plates between which the current is measured.

* Rutherford, *Phil. Mag.* 47, p. 109, 1899.

The theory of this subject has been worked out independently by Child* and Rutherford†. Let V be the potential difference between two parallel plates at a distance d apart. Suppose that the ionisation is confined to a thin layer near the surface of the plate A (see Fig. 1) which is charged positively. When the electric field is acting, there is a distribution of positive ions between the plates A and B .

Let n_1 = number of positive ions per unit volume at a distance x from the plate A ,

K_1 = mobility of the positive ions,

e = charge on an ion.

The current i_1 per square centimetre through the gas is constant for all values of x , and is given by

$$i_1 = K_1 n_1 e \frac{dV}{dx}.$$

By Poisson's equation

$$\frac{d^2 V}{dx^2} = 4\pi n_1 e.$$

Then

$$i_1 = \frac{K_1}{4\pi} \frac{dV}{dx} \frac{d^2 V}{dx^2}.$$

Integrating

$$\left(\frac{dV}{dx}\right)^2 = \frac{8\pi i_1 x}{K_1} + A,$$

where A is a constant. Now A is equal to the value of $\frac{dV}{dx}$ when $x=0$. By making the ionisation very intense, the value of $\frac{dV}{dx}$ can be made extremely small.

Putting $A=0$, we see that

$$\frac{dV}{dx} = \pm \sqrt{\frac{8\pi i_1 x}{K_1}}.$$

This gives the potential gradient between the plates for different values of x .

* Child, *Phys. Rev.* **12**, pp. 65, 135, 1901.

† Rutherford, *Phil. Mag.* **2**, p. 210, 1901; *Phys. Rev.* **13**, p. 32, 1901.

Integrating between the limits 0 and d ,

$$V = \pm \frac{2}{3} \sqrt{\frac{8\pi i_1}{K_1}} d^{\frac{3}{2}},$$

or

$$i_1 = \frac{9V^2}{32\pi d^3} K_1.$$

If i_2 is the value of the current when the electric field is reversed, and K_2 the velocity of the negative ion,

$$i_2 = \frac{9V^2}{32\pi d^3} K_2,$$

and

$$\frac{i_1}{i_2} = \frac{K_1}{K_2}.$$

The current in the two directions is thus directly proportional to the velocities of the positive and negative ions. The current should vary directly as the square of the potential difference applied, and inversely as the cube of the distance between the plates.

The theoretical condition of surface ionisation cannot be fulfilled by the ionisation due to active substances, as the ionisation extends some centimetres from the active plate. If, however, the distance between the plates is large compared with the distance over which the ionisation extends, the variation of current with voltage is in approximate agreement with the theory. On account of the difference in velocity of the positive and negative ion, the magnitude of the current for a given voltage depends upon the direction of the electric field, and is always greater when the active plate is charged negatively. These effects are well illustrated by using an active preparation of radium as a source of α rays and measuring the variation of current with voltage for parallel plates about 10 cms. apart.

When the gas between the plates is at a high pressure, the ionisation extends a very short distance from the active plate. The theoretical conditions are then nearly fulfilled, and the current is found to vary over a considerable range as the square of the potential difference applied. By using a preparation of ionium as a source of radiation, Kovarik* has employed this method to

* Kovarik, *Proc. Roy. Soc. A*, **86**, p. 154, 1911.

determine the velocity of the positive and negative ions up to pressures of 100 atmospheres.

29. Magnetic field produced by an ion in motion. It will be shown later that the two most important kinds of rays emitted by radio-active substances consist of electrified particles, spontaneously projected with great velocity.

The methods adopted to determine the character of these rays are very similar to those first used by J. J. Thomson to show that the cathode rays consisted of a stream of negatively electrified particles travelling with great speed.

The proof that the cathode rays were corpuscular in character, and consisted of charged particles whose mass was very small compared with that of the hydrogen atom, marked an important epoch in physical science: for it not only opened up new and fertile fields of research, but also profoundly modified our previous conceptions of the constitution of matter.

A brief account will accordingly be given of the effects produced by a moving charged body, and also of some of the experimental methods which have been used to determine the mass and velocity of the particles of the cathode stream*.

Consider an ion of radius a , carrying a charge of electricity e , and moving with a velocity u , small compared with the velocity of light. In consequence of the motion, a magnetic field is set up around the charged ion, which is carried with it. The charged ion in motion constitutes a current element of magnitude eu , and the magnetic field H at any point distant r from the sphere is given by

$$H = \frac{eu \sin \theta}{r^2},$$

where θ is the angle the radius vector makes with the direction of motion. The lines of magnetic force are circles around the axis of motion. When the ion is moving with a velocity small compared with the velocity of light, the lines of electric force are nearly

* A simple and excellent account of the effects produced by the motion of a charged ion and also of the electronic theory of matter was given by Sir Oliver Lodge in 1903 in a paper entitled "Electrons" (*Proceedings of the Institution of Electrical Engineers*, Part 159, Vol. 32, 1903). See also J. J. Thomson's *Electricity and Matter* (Scribner, New York, 1904).

radial, but as the speed of light is approached, they tend to leave the axis of motion and to bend towards the equator. When the speed of the body is very close to that of light, the magnetic and electric field is concentrated to a large extent in the equatorial plane.

The presence of a magnetic field around the moving body implies that magnetic energy is stored up in the medium surrounding it. The amount of this energy can be calculated very simply for slow speeds.

In a magnetic field of strength H , the magnetic energy stored up in unit volume of the medium of unit permeability is given by $\frac{H^2}{8\pi}$. Integrating the value of this expression over the region exterior to a sphere of radius a , the total magnetic energy due to the motion of the charged body is given by

$$\begin{aligned} \int_a^\infty \frac{H^2}{8\pi} d(\text{vol}) &= \frac{e^2 u^2}{8\pi} \int_0^{2\pi} \int_0^\pi \int_a^\infty \frac{\sin^2 \theta}{r^4} \cdot r \sin \theta d\phi r d\theta dr \\ &= \frac{e^2 u^2}{4} \int_0^\pi \int_a^\infty \frac{(1 - \cos^2 \theta)}{r^2} \sin \theta d\theta \cdot dr \\ &= \frac{e^2 u^2}{3} \int_a^\infty \frac{dr}{r^2} = \frac{e^2 u^2}{3a}. \end{aligned}$$

The magnetic energy, due to the motion, is analogous to kinetic energy, for it depends upon the square of the velocity of the body. In consequence of the charge carried by the ion, additional kinetic energy is associated with it. If the velocity of the ion is altered, electric and magnetic forces are set up tending to stop the change of motion, and more work is done during the change than if the ion were uncharged. The ordinary kinetic energy of the body is $\frac{1}{2}mu^2$. In consequence of its charge, the kinetic energy associated with it is increased by $\frac{e^2 u^2}{3a}$. It thus behaves as if it possessed a mass $m + m_1$, where m_1 is the *electrical mass*, with the value $\frac{2e^2}{3a}$.

We have so far only considered the electrical mass of a charged ion moving with a velocity small compared with that of light. As the speed of light is approached, the magnetic energy can no longer be expressed by the equation already given. The general

values of the electrical mass of a charged body for speed were first worked out by J. J. Thomson* in 1881. A more complete examination was made in 1889 by Heaviside†, while Searle‡ worked out the case for a charged ellipsoid. Recently, the question was again attacked by Abraham§. Slightly different expressions for the variation of electrical mass with speed have been obtained, depending upon the conditions assumed for the distribution of the electricity on the sphere.

Let m_0 = mass of ion for slow speeds,

m = apparent mass of electron at any speed,

u = velocity of ion,

V = velocity of light.

If $u/V = \beta$, the expression found by Abraham is $m/m_0 = 3/4 \psi(\beta)$, where

$$\psi(\beta) = \frac{1}{\beta^2} \left[\frac{1 + \beta^2}{2\beta} \log \frac{1 + \beta}{1 - \beta} - 1 \right].$$

Later, Lorentz, and Einstein using the principle of relativity have deduced the expression $m/m_0 = (1 - \beta^2)^{-\frac{1}{2}}$. The first experiment to determine the variation of the apparent mass of an ion with speed was made by Kaufmann using a radium preparation as a source of high speed β rays. His results showed that the apparent mass of the β particle or electron, increased rapidly with speed near the velocity of light. By comparison with the theoretical expression developed by Abraham, it was deduced that the mass of the electron must be mainly electrical in origin, and that there was no necessity to assume a material nucleus on which the charge was distributed. Experiments by another method were made later by Bucherer, who found that the variation of the mass of the electron with speed was in close agreement with the Lorentz-Einstein formula given above. An account of these experiments will be given later (section 81). The value of e/m_0 for the electron at low speeds was found to be 1.70×10^7 e.m. units. We have seen that the electrical mass of an ion at slow

* J. J. Thomson, *Phil. Mag.* **11**, p. 229, 1881.

† Heaviside, *Collected Papers*, Vol. 2, p. 514.

‡ Searle, *Phil. Mag.* **44**, p. 329, 1897.

§ Abraham, *Phys. Zeit.* **4**, p. 57, 1902.

speeds is given by $m_0 = 2e^2/3a$, where a is the radius of the ion. Consequently $a = \frac{2}{3} \frac{e}{m_0}$. $e = 1.03 \times 10^{-13}$, taking $e = 1.55 \times 10^{-20}$ e.m. units. The electron thus behaves as if it were an electrical charge distributed over a sphere of radius small compared with the apparent diameter of an atom of matter, viz. 10^{-7} or 10^{-8} cms. In consequence of its minute dimensions, the greater part of the electric and magnetic energy associated with the electron in motion is stored up in a sphere of radius about 10^{-12} cms.

All the calculations agree in showing that the electrical mass is practically constant for slow speeds, but increases as the speed of light is approached, and is theoretically infinite when the speed of light is reached. The nearer the velocity of light is approached, the greater is the resisting force to a change of motion. An infinite force would be required to make an electron actually attain the velocity of light, so that, according to the present theory, it would be impossible for an electron to move faster than light, *i.e.* faster than an electromagnetic disturbance travels in the ether.

The importance of these deductions lies in the fact that an electric charge in motion, quite independently of any material nucleus, possesses an apparent mass in virtue of its motion, and that this mass is a function of the speed. For the positive ion, where the charge is associated with an actual atom of matter, the electrical mass due to its motion is, in general, small compared with the observed mass of the atom. In the case of the electron, however, we have seen that the whole mass is electrical in origin. This has led to the suggestion that the mass in general may be electrical in origin, and result from the motion of the charged particles composing the atom.

30. Action of a magnetic and electric field on a moving ion. Let us consider the case of an ion of mass m carrying a charge e and moving freely with a velocity u . If u is small compared with the velocity of light, the ion in motion corresponds to a current element of magnitude eu . If the ion moves in an external magnetic field of strength H , it is acted on by a force at right angles both to the direction of motion, and to that of the magnetic force and equal in magnitude to $Heu \sin \theta$, where θ is

the angle between the direction of the magnetic force and the direction of motion. Since the force due to the magnetic field is always perpendicular to the direction of motion, it has no effect upon the velocity of the particle, but can only alter the direction of its path.

If ρ is the radius of curvature of the path of the ion, the force along the normal is equal to $\frac{mu^2}{\rho}$, and this is balanced by the force $Heu \sin \theta$.

If $\theta = \frac{\pi}{2}$, *i.e.* if the ion is moving at right angles to the direction of the magnetic field $Heu = \frac{mu^2}{\rho}$ or $H\rho = \frac{m}{e} u$. Since u is constant, ρ is also constant, *i.e.* the particle describes a circular orbit of radius ρ . The radius of the circular orbit is thus directly proportional to u , and inversely proportional to H .

If the ion is moving at an angle θ with the direction of the magnetic field, it describes a curve which is compounded of a motion of a particle of velocity $u \sin \theta$ perpendicular to the field and $u \cos \theta$ in the direction of the field. The former describes a circular orbit of radius ρ , given by $H\rho = \frac{m}{e} u \sin \theta$; the latter is unaffected by the magnetic field and moves uniformly in the direction of the magnetic field with a velocity $u \cos \theta$. The motion of the particle is in consequence a helix, traced on a cylinder of radius $\rho = \frac{mu \sin \theta}{eH}$, whose axis is in the direction of the magnetic field. Thus an ion projected obliquely to the direction of a uniform magnetic field always moves in a helix whose axis is parallel to the lines of magnetic force*. If the magnetic field is perpendicular to the path of a pencil of rays, $\frac{mu}{e} = H\rho$. Consequently the value $\frac{mu}{e}$ for the ion is known when H and ρ are known. In many experimental cases, the radius of curvature

* A full account of the path described by a moving ion under various conditions is given by J. J. Thomson, *Conduction of Electricity in Gases* (Camb. Univ. Press, 1906), chapter IV.

ρ of the path of the ion is deduced from observations of the small deflection of a pencil of rays in a vacuum after passing through a uniform magnetic field.

Suppose, for example (Fig. 10 A), that the line PA represents the original direction of a pencil of positive ions moving at uniform speed. A constant magnetic field of strength H is applied over a length of the path $PC = a$, in a direction perpendicular to the plane of the paper. The ion describes the arc of a circle PD . After escaping from the magnetic field at D , the ion travels in a straight line which is a tangent to the path at D and strikes a screen or photographic plate at B which is perpendicular to the original path of the ions.

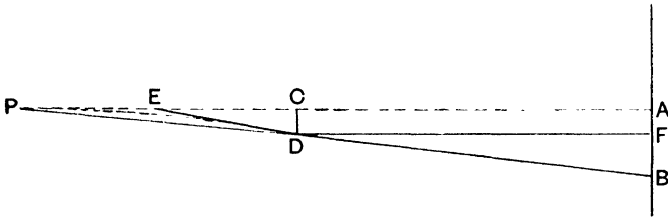

Fig. 10 A.

Draw DF parallel to PA . Let $AF = d_1$, $FB = d_2$, $AB = d$, $PC = a$, $CA = b$. If the deviation CD is small compared with the length PC , by a property of the circle $2\rho \cdot CD = PC^2$ where ρ is the radius. Consequently $d_1 = \frac{a^2}{2\rho}$; $d_2 = FB = b \tan \theta$, where θ is the angle between BD and PA . Since when the deflection is small, the tangent at D if produced bisects PC at E , $\tan \theta = \frac{2d_1}{a}$

and $d_2 = \frac{2bd_1}{a} = \frac{ab}{\rho}$. The total deviation

$$d = d_1 + d_2 = \frac{a}{\rho} \left(b + \frac{a}{2} \right).$$

Substituting this value of ρ ,

$$\frac{mu}{e} = H\rho = \frac{Ha \left(b + \frac{a}{2} \right)}{d}.$$

The ions are also deflected in their passage through an electric field. Suppose that a pencil of positive ions travels at constant

speed in the direction PA between two parallel plates L, M , distant l apart, of length a charged to a difference of potential V (Fig. 10 B). If the plate is charged positively the path of the ions is deviated in the direction PD . Since the value of the electric field $X = V/l$ is constant between the plates, the positive ions experience a constant acceleration $\alpha = Xe/m$ downwards in a direction perpendicular to the original direction of the pencil. The path described by the pencil of rays is evidently a parabola of which PA is a tangent at the vertex P . The particle after escaping from the electric field travels in a straight line DB which is a tangent to the parabola at D , and strikes the screen or photographic plate at B . The time t taken for the ions to traverse the

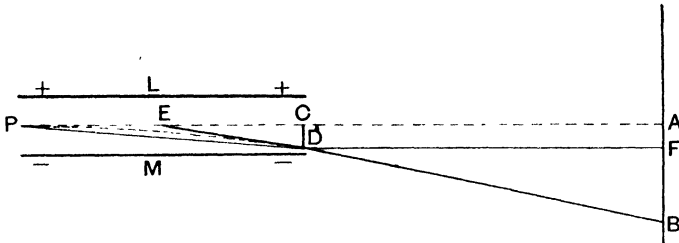

Fig. 10 B.

electric field is a/u and the space CD passed over in this time under the constant acceleration is given by $CD = \frac{1}{2} \frac{Xe}{m} \cdot \frac{a^2}{u^2}$. With the same notation as before the total deviation

$$d = AF + FB = d_1 \left(1 + \frac{2b}{a} \right).$$

Substituting the value of d_1

$$\frac{mu^2}{e} = \frac{Xa^2}{2d} \cdot \left(1 + \frac{2b}{a} \right).$$

From a combination of the deflections observed in a magnetic and in an electric field, both the velocity and value of e/m for the ions can be determined for $\frac{mu}{e} = A$ and $\frac{mu^2}{e} = B$, where A and B are quantities which can be measured.

31. Determination of e/m for the cathode stream. The cathode rays, first observed by Varley, were investigated in detail by Crookes and Hittorf. These rays are projected from the cathode in a vacuum tube at low pressure. They travel in straight lines, and are readily deflected by a magnet, and produce strong luminosity in a variety of substances placed in their path. The rays are deflected by a magnetic field in the same direction as would be expected for a negatively charged particle projected from the cathode. In order to explain the peculiar properties of these rays Crookes supposed that they consisted of negatively electrified particles, moving with great velocity and constituting, as he appropriately termed it, "a new or fourth state of matter." The nature of these rays was for twenty years a subject of much controversy, for while some upheld their material character, others considered that they were a special form of wave motion in the ether.

Perrin and J. J. Thomson showed that the rays always carried with them a negative charge, while Lenard made the important discovery that the rays passed through thin metal foil and other substances opaque to ordinary light. Using this property, he sent the rays through a thin window and examined the properties of the rays outside the vacuum tube in which they were produced.

The absorption of the rays by matter was shown to be nearly proportional to the density of matter over a very wide range, and to be independent of its chemical constitution.

The nature of these rays was successfully demonstrated by J. J. Thomson* in 1897. If the rays consisted of negatively electrified particles, they should be deflected in their passage through an electric as well as through a magnetic field. Such an experiment had been tried by Hertz, but with negative results. J. J. Thomson, however, found that the rays were deflected by an electric field in the direction to be expected for a negatively charged particle, and showed that the failure of Hertz to detect the same was due to the masking of the electric field by the strong ionisation produced in the gas by the cathode stream. This effect was got rid of by reducing the pressure of the gas in the tube.

* J. J. Thomson, *Phil. Mag.* **44**, p. 293, 1897.

The experimental arrangement used for the electric deflection of the rays is shown in Fig. 11.

The cathode rays are generated at the cathode *C*, and a narrow pencil of rays is obtained by passing the rays through a perforated disc *AB*. The rays then passed midway between two parallel insulated plates *D* and *E*, *d* centimetres apart, and maintained at a constant difference of potential *V*. The point of incidence of the pencil of rays was marked by a luminous patch produced on a phosphorescent screen placed at *PP'*.

The particle carrying a negative charge *e* in passing between the charged plates, is acted on by a force Xe directed towards the positive plate, where *X*, the strength of the electric field, is given by $\frac{V}{d}$.

The application of the electric field thus causes the luminous patch to move in the direction of the positive plate. If now

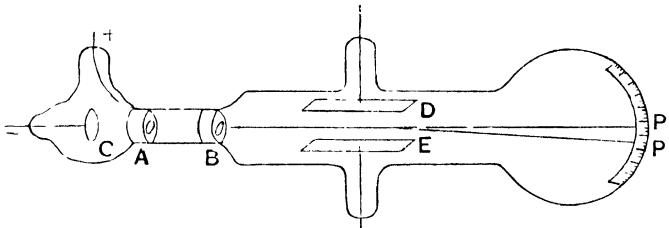

Fig. 11.

a uniform magnetic field is applied between the plates *D* and *E*, perpendicular to the pencil of rays, and parallel to the plane of the plates, and in such a direction that the electric and magnetic forces are opposed to one another, the patch of light can be brought back to its undisturbed position by adjusting the strength of the magnetic field. If *H* is the strength of the magnetic field, the force on the particle due to the magnetic field is Heu , and when a balance is obtained

$$Heu = Xe,$$

or

$$u = \frac{X}{H} \dots\dots\dots(1).$$

Now if the magnetic field H is acting alone, the curvature ρ of the path of the rays between the plates can be deduced from the deflection of the luminous patch. But we have seen that

$$H\rho = \frac{mu}{e} \dots\dots\dots(2).$$

From equations (1) and (2), the value of u and e/m for the particle can be determined.

The velocity u is not constant, but depends upon the potential difference between the electrodes, and this in turn depends upon the pressure and nature of the residual gas in the tube.

By altering these factors, the cathode particles may be made to acquire velocities varying between about 10^9 and 10^{10} cms. per second. This velocity is enormous compared with that which can be impressed ordinarily upon matter by mechanical means.

As a result of a series of experiments the mean value $\frac{e}{m} = 7.7 \times 10^6$ was obtained. The value of e/m is independent of the nature or pressure of the gas in the vacuum tube and independent of the metal used as cathode. A similar value of e/m was obtained by Lenard* and others.

Schuster†, Kaufmann‡ and Simon§ used a different method to determine the value of e/m . The potential difference V between the terminals of the tube was measured. The work done on the charged particle in moving from one end of the tube to the other is Ve , and this must be equal to the kinetic energy $\frac{1}{2}mu^2$ acquired by the moving particle. Thus

$$\frac{e}{m} = \frac{u^2}{2V} \dots\dots\dots(3).$$

By combination of this equation with (2) obtained by measurement of the magnetic deflection, both u and e/m can be determined.

* Lenard, *Annal. d. Phys.* **64**, p. 279, 1898.

† Schuster, *Proc. Roy. Soc.* **37**, p. 317, 1884; **47**, p. 526, 1890.

‡ Kaufmann, *Annal. d. Phys.* **61**, p. 544; **62**, p. 596, 1897; **65**, p. 431, 1898.

§ Simon, *Annal. d. Phys.* **69**, p. 589, 1899.

Simon found by this method that

$$\frac{e}{m} = 1.865 \times 10^7.$$

It will be seen later (section 81) that a similar value was deduced by Kaufmann for the electrons projected from radium, while Bucherer later found a value 1.70×10^7 .

These results, which have been based on the effect of a magnetic and electric field on a moving ion, were confirmed by Wiechert*, who determined by a direct method the time required for the particle to traverse a known distance.

The particles which make up the cathode stream were termed "corpuscles" by J. J. Thomson. The name "electron," first employed by Johnstone Stoney, has also been applied to them and has come into general use†.

The methods above described do not give the mass of the electron, but only the ratio of the charge to the mass. A direct comparison can, however, be made between the ratio e/m for the electron and the corresponding value for the hydrogen atoms set free in the electrolysis of water. Each of the hydrogen atoms is supposed to carry a charge e , and it is known that 96,470 coulombs of electricity, or 9647 electromagnetic units of quantity, are required to liberate one gram of hydrogen. If N is the number of atoms in one gram of hydrogen, then $Ne = 9647$. But if m is the mass of a hydrogen atom, then $Nm = 1$. Dividing one by the other $\frac{e}{m} = 9647$. We have seen already that a gaseous ion carries the same charge as a hydrogen atom, while indirect evidence shows that the electron carries the same charge as an ion, and consequently the same charge as the atom of hydrogen. Hence we may conclude that the apparent mass of the electron is only about $\frac{1}{1700}$ of the mass of the hydrogen atom. The electron thus behaves as the smallest body known to science.

In later experiments J. J. Thomson showed that the negative

* Wiechert, *Ann. d. Phys.* **69**, p. 739, 1899.

† A complete discussion of the various methods employed to measure the velocity and mass of electrons and also of the theory on which they are based will be found in J. J. Thomson's *Conduction of Electricity through Gases*.

ions set free at low pressures by an incandescent carbon filament, and also the negative ions liberated from a zinc plate exposed to the action of ultra-violet light, gave the same value for e/m as the electrons produced in a vacuum tube. It thus seemed probable that the electron was a constituent of all matter. This view received strong support from measurements of quite a different character. Zeeman in 1897 found that the lines of the spectrum from a source of light exposed in a strong magnetic field were displaced and doubled. Later work has shown that the lines in some cases are trebled, in others sextupled, while, in a few cases, the multiplication is still greater. These results received a general explanation on the radiation theories previously advanced by Lorentz and Larmor. The radiation, emitted from any source, was supposed to result from the orbital or oscillatory motion of the charged parts constituting the atom. Since a moving ion is acted on by an external magnetic field, the motion of the charged ions is disturbed when the source of light is exposed between the poles of a strong magnet. There results a small change in the period of the emitted light, and a bright line in the spectrum is, in consequence, displaced by the action of the magnetic field. According to theory, the small change in the wave-length of the emitted light depends upon the strength of the magnetic field and on the ratio e/m of the charge carried by the ion to its mass. By comparison of the theory with the experimental results, it was deduced that the moving ion carried a negative charge and that the value of e/m was about 10^7 . The charged ion, responsible for the radiation from a luminous body, is thus identical with the electron set free in a vacuum tube.

It thus seems reasonable to suppose that the atoms of all bodies are complex and are built up, in part at least, of electrons, whose apparent mass is very small compared with that of the hydrogen atom. The properties of such disembodied charges has been examined mathematically among others by Larmor, who sees in this conception the ultimate basis of a theory of matter. J. J. Thomson and Lord Kelvin have investigated mathematically certain arrangements of a number of electrons which are stable for small disturbances. This question will be discussed more in detail later.

32. Canal rays. If a discharge is passed through a vacuum tube provided with a perforated cathode, within certain limits of pressure, luminous streams are observed to pass through the holes and to emerge on the side of the cathode remote from the anode. These rays were first observed by Goldstein* and were called by him the "Canal-strahlen." These rays travel in straight lines and produce phosphorescence in various substances.

Wien† showed that the canal rays were deflected by strong magnetic and electric fields, but the amount of deflection was very small compared with that of the cathode rays under similar conditions. The deflection was found to be opposite in direction to the cathode rays, indicating that the canal rays consist of positive ions. Wien determined their velocity and the ratio e/m , by measuring the amount of their magnetic and electric deflection. The value of e/m was found to be variable, depending upon the gas in the tube, but the maximum value observed was about 10^4 . This shows that the positive ion, in no case, has a mass less than that of the hydrogen atom. It seems probable that the canal rays consist of positive ions, derived either from the gas or the electrodes, which travel towards the cathode, and have sufficient velocity to pass through the holes of the cathode and to appear in the gas beyond.

A large amount of experimental work has been done in recent years to determine the nature of the positively charged particles of the canal rays, and the anode rays which originate near the anode of a discharged tube. The particles in the canal rays consist of positively charged ions moving with widely different velocities. The value of e/m for the particles has been determined directly by Sir J. J. Thomson‡ by passing a narrow pencil of the rays through an electric and magnetic field at right angles to each other, and measuring the deflection of the traces of the pencil of rays obtained on a photographic plate. The mass and velocity of the charged ions depend upon the nature of gas in the tube. In

* Goldstein, *Berlin Sitz.* **39**, p. 691, 1886; *Ann. d. Phys.* **64**, p. 45, 1898.

† Wien, *Ann. d. Phys.* **65**, p. 440, 1898.

‡ J. J. Thomson, *Phil. Mag.* **20**, p. 752, 1910; **21**, p. 225, 1911.

some cases the ions carry a positive charge and others a negative charge, and the charge carried by an ion may be several multiples of the fundamental charge. In complex gases and vapours, the canal rays consist of a number of carriers of different atomic weight and carrying various multiples of the unit charge.

Such results are of great importance in showing that the atoms of matter may carry different charges, and afford a very sensitive method of analysis of the gases contained in the discharge tube.

It is remarkable that, so far, no case has been observed where the carrier of a positive charge has an apparent mass less than that of the hydrogen atom. Positive electricity always appears to be associated with the atoms of matter. We have seen that the process of ionisation in gases is supposed to consist of the expulsion of an electron from the atom. The corresponding positive charge remains behind on the atom and travels with it. This difference between positive and negative electricity appears to be fundamental, and no explanation of it has, as yet, been forthcoming.

33. Radiation of energy. If an electron moves uniformly in a straight line with constant velocity, the magnetic field, which travels with it, remains constant, and there is no loss of energy from it by radiation. If, however, its motion is hastened or retarded, the magnetic field is altered, and there results a loss of energy from the electron in the form of electromagnetic radiation. The rate of loss of energy from an accelerated electron was first calculated by Larmor* and shown to be $\frac{2e^2}{3V} \times (\text{acceleration})^2$, where e is the charge on the electron in electromagnetic units, and V the velocity of light.

Any alteration in the velocity of a moving charge is thus always accompanied by a radiation of energy from it. Since the electron, set free in a vacuum tube, increases in velocity in passing through the electric field, energy must be radiated from it during its passage from cathode to anode. It can, however, readily be calculated that, in ordinary cases, this loss of energy is small

* Larmor, *Phil. Mag.* **44**, p. 593, 1897.

compared with the kinetic energy acquired by the electron in passing through the electric field.

An electron moving in a circular orbit is a powerful radiator of energy, since it is constantly accelerated towards the centre. An electron moving in an orbit of radius equal to the radius of an atom (about 10^{-8} cms.) would lose most of its kinetic energy of motion in a small fraction of a second, even though its velocity was originally nearly equal to the velocity of light. If, however, a number of electrons are arranged at equal angular intervals on the circumference of a circle and move with constant velocity round the ring, the radiation of energy is much less than for a single electron, and rapidly diminishes with an increase in the number of electrons round the ring. This result, obtained by J. J. Thomson, will be discussed in more detail later when the stability of systems composed of rotating electrons is under consideration.

Since the radiation of energy is proportional to the square of the acceleration, the proportion of the total energy radiated depends upon the suddenness with which an electron is started or stopped. Now some of the cathode ray particles are stopped abruptly when they impinge on the metal cathode, and, in consequence, give up a fraction of their kinetic energy in the form of electromagnetic radiation. Schuster, Stokes and Weichert suggested that this radiation constituted the X rays, which are known to have their origin at the surface on which the cathode rays impinge. The mathematical theory has been worked out by J. J. Thomson*. If the motion of an electron is suddenly arrested, a thin spherical pulse in which the magnetic and electric forces are very intense travels out from the point of impact with the velocity of light. The more suddenly the electron is stopped, the thinner and more intense is the pulse. On this view the X rays are not corpuscular like the cathode rays, which produce them, but consist of transverse disturbances in the ether, akin in some respects to light waves of short wave-length. The rays are made up of a number of pulses, which are non-periodic in character, and which follow one another at irregular intervals.

On this theory of the nature of the X rays, the absence of

* J. J. Thomson, *Phil. Mag.* **46**, p. 172, 1898.

direct deflection, refraction, or polarisation is to be expected, if the thickness of the pulse is small compared with the diameter of an atom. It also explains the non-deflection of the path of the rays by a magnetic or electric field. The intensity of the electric and magnetic force in the pulse is so great that it is able to cause a removal of an electron from some of the atoms of the gas, over which the pulse passes, and thus causes the ionisation observed.

A detailed examination of the effects produced when X rays pass through matter have brought up certain difficulties in the pulse theory. For example, it is found that when X rays pass through matter high speed electrons are liberated, and that the speed of the electron depends upon the penetrating power of the radiation but is independent of the intensity of the radiation. The speed of the electron is apparently the same for all distances from the discharge tube, although the intensity of the magnetic and electric forces in the pulse must become weaker with distance from the origin. In addition, if the energy of the electron is derived from the pulse, the atom must have the property of abstracting the energy from an area of the wave-front very large compared with atomic dimensions. In order to account for this difficulty, Sir J. J. Thomson has suggested that the energy of the pulse is concentrated in definite directions, and is not uniform over the sphere. He has also suggested that the atom may have the property of storing up energy from a succession of pulses passing over it and ultimately restoring it in the form of a high speed electron. From a comparison of the ionisation effects produced by the rays from a radio-active substance and by X rays, Bragg* suggested that the X rays are corpuscular in character, consisting of neutral doublets travelling with great velocity. Some of these doublets are broken up in their passage through the atoms of matter, and give rise to the appearance of a high speed electron. On this view, the energy of the electron is derived from the doublet and not from the atom itself. This hypothesis has served to explain in a simple way some of the effects observed; for example, it has been shown that when X rays fall upon matter the electrons are emitted more freely on the side of emergence than on the side

* Bragg, *Phil. Mag.* **14**, p. 429, 1907; **15**, p. 663, 1908; **16**, p. 918, 1908; **20**, p. 385, 1910.

of incidence. This is to be expected on the hypothesis of Bragg, although it is not inconsistent with the pulse theory, since the momentum of the pulse as well as of the doublet is in the direction of motion of the wave-front. If the pulses are regarded as bundles of concentrated energy which spread little from the source, the two theories are in main essentials identical, and it would be difficult to distinguish between them by experimental method. Whatever may be the ultimate explanation of the nature of X rays, both theories have served a very useful purpose in directing attention to the more salient facts observed when X rays pass through matter.

Barkla* has made a systematic examination of the effects produced when X rays pass through gaseous and solid matter. He has found that the incidence of rays on matter sets up a secondary radiation in all directions, which has about the same penetrating power as the primary rays. There seems to be no doubt that this is to be ascribed to a scattering of the X rays without appreciable change of type. He has also brought to light some very surprising effects which are of great theoretical importance. In addition to the scattered radiation already mentioned, each element has been shown under certain conditions to emit equally in all directions one or more characteristic types of radiation. These rays are of the same type as the primary X rays, and are apparently homogeneous and absorbed according to an exponential law by matter. This characteristic radiation suddenly appears when the primary rays are of slightly greater penetrating power than the characteristic radiation. This type of radiation has been termed by Barkla the characteristic or fluorescent radiation, on account of its analogy in optics. In a series of researches, Barkla has brought out the essential properties of these characteristic radiations, and the peculiar variations in their absorption by elements of different atomic weight.

A detailed investigation has been made by Whiddington† on the conditions attending the production of X rays by the cathode rays in a vacuum tube. He has determined the connection between the speed of the cathode particles and the penetrating power of

* Barkla, *Phil. Mag.* **17**, p. 739, 1909 ; **21**, p. 270, 1911.

† Whiddington, *Proc. Roy. Soc. A*, **85**, pp. 99, 323, 1911.

the radiation produced in different metals and the velocity of the cathode rays necessary to excite the characteristic radiation in a number of metals.

The properties of X rays have been discussed briefly at this stage because of their importance in considering the nature and origin of the γ rays emitted by radio-active substances.

In this chapter an account of the ionisation theory of gases has been given to the extent that is necessary for the interpretation of the measurements of radio-activity by the electric method. It would be out of place here to discuss the development of that theory in detail, to explain the passage of electricity through flames and vapours, the discharge of electricity from hot bodies, and the very complicated phenomena observed in the passage of electricity through a vacuum tube.

For further information on this important subject, the reader is referred to J. J. Thomson's *Conduction of Electricity through Gases*, in which the whole subject is treated in a full and complete manner. A simple account of the effect of moving charges and the electronic theory of matter was given by the same author in the Silliman Lectures of Yale University and published under the title *Electricity and Matter* (Scribner, New York, 1904).

CHAPTER III.

METHODS OF MEASUREMENT.

34. Methods of Measurement. Three general methods have been employed for examination of the radiations from radio-active bodies, depending on

- (1) The action of the rays on a photographic plate.
- (2) The ionising action of the rays on the surrounding gas.
- (3) The luminosity produced by the rays on a screen of platinocyanide of barium, zinc sulphide, or similar substance.

The photographic method has been used very widely, especially in the earlier development of the subject, but has gradually been displaced by the electrical method, as a quantitative determination of the radiations became more and more necessary. In certain directions, however, it possesses distinct advantages over the electrical method. For example, it has proved a very valuable means of investigating the curvature of the path of the rays, when deflected by a magnetic or electric field, and has allowed us to determine the constants of these rays with considerable accuracy.

On the other hand, as a general method of study of the radiations, it is open to many objections. A day's exposure is generally required to produce an appreciable darkening of the sensitive film when exposed to a weak source of radiation like uranium and thorium. It cannot, in consequence, be employed to investigate the radiations of those active products which rapidly lose their activity. Moreover, it is shown that the darkening of a photographic plate can be produced by many agents which do not give out rays like those of the radio-active bodies. This darkening of the plate is produced under the most

varied conditions, and very special precautions are necessary when long exposures to a weak source of radiation are required.

The chief drawback of the photographic method lies in the difficulty of deducing the intensity of the radiation from measurements of the density of the photographic impression. In addition, the relative photographic effect of the different types of radiation is dependent on the thickness and rapidity of the films and plates employed. In some cases, for example, using thick layers of uranium oxide, the photographic effect is largely due to β rays. In most cases, however, where thin films of radio-active matter are used, the photographic effect in a vacuum or close to the active film is mainly due to the α rays. A detailed study of the photographic effects due to the α rays has been made by Kinoshita, and some of his conclusions will be discussed later (section 110).

The electrical method, on the other hand, offers a rapid and accurate method of quantitatively examining the radiations. It can be used as a means of measurement of all the types of radiation emitted, excluding light waves, and is capable of accurate measurement over an extremely wide range. With proper precautions it can be used to measure effects produced by radiations of extremely small intensity.

The luminosity produced by the α , β and γ rays in barium platinocyanide and willemite is only of service in qualitative work. On the other hand, the luminosity in the form of scintillations produced in zinc sulphide by the α rays has proved invaluable in quantitative work. It has afforded a direct method of counting the number of α particles and has been widely employed in researches upon the α rays.

35. Electrical Methods. The electrical methods employed in studying radio-activity are all based on the property of the radiation in question of ionising the gas, *i.e.* of producing positively and negatively charged carriers throughout the volume of the gas. The discussion of the application of the ionisation theory of gases to measurements of radio-activity has been given in the last chapter. It has been shown there that the essential condition to be fulfilled for comparative measurements of the intensity of the radiations

is that the electrical field shall in all cases be strong enough to obtain the maximum or saturation current through the gas. The difficulty of obtaining complete saturation when the ionisation is due to α rays has been discussed in section 14. It has, however, been pointed out that approximate comparative measurements of α ray activities can be made even though saturation is far from complete.

The electric field required to produce practical saturation varies with the intensity of the ionisation and consequently with the activity of the preparations to be examined. For preparations which have an activity not more than 500 times that of uranium, under ordinary conditions, a field of 100 volts per cm. is sufficient to produce a practical saturation current. For very active samples of radium, it is often impossible to obtain conveniently a high enough electromotive force to give even approximate saturation. Under such conditions comparative measurement can be made by measuring the current under diminished pressure of the gas, when saturation is more readily obtained.

The method to be employed in the measurement of the ionisation current depends largely on the intensity of the current to be measured. If some very active radium is spread on the lower of two insulated plates as in Fig. 1, and a saturating electric field applied, the current may readily be measured by a sensitive galvanometer of high resistance. For example, a weight of .45 gr. of impure radium chloride of activity 1000 times that of uranium oxide, spread over a plate of area 33 sq. cms., gave a maximum current of 1.1×10^{-8} amperes when the plates were 4.5 cms. apart. In this case the difference of potential to be applied to produce even approximate saturation was about 600 volts. Since most of the ionisation is due to rays which are absorbed in passing through a few centimetres of air, the current is not much increased by widening the distance between the two plates. In cases where the current is not quite large enough to give a convenient deflection, the current may be determined by connecting the upper insulated plate with a well insulated condenser. After charging for a definite time, say one or more minutes, the condenser is discharged through the galvanometer, and the current can readily be deduced.

In most cases, however, when dealing with less active substances like uranium or thorium, or with small amounts of active material, it is necessary to employ methods for measuring much smaller currents than can be detected conveniently by an ordinary galvanometer. The most convenient apparatus to employ for this purpose is one of the numerous types of quadrant electrometer or an electroscope of special design. For many observations, especially where the activity of the two substances is to be compared under constant conditions, an electroscope offers a very certain and simple method of measurement. As an example of a simple apparatus of this kind, a brief description will be given of an electroscope which the writer has found useful for accurate work.

The general arrangement is clearly seen in Fig. 12. The active matter is placed on the plate *D*. The upper plate *C* is rigidly connected with the gold-leaf system *CG*, and is insulated and supported by the sulphur stopper *S*. The system is charged through the projecting rod to a suitable potential to give a deflection of about 40° to the gold-leaf *G*. When the system is charged a cap *T* is placed over the projecting rod. One of the sides of the lower vessel *A* opens on a hinge, and the lower plate *D*, mounted on a slide, can then be moved out to place the active matter in position. The lower plate *D* and the external case are connected with earth. The movement of the gold-leaf is observed through suitable windows by means of a tele-microscope (magnification about 10), provided with a clearly marked scale in the eyepiece. In practice, the time taken for the gold-leaf to pass between two fixed points on the scale is observed by a stop-watch. It is then convenient to express the

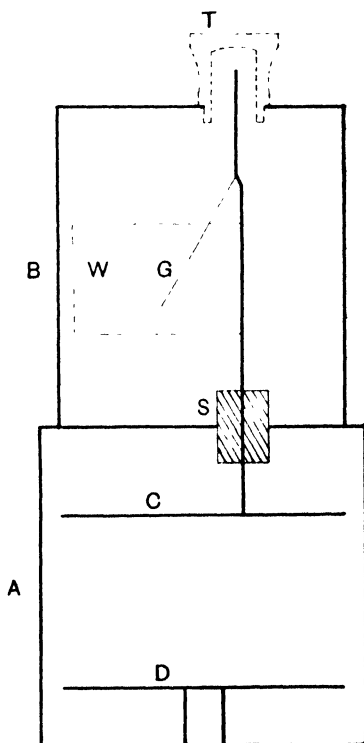

Fig. 12.

rate of discharge in terms of the average number of divisions passed over per minute by the gold-leaf. By suitable adjustments for the length of leaf and its distance from the outer case, it is not difficult to arrange that the gold-leaf moves nearly uniformly over the greater part of the scale for a constant rate of discharge. Since the capacity of the charged system is nearly constant, the average rate of movement of the gold-leaf is directly proportional to the ionisation current between D and C , *i.e.* to the intensity of the radiation emitted by the active substance. In an electroscope of the type described, the natural leak of the apparatus, when all radio-active material is removed, is usually small. It should, however, in all cases be determined.

Suppose it is required to compare the relative activity of two active preparations, *e.g.* the activity of a mineral with uranium oxide to be taken as a standard. An equal weight (about 1 gram) of the mineral and uranium oxide in a powdered form are taken and spread uniformly on two shallow metal vessels about 3 cms. in diameter. Suppose d_1 is the average number of scale divisions passed over per minute by the gold-leaf when the plate of uranium oxide is in position, and d_2 the corresponding number for the mineral. Then if d divisions per minute is the natural leak of the electroscope, the activity of the mineral is proportional to $d_2 - d$ and the uranium oxide to $d_1 - d$. Consequently we may say the activity of the mineral compared with uranium oxide is given by $\frac{d_2 - d}{d_1 - d}$.

It is found by experience that if the plates C and D are not more than 4 cms. apart, and the system is charged to about 300 volts, approximate saturation is obtained, provided the ionisation is not so intense as to cause a rapid movement of the gold-leaf.

Such an α ray electroscope is very convenient for comparison of activity measured by the α rays, and for determining the decay of active products which emit α rays. It is desirable to measure the activities due to β and γ rays in a different type of electroscope.

A modified form of the gold-leaf electroscope can be used to determine extraordinarily minute currents with accuracy, and can be employed in cases where a sensitive electrometer is

unable to detect the current. A special type of electroscopes has been used by Elster and Geitel, in their experiments on the natural ionisation of the atmosphere.

A very convenient type of electroscopes to measure the current due to minute ionisation of the gas is shown in Fig. 13.

This type of instrument was first used by C. T. R. Wilson* in his experiments of the natural ionisation of air in closed vessels. A brass cylindrical vessel is taken of about 1 litre capacity. The gold-leaf system, consisting of a narrow strip of gold-leaf L attached to a flat rod R , is insulated inside the vessel by the small sulphur bead or piece of amber S , supported from the rod P . In a dry atmosphere a clean sulphur bead or piece of amber is almost a perfect insulator.

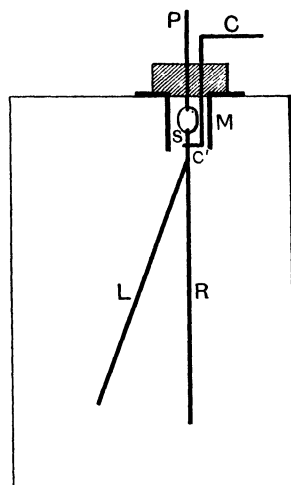

Fig. 13.

The system is charged by a light bent rod CC' passing through an ebonite cork. If the apparatus is required to be air-tight, the gold-leaf system can be charged by means of a piece of magnetized steel wire, which is made to touch the rod R by the approach of a magnet. The rod C is connected to one terminal of a battery of small accumulators of 200 to 300 volts. If these are not available, the system can be charged by means of a rod of sealing-wax. The charging rod CC' is then removed from contact with the gold-leaf system. The rods P and C and the cylinder are then connected with earth.

The rate of movement of the gold-leaf is observed by a reading microscope through two holes in the cylinder, covered with thin mica or glass. In cases where the natural ionisation due to the enclosed air in the cylinder is to be measured accurately, it is advisable to enclose the supporting and charging rod and sulphur bead inside a small metal cylinder M connected to earth, so that only the charged gold-leaf system is exposed in the main volume of the air.

In an apparatus of this kind, the small leakage over the sulphur

* Wilson, *Proc. Roy. Soc.* 68, p. 152, 1901.

bead can be eliminated almost completely by keeping the rod P charged to the average potential of the gold-leaf system during the observation. This method has been used with great success by C. T. R. Wilson (*loc. cit.*). Such refinements, however, are generally unnecessary, except in investigations of the natural ionisation of gases at low pressures, when the conduction leak over the sulphur bead is comparable with the discharge due to the ionised gas.

36. Ionisation Current. The electric capacity C of a gold-leaf system about 4 cms. long is usually about 2 electrostatic units. If V is the decrease of potential of the gold-leaf system in t seconds, the current i through the gas is given by

$$i = \frac{CV}{t}.$$

With a well cleaned brass electroscope of volume 1 litre, the fall of potential due to the natural ionisation of the air was found to be about 6 volts per hour. Since the capacity of the gold-leaf system was about 1 electrostatic unit

$$i = \frac{1 \times 6}{3600 \times 300} = 5.6 \times 10^{-6} \text{ e.s. units} = 1.9 \times 10^{-15} \text{ amperes.}$$

With special precautions a rate of discharge of 1/10 or even 1/100 of this amount can be measured accurately.

The number of ions produced in the gas can be calculated if the charge of an ion is known.

Let q = number of ions produced per second per cubic centimetre throughout the volume of the electroscope,

S = volume of electroscope in cubic centimetres.

If the ionisation be uniform, the saturation current i is given by $i = qSe$.

Now for an electroscope with a volume of 1000 c.c., i was equal to about 1.9×10^{-15} amperes. Taking the charge carried by an ion as 4.65×10^{-10} electrostatic units or 1.55×10^{-19} coulombs, this current corresponds to a production q of 12 ions per c.c. per second.

With suitable precautions an electroscope can thus readily measure an ionisation current corresponding to the production of one ion per cubic centimetre per second.

The great advantage of an apparatus of this kind lies in the fact that the current measured is due to the ionisation inside the vessel and is not influenced by the ionisation of the external air or by electrostatic disturbances.

For accurate measurements with electroscopes generally it is desirable that the sulphur or amber insulator should be made as small as possible in order to reduce to a minimum the absorption of electric charge. With large insulators it is observed that the apparent natural leak is much greater when the apparatus is first charged than an hour or so later. It appears to take some time for the absorption to reach a constant value. For this reason it is desirable to charge the electroscope some time before measurements are begun, or still better to keep the gold-leaf system permanently charged by means of accumulators. It is important that the illumination required to see the scale clearly should be as small as possible. If a strong source of illumination is employed, the electroscope is heated, and the air convection currents set up often cause irregular and marked disturbances of the gold-leaf. It is convenient to use a small electric lamp, which is only switched on for the short time required to take a reading. It is desirable that the gold-leaf should have a straight edge on which the microscope can be accurately focussed. For this purpose, H. W. Schmidt has suggested the use of a fine quartz fibre which is attached to a small segment cut out of the leaf. C. E. S. Phillips has employed a fine fibre of the conducting glass made by him in place of the gold-leaf. For flexibility, this fibre is attached to the insulated support by a short length of gold-leaf. By this method the microscope can be focussed very accurately on the fibre.

37. β and γ ray electroscopes. A modification of the type of electroscope shown in Fig. 13 affords a very convenient apparatus for the comparison of the β and γ ray activities of radioactive substances. For use as a β ray electroscope, a circular opening is cut in the base, and this is covered by a thin sheet of aluminium of just sufficient thickness to absorb the α rays. The material whose β ray activity is to be measured is placed under the electroscope. For this purpose the electroscope is supported above the table on a stand. For comparison of γ ray activities, it

is advisable that the electroscope should be made of sheet lead 2 or 3 mms. thick so that no radiation can enter the vessel without passing through this thickness of lead. The material to be tested is placed to one side of or below the electroscope at such a distance as to give a suitable rate of leak. The β rays are completely absorbed by the lead walls of the electroscope, and the ionisation inside the electroscope is due entirely to the γ rays. For use with γ rays it is desirable that the windows should be covered with thick glass, and protected from stray radiation by projecting lead screens. It should be noted that saturation is far more readily obtained for the ionisation due to the β and γ rays than for the α rays.

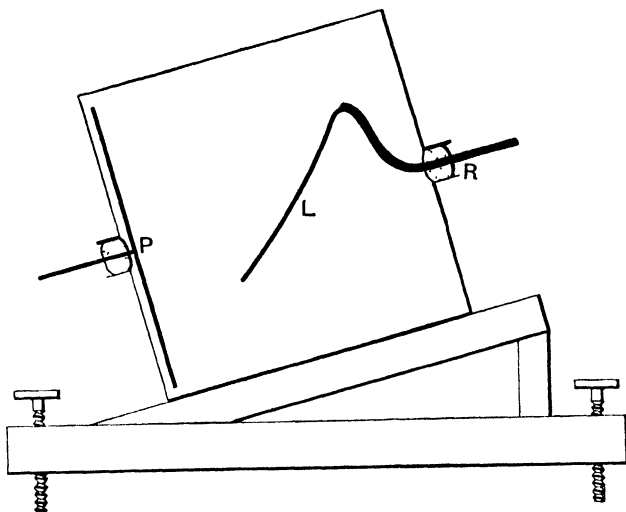

Fig. 14.

38. Tilted Electroscope. A modified form of electroscope which has proved very useful in place of an electrometer for measuring minute currents was devised by C. T. R. Wilson*. The construction of the apparatus is shown in Fig. 14.

The case consists of a rectangular brass box 4 cms. \times 4 cms. \times 3 cms. A narrow gold-leaf *L* is attached to a rod *R* passing through a clean sulphur cork. Opposite the gold-leaf is fixed an insulated brass plate *P*, placed about 1 mm. from the wall of the box. The movement of the gold-leaf is observed through two

* C. T. R. Wilson, *Proc. Camb. Phil. Soc.* **12**, p. 135, 1903. See also Kaye, *Proc. Phys. Soc.* **23**, p. 209, 1911.

small windows by means of a microscope provided with a micrometer scale. The plate P is maintained at a constant potential (generally about 200 volts). The electroscope case is placed in an inclined position as shown in the figure, the angle of inclination and the potential of the plate being adjusted to give the desired sensitiveness. The gold-leaf is initially connected to the case, and the microscope adjusted so that the gold-leaf is seen in the centre of the scale. For a given potential of the plate, the sensitiveness depends on the angle of tilt of the case. There is a certain critical inclination below which the gold-leaf is unstable. The most sensitive position lies just below the critical angle. In a particular experiment Wilson found that with an angle of tilt of 30° and with the plate at a constant potential of 207 volts, the gold-leaf, when raised to a potential of one volt above the case, moved over 200 scale divisions of the eyepiece, 54 divisions corresponding to one millimetre.

In use, the rod R is connected with the external insulated system whose rise or fall of potential is to be measured. On account of the small capacity of the system and the large movement of the gold-leaf for a small difference of potential, the electroscope is able to measure very minute currents. The apparatus is portable. If the plate P be connected to one pole of a dry pile the gold-leaf is stretched out towards the plate, and in this position can be carried without risk of injury.

39. A variety of forms of electroscope differing in details of construction have been used for radio-active measurement. Wulf* in place of a gold-leaf used a doubled quartz fibre silvered to make it conducting. This is strung on an insulating support and the lower ends are connected together to a bow of quartz. On charging the system, the quartz fibres diverge and their movement is observed by a microscope. The deflection is nearly proportional to the voltage between about 40 and 240 volts. This form of apparatus is very convenient for measuring ionisation currents at sea, for the deflection of the fibres is not much altered by the motion of the ship†.

* Wulf, *Phys. Zeit.* 8, pp. 246, 537, 780, 1907; 9, p. 1090, 1910.

† See Simpson and Wright, *Proc. Roy. Soc. A*, 85, p. 175, 1911.

40. Electrometers. Although the electroscope can be used with advantage in special cases, it is limited in its application. The most generally convenient apparatus for measurement of ionisation currents through gases is one of the numerous types of quadrant electrometer. With the help of auxiliary capacities, the electrometer can be used to measure currents with accuracy over a wide range, and can be employed for practically every kind of measurement required in radio-activity.

The elementary theory of the symmetrical quadrant electrometer as given in the text-books is very imperfect. It is deduced that the sensibility of the electrometer—measured by the deflection of the needle for 1 volt P.D. between the quadrants—varies directly as the potential of the charged needle, provided that this potential is high compared with the P.D. between the quadrants. In most electrometers however, the sensibility rises to a maximum, and then decreases with increase of potential of the needle. For electrometers in which the needle lies close to the quadrants, this maximum sensibility is obtained for a comparatively low potential of the needle. This variation in sensibility of an electrometer was first observed by Hopkinson in 1885 and has been the subject of considerable discussion. A simple physical explanation of the effect and of the correct formula has been recently given by R. Beattie*. The effect is due to the presence of the air space that necessarily exists between adjoining quadrants.

Suppose that it is required to measure with an electrometer the ionisation current between two horizontal metal plates *A* and *B* (Fig. 15) on the lower of which some active material has been spread. If the saturation current is required, the insulated plate *A* is connected with one pole of a battery of sufficient E.M.F. to produce saturation, the other pole being connected to earth. The insulated

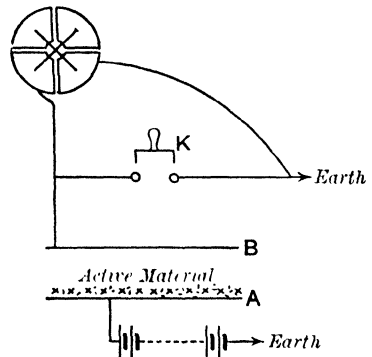

Fig. 15.

* Beattie, *Electrician*, Aug. 12, 1910.

plate *B* is connected with one pair of quadrants of the electrometer, the other pair being earthed. By means of a suitable key *K*, the plate *B* and the pair of quadrants connected with it may be either insulated or connected with earth. When a measurement is to be taken, the earth connection is broken. If the positive pole of the battery is connected with *A*, the plate *B* and the electrometer connections immediately begin to be charged positively, and the potential, if allowed, will steadily rise until it is very nearly equal to the potential of *A*. As soon as the potential of the electrometer system begins to rise, the electrometer needle commences to move at a uniform rate. Observations of the angular movement of the needle are made either by the telescope and scale or by the movement of the spot of light on a scale in the usual way. If the needle is damped so as to give a uniform motion over the scale, the rate of movement of the needle, *i.e.* the number of divisions of the scale passed over per second, may be taken as a measure of the current through the gas. The rate of movement is most simply obtained by observing with a stop-watch the time taken for the spot of light, after the motion has become steady, to pass over 100 divisions of the scale. As soon as the observation is made, the plate *B* is again connected with earth, and the electrometer needle returns to its original position.

41. A very useful electrometer of great sensibility which has come into general use has been devised by Dolezalek. It is of the ordinary quadrant type with a very light needle of silvered paper, spindle shaped, which lies fairly close to the quadrants. A very fine quartz suspension is employed. In consequence of the lightness of the needle and its nearness to the quadrants, it acts as its own damper. These instruments can readily be made to give a sensibility of several thousand divisions for a volt when the needle is charged to about one hundred volts. The sensibility of the electrometer passes through a maximum as the potential of the needle is increased. It is always advisable to charge the needle to about the value of this critical potential. The capacity of the electrometer is in general high (about 50 electrostatic units) but the increased sensibility more than compensates for this. In addition to its great sensibility, the advantage of this

instrument is in the steadiness of the zero and in the self-damping.

If a quartz suspension is employed, the needle is charged by lightly touching it with a fine wire connected with one terminal of a battery of accumulators.

For ordinary measurements where great sensibility is not required, it is desirable to use a fine suspension of phosphor bronze, and to keep the needle permanently charged to the required potential by means of a battery.

A sensibility of 10,000 millimetre divisions per volt can be readily obtained with this electrometer, if a very fine quartz fibre be used. The use of such high sensibilities cannot, however, be recommended except for very special experiments. The period of swing of the needle under these conditions is several minutes and the natural leak of the testing vessels employed, as well as electrostatic and other disturbances, make themselves only too manifest.

For most measurements in radio-activity, an electrometer which has a sensibility of 200 divisions per volt is very suitable, and no advantage is gained by using an electrometer of greater sensibility.

If measurements of minute currents are required, an electroscope of the type described in section 35 is often to be preferred to a very sensitive electrometer. The electroscope readings in such a case are more accurate than similar measurements made by an electrometer.

In adjusting an electrometer, it is important to arrange that the needle shall lie symmetrically with regard to the quadrants. This is the case where the needle is not deflected on charging, the quadrants all being earthed. When this condition is fulfilled, the zero reading of the electrometer remains unaltered as the needle loses its charge, and the deflection on both sides of the zero should be the same for equal and opposite quantities of electricity.

For work with electrometers, a special key is necessary in order to make and break from a distance the connection of the quadrants with earth so as to avoid electrostatic disturbances at the moment the current is to be measured. This is most simply done by operating the key with a string or by some electromagnetic device.

It is desirable that the movement of the conductor, which breaks the contact, should be as small as possible.

In working with a sensitive instrument like the Dolezalek electrometer, it is essential that the electrometer and the testing apparatus should be completely enclosed in a screen of wire-gauze connected with earth, in order to avoid electrostatic disturbances. If an apparatus is to be tested at some distance from the electrometer, the wires leading to it should be insulated in metal cylinders connected with earth. The size of the insulators used at various points should be made as small as possible, in order to avoid disturbances due to their electrification. In damp climates amber or sulphur insulates better than ebonite. All insulators should be diselectrified by means of a spirit-lamp or still better by leaving some uranium near them. Care should be taken not to touch the insulation when once diselectrified.

In accurate work it is advisable to avoid the use of gas jets or Bunsen flames in the neighbourhood of the electrometer, as the flame gases are strongly ionised and take some time to lose their conductivity. If radio-active substances are present in the room, it is necessary to enclose the wires leading to the electrometer in fairly narrow tubes, connected with earth. If this is not done, it will be found that the needle does not move at a constant rate, but rapidly approaches a steady deflection where the rate of loss of charge of the electrometer and connections, due to the ionisation of the air around them, is balanced by the current to be measured. This precaution must always be taken when observations are made on the very penetrating rays from active substances. These rays readily pass through ordinary screens, and ionise the air around the electrometer and connecting wires. For this reason it is difficult to make accurate measurements of small currents in a room which is used for the preparation of radio-active material.

42. String electrometer. In sensitive electroscopes or quadrant electrometers, the moving system responds tardily to a difference of potential applied. These instruments consequently cannot be used with advantage to measure rapid changes in the value of an ionisation current. The detection of such rapidly varying currents is now of considerable interest and importance

in connection with the study of discontinuous phenomena, such as is exhibited in the expulsion of α and β particles from a radioactive substance.

Types of electrometers fulfilling the necessary conditions have been devised by Lutz*, Laby† and Elster and Geitel‡. A fine quartz thread silvered to make it conducting is suspended centrally between two parallel plates, which are connected to opposite poles of a battery of about 200 volts, the middle point of which is earthed. Any charge communicated to the quartz fibre is then shown by a movement of the fibre, and the deflection from the zero, when the fibre is earthed, is measured by a high power microscope. As far as regards the quartz fibre and the microscope, the arrangements are similar to those employed in the Einthoven string galvanometer. By suitable adjustment of the voltage, the fibre can be made to give a deflection of several hundred divisions of the microscopic scale corresponding to a rise of potential of one volt. The string electrometer responds rapidly to any change of voltage. The rapidity of movement is controlled in part by the tension of the fibre. An electrometer of this type is very useful for counting α particles by the electric method, and for measuring the probability variations in the emission of α and β particles. (Sections 59, 75.)

43. Steady deflection method. The rate method for measuring ionisation currents by means of an electrometer is to be relied on only if the rate of movement of the needle is slow. If the rate of movement is rapid, successive measurements may agree closely, but may nevertheless be in considerable error, for it takes some time for the motion of the electrometer needle to become steady. Bronson has developed a method of measurement in which the currents are measured by an electrometer as in a galvanometer by a steady deflection. In order to realise this practically, it is necessary that the charge on the electrometer system should leak away through a high resistance. For measurement of ionisation currents of the magnitude ordinarily employed,

* Lutz, *Phys. Zeit.* **9**, p. 100, 1908.

† Laby, *Proc. Camb. Phil. Soc.* **15**, p. 106, 1909.

‡ Elster and Geitel, *Phys. Zeit.* **10**, p. 664, 1909.

a resistance of more than 10,000 megohms would be required in order to obtain a reasonable steady deflection of the needle of an ordinary electrometer. It is difficult to obtain a sufficiently high and constant resistance to answer the purpose*, and in their place Bronson† employed what may be called an “air resistance.” The arrangement of the experiment is shown in Fig. 16.

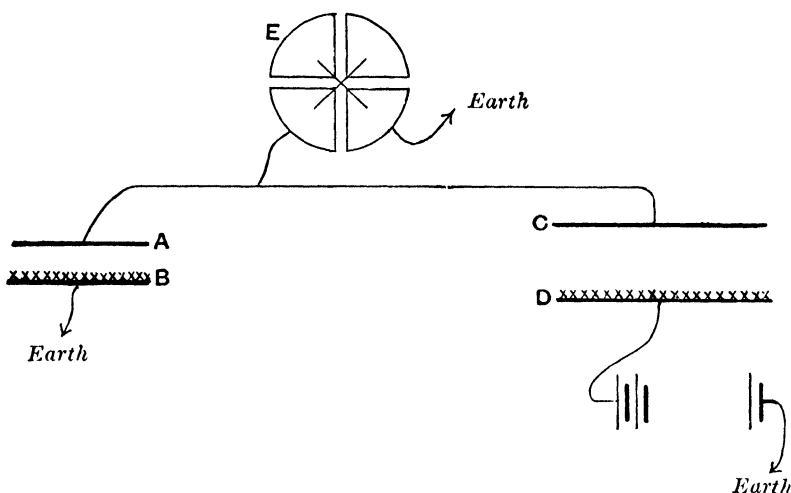

Fig. 16.

The electrometer system was connected with the upper of two insulated parallel plates *AB*, on the lower of which was spread a layer of a very active substance. The lower plate *B* was connected to earth. The charge communicated to the upper plate of the testing vessel *CD* and the electrometer system leaked away in consequence of the strong ionisation between the plates *AB*, and a steady deflection was obtained when the rate of supply was equal to the rate of discharge.

Bronson found that such a constant air resistance, suitable for measurement over a large range, could be constructed by using as a source of radiation a small plate on which a trace of radium salt had been evaporated. This was placed at the bottom of an ebonite cylinder with the upper electrode several centimetres above it.

* W. Campbell (*Phil. Mag.* 21, p. 301, 1911) states that a resistance consisting of a mixture of xybol and absolute alcohol in thermometer tubing is very suitable for the purpose.

† Bronson, *Amer. Journ. Sci.* 19, p. 185, 1905.

The apparatus was completely sealed to avoid the escape of emanation. This air resistance obeyed Ohm's Law over a considerable range, so that the steady deflection of the electrometer was proportional to the current. By applying a suitable voltage to the radium plate in order to balance the greater part of the ionisation current which was being measured, the electrometer can be employed to measure currents accurately over a wide range. When the ionisation current was due to α rays, Bronson observed that the electrometer needle never came to rest but oscillated irregularly about a mean position. This is now known to be due to the probability variations in the rate of emission of α particles. (Section 75.)

44. Balance and compensation methods. The increasing importance of accurate measurements of ionisation currents has led to the use of a number of compensation and balance methods. For example, if the small variations of the ionisation current in a testing vessel are to be accurately determined, it is advisable to balance the main current by means of an opposite current supplied by the ionisation due to a constant source of radiation like uranium oxide. The variations of the current in the testing vessel are then directly indicated by the motion of the electrometer needle. If the ionisation current to be balanced is very small, it is desirable to use the β rays rather than the α rays of uranium as the source of radiation, for the probability variations in the case of the β rays is smaller than for an equal ionisation by the α rays (see section 75).

Allen* has described a simple compensation method in which the current to be measured is balanced against that due to uranium oxide as a source of radiation. The current supplied by the latter in an electric field is varied by altering the area of the radiating surface. The current due to the uranium oxide in a given electric field is calibrated by suitable methods. Townsend has employed another form of compensation method. One terminal of a condenser is connected with the electrometer, and the other with a source of E.M.F., the magnitude of which can be varied rapidly and at will by means of a simple type of potentiometer. In

* Allen, *Phil. Mag.* **14**, p. 712, 1907.

experiments by this method, the electrometer needle is kept balanced as nearly as possible for a definite interval of about one minute, and the current to be measured is then equal to the capacity multiplied by the average rate of rise of potential of the condenser. In this case, the current is determined at once in absolute measure for each observation, and the electrometer is merely used as a detector rather than as a measurer of the current.

45. Quartz Piezo-electrique. A compensation method based on quite a different principle has been largely used in France. It depends on the use of the quartz piezo-electrique devised by the brothers MM. J. and P. Curie*.

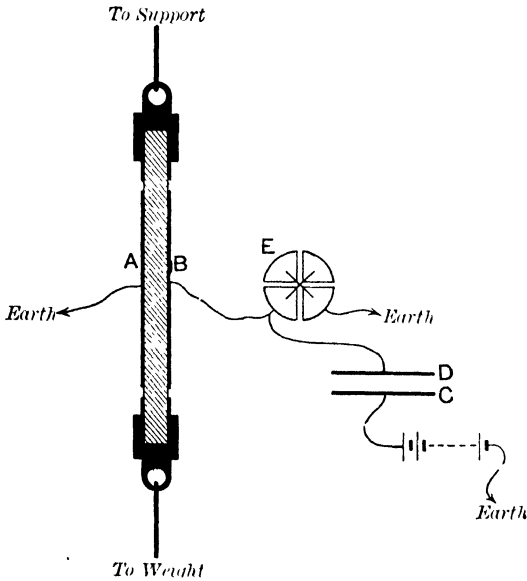

Fig. 17.

The essential part of this instrument consists of a plate of quartz which is cut in a special manner. The plate of quartz *AB* (Fig. 17) is cut so that the optic axis of the crystal is horizontal and at right angles to the plane of the paper. When this plate is placed under tension, there is a liberation of electricity equal

* J. and P. Curie, *C. R.* **91**, pp. 38 and 294, 1880. See also Friedel and J. Curie, *C. R.* **96**, pp. 1262 and 1389, 1883, and Lord Kelvin, *Phil. Mag.* **36**, pp. 331, 342, 384, 414, 453, 1893.

in amount but opposite in sign on the two sides of the plate. The plate is hung vertically and weights are added to the lower end.

The two faces A and B are normal to one of the binary axes (or electrical axes) of the crystal. The tension must be applied in a direction normal to the optic and electric axes. The two faces A and B are silvered, but the main portion of the plate is electrically insulated by removing a narrow strip of the silvering near the upper and lower ends of the plate. One side of the plate is connected with the electrometer and with the conductor, the rate of leak of which is to be measured. The quantity of electricity set free on one face of the plate is accurately given by

$$Q = 0.0677 \frac{L}{b} F,$$

where L is the length of the insulated portion of the plate, b the thickness AB , and F the weight attached in kilogrammes. Q is then given in electrostatic units.

Suppose, for example, that it is required to measure the current between the plates CD (Fig. 17) due to some radio-active material on the plate C , for a given difference of potential between C and D . At a given instant the connection of the quadrants of the electrometer with the earth is broken. The weight is attached to the quartz plate, and is held in the hand so as to apply the tension gradually. This causes a release of electricity opposite in sign to that given to the plate D . The electrometer needle is kept at the position of rest as nearly as possible by adjusting the tension by hand. The tension being fully applied, the moment the needle commences to move steadily from zero is noted. The current between the plates CD is then given by $\frac{Q}{t}$ where t is the time of the observation. The value of Q is known from the weight attached.

In this method the electrometer is only used as a detector to show that the system is kept at zero potential. No knowledge of the capacity of the insulated system is required. With practice, measurements of the current can be made in this way with rapidity and certainty.

46. Testing Apparatus. The arrangement shown in Fig. 18 is very convenient for many measurements in radio-activity. Two parallel insulated metal plates *A* and *B* are placed inside a metal vessel *V*, provided with a side door. The plate *A* is connected

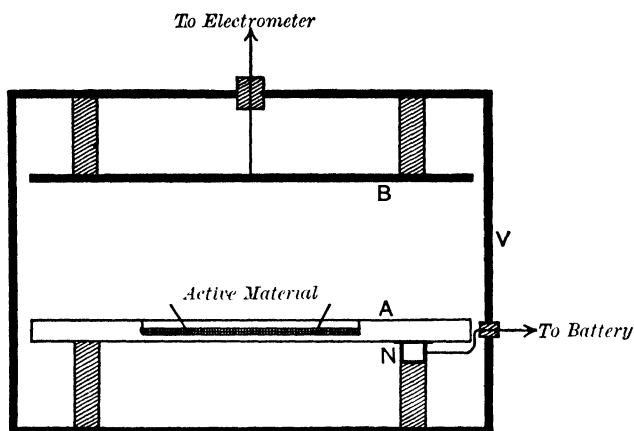

Fig. 18.

with one terminal of a battery of small storage cells, the other pole of which is earthed; the plate *B* is connected with the electrometer, and the vessel *V* with earth. The shaded areas in the figure indicate the position of ebonite insulators. The active material to be tested is placed on the brass plate *A*. In order to avoid breaking the battery connection every time the plate *A* is removed, the wire from the battery is permanently connected with the metal block *N* resting on the ebonite support. In this arrangement there is no possibility of a conduction leak from the plate *A* to *B*, since the earth-connected vessel *V* intervenes.

An apparatus of this kind is very convenient for testing the absorption of the α and β radiations by solid screens, as well as for making comparative studies of the activity of different bodies. Unless very active preparations of radium are employed, a battery of 300 volts is sufficient to ensure practical saturation when the plates are not more than 5 centimetres apart. If substances which give off a radio-active emanation are being tested, the effect of the emanation can be eliminated to a large extent by passing a steady current of air between the plates.

If a clean plate is put in the place of *A*, a small movement of the electrometer needle is always observed. If there is no radioactive substance in the neighbourhood, this effect is due to the small natural ionisation of the air.

We have often to measure the activity due to the emanations of thorium or radium, or the activity imparted by those emanations to rods or wires. A convenient apparatus for this purpose is shown in Fig. 19. The cylinder *B* is connected with the battery

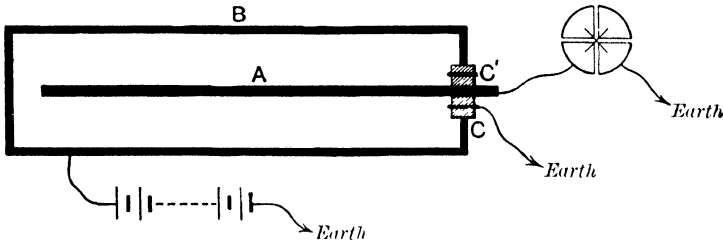

Fig. 19.

in the usual way, and the central conductor *A* with the electrometer. This central rod is insulated from the external cylinder by an ebonite collar, which is divided into two parts by a metal ring *CC'* connected to earth. This ring acts the part of a guard-ring, and prevents any conduction leak between *B* and *A*. The ebonite is thus only required to insulate satisfactorily for the small rise of potential produced on *A* during the experiment. In all accurate measurements of current in radio-activity the guard-ring principle should always be used to ensure good insulation. This is easily secured when the ebonite is only required to insulate for a fraction of a volt, instead of for several hundred volts, as is the case when the guard-ring is absent.

For measurements of radio-activity with an electrometer, a steady source of E.M.F. of at least 300 volts is necessary. This is best obtained by a battery of small cells made simply by immersing strips of lead in dilute sulphuric acid, or by a battery of small accumulators of the usual construction. Small accumulators of capacity about one-half ampere-hour can now be obtained at a moderate price, and are more constant and require less attention than simple lead cells.

In order to measure currents over a wide range, a graduated series of capacities is required. The capacity of an electrometer and testing apparatus is usually about 50 electrostatic units or $\cdot 000056$ microfarads. Subdivided condensers of mica are constructed in which capacities varying from $\cdot 001$ to $\cdot 2$ microfarads are provided. With such a condenser, another extra capacity is required to bridge over the gap between the capacity of the electrometer and the lowest capacity of the condenser. This capacity of value about 200 electrostatic units can readily be made by using parallel plates or still better concentric cylinders. With this series of capacities, currents may be measured between 3×10^{-14} and 3×10^{-8} amperes—a range of over one million. Still larger currents can be measured if the sensibility of the electrometer is reduced, or if larger capacities are available.

47. Measurement of Current. In order to determine the current in the electrometer circuit by measuring the rate of movement of the needle, it is necessary to know both the capacity of the circuit and the sensibility of the electrometer.

Let C = capacity of electrometer and its connections in E.S. units,
 d = number of divisions of the scale passed over per second,
 D = sensibility of the electrometer measured in scale divisions for 1 volt P.D. between the quadrants.

The current i is given by the product of the capacity of the system and the rate of rise of potential.

$$\begin{aligned} \text{Thus} \quad i &= \frac{Cd}{300D} \text{ E.S. units,} \\ &= \frac{Cd}{9 \times 10^{11} D} \text{ amperes.} \end{aligned}$$

Suppose, for example,

$$C = 50, \quad d = 5, \quad D = 1000;$$

then $i = 2.8 \times 10^{-13}$ amperes.

Since the electrometer can readily measure a current corresponding to a movement of half a scale division per second,

we see that an electrometer can measure a current of 3×10^{-14} amperes, which is considerably below the range of the most sensitive galvanometer.

The capacity of the electrometer itself must not be considered as equal to that of the pair of quadrants and the needle when in a position of rest. The actual capacity is very much larger than this, on account of the motion of the charged needle. Suppose, for example, that the needle is charged to a high negative potential, and kept at the zero position by an external constraint. If a quantity Q of positive electricity is given to the electrometer and its connections, the whole system is raised to a potential V , such that $Q = CV$, where C is the capacity of the system. When however the needle is allowed to move, it is attracted into the charged pair of quadrants. This corresponds to the introduction of a negatively charged body between the quadrants, and in consequence the potential of the system is lowered to V' . The actual capacity C' of the system when the needle moves is thus greater than C , and is given by

$$C'V' = CV.$$

Thus the capacity of the electrometer is not a constant, but depends on the potential of the needle, *i.e.* on the sensibility of the electrometer.

48. Capacity of electrometer. The capacity of the electrometer and its connections cannot be measured by any of the commutator methods used for the determination of small capacities, for in such cases the needle does not move, and the capacity measured is not that of the electrometer system when in actual use. The value of the capacity may, however, be determined by the method of mixtures.

Let C = capacity of electrometer and connections,

C_1 = capacity of a standard condenser.

The electrometer and its connections are charged to a potential V_1 by a battery, and the deflection d_1 of the needle is noted. By means of an insulated key, the capacity of the standard condenser is added in parallel with the electrometer system. Let V_2 be the potential of the system, and d_2 the new deflection.

Then

$$CV_1 = (C + C_1) V_2,$$

$$\frac{C + C_1}{C} = \frac{V_1}{V_2} = \frac{d_1}{d_2},$$

and

$$C = C_1 \frac{d_2}{d_1 - d_2}.$$

A simple standard capacity for this purpose can be constructed of two concentric brass tubes the diameters of which can be accurately measured. The external cylinder D (Fig. 20) is mounted

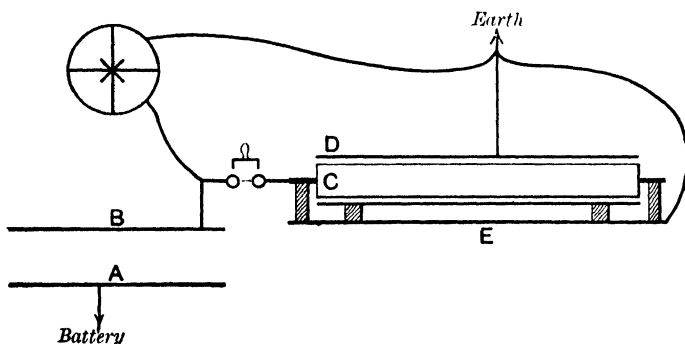

Fig. 20.

on a wooden base, which is covered with a sheet of metal or tin-foil connected to earth. The tube C is supported centrally on ebonite rods at each end. The capacity is given approximately by the formula

$$C = \frac{l}{2 \log_e \frac{b}{a}},$$

where b is the internal diameter of D , a the external diameter of C , and l the length of the tubes.

The following method can be used in some cases with advantage. While a testing vessel is in connection with the electrometer, a sample of uranium is placed on the lower plate A . Let d_2 and d_1 be the number of divisions passed over per second by the needle with and without the standard capacity in connection.

Then

$$\frac{C + C_1}{C} = \frac{d_1}{d_2},$$

and

$$C = C_1 \frac{d_2}{d_1 - d_2}.$$

This method has the advantage that the relative capacities are expressed in terms of the motion of the needle under the actual conditions of measurement.

49. Ionisation standards. In many experiments in radio-activity, it is necessary to measure by the electric method the variations in activity of a substance over long intervals of time. As the sensibility of electroscopes and other measuring instruments may alter from time to time due to a variety of causes, it is very desirable to have some simple means of correcting for these variations. This is most simply done by the use of radioactive standards. The most convenient substance to employ for this purpose is the black oxide of uranium, which for all practical purposes may be considered to be an invariable source of radiation.

Such a standard can be readily prepared by a method first used by McCoy*. Some uranium oxide is ground to a fine powder and thoroughly mixed with an organic liquid, *e.g.* chloroform or ether. The mixture is then poured or uniformly spread over a plate of aluminium or of copper. The liquid soon evaporates and leaves behind a uniform film of uranium oxide which adheres firmly to the plate. In this way, films of uranium oxide of any desired thickness or area can be readily prepared. Practically all the ionisation produced by these films is due to the α rays. The ionisation current due to the active substance under observation is directly compared under definite conditions with that due to the uranium standard. The ratio of these two currents is independent of any variations in the sensibility of the measuring instrument.

By weighing the metal plate before and after the film is deposited, the weight of the film is determined. The number of α particles emitted per second from the film can be deduced from the observations of Geiger and Rutherford†, that one gram of uranium emits 2.37×10^4 α particles per second. The uranium standard thus not only serves to correct for variations of the sensibility of the electrometer or electroscope but affords a simple

* McCoy, *Phil. Mag.* 11, p. 176, 1906; *Amer. Journ. Sci.* 26, p. 521, 1908.

† Geiger and Rutherford, *Phil. Mag.* 20, p. 691, 1910.

method of deducing the number of α particles emitted by the active matter under observation when the differences of the ranges of the α particles emitted in the two cases are taken into account (see section 67).

If a standard of greater activity be required, a thin film of an ionium preparation may be used in place of uranium oxide. The activity of an ionium film which emits α rays is practically constant for the interval of a lifetime. Ionium is always separated from radio-active minerals with thorium, from which it cannot be chemically separated. In most cases, however, the activity due to the thorium in the preparation is negligible compared with that due to the ionium.

A thick layer of uranium oxide spread uniformly over a shallow dish makes a convenient standard for calibrating a β ray electro-scope. In a similar way, the γ rays from a small quantity of radium preparation kept in a sealed tube affords a simple method of standardising a γ ray electro-scope.

50. Radio-active contamination. In a laboratory in which radio-active experiments are constantly made, it is desirable that all sources of active matter should be kept in sealed vessels, in order to avoid possible radio-active contamination due to the distribution of radio-active material. This is especially important with a substance of a high activity like radium. The presence in a closed room of an unsealed capsule containing a few milligrams of radium salt, on account of the escape of the emanation, is sufficient in the course of a day to increase greatly the spontaneous leak of neighbouring electrometers and electroscopes. It is highly important not to perform chemical work with strong preparations of radium in a laboratory used for radio-active measurements, for general experience has shown that it is almost impossible to avoid a permanent radio-active contamination of the laboratory in consequence. Such work should be done in a building outside the main laboratory. In many laboratories, the radium emanation is now used in the place of radium itself for many experiments. It is important that this emanation should be kept in sealed vessels, and the work of transference should be done in some part of the laboratory where any accident involving the escape of emanation

shall not lead to the contamination of the main part of the building. The disturbance of measurement due to the escape of radium emanation is for the most part temporary in character; but a continuous escape of emanation leads ultimately to all the surface of the building becoming strongly active due to the deposition of the products of slow decay derived from the emanation. If accurate work with small activities is to be done in a laboratory, the importance of handling all radio-active material with the greatest care cannot be too strongly insisted upon.

CHAPTER IV.

THE ALPHA RAYS.

COMPARISON OF THE RADIATIONS.

51. The Three Types of Radiation. All the radio-active substances possess in common the power of acting on a photographic plate and of ionising the gas in their immediate neighbourhood. The intensity of the radiations may be compared by means of their photographic or electrical action; and, in the case of the strongly radio-active substances, by the power they possess of lighting up a phosphorescent screen. Such comparisons, however, do not throw much light on the question whether the radiations are of the same or of different kinds, for it is well known that such different types of radiations as the short waves of ultra-violet light, Röntgen and cathode rays, all possess the property of producing ions throughout the volume of a gas, lighting up a fluorescent screen, and acting on a photographic plate. Neither can the ordinary optical methods be employed to examine the radiations under consideration, as they show no trace of regular reflection, refraction, or polarisation.

Two general methods can be used to distinguish the types of the radiations given out by the same body, and also to compare the radiations from the different active substances. These methods are as follows:

(1) By observing whether the rays are appreciably deflected in a magnetic and in an electric field.

(2) By comparing the relative absorption of the rays by solids and gases.

Examined in these ways, it has been found that there are three distinct types of radiation emitted from radio-active bodies, which for brevity and convenience have been termed by the writer the α , β , and γ rays*.

(i) The α rays are very readily absorbed by thin metal foil and by a few centimetres of air. They have been shown to consist of positively charged atoms of helium projected with a velocity of about $1/15$ the velocity of light. They are deflected by intense magnetic and electric fields, but the amount of deviation is minute in comparison with the deviation, under the same conditions, of the cathode rays produced in a vacuum tube.

(ii) The β rays are on an average far more penetrating in character than the α rays, and consist of negatively charged bodies projected with velocities of the same order as the velocity of light. They are far more readily deflected than the α rays, and are in type identical with the cathode rays produced in a vacuum tube.

(iii) The γ rays are extremely penetrating, and non-deviable by a magnetic or electric field. Their true nature is not definitely settled, but they are analogous in most respects to very penetrating Röntgen rays.

The four best known radio-active substances, uranium, thorium, radium and actinium, when in equilibrium with their products, all give out these three types of rays.

52. Comparison of the rays. The rays emitted from the active bodies thus present a very close analogy with the rays which are produced in a highly exhausted vacuum tube when an

* In an examination of uranium the writer (*Phil. Mag.* **47**, p. 116, 1899) found that the rays from uranium consist of two kinds, differing greatly in penetrating power, which were called the α and β rays. Later, it was found that similar types of rays were emitted by thorium and radium. On the discovery that very penetrating rays were given out by uranium and thorium as well as by radium, the term γ was applied to them. The word "ray" has been retained in this work, although it is now settled that the α and β rays consist of particles projected with great velocity. The term is thus used in the same sense as by Newton, who applied it in the *Principia* to the stream of corpuscles which he believed to be responsible for the phenomenon of light. The name "emanation" is used only with reference to the radio-active gases which diffuse from thorium, actinium, and radium.

electric discharge passes through it. The α rays are analogous to the canal rays, discovered by Goldstein, which have been shown by Wien to consist of positively charged bodies projected with great velocity (see section 32). The β rays are the same as the cathode rays, while the γ rays resemble the Röntgen rays. In a vacuum tube, a large amount of electric energy is expended in producing the rays, but, in the radio-active bodies, the rays are emitted spontaneously, and at a rate uninfluenced by any chemical or physical agency. The α and β rays from the active bodies are projected with much greater velocity than the corresponding rays in a vacuum tube, while the γ rays are of much greater penetrating power than Röntgen rays.

The effect of a magnetic field on a pencil of rays from a radio-active substance giving out three kinds of rays is illustrated in Fig. 21.

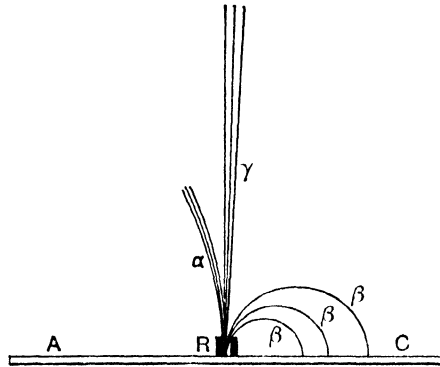

Fig. 21.

Some radium is placed in the bottom of a narrow cylindrical lead vessel R . A narrow pencil of rays consisting of α , β , and γ rays escapes from the opening. If a strong uniform magnetic field is applied at right angles to the plane of the paper, and directed towards the paper, the three types of rays are separated from one another. The γ rays continue in a straight line without any deviation. The β rays are deflected to the right, describing circular orbits the radii of which vary within wide limits. If the photographic plate AC is placed under the radium vessel, the β rays produce a diffuse photographic impression on the right of the vessel R . The α rays are bent in the direction opposite to that

of the β rays, and describe a portion of the arc of a circle of large radius, but they are rapidly absorbed after traversing a distance of a few centimetres from the vessel R . The amount of the deviation of the α rays compared with the β rays is much exaggerated in the figure.

53. Ionising and penetrating power of the rays. Of the three types of rays, the α rays produce most of the ionisation in the gas and the γ rays the least. For example, using a thin layer of a radium compound spread on the lower of two parallel plates 5 cms. apart, the amount of ionisation due to the α , β , and γ rays is of the relative order 10,000, 100 and 1. These numbers are only rough approximations and the differences become less marked as the thickness of the radio-active layer is increased. Since each type of rays from radio-active substances is usually complex and consists of radiations which are absorbed to an unequal extent, it is difficult to give an accurate comparison of the relative penetrating power of the three types of rays. As a rough working rule, it may be taken that the β rays are about 100 times as penetrating as the α rays and the γ rays from 10 to 100 times as penetrating as the β rays.

It is often convenient to know what thickness of matter is sufficient to absorb a specific type of radiation. A thickness of .006 cms. of aluminium or mica or a sheet of ordinary writing-paper is sufficient to absorb completely all the α rays. With such a screen over the active material, the external effects are due only to the β and γ rays, which pass through with a very slight absorption. Most of the β rays are absorbed in 5 mms. of aluminium or 1 mm. of lead. The radiation passing through such screens consists very largely of the γ rays. As a rough working rule, it may be taken that a thickness of matter required to absorb any type of rays is inversely proportional to the density of the substance, *i.e.* the absorption is proportional to the density. This rule holds approximately for light substances, but, in heavy substances like mercury and lead, the radiations are more readily absorbed than the density rule would lead us to expect.

54. Difficulties of comparative measurements. It is difficult to make quantitative or even qualitative measurements

of the relative intensity of the three types of rays from active substances. The three general methods employed depend upon the action of the rays in ionising the gas, in acting on a photographic plate, and in causing phosphorescent or fluorescent effects in certain substances. In each of these methods the fraction of the rays which is absorbed and transformed into another form of energy is different for each type of ray. Even when one specific kind of ray is under observation, comparative measurements are rendered difficult by the complexity of that type of rays. For example, the β rays from radium consist of negatively charged particles projected with a wide range of velocity, and, in consequence, they are absorbed in different amounts in passing through a definite thickness of matter. In each case, only a fraction of the energy absorbed is transformed into the particular type of energy, whether ionic, chemical, or luminous, which serves as a means of measurement.

The necessity of taking into account the relative ionising and photographic effects produced by the α and β rays is well illustrated by the earlier experiments with uranium. With unscreened material, the ionisation observed is due mainly to the α rays while the photographic effect is largely due to the β rays. The failure to appreciate this difference led at first to considerable confusion and apparent contradiction in the effects observed.

THE α RAYS.

55. The α rays. The magnetic deviation of the β rays was discovered towards the end of 1899, at a comparatively early stage in the history of radio-activity, but three years elapsed before the true character of the α rays was disclosed. It was natural that great prominence should have been given in the early stages of the subject to the β rays, on account of their great penetrating power and marked action in causing phosphorescence in many substances. The α rays were, in comparison, very little studied, and their importance was not generally recognised. It will, however, be shown that the α rays play a far more important part in radio-active processes than the β rays, and that the greater

portion of the energy emitted in the form of heat and of ionising radiations is due to them.

The nature of the α rays was difficult to determine, for a magnetic field sufficient to cause considerable deviation of the β rays produced no appreciable effect on the α rays. It was suggested by several observers that they were, in reality, secondary rays set up by the β or cathode rays in the active matter from which they were produced. Such a view, however, failed to explain the radio-activity of polonium, which gave out α rays only. Later work also showed that the matter, which gave rise to the β rays from uranium, could be chemically separated from the uranium, while the intensity of the α rays was unaffected. These and other results show that (the α and β rays are produced in many cases quite independently of one another.) (The view that they were an easily absorbed type of Röntgen rays failed to explain a characteristic property of the α rays, viz. that the absorption of the rays in a given thickness of matter, determined by the electrical method, increases with the thickness of matter previously traversed. This peculiarity of the absorption of the α rays was first clearly shown by Mme Curie* in 1900 using polonium as a source of radiation. In explanation, she suggested that the α rays consisted of projected particles, which lost their energy by passing through matter.) From observations of the ionisation produced in gases by the α and β rays Strutt† in 1901 suggested that the α rays might be analogous to the canal rays produced in a vacuum tube, and thus might consist of positively charged particles projected with great velocity. A similar suggestion was made in 1902 by Sir William Crookes‡.

The writer was led to the same view from consideration of a mass of indirect evidence, which only received an explanation on the assumption that the α rays consisted of projected charged matter. If this were the case a pencil of α rays should be deflected in a magnetic and in an electric field. Preliminary experiments in this direction were unsuccessful, but finally in 1903 when a more active preparation of radium was obtained, the writer was able to show

* Mme Curie, *C. R.* **130**, p. 76, 1900.

† Strutt, *Phil. Trans. Roy. Soc. A*, **196**, p. 507, 1901.

‡ Crookes, *Proc. Roy. Soc. A*, **69**, p. 413, 1902.

by the electric method that the α rays were deflected both by a magnetic and by an electric field*. The smallness of the magnetic deviation may be judged from the fact that the α rays projected at right angles to a magnetic field of 10,000 c.g.s. units describe the arc of a circle of about 40 cms. radius; while under the same conditions the cathode rays produced in a vacuum tube would describe a circle of about .01 cms. radius. It is, therefore, not surprising that the α rays were for some time thought to be non-deviable by a magnetic field.

56. The magnetic and electric deflection of the α rays.

A brief account will be given of the original experiments to show that the α rays consisted of projected particles carrying an electric

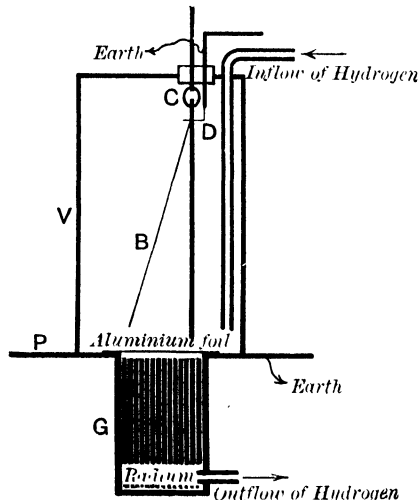

Fig. 22.

charge. The general arrangement of the experiment is shown in Fig. 22. The method employed to detect the magnetic deviation of the α rays was to allow the rays to pass through narrow slits, and to observe whether the rate of ionisation due to the α rays was altered by the application of a strong magnetic field. The rays from a thin layer of radium salt passed upwards through a number of narrow slits G in parallel, and then through a thin aluminium foil into the testing vessel V where the ionisation was measured

* Rutherford, *Phys. Zeit.* 4, p. 235, 1903; *Phil. Mag.* 5, p. 177, 1903.

by a gold-leaf electroscope. In order to increase the electrical effect in the testing vessel, the rays passed through about twenty slits of equal width placed side by side about 1 mm. apart. A magnetic field was applied perpendicular to the plane of the paper and parallel to the plane of the slits. The rays are thus deflected in the direction perpendicular to the plane of the slits, and a very small amount of deviation is sufficient to cause the rays to impinge on the side of the plate where they are absorbed. A steady current of hydrogen was passed through the apparatus to remove any emanation liberated from the radium salt, and in order to reduce the absorption of the α rays in passing through the gas. It was found that the ionisation in the electroscope due to the α rays could be reduced to a small fraction of its initial value by use of a very strong magnetic field. This showed that the α rays must consist of projected charged particles. The sign of the charge was determined by half covering the top of the slits with a brass strip. The diminution of the rate of discharge in the testing vessel by a given magnetic field then depends upon the direction of the field. In this way, it was found that the α rays were deflected in an opposite sense from the cathode rays. Since the latter consist of negatively charged particles the α rays must consist of positively charged particles. If the rays consist of charged particles they must be deflected in passing through an electric field as well as by a magnetic field. This was found to be the case by a modification of the same apparatus. The plates were insulated from each other and alternate plates were connected together and charged to a high potential by a battery of accumulators. On application of a strong electric field the ionisation in the testing vessel was diminished.

From a consideration of the dimensions of the apparatus, and the decrease of the ionisation when a magnetic and electric field was applied, it is possible to deduce the velocity u of the α particles, and the value of e/m , the ratio of the charge to the mass of the α particle. The values found were

$$u = 2.5 \times 10^9 \text{ cms. per sec.}$$

$$e/m = 6000 \text{ electromagnetic units.}$$

These results were only approximate in character, for the radiation

from the radium salt was complex, consisting of particles projected at different speeds. The results were soon confirmed by Des Coudres* by the photographic method, using some nearly pure radium bromide as a source of α rays. His results were in good agreement and gave the value $e/m = 6400$.

Since the value of e/m for the hydrogen atom is 9647 e.m. units the value of e/m found for the α particle indicated that it was of atomic dimensions, and of mass about twice that of the hydrogen atom, assuming that the α particle carries the same charge as the hydrogen atom. It was thus clear that the α rays must consist of a stream of positively charged atoms of matter projected with great velocity.

Becquerel† confirmed the deflection of the α rays in a magnetic field by a different method. A narrow pencil of α rays after passing through a slit fell on a photographic plate placed at a small angle with the issuing pencil and perpendicular to the magnetic field. If the field is reversed during the experiment, the plate on development shows two lines diverging from the slit. By measuring the deviation of the pencil of rays at different distances from the slit, Becquerel found that the radius of curvature of the rays increases with distance from the slit. These results seemed at first sight very remarkable, but it will be seen later (section 65) that they are completely explained by taking into account the complexity of the α radiation.

In 1905, further experiments were made by Mackenzie‡ using pure radium bromide as the source of radiation. A photographic method was employed in which the α rays fell on a glass plate coated on its lower surface with zinc sulphide. A photographic plate was placed on the upper side of the glass plate, and was acted on by the light from the scintillations produced by α particles in the zinc sulphide screen immediately below it. The deflection of a pencil of rays was observed both in a magnetic and electric field. The rays were found to be complex. Taking a mean value for the deflected rays, the velocity was found to vary between 1.3×10^9 and 1.96×10^9 cms. per second, while the value of e/m

* Des Coudres, *Phys. Zeit.* **4**, p. 483, 1903.

† Becquerel, *C. R.* **136**, p. 199, 1903.

‡ Mackenzie, *Phil. Mag.* **10**, p. 538, 1905.

was found to be 4600. The experiments were continued by W. B. Huff*, using a thin film of polonium on a bismuth rod as a source of radiation. He found value for polonium rays

$$u = 1.41 \times 10^9,$$
$$e/m = 4300.$$

57. Magnetic deflection of homogeneous rays. The discovery of the production of helium by radium suggested the possibility that the α particles consisted of charged particles of helium. To throw light on this question, the writer† made another and more accurate determination of the value of e/m for the α particle. In the interval between these and the original experiments, the knowledge of the nature of the absorption of the α rays had greatly increased. Bragg had shown that the α particles from a thin film of radio-active matter of one kind have a definite range of ionisation in air, and that the ionisation produced by the α particle falls off abruptly near the end of its path. He had concluded from his experiments that a thin film of one kind of active matter emits α particles of identical range and identical velocities, and that the velocity of the α particles are all reduced by an equal amount in passing through the same thickness of matter. In order to obtain an accurate determination of e/m , it was essential that a pencil of homogeneous rays should be employed in the experiments. It was found that a deposit of radium C was very suitable for the purpose. If a negatively charged wire is placed for some hours in a vessel containing radium emanation, the wire becomes intensely active by the concentration upon it of the active deposit produced from the emanation. This active deposit consists of the three products, radium A, radium B, and radium C. Fifteen minutes after removal from the emanation, the α ray activity due to radium A has practically disappeared, and the α radiation is then due entirely to radium C, for radium B emits only β rays. Such a wire then serves as a convenient source of homogeneous α rays, the range of which in air is 7 cms. By using large quantities of radium emanation, a thin wire may be made intensely active. The activity of radium C decays

* Huff, *Proc. Roy. Soc. A*, **78**, p. 77, 1906.

† Rutherford, *Phil. Mag.* **12**, p. 348, 1906.

rapidly and two hours after removal from the emanation is only 14 per cent. of its initial value.

In order to determine the value of e/m it is necessary to measure the deflection of the α rays in a magnetic and in an electric field. Fig. 23 shows the arrangement adopted to determine the deflection in a magnetic field. An active wire coated with radium C was placed in a groove A. The rays pass through a narrow slit B and fall on a small piece of photographic plate at C. The apparatus is enclosed in a cylindrical vessel P, which can be rapidly exhausted of air. The apparatus is placed between the pole pieces of a large electromagnet, so that the magnetic field is parallel to the direction of the wire and slit, and uniform over the whole path of the rays. The electromagnet is excited by a constant current, which is reversed every ten minutes.

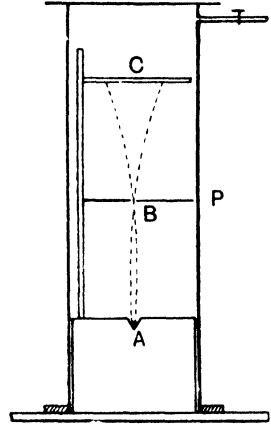

Fig. 23.

On developing the plate two well-defined bands are observed corresponding to the pencils of rays which have been deflected equally on opposite sides of the normal position of the band. If ρ is the radius of curvature of the circular arc described by the rays in a field of strength H , then $H\rho = \frac{mu}{e}$ where u is the velocity of the rays. If $2d =$ distance between bands on reversal of the field, $b =$ distance of slit from the source, $a =$ distance of plate from slit, then if d is small

$$2\rho d = a(a + b)$$

and

$$\frac{mu}{e} = H\rho = \frac{Ha(a + b)}{2d}$$

In the actual photographs, the width of the deflected band was the same as the undeflected band, showing that all the particles were projected with identical speed. The traces of the pencil of rays (see Fig. 24) stand out clearly with well-defined edges, so that the value $2d$, the distance of the inside edge of one band to the outside edge of the other, can easily be measured. In this

way the value of $H\rho$ for the α particles emitted from radium C was found to be 4.06×10^5 . In a uniform field of 10,000 c.g.s. units, the α particle consequently describes a circle of radius 40.6 cms.

With a modification of the experimental arrangement given in Fig. 23 it can be simply shown that the α particles *decrease* in velocity in passing through matter. By means of mica plates, placed at right angles to the slit, the apparatus is divided into two equal parts. One half of the photographic plate is acted on by the rays from the bare wire, and the other by the rays which have passed through an absorbing screen placed over the wire. A drawing of a photograph obtained by this method is shown in Fig. 24. The two upper bands *A* represent the traces of the pencil of rays obtained by reversal of the magnetic field for the rays from the uncovered half of the wire; the lower bands *B* were obtained for the rays from the wire, when covered with aluminium foil, of thickness about .0025 cms. The apparatus was exhausted during the experiment, so that the absorption of the rays by the gas is negligible*.



Fig. 24.

The greater deflection of the pencil of rays which has passed through the aluminium is clearly seen in the figure. It will be shown later that the value of e/m for the particles does not change in consequence of their passage through matter. The greater deflection of the rays is then due to a decrease of their velocity after passing through the screen. We have seen that the α particles from radium C are all projected initially with the same speed. The absence of dispersion of the rays after passing through the screen shows that the velocity of all the α particles is reduced by the same amount in traversing the screen.

58. Electrostatic deflection of homogeneous rays.

Unless very strong electric fields are employed, the deviation of

* If a fine wire coated with radium C is used as a source with a narrow slit, it is observed that the photographic traces are not uniform over the width, but that the edges of the band are far more intense than the centre. This effect, which is illustrated in the figure, is to be expected if the rays are uniformly expelled in all directions from each part of the wire (see section 113).

the α particle is small and difficult to measure. The arrangement employed for this purpose is shown in Fig. 25. The rays from the active wire W , after traversing a thin mica plate in the base of the brass vessel M , passed between two parallel insulated plates A and B , about 4 cms. high and 0.21 mms. apart. The plates A and B were charged to a known difference of potential by means of a battery. The pencil of rays after emerging from the parallel plates fell on a photographic plate P , placed a definite distance away. The whole apparatus was exhausted to a high vacuum.

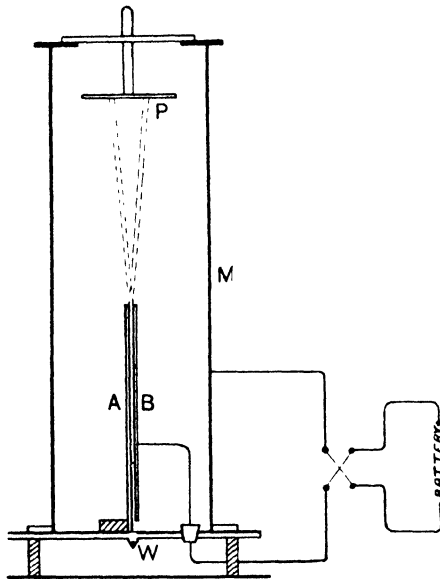

Fig. 25.

In this arrangement, the parallel plates A and B serve the double purpose of a slit, and as a means for applying an intense electric field. In their passage between the charged plates, the α particles describe a parabolic path, and those which emerge travel in a straight line to the photographic plate. Fig. 26, A shows the natural width of the line on the plate when no electric field is acting. B and C show the traces of the deflected pencil of rays for reversal of potential differences of 340 and 497 volts respectively. The outside edges of the bands are sharply defined with homogeneous rays, but the inside edge is not distinct, and

the width of the band narrows with increase of the electric field. Such an effect is to be expected theoretically.

It can be shown that if D is the distance between the extreme edges of the deflected bands for the reversal of a potential difference E

$$\frac{mv^2}{e} = \frac{8El^2}{(D-d)^2},$$

where e is the charge of the α particle, m its mass, v its velocity, and l the distance of the photographic plate from the end of the

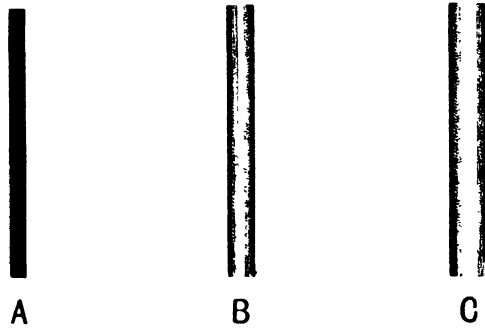

Fig. 26.

parallel plates, and d the distance between the parallel plates. This simple equation holds only if the field is strong enough to deflect the α particle through a distance greater than d in its passage through the electric field. For small values of the field, a modified form of this equation must be used.

The α rays from radium C deposited on a thin wire were used as a source of radiation. The decrease of velocity of these rays in passing through the mica plate at the base of the vessel was determined experimentally by measuring the magnetic deflection of the rays after passing through the mica. The value

$$\frac{mv}{e} = H\rho = 3.10 \times 10^9$$

and

$$\frac{mv^2}{e} = 4.87 \times 10^{14}$$

for rays of the same velocity. Consequently $v = 1.57 \times 10^9$ cms. per sec. and $e/m = 5070$. Correcting for the retardation of the α particles in passing through the mica plate, the initial velocity

of the α rays from radium C was found to be 2.06×10^9 cms. per sec.

By similar methods it was found that the value of e/m of the α particle did not alter by its passage through screens of different thicknesses. Determinations of e/m were also made for selected products of radium, actinium, and thorium. The products employed were radium A, radium F (polonium), actinium C and thorium C. The experiments with the active deposit of thorium were made in conjunction with Dr Hahn, using his intensely radio-active preparations of radiothorium. While the velocity of the α particles from each of these products differed considerably, the value of e/m was found to be the same in all cases within the limit of experimental error. These results show that the α particles from all of these products are identical, and suggest that the α particles from all radio-active products consist of the same kind of matter.

A difficulty immediately arose in regard to the conclusions to be drawn from these experiments. We have seen that the value of e/m for the hydrogen atom is 9647. If the α particle were a helium atom (of atomic weight 4) and carried the same positive charge as that of a hydrogen atom the value of e/m should be 2415 or about half the value actually observed. In order to reconcile the value of e/m for the α particle with the theoretical value, it was thus necessary to assume that the α particle carries two unit positive charges. This suggestion at the time seemed the most probable; but at the same time it was recognised that the results would be equally explained by supposing that the α particle was a hydrogen molecule or an atom of atomic weight about 2. We shall now consider some further experiments which have thrown much light on these questions.

59. Counting the α particles. The total number of α particles expelled per second from one gram of radium was initially estimated by Rutherford* by measuring the positive charge carried by the α particles emitted from a known quantity of radium in the form of a thin film. On the assumption that each α particle carried an ionic charge 3.4×10^{-10} electrostatic

* Rutherford, *Phil. Mag.* 10, p. 193, 1905.

units, the results showed that 6.2×10^{10} α particles are expelled per second from one gram of radium itself, and four times this number when the radium is in equilibrium with its three α ray products. The uncertainty, however, of the actual magnitude of the charge carried by the α particle rendered it desirable to determine this number by an independent method. We shall see later that the α particle from radium C of range about 7 cms. produces about 2.37×10^6 ions in its path in air before absorption. If each ion carries a charge 4.65×10^{-10} units, this corresponds to a transfer of 1.1×10^{-4} electrostatic units in a strong electric field. This quantity of electricity is small, but should be detectable using a very sensitive electroscope or electrometer. The detection of a single α particle, however, by its direct electrical effect, while not impossible, is beset by many experimental difficulties.

In order to increase the electrical effect, Rutherford and Geiger* developed a method of automatically magnifying the ionisation due to a single α particle, using the principle of the production of ions by collision. In an admirable series of papers, Townsend has worked out the conditions under which ions can be generated by collision with neutral gas molecules in a strong electric field. The general principle involved has already been explained in section 15. If a strong electric field acts on a gas at a low pressure, the number of ions produced in the gas by an external source is greatly increased by the movement of the ions in the electric field. If the voltage applied is near the sparking value, the ionisation current may in this way be increased more than a thousand times. In the experiments of Rutherford and Geiger to detect a single α particle, it was arranged that the α particles were fired through a gas at low pressure, exposed to an electric field somewhat below the sparking value. In this way, the small ionisation produced by one α particle in passing along the gas could be magnified several thousand times. The sudden current through the gas, due to the entrance of a single α particle in the detecting vessel, was by this method increased sufficiently to give an easily measurable deflection to the needle of an ordinary electrometer.

* Rutherford and Geiger, *Proc. Roy. Soc. A*, **81**, p. 141, 1908; *Phys. Zeit.* **10**, p. 1, 1909.

The experimental arrangement adopted is shown in Fig. 27. The detecting vessel consisted of a brass cylinder *A* from 15 to 20 cms. in length, and 1.77 cms. in diameter, with a centrally insulated wire *B* passing through ebonite plugs at the end. The cylinder was exhausted to a pressure varying from 2 to 5 cms. of mercury. The central wire was connected with the electrometer and the outside tube with the negative terminal of a battery of accumulators, the other pole of which was earthed. If the tube were connected to the positive pole of the battery, the magnification by collision became large only very close to the sparking value, and was less under control than when the field was reversed. In the ebonite plug *C*, was fixed a short glass tube *D*, in the end of which was a circular opening of about 1.5 mms. diameter. This opening, through which the α particles entered

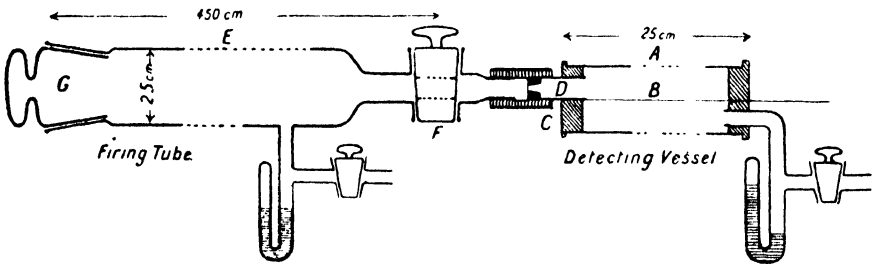

Fig. 27.

the testing vessel, was covered with a thin sheet of mica. In most experiments the thickness of the plate of mica was equivalent in stopping power of the α particle to about 5 mms. of air at ordinary pressure. Over the tube *D* was fixed a wide rubber tube, to the other end of which was attached a long glass tube *E*, 450 cms. in length. A stopcock *F* with a wide opening was placed near the detecting vessel. The general procedure of an experiment was as follows:—The voltage applied to the testing vessel was adjusted so that the current, due to an external source of γ rays, was increased by collision several thousand times. The active matter in the form of a thin film of small surface area was placed in the long tube *E*, and its distance from the detecting vessel could be varied by means of an external magnet. The glass tube was then exhausted to a low vacuum. When the stopcock *F* was closed, no α particles could enter the detecting vessel, and the steadiness of

the electrometer needle could thus be tested at intervals during the experiment. On opening the stopcock, a small fraction of the total number of the α particles expelled from the source passed through the aperture into the detecting vessel. The intensity of the source and its distance from the aperture were adjusted so that from 3 to 5 α particles entered the detecting vessel per minute. The entrance of an α particle into the detecting vessel was signified by a sudden *ballistic* throw of the electrometer needle. By adjusting the potential, it was not difficult to obtain a throw of 50 to 100 mms. on the electrometer scale for a single α particle. The following table illustrates the results obtained in an actual experiment. The voltage applied was 1320, and the detecting vessel contained carbon dioxide at a pressure of 4.2 cms. Each scale division was equal to 2.5 mms.

	Number of throws	Magnitude of successive throws in scale divisions
1st minute	4	11, 12, 10, 11
2nd "	3	10, 11, 8
3rd "	5	10, 9, 13, 8, 12
4th "	4	18*, 8, 12
5th "	3	10, 6, 10
6th "	4	9, 10, 12, 11
7th "	2	10, 11
8th "	3	11, 13, 8
9th "	3	8, 20*
10th "	4	8, 12, 14, 6
Average per minute = 3.5		Average throw = 10 divisions

It will be seen that two of the throws are marked by asterisks. The large deflection observed in each of these cases was undoubtedly due to the entrance of two α particles within a few seconds of each other. This was readily seen from the peculiarity of motion of the spot of light on the scale. As the electrometer needle was moving slowly near the end of its swing caused by one α particle, a second impulse due to the entrance of another was communicated to it. Provided the interval between two successive particles is not too small, such double throws are easily recognised.

The main difficulty in these experiments was to obtain a detecting vessel in which the natural disturbances under the experimental conditions were small compared with that due to an α particle. For this purpose, it was necessary to use as detecting vessel a cylinder of small diameter, for the number of such disturbances falls off rapidly with decrease of diameter. It was also found necessary to use short tubes, in order to avoid large inequalities in the magnitude of the throws due to individual α particles. This effect was found to be due to the scattering of the α particles in their passage through the mica plate and through the gas in the detecting vessel.

By this electric method, the emission of α particles was observed from all the known radio-active substances. For the accurate determination of the number of α particles expelled from radium, its product radium C was used as a source of rays. A deposit of radium C was obtained on a suitable surface by exposure to the emanation. The amount of radium C present at any time was determined by comparing its γ ray effect with that due to a radium standard.

Let Q be the average number of α particles expelled per second from the source, distant r from the aperture of area A . Since it was verified experimentally that the α particles on an average are projected equally in all directions, the number n of α particles entering the detecting vessel per second is given by $n = \frac{Q \cdot A}{4\pi r^2}$.

This expression holds provided that each portion of the active source can fire particles through the aperture. As a result of a number of experiments, it was found that the number of α particles emitted per second from the product radium C in equilibrium with one gram of radium was 3.4×10^{10} . From other evidence, it is known that the same number of α particles is emitted per second from one gram radium itself and from each of its three α ray products in equilibrium with it (see section 66). Consequently *the number of α particles expelled per second from one gram of radium itself is 3.4×10^{10} , and from radium in equilibrium 13.6×10^{10} .*

The movements of an electrometer or electroscope due to the entrance of successive α particles in the detecting vessel can be

photographically recorded, thus affording a method of counting the α particles. This has been done by Rutherford and Geiger using a string electrometer, by Duane* using a sensitive electroscope and by Mme Curie† using an electrometer. Since the α particles are expelled at random from the source, considerable fluctuations in the number of α particles are observed when a small number of particles is counted. A discussion of these probability variations is given later in section 75.

60. Counting of scintillations. It was found by Giesel that a screen of Sidot's hexagonal blend (phosphorescent zinc sulphide) lights up brightly when exposed to α rays. If the surface of the screen is examined by a magnifying glass, the light from the screen is found to be not uniformly distributed, but to consist of a number of scintillating points of light, scattered over the whole surface, exposed to the radiation, and having only a short duration. This remarkable effect of the α rays on a zinc sulphide screen was discovered by Sir William Crookes‡, and independently by Elster and Geitel§. The former has devised a simple apparatus called the *spintariscope* to show the scintillations due to radioactive matter. A small surface coated with a trace of radium is placed several millimetres away from the zinc sulphide screen, which is fixed at one end of a short tube, and is viewed by a lens at the other end. In a dark room the surface of the screen is seen as a dark background dotted with brilliant points of light, which come and go with great rapidity. The experiment is extremely beautiful, and brings vividly before the observer the idea that the radium is shooting out a stream of projectiles, the impact of each of which on the screen is marked by a flash of light. The scintillations of zinc sulphide are produced by α rays and not by β rays. A similar property is exhibited by certain kinds of diamonds. Regener|| found that the β particles produced a similar scintillating effect in barium-platino cyanide; but the scintillations are very feeble.

Regener|| was the first to count systematically the scintillations,

* Duane, *C. R.* **151**, p. 228, 1910; *Le Radium*, **7**, p. 196, 1910.

† Mme Curie, *Le Radium*, **8**, p. 354, 1911.

‡ Crookes, *Proc. Roy. Soc. A.*, **71**, p. 405, 1903.

§ Elster and Geitel, *Phys. Zeit.* **4**, p. 439, 1903.

|| Regener, *Verh. d. D. Phys. Ges.* **19**, pp. 78 and 351, 1908.

and has determined the most favourable conditions for their observation. It is desirable in ordinary cases to employ a microscope of magnification about 50 with an object glass of large aperture, in order to make the scintillations as bright as possible. The experiment should be made in a dark room when the eye is rested, and the surface of the screen should be faintly lighted up in order to keep the eye focussed on it.

The development of the electric method of counting made it possible to settle definitely whether each scintillation was produced by a single α particle. Rutherford and Geiger (*loc. cit.*) found that the number of α particles, counted by the scintillation method, was the same as the number of α particles incident on the screen determined by the electric method. On a uniform screen of zinc sulphide, there is thus no doubt that each α particle produces a visible scintillation. This optical method of counting α particles is much simpler than the electric method, and has been widely used as a direct means of counting the number of α particles emitted from all types of radio-active matter. Under the best conditions, the error of counting need not exceed more than one or two per cent. Unless a screen is very carefully made, the number of scintillations observed is usually 5 to 10 per cent. less than the number of incident α particles. It is essential for accurate work that the area of screen seen in the microscope should be completely coated with zinc sulphide crystals.

We have thus two distinct methods of detecting single α particles, one electrical, depending on the ionisation produced in the gas, and the other optical, depending on the luminosity produced in certain substances. Kinoshita* has also shown that each α particle produces a detectable photographic effect. A more complete discussion of the scintillations and also of the photographic effect of the α particles is given in Chapter VII.

C. T. R. Wilson† has recently devised a striking method of making visible the path of a single α or β particle. It has been shown in section 18 that the ions become centres of condensation in a moist gas when a definite supersaturation of water vapour is reached by a sudden expansion. Under suitable conditions, the

* Kinoshita, *Proc. Roy. Soc. A*, **83**, p. 432, 1909.

† C. T. R. Wilson, *Proc. Roy. Soc. A*, **85**, p. 285, 1911.

trail of the ions produced by the passage of an α particle through the gas is marked by a line of fine water drops. These trails of the particles can be readily photographed. This method of detection is so delicate that the trail of the β particle can also be seen, though it is far less dense than that due to the α particle on account of the much smaller ionisation produced per unit path by the former.

61. The charge carried by the α particle. Since the number of α particles can be directly counted, the charge carried by each α particle can be deduced by measuring the total charge carried by a counted number of α particles. The determination of the positive charge carried by the α particles was at first difficult* on account of the secondary electrical effects produced when α rays fall upon matter. J. J. Thomson† showed that a film of polonium emitted, in addition to α rays, a great number of negatively charged particles, which he termed the δ (delta) rays. These particles, which are identical with electrons, always appear when the α particles impinge on matter, whether in a liquid, solid or gaseous state. To determine the charge carried by the α rays it is necessary to eliminate the effects due to the δ rays. This can be done by placing the active matter in a strong magnetic field. Under such conditions, the δ particles, which are emitted at a slow speed from a surface, describe a small orbit, and return to the surface from which they set out. In order to measure accurately the

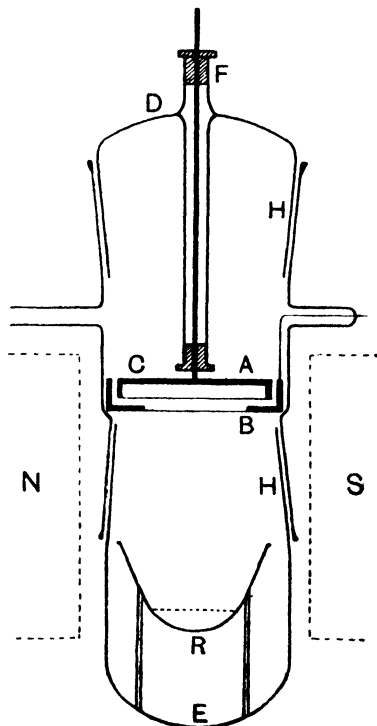

Fig. 28.

* See Rutherford, Bakerian Lecture, *Phil. Trans. Roy. Soc. A*, 204, p. 169, 1904; *Phil. Mag.* 10, p. 193, 1905.

† J. J. Thomson, *Proc. Camb. Phil. Soc.* 13, p. 49, 1904.

charge carried by the α rays, Rutherford and Geiger* employed radium C as a source of radiation. The experimental arrangement is shown in Fig. 28. The active matter in the form of a thin film was distributed on the inner surface of the vessel *R*. The α rays, after passing through a thin aluminium plate *B*, were stopped by the plate *CA*, the lower surface of which was also covered with a thin aluminium foil. The whole apparatus was placed in a strong magnetic field in order to get rid of the effect of the δ particles, and to bend away from the measuring vessel the β rays, which, in addition to α rays, are emitted from radium C. The apparatus was exhausted to a charcoal vacuum and the current between *CA* and *B* was measured by an electrometer. The γ ray activity of the active deposit was measured in terms of radium, and from this the number of α particles entering the measuring chamber was deduced. Using a strong magnetic field, the upper plate received a positive charge, whether the lower plate was charged positively or negatively. The current was first measured with the lower plate charged to a potential $+V$, and then with the same plate at a potential $-V$. Let i_1 be the current observed in the first case and i_2 in the second case. i_2 is always numerically less than i_1 , the ratio depending upon the degree of exhaustion. Let i_0 be the current through the gas due to the ionisation of the residual gas between the plates by the α rays. Then

$$i_1 = nE + i_0 \dots\dots\dots(1)$$

where n is the number of α particles passing into the upper plate per second and E the charge on each. On reversing the voltage, the ionisation is equal in magnitude but reversed in its direction. Consequently

$$i_2 = nE - i_0 \dots\dots\dots(2).$$

Adding (1) and (2)

$$nE = \frac{1}{2}(i_1 + i_2).$$

It was found in this way that the charge carried by one α particle was 9.3×10^{-10} e.s. units. From consideration of the values of the ionic charge, previously obtained by J. J. Thomson, Wilson and Millikan and Begeman, who had obtained values

* Rutherford and Geiger, *Proc. Roy. Soc. A*, **81**, p. 162, 1908; *Phys. Zeit.* **10**, p. 42, 1909.

3.4×10^{-10} , 3.1×10^{-10} , 4.06×10^{-10} respectively (see section 20), it was concluded that the α particle carried two unit positive charges. The value of the fundamental unit of charge was thus half this value, or 4.65×10^{-10} e.s. units. The adoption of this view reconciled the observed value of e/m with the value to be theoretically expected if the α particle were a helium atom.

Regener* determined the charge carried by the α rays from polonium by the same general method. In his experiments, however, the α particles were counted by observing the scintillations produced on a small diamond. As a result of very careful measurements, he found the charge on an α particle to be 9.58×10^{-10} , and consequently the fundamental unit of charge to be 4.79×10^{-10} , a value agreeing closely with the determination of Rutherford and Geiger. There is one possible source of error in the experiments of Regener. The charge carried by the α rays was determined with an uncovered polonium plate. It is known from the experiments of Russ and Makower, and Hahn (see section 73) that the expulsion of an α particle causes a recoil of the residual atom. In a vacuum these recoil atoms, which usually carry a positive charge, would travel with the α rays and give up their charge to the same plate. For this reason the apparent charge carried by the α particle would tend to be too high. In the experiments of Rutherford and Geiger, this possible error was not present, as a thin aluminium sheet was interposed between the source and the measuring vessel, of thickness ample to stop the recoil atoms. An account of the values obtained for the fundamental unit of charge by other methods has been given in section 20. The value of the fundamental unit is throughout this work taken as 4.65×10^{-10} electrostatic units, since a large amount of radio-active data has been given in terms of this unit.

62. Nature of the α particle. From the determination of the charge carried by the α particle, it seemed established from indirect evidence that the α particle was a helium atom, carrying two unit positive charges. This conclusion was confirmed by a direct experiment made by Rutherford and Royds†, who showed that

* Regener, *Sitz. Ber. d. k. Preuss. Akad. d. Wiss.* **38**, p. 948, 1909.

† Rutherford and Royds, *Phil. Mag.* **17**, p. 281, 1909.

accumulated α particles, quite independently of the matter from which they were expelled, consist of helium. The method of experiment will be clearly seen from Fig. 29. A large quantity of radium emanation was compressed into a fine glass tube *A* about 1.5 cms. long. This tube, which was sealed to a larger

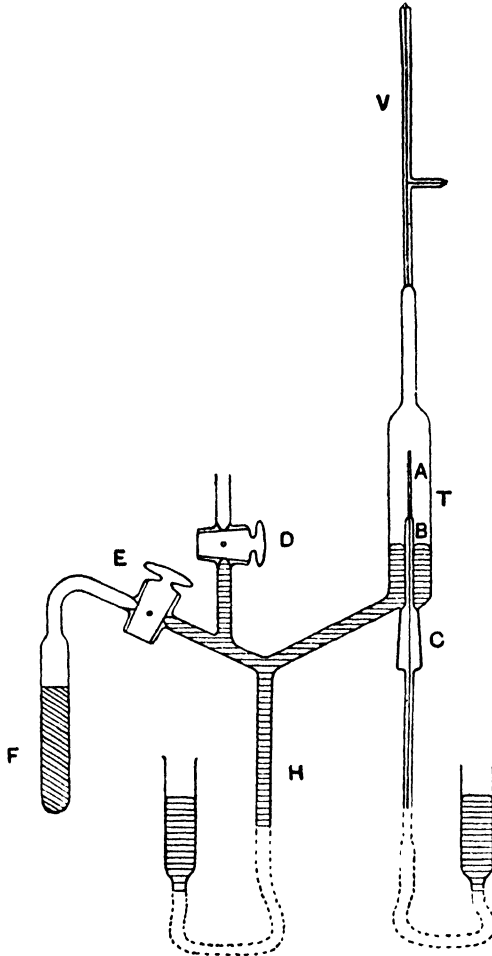

Fig. 29.

capillary tube *B*, was sufficiently thin to allow the α particles from the emanation and its products to escape; but sufficiently strong to withstand atmospheric pressure. The thickness of the glass wall was, in most cases, less than $1/100$ mm. On introducing the emanation into the tube, the escape of the α particles from

the emanation was clearly seen by the scintillations produced at some distance on a zinc sulphide screen. The glass tube A was surrounded by a cylindrical glass tube T , and a small spectrum tube V was attached to it. The tube T was completely exhausted to a charcoal vacuum. By means of the mercury column H the gases in the tube T could at any time be compressed into the spectrum tube V , and the nature of the gases present determined spectroscopically. It was found that two days after the introduction of the emanation, the spectrum showed the yellow line of helium, and after six days the whole helium spectrum was observed. In order to be certain that the helium had not diffused through the thin walls of the tube A , the emanation was pumped out and helium substituted. No trace of helium could be observed in the vacuum tube after several days, showing that the helium observed in the first experiment must have originated from the α particles, which had been fired through the thin glass tube into the outer cylinder.

Most of the α particles penetrate some distance into the walls of the outer tube, and some of these gradually diffuse out into the exhausted space. The presence of helium in the spectrum tube can be detected after a shorter interval if a thin cylinder of lead is placed over the emanation tube, since the helium fired into the lead diffuses out more rapidly than from glass. A still more definite proof of the identity of the α particle with the helium atom was obtained by removing the outer glass cylinder and placing a cylinder of sheet lead over the emanation tube in the open air. Helium was always detected in the lead after it had remained several hours over the thin tube containing a large quantity of emanation. In order to test for the presence of helium in the lead, the gases present were released by melting the lead in a closed vessel. There can thus be no doubt that the α particle becomes a helium atom when its charge is neutralised. The value of the charge carried by the α particle, and also the value of e/m , show in addition that the α particle must carry normally two unit charges. It is difficult to offer any definite explanation why the atom of a monatomic gas like helium should carry a double charge. Even supposing the α particle was initially emitted without charge, it would acquire a charge immediately due to

collision with the molecules of matter in its path. If the helium atom can readily lose two negative electrons, either at disintegration or as a result of the violent collisions with the atoms of matter, this would result in leaving the helium atom with a double positive charge. There is no definite evidence, however, that the α particle has not its final charge at the moment of its expulsion from the atom. This question has been examined in detail by Soddy who finally concluded that there was no definite evidence that the α particle was uncharged at the moment of its expulsion.

63. Atomic and radio-active constants. The determination of the number of α particles emitted by radium and of the value of the unit charge allows us at once to deduce the values of a number of important atomic and radio-active magnitudes*. If e be the unit of charge carried by the hydrogen atom in electrolysis, and n the number of atoms in one gram of hydrogen, it is known from Faraday's experiments that $ne = 9647$ electromagnetic units. Since $e = 4.65 \times 10^{-10}$ electrostatic units, or 1.55×10^{-20} electromagnetic units, the value of n is at once determined. From this it is a simple matter, assuming Avogadro's law, to deduce the number of molecules in one cubic centimetre of any gas at standard pressure and temperature. For convenience some of the more important atomic and radio-active constants are tabulated below.

Charge carried by the hydrogen atom	= 4.65×10^{-10} e.s. units.
Value of e/m for α particle	= 5070 e.m. units.
Charge carried by the α particle	= 9.3×10^{-10} e.s. units.
Number of atoms in 1 gram of hydrogen	= 6.2×10^{23} .
Mass of an atom of hydrogen	= 1.60×10^{-24} gram.
Number of molecules per cubic centimetre of any gas of standard pressure and temperature	= 2.78×10^{19} .
Number of α particles expelled per second per gram of radium itself	= 3.4×10^{10} .
Number of α particles expelled per second per gram of radium in equilibrium with its products	= 13.6×10^{10} .

* Rutherford and Geiger, *Proc. Roy. Soc. A*, **81**, p. 162, 1908.

With the aid of these data, it is possible to deduce at once the rate of production of helium from any substance, for example radium, for which the number of α particles emitted per second has been determined. It is known that one gram of radium in equilibrium produces 13.6×10^{10} atoms of helium per second. Dividing by the number of atoms of helium in one cubic centimetre, this corresponds to a production of helium of 4.90×10^{-9} c.c. per second, or 158 cubic mms. per year. It will be seen in Chapter XVII that this calculated value is in close agreement with that determined experimentally. Such a close concordance between calculation and experiment affords strong evidence of the essential correctness of the data on which the calculations are based.

64. Retardation of the α particle. We have seen in section 57 that the α particles diminish in velocity in passing through matter. Using a pencil of homogeneous rays, the reduction of velocity in traversing normally a uniform screen is nearly the same for all the α particles, so that a homogeneous pencil of rays remains nearly homogeneous after traversing the screen. In the ordinary arrangement, the effects of scattering of the α particles in passing through matter does not come in appreciably, but we shall see later (section 74) that there is some evidence that a small fraction of the α particles owing to scattering suffer a greater reduction of velocity than the average. In discussing the laws of retardation of the α particles, it is convenient to connect the velocity of an α particle with its range of ionisation in air. It will be seen later that Bragg has shown that the ionisation due to a homogeneous pencil of α rays ends comparatively abruptly after they have traversed a certain distance of air. This distance is called the *range* of the α particle in air. (The magnitude of the range is inversely proportional to the density of the air, and thus depends on the pressure and temperature.) The range in air is usually given for air at standard pressure and at laboratory temperature. For example, the range of the α particles from a thin film of radium C is 7.06 cms. at 20° C. On placing a uniform screen, for example of aluminium, over the source, the range of ionisation is reduced say to 5 cms. In this case, the screen of aluminium is said to

have a "stopping power" for the α particle equivalent to 2.06 cms. of air.

The decrease of velocity with thickness of matter traversed was first determined by Rutherford* by observing the deflection of the rays in a magnetic field. Radium C was used as a source of homogeneous rays and, by the photographic method, the variation of velocity of the α particles was observed after passing through various thicknesses of aluminium, for which the stopping power of the α particle was determined in terms of air. It was found that the photographic effect of the α particles fell off rapidly near the end of their range, and that it was not possible to detect by the photographic method α particles whose velocity had fallen below about $\frac{1}{4}$ of the initial velocity of projection of the α particles from radium C, *i.e.* below 8×10^8 cms. per second. It thus appeared at first as if the α particles lost their characteristic photographic and ionising properties while they were still moving at a high speed. The question was re-investigated by Geiger† using the scintillation method, and uniform screens of mica instead of aluminium in the path of the rays. He found that it was possible to detect the presence of α particles by scintillations for still lower velocities, although the number and intensity of the scintillations are much diminished. The results of the investigations of Rutherford and Geiger are given in the following table in terms of the air equivalent of the stopping power of the mica screen. The velocities are expressed in terms of the initial velocity of the α particle from radium C.

Equivalent distance of air traversed	Observed velocity	
	Rutherford	Geiger
0	1.00	1.00
1	0.95	0.95
2	0.87	0.89
3	0.80	0.82
4	0.75	0.75
5	0.65	0.66
6	0.52	0.52
7	0.43	0.2

* Rutherford, *Phil. Mag.* **12**, p. 134, 1906.

† Geiger, *Proc. Roy. Soc. A*, **83**, p. 505, 1910.

Rutherford showed from his experiments that the decrease of velocity V of an α particle of range R cms. could be expressed approximately by the formula

$$V^2 = R + 1.25.$$

Geiger showed that his results were more accurately expressed by the formula $V^3 = aR$ where a is a constant.

This simple relation holds very approximately over the range of velocities examined. It should be mentioned that it is very difficult to make accurate measurements when the velocity of the α particles falls much below .5 of the maximum velocity of the rays from radium C, for the photographic and scintillation effects of the α particles become very feeble near the end of their range. It is essential to employ absorbing screens of uniform thickness, for otherwise the photographic effect is mainly due to the rays which have suffered the least retardation. The scattering of the α particles also becomes of great importance near the end of their range and tends to reduce the intensity of the scintillating and photographic effects.

65. The photographic effect of the α rays from thick layers. Since the velocity of the α particle is reduced by its passage through matter, the α particles reaching the surface of a *thick* layer of radio-active matter must have all velocities up to the initial velocity of expulsion of the swiftest α particle. It is consequently to be expected that the particles in a pencil of α rays from a thick layer should be unequally deflected both by a magnetic and an electric field—a result observed experimentally*. The photographic effect† of the α rays, using ordinary plates, falls off rapidly as the velocity of the α particles is reduced.

For this reason the photographic effect of a pencil of rays from a thick layer of radium in a magnetic field is mainly confined to a range of velocities between $.6V$ and V , where V is the initial velocity of expulsion of the α particles from radium C. In practice, unless the darkening of the photographic plate is very

* Mackenzie, *Phil. Mag.* **10**, p. 538, 1905. Rutherford, *Phil. Mag.* **11**, p. 166, 1906.

† Rutherford, *Phil. Mag.* **11**, p. 553, 1906; **12**, p. 134, 1906.

intense, it is difficult to observe the photographic effect of rays of velocity lower than $\cdot 6V$.

We have already referred (section 56) to an interesting observation made by Becquerel. He observed that the trace of a pencil of α rays from a thick layer of radium in a magnetic field showed a steadily increasing curvature. He also observed later that the deflection of such a pencil of rays was not altered by placing a metallic screen over the radium. The latter result at first sight indicated that the velocity of the α particles was not altered by passing through matter*. It will be seen, however, that these apparently anomalous results receive a simple explanation when we take into account the complexity of the radiation under examination. The general arrangement of Becquerel's experiment is shown in Fig. 30.

A narrow vertical pencil of rays from the radium at R fell on a photographic plate, which was placed at right angles to the slit, and inclined at a small angle with the vertical. The apparatus was placed in a uniform magnetic field perpendicular to the pencil of rays and parallel to the slit. By reversing the magnetic field two fine diverging lines SP , SP' were observed on the plate. The distance between these lines at any point represents twice the deflection of a pencil of rays at that point. By careful measurement, Becquerel† found

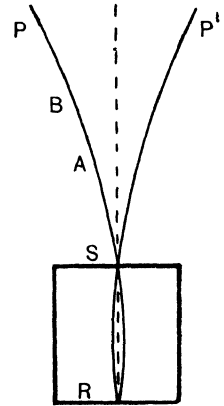

Fig. 30.

that these two diverging lines were not accurately the arcs of a circle but that the radius of curvature of the path of the rays increased with the distance from the source. This was at first ascribed to a progressive change of e/m of the α particles in their passage through the air. Bragg‡ and Rutherford§ independently showed that this peculiarity in the trace of the rays could be simply explained by taking into account the change of velocity of

* Becquerel, *C. R.* **141**, p. 485, 1905; **143**, p. 365, 1906; *Phys. Zeit.* **7**, p. 177, 1906.

† Becquerel, *C. R.* **136**, pp. 199, 431, 977, 1517 (1903).

‡ Bragg, *Phil. Mag.* **11**, p. 617, 1906.

§ Rutherford, *Phil. Mag.* **11**, p. 166, 1906.

the α particle in passing through matter, without any assumption of the alteration of the value of e/m . Consider, for example, the outside edge of the trace at a point A . The photographic effect at this edge of the trace is due to the particles of lowest velocity which are just able to produce a detectable photographic action at A . Consider next the point B further removed from the source. The α particles which produce the edge of the trace have the same velocity as in the first case; but since they have had to travel through a greater distance of air they must have initially started with a greater velocity. The average velocity of these α particles along their path RB is consequently greater than in the first case, and the outside edge would be deflected through a smaller distance than would be expected if the average velocity were the same for the two paths RA , RB . Consequently the trace of the rays will show evidence of steadily increasing radius of curvature as we proceed from the source. An opposite effect is produced on the inside edge of the trace, for this is produced by the swiftest α particles from radium, viz. those emitted from radium C. Since the velocity of these particles decreases in their passage through the air the inside edge will show evidence of decreasing radius of curvature. This will have the effect of contracting the natural width of the trace. This effect is, however, small and tends to be masked experimentally by the scattering of the α particles in their passage through air.

Let us now consider the effect of placing a thin sheet of matter over the radium. The photographic effect at the outside of the trace is due to α particles of the same velocity as before; not, however, by the same α particles but by another set whose velocity has been diminished to the same amount in their passage through the absorbing screen. The radius of the curvature of the trace at A would consequently be unaltered by the interposition of the absorbing screen. The explanation of this apparent paradox is thus seen to follow necessarily from the fact that the α particles are reduced in velocity in passing through matter.

A discussion of these effects has been given on account of their intrinsic interest and the part they played in the development of our knowledge of the α rays. It must be borne in mind that the photographic effects due to a complex pencil of α rays, under

ordinary experimental conditions, are confined to particles of a comparatively narrow range of velocity. There is usually some photographic effect due to the β and γ rays, or to other causes, and this in practice tends to obscure the weak photographic effect of the more slowly moving α particles. The apparent sharpness of the trace for a complex pencil of rays is to a large extent illusory, and it is desirable to interpret such photographic results with great caution.

66. Absorption of α rays. The absorption of α rays by matter was initially investigated by using a thick layer of radioactive material spread over a plate, and examining the variation of the saturation current between this plate and another placed parallel to it when successive screens were placed over the active matter. Experiments of this kind were made by Rutherford, who showed that the ionisation current decreased approximately according to an exponential law with the thickness of matter traversed. It was found that the absorption of α rays varied for different materials. It was greatest for the rays from uranium, and least for the radiation from the active deposit of thorium. The experiments showed that the ionisation fell off rapidly with increase of distance from the active plate, and was mainly confined to a range of a few centimetres from the active surface. The decrease of the ionisation with thickness of aluminium is shown in Fig. 31 for a number of active substances. By diminishing the pressure of the gas the range over which ionisation was observed increased inversely proportional to the pressure of the gas. Measurements of the absorption of α rays by these methods have been made by Rutherford*, Owens†, Rutherford and Miss Brooks‡, Meyer and Schweidler§, and others. It was natural at first to suppose that the α rays, like the cathode rays, would be absorbed according to an exponential law. It will be seen, however, that these results tended to mask the true character of absorption of the α rays.

* Rutherford, *Phil. Mag.* **47**, p. 109, 1899; **49**, p. 161, 1900.

† Owens, *Phil. Mag.* **48**, p. 360, 1900.

‡ Rutherford and Miss Brooks, *Phil. Mag.* **4**, p. 1, 1902.

§ Meyer and Schweidler, *Wien Ber.* **115**, p. 713, 1906.

Some experiments on the absorption of the α rays were made in a different way by Mme Curie* using a thin film of polonium as a source of radiation. The rays from polonium passed through a hole in a metal plate covered with a wire gauze or thin sheet of metal, and the ionisation current was measured between this plate and a parallel plate placed 3 cms. above it. No appreciable current was observed when the polonium was 4 cms. below the hole, but as this distance was diminished beyond a certain value the current increased very rapidly, so that for a small variation of distance there was a large alteration in the current. This rapid

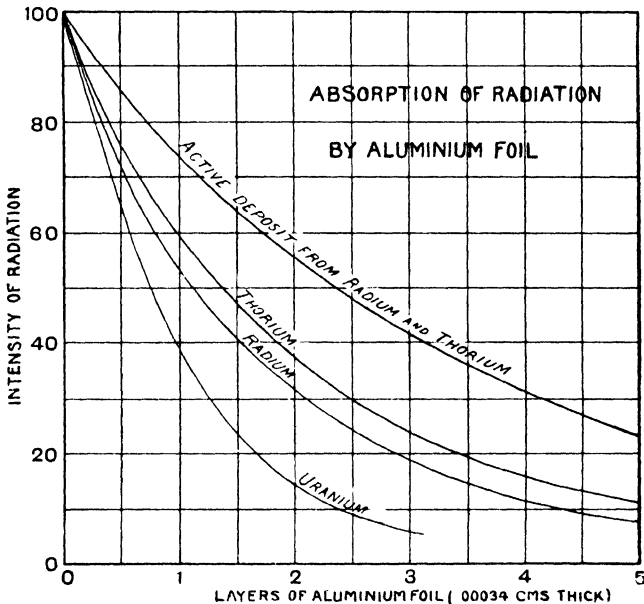

Fig. 31.

increase of the current suggested that the ionising property of the α rays ceased suddenly after traversing a definite distance in air. By placing a layer of metal foil over the polonium this critical distance was diminished.

In 1904 the question of the absorption of the α rays was attacked by Bragg and by Bragg and Kleeman†, and the interesting

* Mme Curie, *C. R.* 130, p. 76, 1900.

† Bragg, *Phil. Mag.* 8, p. 719, 1904; 10, p. 600, 1905; 11, p. 617, 1906.
Bragg and Kleeman, *Phil. Mag.* 8, p. 726, 1904; 10, p. 318, 1905.

experiments made by them have thrown a great deal of light on the ionisation by the α rays, and on the laws of their absorption by matter.

In order to account for their experimental results, a simple theory of absorption was formulated. On this theory all the α particles from a thin layer of radio-active matter of one kind are projected with equal velocities and pass through a definite distance in air before complete absorption. The velocity of the α particle decreases in its passage through the gas in consequence of the expenditure of its energy in ionising the gas. This range of the α particle varies for each α ray product on account of the differences in the initial velocities of projection of the α particles. If an absorbing screen is placed in the path of the rays, the velocities of the α particles from a simple product should all be diminished by the same amount, and the range in air of the emerging particles reduced by a definite amount depending on the thickness and atomic weight of the screen.

The main conclusions of Bragg have been confirmed later by direct experiment. It has been shown definitely that the α particles from a simple product are expelled with identical velocity, and that this velocity is reduced by a definite amount in passing through matter. Provided the measurements are made some distance from the end of their range, it has been shown by the scintillation method that the α particles are unchanged in number, although reduced in velocity after traversing an absorbing screen.

In order to investigate the ionisation of the α particles along their paths an apparatus similar to that shown in Fig. 32 was employed by Bragg. A narrow pencil of rays from a source R passes into a shallow ionisation vessel AB through a wire gauze A . The current between A and B at various distances from the source is measured by an electrometer. Since all the α particles in a narrow pencil of rays pass into the ionisation chamber, the variation of the current with distance affords a

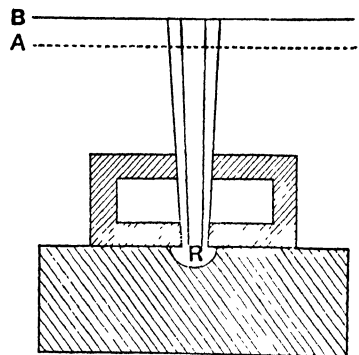

Fig. 32.

direct measure of the ionisation produced by the α particles at different points of their path in air. Using a thin layer of radioactive matter of one kind, it was found that the ionisation per centimetre of path increases from the source, passes through a maximum and then falls rapidly to zero. Typical ionisation curves for radium itself (Bragg) and for radium C (McClung)* are shown in Fig. 33, where the abscissae represent the current

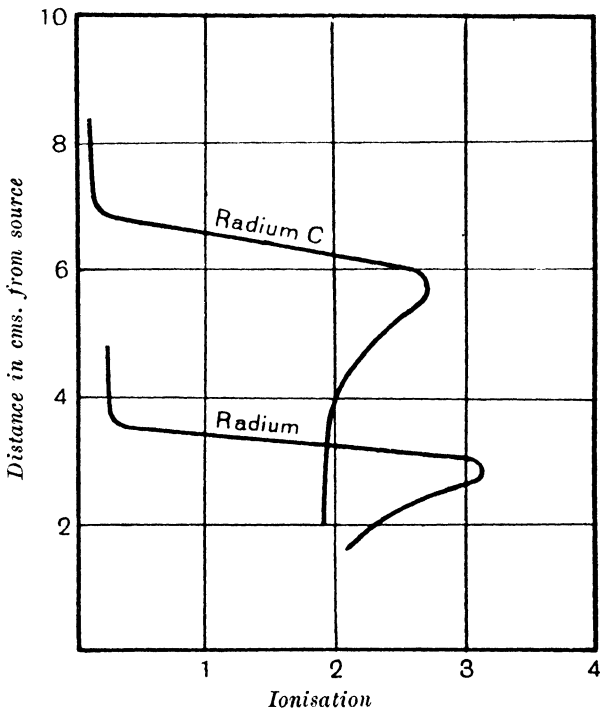

Fig. 33.

observed and the ordinates the distance in air from the active matter. The incline of the ionisation curve near the end of the range of the α particles and the sharpness of the maximum depend to some extent on the depth of the testing vessel and on the angle of the cone of rays. Using a broad cone of rays, the maximum is less marked and the incline less steep. A very strong electric field is required to produce saturation, especially near the knee of the ionisation curve.

* McClung, *Phil. Mag.* 11, p. 131, 1906.

The shape of the ionisation curve is typical for all radio-active products. For example, the ionisation curve due to a thin film of radium itself, the α particles of which have a range of 3.50 cms. in air, is identical with that part of the curve of radium C measured from a distance 3.5 to 7.0 cms. In other words the α rays from radium show the same velocity and produce the same ionisation as the rays from radium C after passing through 3.5 cms. of air. In cases where no β rays are emitted from the product, the current in the testing vessel falls to zero at the end of the range. If β and γ rays are present there is always a small residual ionisation which remains approximately constant as the testing vessel is moved beyond the range of the α particles.

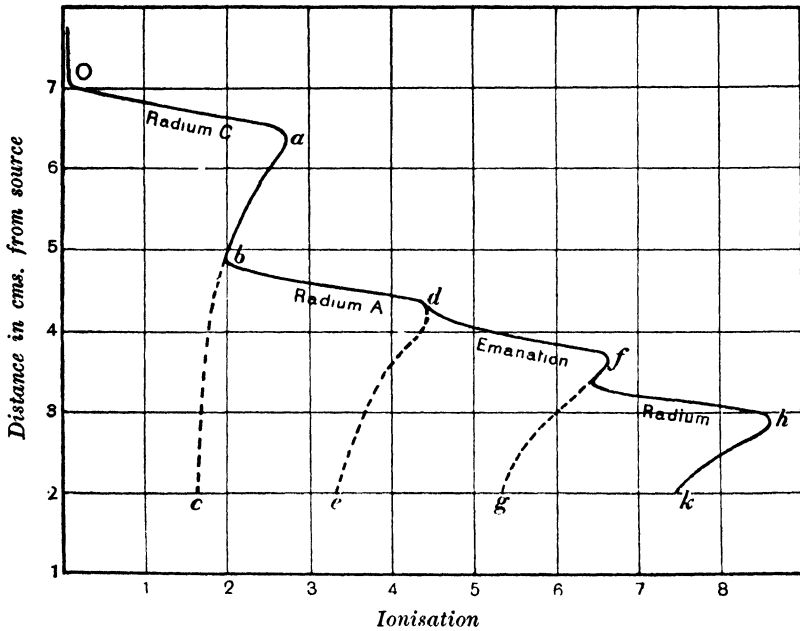

Fig. 34.

Bragg and McClung showed that the range of a given set of α particles in air was reduced by about an equal amount by placing successively thin layers of foil of the same thickness over the source. Bragg and Kleeman have determined the range of the α rays from the different α ray products present in a thin film of radium in radio-active equilibrium, viz. radium itself, the

emanation, radium A and radium C. The results obtained are shown in Fig. 34. The first α particles entered the testing vessel at a distance of 7.06 cms. from the source. These rays were emitted from radium C and have the greatest range of all the rays from radium products. At the point *b* the curve suddenly turns through an angle, showing that at this angle the α rays from another product whose range is 4.83 cms. have entered the testing vessel. There is a similar though not so well-defined break in the curves at *d* and *f* for ranges 4.23 and 3.50 cms. respectively. It has been found that the α rays of range 4.83, 4.23, 3.50 cms. belong respectively to radium A, the emanation, and radium itself.

If the curve *ab* is produced downwards to *c*, the curve *oabc* represents the ionisation due to radium C alone at different distances from the source. Suppose the ordinates of the curve are lowered through a distance 2.23 cms., corresponding to the difference in range between 7.06 cms. and 4.83 cms., and the abscissae of the two curves added together. The resultant curve *bde* lies accurately along the experimental curve *bd*. If the curve be again lowered through a distance 6.0 mms., corresponding to the difference of range for the next products, and a similar addition be performed, the resulting curve *dfg* again lies on the experimental curve. Finally if the curve is lowered through 7.3 mms., it is similarly found that the theoretical curve lies on the experimental curve *fhk*.

Knowing the ionisation curve of one product, the experimental curve for the combined products can thus be built up from it in a very simple way. Such a result shows clearly that, allowing for the differences in the initial velocities of projection, the ionisation curves for radium and each of its products are identical. It also shows that the same number of α particles are projected per second from each of the α ray products. This result follows from the disintegration theory if the various products are successive and in equilibrium, provided each atom emits one α particle during its transformation.

The results of Bragg and Kleeman have thus confirmed in a novel and striking way the theory of successive changes, initially developed from quite distinct considerations. They show that the

products are successive, for otherwise the experimental curve could not be built up from consideration of the ionisation curve of one product alone.

The curves so far considered refer only to thin films of radioactive matter where the α rays from each product escape with identical velocity and suffer no loss of range in traversing the active matter itself. The shape of curve obtained in a similar way with *thick* layers of active matter is quite different. In such

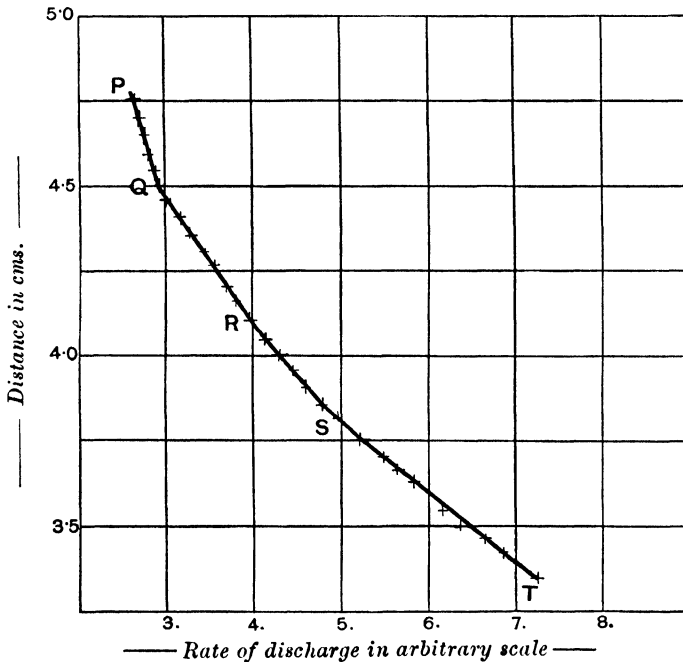

Fig. 35.

cases, the radiation at any point of the pencil is heterogeneous and consists of α particles moving over a wide range of velocities. Examples of such ionisation curves for a thick layer of radium have been given by Bragg. The curve (Fig. 35) consists of a number of approximately straight lines with fairly well-defined points of intersection. Beyond *Q* the ionisation is due to α rays from radium C alone. At *Q* the ionisation due to radium A adds its effect. A similar break is observed at *R* and *S* where the α rays from the two other products enter the testing vessel. The

shape of these curves can be deduced from a knowledge of the ionisation curve for a thin film.

67. Ionisation due to one α particle. Geiger* made an accurate determination of the variation of the ionisation of the α particle at various points of its range. The α rays from a point source of radium C passed through a small opening covered with a thin sheet of mica, and the ionisation between two parallel

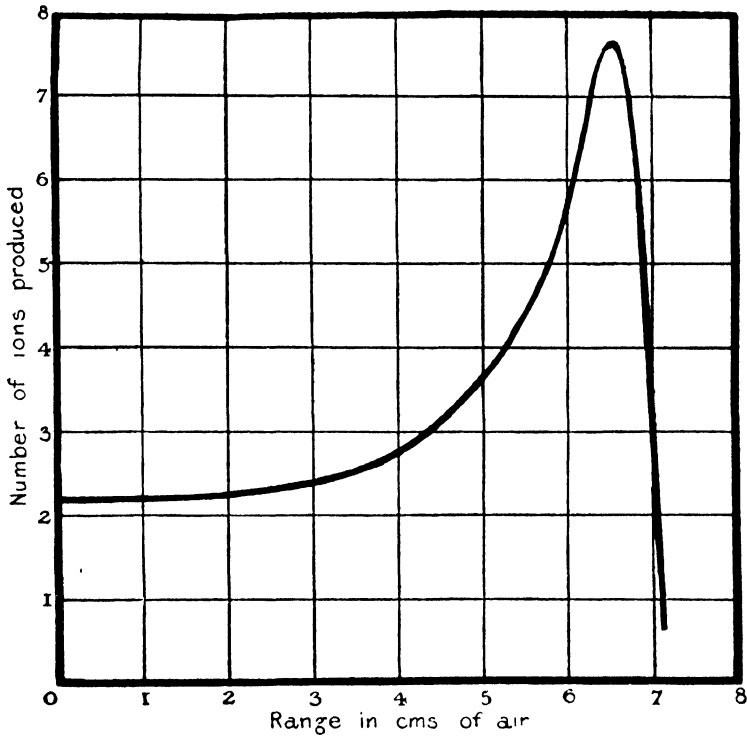

Fig. 36.

plates was measured in a second vessel containing hydrogen at diminished pressure. This corresponded to a very shallow testing vessel. By altering the pressure of the air between the source and the opening, the ionisation was determined corresponding to various points of the range. The curve obtained is shown in Fig. 36.

* Geiger, *Proc. Roy. Soc. A*, **82**, p. 486, 1909.

By measuring the ionisation produced by a definite number of α particles, Geiger has determined the total number of ions produced in hydrogen by complete absorption, and found it to be 2.37×10^5 . The ionisation per millimetre of path at atmospheric pressure and 12° C. for the α particles from radium C is shown in the following table.

Distance from source in cms.	Number of ions per mm. of path
1	2250
2	2300
3	2400
4	2800
5	3600
6	5500
6.5 (about)	7600
7 ,,	4000

Each square of the curve shown in Fig. 36 represents 10,000 ions. The number of ions produced within any part of the range can therefore be deduced at once.

Knowing the range of the α particles from the various α ray products of radium, the total ionisation due to an α particle from each can be deduced from the curve. The results are included in the table given in section 70. It will be seen from section 69 that the ionisation due to an α particle of range R should be proportional to $R^{\frac{3}{2}}$.

It will be seen that the ionisation curve was determined by Geiger in hydrogen on account of the greater ease of obtaining a saturation current in that gas. Later, however, Taylor* showed that the ionisation curves in air and hydrogen are somewhat different. The curves obtained by him are shown in Fig. 37. The pressure of the air was reduced so as to give exactly the same range as for hydrogen at standard pressure. It will be seen that the ionisation in hydrogen is less initially than in air, but the curves intersect and the maximum is more pronounced in hydrogen. Taylor showed by integrating the curves that the total ionisation produced in hydrogen was about equal to that in air, a result which had been independently obtained by different methods by

* Taylor, *Amer. Jour. Sci.* 28, p. 357, 1909; *Phil. Mag.* 21, p. 571, 1911.

Rutherford and Bragg. There appears to be little doubt from the work of Taylor that the ionisation curves will vary somewhat in shape for different gases, and that the ionisation per centimetre of path will show less variation for gases of heavy atomic weight. The reason of these differences will be seen from the discussion in section 71. On account of the differences in the ionisation curve in air and hydrogen, it is probable that the maximum of the ionisation curve observed by Geiger (Fig. 36) is somewhat more

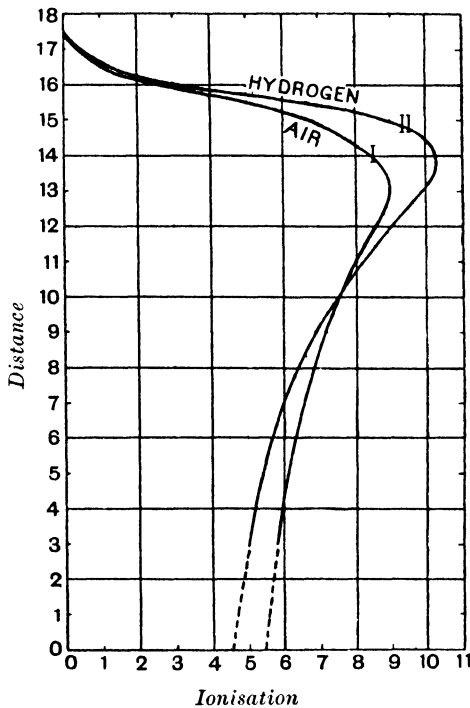

Fig. 37.

pronounced than it would be in air, and that the relative number of ions per millimetre of path given for air are slightly in error.

Since one gram of radium at its minimum activity emits 3.4×10^{10} α particles per second, the total ionisation current due to a thin film containing one gram of radium in which half the α particles produce ionisation is equal to 1.21×10^6 e.s. units, or 4.0×10^{-4} amperes. Geiger (*loc. cit.*) has pointed out that this number may be useful in estimating small quantities of radium.

It must be remembered, however, that the number given above refers to the saturation current. This current is difficult to obtain in practice unless a very strong electric field is applied or unless the ionisation is measured under reduced pressure.

68. Explanation of the ionisation curve. We have seen that the ionisation per centimetre of path due to a pencil of α rays increases at first slowly as we pass from the source, then more rapidly to a well marked maximum, and then decreases rapidly to

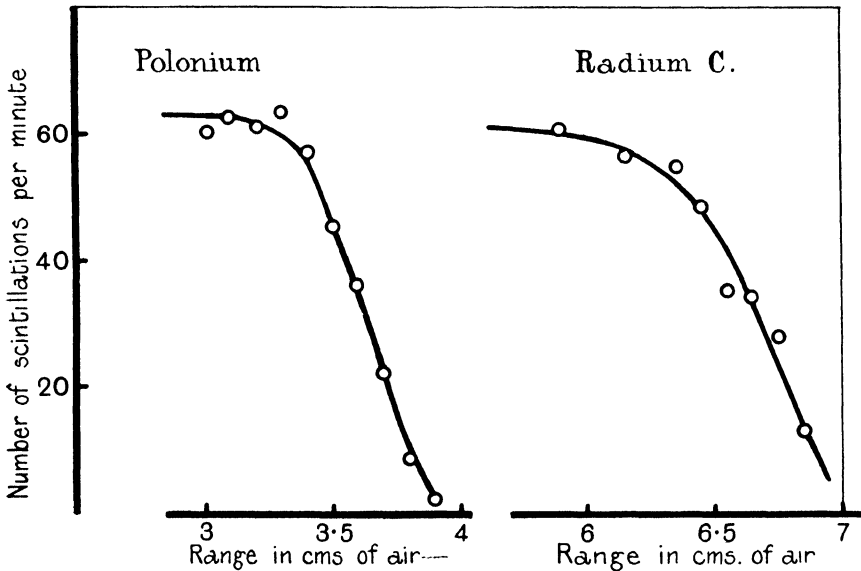

Fig. 38.

zero. It is now necessary to consider the explanation of this characteristic curve of ionisation due to a pencil of α rays. It has been definitely proved that the α rays from a simple product are expelled initially with the same velocity. Regener and Geiger by the scintillation method have shown that the number of α particles at first remains constant when successive sheets of absorbing matter are placed in the path of the absorbing rays, but decreases rapidly at the end of the range of the α particle. Aschkinass*

* Aschkinass, *Verh. d. D. Phys. Ges.* 10, p. 953, 1908; *Ann. d. Phys.* 27, p. 377, 1908.

and also Greinacher* found that the α particles retained their charge to the end of their path and that the charge carried by them fell off near the end of the range in a similar way to the ionisation of the gas. The decrease in the number near the end of the range has been investigated in detail by Geiger† by the scintillation method, using a very narrow pencil of rays. He found that the number commenced to decrease about one centimetre from the end of their path in air, and rapidly decreased to zero.

The experimental results are shown in Fig. 38 using narrow pencils of rays from polonium, range 3.86 cms., and of radium C, range 7.06 cms., as a source of rays. This decrease in number is probably to be ascribed to the scattering of the α particles in their passage through the gas. This scattering not only causes inequalities in the actual distance traversed by the α particles but probably gives rise to small changes of velocity for particles that have traversed the same distance (see section 74).

On this view, it is seen that the distance where the ionisation ceases, viz. 7.06 cms. for radium C, marks the greatest range, while the *average* range of the particles is about 6.7 cms. This diminution in the number of α particles near the end of their path offers a reasonable explanation of the rapid decline in the ionisation curve. This decline of the curve is always observed however narrow the pencil of rays or however shallow the ionisation chamber.

It has been shown previously in section 64 that at a distance x from the source, the velocity V of an α particle passing through air can be represented very closely by the equation $V^3 = a(R - x)$ where a is a constant and R the maximum range of the α particle. In comparing this equation with the experimental results, R was taken as 7.06 cms. From the manner in which the observations were made it is clear that the results give the change of velocity of the α particle which happens to travel the maximum range. For comparison, however, with the ionisation curve it is desirable to express R in terms of the average range, viz. 6.7 cms. It is natural to suppose that the ionisation produced by an α particle per unit path is proportional to the energy absorbed. The change

* Greinacher, *Verh. d. D. Phys. Ges.* **11**, p. 179, 1909.

† Geiger, *Proc. Roy. Soc. A*, **83**, p. 505, 1910.

of energy dE of the α particle in the distance dx after traversing a distance x is given by

$$\frac{dE}{dx} = \frac{K}{(R - x)^{\frac{1}{2}}} = \frac{K_1}{V} \dots\dots\dots(1),$$

where K and K_1 are constants.

The ionisation is thus inversely proportional to the velocity of the α particle, or in other words is directly proportional to the time taken to cross the atom. It also follows directly by integration that the total ionisation due to an α particle of range R is proportional to $R^{\frac{3}{2}}$. From the above considerations, it is obvious that the equation expressing the connection between the velocity and the distance can be deduced by assuming the relation given in equation (1) and the proportionality between ionisation and expenditure of energy. Supposing that the ionisation per unit path is inversely proportional to the velocity, it follows that the ionisation due to an α particle should increase rapidly near the end of its path and then fall suddenly to zero. No doubt this relation will not hold accurately to the very end of the path. It seems more probable that the ionisation will increase to a definite maximum when each collision produces ions and then stop almost abruptly when the velocity falls below a certain critical value. The curve for a pencil of α rays will be different from that of a single α particle, since there are inequalities in the number and velocity of the α particles near the end of their range. The actual curve will be built up of a great number of similar curves, grouped about the curve of average range. Geiger has shown that the resultant curve built up in this way will be very similar to that observed experimentally. The theoretical curve for a single α particle from radium C of average range 6.7 cms. is shown in Fig. 39 by the full curve. The dotted line represents the resultant ionisation curve for a distribution of α particles such as is shown in Fig. 38.

Energy required to produce an ion. From the data already given, the energy required for production of a pair of ions by an α particle can be simply deduced. We have seen that an α particle from radium C, which has a kinetic energy of 1.31×10^{-5} ergs,

produces 2.37×10^5 ions. From this it follows that the energy required to produce a pair of ions is 5.5×10^{-11} ergs. This corresponds to the energy required by the fundamental unit of charge in moving freely between two points of potential difference 35 volts. It seems not improbable that about the same energy is required to produce an ion in the case of β and γ rays. If the energy of a particle in traversing a gas is mainly used up in producing ions, conversely it is possible to deduce the energy of

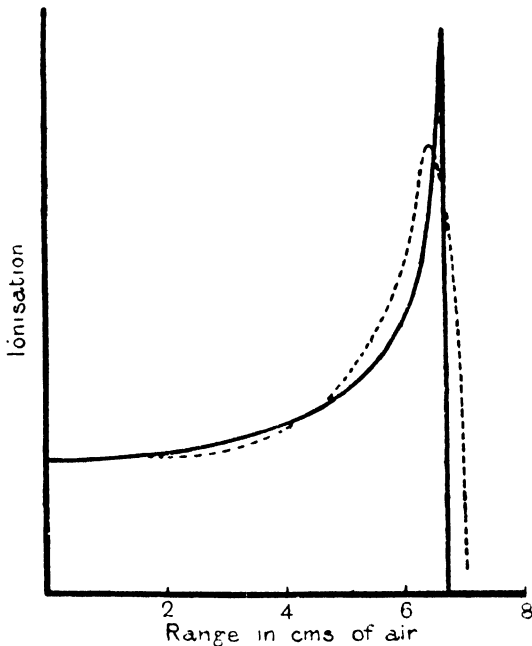

Fig. 39.

the radiation by determining the total ionisation produced by the complete absorption of the radiation.

69. Decrease of ionisation with distance from a uniform sheet of radio-active matter. It is sometimes of importance to deduce the decrease of ionisation with distance from a plane uniform sheet of radio-active matter. We shall first consider the case of a large plane sheet covered uniformly with a thin film of radio-active matter which emits α particles of definite range R in the gas under consideration. Suppose N α particles are emitted

in the upward direction from each square centimetre of surface, and that these α particles escape equally in all directions. The number which passes between two cones making angles θ and $\theta + d\theta$ with the normal is $N \sin \theta d\theta$.

Consider the ionisation in the space above a plane $A'B'$ parallel to AB and distant d from it (Fig. 40). After traversing the gas in the direction θ , the range of the particles issuing through $A'B'$ is $R - d \sec \theta$. Supposing that the ionisation at any point of the path is inversely proportional to the velocity, it follows that the total ionisation due to an α particle of range R is proportional

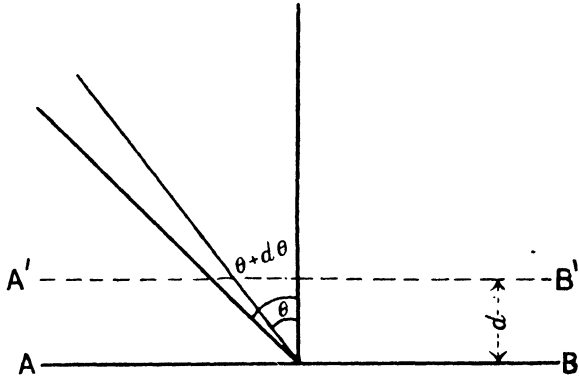

Fig. 40.

to $R^{\frac{2}{3}}$. The ionisation I_d produced above the plane $A'B'$ is consequently given by

$$\begin{aligned} I_d &= KN \int_0^{\cos^{-1} d/R} \sin \theta (R - d \sec \theta)^{\frac{2}{3}} d\theta \\ &= KN \left[b^2 + \frac{d}{a} \log \frac{a-b}{d^{\frac{1}{3}}} + \frac{2d}{\sqrt{3}a} \tan^{-1} \frac{\sqrt{3}b}{2a+b} \right], \end{aligned}$$

where K is a constant; $R = a^3$, $R - d = b^3$.

The total ionisation I_0 when $d = 0$ is

$$I_0 = KNa^2.$$

The ratio I_d/I_0 can thus be at once deduced for any value of d .

This relation should hold more accurately if the value of R is taken as the average rather than the maximum range of the α particle.

Calculations of this character have been given by Bragg but, in the older calculations, the relation assumed between velocity and ionisation was different from that considered here. The results show that the ionisation initially decreases with the distance d approximately according to an exponential law, but falls off more rapidly than this near the end of the ionisation curve.

The calculations given above refer also to the case where a uniform absorbing screen is placed over the active matter. In this case d refers not to the thickness of the screen but to its stopping power of the α particle in terms of the gas above it.

In a similar way calculations can be made for a *thick* layer of radio-active matter, but the expression is of a very complicated form. It is of interest to note that the total ionisation due to thick layers of radio-active matter of different kinds is approximately proportional to R^2 when R is the range of the α particles emitted.

70. Range of α particles. The maximum range of ionisation of an α particle from a simple product is a constant for a definite pressure and temperature of the gas. This range varies inversely as the pressure of the gas, and directly as its absolute temperature. The value of the range depends upon the absorbing gas in the manner discussed in Section 71. It has been usual to express the range of the α particles from various products in terms of air at standard pressure and laboratory temperature of about 15°C . Measurement of the ranges of the α particles from radium were first made by Bragg and Kleeman* by the electric method, and a similar method has been employed by Hahn for the α ray products in thorium and actinium. In some cases, the scintillation method has been used, for it is found that the scintillations disappear at a point corresponding to the end of the range of the α particles. Since the scintillation method is not quite so sensitive as the electric method, it gives a value of the range one or two millimetres less than the latter.

Bragg's method is very suitable for determining the range of the particles emitted by very active material where a narrow and intense pencil of α particles can be used. Measurements by

* Bragg and Kleeman, *Phil. Mag.* **10**, p. 318, 1905.

this method have been made by Bragg and Kleeman* for radium and its products, by Hahn† for the active deposits of thorium and actinium, and by Levin‡ and Kucera and Masek§ for polonium. The range of the α particles from ionium has been determined by Boltwood|| by the scintillation and electric methods. In the case of weak radio-active substances like uranium and thorium the electrical effects are too small to employ Bragg's method. The range of the particles can, however, be deduced by determining the decrease of the ionisation when successive layers of aluminium or other foils are placed over a layer of the active material. This method has been employed for uranium and thorium by Bragg¶, and for uranium by Geiger and Rutherford**. The latter method is not very satisfactory; but Geiger and Nuttall†† have devised a simple method for the determination of the range of the α particle from all kinds of active matter, provided they are not gaseous, when only weak activities are available. The general arrangement is shown in Fig. 41. The active material is placed in the centre of a bulb on the small metal disc *B*, which is connected to the electrometer by means of the wire *H*. The bulb is spherical and of 7.95 cms. radius. The saturation current is measured for different pressures. For low pressures the current is found to vary nearly proportionally with the pressure; but when the pressure reaches a value such that the α particles are completely absorbed in the gas, the current reaches a maximum value and there is no further change with increase of pressure. In order to obtain the best results, the active

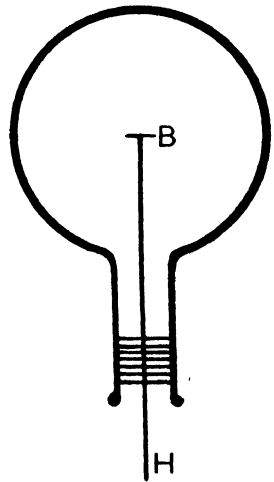

Fig. 41.

* Bragg and Kleeman, *Phil. Mag.* 10, p. 318, 1905.† Hahn, *Phys. Zeit.* 7, p. 456, 1906; *Phil. Mag.* 12, pp. 82, 244, 1906.‡ Levin, *Phys. Zeit.* 7, p. 519, 1906.§ Kucera and Masek, *Phys. Zeit.* 7, p. 337, 1906.|| Boltwood, *Amer. Journ. Sci.* 25, p. 365, 1908.¶ Bragg, *Phil. Mag.* 11, p. 754, 1906.** Geiger and Rutherford, *Phil. Mag.* 20, p. 691, 1910.†† Geiger and Nuttall, *Phil. Mag.* 22, p. 613, 1911.

matter should be in the form of a thin film of a few millimetres diameter. Examples of results obtained are shown in Fig. 42 where the ordinates represent the ionisation, and the abscissae the pressure of air in the bulb. It is seen that there is a sudden break in each curve for a definite pressure. This corresponds to the maximum range of the α particles in the gas at that pressure. Since the range of the α particles is inversely proportional to the

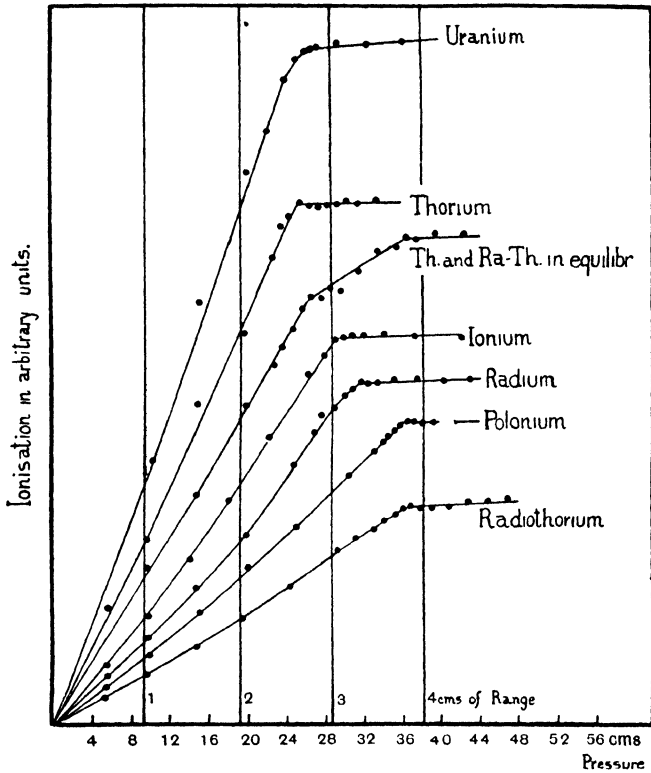

Fig. 42.

pressure, the range in air at atmospheric pressure can at once be deduced.

The ranges of the α particle from the various radio-active substances are given in the next table. In Column 2 the ranges are given in terms of air at standard pressure and temperature; in Column 3 in air at 15° and standard pressure. The latter number is convenient for practical work, but can be readily calculated from the other since the range is directly proportional

to the absolute temperature. Some observers have given the ranges at laboratory temperature and pressure, but with no information as to their exact values. The number of ions produced by the absorption of the α particle (see Section 67) is given in the last column. For convenience the initial velocity, momentum and kinetic energy of the α particle are added. The velocity V is deduced from the formula obtained by Geiger, viz.

$$V^3 = aR,$$

where R is the range, assuming that the velocity of the α particles from radium C of range 7.06 cms. at 20° C. is 2.06×10^9 cms. per second (see Section 58).

Product	Range in cms. at 0° C.	Range in cms. at 15° C.	Velocity of the α particle in cms. per sec.	Momentum of the α particle	Kinetic Energy in ergs	Whole number of ions produced
Uranium 1...	2.37	2.50	1.45×10^9	$.89 \times 10^{-14}$	$.645 \times 10^{-5}$	1.26×10^5
Uranium 2...	2.75	2.90	1.53 "	.94 "	.72 "	1.37 "
Ionium ...	2.84	3.00	1.56 "	.956 "	.746 "	1.40 "
Radium ...	3.13	3.30	1.61 "	.987 "	.794 "	1.50 "
Emanation...	3.94	4.16	1.73 "	1.06 "	.915 "	1.74 "
Radium A ...	4.50	4.75	1.82 "	1.11 "	1.01 "	1.88 "
Radium C ...	6.57	6.94	2.06 "	1.26 "	1.31 "	2.37 "
Radium F ...	3.58	3.77	1.68 "	1.03 "	.866 "	1.63 "
Thorium ...	2.58	2.72	1.50 "	.920 "	.690 "	1.32 "
Radio-thorium	3.67	3.87	1.70 "	1.04 "	.886 "	1.66 "
Thorium X	5.4	5.7	1.94 "	1.19 "	1.15 "	2.1 "
Emanation*	5.2	5.5	1.90 "	1.16 "	1.10 "	2.0 "
Thorium A	5.6	5.9	1.97 "	1.21 "	1.19 "	2.2 "
Thorium C ₁	4.73	5.0	1.85 "	1.13 "	1.05 "	1.9 "
Thorium C ₂	8.15	8.6	2.22 "	1.37 "	1.53 "	2.9 "
Radio-actinium	4.55	4.80	1.83 "	1.12 "	1.02 "	1.89 "
Actinium X	4.17	4.40	1.76 "	1.07 "	.94 "	1.79 "
Emanation...	5.40	5.70	1.94 "	1.19 "	1.15 "	2.10 "
Actinium A	6.16	6.50	2.02 "	1.24 "	1.25 "	2.27 "
Actinium C	5.12	5.40	1.89 "	1.16 "	1.10 "	2.02 "

The range of the α rays from thorium X is not yet known with certainty.

* Barratt (*Proc. Phys. Soc.* 24, p. 112, 1912) finds the ranges of the α particles from thorium emanation and thorium A to be 5.0 and 5.4 cms. respectively.

A very interesting connection between the range of the α particles from different products and their period of transformation is discussed later in Chapter XVIII.

Eve* has shown that the range of the α particles in air is altered in appreciable amount by their movement in a strong electric field, and in the direction to be expected if the α particle carries a positive charge. In these experiments, the α particle moved between two conductors charged to a potential difference of about 30,000 volts. A similar result has been observed by Reinganum†. The amount of change of range is of about the magnitude to be expected theoretically.

71. The stopping power of substances. Bragg and Kleeman‡ found that the range of an α particle in different materials was connected in a simple way with the atomic weight. They found that the "stopping power" of an atom for an α particle was approximately proportional to the square root of its atomic weight. For example, the range of the α particles in hydrogen is four times the range of the α particles in oxygen at normal pressure and temperature. Generally, in the case of metals, the weight of matter per unit area required to stop completely the α particle is proportional to the square root of its atomic weight. The stopping power was deduced from observations of the decrease of the range of the α particle in air after passing through known thicknesses of matter. The stopping powers of various atoms were compared with that of the average atom of air. Since the stopping power of the atoms of oxygen and nitrogen differ very little, the average atom of air may be assumed to have an atomic weight 14.4 and an atomic square root 3.79.

Some of the results obtained are given in the following table. The first line gives the observed stopping power s of the atom in terms of air as unity; the next line the value of the atomic weight ω and the third line the value $s/\sqrt{\omega}$.

If the stopping power is proportional to the square root of the atomic weight, the figures in the third lines should all be

* Eve, *Phil. Mag.* **15**, p. 720, 1908.

† Reinganum, *Annal. d. Phys.* **33**, p. 134, 1909.

‡ Bragg and Kleeman, *Phil. Mag.* **10**, p. 318, 1905. Bragg, *Phil. Mag.* **10**, p. 600, 1905; **11**, p. 617, 1906.

equal. This will be seen to be approximately the case. The quotient $s/\sqrt{\omega}$ is seen, however, to increase progressively for elements of light atomic weight up to aluminium.

	H	C	N	O	Al	S	Cl	Fe	Ni.
s24	.85	.94	1.05	1.495	1.76	1.78	2.29	2.44
$\sqrt{\omega}$	1.00	3.47	3.74	4.00	5.20	5.65	5.96	7.48	7.65
$s/\sqrt{\omega} \times 10^3$	240	246	251	262	287	312	299	307	319
	Cu	Br	Ag	Sn	I	Pt	Au	Pb	
s	2.46	2.60	3.28	3.56	3.44	4.14	4.22	4.27	
$\Delta\sqrt{\omega}$	7.96	8.93	10.37	10.9	11.2	13.95	14.0	14.35	
$s/\sqrt{\omega} \times 10^3$	309	291	316	326	307	297	301	298	

This rule for determination of stopping power holds also for complex molecules, provided it is assumed that the stopping power of the molecule is the sum of the stopping powers of its constituent atoms. For example, if the molecule is composed of N_1 atoms of atomic weight ω_1 , N_2 atoms of atomic weight ω_2 , etc., the stopping power of the molecule is $N_1\sqrt{\omega_1} + N_2\sqrt{\omega_2}$.

The following table shows the calculated and observed stopping power for a number of complex gases. For purposes of calculation, it is assumed that the stopping power of $H_2 = .24$, $C_2 = .85$, $O_2 = 1.03$, $Cl_2 = 1.78$ compared with the average atom of air.

	C_2H_2	C_2H_4	C_6H_6	C_6H_{12}	CH_4O	C_2H_6O
Calculated	1.09	1.33	3.27	3.56	1.41	2.08
Observed	1.11	1.35	3.33	3.59	1.43	2.00
	$C_4H_{10}O$	CO_2	CCl_4	$CHCl_3$	C_2H_5Cl	
Calculated	3.41	1.47	3.98	3.21	2.34	
Observed	3.33	1.48	4.00	3.16	2.36	

The range of the α particles from polonium was also investigated by E. P. Adams* for a number of gases. The maximum distance d in cms. between the source of radiation and a zinc sulphide screen was determined for a pressure p of the gas in cms. of mercury when the scintillations on the screen just disappeared. The value of the range pd was found to be constant for different pressures. Some of his results are given in the following table

* E. P. Adams, *Phys. Rev.* **24**, p. 108, 1907.

where $\Sigma\sqrt{\omega}$ expresses the sum of the square roots of the constituent atoms.

	H	He	A	O	Air	Pentane C ₅ H ₁₂	Nickel Carbonyl Ni(CO) ₄
Range pd	1108	954	301	269	276	77	56
$\Sigma\sqrt{\omega}$...	2.0	2.0	6.32	8.0	7.60	29.3	37.5
$pd \cdot \Sigma\sqrt{\omega}$	2216	1908	1902	2152	2098	2256	2100

The results for helium and argon are of special interest as these are monatomic gases. It will be seen that the observed ranges for these gases are about 5 per cent. less than would be expected from the square root law taking air as the standard of comparison. The range in the monatomic gas helium, atomic weight 3.99, is nearly the same as the range in the diatomic gas hydrogen, atomic weight 1.

From these results it is clear that the stopping power of a complex molecule is very approximately an additive property. Such a result indicates that the loss of energy in passing through the average molecule depends only on the number and atomic weight of its constituent atoms, and is independent of the character of the molecular grouping. Using this rule, it is possible to calculate approximately the range of the α particle in any kind of matter, whether solid, liquid, or gaseous.

In the earlier experiments by Bragg, McClung and others it was observed that in the case of a light element like aluminium, the loss of range in passing through a given thickness of matter was nearly independent of the velocity of the α particle. For example, a sheet of aluminium caused very nearly the same reduction of range of the α particle whether placed close to the source of radiation or near the end of the path of the α particle. Some later observations, however, indicated that this simple relation did not hold generally. For example, Bragg* observed that the ionisation curves for radium were somewhat different in methane than in air, and that a metal sheet placed over the radium did not cause exactly the same decrease of range for each

* Bragg and Cooke, *Phil. Mag.* **14**, p. 425, 1907. Bragg, *Phil. Mag.* **13**, p. 507, 1907.

of the sets of α particles. Kucera and Masek* made a further examination of this point and found that, for metal sheets, the loss of range in air decreased as the screen was moved away from the source of radiation. This showed that the loss of range for a given sheet depended on the velocity of the α particle. It was found that the loss of range was greater the swifter the α particle, and that the effect was most marked for atoms of high atomic weight. Bragg (*loc. cit.*) confirmed these results and showed in addition that the stopping power of a combination of two sheets of different metals altered when the sheets were reversed. For example, the loss of range due to a double sheet of aluminium and gold was slightly greater when the gold was next the source than for aluminium next the source. Bragg pointed out that this effect offers an explanation of some earlier observations recorded by Mme. Curie, where the ionisation due to a pencil of α rays was determined after passing through a combination of two metal plates. A marked difference was observed for inversion of the plates, especially near the end of the range of the α particles. Rutherford had suggested that this might be due to the presence of a secondary radiation set up by the α rays which varied for different kinds of matter. Kucera and Masek later ascribed the effect to a differential scattering of the α particles. It seems clear, however, that the effect is mainly if not entirely due to a variation of stopping power of the combination with inversion of the plates.

The question of the change of stopping power with velocity of the α particle was later investigated in detail by Taylor†. The stopping powers of different metals in terms of air were determined at various points of the range of an α particle from polonium and radium C. It was observed that the loss of range in air due to a given metal sheet decreased progressively the further it was moved from the source of radiation. The difference in range was very small for a light element like aluminium, but became very marked for a metal of high atomic weight like gold. For example, a certain sheet of aluminium showed a decrease of range equal to 1.209 cms. of air when the α particles entering the sheet had

* Kucera and Masek, *Phys. Zeit.* **7**, p. 630, 1906.

† Taylor, *Amer. Journ. Sci.* **28**, p. 357, 1909; *Phil. Mag.* **18**, p. 604, 1909.

a range of 5.7 cms. When the range of the entering α particle was 2.1 cms., the corresponding loss of range was 1.131, or a change of about 6 per cent. Under similar conditions of initial velocities of the α particles, the loss of range for a gold sheet varied from 1.375 cms. to 1.127, or a change of 18 per cent. On the other hand, a sheet of celluloid or paper showed very little change. The rate of change of the stopping power with range of the entering α particle was found to be approximately proportional to the square root of the atomic weight. Special experiments were made with hydrogen, using a cell closed by thin celluloid sheets. A converse effect was observed, for the loss of range *increased* as the speed of the entering α particle decreased. Such results indicate that there is a progressive change in the absorption of the energy of the α particle along its path as the matter changes from low to high atomic weight.

In the case of air, it has been shown that the expenditure of energy per unit path is inversely proportional to the velocity of the α particle, and that the ionisation curve for a pencil of rays is in general agreement with this result if it be assumed that the expenditure of energy by the α particle is proportional to the ionisation produced. Since the laws of absorption of the α particle hold for solids as well as for gases, it is reasonable to suppose that the energy of the α particle in passing through a metal is mainly used up in producing ions in the metal. From the observations of the change of stopping power of a sheet of metal with velocity of the α particle, it is clear that the rate of expenditure of energy with velocity of the α particle varies with the nature of the absorbing substance. If the expenditure of energy is proportional to the ionisation, it is consequently to be expected that the ionisation curve should be different for different materials. This is borne out by the results of Taylor, who found that the ionisation curve for hydrogen (see Fig. 37) differed from that of air and showed a more marked maximum in hydrogen than in air. This is to be expected from the increase of stopping power of hydrogen compared with air for decreasing velocities of the α particle.

In the case of matter of high atomic weight like mercury vapour, it is to be expected that the ionisation curve would be

more nearly constant along the path of the α particle than in the case of air. If the ionisation were constant along the path, the range R of the α particle would be connected with the velocity V by the relation $V^2 = bR$ instead of the relation found for air, viz. $V^3 = aR$. From consideration of the results obtained by Taylor, it can be calculated that the expenditure of energy per unit path in gold is more nearly in accord with the relation $V^2 = bR$ than with the latter. Such a result is to be expected when the α particle ionises each atom in its path. This condition must be nearly fulfilled in the case of metals or gases of high atomic weight.

§72. **Secondary radiations accompanying α rays.** There are two types of radiation which always accompany the emission of α particles from radio-active matter, viz. (1) *delta rays* consisting of slow speed negative electrons, large in number compared with the α particles; (2) *recoil radiation* consisting of heavy atoms of matter, usually radio-active, which escape with a positive charge and with a velocity of about 3×10^7 cms. per second. The number of these recoil atoms is always less than the number of α particles.

Delta rays. We have already referred in Section 61 to the appearance of a large number of slow speed electrons from matter traversed by the α rays, and to the consequent difficulty of measuring the charge carried by the α particles themselves. The presence of this type of radiation was first definitely proved by J. J. Thomson*, who called them the *delta rays*. A plate coated with polonium, which emits α rays but no β rays, was placed in a good vacuum close to a parallel metal plate connected with an electroscope. The rate of discharge was found to be much greater when the electroscope was charged positively than when negatively, indicating that a large number of negatively charged particles were emitted from the polonium plate. In a strong magnetic field, these particles after describing small orbits returned to the plate from which they were emitted. Under such conditions, the rate of discharge is diminished to a small fraction of its value without the field and the positive charge carried by

* J. J. Thomson, *Proc. Camb. Phil. Soc.* 13, p. 49, 1904.

the α particles could be measured. J. J. Thomson concluded that the δ rays consisted of slowly moving negative electrons, whose velocity of expulsion was about that acquired in falling through a potential difference of a few volts only. Miss Slater* showed that a similar radiation was emitted from the emanations and active deposit both of thorium and of radium. Polonium is the most suitable source of radiation for examining the conditions of emission and properties of the δ rays, the results not being complicated, as in the case of radium, by the emission of β rays. Consequently this substance has been used as a source of δ rays in most of the later researches. Experiments to estimate the velocity of emission of the δ rays from matter have been made by Ewers†, Logeman‡, Moulin§, Lattès||, and more recently by Hauser¶ and Campbell**. It must be borne in mind that the δ rays are copiously emitted not only from the active plate but from any substance traversed by the α rays whether solid or gaseous.

Consider the current between a polonium plate A and a second parallel plate B close to it in a vacuum. The variation of current with voltage between the two plates is shown in Fig. 43 taken from Logeman's paper. It is seen that the current reaches a practical maximum at about 20 volts, but its value depends on the direction of the electric field. The magnitude of the current is always greater when A is charged negatively. These results receive a general explanation by taking into account (1) the positive charge carried by the α rays, (2) the emission of δ particles from the inner surfaces both of A and B . Suppose the plates A and B are so close together that all the α particles from A are absorbed by B . Let K and K' be the average number of δ particles emitted from A and B respectively for *one* α particle. Then for no field acting, the current i_0 in the direction AB is given by $i_0 = n(E + K' - Ke)$ where E and e are the charges carried by the

* Miss Slater, *Phil. Mag.* **10**, p. 460, 1905.

† Ewers, *Phys. Zeit.* **7**, p. 148, 1906.

‡ Logeman, *Proc. Roy. Soc. A*, **78**, p. 212, 1906.

§ Moulin, *C. R.* **144**, p. 1416, 1907; *Le Radium*, **4**, p. 352, 1907.

|| Lattès, *Le Radium*, **6**, p. 97, 1908.

¶ Hauser, *Phys. Zeit.* **12**, p. 466, 1911.

** Campbell, *Phil. Mag.* **22**, p. 276, 1911; **23**, p. 46, 1912.

α and δ particles respectively and n is the number of α particles emitted per second.

When A is charged to a high positive potential, so that the δ particles from A are turned back by the electric field, the current is given by $n(E + K'e)$; similarly when A is negative, the current is given by $n(E - Ke)$. If now a magnetic field is applied so that the δ particles are prevented from escaping from either plate, the value of the charge nE carried by the α rays can

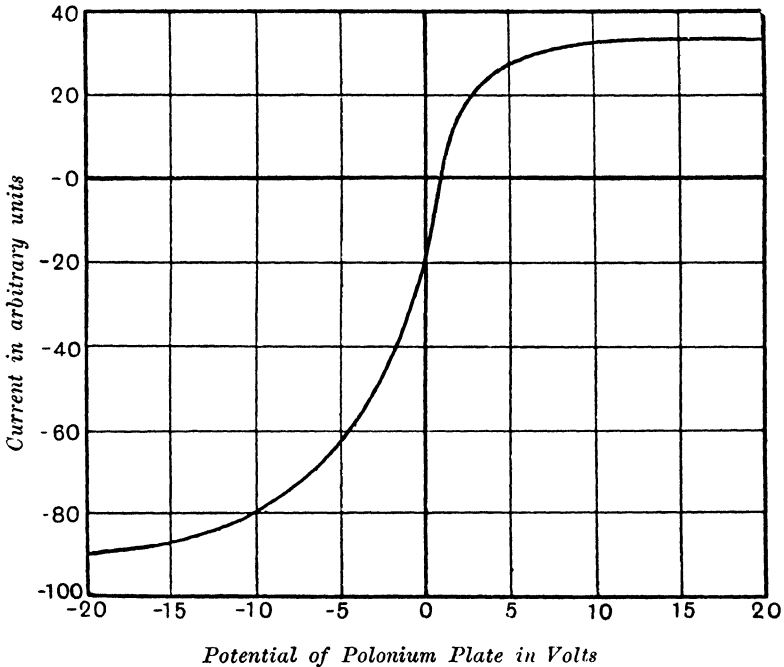

Fig. 43.

be directly measured. In this way, the value of K and K' can be measured. From the experiments of Logeman, it appears that practically all the δ particles are turned back for a potential difference of about 10 volts. This would correspond to a maximum velocity of expulsion of the electron of 1.8×10^8 cms. per second. Ewers (*loc. cit.*) deduced that the value of e/m for the δ particle was about that found for the electron and that the velocity of emission was approximately 3.25×10^8 cms. per second. In practice, however, it is doubtful whether very definite information of the

velocity of the δ particles can be deduced from curves such as that shown in Fig. 43, for Campbell has shown that the increase of current with voltage may be in part due to a dragging out of δ particles from the surface layer of the plates. Several observers have noted that the emission of δ particles from a surface is often capricious and depends apparently on the condition of the surface layer.

An estimate of the number of δ particles for each α particle from a plate coated with the active deposit of radium has been made by Duane*. He concludes that about 20 to 50 δ particles are emitted for each α particle. He also obtained some evidence that radium B, which emits only β rays, emits also a large number of δ particles.

McLennan† and Campbell have made a detailed examination of the emission of δ particles. The latter concluded that the number emitted from thin foils of aluminium, silver and gold was nearly the same. The number thus appears to be independent of the metal. His results also show that the number of δ particles emitted from a thin foil for one α particle increases with decrease of the velocity of the α particle. If the emission of δ particles is proportional to the ionisation, it is to be expected that the number of δ particles produced should vary in exactly the same way as the ionisation along the path of a pencil of α rays. This has been experimentally verified by Bumstead‡. He found that the number of δ particles emitted was independent of the material of the absorbing screens and suggested in explanation that the δ rays arise not from the metal itself but from the air film attached to its surface.

The general evidence indicates that the process of ionisation of an atom consists in the emission of a δ particle. The latter at ordinary pressure attaches itself to a molecule or group of molecules, and becomes the negative ion. The number of δ particles released by an α particle should on this view be equal to the number of ions produced. The number of δ particles emitted from metal foils indicates that on an average the δ particle must be able to escape

* Duane, *Le Radium*, 5, p. 65, 1908.

† McLennan, *British Ass. Reports*, p. 395, 1909.

‡ Bumstead, *Phil. Mag.* 22, p. 907, 1911.

from a depth corresponding to a layer of molecules from 10 to 20 in thickness. It is naturally to be expected that the δ particles escaping from a surface would have all velocities between zero and the maximum velocity.

It has always been observed that a polonium plate emits more δ particles than a metal plate on which all the α rays fall. This is to be expected if the layer of polonium, and any impurities associated with it, is more than one molecule thick. McLennan (*loc. cit.*) found that the number of δ particles from polonium deposited on different plates of metal was independent of the metal but depended only on the number of α particles emitted. In any case, there is reason to believe that the expulsion of an α particle from the radio-active atom itself liberates three δ particles, for otherwise it is difficult to explain the single positive charge carried by the recoil atoms (Section 73).

If the δ particle accompanies the act of ionisation of the atom of matter, it is to be expected from the principle of conservation of momentum that it would on the average be projected in the direction of travel of the α particle. Kleeman* found evidence of the existence of this effect by comparing the number of δ particles emitted from each side of a thin sheet of matter traversed by α rays, but the difference was not very marked. On the other hand, Campbell (*loc. cit.*) failed to detect any certain differences.

73. Recoil radiations. When a particle of mass m and velocity v is ejected from an atom of mass M , from the principle of the conservation of momentum, it is to be expected that the residual atom of mass $M - m$ would recoil with a velocity V given by $(M - m)V = mv$. Since the momentum of the α particle, ejected from a radio-active substance, is much greater than the momentum of the average β particle, it is to be expected that the velocity of recoil of the residual atom would be much greater for the expulsion of an α particle than for the expulsion of a β particle. Let us consider, for example, the case of the transformation of radium A of atomic weight 218. An α particle of mass 4 is expelled with a velocity of 1.82×10^9 cms. per second. The residual atom, radium B, has an atomic weight 214. Consequently on the

* Kleeman, *Proc. Roy. Soc.* **83**, p. 195, 1910.

principle of momentum, an atom of radium B should recoil with a velocity of 3.4×10^7 cms. per second.

Next consider the transformation of radium B into radium C, which is accompanied by the expulsion of an electron with an average speed such that $H\rho = 1300$ about. Taking the atomic weight of radium C as 214, the velocity of recoil of radium C comes out to be 5×10^4 cms. per second. This velocity of recoil is only about 1/700 of that due to the emission of an α particle; but it will be seen later that it is apparently sufficient to cause the occasional escape of an atom of radium C during the transformation of radium B.

The hypothesis of recoil was first employed to explain the distribution of the active deposit from the emanations of thorium and radium at low pressures of the gas (Section 150). At ordinary pressure, the active deposit is mainly confined to the negative electrode in a strong electric field. At low pressures of the gas containing the emanation, the active deposit is nearly uniformly distributed over the surface of the containing vessel. This was ascribed to the recoil of the carriers of the active deposit at a considerable speed in consequence of the expulsion of an α particle from the emanation. At low pressures, these carriers have sufficient velocity to reach the surface before they are stopped by collisions with the gas molecules and turned back by the electric field. It is of interest to record an experiment made by Miss Brooks* in 1904. She observed that an inactive plate placed near another coated with the active deposit of radium became active due to the deposition of radium B on the plate. This effect was most marked during the first few minutes after removal of the active plate from the emanation, and in explanation the writer suggested that the radium B was set free by recoil during the transformation of radium A.

The importance of this principle as a general method of radio-active analysis was not recognised until the striking experiments of Hahn† and of Russ and Makower‡ in 1909. Hahn showed that a number of radio-active products could be separated

* Miss Brooks, *Nature*, July 21, 1904.

† Hahn, *Verh. d. D. phys. Ges.* 11, p. 55, 1909.

‡ Russ and Makower, *Proc. Roy. Soc. A*, 82, p. 205, 1909.

in a pure state by the method of recoil. The general method employed was to place an inactive plate charged negatively near a plate covered with active matter and observe the activity imparted to it. The recoil atoms were concentrated on the negative plate showing that they carried a positive charge. The application of this method led to the discovery of several new products. For example, when a plate was placed for a few seconds near another plate coated with the active deposit of actinium, the plate on removal showed a β ray activity which decayed with a half value period of about five minutes. This radiation was shown to be due to a new product called actinium D, which is liberated by recoil in consequence of the transformation of the α ray product actinium C. In a similar way, a new β ray product thorium D was found in the active deposit of thorium. Using the recoil method, it was found that radium C must consist of at least two products. A further discussion of this important result is given in Section 198. The phenomenon of recoil was found to be quite general. Radium B was obtained by recoil from radium A, radium C from radium B, the emanation from radium, and actinium X from radio-actinium.

Russ and Makower initially made their experiments with a layer of radium emanation condensed in the bottom of an exhausted glass vessel. They found that a plate placed near became active by recoil and was coated with varying proportions of radium A, radium B and radium C. In these experiments, the recoil atoms were projected on to the plate through a vacuum and no electric field was employed. They investigated the absorption of the recoil atoms by hydrogen and air, and showed that the number of recoil atoms reaching the plate decreased approximately according to an exponential law with the pressure of the gas. Air was more effective than hydrogen in stopping the recoil atoms. The law of stopping of the recoil atoms in passing through matter has also been investigated by Wertenstein*. Radium A was used as a source of radiation and the amount of radium B obtained by recoil on a parallel plate was measured for different distances between the plates and at different pressures. The amount of radium B was found to fall off with increase of distance and

* Wertenstein, *C. R.* 150, p. 869, 1910.

pressure of the gas. The product of range of recoil atoms and the pressure measured in millimetres varied between 80 and 90. This showed that the range of the recoil atoms in air at atmospheric pressure was about $1/10$ mm.

Hahn* and Makower and Russ† both showed that radium C was obtained by recoil from radium B. This is of great interest, since radium B emits for the most part β particles of slow speed during its transformation. The fraction of the total amount of the radium C which is liberated by recoil is only about $1/6000$, while in the case of an α ray transformation like radium A or actinium C, a considerable part of the product is obtained by recoil under normal experimental conditions.

If the recoil atoms carry a charge they should be deflected in passing through a magnetic and an electric field in a vacuum. Experiments to examine this point have been made by Russ and Makower‡ and Makower and Evans§. A deposit of radium A on a fine wire was used as a source of radiation, and a pencil composed of the recoil atoms, radium B, passed through a magnetic or an electric field. The direction of deflection of the radiation measured either by the electric or photographic method showed that the recoil atoms carried a positive charge. It was found that the deflection of the recoil atoms in a magnetic field was *one half* of the corresponding deflection of the α particles emitted from radium A. Since the momentum of the recoil atom should be equal and opposite to that of the expelled α particle, this result shows that the recoil atom has *one half* of the charge carried by an α particle. This is clear from the fact that the amount of deflection in a magnetic field of a pencil of rays is proportional to the charge of the particle divided by the momentum. Since the α particles are known to carry two unit positive charges it follows that the recoil atom carries a single positive charge. Since in a gas at ordinary pressure, the recoil atoms are carried to the negative electrode, it is evident that they retain their positive charge unaltered in passing through the gas. No doubt in a weak

* Hahn, *l.c.*

† Makower and Russ, *Phil. Mag.* **19**, p. 100, 1910.

‡ Russ and Makower, *Phil. Mag.* **20**, p. 875, 1910.

§ Makower and Evans, *Phil. Mag.* **20**, p. 882, 1910.

electric field many of the recoil atoms lose their charge due to recombination, as in the case of ordinary ions. By observing the deflections of a pencil of recoil rays, both in a magnetic and electric field, the velocity and value of e/m of the recoil atoms can be deduced. Experiments on this question are still in progress; but the results so far obtained show that the value of e/m observed agrees within the limit of experimental error with the calculated value on the assumption that the recoil atom carries a single charge. For example, it has been deduced that the velocity of recoil of radium B from radium A is 3.23×10^7 cms. per second, and the value of $e/m = 49.7$. Taking the atomic weight of radium B as 12 units less than that of radium, the calculated value of e/m is 46.7 em. units.

There seems to be little doubt that this recoil method can be developed to determine with accuracy the atomic weights of a number of products which exist in too small quantity to be determined by direct chemical methods. For example, it should be possible to obtain in this way the value of e/m for the recoil atoms constituting actinium D, thorium D and radium D.

There are a number of interesting points connected with recoil phenomena which have not yet been fully investigated. The interpretation of experiments is in some cases complicated by an apparent volatility of some products at ordinary temperatures. In addition, there is some evidence that radio-active matter is torn off a plate by exhausting the air surrounding it. This effect appears to be purely mechanical, and is to be expected if the active matter is merely resting on the surface and not in close contact with it. It is to be expected that the recoil atoms on account of their slow velocity would suffer a marked scattering in passing through matter. Some evidence of this has been obtained by Makower and Russ*. It is of interest to note that notwithstanding its heavy mass the recoil atom of thorium D, for example, after it has lost its initial velocity travels through the gas in an electric field at the same rate as positive ions produced by any agency in the same gas.

* Makower and Russ, *Manch. Lit. and Phil. Soc.* 55, No. 2, 1910.

Ionisation due to recoil atoms. Townsend has shown that positive ions moving in an electric field are able to produce fresh ions by collision when their velocity exceeds a certain value depending on the gas. Since the recoil atoms are initially expelled with a velocity considerably greater than this minimum velocity, it is to be expected that the recoil atoms should ionise the gas traversed by them. This has been shown to be the case by Wertenstein* using radium A as a source of the recoil radiation. An active plate 2 cms. in diameter was placed beneath a testing vessel of parallel plates 2 mms. apart, between which the ionisation was measured. The distance between the active matter and the testing vessel could be varied and also the pressure of the gas. The effect in the testing vessel is due to the ionisation produced by the α rays plus the ionisation due to the recoil atoms. At a pressure of 5 mms. of mercury, the ionisation diminished rapidly for increase of distance between the active plate and testing vessel, from 5 mms. to 24 mms. Above this distance, the ionisation was sensibly constant, showing that the recoil atoms no longer are effective. At a pressure of 10 mms., the ionisation due to the recoil atoms disappeared for a distance of 10 mms.

The following example illustrates the type of results obtained. For a pressure of air of 3.15 mms., the ionisation in the testing vessel due to the recoil atoms was 6.5 times that of the α rays for a distance of 6.5 mms. between the plate and testing vessel. The ionisation fell to one quarter of this value for an increase of distance to 24.5 mms. at the same pressure. Since probably the number of recoil atoms liberated from the plate is about one half of the number of α particles, these results show that the heavy slow speed recoil atoms produce more than 10 times as many ions as an α particle traversing the same path. It thus appears that the recoil atom is a very efficient ioniser and in this respect resembles the α particle near the end of its range (Section 67). If the greater part of the energy of the recoil atom is expended in producing ions, it is to be expected that the recoil atom will produce about 1/50 of the total ionisation due to the corresponding α particle.

* Wertenstein, *C. R.* 152, p. 1657, 1911.

74. Scattering of the α rays. It is well known that a narrow pencil of β or cathode rays is scattered in its passage through matter, so that the pencil of emergent rays is very diffused. This scattering is so great for β rays that a considerable fraction of the β particles is returned from the plate on the side of incidence. In giving his theory of the nature of the absorption of α rays, Bragg pointed out that scattering should be much less marked for the α particles than for β particles on account of the much smaller kinetic energy of the latter. He supposed that the α particle would pursue a nearly rectilinear course passing through the atoms of matter in its path. Experiment, however, has shown that there is an undoubted small scattering of the α rays in passing through matter in general, and that the amount of this

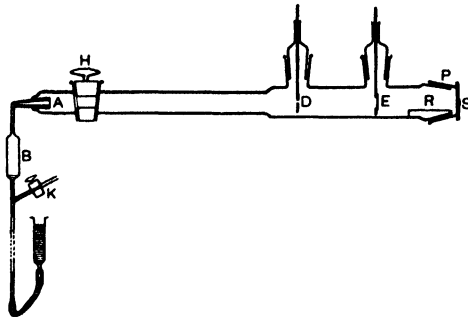

Fig. 44.

scattering increases with diminution of the velocity of the α particle. The presence of this scattering was initially shown by Rutherford* using the photographic method. In an experiment such as was described in section 57, the bands produced on a photographic plate have their edges sharply defined in a vacuum; but in air at atmospheric pressure the bands are broader and the edges more diffuse. The scattering of the α rays is easily illustrated by placing a sheet of matter over the slit in the apparatus shown in Fig. 23. The photographic trace of the pencil of rays is made much broader, and the intensity of the photographic effect fades off slowly on either side of the centre. Geiger† has made a systematic

* Rutherford, *Phil. Mag.* **11**, p. 166, 1906.

† Geiger, *Proc. Roy. Soc. A*, **81**, p. 174, 1908, and **83**, p. 492, 1910.

examination of the amount and character of the scattering of the α rays in passing through different kinds of matter. He has employed the scintillation method, which possesses many advantages over the photographic or electric method for this type of investigation. The arrangement of the apparatus is shown in Fig. 44. In these experiments it was necessary to employ a small and intense source of homogeneous α rays. For this purpose radium emanation was introduced into a conical tube *A*, closed by a thin sheet of mica, and was allowed to remain for several hours. After removing the emanation by expanding into the vessel *B*, the radiation after a short interval came almost entirely from the thin film of radium *C* deposited on the walls of the conical vessel. A narrow pencil of homogeneous rays was obtained by means of the slit *D*; the distribution of scintillations was observed on a zinc sulphide screen *S* with the aid of a microscope. Various screens could be introduced at the point *E*. In a good vacuum, a bright band of light, due to the narrow pencil of α rays, was observed on the zinc sulphide screen. On introducing a thin sheet of matter at *E*, the bright band vanished, due to the scattering of the α particles over a much greater area. The distribution of the α particles was measured by taking observations of the number of scintillations on a given area at different distances from the centre. Examples of the results obtained are given in Fig. 45. The curve *A* shows the distribution of the α particles in a vacuum, the curve *B* the distribution when the rays were scattered by passing through one gold leaf, and the curve *C* through two gold leaves. It will be seen that the density of the α particles per unit area falls off rapidly on either side of the centre.

From measurements of this kind it is possible to deduce directly the most probable angle of scattering of the rays for a given screen. This is determined by using a circular aperture and finding the distance from the centre for which the value of $2\pi r n$ is a maximum where r is the distance from the centre, and n the number of scintillations per unit area. The most probable angle θ of scattering is then given by $\tan \theta = r/l$ where l is the distance between the screen and the scattering material. For example, with a sheet of gold corresponding in its stopping power on the α particle to 3.68 cms.

of air, the most probable angle of scattering was 7 degrees. Geiger found that the angle of scattering depended greatly on the atomic weight of the scattering metal. This is shown in Fig. 46 where the ordinates represent the most probable angle of scattering and the abscissae the stopping power of the metal foil in terms of air. The angle of scattering is for small thicknesses nearly proportional to the square root of the thickness, but with thicker screens the curves, as is seen in the figure, are approximately

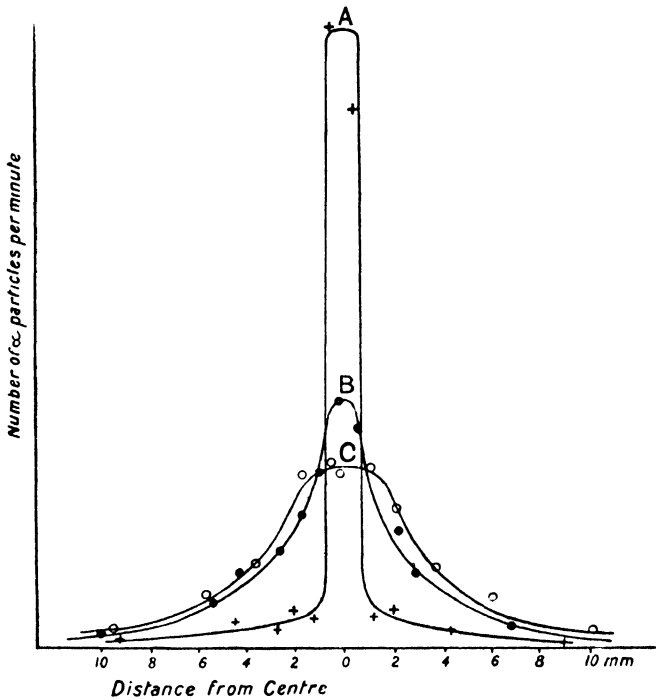

Fig. 45.

linear. This effect is due to the diminution of velocity of the α particle in passing through the screen and the consequent increase of scattering. In a special experiment, it was shown that the most probable angle of scattering is inversely proportional to the third power of the velocity of the α particle. When the change with velocity of the scattering coefficient is taken into account, the experimental curves are in good accord with those to be expected from the general laws of probability.

It was deduced that the average angle of scattering per atom of matter traversed is approximately proportional to the atomic weight.

Geiger and Marsden* observed another very striking effect. A very small fraction of the α particles are scattered through such a large angle that they emerge again on the side of incidence. The amount of this diffuse reflection increases at first with the

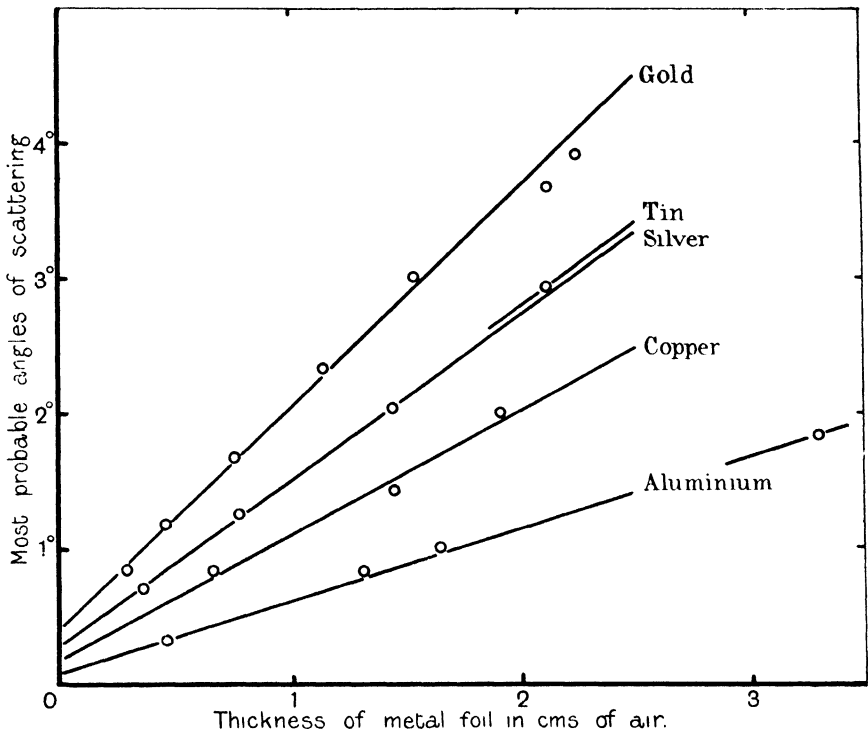

Fig. 46.

thickness of the plate on which the α particles fall, and is thus a volume and not a surface effect. The fraction of α particles thus reflected increases more rapidly than the atomic weight of the radiator, and is thus much smaller for aluminium than for gold. It is surprising, however, that, in the case of a metal of high atomic weight like gold, about half of the maximum number

* Geiger and Marsden, *Proc. Roy. Soc. A*, **82**, p. 495, 1909.

of reflected α particles is obtained from a thin sheet of gold equivalent in stopping power to about 2 mms. of air.

When radium C is used as a source of rays and platinum as a radiator, it was found that 1 in 8000 α particles incident on the plate were scattered back from the plate through more than a right angle. In making this calculation, it was assumed that the α particles were scattered back equally in all directions. Taking into account the average angle of scattering of the main pencil of α particles, it can be calculated on the laws of probability that the fraction of the particles scattered through more than a right angle should be much smaller than that observed experimentally.

To account for the experimental results, it is necessary to suppose that the atom is the seat of such intense electrical forces that occasionally the α particle can be deflected from its path through more than a right angle in an encounter with a single atom. This indicates that the atom must contain a highly concentrated charged nucleus, and that the α particle in passing through the atom close to the nucleus suffers a wide deflection of its orbit. In order to calculate the effects to be expected, the writer* has supposed that the atoms of matter consist of a central charge $\pm Ne$ surrounded by a compensating charge $\mp Ne$ distributed over a sphere of radius comparable with the radius of an atom. Assuming this central charge is concentrated at a point, it can be simply shown that the α particle describes a nearly hyperbolic orbit in passing close to the centre. The angle of deviation ϕ of the particle is given by

$$\cot \phi/2 = 2p/b,$$

where p is the perpendicular distance from the centre on the direction of initial motion of the particle, and

$$b = \frac{2NeE}{mu^2},$$

where Ne is the central charge, E the charge on the α particle, m its mass and u its velocity. Suppose a pencil of α particles falls normally on a very thin screen of matter of thickness t . Let

* Rutherford, *Phil. Mag.* 21, p. 669, 1911.

n = number of atoms in unit volume of the material. Then the probability m of entering an atom within a distance p of its centre is given by

$$m = \pi p^2 n t.$$

The chance dm of striking within radii p and $p + dp$ is given by

$$dm = \frac{\pi}{4} n \cdot t \cdot b^2 \cot^2 \phi/2.$$

Here dm is the fraction of the total number of α particles scattered through an angle ϕ . In practice the scattering is determined by counting the number of α particles falling on unit area at a constant distance r from the radiator. In this case the number y of scattered particles on unit area is given by

$$y = \frac{ntb^2 Q \operatorname{cosec}^4 \phi/2}{16r^2},$$

where Q is the number of α particles incident on the radiator. On this theory, it is to be expected that the number of α particles scattered through any angle ϕ should be proportional to

- (1) $\operatorname{cosec}^4 \phi/2$ or $1/\phi^4$ if ϕ be small,
- (2) thickness of scattering material provided this is small,
- (3) magnitude of central charge Ne ,
- (4) and inversely proportional to $(mu^2)^2$ or u^4 if m be constant.

In these calculations, it is assumed that the screen is so thin that the α particle suffers only one deflection of large angle in traversing the screen.

The correctness of these conclusions has been tested by Geiger*. By using a fine thin-walled glass tube filled with radium emanation as a source of α rays, he found that the number scattered through a given angle ϕ for gold was nearly proportional to t and varied very nearly as $\operatorname{cosec}^4 \phi/2$ over a wide range of angle. This theory serves to explain in a satisfactory way the main results of scattering observed both for α and for β rays, incident on thin screens of matter. The theory supposes that the α particle may suffer any deflection from 0° to 180° in traversing an atom, but the

* Geiger, *Proc. Manch. Lit. and Phil. Soc.* 55, Pt. II, p. xx, 1911.

probability of a large deflexion is very small. For any given angle of scattering, however, the effect of "single" scattering is more marked than "compound" scattering, i.e. the probable deflection due to a multitude of encounters where the deflection is small.

The general results indicate that the value of the central charge Ne is nearly proportional to the atomic weight of the atom, and has a value of about $100e$ for gold. If the value of N varies as the atomic weight, the theory shows that the amount of scattering for equal thicknesses varies as DA , where D is the density and A the atomic weight. For example, the scattering by gold should be about 50 times that by aluminium. This conclusion has been verified experimentally by Geiger and Marsden. If there is no loss of momentum by radiation in an atomic encounter, it is to be expected theoretically that the α particle should diminish in velocity when it is deflected by an atom. This loss of velocity for large deflections should be small for gold, but marked for aluminium and elements of low atomic weight. The effects of scattering by light atoms like those of hydrogen and helium, which are comparable in mass with the α particle, are of special interest, but have not yet been examined experimentally.

Since the high speed α and β particles undoubtedly pass through the atomic system, the law of scattering of such particles by matter affords one of the most promising methods of elucidating the structure of the atom. A further discussion of scattering in connection with β and γ rays is given in later chapters.

75. Probability variations. The rate of disintegration of all radio-active substances is expressed by a simple law, namely, that the number of atoms n breaking up per second is proportional to the number N of atoms present. Consequently $n = \lambda N$, where λ is a constant characteristic for a particular radio-active substance. E. v. Schweidler first pointed out that the rate of disintegration should follow the laws of probability, and that the value of n should be subject to fluctuations on either side of the average value which is given by $n = \lambda N$.

From the theory of probability, it is known that the absolute average error ϵ in a large number of observations for two events P and Q is given by $\epsilon = \pm \sqrt{Npq}$ where N is the number of

observations, and p and q are the probabilities for the events P and Q respectively. Applying this formula to the radio-active changes, the number of atoms breaking up during the given time τ , small compared with the half value period of the substance, is given by $\lambda\tau N$, while the number of atoms still unchanged at the end of the interval is $(1 - \lambda\tau)N$. The probability of a single atom breaking up during the time τ is $\lambda\tau$ while the probability that the same atom will exist after that time is $1 - \lambda\tau$. Consequently the absolute average error $\epsilon = \pm \sqrt{N\lambda\tau(1 - \lambda\tau)}$. Since the square of $\lambda\tau$ is small compared with $\lambda\tau$ itself, $\epsilon = \pm \sqrt{N\lambda\tau}$ or $\pm \sqrt{Z}$, where Z is the average number of atoms disintegrating during the time τ . The actual number of atoms breaking up in the time τ thus shows a deviation from the average value of magnitude $\pm \sqrt{Z}$. The absolute value of the error \sqrt{Z} increases with the number of atoms breaking up in the interval under consideration; but the relative error \sqrt{Z}/Z decreases.

In radio-active substances which break up with the expulsion of α particles, the number of α particles emitted is in most cases equal to the number of atoms breaking up. The variations from the average value should be detected by variations in the saturation current due to the ionisation by the α particles. Schweidler* calculated that these probability deviations should be easily detected for substances emitting α rays. The first experiments to test the correctness of this theory were made by Kohlrausch† by balancing the ionisation currents due to two sources of α radiation against each other, and measuring the fluctuations from the balance by means of an electrometer. Observations of a similar kind were made later by Meyer and Regener‡ by balancing the saturation ionisation current due to the source of α radiation against a Bronson resistance (Section 43). Experiments were also made independently by Geiger§ by balancing one source of radiation against another. It was important to settle initially whether the fluctuations from the balance observed experimentally

* v. Schweidler, Congrès international pour l'étude de la radiologie et de l'ionisation; Liège, 1905.

† Kohlrausch, *Wien Ber.* **115**, p. 673, 1906.

‡ Meyer and Regener, *Ann. d. Phys.* **25**, p. 757, 1908.

§ Geiger, *Phil. Mag.* **15**, p. 539, 1908.

were due to probability variations, or whether they could be ascribed to instrumental disturbances. To test this point the same pencil of α particles was arranged to pass through two separate testing vessels, and the saturation currents were balanced against each other. The disturbances from the balance were found to be small compared with those observed when two distinct sources of α radiation were employed. In addition, Geiger showed that for equal ionisations produced by the α and β rays, the disturbances observed in the latter case were much smaller than in the former. This is to be expected, since the ionisation due to a β particle is much smaller than that due to an α particle, and consequently a much larger number of β particles is required to produce the same current. Meyer and Regener, and Geiger showed that the deviations observed were of about the right magnitude to be expected on the probability theory. A complete discussion of the theory and methods of observations in these cases has been given by Campbell*.

Since the average error is \sqrt{Z} for a number of atoms Z , the ratio \sqrt{Z}/Z can be determined by electrometer observations by observing the fluctuations from the balance. Consequently, this method could be used to determine the actual value of Z . The importance of such experiments has, however, diminished on account of the development of methods for counting the α particles directly.

The probability variations are at once obvious when the number of α particles in a given short interval are counted by the electric or scintillation method. In the scintillation method, for example, it is observed that the interval between successive α particles is very variable. Examples of such probability variations have been given by Regener and by Rutherford and Geiger. It is of importance to settle whether the emission of α particles follows a simple probability law, *i.e.* whether the α particles are emitted at random both in time and space. This has been investigated by a special method by Rutherford and Geiger applying a formula worked out by Bateman†. A large number of α particles, emitted from a thin film of polonium, were counted

* Campbell, *Proc. Camb. Phil. Soc.* **15**, p. 117, 1909.

† Rutherford and Geiger, and Bateman, *Phil. Mag.* **20**, p. 698, 1910. See also E. C. Snow, *Phil. Mag.* **22**, p. 198, 1911.

by the scintillation method. The time of appearance of each scintillation was recorded on a revolving tape by pressing an electric key. About 10,000 scintillations were counted, and the number appearing in equal intervals was then deduced from the tape. Bateman showed that the probability that n α particles should appear in a given interval is given by $\frac{x^n}{n!} e^{-x}$ where x is the average number during the interval, and n may have any positive value from 0 to ∞ . The agreement between theory and experiment is shown by the following table. The number of times that 0, 1, 2, 3, etc., α particles were observed in a definite interval are given in the horizontal columns together with the calculated

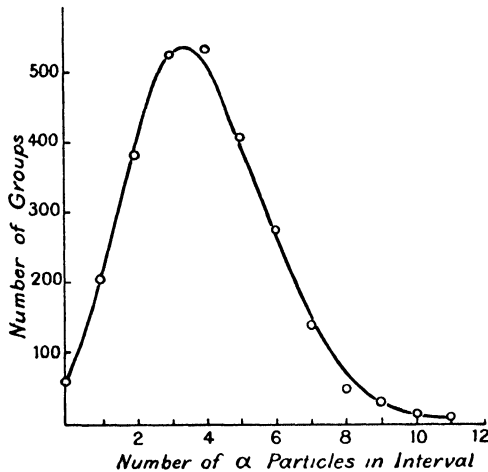

Fig. 47.

values deduced from the theory. The number of α particles counted was 10,097, and the average number appearing in the interval under consideration, namely, 1/8 minute was 3.87. These results are shown graphically in Fig. 47 where the circles represent observed numbers and the full line the theoretical curve.

Number of a particles observed in interval:

0 1 2 3 4 5 6 7 8 9 10 11 12 13 14

Observed number of occurrences :

57 203 383 525 532 408 273 139 45 27 10 4 0 1

Theoretical number of occurrences :

54 210 407 525 508 394 254 140 68 29 11 4 1 1 1

Considering the comparatively small number of α particles counted, the agreement between theory and experiment is quite as close as could be expected.

Marsden and Barratt* have used another method of comparing the distribution in time of the α particles with the theory of probability. If the *average* time between successive α particles from a constant source is $1/\mu$, the probability that no scintillation is observed on the screen in any interval t is $e^{-\mu t}$. The probability that a scintillation occurs in the interval between t and $t + dt$ is μdt . Consequently the probability of an interval greater than t and smaller than $t + dt$ is $\mu e^{-\mu t} dt$. In a large number N of intervals, the probable number of intervals larger than t and smaller than $t + dt$ is $N\mu e^{-\mu t} dt$. This deduction shows that *small* intervals are more probable than *large* ones. If a curve be plotted

Duration of interval between successive scintillations (seconds)	Number of Intervals	
	Observed	Calculated
0 to 1.0	3106	3059
1.0 to 2.0	1763	1822
2.0 to 3.0	1115	1085
3.0 to 4.0	658	646
4.0 to 5.0	389	385
5.0 to 6.0	206	229
6.0 to 7.0	130	136
7.0 to 8.0	86	81
8.0 to 9.0	42	48
9.0 to ∞	68	71

with the number of intervals as ordinates and the interval in seconds as abscissae, the curve is exponential. Marsden and Barratt have shown that this relation agrees well with experiment. Later the same authors† pointed out that this relation could be used to test the accuracy of counting scintillations, and also to correct the observed number of α particles for failures to record or detect those which follow each other within a very short time interval. The results are illustrated by the above numbers obtained from

* Marsden and Barratt, *Proc. Phys. Soc.* **23**, p. 367, 1911.

† Marsden and Barratt, *Proc. Phys. Soc.* **24**, p. 50, 1911.

an examination of the record of the scintillations on the chronograph tape in the experiments by Rutherford and Geiger previously mentioned. The number of intervals of duration greater than t_1 and less than t_2 is given by $N(e^{-\mu t_1} - e^{-\mu t_2})$.

The total number of intervals was 7564 in 14598 secs. and the average interval $1/\mu$ was 1.930 secs.

The agreement between theory and experiment is excellent and indicates that the α particles are emitted at random and that the variations accord with the laws of probability. The possibility that the disintegration of one atom influences that of another seems to be excluded.

Double scintillations.

The theory of probability given above refers to cases where each atom in breaking up emits one α particle. Geiger and

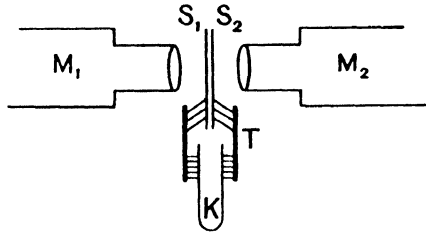

Fig. 48.

Marsden* have found in the case of certain substances that two α particles are emitted nearly simultaneously. The method of experiment is illustrated in Fig. 48. A narrow cell is formed by two zinc sulphide screens S_1, S_2 . The emanation from an actinium preparation at K diffuses up between the plates. All the α particles emitted from the emanation between the plates and the active deposit to which it gives rise fall on the zinc sulphide screen, and the scintillations are viewed by two observers with the microscopes M_1, M_2 . Each observer sees clearly the scintillations produced on one screen but not the scintillations on the other. In this way, Geiger and Marsden* showed that the scintillations

* Geiger and Marsden, *Phys. Zeit.* 11, p. 7, 1910.

from the emanation of actinium appeared as pairs, sometimes one on *each* screen, and in other cases both on *one* screen. For example, they found that the emanation, plus 10 per cent. of the active deposit, gave 66 per cent. of the total number of scintillations as doubles. Under similar conditions, the doubles observed for polonium and radium emanation varied between 0.8 and 4 per cent. of the total. These results suggested that either the atom of the actinium emanation in breaking up emitted two α particles simultaneously, or that two α ray products were present in the emanation, one of which had a half period of transformation less than $1/10$ of a second. The latter conclusion has been confirmed later by the discovery by Geiger of two successive α ray products in the emanation, the latter of which has a period of $1/500$ second. In a similar way, Geiger and Marsden found a large number of the scintillations emitted from the thorium emanation while not appearing simultaneously corresponded to doubles with a short time interval between. They concluded that two α ray products must be present, one of which had an average life of about $1/5$ second. This has been confirmed by the discovery by Geiger of a new product in the thorium emanation. The half value period was measured by Moseley and Fajans and found to be 0.14 second.

It will be seen from these considerations that a study of the distribution of α particles with regard to time has been instrumental in bringing to light a number of striking facts. The general method outlined above can be employed in all cases to settle definitely whether an atom in breaking up emits more than one α particle.

CHAPTER V.

THE BETA RAYS.

76. Discovery of the β rays. A discovery which gave a great impetus to the study of radiations from active bodies was made in 1899 by Giesel*, and confirmed shortly afterwards by Meyer and Schweidler and Becquerel and P. Curie. It was observed that the preparations of radium gave out some rays which were deviable by a magnetic field and very similar to the cathode rays produced in a vacuum tube. The initial observation of Elster and Geitel† that a magnetic field altered the conductivity produced in air by radium rays, led Giesel to examine the effect of a magnetic field on the radiations. In his experiments, the radioactive preparation was placed in a small vessel between the poles of an electromagnet. The vessel was arranged to give a pencil of rays which was approximately perpendicular to the field. The rays caused a small fluorescent patch on the screen. On exciting the electromagnet, the fluorescent zone was observed to broaden out on one side. On reversing the field, the deflection of the zone was in the opposite direction. The deviation of the rays thus indicated was in the same direction and of the same order of magnitude as that for cathode rays produced in a vacuum tube.

Meyer and Schweidler‡ showed the deflection of the rays by the alteration of the conductivity of the air when a magnetic field was applied, while Becquerel§ employed a photographic method. Curie|| found that the rays from radium consisted of two kinds,

* Giesel, *Annal. d. Phys.* **69**, p. 834, 1899.

† Elster and Geitel, *Annal. d. Phys.* **69**, p. 88, 1899.

‡ Meyer and Schweidler, *Phys. Zeit.* **1**, pp. 90, 113, 1899.

§ Becquerel, *C. R.* **129**, pp. 997, 1205, 1899.

|| P. Curie, *C. R.* **130**, p. 73, 1900.

one apparently non-deviable and easily absorbed (now known as the α rays), the other more penetrating and deviable by a magnetic field (now known as the β rays). Under ordinary conditions, the ionisation effect due to the β rays was small compared with that due to the α rays. Later investigations have shown that ordinary preparations of uranium, radium, thorium and actinium emit β as well as α rays, while ionium and polonium emit only α rays.

The β rays from a few milligrams of radium in equilibrium produce a strong phosphorescence in barium platinocyanide when brought near it. With the aid of a screen coated with this material, many of the properties of the β rays may be simply illustrated by experiments in a dark room. A quantity of radium is placed at one end of a short narrow lead tube to give a well defined pencil of β rays. The lead tube rests on a screen of barium platinocyanide, and the whole is placed between the pole pieces of a large electromagnet. When the field is excited, the rays are deflected and the screen is brightly lighted up on one side over an area elliptical in shape. The direction of deflection is reversed by reversal of the field. The complex nature of the rays is shown by the broad extent of the phosphorescence. The path of the rays at any point can be observed by placing a small metal screen in the path of the rays, and noting the positions of the shadow cast on the screen.

77. Magnetic deflection by the photographic method.

Becquerel made a very complete study, by the photographic method, of the β rays from radium, and has shown that they behave in all respects like cathode rays, which are known to be negatively charged particles moving with a high velocity. The motion of a charged ion acted on by a magnetic field has been discussed in section 29. It has been shown that if a particle of mass m and charge e is projected with a velocity u , at an angle α with the direction of a uniform field of strength H , it will describe a helix round the magnetic lines of force. This helix is wound on a cylinder of radius R , with the axis parallel to the field, where R is given by

$$R = \frac{mu}{He} \sin \alpha.$$

When $\alpha = \frac{\pi}{2}$, *i.e.* when the rays are projected normally to the field, the particles describe circles of radius

$$R = \frac{mu}{He}.$$

The planes of these circles are normal to the field. Thus, for a particular velocity u , the value of R varies inversely as the strength of the field. In a uniform field the rays projected normally to the field describe circles, and their directions of projection are the tangents at the origin.

This conclusion has been verified experimentally by Becquerel for the β rays of radium, by an arrangement similar to that shown in Fig. 49.

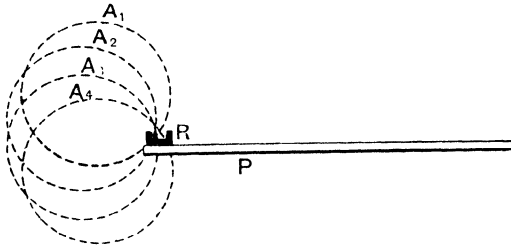

Fig. 49.

A photographic plate P , with the film downwards, is enveloped in black paper and placed horizontally in the uniform horizontal magnetic field of an electromagnet. The magnetic field is supposed to be uniform, and, in the figure, is at right angles to the plane of the paper. The plate is covered with a sheet of lead, and on the edge of the plate, in the centre of the magnetic field, is placed a small lead vessel R containing the radio-active matter.

On exciting the magnet, so that the rays are bent to the left of the figure, it is observed that a photographic impression is produced directly below the source of the rays, which have been bent round by the magnetic field. The active matter sends out rays equally in all directions. The rays perpendicular to the field describe circles, which strike the plate immediately under the source. A few of these rays, A_1 , A_2 , A_3 , are shown in the figure. The rays, normal to the plate, strike the plate almost normally, while the rays nearly parallel to the plate strike the plate at

grazing incidence. The rays, inclined to the direction of the field, describe spirals and produce effects on a line parallel to the field and passing through the source. In consequence of this, any opaque screen placed in the path of the rays has its shadow thrown near the edge of the photographic plate.

78. Complexity of the rays. The deviable rays from radium are complex, *i.e.* they are composed of a flight of particles projected with a wide range of velocity. In a magnetic field every ray describes a path, of which the radius of curvature is directly proportional to the velocity of projection. The complexity of the radiation has been shown very clearly by Becquerel* in the following way.

An uncovered photographic plate, with the film upwards, was placed horizontally in the horizontal uniform magnetic field of an electromagnet. A small, open, lead box, containing the radio-active matter, was placed in the centre of the field, on the photographic plate. The light, due to the phosphorescence of the radio-active matter, therefore, could not reach the plate. The whole apparatus was placed in a dark room. The impression on the plate took the form of a large, diffuse, but continuous band, elliptic in shape, produced on one side of the plate.

Such an impression is to be expected if the rays are sent out in all directions, even if their velocities of projection are the same, for it can readily be shown theoretically, that the path of the rays is confined within an ellipse whose minor axis, which is at right angles to the field, is equal to $2R$, and whose major axis is equal to πR . If, however, the active matter is placed in the bottom of a deep lead cylinder of small diameter, the emerging rays are confined to a narrow pencil, and each part of the plate is acted on by rays of a definite curvature.

In this case also, a diffuse impression is observed on the plate, giving, so to speak, a continuous spectrum of the rays and showing that the radiation is composed of rays of widely different velocities. Fig. 50 shows a photograph of this kind obtained by Becquerel, when strips of paper, aluminium, and platinum were placed on the plate.

* Becquerel, *C. R.* **130**, pp. 206, 372, 810, 979, 1900.

When screens of various thickness are placed on the plate, it is observed that the plate is not appreciably affected within a certain distance from the active matter, and that this distance increases with the thickness of the screen. This distance is obviously equal to twice the radius of curvature of the path of the rays, which are just able to produce an impression through the screen.

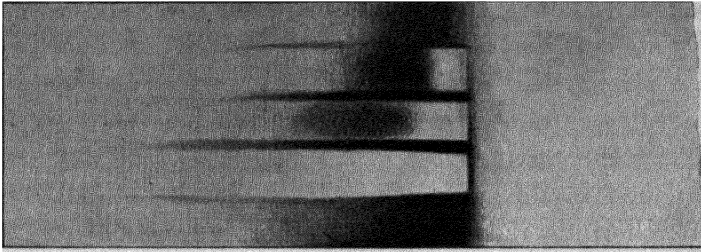

Fig. 50.

These experiments show very clearly that the most deviable rays are those most readily absorbed by matter.

79. Magnetic deflection of β rays by the electric method. The presence of easily deviable rays given off from an active substance can most readily be shown by the photographic method, but it is necessary, in addition, to show that the penetrating rays which produce the ionisation in the gas are the same as those which cause the photographic action. This can be conveniently tested in an arrangement similar to that shown in Fig. 51.

The radio-active matter A is placed on a lead block B'' between the two parallel lead plates BB' . The rays pass between the parallel plates and ionise the gas between the plates PP' of the testing vessel. The magnetic field is applied at right angles to the plane of the paper. The dotted rectangle $EEEE$ represents the position of the pole pieces. When a layer of uranium, thorium or radium

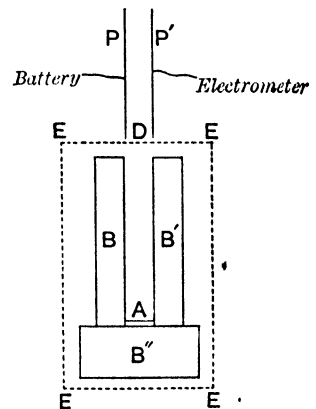

Fig. 51.

compound is placed at A , the ionisation in the testing vessel is due mainly to the action of the α and β rays. The α rays are cut off by adding a layer of aluminium $\cdot 01$ cm. thick over the active material. When the layer of active matter is not more than a few millimetres thick, the ionisation due to the γ rays is usually small compared with that produced by the β rays. On the application of a magnetic field at right angles to the mean direction of the rays, the ionisation in the testing vessel due to the rays steadily decreases as the strength of the field increases, and in a strong field it is reduced to a very small fraction of its original value. In this case the rays are bent so that none of them enter the testing vessel.

Examined in this way, it has been found that the β rays of uranium, thorium, radium and actinium consist entirely of rays readily deflected by a magnetic field.

80. Charge carried by the β rays. The experiments of Perrin and J. J. Thomson have shown that the cathode rays carry with them a negative charge, while Lenard found that they still retained this charge after passing through a thin screen of matter. When β rays, or cathode rays, are stopped in matter, they give up their negative charge, and the quantity of negative electricity communicated to the plate is a measure of the quantity of electricity carried by the absorbed particles.

The total charge carried by the β rays emitted per second from a gram of uranium or thorium is very small, and can only be detected by very delicate measurements. Using a milligram of radium, the charge carried by the β rays from it can be measured easily by an electroscope or ordinary electrometer.

Suppose that an active preparation of radium is spread on a metal plate connected with earth, and that the β rays are absorbed by a parallel plate connected with an electrometer. If the rays are negatively charged, the top plate should receive a negative charge increasing with the time. On account, however, of the great ionisation produced by the rays between the plates, any charge given to one of them is almost instantly dissipated. In many cases, the plate does become charged to a definite positive or negative potential depending on the metal, but this is due to the

contact difference of potential between the plates, and would be produced whether the rays were charged or not. The ionisation of the gas between the plates is greatly diminished by placing over the active material a metal screen which absorbs the α rays, but allows the β rays to pass through with little absorption.

The rapid loss of any charge communicated to the top plate can be very much reduced, either by diminishing the pressure of the gas surrounding it or by enclosing the plate with suitable insulators.

The latter method was adopted by M. and Mme Curie* in their experiments which first showed that the β rays from radium carried with them a negative charge. They found that the β rays fired into the upper plate gave it a negative charge; while the insulating plate carrying the radium preparation acquired a positive charge of equal amount.

The simplest and most accurate method of measuring the charge carried by the β rays is to enclose the active material in a glass or metal tube of thickness sufficient to completely stop the α rays, but thin enough to allow most of the β rays to escape. If the radium tube is insulated inside an exhausted space, it gains a positive charge, and in a high vacuum this may easily reach several hundred volts before the loss of charge through the insulator and gas balances the rate of supply.

A very striking experiment of this kind has been devised by Strutt†, and the experimental arrangement is shown in Fig. 52. To a sealed tube *AA* containing the radium was attached at one end a pair of thin gold leaves *CC* in metallic connection with the radium, which was insulated by means of a quartz rod *B*. The inner surface of the tube

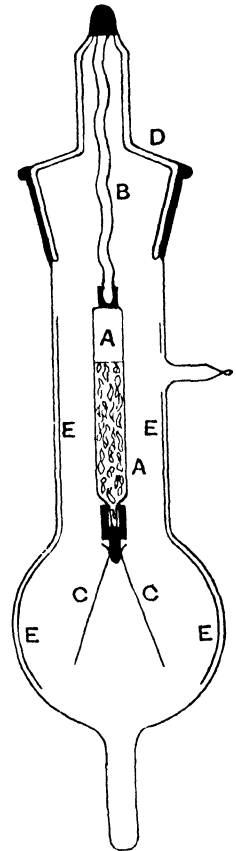

Fig. 52.

* M. and Mme Curie, *C. R.* **130**, p. 647, 1900.

† Strutt, *Phil. Mag.* **6**, p. 588, 1903.

was coated with tinfoil EE connected to earth. The glass surface of AA was made conducting by a thin coating of phosphoric acid. The air in the outer tube was exhausted as completely as possible by means of a mercury pump, in order to reduce the ionisation in the gas, and consequently the loss of any charge gained by the gold leaves. After an interval of 20 hours, the gold leaves were observed to diverge to their full extent, indicating that they had acquired a large positive charge. In this experiment Strutt used half a gram of radiferous barium of activity only 100 times that of uranium.

If the tube is filled with 30 mgrs. of pure radium bromide, the leaves diverge to their full extent in the course of about a minute. If it is arranged that the gold leaf, at a certain angle of divergence, comes in contact with a piece of metal connected with earth, the apparatus can be made to work automatically. The leaf diverges, touches the metal, and at once collapses, and this periodic movement of the leaf will continue, if not indefinitely, at any rate as long as the radium lasts. This "radium clock" should work at a sensibly uniform rate for many years, but, from evidence considered later (Section 176), there is reason to believe that the number of β particles emitted would ultimately decrease exponentially with the time, falling to half value in about 2000 years. The rate of movement of the leaf should thus gradually decrease with the time, and ultimately, after a very long interval of time, the effect would become too small to observe.

An interesting experimental result has been described by Dorn*. A small quantity of radium salt was placed in a sealed glass tube and left for several months. On opening the tube with a file, he states that a bright electric spark was observed at the moment of fracture, indicating that there was a large difference of potential between the inside of the tube and the earth.

In this case the α rays were absorbed in the walls of the tube, but a large proportion of the β rays escaped. The inside of the tube thus became charged, in the course of time, to a high positive potential; a steady state would be reached when the rate of escape of negative electricity was balanced by the leakage of positive

* Dorn, *Phys. Zeit.* 4, p. 507, 1903.

electricity through the walls of the tube. The external surface of the glass would be always practically at zero potential, on account of the ionisation of the air around it.

The writer has not personally observed any marked evidence of such an effect, even when small tubes have contained a large quantity of radium or the radium emanation. It is probable that ordinary glass is sufficiently conducting under the influence of the α rays to prevent the rise of any great difference of potential between the inner and outer surfaces.

The first estimate of the amount of the charge carried by the β rays from a known weight of radium salt was made by Wien*. A small quantity of radium bromide, placed in a sealed platinum vessel, was hung by an insulating thread inside a glass cylinder, which was exhausted to a low pressure. A connection between the platinum vessel and an electrode sealed through the external glass cylinder could be made, when required, by tilting the tube. Wien found that in a good vacuum the platinum vessel became charged to about 100 volts. By measuring the rate of loss of the negative charge from the platinum cylinder, the number of β particles escaping from the tube per second can be deduced by assuming that each β particle carries the fundamental unit of charge. In the experiments of Wien, a considerable fraction of the β rays emitted by the radium were absorbed in their passage through the platinum, so that the estimate of the number of β particles emitted by the radium per second was much too low.

In order to reduce this absorption by the containing envelope to a minimum, the writer† employed a lead cylinder coated with a thin film of the active deposit of radium as a source of β rays. The lead cylinder was covered with a thickness of aluminium foil just sufficient to stop all the α rays, but not enough to stop the β rays appreciably. The lead cylinder was insulated inside a brass tube which was exhausted to a low vacuum. In a good vacuum the current passing between the two cylinders is always in the same direction whether the inside electrode is charged positively or negatively, but the actual current is larger in the latter case. This difference is due to the small ionisation of the

* Wien, *Phys. Zeit.* **4**, p. 624, 1903.

† Rutherford, *Phil. Mag.* **10**, p. 193, 1905.

residual gas. By taking the mean of the two currents obtained by reversal of a weak electric field, the total charge of the β particles emitted per second was directly determined. The amount of radium C was deduced by comparison of the γ ray activity of the lead cylinder with a standard quantity of radium in equilibrium, and suitable corrections were made for the decay of the active deposit during the experiment. Since the β rays emitted from radium are mainly due to the products radium B and radium C, it was thus possible to deduce the total number of β particles emitted from one gram of radium in equilibrium. Taking the charge as 4.65×10^{-10} e.s. units, the number of β particles expelled per gram of radium per second comes out to be 5.3×10^{10} . In the light of later knowledge, there are certain objections to this arrangement. A considerable fraction of the β particles which are fired into the lead are so scattered that they emerge again from the surface. In addition, for a similar reason, some of the β particles on striking the outer tube are scattered and give up their charge to the lead cylinder. In order to avoid these difficulties, Makower* used as a source of radiation a thin glass tube of small diameter filled with emanation. This was of sufficient thickness to let through all except the easily absorbed β rays, and at the same time was of such small diameter that the greater part of the β rays which escaped ultimately gave up their charge to the outer cylinder, quite independently of the scattering when they struck the surface. Using a glass tube of thickness .078 mms. he found that 3.68×10^{10} β particles were expelled per second from the emanation in equilibrium with one gram of radium. Using the absorption curve for the β rays from radium B given by Schmidt, he deduced that the total number of β particles expelled per second per gram of radium was 5.0×10^{10} . This number is calculated on the assumption that radium B and radium C emit an equal number of β particles.

Makower determined the absorption of the β rays by placing cylinders of glass of known thickness over the source of radiation. He found that the curve expressing the relation between the number of β particles which emerged, and the thickness of the absorbing screen was very similar to the absorption curve obtained

* Makower, *Phil. Mag.* 17, p. 171, 1909.

by measuring the ionisation of the air between the cylinders at atmospheric pressure for different thicknesses of absorbing screens. The results are shown in Fig. 53 where the ordinates are proportional to the number of β particles emitted, and the abscissae to the thickness of glass in mms. The circles refer to the charge, and the crosses to the ionisation for the same thickness. The dotted line shows the extrapolated part of the curve. It will be seen that the two curves are in good agreement over their whole range.

This is an important result, and appears to indicate that the ionisation is proportional to the number of β particles emitted, and independent of any change of velocity resulting from their

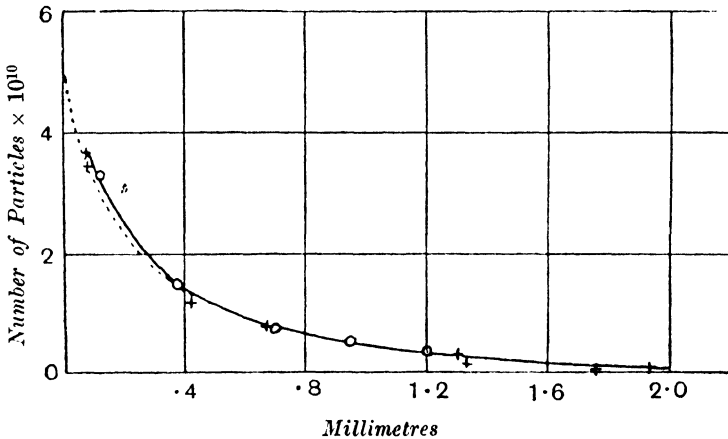

Fig. 53.

passage through the absorbing screen. It must be borne in mind, however, that the β rays from radium are very complex, and remain complex after passing through absorbing screens. The results obtained thus refer in each case to the *average* ionisation produced by a number of β particles moving at very different speeds.

Supposing that an atom of both radium B and radium C in breaking up emits one β particle, the number of β particles emitted per second from the emanation in equilibrium with one gram of radium should be equal to twice the number of α particles from radium C, *i.e.* 6.8×10^{10} β particles. The actual number observed is less than this. This low value is certainly striking

when we take into consideration the recent results obtained by v. Baeyer and Hahn and Meitner and by Danysz (Section 95). The latter found that twenty-nine distinct groups of β rays were emitted from radium B and radium C together. Hahn has also shown that radium itself emits two groups of very easily absorbed β rays.

There is one point of importance which so far has not been taken into account in the measurement of the charge carried by the β rays proper. We have seen (Sections 61, 72) that the α particles in passing through matter cause the emission of a number of slow moving electrons (δ rays). Since the ionisation of gases and solids by β rays is probably very similar in character to that produced by α rays, it is to be expected that the β particles on emerging from, or impinging upon, matter will release some slow moving δ particles. Evidence to this effect has recently been obtained by Moseley. The emission of δ particles tends to make the rate of loss of charge observed somewhat greater than that actually due to the escape of the primary β particles.

Moseley has recently made a careful determination of the number of β particles from the radium emanation contained in very thin glass tubes. Correcting as far as possible for the absorption of the β rays in the matter required to stop the α rays, he found that the emanation together with its products radium B and radium C in equilibrium with one gram of radium emitted 7×10^{10} β particles per second or 2.2 times the number of α particles from one gram of radium itself. Other experiments showed that about an equal number of β rays were expelled from radium B and radium C when in equilibrium with each other.

81. Determination of e/m and its variation with speed.

We have seen (Section 31) that in their passage between two charged plates, cathode rays are deflected towards the positive plate. Shortly after the discovery of the β rays from radium, Dorn* and Becquerel† showed that the β rays were deflected in an electric field in the same direction as the cathode rays.

* Dorn, *C. R.* **130**, p. 1129, 1900.

† Becquerel, *C. R.* **130**, p. 809, 1900.

Becquerel made an approximate determination of the velocity of the β rays, and of the value of e/m by determining separately the deflection of a pencil of rays both in a magnetic and an electric field by the photographic method. An active preparation of radium was used as a source of β rays. Since radium emits β rays over a wide range of velocity, a narrow pencil of rays forms a broad band on the photographic plate when the rays pass through a magnetic or electric field. The deflection of the β particles of average velocity was measured. In this way it was found that the average velocity of the β particles of radium was about 1.6×10^{10} cms. per second, and that the value of e/m was about 10^7 e.m. units.

These approximate results indicated that the β particles had about the same small mass as the cathode ray particles, and were projected with a velocity about half that of light. This velocity is considerably greater than can be impressed on the cathode particles in an ordinary vacuum tube. It was clear, however, that the β particles were probably identical in all respects except velocity with the cathode rays. An accurate determination of the value of e/m for β particles at different speeds was first made by Kaufmann*. The fact that radium emits β particles over a wide range of velocity, and that some of them have nearly the velocity of light, was utilised by him to determine the variation of the value of e/m with the speed of the particle. We have seen (Section 29) that according to the electromagnetic theory, a charge of electricity in motion behaves as though it had apparent or electrical mass. For speeds small compared with that of light, this additional mass is equal to $2e^2/3a$ where e is the charge supposed distributed over a sphere of radius a . According to the theory, the apparent mass should increase rapidly as the speed of light is approached. It was of great importance to settle definitely whether the mass of the electron is due partly to mechanical and partly to electrical mass, or whether it can be explained by virtue of electricity in motion, independently of the usual conception of mass.

The experimental method employed by Kaufmann to determine the value of e/m for β particles of different velocities, was similar to

* Kaufmann, *Phys. Zeit.* 4, p. 54, 1902.

the method of crossed spectra. Some strongly active radium salt was placed at the bottom of a brass box. The rays from this passed between two brass plates insulated and about 1.2 mm. apart. These rays fell on a platinum diaphragm, containing a small opening about 0.2 mm. in diameter, through which passed a narrow bundle of rays. The rays then struck a photographic plate enveloped in a thin sheet of aluminium.

In the experiments the diaphragm was about 2 cms. from the active material and at the same distance from the photographic plate. When the whole apparatus was placed in a vacuum, a P.D. of from 2000 to 5000 volts could be applied between the plates without a discharge taking place. The rays were deflected in their passage through the electric field, and produced what may be termed an electric spectrum on the plate.

If by means of an electromagnet a magnetic field is superimposed parallel to the electric field, a magnetic spectrum is obtained perpendicular to the electric spectrum. The combination of the two spectra gives rise to a curved line on the plate. The double trace obtained on the photographic plate with reversal of the magnetic field is shown in Fig. 54. Disregarding some small corrections, it can readily be shown (see Section 30) that if y and z are the electric and magnetic deviations respectively corresponding to any point on the photographic



Fig. 54.

plate $y = \kappa_1 \frac{e}{mu^2}$, $z = \kappa_2 \frac{e}{mu}$ where κ_1 and κ_2 are constants which can be determined. From these two equations, the value of e/m of the β particle corresponding to any value u of the velocity can be deduced. Kaufmann initially compared his result with the theory developed by Abraham (see Section 29). He found that the value of e/m decreased with increase of speed, and deduced that the value e/m_0 for rays of slow speed was 1.84×10^7 e.m. units—a value in close accord with that obtained by Simon* (1.86×10^7) for cathode rays of average speed 7×10^9 cms. per second.

The agreement of his observations with the theory of Abraham is shown in the following table. The first column gives the ratio

* Simon, *Annal. d. Phys.* **69**, p. 589, 1899.

of the velocity u of the β particle to the velocity of light V , the second the ratio of the observed ratio of the mass m at that speed to the mass m_0 for slow speeds.

Value of $\frac{u}{V}$	Observed value of $\frac{m}{m_0}$	Percentage difference from theoretical values
Small	1	
·732	1·34	-1·5 %
·752	1·37	-0·9 "
·777	1·42	-0·6 "
·801	1·47	+0·5 "
·830	1·545	+0·5 "
·860	1·65	0 "
·883	1·73	+2·8 "
·933	2·05	-7·8 " ?
·949	2·145	-1·2 "
·963	2·42	+0·4 "

It is seen that for particles moving with ·963 the velocity of light, the apparent mass is 2·42 times greater than for slow speeds. From the agreement of experiment with theory, Kaufmann concluded that the mass of the β particle or electron was entirely electromagnetic in origin. In a later paper*, he considered that his results were in better agreement with the formula of Abraham than with that deduced by Lorentz from different considerations (see Section 29).

In the meantime, the principle of relativity had been developed by Einstein and others. This led to a somewhat different relation for the variation of e/m with speed, viz. $e/m = \frac{e}{m_0} \left(1 - \frac{u^2}{V^2}\right)^{\frac{1}{2}}$ where u is the velocity of the particle and V the velocity of light. In order to test the validity of this formula, Bucherer† made a determination of the variation of e/m with speed by a new method.

A small fragment of radium salt was placed at the centre of two circular parallel plates, 8 centimetres in diameter, and 0·25 millimetre apart. A magnetic field produced by a current through suitable coils was applied parallel to the plane of the

* Kaufmann, *Ann. d. Phys.* **19**, p. 487, 1906.

† Bucherer, *Ann. d. Phys.* **28**, p. 513, 1909, and **29**, p. 1063, 1909.

plates. Let H and X be the values of the magnetic and electric fields respectively between the plates, and u the velocity of the β particle. If the force on a β particle due to the magnetic field is equal and opposite to that due to the electric field, the β particle will pass between the plates without deviation but will be deflected by the magnetic field extending beyond the plates. This will be the case for β particles making an angle α with the direction of the magnetic field if $Xe = Heu \sin \alpha$.

The rays emerging at a definite angle with the magnetic field, will thus consist to a large extent of particles moving with the same speed. The pencil of rays after emergence is deflected by the magnetic field alone, and falls on a photographic film which envelopes the inner surface of a cylinder 16 cms. in diameter, the axis of which is perpendicular to the plane of the plates, and passes through the centre of the plates.

By reversal of the fields, the film on development shows two continuous bands, whose distance apart at any point is a measure of twice the deflection produced by the magnetic field. From the experimental results, the velocity and value of e/m of the β particle for each point of the curve can be deduced. Bucherer determined the value of e/m for velocities between 0.32 and 0.7 the velocity of light. He found that his results were in close accord with the formula of Lorentz and Einstein, but did not agree so well with that deduced by Abraham. The value of e/m_0 was found to be 1.73×10^7 e.m. units, which is slightly lower than the original value found by Kaufmann. Several other determinations of the value of e/m_0 have been made by other observers, including H. Starke*, Bestelmeyer†, and Classen‡. Hupka§ determined the variation of e/m with speed for electrons emitted by a metal surface exposed to ultra violet light. The electrons were set in motion in a vacuum between two plates charged to a high difference of potential. The variation of e/m with speed was found to be in close agreement with the formula of Lorentz and Einstein.

* H. Starke, *Verh. d. D. Phys. Ges.* **5**, p. 241, 1903.

† Bestelmeyer, *Annal. d. Phys.* **22**, p. 429, 1907.

‡ Classen, *Phys. Zeit.* **9**, p. 762, 1908.

§ Hupka, *Verh. d. D. Phys. Ges.* **11**, p. 249, 1909.

At the end of this book, a table is added which shows the variation of e/m with speed for particles of different velocities according to the formula of Lorentz and Einstein. The corresponding values of $\frac{mu}{e}$, $\frac{mu^2}{e}$ are added for convenience. These tables will be found useful in deducing the momentum and kinetic energy of the β particle at different speeds and also for deducing the velocity of β particles where the value $H\rho = mu/e$ is measured experimentally. The value of e/m_0 is taken as 1.77×10^7 electromagnetic units.

82. The passage of the β rays through matter. We have seen in the last chapter that the main phenomena connected with the absorption of α rays can be approximately explained by a simple law. The passage of the β rays through matter is, in some respects, far more complicated, and although a large amount of experimental work has been done to bring out clearly the more important factors involved, no final and definite conclusions have yet been reached. It is desirable at this stage to give an historical *résumé* of the development of our knowledge of this subject. It was early found that the β rays were, as a whole, far more penetrating than the α rays*. Their absorption by matter was initially examined by the electrical method by placing metal screens over a layer of active matter. For this purpose a β ray electroscope was employed, or a testing vessel such as is shown in Fig. 13. The active matter which emitted the β rays was placed under the electroscope, or rested on the lower of the two parallel plates. The ionisation of the gas due to the β rays was found to decrease approximately according to an exponential law with the thickness of matter traversed by the rays. This is expressed by the relation $I/I_0 = e^{-\mu d}$ where I is the electrical effect after passing through a thickness d and I_0 the initial value for a thin screen of sufficient thickness to absorb the α rays, and μ a constant of absorption. This relation was initially found to hold approximately for the β rays from uranium but not for the β rays from radium and thorium. Since Lenard had shown that cathode rays, which are identical with β rays of low speed, are absorbed according

* Rutherford, *Phil. Mag.* 47, p. 109, 1899.

to an exponential law, it was natural at first to suppose that the exponential law of absorption was an indication that the β rays were homogeneous, i.e. consisted of β particles projected with the same speed. On this view, the β particles emitted from uranium which gave a nearly exponential law of absorption, were supposed to be homogeneous. On the other hand, the β rays from radium which did not give an exponential law of absorption were known from other evidence to be heterogeneous. In order to account for the observation that very nearly the same exponential law was obtained for *thick* and *thin* layers of uranium, it was implicitly assumed that the β particle suffered only a very small change of velocity in passing through a considerable thickness of matter, so that the rays issuing from a thick layer of matter were only slightly altered in velocity by their passage through it.

The β rays expelled from the various radio-active products vary in velocity between $\cdot 3$ and $\cdot 99$ the velocity of light. These velocities are much higher than those impressed on the cathode rays produced in a vacuum tube. Lenard had carefully investigated the latter and shown that they were absorbed approximately according to an exponential law, and that the absorption for different kinds of matter was nearly proportional to the density of material over a very wide range. The penetrating power of β rays increases very rapidly with their velocity, so that the rays from many of the radio-active products have a very much greater penetrating power than the slower velocity cathode particles. Although the β particle, on the average, is expelled with a velocity more than ten times greater than that of the α particle, its apparent mass is so small that its momentum and kinetic energy are, on an average, small compared with that of the α particle.

We have already seen that the α particles are deflected from their rectilinear path by their passage through the atoms of matter. On account of the much smaller momentum and energy of the β particle, the latter is far more readily deflected in its encounters with atoms of matter than the massive α particle. Lenard early showed that a pencil of cathode rays after passing through a screen of matter was widely scattered, and emerged as a very diffused beam. A similar scattering is exhibited by β rays. This scattering is so marked that a considerable part of the

β particles incident on a metal screen emerge again on the side of incidence. This scattering of the β particles plays a very important part in the passage of the β rays through matter, and is one of the main causes of the wide difference in the character of the absorption shown by the α and β rays. This subject of scattering is very important, and will be considered in detail later.

A study of the α rays has shown that a thin film of active matter of one kind expels α particles with the same speed, and that the velocity of each of these α particles is reduced by the same amount in passing through a metal screen. This shows that each atom of radio-active matter breaks up in the same way, and expels an α particle with a definite velocity characteristic of the particular substance undergoing disintegration. It is now known that a number of products like uranium X, radium B, radium E and meso-thorium 2 are transformed with the emission of β rays, but no α rays. These β particles, which are expelled at a great speed, seem to be a *primary* effect of the transformation of the atoms, and in this respect resemble the α rays. From analogy with the α rays, it was natural *a priori* to expect that the β rays from a thin film of active matter of one kind should escape with identical velocity.

Hahn and Meitner* adopted the view that the exponential law of absorption was a proof of the emission of such homogeneous rays, and used this principle in a search for further products of the transformation of radio-active matter. This view proved very valuable as a working hypothesis, for they were able to show in a number of cases that a radio-active material which emitted β rays of a complex character, *i.e.* rays which were not absorbed according to an exponential law, contained more than one β ray product. In the meantime, W. Wilson† made some experiments on the absorption of approximately homogeneous rays, obtained by sorting out the complex β rays of radium by a magnetic field. An account of these experiments will be given later, but it suffices to say at this point that he concluded that homogeneous rays were not absorbed according to an exponential law; and further,

* Hahn and Meitner, *Phys. Zeit.* **9**, p. 321, 1908; **10**, pp. 697, 948, 1909.

† W. Wilson, *Proc. Roy. Soc. A*, **82**, p. 612, 1909.

by using aluminium screens, that an exponential law of absorption indicated that the β rays were complex in character.

In order to throw light on this point, J. A. Gray* examined the deflection of the β rays from radium E in a magnetic field by the photographic method, using an apparatus similar to that employed for the α rays shown in Fig. 23. The deflected β rays showed a continuous band or spectrum, indicating that the rays were heterogeneous. At the same time, he found that the β rays from both a *thick* and *thin* layer of radium E were absorbed according to an exponential law. These results thus confirmed in some respects the conclusions reached by W. Wilson. v. Baeyer, Hahn and Meitner† in the meantime had independently investigated the question of the complexity of the β rays by a similar photographic method. As sources of β rays, they employed thin films of active matter deposited on fine wires. The photographs obtained in a magnetic field showed several well-marked bands, indicating that each of these sources emitted sets of rays of definite velocity. In later work it was found that the emission of β rays was very complicated, and that in some cases a large number of bands was observed for a single product. For example, the active deposit of radium, consisting of radium B + C gave at least nine distinct types of rays which were clearly observable on a photographic plate. It was also found that while the slower rays were apparently homogeneous and gave sharp lines, the swifter rays gave more diffuse bands, indicating that the particles were expelled over a considerable range of speed. A discussion of these interesting and important results is given later in Section 95.

83. Scattered or reflected rays. We have seen that when the β rays fall on matter, part is transmitted and part is diffusely scattered from the plate on the side of incidence. This scattered radiation is identical in type with the primary β rays, and was initially given the name of *secondary* β radiation. Later work, however, has indicated that this diffuse radiation consists of the

* Gray, *Proc. Roy. Soc. A*, **84**, p. 136, 1910.

† v. Baeyer, Hahn and Meitner, *Phys. Zeitschr.* **11**, p. 488, 1910, and **12**, p. 273, 1911.

β particles that are scattered through such a large angle by the matter that they return on the side of incidence. There is no definite evidence that β particles on striking the plate give rise to a true secondary radiation of the β ray type, which is excited in the atoms of matter by the impact of β rays. Taking the view that the γ rays are pulses accompanying the expulsion of β rays, it might reasonably be expected that some γ rays would be produced by the stoppage of the β particles by matter. This production of γ rays by β rays has been recently observed by J. A. Gray* using the β rays of radium E as a source. In the case of radium and thorium, however, this effect is so small compared with that due to the primary γ rays generated in the radio-active matter that it is very difficult to detect. From analogy with the α rays, it is to be expected that some slow velocity electrons would appear on the sides of incidence and emergence of the β rays; but the ionising effect of these would only extend to a minute distance from the surface of the plate.

It will be very convenient to call the rays which are turned back on the side of incidence the *reflected* rays, and those which pass through the plate the *transmitted* rays. In using the term "reflected," however, it must be remembered that the phenomenon has no analogy with light, but that the reflected rays consist of the primary β particles which have been so scattered by the atoms of matter that they emerge again in all directions. Becquerel first showed by the photographic method the presence of these reflected rays, and pointed out that these reflected rays falling on matter gave rise in turn to another set of reflected rays, and so on. The rays produced by one and two reflections are sometimes known as secondary, tertiary, etc.

Eve† investigated the reflected radiation by an electric method; the arrangement is shown in the following figure (Fig. 55). The β rays from a tube R containing radium fell on a plate of material called the radiator, and the reflected rays passed into an electroscope, the face of which was covered with a thin sheet of aluminium. A lead screen was put in position to cut off the greater part of the direct transmitted β and γ radiation. The

* Gray, *Proc. Roy. Soc. A*, **85**, p. 131, 1911.

† Eve, *Phil. Mag.* **8**, p. 669, 1904.

effect observed in the electroscope was due to the reflected β rays, and also in small part to scattered γ rays, and the β rays which are known to be produced when the γ rays pass through matter. Eve found that this reflected radiation increased at first with the thickness of the radiator, soon reaching a practical maximum. This shows that the primary rays penetrate some distance before the amount of scattered radiation reaches its maximum. He measured the amount of reflected radiation from thick radiators of a number of materials and found that the amount of radiation increased with the density of the material, but was greater for light substances like paper and wood than would be expected if the amount of reflected rays were proportional to the density.

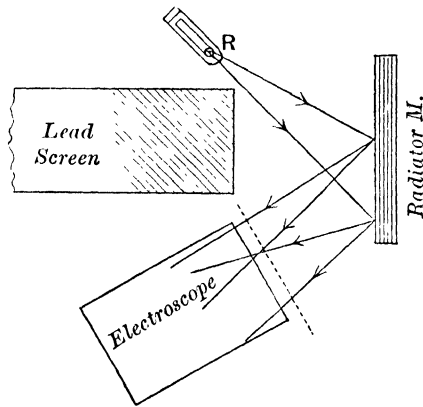

Fig. 55.

The same problem was independently investigated about the same time by McClelland*. In order to investigate the distribution of the reflected β particles, the arrangement was that shown in Fig. 56. AB , A_1B_1 were cylindrical testing vessels identical in size; the former was fixed and was used to determine the intensity of the β rays from the radium R . The latter, which was moved round the arm of a circle, was used to measure the intensity of the scattered radiation from the plate P at different angles θ from the normal. It was found that the amount of scattered radiation entering the small testing vessel varied approximately as the

* McClelland, *Trans. Roy. Dub. Soc.* 9, Pt. 1, p. 1, 1905; 9, Pt. 2, p. 9, 1906; *Proc. Roy. Soc. A*, 80, p. 501, 1908.

cosine θ . Even if the rays are scattered equally in all directions, those which emerge at an angle θ have on the average passed through a greater thickness of matter than those which escape normally, and consequently by absorption are reduced relatively in number, and probably also in velocity and penetrating power. McClelland also investigated the amount of reflected radiation from thick radiators of different metals, and found that the amount of this reflected radiation increased with the atomic weight of the radiator. Evidence was also obtained that the amount of scattered radiation appeared to be a periodic function of the atomic weights.

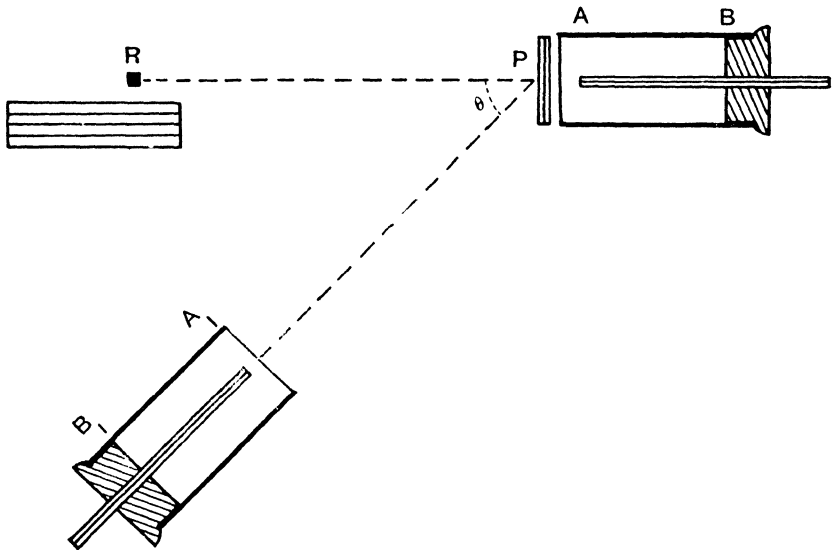

Fig. 56.

Righi* investigated the amount of reflected radiation by a different method. β rays were allowed to fall on a plate placed in an exhausted vessel and connected with an electrometer. The plate gained a negative charge; but the rate of charging was greater for light than for heavy atoms. For example, it was found that the rate of charging for aluminium was about twice as great as for lead. The explanation of this effect is simple. The charge given to the plate is proportional to the number of β particles

* Righi, *Phys. Zeit.* 6, p. 815, 1905.

striking the plate less the number scattered back. It is clear from these results that a radiator of high atomic weight scatters back a much larger proportion of the β particles than a metal of light atomic weight. This is in agreement with the results obtained by other methods.

The amount of reflected radiation for different materials has been closely investigated by H. W. Schmidt* and later by Kovarik†, using electroscopic methods. The apparatus employed by Kovarik is shown in Fig. 57. The source of β rays was a thin film of active matter spread on a very thin plate of mica or of aluminium. A layer of aluminium of thickness just sufficient to completely

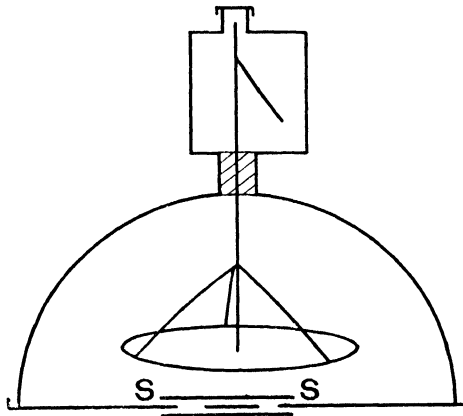

Fig. 57.

stop the α rays was placed over the active matter. The testing vessel was hemispherical in shape, and the active matter was placed over an opening *SS* in the base of the hemisphere. The advantage of this arrangement was that all the β rays escaping upward from the plate passed into the testing vessel and had nearly the same path in air. By placing a thick layer of metal under the active plate the greater part of the scattered radiation entered the testing vessel and added its effect to that of the direct radiation. In this way, the amount of scattered radiation was determined directly as a percentage of the primary radiation. Small corrections were made for the slight absorption of the

* H. W. Schmidt, *Ann. d. Phys.* **23**, p. 671, 1907.

† Kovarik, *Phil. Mag.* **20**, p. 849, 1910.

β rays in passing through the aluminium screen surrounding the active matter. Some of the results obtained by Kovarik are given in the following table, for the β rays from a thin layer of radium E and of actinium D obtained from the active deposit of actinium.

The β radiations from each of these materials is absorbed very nearly according to an exponential law. The coefficient of absorption in terms of cms. of aluminium is 43.5 for the rays from radium E and 28.5 for the rays from actinium D. The incident radiation is taken as 100.

Reflector	Atomic weight	Percentage reflected β radiation	
		Radium E	Actinium D
Bismuth	208.5	70.9	81.0
Lead	206.9	70.2	80.0
Gold	197.2	67.8	78.7
Platinum	194.8	67.7	77.6
Tin	119.0	62.5	69.7
Silver	107.9	57.4	63.5
Zinc	65.4	45.5	52.6
Copper	63.6	44.7	51.9
Nickel	58.7	43.5	48.0
Iron	55.9	41.2	47.1
Sulphur	32.1	32.1	40.1
Aluminium	27.1	30.0	38.3
Carbon	12.0	17.1	27.4

It will be seen that the amount of scattered radiation increases with the atomic weight, and also depends on the velocity of the β rays. The β rays from actinium are swifter than those from radium E and show a greater percentage reflection.

In a paper by Kovarik and W. Wilson*, it was shown that the amount of reflected radiation from different materials increases with the velocity of the β rays up to a certain point and then decreases again. For example, the amount of reflected radiation from lead increases until the rays have a velocity about 0.9 the velocity of light and then slowly decreases for higher speeds.

Schmidt and Kovarik (*loc. cit.*) have shown that the reflected radiation is always of less average penetrating power than the incident. For example, using a thin film of radium E as a source

* Kovarik and Wilson, *Phil. Mag.* 20, p. 866, 1910.

of β rays, Kovarik found that the absorption coefficient μ of the transmitted radiation varies with the material placed beneath the active matter. With air underneath, $\mu = 42.4$ (cms.)⁻¹, with lead underneath, $\mu = 44.8$, with aluminium underneath, $\mu = 43.3$. Such a result is to be expected since the scattered β rays have on an average encountered a large number of atoms before they emerge, and have had their velocity reduced to some extent in consequence of these encounters (see Sections 92 and 93).

84. Scattering of transmitted β rays. Crowther* early showed that the β particles were much scattered in passing through thin sheets of matter in which the absorption was small. The general idea of the experiment will be clear from Fig. 58. AC and BD are two parallel plates close together, so that a narrow beam of β rays emerges from CD when the source of β rays is at AB . If now a thin metal screen is introduced between the plates at XY , any β rays which are scattered through more than a small angle in traversing the screen are absorbed by the walls of the parallel plates. The effect of the screen is thus to reduce the number of β particles emerging from CD . In the experiments, uranium was used as a source of β rays, and a number of plates in parallel were used to increase the magnitude of the electrical effect due to the issuing rays. The current due to the issuing rays was found to decrease rapidly with thickness of the screen at XY . Crowther found that practically all the rays were scattered for a thickness of aluminium $.015$ cm. and for a thickness of gold $.0002$ cm.

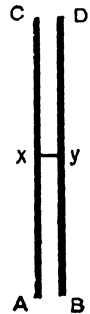

Fig. 58.

It must be borne in mind, however, that in the arrangement of Crowther, the β rays have only to be scattered through a comparatively small angle to be absorbed by the walls of the parallel plates. The experiments do not throw light on the distribution of the scattered radiation but afford a means of comparing the amount of scattering by different materials.

The scattering of the β rays of radium by thin layers of metal

* Crowther, *Proc. Roy. Soc. A*, **80**, p. 186, 1908.

was examined later by Madsen*. The general principle of the experiment was similar to that of Crowther, but the arrangements were such that the scattered radiation entered a hemispherical testing vessel and that the distance traversed by each scattered particle was the same. Madsen examined the amount of scattered radiation both on the side of "emergence" and on the side of "incidence." The former is always far more marked than the latter. For example, using thin metal foils, the amount of emergent scattered radiation was 9 times the amount of the scattered "incident" radiation for aluminium, and about 5 times for gold.

Madsen found that the amount of scattered radiation increased rapidly at first with thickness of the scattering material, passed through a maximum, and then decreased slowly. Such results are to be expected; for at first the absorption of the β rays is small, and the amount of scattering becomes more marked with increasing thickness of the screen. For larger thicknesses, the absorption of the rays by the screen becomes important and finally leads to a decrease in the amount of emergent radiation.

85. Scattering of β rays by thin sheets of matter. The experiments previously described deal for the most part with the scattering of complex β rays from comparatively thick sheets of matter. In these cases, the amount of scattered radiation is not only a function of the velocity of the rays but also depends on the amount of absorption of the rays by different materials. Under these conditions, it is not to be expected that the experimental results would show any simple relation either with the average velocity of the β particles or with the atomic weight of the scattering material. A comparison of experiment with any theory of scattering is best made by observing the distribution of the scattered radiations after passing through sheets of matter so thin that the absorption of the incident rays is negligible. Experiments of this kind have been made by Crowther†.

The experimental arrangement is shown in Fig. 59. A nearly homogeneous pencil of β rays from a radium preparation *A* was

* Madsen, *Phil. Mag.* **18**, p. 909, 1909.

† Crowther, *Proc. Roy. Soc. A*, **84**, p. 226, 1910.

obtained by passing the rays between the poles of an electro-magnet $EFGH$. This homogeneous pencil passed through the opening D into the scattering chamber S . The rays then passed through an opening R in S covered with thin aluminium foil and entered the testing vessel T where the ionisation current due to them was measured. In order to avoid the scattering of the β rays by the gas, their path to R was through an exhausted space. On introducing a thin metal screen at P , the pencil of rays is scattered, and the effect measured in T is then due to the β rays which have been scattered through an angle less than ϕ , where ϕ is half the angle subtended by the opening R .

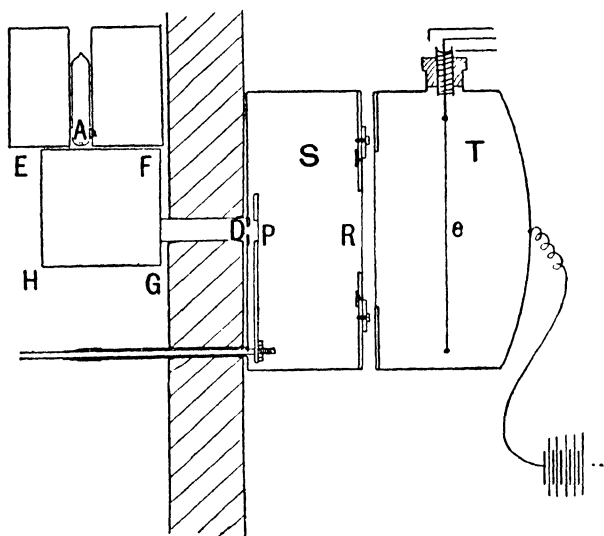

Fig. 59.

This apparatus was very convenient for studying the scattering of β rays of different velocities by very thin metal foils. In order to obtain a pencil of rays as homogeneous as possible, the opening at D was small. Under these conditions, the effect of the γ rays from the radium was comparable with that due to the β rays. A balance method was employed to obtain accurate measurements. The results obtained were compared with a theory of scattering advanced by Sir J. J. Thomson*.

* J. J. Thomson, *Proc. Camb. Phil. Soc.* **15**, p. 465, 1910.

This theory has been already referred to in Section 74. The atom of matter was supposed to consist of a sphere of uniform positive electrification in which was distributed an equal and opposite charge in the form of negative electrons. The β particle traverses the atom and suffers irregular deflections due to a close approach to the constituent electrons or to the field due to the positive sphere. The deflections were supposed to be in general small, and the observed deflection of β particles was ascribed to the probability distribution resulting from a large number of small average deflections. If θ is the average deflection due to each encounter with an atom, the mean deflection of a particle after N encounters was taken as $\sqrt{N} \cdot \theta$. Now if n be the number of atoms per unit volume of material, b the radius of the atom, the number of encounters in passing through a thickness t is $n\pi b^2 t$. Consequently the mean deflection $\phi_m = \sqrt{n\pi b^2 t} \cdot \theta$ or ϕ_m/\sqrt{t} should be constant for a given material. The theory also indicates that the value $mu^2/\sqrt{t_m}$ should be constant for a given material for a given value of ϕ , where $\frac{1}{2}mu^2$ is the energy of the β particle and t_m is the value of t required to cut down the radiation to half value. These two relations have been verified experimentally by Crowther, and his results for aluminium are given in the following tables. In the first table the velocity of the β particle was constant, but the angle ϕ and thickness of screen were varied. In the second table ϕ was constant, and the velocity and thickness of the screen were varied.

Scattering for aluminium.

Velocity of β particles = 2.681×10^{10} cm./sec.

ϕ (radians)	t_m (cms.)	$\phi/\sqrt{t_m}$
0.20	0.0022	4.3
0.24	0.0033	4.2
0.31	0.0054	4.2
0.41	0.0090	4.3

Scattering for aluminium.

$$\phi = 18^\circ$$

$H\rho$	u	mu^2/e	t_m (cms.)	$mu^2/e\sqrt{t_m}$
2260	2.40×10^{10}	5.41×10^{13}	0.00183	1.26×10^{15}
2870	2.58×10^{10}	7.40×10^{13}	0.00406	1.16×10^{15}
3420	2.68×10^{10}	9.15×10^{13}	0.0056	1.23×10^{15}
4050	2.77×10^{10}	11.2×10^{13}	0.0084	1.22×10^{15}
4840	2.83×10^{10}	13.7×10^{13}	0.0122	1.25×10^{15}
6500	2.90×10^{10}	18.9×10^{13}	0.0226	1.26×10^{15}

In considering the scattering of α rays (Section 74), a theory of scattering has been advanced which is based on different views. On this theory, it is supposed that a moving electrified particle can be deflected through a large angle by a single atomic encounter, and it has been concluded that the observed scattering of the α rays is mainly due to the effect of this single scattering, and that the compound scattering on which the theory of J. J. Thomson is based, is of less importance in determining the distribution of scattered particles. It has been shown that the theory of single scattering explains most of the experimental results obtained by Crowther; for example, on this theory, $\phi/\sqrt{t_m}$ and $mu^2/e\sqrt{t_m}$ should be constant. There is, however, one important point of difference in the deductions. The theory of J. J. Thomson indicates that if ϕ is constant and t is varied, the fraction I/I_0 of the total radiation entering S is given by $I/I_0 = 1 - e^{-k/t}$ where k is a constant. The numbers given by Crowther seem to be in accord with this relation. Such a result cannot hold on the theory of single scattering where it can be simply shown that $I/I_0 = 1 - \lambda t$ where λ is a constant. This is an important point; but it is a difficult one to decide experimentally on account of the difficulties of the measurements. Both theories of scattering are only applicable when the screens are so thin that no absorption of the radiation takes place and the scattering is not complete. A theory of scattering to include the effects of absorption and change of velocity of the β particle would of necessity be complicated.

86. The transmitted radiation. The absorption of the transmitted rays by matter has been usually investigated by the electroscopic method. The source of β rays is placed some distance below the opening in the base of a β ray electroscop. The ionisation current in the electroscop is determined for different thicknesses of matter placed between the electroscop and the source of radiation. When uranium X or radium E are used as sources of β rays, the current is found to fall off very nearly according to an exponential law with the thicknesses of

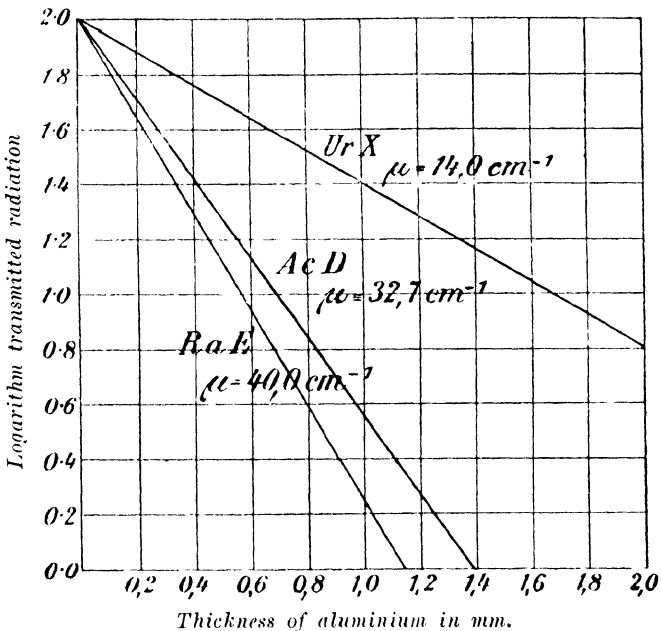

Fig. 60.

matter traversed. Consequently the intensity I measured by the saturation current after traversing a thickness d cms. of the material is given by $I/I_0 = e^{-\mu d}$ where I_0 is the value for thickness 0 and μ is the coefficient of absorption for the material. If d is the thickness in cms. to reduce the current to half value $\mu = \log_e 2/d = 0.693/d$ (cms.)⁻¹. Consequently if the curve is plotted with the logarithms of the currents as ordinates, and the thicknesses of matter traversed as abscissae, the curve of absorption is a straight line. The logarithmic curves, given by

H. W. Schmidt, showing the absorption in aluminium for the β rays from uranium X, from radium E and actinium D, are shown in Fig. 60. It should be mentioned here that owing to the presence of some easily absorbed rays, there is always a slight initial rapid drop in the curve not shown in the figure.

If the absorbing screens are placed some distance above the active matter, so that an approximately normal pencil of β rays falls on them, the curve always shows a rapid initial drop. This effect, first noticed by Crowther*, is due to the scattering of the β rays in all directions by the screen. Kovarik† has shown that in some positions of the screen relative to the electroscope, the ionisation current at first *increases* when thin layers of matter are placed over the source. After passing through a maximum, the current decreases according to an exponential law. This initial effect is also to be ascribed to scattering. In order to avoid these initial disturbances, which are largely dependent on the relative positions of the source of radiation and the absorbing screen with regard to the electroscope, it is desirable to place the absorbing material *close* to the base of the electroscope so that all radiation scattered in the direction of emergence may enter the electroscope. Under such conditions, the absorption curve is nearly exponential from the start. Since the amount and penetrating power of the scattered radiation depend upon the scattering material, the coefficient of absorption is influenced to some extent by the thickness of radiating material and the matter on which it is placed. The correction for this is not large, and can be made if necessary. The most trustworthy method of determining the absorption is to use a very thin layer of the material on thin plates of metal or mica, and to place equal thicknesses of material *above* and *below* the active matter which is placed directly under the electroscope. In such cases, the escaping radiation is symmetrical on both sides of the plates and the effect of scattering is to a large extent compensated. This method has been adopted by Kovarik.

The absorption coefficients of the β rays from active products have been determined by a number of investigators.

* Crowther, *Proc. Roy. Soc. A*, **80**, p. 186, 1908.

† Kovarik, *Phil. Mag.* **20**, p. 849, 1910.

The results are given in the following table where aluminium is used as the absorbing substance. For many of the products the absorption is approximately exponential. It must, however, be borne in mind that in nearly all cases the radiation emitted from even one product is complex. This will be clear from a consideration of the evidence discussed in Section 95. At the same time, it is very convenient and of practical importance to distinguish between the radiations by their absorption by matter measured by the electric method.

Substance	Coefficient of absorption μ (cms.) ⁻¹ in aluminium	First determination
Uranium X	15, 510	Rutherford ; H. W. Schmidt
Radium	312	Hahn and Meitner†
Radium B	13·1, 80, 890 }	H. W. Schmidt*
Radium C	13·2, 53 }	
Radium D	130	Hahn and Meitner†
Radium E	43·3	H. W. Schmidt*
Mesothorium 2	20 to 38·5	Hahn and Meitner†
Thorium B	110	
Thorium D	16·3	
Radio-actinium	110	
Actinium D	28·5	Godlewski‡

The values of μ for these substances have been determined by many observers who have obtained slightly different values depending on the experimental arrangement employed. For convenience of reference, the results given are those most recently published. The names of the investigators who made the first determinations are added, though not in all cases the value of μ found by them. It should be mentioned that the radiations from radium B and C are both very complex (see Section 95). The values given above are those deduced by Schmidt in order to account for the absorption curves.

The absorption of the β rays from radium has been investigated by Seitz§ by a different method. The rays from the radium

* H. W. Schmidt, *Phys. Zeit.* **7**, p. 764, 1906; **8**, p. 361, 1907; **10**, p. 6, 1909.

† Hahn and Meitner, *Phys. Zeit.* **9**, pp. 321, 697, 1908; **10**, p. 741, 1909; **12**, p. 378, 1911.

‡ Godlewski, *Phil. Mag.* **10**, p. 375, 1905.

§ Seitz, *Phys. Zeit.* **5**, p. 315, 1904.

passed into an exhausted vessel through a thin mica window, and the negative charge communicated per second to a thick insulated plate was determined. This is a measure of the number of β particles absorbed by the plate. By placing screens over the radium, an absorption curve was obtained which was similar in general character to that obtained by the ordinary electroscopic method. It is not to be expected that the absorption curves should be identical, since the ionisation in the electroscopic method depends not only on the number of β particles but also on their velocity. The differences, however, are not very marked for the β rays from radium, for we have seen (Section 80) that Makower found that the absorption curves obtained by the two methods were in good accord.

87. Absorption and chemical constitution. Lenard* showed in 1895 that the coefficient of absorption μ of the cathode

Substance	At. Wt.	μ/D	Substance	At. Wt.	μ/D
Boron ...	11	4.65	Arsenic ...	75	8.2
Carbon ...	12	4.4	Selenium ...	79	8.65
Sodium ...	23	4.95	Strontium ...	87.5	8.5
Magnesium ...	24.4	5.1	Zirconium ...	90.7	8.3
Aluminium ...	27	5.26	Palladium ...	106	8.0
Silicon ...	28	5.5	Silver ...	108	8.3
Phosphorus ...	31	6.1	Tin ...	118	9.46
Sulphur ...	32	6.6	Antimony ..	120	9.8
Potassium .	39	6.53	Tellurium ...	126	10.8
Calcium ...	40	6.47	Iodine ...	126	10.8
Titanium ..	48	6.2	Barium ...	137	8.8
Chromium ...	52	6.25	Platinum ...	195	9.4
Iron ...	56	6.4	Gold ...	197	9.5
Cobalt ...	59	6.48	Lead ...	207	10.8
Copper ...	63.3	6.8	Uranium ...	240	10.1
Zinc ...	65.5	6.95			

rays was approximately proportional to the density D of the material over a very wide range. The extreme limits of the ratio μ/D were 2070 and 5610, although the absorbing materials employed in the experiments varied in density between 3.6×10^{-7}

* Lenard, *Ann. d. Phys.* **56**, p. 275, 1895.

for hydrogen at 3 mms. pressure to 19.3 for gold. Rutherford* showed that a similar relation held approximately for the swifter β rays from uranium X; but it was shown that the value of μ/D for elements of high atomic weight like lead was about twice as great as for the lighter elements like aluminium. Similar results were obtained by Strutt† for the complex β rays emitted by radium. The question was re-examined by Crowther‡, using

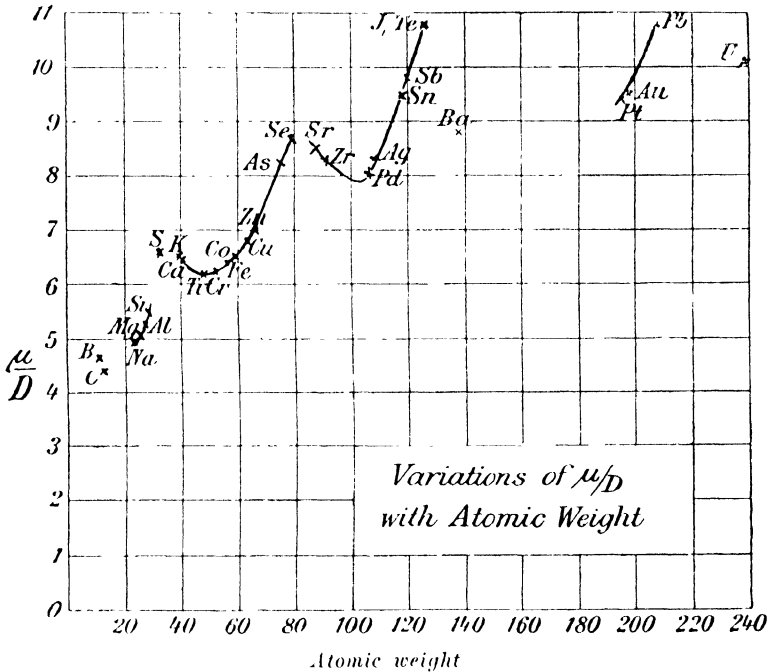

Fig. 61.

a large number of elements, and the results are included in the table on p. 226.

The β rays from uranium X employed as a source of radiation are absorbed approximately according to an exponential law. The coefficient of absorption referred to is the one defined in the last section and is not corrected for reflection of the β rays. It will be seen that the value of μ/D shows for most elements

* Rutherford, *Phil. Mag.* **47**, p. 109, 1899.† Strutt, *Nature*, **61**, p. 539, 1900.‡ Crowther *Phil. Mag.* **12**, p. 379, 1906.

a progressive increase from light to heavier elements, being more than twice as great for lead as for boron.

It has been mentioned in Section 83 that McClelland found that the amount of scattering of β rays from thick layers of different elements showed some connection with their position in the Periodic System. A similar result was found to hold by Crowther for the transmitted rays. The results are shown diagrammatically in Fig. 61. It is seen that the elements arrange themselves along a series of similar curves which correspond closely in extent with the grouping of the elements in the periodic table. In each group of elements, the value of μ/D changes slowly at first and then rises sharply to a maximum.

Such experiments indicate that the value of μ/D is a periodic function of the atomic weights, and is connected with the position of elements in the periodic table. On the other hand, it should be pointed out that when account is taken of the scattered rays, the true coefficient of absorption divided by the density does not show any such marked periodic variations (see Section 89).

Crowther (*loc. cit.*) also showed that the absorption of the β rays for compounds followed an additive law and could be deduced from a knowledge of the absorption of the individual components. The absorption of β rays by liquids has been examined by Campbell*, S. J. Allen†, H. W. Schmidt‡ and Borodowsky§. Using the β rays of radium, the latter showed that their absorption by compounds followed accurately an additive law and did not depend upon the degree of concentration or of chemical dissociation of the liquids. For example, the reduction of intensity of the β rays was determined after passing through two shallow trays, one containing water and the other sulphuric acid. On mixing the contents of the two trays, the intensity of the transmitted radiation was unchanged. This result holds even in cases where precipitation occurs owing to the mixture. The absorption of β rays by a number of organic liquids was examined by Allen, Borodowsky and Schmidt, and was found to follow an

* Campbell, *Phil. Mag.* **17**, p. 180, 1909.

† S. J. Allen, *Phys. Rev.* **29**, p. 178, 1909.

‡ H. W. Schmidt, *Phys. Zeit.* **11**, p. 262, 1910.

§ Borodowsky, *Phil. Mag.* **19**, p. 605, 1910.

additive law. The absorption of the rays by the liquid could be deduced from a knowledge of the absorption of the constituent elements.

It is thus clear that the absorption of β rays is an atomic phenomenon and is not affected by the chemical combination of the atoms. Such a relation appears to hold generally for all types of radiations emitted by radio-active substances.

It is of interest to consider a method of determining the absorption of β rays in the material from which they arise. If the emergent radiation has a coefficient of absorption μ in the active material, it can be simply shown that the intensity I of the rays issuing from a layer of active matter of thickness d is given by

$$I = I_0(1 - e^{-\mu d}),$$

where I_0 is the intensity due to a very thick layer. This equation has been confirmed experimentally by the writer in the case of uranium oxide. I/I_0 was equal to one half for a thickness of oxide corresponding to .11 gr. per sq. cm. This gives a value for μ/D of 6.3. This is a value somewhat greater than that observed for the absorption of the same rays in aluminium. Such a result shows that a substance which gives rise to β rays does not absorb them to a greater extent than does ordinary matter of the same density.

88. The absorption of β rays from radium by air.

Eve* has investigated the distribution of the ionisation in the neighbourhood of a small radium preparation supported in the centre of a large room. In order to avoid the disturbing effects due to absorption and scattering of the β rays by matter, an electroscope was constructed whose sides consisted of thin aluminium foil, and the ionisation produced in this electroscope was measured at different distances from the radium preparation. Using an electroscope with such thin walls, the effect of scattering and absorption of the rays by the electroscope itself is small, and the ionisation observed in the electroscope is very nearly a measure of the amount of the ionisation existing at that place before the electroscope was introduced. At some distance from the radium, he found that the ionisation was proportional to $\frac{e^{-\mu r}}{r^2}$, where r is

* Eve, *Phil. Mag.* **21**, p. 8, 1911; **22** p. 551, 1911.

the distance from the radium preparation, and μ the coefficient of absorption of the β rays by the air. It is well known that the rays from radium are complex; but at some distance from the source the value of μ for air was found to be $\cdot 004$ (cms.)⁻¹ corresponding to the swifter rays from radium C. Consequently, the average path of the β particle in air is $1/\mu$ or 250 cms. By using a thin film of radium B + C as a source of rays, the value of μ was found to vary between $\cdot 012$ and $\cdot 013$ for distances from 40 to 100 cms. By integrating the ionisation observed over a spherical surface, Eve concluded that the total number of ions produced in air by the β rays from radium C corresponding to one gram of radium was about 4×10^{14} and from radium B about $0\cdot 7 \times 10^{14}$. A later determination under more definite conditions was made by Moseley and Robinson in the laboratory of the writer. The total number of ions due to the β rays from radium B + C in one gram of radium was found to be 9×10^{14} .

89. Theories of absorption. From the standpoint of our present knowledge, it is a very difficult matter to formulate a satisfactory theory of the passage of β rays through matter. Taking the simplest case of normal incidence of a pencil of homogeneous β rays on a uniform sheet of matter, it is necessary to take into account the scattering of the β rays and its variation with velocity, and also the reduction of the velocity and penetrating power of the particles as a result of the atomic encounters. There appears to be little doubt that a homogeneous pencil of β rays after transmission through some thickness of matter becomes heterogeneous. It is thus very difficult to obtain a general expression to take into account all the effects. Before this can be done, it will be necessary to know accurately the laws which govern the individual factors involved. Certain fundamental points are not yet definitely settled. For example, it is not known definitely whether the β particle can be stopped in mid career by a violent encounter with an atom, or whether each particle gradually loses its velocity in consequence of a succession of atomic encounters involving scattering and ionisation.

Bragg* has suggested that the β particles of a given velocity

* Bragg, *Phil. Mag.* **20**, p. 385, 1910.

may, like the α particles, have a definite range in matter, and he has collected some evidence in support of this view. In this case, the range does not refer to the distance between the point of entrance and final absorption, but is the integral of the total tortuous path of the β particle. The evidence as a whole indicates that some of the β particles are gradually slowed up by their passage through matter, and that the absorption observed is due to the stopping of those particles which have lost most of their energy by a long succession of atomic encounters. At the same time, there is reason to believe that some of the β particles must suffer a sudden and marked loss of velocity in occasional violent encounters where the β particle passes close to the centre of the atomic system. Both of these factors may be involved in the absorption of β rays by matter. Definite progress has already been made in deducing the laws of scattering for thin films, and in determining the law of retardation of β particles and the variation of ionisation with velocity.

The first attempt to formulate a theory of absorption of β rays taking into account the effect of "scattered rays" which were then thought to be "secondary rays" was made by McClelland* in 1905. He supposed that the reduction in intensity of the pencil of rays depended on (1) a true absorption proportional to the intensity, and (2) a production of secondary or scattered rays which was proportional to the energy absorbed. Expressions were obtained by which the value of the true absorption coefficient and the amount of radiation scattered back from a plate of matter could be deduced.

A somewhat modified theory was developed later by H. W. Schmidt†. He supposed that of the energy I passing through a layer of matter of thickness dx , a part αIdx was absorbed and another part βIdx was scattered back.

The scattered rays were assumed to have the same properties as the primary rays both as regards absorption and scattering, and to result from a volume and not a surface effect. Assuming the rays to be homogeneous and to be unchanged in velocity in

* McClelland, *Roy. Soc. Trans. Dub.* **8**, p. 169; **9**, p. 1, 1905.

† H. W. Schmidt, *Ann. d. Phys.* **23**, p. 671, 1907; *Phys. Zeit.* **10**, p. 929, 1909; **11**, p. 262, 1910.

traversing matter, he deduced that the fraction ρ of the rays scattered back from a plate of thickness x was given by

$$\rho = \frac{p(1 - e^{-2\mu x})}{1 - p^2 e^{-2\mu x}},$$

and δ the transmitted fraction by

$$\delta = \frac{e^{-\mu x}}{1 - p^2 e^{-2\mu x}} \cdot (1 - p^2),$$

where the constants μ and p are connected with α and β by the relations

$$\alpha = \mu \frac{1 - p}{1 + p}, \quad \beta = \frac{2\mu p}{1 - p^2}.$$

When a plate is thick, $x = \infty$ and $\rho = p$, *i.e.* p is the fraction of the total radiation scattered back from the plate. Since p is always less than 1, the equation of the transmitted radiation for small values of x is approximately given by

$$\delta = (1 - p^2) e^{-\mu x}.$$

Schmidt determined the variation of p with x for a number of materials using uranium X as the source of β rays. The values of p for thick plates obtained by Kovarik have been given in Section 83.

Knowing the value of p , the true coefficient of absorption μ can be deduced. The results obtained by Schmidt using the β rays from uranium X are included in the table, p. 233, where A is the atomic weight, D the density of the material, μ the true absorption coefficient, β the reflection or scattering coefficient, and p the total fraction scattered back from thick plates.

It is seen from the table, p. 233, that the values of $\frac{\alpha}{D} A^{\frac{1}{3}}$ and $\frac{\beta}{AD}$ are approximately constant for all substances, the mean values being 11.2 and 12.4 respectively, the maximum departure from the mean being about 14 per cent.

Schmidt considers that these values are universal constants of matter for a given radiation. If

$$c_1 = \frac{\alpha}{D} A^{\frac{1}{3}} \quad \text{and} \quad c_2 = \frac{\beta}{AD},$$

$$\alpha = c_1 D A^{-\frac{1}{3}}, \quad \beta = c_2 A D.$$

The constant of scattering β used by Schmidt is practically equivalent to the fraction of particles deflected through a given angle ϕ , for which the theory has been given in Sections 74 and 85. It has there been pointed out that the experiments on scattering

Scattering and absorption coefficients of elements for the β rays from uranium X

Element	A	D	μ (c.m.s.) ⁻¹	$\mu_0 D$	$100 p$	α (c.m.s.) ⁻¹	β (c.m.s.) ⁻¹	$\frac{\alpha \sqrt{A}}{D}$	$\frac{10^3 \beta}{AD}$
Magnesium	24.36	1.74	10.5	6.03	25.5	6.30	5.76	10.4	13.6
Aluminium	27.1	2.65	15.0	5.66	27.0	8.65	9.63	10.9	12.2
Iron ...	55.9	7.80	57	7.32	40.8	24.0	55.9	11.8	12.8
Nickel ...	58.7	8.90	66	7.42	43.4	26.1	70.5	11.5	13.5
Cobalt ..	59.0	8.5	61	7.17	41.0	25.7	60.0	11.8	11.9
Copper ...	63.4	8.93	66	7.39	42.5	27.0	70.0	12.0	12.4
Zinc ...	65.4	7.19	52.5	7.31	43.2	21.6	56.9	12.1	11.9
Palladium	106.5	11.9	103	8.66	55.0	30.0	160	11.9	12.7
Silver ...	107.9	10.5	90	8.56	55.3	26.0	144	11.8	12.8
Tin ...	119.0	7.3	58	7.95	57.5	15.6	100	10.5	11.6
Platinum	194.8	21.5	200	9.30	66.0	41.0	468	11.0	11.2
Gold ...	197.2	19.3	187	9.70	68.4	36.2	480	11.0	12.6
Lead ...	206.9	11.4	103	9.12	68.4	19.3	266	10.0	11.3
Bismuth ...	208.0	9.8	92.5	9.45	20.0	16.3	254	9.9	12.5

by thin films of matter both with α and β rays indicate that β should be proportional to AD , the empirical relation found by Schmidt.

Since $D = NA$, where N is the number of atoms per unit volume, it follows that α is proportional to the cross section of the atom and β to the volume of the atom.

The above theories are of necessity very imperfect expressions of the facts of absorption, for no account is taken of the retardation of the β particles, nor of the variation of ionisation and scattering with velocity. In addition, the experimental deductions have been made by using β rays which are very heterogeneous. At the same time, such theories are of importance in bringing out some of the main points involved, and in making comparisons on the

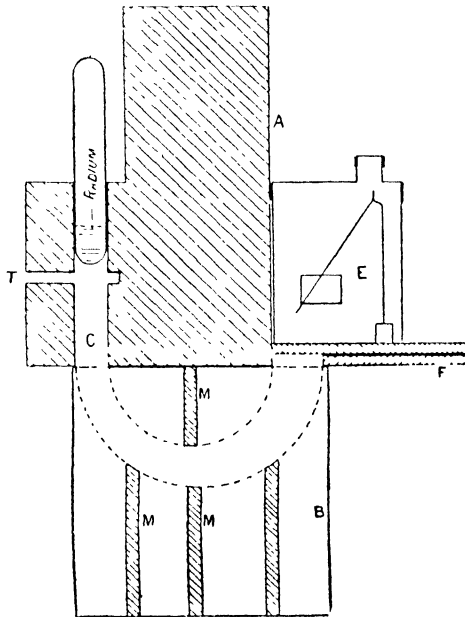

Fig. 62.

character of the absorption and scattering by different elements. It seems not unlikely that the relations between absorption and scattering for different elements deduced by Schmidt with the aid of the theory may prove to have an essential basis in fact.

90. The absorption of homogeneous rays. We have seen that it was initially supposed that an exponential law of absorption of β rays indicated that the β rays were all projected with the same speed. By sorting out rays of a definite velocity by

means of a magnetic field, W. Wilson* found that homogeneous rays were not absorbed according to an exponential law. The experimental arrangement is shown in Fig. 62. The source of radiation was either radium itself or a small glass tube filled with radium emanation. The complex rays from the source passing through a magnetic field were bent into circles of different radii. The velocity of the rays entering the electroscope E was consequently determined by the strength of field. Since the openings

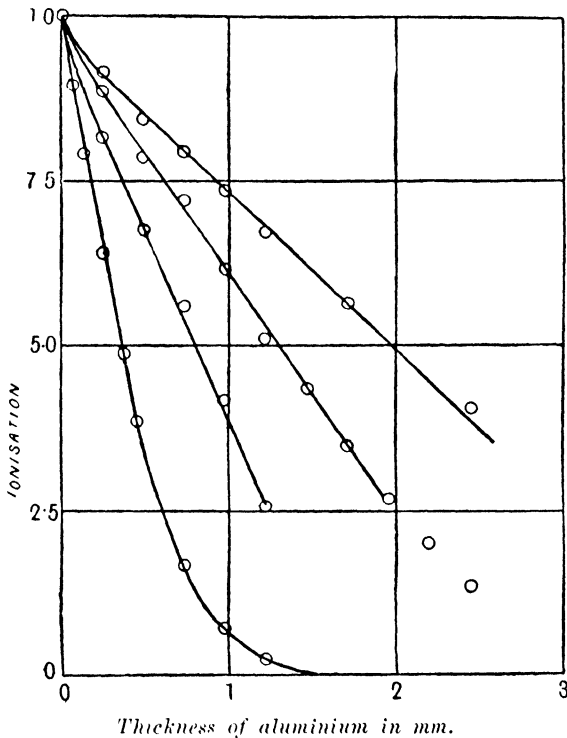

Fig. 63.

were of finite size, the rays entering the electroscope, although approximately homogeneous, consisted of β particles whose velocity varied by about ten per cent. The screens MM were placed in position to constrain the path of the rays, and to prevent as far as possible scattered rays from entering the electroscope. The absorption of the rays was measured in the electroscope E by placing screens of different thickness over the opening in the

* W. Wilson, *Proc. Roy. Soc. A*, **82**, p. 612, 1909.

bottom of the electroscope. The effect of direct β and γ rays was cut off to a large extent by a suitable lead screen A ; but in each experiment the effect of the γ rays in the electroscope had to be allowed for. The general results obtained for aluminium are shown in Fig. 63 for rays of different velocity. It will be seen that the curves plotted with the ionisation current as ordinate, and thickness of screen as abscissa, are nearly straight lines over a considerable range of thickness and depart widely from the ordinary exponential curve. Later Crowther* repeated the experiments using the general arrangement shown in Fig. 59.

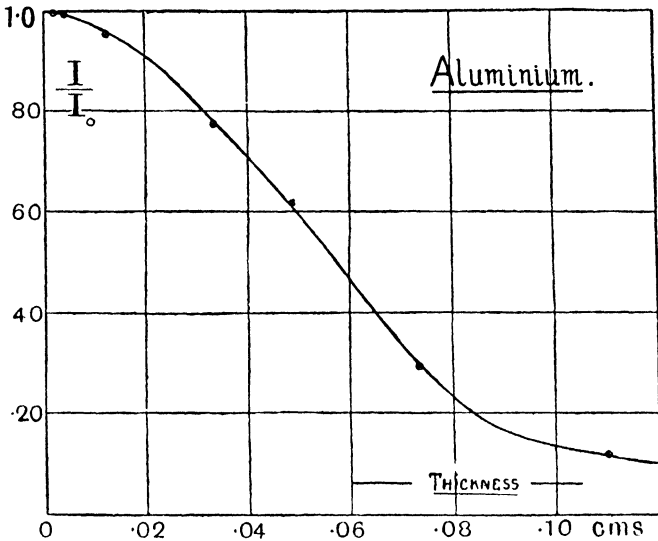

Fig. 64.

The vacuum chamber S was removed and a hemispherical ionisation vessel substituted and the opening D was closed with thin aluminium. The rays were rendered more homogeneous than those employed by Wilson. The absorption curve obtained for aluminium is shown in Fig. 64. The ionisation at first falls off slowly, then nearly according to a linear law and finally more slowly, but the latter part of the curve could not be determined accurately. The initial part of the curve would indicate that there was little, if any, absorption for thin layers, but the reduction was mainly due to scattering of the rays on the side of incidence. On the other hand, Crowther found that if the

* Crowther, *Proc. Roy. Soc. A*, **84**, p. 226, 1910.

homogeneous rays were first passed through a platinum plate 0.001 cm. thick, the emerging rays were absorbed very nearly according to an exponential law. The explanation of this effect is not obvious, but it is probably connected with the wide difference in the scattering coefficient for aluminium and platinum*. The rays passing through 0.001 cm. of platinum are very completely scattered, and the effect of this scattering may make the rays heterogeneous to some extent as regards velocity. The question of the nature of the absorption of very homogeneous pencils of β rays has been later examined in detail by W. Wilson (*Proc. Roy. Soc.* 1912).

The experiments of Wilson indicate that for approximately homogeneous beams, the rays must decrease steadily in velocity in traversing the aluminium. On his results, the intensity I of the rays measured by the ionisation current after passing through a thickness x is given by $I = k(a - x)$ where a is the distance from the origin of the point where the straight line if produced cuts the axis of abscissae. If we define the coefficient of absorption μ in the usual way, viz. $dI = -\mu I dx$, it is seen that $\mu = 1/(a - x)$. The absorption coefficient is thus not constant but increases in value with the thickness x traversed. Such a result indicates that the rays decrease rapidly in penetrating power and consequently in velocity in their passage through matter. This was shown later to be the case by Wilson (Section 92) and the decrease of velocity was found to be in fair accord with that deduced from the change of the coefficient of absorption with thickness. It must not, however, be forgotten that the interpretation of the amount of ionisation due to the transmitted rays depends on three factors, (1) the scattering of the β particles back on the side of incidence, (2) the number of β particles stopped by the matter, and (3) the change with velocity of ionisation per unit path of the particle. The importance of each of these factors requires to be settled before any very definite deductions can be made.

The apparent absorption according to an exponential law of β rays from some radio-active substances is not easy to account for on these results. It would appear that the rays must be complex to a considerable extent before such a law of absorption can hold even approximately. Wilson has calculated from his

* See Bragg, *Phil. Mag.* 20, p. 385, 1910.

results the distribution with velocity of β particles required to give approximately an exponential law of absorption. Gray and Wilson* found that the absorption of β rays from radium E, which were shown to be complex both by the electric and photographic method, was the same for a thick and thin layer over a considerable range of thickness. Such a result shows that the initial distribution of β rays with velocity for a thin film must be nearly the same as the distribution in the case of a thick layer. At the same time, the experiment of Crowther on the exponential law of absorption of homogeneous β rays after traversing some thickness of platinum, indicates that the results are to a large extent affected by the nature of the absorbing screen.

91. Variation of absorption with speed. It was early recognised by Becquerel that radium emitted complex β rays, and that their penetrating power increased rapidly with velocity. From the considerations advanced later in Section 95, it will be seen that the sources of β radiation ordinarily employed are not homogeneous, so that the coefficient of absorption found in the usual way applies to a mixture of rays of different speeds. The mean velocity of the β rays emitted by radium E and uranium X have been determined by H. W. Schmidt† using an electric method and found to be 2.31×10^{10} and 2.76×10^{10} cms. per second respectively. These rays are absorbed according to an exponential law and give values of $\mu = 43.3$ and $\mu = 15$ (cms.)⁻¹ respectively for aluminium. These results show that the value of μ decreases rapidly with increase of average velocity of the rays.

The absorption of cathode rays has been investigated by Lenard, who found that the absorption coefficient μ varies inversely as the fourth power of the velocity and is nearly proportional to the density of the material over a wide range. No doubt the cathode rays employed by Lenard were heterogeneous, and the absorption coefficients found by him correspond to a mixture of rays of different velocities. The value of μ for the cathode rays is very large compared with that for the much swifter rays from active substances.

* Gray and Wilson, *Phil. Mag.* **20**, p. 870, 1910.

† H. W. Schmidt, *Phys. Zeit.* **8**, p. 361, 1907; **10**, p. 6, 1909.

The variation of absorption with speed for homogeneous rays has been investigated by Wilson by the method described in the previous section.

The absorption curve for aluminium was approximately linear, and the coefficient of absorption was deduced from the relation $\mu = 1/(a - x)$ where x is the thickness of aluminium traversed and a the distance from the origin where the straight line if produced cuts the axis of abscissae (see Fig. 63). The results are included in the following table where u is the velocity of the incident rays.

$H\rho$ (Gauss cm.)	u (cms. per sec.)	a (in mms.)	μ (cms.) ⁻¹	$\left(\frac{mu^2}{e}\right)^{\frac{3}{2}} \mu$
1310	1.79×10^{10}	0.14	71.5	8.12×10^{21}
1860	2.20 "	0.26	38.5	10.01 "
2760	2.545 "	0.70	14.3	8.41 "
3860	2.74 "	1.32	7.6	8.27 "
4450	2.794 "	1.67	6.0	8.33 "
5390	2.855 "	2.08	4.81	9.17 "
6350	2.899 "	2.64	3.79	9.43 "
8000	2.920 "	3.29	3.04	10.8 "
8580	2.930 "	4.09	2.44	9.87 "
8960	2.937 "	4.69	1.13	9.09 "
Average				9.25×10^{21}

It is seen that there is a rapid variation of μ with velocity. For an increase of velocity from 1.79 to 2.937×10^{10} , the value of μ varies in the ratio of 63 to 1. In the last column, the writer has included the value $\left(\frac{mu^2}{e}\right)^{\frac{3}{2}} \mu$ for the β particle. This is seen to be approximately constant over the range of velocities examined. We may consequently conclude that $\mu \propto E^{-\frac{3}{2}}$ approximately where E is the energy of the incident β particle. The above relation is of value in considering the connection between the change of absorption and change of velocity of the β particle in passing through matter. Whiddington* concludes that $\mu \cdot v^4$ is a constant for slow β rays excited by X rays.

* Whiddington, *Proc. Camb. Phil. Soc.* **16**, p. 326, 1911.

Since we have seen that $\mu = 1/(a - x)$ where x is the thickness of matter traversed, $E^{\frac{3}{2}} = k(a - x)$, where k is a constant. Suppose that the energy of the incident particle is E_0 when $x = 0$; then $E_0^{\frac{3}{2}} - E^{\frac{3}{2}} = kx$ gives the relation between the energy E of the issuing particle and the thickness of matter traversed. It will be seen in the next section that the reduction of velocity of the β rays in passing through aluminium can be approximately expressed by an equation of this type.

If it be supposed that the decrease of energy of the transmitted pencil of rays is due entirely to the *ionisation* produced in the substance, the variation of ionisation with velocity can be at once deduced. Since $E^{\frac{3}{2}} = k(a - x)$, $dE/dx \propto (a - x)^{-\frac{1}{2}} \propto E^{-\frac{1}{2}}$. Suppose that the radiation passes through one centimetre of gas, then if the absorption of energy dE is proportional to the number of ions produced in traversing one centimetre, $I \cdot \sqrt{E}$ is a constant, *i.e.* the ionisation per unit path varies inversely as \sqrt{E} or $\sqrt{mv^2}$.

It will be seen (Section 93) that this relation approximately expresses the variation of ionisation with velocity for swift β rays. It is of interest to note that this relation is equivalent to that deduced for the α particle by Geiger (Section 68).

92. The retardation of the β particles. The laws of absorption of β particles by matter is very similar in solids, liquids and gases. Since it is known that the passage of the β particle through gases is accompanied by ionisation and consequently by absorption of energy, it seems probable that ionisation is also produced by the β particle in passing through liquid and solid matter. It is thus to be expected that the velocity of the β particles should decrease in passing through matter. This has been simply shown in the case of the α rays, where homogeneous radiations are available. In the case of the β rays, the diminution of velocity has been more difficult to determine, partly on account of the difficulty of obtaining homogeneous β radiation, and partly on account of the marked scattering of the β rays in passing through matter. The initial experiments on the absorption of β rays at first led to the conclusion that the reduction of velocity in passing through matter must be small. This question was

examined in detail by W. Wilson*. The experimental arrangement is shown in Fig. 65. The rays from a tube *A* filled with radium emanation passed between the pole pieces of an electro-magnet *C*, described a circular path, and passed through an opening *O* between the poles *D* of another electro-magnet, where they were again bent to enter the electroscope *E*. In this way, rays of a definite velocity were made to pass through an absorbing screen at *O*, and the velocity of the emerging rays was then analysed by the *second* magnetic field.

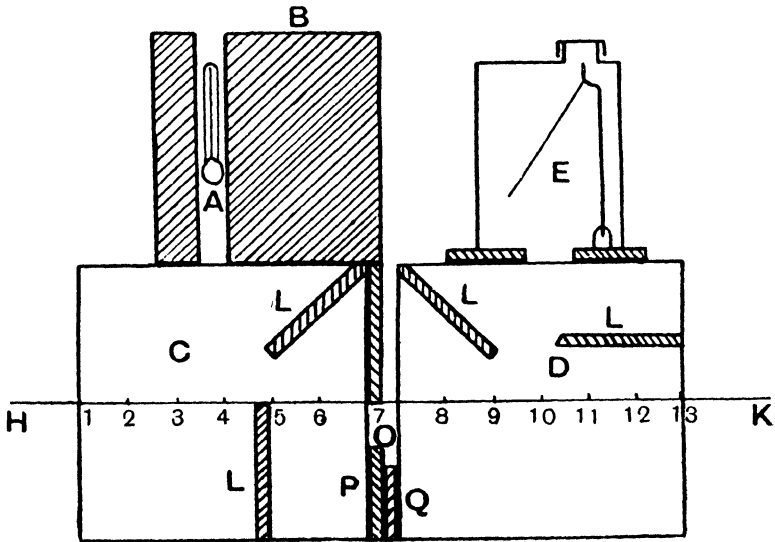

Fig. 65.

The method of conducting the experiment was as follows: By passing currents of known strength through the electro-magnets *C* and *D*, an approximately homogeneous radiation was allowed to pass through the hole *O* into the magnetic field *D*. The field in *D* was varied, while that in *C* was kept constant. The ionisation in the electroscope was determined for each value of the field in *D*, and the values thus obtained were plotted against the current through *D*. The curve *A* (Fig. 66) shows the variation of ionisation with current when there is no screen at *O*. If the rays had been completely homogeneous, it would be

* W. Wilson, *Proc. Roy. Soc. A*, **84**, p. 141, 1910.

expected that they could only pass in the electroscop E for a definite value of the current in D . In consequence, however, of the finite width of the openings, the rays were not completely homogeneous. Under these conditions, an effect in the electroscop is observed over a considerable range of current in the second electro-magnet, but the curve has a sharp maximum which corresponds to the rays of mean velocity. The curves B , C , D

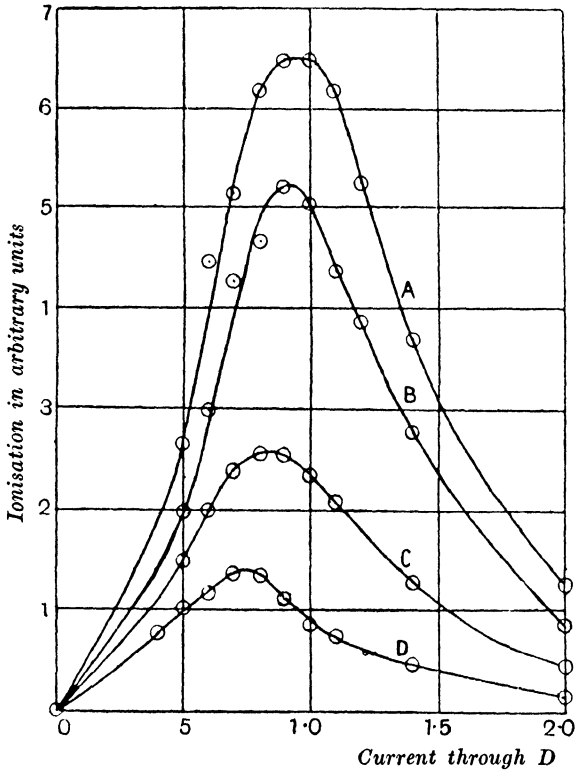

Fig. 66.

were obtained when screens of aluminium of increasing thickness were placed at O . The effect of these screens is to reduce markedly the ionisation due to the β rays in the electroscop. It is seen that the maxima of the curves are displaced towards the *lower* magnetic fields. This shows that the average velocity of the issuing rays has been *reduced* by traversing matter. This reduction of velocity is also shown by the increase of the coefficient of absorption μ of the issuing rays with thickness of

matter traversed. The results are shown in the following table starting with β particles of velocity 2.86×10^{10} cms. per second.

The velocity was determined from the curvature of the path of the rays using the Lorentz-Einstein formula. It is seen that the reduction of velocity in passing through a considerable thickness of aluminium is apparently not very marked; but it must be borne in mind that this alteration in velocity corresponds to a marked change in the energy and penetrating power of the transmitted particles. For example, the rays of velocity 2.00×10^{10} are half absorbed by a thickness of matter less than 1/10 that required

Thickness of Al. in mm.	μ in cm. ⁻¹	Velocity in 10^{10} cm./sec.	Energy of β particle in ergs
0.00	4.7	2.86	18.6×10^{-7}
0.51	6.2	2.80	14.3 "
0.83	7.7	2.75	12.0 "
1.03	9.1	2.70	10.4 "
1.20	10.8	2.65	9.2 "
1.34	12.7	2.60	8.1 "
1.48	15.4	2.55	7.15 "
1.58	18.2	2.50	6.5 "
1.66	21.3	2.45	5.9 "
1.72	24.1	2.40	5.4 "
1.78	28.6	2.35	4.9 "
1.82	32.3	2.30	4.5 "
1.86	37.0	2.25	4.1 "
1.88	40.0	2.20	3.8 "
1.95	55.5	2.00	2.75 "

for particles of velocity 2.86×10^{10} . The results clearly show that, on an average, the β particles do diminish in velocity in passing through matter and that consequently their absorption coefficient undergoes a progressive change.

It has been deduced in the last section that the relation between the energy E of the transmitted particle and the thickness x of matter traversed should be given by $E_0^{\frac{3}{2}} - E^{\frac{3}{2}} = kx$ where k is a constant and E_0 the energy of the incident particle. This formula is in fair agreement with the results included in the above table. Wilson (*loc. cit.*) has shown that the results are also approximately expressed by a formula of the type $E_0 - E = k_1 x$, but on account

of the uncertainty in the measurement of the lower velocities, it is difficult to decide definitely between this relation and a relation of the type $E_0^2 - E^2 = k_1x$. From measurements of the retardation of cathode rays between velocities 5.3×10^9 and 8.6×10^9 cms. per second Whiddington* concludes that the retardation is expressed by the formula $V_0^4 - V^4 = kx$ where V_0 is the initial velocity of the β particle and V the velocity of the issuing particles after traversing a thickness x of matter.

Decrease of velocity by the photographic method.

The decrease of velocity of the β particles in passing through matter has been shown by v. Baeyer† in a striking way by the photographic method. It will be seen in the next section that the active deposit of thorium expels several sets of homogeneous β rays. This is shown by the photographic method using an apparatus similar to that given in Fig. 23. The writer is indebted to Dr v. Baeyer for the photograph reproduced later in Fig. 70 A. The central part *A* of the figure shows the photograph obtained when the active wire is uncovered. The dark band in the centre is due to the α and γ rays. The symmetrical bands on either side due to the β rays are obtained by reversal of a weak magnetic field. The dark bands on the right and left correspond to an emission of a set of homogeneous rays of velocity 1.89×10^{10} cms. per second. The upper and lower parts *B* and *C* of the figure show the deflection of the same rays after passing through .044 cm. and .022 cm. of aluminium respectively. It is seen that the bands are more deflected than before showing that the velocity of the transmitted β rays has been reduced in their passage through the aluminium. The reduction of velocity is more marked for the thicker sheet of aluminium. The bands after traversing the aluminium are still distinctly defined showing that the transmitted rays are approximately homogeneous. It can also be observed in the photograph that the intensity of the band of higher velocity becomes relatively more marked after passing through the aluminium. It is difficult to decide with certainty from such photographs whether the homogeneous β rays remain entirely

* Whiddington, *Proc. Camb. Phil. Soc.* **16**, p. 321, 1911.

† v. Baeyer, *Phys. Zeit.* **13**, p. 485, 1912.

homogeneous after traversing matter. It would be difficult, for example, to decide whether a fraction of the transmitted β particles were heterogeneous as regards velocity, since the photographic effect of the distributed rays would be too feeble to detect.

93. Ionisation and velocity of the β particle. The activity of β rays and their absorption by matter are usually measured by the electric method. Since many radio-active substances emit β particles with a wide range of velocity, it is of importance for the interpretation of results to know how far the ionisation current is a measure of the number of β particles present. This will obviously depend upon the variation with velocity of the number of ions produced by a β particle in its passage through the gas in the ionisation chamber. In his experiments on ionisation by collision, Townsend found that the number of ions produced by an electron moving in an electric field was small at first for weak fields, but increased with the strength of an electric field to a maximum corresponding to a production of about 20 ions per centimetre of path in air at a pressure of one millimetre. Under these conditions, each collision of the electron with an atom produced a pair of new ions. Suppose next the electron is expelled with sufficient velocity to produce a number of ions before it is stopped and that no electric field is acting. The ionisation per unit path in the gas then decreases rapidly with increase of velocity of projection. This is shown by the experiments of Durack* with the cathode rays. The charge carried by the cathode rays emerging from a Lenard tube was measured and also the ionisation produced by them in air at low pressures. The number α of ions produced per centimetre of path per particle is for such swift particles proportional to αp , where p is the pressure, supposed small. The value of α for $p = 1$ mm. of mercury was found to be 0.43 for air with rays of average velocity (recalculated) 7×10^9 cms. per second. A recent determination of α has been made by Glasson† under more definite conditions, who found a value $\alpha = 1.5$ for cathode particles of velocity 4.8×10^9 cms per second. In a similar way, Durack‡ determined the value of

* Durack, *Phil. Mag.* 4, p. 29, 1902.

† Glasson, *Phil. Mag.* 22, p. 647, 1911.

‡ Durack, *Phil. Mag.* 5, p. 550, 1903.

α for high speed β particles (average velocity about 2.6×10^{10}) emitted by a radium preparation. The value of α was still lower, viz. 0.17 at 1 mm. pressure, showing that only one pair of ions is, on the average, produced by the β particle traversing 6 cms. of air at 1 mm. pressure. Recent estimates by different methods have been made by Eve* and by Geiger and Kovarik†. The former found that on an average a β particle from radium C produced 48 ions per cm. of path at atmospheric pressure, while Geiger and Kovarik found 108. The corresponding values of α are .06 and .13 respectively. It is difficult to make a direct comparison of these two numbers as the measurements were made under very different conditions. The number given by Geiger and Kovarik refers to the ionisation over the first centimetre of path of the *average* β particle from radium C; the value by Eve to the average ionisation per centimetre produced by the β particles along their whole path.

It is thus clear that the high speed β particle is a very inefficient ioniser compared with the α particle. From the results given by Geiger (Section 67) it is seen that the α particle at its highest velocity produces about 2250 ions per millimetre of path in air at atmospheric pressure, or 30 ions per cm. at 1 mm. pressure. The relative ionisation per unit path produced by the average α or β particle expelled from radium thus varies in the ratio of about 200 to 1.

It has been deduced in Section 91 that, if the loss of energy of the β rays is due mainly to the energy required for ionisation, the ionisation per unit path of the β particle should vary as $1/E^{1/2}$ where E is the energy of the β particle. It is of interest to calculate on this assumption the value of α in air (number of ions per cm. at 1 mm. pressure) for different values of the velocity. The latter is expressed in the table by β , the ratio of the velocity of the β particle to the velocity of light. For the purpose of calculation, the value of Glasson $\alpha = 1.5$ for $\beta = .16$ is assumed to be correct.

Value β	.012	.05	.1	.16	.2	.3	.4	.5	.6	.7	.8	.9	.95
Value α	20	4.8	2.4	1.5	1.2	.8	.57	.46	.36	.29	.23	.16	.096

* Eve, *Phil. Mag.* **22**, p. 551, 1911.

† Geiger and Kovarik, *Phil. Mag.* **22**, p. 604, 1911.

It is of interest to note that the values obtained for high velocities are in reasonable agreement with the data so far obtained. The value of α reaches 20 for a velocity 3.6×10^8 cms. per second, while Townsend observed that an electron produces a pair of ions in each collision when the velocity was that acquired in moving freely between two points of differ-

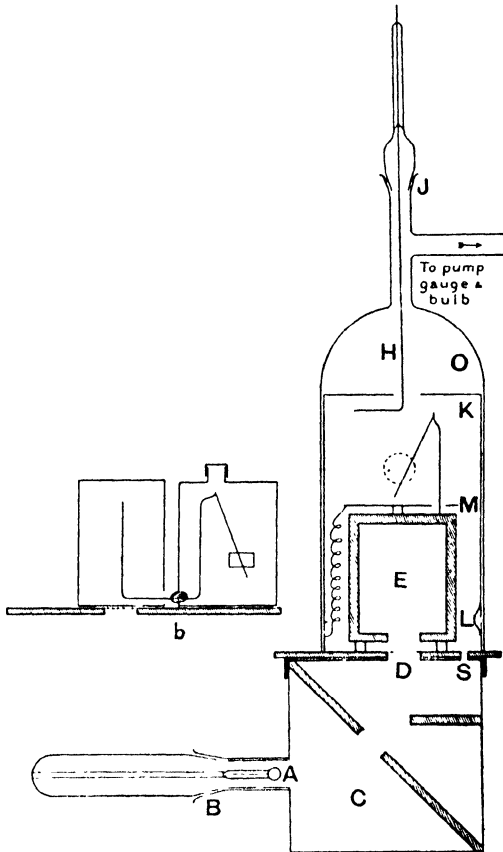

Fig. 67.

ence of potential 20 volts. This corresponds to a velocity of 2.6×10^8 cms. per second. For a velocity corresponding to that of initial expulsion of an α particle from radium C, viz. 2.06×10^8 cms. per second, the value of α is 3.5 for the β particle and 30 for the α particle. Consequently at the same speed an α particle produces in air nearly 9 times the number of ions produced by a

β particle. Since the α particle carries twice the charge of the β particle and is also of much greater mass, this difference in efficiency is about that to be expected on general theoretical grounds.

An investigation has been made by W. Wilson* to determine the variation of ionisation of high speed β particles with velocity. For this purpose, a small tube filled with the radium emanation served as an intense source of β rays. The general arrangement employed is seen in Fig. 67. The rays from the source at A passed into a flat brass box C fixed between the pole pieces of an electro-magnet, were bent by the magnetic field and entered the copper vessel E , in which the charge carried by the pencil of β rays was measured by means of a gold leaf electro-scope attached to it. The whole apparatus was hermetically sealed and exhausted to a low vacuum. A number of screens were arranged in the vessel C to cut off stray radiation, so that the rays entering D were approximately homogeneous after being sorted out by the magnetic field. By varying the magnetic field, β particles of different velocities entered the vessel E , and their charge was measured. The velocity of the particles was deduced from the radius of curvature of the rays, assuming the Lorentz-Einstein formula. In order to measure the ionisation, the vessel E was removed and an ionisation vessel b was substituted. Air was admitted to a low pressure, and the ionisation was measured for pressures between 1 and 50 millimetres. At such low pressures, the ionisation is proportional to the pressure. The results are given in the table on p. 249.

Column II gives the velocity of the β particles; column III, the charge carried by the β particles which entered the electro-scope for different mean velocities; column IV, the observed ionisation in arbitrary units for a constant air pressure. Since many of the β particles are diffusely reflected from the walls of the ionisation vessel and after a number of successive reflections are absorbed by the walls, the ionisation observed is much greater than that due to the β particle in traversing the length of the vessel. Since the amount of reflection (Section 83) is a function of the velocity of the β particles, it is necessary to correct the

* W. Wilson, *Proc. Roy. Soc. A*, **85**, p. 240, 1911.

observed ionisation for reflection. The corrected values are given in column V. Column VI gives the values I of the corrected ionisation divided by the charge; I in this case corresponds to the relative ionisation per particle in travelling the length of the vessel. Column VII gives the product Iu^2 where u is the velocity of the β particle, and column VIII the relative values $I \cdot E^{\frac{1}{2}}$ where E is the energy of the β particle. From the

I	II	III	IV	V	VI	VII	VIII
$H\rho$ Gauss cm.	u 10^{10} cm./ sec.	Relative No. of particles (charge)	Relative Ionisation	Ionisation corrected for reflection	Ionisation Charge = I	Iu^2	$I \cdot E^{\frac{1}{2}}$
850	1.35	49	7.67	7.67	15.7	28	168
1150	1.66	73	9.82	8.31	11.4	31	157
1390	1.87	87	10.99	8.10	9.3	32	150
1650	2.08	105	10.97	7.20	6.85	30	127
1890	2.23	106	10.47	6.50	6.14	30	126
2160	2.35	108	9.77	5.89	5.45	30	123
2440	2.46	102	8.64	5.06	4.95	30	121
2750	2.55	104	7.82	4.66	4.48	29	119
3300	2.67	89	6.44	3.63	4.08	29	121
3900	2.74	76	5.43	3.06	4.03	30	132
4800	2.82	56	3.82	2.16	3.86	31	142
5430	2.86	47	2.97	1.71	3.64	30	142
5910	2.88	44	2.58	1.52	3.46	29	143
6350	2.90	39	2.23	1.37	3.52	30	155

Mean 137

agreement of the product Iu^2 for different velocities, Wilson concluded that the ionisation per unit path was inversely proportional to the square of the velocity over the range of measurement.

We have seen above that it is to be expected that the ionisation should vary as $1/E^{\frac{1}{2}}$. Consequently $I \cdot E^{\frac{1}{2}}$ should be a constant. The values of this product given in the last column do not agree so well with one another, as the values for the relation given by Wilson. Considering, however, the difficulty of the measurements, the agreement is sufficiently good to indicate

that the ionisation may be taken to vary inversely as the square root of the energy of the β particle. The actual value of the ionisation in a copper vessel uncorrected for reflection was found to be expressed very nearly by a relation of the form $I = k(c - u)$ where k and c are constants.

Geiger and Kovarik* have determined the average number of ions produced per β particle for the first centimetre of its path in air at atmospheric pressure for a number of β ray products. The total average ionisation due to each β particle was calculated from this quantity. In these experiments, the actual number of β particles emitted by the material was not directly measured, but it was assumed that each atom in disintegrating emitted one β particle. The number of atoms disintegrating per second was obtained by counting the α particles emitted by the product itself, or by a product in equilibrium with it. The results are included in the following table:

Substance	Absorption Coefficient μ (cms.) ⁻¹ in aluminium	Current per β particle in e.s. units. Average Value	Number of Ions produced in first cm. of path	Whole number of Ions produced
Actinium D ...	28.5	6.3×10^{-8}	136	10.0×10^3
Thorium C + D	16.3	6.3 "	136	17.3 "
Radium B ...	75.0	6.2 "	133	3.7 "
Radium C ...	13.5 to 50	5.0 "	108	7.7 "
Radium E ...	43.3	3.2 "	69	3.3 "
Uranium ...	14.4	3.6 "	78	11.3 "
Thorium B ...	130	20 "	—	—
Radio-actinium	175	0.7 "	—	—
Actinium B ...	125	0.4 "	—	—
Radium D ...	120	0.5 "	—	—

94. Distribution with velocity of the β rays. It was early recognised that the β rays from radium and thorium were complex and consisted of β particles projected over a considerable range of velocity. The distribution of particles with velocity depends to a large extent on the thickness of the layer of

* Geiger and Kovarik, *Phil. Mag.* **22**, p. 604, 1911.

radio-active material from which the radiations emerge, and also on the thickness of the screens surrounding the preparation. The distribution with velocity of the β particles from a preparation of radium was first determined by Paschen* by measuring the total charge carried by the β rays which were not bent away by a known magnetic field. The results are shown in Fig. 68. Curve I gives the charge due to the β rays for different values of the magnetic field. Curve II is the first differential of Curve I, and the ordinates represent the relative number of β particles

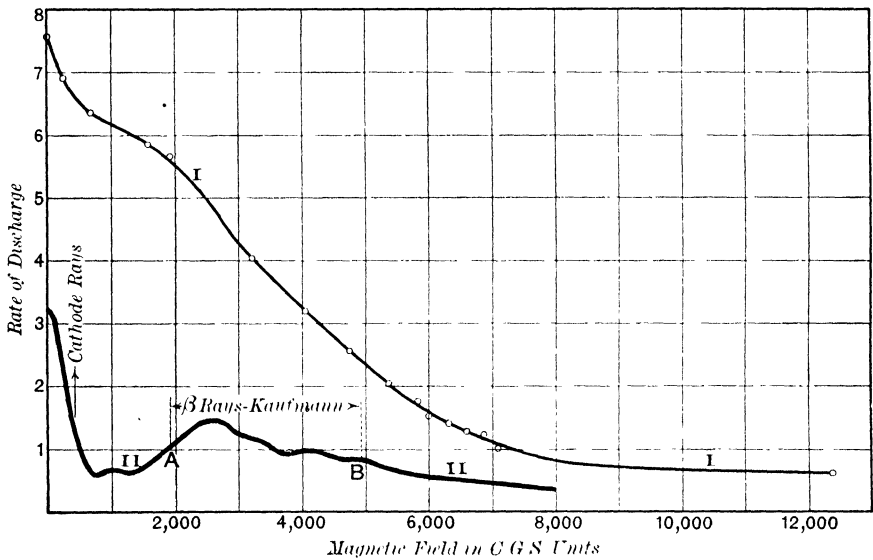

Fig. 68.

for each velocity. It is seen that a considerable number of slow velocity rays are present, but the curve shows a maximum for the penetrating radiations for a field corresponding to 2500 Gauss.

If the distribution is examined by sorting out the β rays by a magnetic field, and measuring the ionisation current due to them in an electroscope, the distribution† is similar to that shown in Fig. 69, curve *a*. The ionisation reaches a maximum for a value 3500 Gauss, which corresponds to a velocity of 2.7×10^{10} cms. per second. The distribution curve depends on the thickness of

* Paschen, *Ann. d. Phys.* **14**, p. 389, 1904.

† W. Wilson, *Proc. Roy. Soc. A*, **82**, p. 612, 1909.

matter traversed. Curves *b* and *c* give the distribution after passing through 0.489 and 1.219 mms. of aluminium respectively placed *under* the electroscope (see Fig. 67); *d* and *e* are corresponding curves when the screens are placed in the path of the rays *before* entering the magnetic field.

95. Homogeneous groups of β rays. We have already outlined in Section 82 the changes of view in regard to the

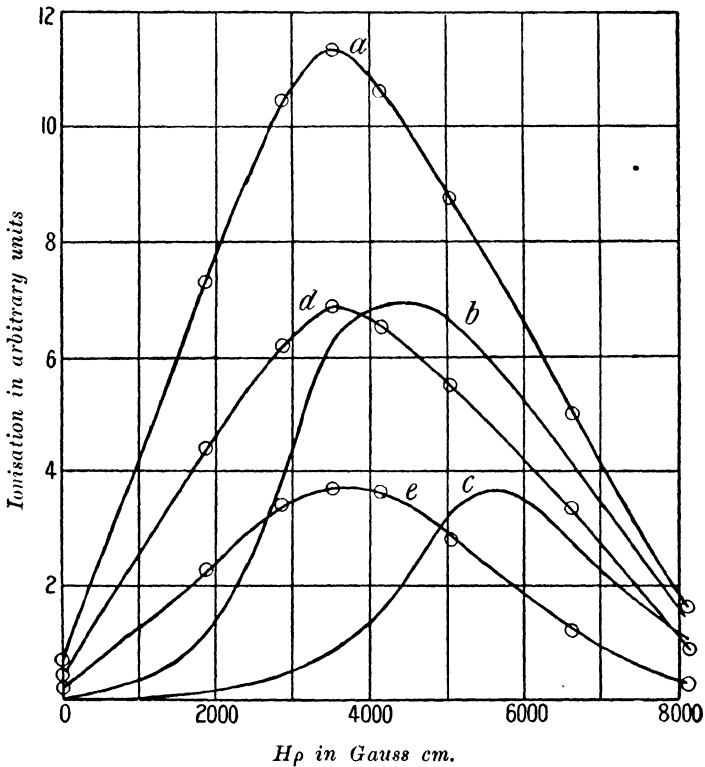

Fig. 69.

absorption of β particles by matter. A notable advance in our knowledge of the emission of β particles by different kinds of radio-active matter has resulted from the investigations of v. Baeyer, Hahn and Meitner*. They have examined by a photographic method the "spectrum" in a magnetic field of the β rays expelled from thin films of radio-active matter. The arrangement

* v. Baeyer and Hahn, *Phys. Zeit.* 11, p. 488, 1910. v. Baeyer, Hahn and Meitner, *Phys. Zeit.* 12, pp. 273, 378, 1911; 3, p. 264, 1912.

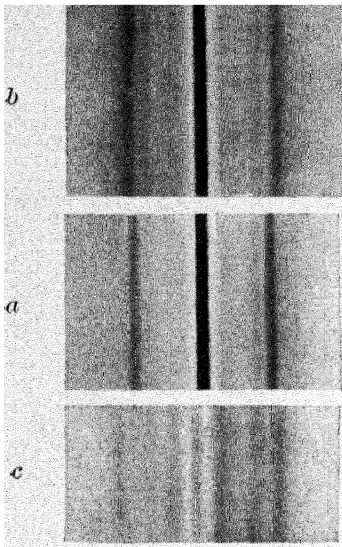

Fig. 70 A.

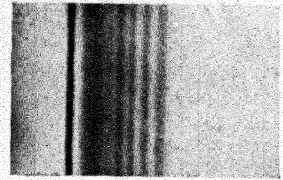

Fig. 70 B.

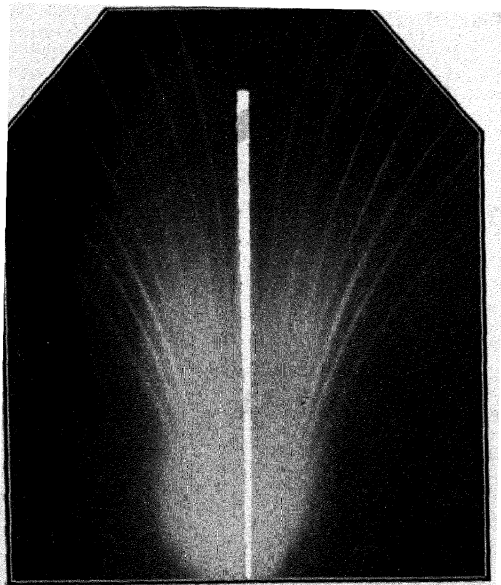

Fig. 70 c. (Nat. size.)

of the experiment is very similar to that shown in Fig. 23, used for the α rays. The source of radiation was a fine wire coated with a very thin film of radio-active matter. The experiments were made in a vacuum with the wire unscreened, so that the α rays produced a strong effect on the plate. These α rays are only very slightly deflected for magnetic fields sufficient to give a large deviation of the β rays. It was found that in many cases sharp bands were obtained on the photographic plate showing that the active matter emitted sets of homogeneous β rays with different but characteristic velocities. Examples of the results obtained for the active deposit of thorium have already been mentioned in Section 92 and are shown in Fig. 70 A. The distribution of the groups of β rays from mesothorium 2 is shown in Fig. 70 B. The writer is indebted to Dr Hahn for this photograph. Fig. 70 C obtained by the writer shows some of the more marked groups of β rays which are emitted by the active deposit of radium. In this case the rays from a fine tube containing radium emanation, after passing through a narrow slit, fell on a photographic plate placed at an angle of about 45° with the horizontal. The central dark line is due mainly to the α rays. The magnetic field was reversed during the experiment.

It was at first thought that each of the bands was due to a group of homogeneous rays, but a closer investigation has shown that while the easily absorbed rays of comparatively slow velocity give sharp bands or traces on the photographic plate, some of the more penetrating rays of swifter velocity, for example those from thorium D, show broader and more diffuse bands. This difference is of great interest. The results indicate that the slow velocity particles are emitted with a definite and characteristic velocity, but that the more penetrating rays consist either of particles projected over a considerable range of velocity or contain a number of groups of rays. This photographic method of analysis has proved of great value, and has led to a definite determination of the velocities of the sets of rays emitted from different kinds of active matter. The general results show that the emission of β rays is a very complex phenomenon, and there appears to be no definite connection between the number of α and the number of groups of β particles emitted by any given product. For example,

it is known that the β radiation from radium B and C together consists at least of twenty-nine distinct sets of β rays, which show clearly on the photographic plate. Consequently in these two successive transformations, where only one α particle is emitted per atom of radium C, there are at least twenty-nine sets of β particles. The bearing of these results on the character of the transformations will be considered later in Chapter XVIII.

There appears to be no doubt that the number of β particles emitted in each of the sets of rays is only a fraction of the total number of atoms transformed, for we have seen (Section 80) that Moseley could detect the presence of only about 2.1 β particles corresponding to the transformation of an atom of both radium B and radium C. The examination of the types of rays emitted by β ray products has not been completed, but the velocities so far obtained are given below.

<u>Substance</u>	<u>Velocity of groups of rays as fractions of the velocity of light</u>
Uranium X	Continuous β ray spectrum
Radium (freed from active deposit)	.52, .65
Radium B	.36, .41, .63, .70, .74
Radium C	.80, .86, .94, .98
Radium D	.33, .39
Radium E	Continuous β ray spectrum
Mesothorium 2	.37, .39, .43, .50, .57, .60, .66
	The swifter rays have not yet been analysed
Thorium X	.47, .51
Thorium B	.63, .72
Thorium C+D	.29, .36, .93—95 (broad band)

It is of interest to note that the radiations from both uranium X and radium E give an apparently continuous spectrum on the photographic plate, and no definite evidence of the emission of groups of homogeneous rays has yet been obtained.

The β ray products of actinium have not yet been analysed on account of the difficulty of obtaining sufficiently active preparations.

Danzysz* has recently published a more complete list of the different sets of β rays emitted from the radium emanation. The

* Danysz, *C. R.* **153**, pp. 339, 1066, 1911; *Le Radium* **9**, p. 1, 1912.

emanation from about 200 milligrams of radium was concentrated in a very fine glass tube. After passing through a narrow slit the rays fell on a photographic film inclined at a small angle with the direction of the rays. On applying a uniform magnetic field at right angles to the slit, each set of rays traced out the arc of a circle on the photographic plate. His results are given in the following table.

No.	$H\rho$	β	Remarks	No.	$H\rho$	β	Remarks
1	1320	·615	s.	13	3140	·882	f.
2	1390	·634	f.	14	3420	·897	f.
3	1490	·660	v.f.	15	4000	·920	f.
4	1580	·682	s.	16	4670	·940	s.
5	1680	·705	f.	17	4800	·943	f.
6	1750	·718	v.f.	18	4980	·946	f.
7	1830	·735	s.	19	5100	·949	m.
8	1900	·748	m.	20	5700	·957	s.
9	1970	·760	f.	21	5990	·962	f.
10	2150	·786	s.	22	11200	·988	complex
11	2190	·790	f.	23	18100	·996	—
12	2870	·862	s.				

From the observed value of $H\rho$, where H is the strength of the magnetic field and ρ the curvature of the rays in a magnetic field, the velocity was deduced by the aid of the Lorentz-Einstein formula assuming that $e/m_0 = 1.772 \times 10^7$. The velocity is expressed in the table by β , the fraction of the velocity of light. The intensity of the traces on the photographic plate varies widely, strong lines are marked s., feeble lines f., very feeble lines v.f., and lines of medium intensity m. The lines marked s. are easy to measure. The lines for numbers 1 to 9 are slightly broader than is to be expected theoretically for a completely homogeneous pencil from the dimensions of the source and slit. The variation of velocity in the bundle, however, is not more than one per cent. The swifter rays give finer lines of about the theoretical breadth. Number 22 consists of several sets of rays from 3 to 5 in number, for which the values of β lie between .98 and .99. The swiftest β rays observed gave $H\rho = 26000$ and $\beta = .998$. The stronger lines observed by Danysz are in good

accord with those found by v. Baeyer, Hahn and Meitner and included separately under radium B and radium C in the previous table.

The results so far obtained show how extraordinarily complex are the β radiations from radio-active substances. In the light of the results given above it appears not improbable that the continuous β ray spectrum observed for uranium X and radium E may be ultimately resolved into a number of lines. It is quite possible also that the somewhat diffuse band given by thorium D may be caused by the overlapping of several groups of rays.

A possible explanation of the complexity of β rays from radio-active substances is suggested in Chapter XVIII.

CHAPTER VI.

THE GAMMA OR VERY PENETRATING RAYS.

96. In addition to the α and β rays, a number of the radioactive substances give out a radiation of an extraordinarily penetrating character called the γ rays. These rays are considerably more penetrating than the X rays produced in a "hard" vacuum tube. Their presence can readily be observed for an active substance like radium, but is difficult to detect for uranium and thorium unless a large quantity of active material is used.

Villard*, using the photographic method, first drew attention to the fact that radium gave out these very penetrating rays, and found that they were non-deviable by a magnetic field. This result was confirmed by Becquerel†.

Using a few milligrams of radium, the γ rays can be detected in a dark room by the luminosity they excite in the mineral willemite or in a screen of platinocyanide of barium. The α and β rays are completely absorbed by placing a thickness of 2 millimetres of lead over the radium, and the rays which then pass through the lead consist entirely of γ rays. The very great penetrating power of these rays is easily observed by noting the slight diminution of the luminosity of the screen when plates of metal several centimetres thick are placed between the radium and the screen. These rays also produce ionisation in gases and are best investigated by the electrical method. The presence of the γ rays from 30 mgrs. of radium can be observed in an electroscope after passing through 30 cms. of iron.

* Villard, *C. R.* **130**, pp. 1010, 1178, 1900.

† Becquerel, *C. R.* **130**, p. 1154, 1900.

97. The absorption of γ rays from radium. The γ rays are emitted in large amount only from those radio-active substances which emit penetrating β rays. Before the effect due to the γ rays can be studied, it is necessary either to deflect the β rays away from the measuring apparatus by a strong magnetic field or to place a sufficient thickness of matter over the preparation to completely absorb the β rays. The latter method is usually adopted, and it is found that a thickness of two millimetres of lead is sufficient to completely cut off the β rays. Investigations

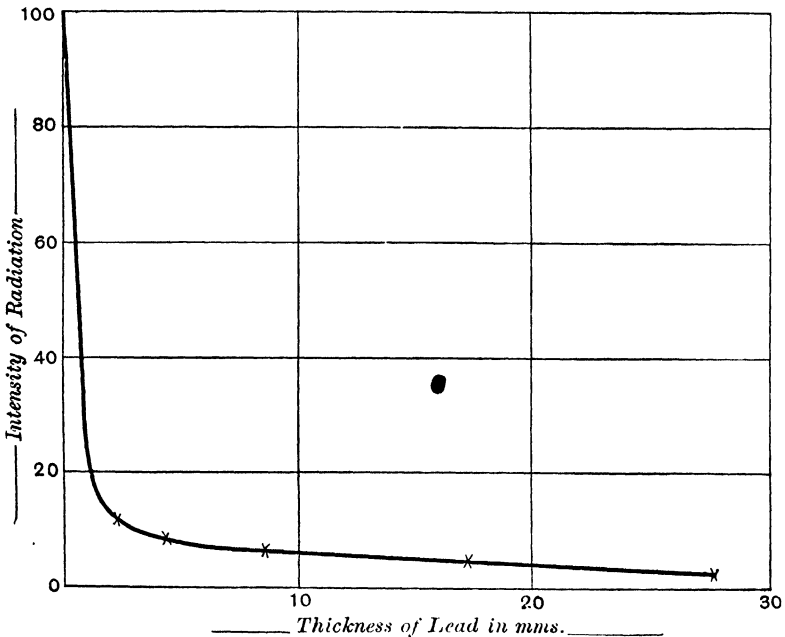

Fig. 71.

on the absorption of the γ rays can be most simply carried out by electroscopic methods. For this purpose it is desirable to use a lead electroscop, whose walls are at least 2 mms. thick. The windows of the electroscop should be suitably shielded to prevent β rays entering through them.

In Fig. 71 is shown the effect on the ionisation in an ordinary β ray electroscop when screens of lead of different thicknesses are placed between the active material and the electroscop. Initial observations on the absorption of the γ rays from radium

by the electric method were made by Rutherford* and later by McClelland†. The latter found that the absorption of γ rays was not exponential until the rays had passed through several centimetres of lead. If the coefficient of absorption μ is defined in the usual way by $dI = \mu I dx$, where I is the intensity measured by the ionisation produced, it was found that the value of μ showed a progressive decrease with thickness for heavy elements like lead and mercury, but was sensibly constant for lighter elements like aluminium. The absorption constant μ was approximately proportional to the density D of the material after the radiation had passed through a considerable thickness of lead.

Observations on the absorption of γ rays from radium have been made by Eve‡, Wigger§, Tuomikoski||, and Soddy and Russell¶. Using the electroscopic method and interposing screens of lead between the absorbing material and the electroscope, the coefficient of absorption is found at first to decrease with the thickness of matter traversed. The values found by Tuomikoski for the variation of the ionisation current with thickness of lead up to 19 cms. are shown in the following tables. The value of μ is deduced from the relation

$$I_1/I_2 = e^{-\mu(d_1 - d_2)},$$

where I_1 is the intensity after traversing a distance d_1 , and I_2 the intensity after a distance d_2 .

Corresponding values of μ for different thicknesses deduced from these results are given in the second table. It is seen that there is a progressive decrease of the value of μ with increasing thickness. The coefficient $\mu = .50$ (cms.)⁻¹ shows that after passing through about 5 cms. of lead an additional thickness of 1.4 cms. is required to cut down the ionisation to half value.

The values of the coefficient of absorption obtained by ordinary methods vary somewhat according to the arrangement adopted.

* Rutherford, *Phys. Zeit.* **3**, p. 517, 1902.

† McClelland, *Phil. Mag.* **8**, p. 67, 1904.

‡ Eve, *Phil. Mag.* **16**, p. 224, 1908; **18**, p. 275, 1909.

§ Wigger, *Jahr. Radioakt.* **2**, p. 430, 1905.

|| Tuomikoski, *Phys. Zeit.* **10**, p. 372, 1909.

¶ Soddy and Russell, *Phil. Mag.* **18**, p. 620, 1909.

Mr and Mrs Soddy, and Russell* have made an extensive investigation of the absorption of γ rays from radium by different materials. The absorption by lead was investigated by a special electroscopic method, and the value of μ was found to be 0.50 (cms.)^{-1} for a range of thickness between 2 cms. and 22 cms. This value agrees well with that found by Tuomikoski (see above) between 2 and 12 cms. of lead. Soddy and Russell

Absorption of γ rays from radium by lead.

Thickness of lead in cms.	Ionisation current	Thickness of lead in cms.	Ionisation current
0.3	100	10	0.63
1	61.6	11	0.39
2	33.1	12	0.30
3	19.9	13	0.20
4	11.7	14	0.11
5	7.07	15	0.07
6	4.26	16	0.05
7	2.57	17	0.04
8	1.62	18	0.03
9	1	19	0.02

Thickness of lead in cms.	$\mu \text{ (cms.)}^{-1}$
0.4— 1.0	0.70
1.0— 2.2	0.58
2.2— 5.4	0.52
5.4—12.0	0.50
12.0—15.8	0.39
15.8—18	0.25

ascribe the decrease in the value of μ found by Tuomikoski for greater thickness to the presence of a secondary penetrating radiation which enters any unprotected point of an electroscope, for example, the windows. This radiation penetrates aluminium and brass very readily, but is stopped by a few millimetres of lead.

When examined by the ordinary methods, the absorption of the γ rays of radium by lead does not follow an exponential law

* Mr and Mrs Soddy, and Russell, *Phil. Mag.* 19, p. 725, 1910.

but the apparent value of μ decreases rapidly to a value of about 0.50 for a thickness of 2 cms. of lead. In order to investigate the absorption of the rays for small thicknesses, Soddy and Russell employed a different arrangement. The ionisation vessel consisted of two concentric hemispherical copper bowls 40 and 20 cms. diameter respectively, while the radium was placed at their centre. The rays thus had the same path in the ionisation vessel for angles up to 180° . The absorbing material was constructed of plates so cut as to build up a hemisphere with the radium at its centre. The values of μ for the truncated hemispheres were calculated, allowance being made for the variation in lengths of path of the γ rays in passing obliquely through the absorbing material. The ordinary formula of absorption cannot be applied unless a narrow pencil of γ rays falls normally on the absorbing material. Suppose that the γ rays emitted over an angle of 180°

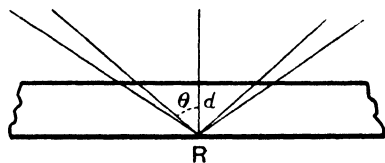

Fig. 72.

from a source R (Fig. 72) enter the ionisation chamber, and let I_0 be the total energy of the radiation over this angle. Let I_d be the corresponding value when the rays have traversed a screen of uniform thickness d .

Suppose the absorption coefficient is defined in the usual way, viz. $\lambda = \frac{1}{I} \frac{dI}{dx}$, where dx is the thickness traversed and I the intensity of the radiation.

Let E = intensity of radiation at unit distance. Within a solid angle $d\omega$ the energy of the radiation transmitted through the plate at an angle θ with the normal is $E d\omega e^{-\mu d/\cos \theta}$. Consequently the total energy I_d transmitted through the screen is given by

$$I_d = \int_0^{\pi/2} E e^{-\mu d/\cos \theta} 2\pi \sin \theta d\theta.$$

Since $I_0 = 2\pi E$,

$$\begin{aligned} I_d/I_0 &= \int_0^{\pi/2} e^{-\mu d/\cos\theta} \sin\theta d\theta = \mu d \int_{\mu d}^{\infty} \frac{e^{-y}}{y^2} dy, \text{ if } y = \mu d/\cos\theta, \\ &= e^{-\mu d} + \int_{\infty}^{\mu d} \frac{e^{-y}}{y} dy. \end{aligned}$$

The latter integral known as the "exponential integral" has been evaluated by Glaisher. In a similar way, it is a simple matter to deduce the ratio I_d/I_0 when the incident rays are included within a known angle. The value of μ can thus be calculated from the observed ratios I_d/I_0 of the ionisation. The value of μ so found is less than that deduced from the ordinary exponential formula, where the angular width of the pencil of incident rays is neglected. For example, Soddy and Russell calculated that for a pencil of semi-angle 18° the value of μ was about 2 to 2.5 per cent. less than the ordinary value over a wide range of thickness. The correction is consequently not large under these conditions. The absorption of the γ rays for thickness of lead up to 7.5 cms. was examined by the method described above, and found to be approximately exponential over the whole range with a value of $\mu = 0.50$ for lead. In this arrangement, all the radiation passing through the absorbing sheets entered the testing vessel, so that there was no disturbance due to scattering of the emergent rays. The absorption of a number of metals was made by the same method with somewhat varying results. For example, in zinc, the absorption curve for small thicknesses showed initially wide departures from the exponential law.

From the fact that under certain experimental conditions the γ rays of radium are absorbed nearly exponentially over a wide range of thickness, Soddy and Russell concluded that the γ rays must be homogeneous. The evidence obtained from scattering, however, does not support such a conclusion. It seems probable that the exponential law of absorption, as in the case of β rays, cannot be regarded as definite evidence of homogeneity*.

The value of the coefficient of absorption of the γ rays by matter is considerably influenced by the disposition of the absorbing

* See Kleeman, *Phil. Mag.* 20, p. 248, 1910; and Soddy, *Phil. Mag.* 20, p. 383, 1910.

screen between the source and the testing vessel. When the absorption is measured by placing plane sheets of matter between the source and the electroscope, all observers have found that the value of μ for the γ rays of radium at first decreases rapidly with the thickness. This is especially marked in lead, and has been ascribed to a lack of homogeneity of the primary γ rays. The initial part of the absorption curves obtained with heavy elements like lead and mercury show more marked variations than with a light element like aluminium. This is expressed by the statement that lead *hardens* the radiation, *i.e.* the average penetrating power of the issuing rays after passing through lead is increased for *all* substances. This is ascribed to the property of lead and other heavy elements of rapidly absorbing the soft radiation. On this view, the hardness of the issuing rays is due to the removal of a large proportion of the less penetrating γ rays. This effect is not exhibited to anything like the same extent by light elements like aluminium and iron. The values of the coefficient of absorption found thus depend to some extent on whether the electroscope is made of lead and the source covered with lead to cut off this soft radiation. In addition, it will be shown later that the γ rays are scattered by their passage through matter, and that the softer or less penetrating rays are more readily scattered than the harder or more penetrating radiation. The value of μ will thus vary with the arrangement, depending on how much of this soft scattered radiation enters the electroscope. Soddy and Russell (*loc. cit.*) and Florance* have drawn attention to the variation of μ with the disposition of the electroscope and absorbing screens.

98. Connection of absorption with density. Soddy and Russell examined the relation between absorption and density for the γ rays from radium and from an intense source of uranium X. The values found for the two types of γ rays are included in the table on page 264.

It is seen that the γ rays of radium are more penetrating than those from uranium. Some of the curves of absorption for radium γ rays in different materials obtained by Soddy and Russell are shown in Fig. 73 where the logarithms of the ionisation in the

* Florance, *Phil. Mag.* **20**, p. 921, 1910.

electroscope are plotted as ordinates and the thicknesses of material as abscissae. In this case the γ rays initially passed through 1 cm. of lead. It is seen that in most cases the curves are nearly

No.	Material	Density	Range of thickness (cms.)	Radium rays		Uranium rays	
				μ (cms.) ⁻¹	100 μ/D	μ (cms.) ⁻¹	100 μ/D
1	Mercury ...	13.59	.34 to 3.5	.642	4.72	.832	6.12
2	Lead ...	11.40	0 to 7.9	.495	4.34	.725	6.36
3	Copper ...	8.81	0 to 7.6	.351	3.98	.416	4.72
4	Brass ...	8.35	0 to 5.86	.325	3.89	.392	4.70
5	Iron ...	7.62	0 to 7.6	.304	3.99	.360	4.72
6	Tin ...	7.245	0 to 5.5	.281	3.88	.341	4.70
7	Zinc ...	7.07	0 to 6.0	.228	3.93	.329	4.65
8	Slate ...	2.854	0 to 9.4	.118	4.14	.134	4.69
9	Aluminium ...	2.77	0 to 11.2	.111	4.06	.130	4.69
10	Glass ...	2.52	0 to 11.3	.105	4.16	.122	4.84
11	Sulphur ...	1.785	0 to 11.6	.0782	4.38	.0921	5.16
12	Paraffin wax ...	0.862	0 to 11.4	.042	4.64	.0433	5.02

straight lines, showing that the absorption is approximately exponential.

The values of μ/D given in the table show that the metals may be conveniently divided into three groups. The first group

contains mercury and lead for which the values of μ/D are distinctly higher than for the elements of lower atomic weight. The second group contains elements of density between 8.8 and 2.6 in which the values of μ/D are sensibly constant, showing that the absorption is very nearly proportional to the density. The third group contains lighter substances in which μ/D has a somewhat higher value. From a consideration of these results and the results for the absorption of γ rays by gases given later, it is clear

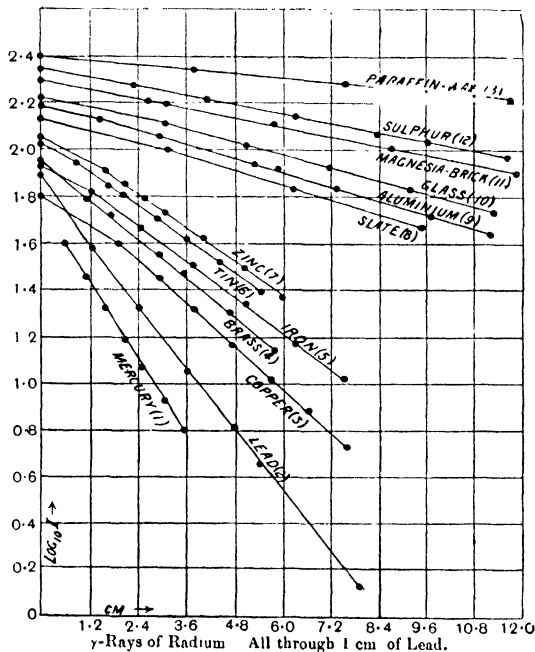

Fig. 73.

that the value of μ/D passes through a minimum for elements of intermediate atomic weight like aluminium and copper. This is an experimental result of great interest for which no explanation has as yet been offered.

Absorption by Gases.

The absorption of the γ rays from radium by gases has been examined by Chadwick* by a balance method. The ionisation

* Chadwick, *Proc. Phys. Soc.* **24**, p. 152, 1912.

effect in a lead vessel due to a source of γ rays was balanced against the constant ionisation due to the α rays from uranium, and the disturbance of the balance due to the passage of the rays through known thicknesses of absorbing matter was determined. The absorption of γ rays by liquid air and by solid carbon dioxide was measured and compared with the absorption of the rays by air and carbon dioxide contained in cylinders under high pressure. The absorption was found to vary directly as the pressure of the gas. The value μ/D for air and carbon dioxide was found to be practically the same by the two methods, indicating that lowering of temperature has no effect on the absorption of the γ rays.

The observed values of μ/D are included in the following table for the three gases and also for some of the lighter substances measured under similar conditions. In column I is given the value of μ for the rays which traverse 3 mms. of lead before entering the electroscope and in column II for 10 mms.

Substance	I	II
	100 μ/D	100 μ/D
Hydrogen	4.7	—
Air (under pressure)	4.8	—
Air (liquid)	4.84	4.60
CO ₂ (under pressure)	5.1	4.7
Wood	5.21	4.29
Water	5.58	4.72
Aluminium	4.45	3.95
Iron	4.48	4.00
Lead	9.03	5.99

It is seen that the value of μ/D is greater for gases and water than for aluminium, but is much less than for lead under the same conditions. The variations are less marked for more penetrating rays.

Since the value of μ/D for air does not change much with the penetrating power of γ rays, the average coefficient of absorption of the γ rays from radium by air can be calculated taking the value $\mu/D = 0.048$. Since the density of air at normal pressure and at 15° C. is 0.00125, μ for air at ordinary temperature = 6.0×10^{-5} (cm.)⁻¹. This value is of importance in determining

the distance traversed by the γ rays in air. The γ rays from radium are half absorbed in a distance of 115 metres of air at normal pressure and temperature, and their intensity is reduced to 1/100 after traversing 760 metres.

Experiments on the absorption of the γ rays from radium by air have also been made by Hess*. The ionisation due to the γ rays from about a gram of radium was measured for different distances from the radium. Assuming that the intensity of the γ rays at a distance r from the radium is proportional to $e^{-\mu r}/r^2$, the value of μ can be deduced from the relative values of the ionisation observed in an electroscope for different values of r . Hess found that $\mu = 4.47 \cdot 10^{-5}$ (cms.)⁻¹ for air. This is a value distinctly lower than the value obtained by Chadwick given above, but the conditions of measurement were very different in the two cases.

99. γ radiation from other radio-active substances.

The absorption of the γ rays from actinium was initially examined by Godlewski† and Eve and from uranium and thorium by Eve‡. The latter early observed that the penetrating power of the γ rays from thorium was about the same as from radium, while the rays from actinium and uranium X were less penetrating. A careful comparison of the quantity and penetrating power of the γ rays from these substances has been made by Russell and Soddy§. The following radio-active products were used as sources of γ rays: radium C, uranium X, thorium D, mesothorium 2. A large quantity of uranium X was separated from several kilograms of uranium, while the mesothorium was separated from several kilograms of thorium nitrate. The thorium D was obtained by exposure to the thorium emanation from an active preparation of radio-thorium.

The coefficients of absorption of the γ rays from these substances were obtained under similar conditions by an electroscopic method. The rays had in all cases to pass through a thickness

* Hess, *Phys. Zeit.* **12**, p. 998, 1911.

† Godlewski, *Phil. Mag.* **10**, p. 375, 1905.

‡ Eve, *Phil. Mag.* **11**, p. 586, 1906.

§ Russell and Soddy, *Phil. Mag.* **21**, p. 130, 1911.

of 1 cm. of lead before entering the electroscope. The absorption was in all cases nearly exponential. The relative values of μ

Absorbing material	Thorium D		Radium C		Mesothorium 2		Uranium X	
	μ	$100 \mu/D$	μ	$100 \mu/D$	μ	$100 \mu/D$	μ	$100 \mu/D$
Lead ...	0.462	4.05	0.500	4.38	0.620	5.44	0.725	6.36
Copper ...	0.294	3.34	Class II See previous table	Mean value 3.99	0.373	4.23	See previous table	Mean value 4.70
Brass ...	0.271	3.25			0.355	4.25		
Iron ...	0.250	3.28			0.316	4.15		
Tin ...	0.236	3.26			0.305	4.21		
Zinc ...	0.233	3.30			0.300	4.24		
Slate ...	0.0961	3.37			—	—		
Aluminium ...	0.0916	3.24	0.119	4.21				
Glass ...	0.0886	3.52	0.113	4.48	0.122	4.84	0.0917	4.78
Magnesia ...	0.062	3.23	0.090	4.69	0.083	4.65	0.0921	5.16
Brick ...	0.066	3.69	0.040	4.64	0.050	5.80	0.0433	5.02
Sulphur ...	0.031	3.61						
Paraffin wax ...								

and μ/D are shown in the table where the absorbing screen was placed directly over the active matter some distance from the

electroscope. The values of μ were found to depend to some extent on the particular arrangement employed.

The nature of the absorbent has a marked effect on the relative penetrating power of the four types of rays. Taking the absorption coefficient of radium C as unity, the relative values of μ are shown in the following table (1) for lead, (2) for the average metal of Class II where μ/D is nearly constant, and (3) for a light substance like paraffin wax.

Relative values of μ (cms.)⁻¹.

Absorbent	Radium C	Thorium D	Mesothorium 2	Uranium X
Lead ...	1.00	0.924	1.24	1.45
Class II ...	1.00	0.82	1.06	1.18
Paraffin wax	1.00	0.78	1.26	1.08

The rays from thorium D are slightly more penetrating than those from radium C, while the rays from mesothorium 2 and uranium X are less penetrating, although the differences are not very marked.

Moseley and Makower* have recently shown that radium B emits γ rays of a comparatively soft type. The ionisation due to these γ rays through 3 mms. of lead is about 12 per cent. of the ionisation due to the γ rays from the radium C in equilibrium with it.

The γ rays of actinium are considerably less penetrating than those from the above group of radio-elements. Godlewski first measured the absorption of these rays and found $\mu = 4.54$ for lead for a thickness 0 to 3.5 mms. The corresponding values for iron and zinc were $\mu = 1.23$ and $\mu = 1.24$ respectively for thicknesses 0 to 10 mms. The large absorption for lead relative to iron is more marked for the actinium rays than the rays from radium C. Eve found $\mu = 4.1$ for lead over a similar range, but after 2.7 mms. a change to $\mu = 2.7$ took place. The question was re-examined by Russell and Soddy (*loc. cit.*) using a stronger preparation. The absorption of the γ rays by aluminium and zinc was found to be

* Moseley and Makower, *Phil. Mag.* **23**, p. 312, 1912.

nearly exponential with values of $\mu = 0.217$ and $\mu = 0.420$ respectively. The absorption by lead is abnormal. There is a change in the value of μ after 3 mms. and also after 8.5 mms. The relative values of μ compared with those for the γ rays from radium C depend considerably upon the arrangement adopted for measurement.

100. Connection of γ rays with β rays. We have so far given the results of investigations on the penetrating power of γ rays from different substances without reference to the relative quantity emitted. It has been usually assumed that the production of γ rays always accompanies the emission of high speed β particles from radio-active matter, and this is borne out by the fact that γ rays have so far only been obtained from active products which emit penetrating β rays. On the other hand, some very striking differences occur in the intensity of γ rays compared with the intensity of the β radiation. For example, uranium X, which emits high speed β particles, shows a relatively small γ ray activity, although the γ radiation is comparatively penetrating. A similar result holds for actinium. This difference is most marked for radium E, which emits β rays of moderate penetrating power, but which emits γ rays very feeble in intensity and in power of penetration. The relative β and γ activity for a number of radio-active products has been examined by Russell and Soddy (*loc. cit.*). The ratios of these two activities will obviously be dependent on the particular arrangement employed, for example, on the distance of the preparation from the testing vessel and the thickness of absorbing screen through which the γ rays pass. The relative values given below were obtained for the β and γ ray activity under the following conditions. The source of β rays was placed 60 cms. below a brass electroscope whose base was covered with aluminium foil 0.95 mm. thick. The ionisation was then mainly due to the more penetrating β rays. The source of γ rays was placed 8.6 cms. below a lead electroscope whose base was of lead 3 mms. thick. The results are included in the following table. γ/β represents the ratio of γ to β ray activity measured by the method described above, the ratio for radium C being taken as unity.

The ratios for actinium and uranium X were measured under somewhat different conditions from the others, so that the relative values are only approximate. It is thus seen that the ratio γ/β does not differ markedly for the first three substances, but is less than 1/10 for actinium D and about 1/50 for uranium X.

	γ/β
Radium C	1.00
Mesothorium 2	1.13
Thorium D	0.74
Actinium D	0.077
Uranium X	0.02

This difference, as already mentioned, is far more marked for radium E, where the ratio is about 1/1000 or even less (see Section 103). This wide difference in the relative intensity of the γ and β rays from different active substances at first sight suggests that there may be no definite connection between the expulsion of β rays and the appearance of γ rays. We know, however, that cathode rays give rise to X rays, while Gray (Section 103) has shown that swift β rays in traversing matter give rise to γ rays. In addition, no product has yet been found where the γ rays appear independently of β rays. It is to be expected theoretically that γ rays would appear in consequence of the expulsion of β particles from the atom. The wide variation in the quality and quantity of the γ rays from different substances indicates that the production of γ rays is either dependent on the structure of the particular atom undergoing transformation or upon some peculiarity in the origin and mode of expulsion of the β particle from the atom. We have seen in Section 95 that the emission of β particles from radio-active matter is a very complex phenomenon, and it is quite possible that the appearance of intense γ rays may be connected with some peculiarity in the mode of emission of the β rays.

101. Secondary β rays produced by γ rays. We have seen that β rays falling on matter are diffusely scattered, but that there is no definite evidence that the β rays give rise to a true secondary radiation of the β ray type. It has long been known that the α rays falling on matter give rise to secondary rays which

consist of negatively charged particles analogous in all respects to very slow β rays. A secondary radiation of the β ray type is set up in matter of all kinds by γ rays but the β particles are relatively far swifter and more penetrating than the δ radiation set up by α rays.

‡ Paschen* observed that a preparation of radium surrounded by a thickness of lead, sufficient to stop completely the β rays, gained a small positive charge in a vacuum. He suggested in consequence that the γ rays were in reality very swift β rays

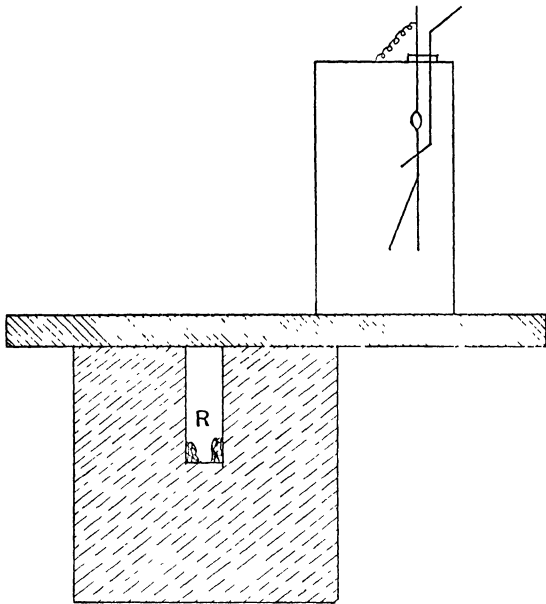

Fig. 74.

travelling at a velocity close to that of light. The explanation of the charge observed was given by Eve†, who showed that matter struck by γ rays emitted freely a secondary radiation of the β ray type. In consequence of the expulsion of negatively charged particles from the lead, the latter acquired a positive charge. The method employed to find the presence of β rays is shown in Fig. 74. A small electroscopical was mounted on one side of a lead platform 1.2 cms. thick, which rested on a lead cylinder

* Paschen, *Ann. d. Phys.* **14**, p. 389, 1904.

† Eve, *Phil. Mag.* **8**, p. 669, 1904.

10 cms. high and 10 cms. in diameter. The radium R was placed in a hole reaching to the centre of the cylinder. The effect in the electroscope was partly due to the γ rays traversing the lead and partly to secondary β rays excited in the lead platform. On applying a magnetic field so as to bend the β rays towards the electroscope, the discharge was much increased. On reversing the field, the effect was diminished. Since the γ rays are themselves undeflected by a magnetic field, this experiment shows that the γ rays excite secondary β rays. These have an average velocity more than half that of light.

The penetrating power and distribution of this β radiation excited by γ rays has been examined by a number of observers under somewhat different conditions. It is necessary at this stage to draw a sharp distinction between the β radiation which escapes from the side of the plate on which the γ rays fall and the β radiation which emerges from the far side of the plate. The former will be called the *incidence* radiation and the latter the *emergence* radiation. Preliminary experiments were for the most part made on the incidence β radiation. In addition to the emission of β rays, a substance traversed by γ rays gives rise to a secondary or scattered radiation of the γ ray type. If the plate is not very thick, the ionisation due to the latter is small compared with that due to the excited β radiation. Eve*, using the γ rays of radium, made a number of experiments with the arrangement shown in Fig. 55. The primary β rays were absorbed by surrounding the radium with lead and the amount of incidence β radiation from different materials was measured in the electroscope. The emission of β rays was found to be a volume effect, for the number of β particles increased at first with thickness of the radiator. The thickness to give an approximate maximum for aluminium was 3 mms. Such a result is to be expected if the β rays are emitted equally at each point of the radiator traversed by the γ rays. The thickness required for a maximum effect is then dependent on the absorption of the excited β rays by different materials.

The amount of the incidence radiation was found to increase

* Eve, *Phil. Mag.* 8, p. 669, 1904.

in a regular manner with the atomic weight of the radiator. The relative amount of β radiation from different substances follows the same order as the amount of scattered radiation observed when a pencil of β rays falls on different materials (Section 83). S. J. Allen* and Eve (*loc. cit.*) showed that the penetrating power of these β rays was about the same as that of the primary β rays from radium. Eve also showed that the radiation from lead is slightly more penetrating than that from light elements like carbon or aluminium. This is again analogous to the difference in penetrating power between the primary β rays and the scattered radiation from elements of different atomic weight (Section 83).

Metal	Soft γ rays		Hard γ rays	
	Incident radiation	Emergent radiation	Incident radiation	Emergent radiation
Carbon ...	170	2280	58	1150
Aluminium ...	280	1810	120	795
Sulphur ...	340	1575	154	685
Iron ...	487	1350	163	560
Copper ...	558	—	202	523
Tin ...	1051	1170	333	303
Lead ...	1723	2001	497	470

Mackenzie† first drew attention to the striking fact that the emergence β radiation was always far more intense than the incidence radiation. This difference is observed for all kinds of matter but is most marked for elements of light atomic weight. It was pointed out by Bragg that this effect was a necessary consequence of his view that the γ rays are corpuscular in nature. This theory will be discussed later but it suffices to say at present that the β rays produced in matter by the γ rays should on the whole be expelled in the direction of travel of the γ rays. The difference in the amount of emergence and incidence radiation

* Allen, *Phys. Rev.* **23**, p. 65, 1906.

† Mackenzie, *Phil. Mag.* **14**, p. 176, 1907.

was examined by Bragg* for a number of metals. The γ rays, freed as far as possible from β rays by a magnetic field, traversed thin sheets of matter. The β radiation escaping on the side of incidence and emergence was separately examined. The results in arbitrary units are given in the table on p. 274 for soft γ rays and γ rays hardened by their passage through lead.

It is seen that for light substances the emergent radiation is very much greater than the incident. For heavy metals the

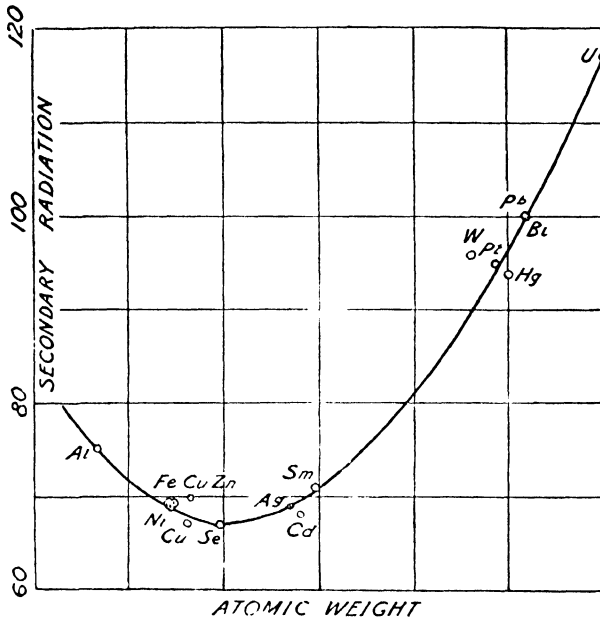

Fig. 75.

difference is far less marked. Such a result is to be expected on account of the marked scattering of heavy atoms even if the β rays are initially projected in the direction of the γ rays.

Bragg and Madsen†, Eve‡ and Hackett§ have shown that the

* Bragg, *Phil. Mag.* **15**, p. 663, 1908.

† Bragg and Madsen, *Phil. Mag.* **16**, p. 918, 1908.

‡ Eve, *Phil. Mag.* **18**, p. 275, 1909.

§ Hackett, *Trans. Roy. Dubl. Soc.* **9**, p. 201, 1909.

amounts of emergence radiation from thick plates of matter do not, like the incidence radiation, increase regularly with atomic weight but pass through a minimum for an atomic weight corresponding to about that of zinc. If the amount of emergence radiation is plotted as ordinate and the atomic weight of the radiator as abscissa, the elements roughly lie on a curve approximately parabolic in form. The shape of the curve is to some extent dependent on the penetrating power of the γ rays employed. The type of curve obtained for γ rays of radium which have passed through 2 mms. of lead is shown in Fig. 75. This curve has been drawn by Eve from the experimental data given by Hackett.

The general results obtained, both as regards the incidence and emergence radiation, are in conformity with the view that the γ rays in passing through matter in some way give rise to β rays in amount proportional to the intensity of the γ radiation. The results indicate that the β particles initially escape in the direction of the γ rays, and with the same speed for all kinds of matter. The velocity of the expelled β particle will depend, however, on the penetrating power of the γ rays and increases with it. As we have seen, the differences in absorption of the incidence β radiation from different elements are to be explained by the wide differences in absorption and scattering of β rays by different kinds of matter and not to any difference in the initial velocity of expulsion. Assuming that the β rays excited in matter by complex γ rays are absorbed according to an exponential law, a general explanation can be given of the results observed.

Suppose that a pencil of γ rays of intensity I_0 falls normally on a plane sheet of matter of thickness d . The number of β particles formed in the matter between two planes distant x and $x + dx$ from the side of incidence should be proportional to the energy of the γ radiation absorbed in the layer, *i.e.* to $\mu I_0 e^{-\mu x} dx$, where μ is the coefficient of absorption of the γ rays by the matter. Since the β particles are initially supposed to travel in the direction of the γ rays, the laws of absorption are the same as for a normal pencil of β rays passing through matter. If μ_1 is the

coefficient of absorption of the β rays by matter, the total intensity of the emergence radiation is thus proportional to

$$\mu I_0 \int_0^d e^{-\mu x} e^{-\mu_1(d-x)} dx = \frac{\mu I_0}{\mu_1 - \mu} (e^{-\mu d} - e^{-\mu_1 d}).$$

Since μ_1 is of the order 100μ , it is seen that the intensity of the emergence β radiation is at first proportional to the thickness when this is small, passes through a maximum when

$$d = \frac{1}{\mu_1 - \mu} \log_e \frac{\mu_1}{\mu},$$

and finally decreases exponentially with the intensity $I_0 e^{-\mu d}$ of the γ rays.

These conclusions are in general agreement with the experimental observations of Bragg and Madsen.

If the emergence radiation is determined for plates of different materials of sufficient thickness to give the maximum radiation, the intensity of the emergent radiation is proportional to $\frac{\mu}{\mu_1 - \mu}$ (since $e^{-\mu d}$ is nearly unity in most cases), *i.e.* to $\frac{\mu/D}{\mu_1/D - \mu/D}$, where D is the density of the material.

By comparing the values of μ/D for the γ rays from uranium X (Section 99) with the value μ_1/D for the β rays from uranium X (Section 89), the value of this quantity can be approximately estimated for different materials. On these data, the values for aluminium, iron, copper and lead are 84, 65, 64, 59, 70×10^{-4} respectively. This shows that the emergence radiation should pass through a minimum with increase of atomic weight. This is in general agreement with the experimental results already discussed.

If the excited β radiation travels in the direction of the γ rays, the amount of incidence radiation will, as in the case of β rays falling on matter, depend mainly on the scattering power of different elements for β rays, and should thus increase regularly with the atomic weight. This is observed experimentally.

Variation of ionisation with material of electroscope.

On account of the variation in the amount of incidence and emergence radiation for different kinds of matter, the ionisation observed in a γ ray electroscope for a given intensity of γ rays depends on the material with which it is lined. This has been observed by Eve. Bragg* made an accurate comparison of the ionisation under definite conditions. The ionisation chamber was of lead, cylindrical in shape, and the radium as a source of γ rays was placed some distance away on the axis of the cylinder. The lining of the chamber was of sufficient thickness to give the maximum amount of secondary β radiation. The results are shown in the following table. Column II gives the thickness of lining; Column III gives the relative ionisations, taking lead as 100, when the γ rays first passed through .47 cm. of lead; Column IV the relative ionisations when the rays first passed through 1.6 cms. of lead.

I Metal used for lining	II Thickness of lining in cms.	III	IV
Lead ...	—	100	100
Tin16	58	68
Zinc21	47	55
Iron155	45	54
Aluminium	.21	40	49
Card24	39	46

The change in the relative values in the two columns is mainly due to the change in lead only; for the rays have been hardened in passing through the extra thickness of lead.

In these cases, the ionisations observed are mainly if not entirely due to the secondary β rays (see Section 105) and result from a combination of the effects of the incidence and emergence

* Bragg, *Phil. Mag.* 20, p. 385, 1910.

radiations. Bragg has utilised these results to form an estimate of the relative *total* range of the β particle in different metals before absorption.

102. Scattered γ radiation. We have already mentioned that in addition to the excitation of β rays, γ rays in traversing matter give rise to a scattered radiation of the γ ray type. This radiation has usually been called the *secondary* γ radiation and was first observed by Eve*. Extensive investigations on the nature of this secondary radiation have been made by Kleeman†, Madsen‡, and Florance§. From an examination of the differences in penetrating power of the β rays excited in different substances and of the penetrating power of the secondary γ rays, Kleeman concluded that the γ rays of radium consisted of at least three distinct kinds having different penetrating powers. Madsen by a different method investigated the character of this secondary γ radiation on the side both of incidence and emergence. He showed that the radiation on the side of incidence was much weaker and more easily absorbed than the radiation on the side of emergence. The question was re-examined by Florance using a sufficient quantity of radium to determine the amount of the secondary radiation emitted at different angles with the radiator. The general arrangement is clearly shown in Fig. 76. The testing electroscop *E* was made of lead, about 3 mms. thick. It could be moved on the arm of a circle with the radiator as centre in order to examine the quantity and quality of the secondary γ radiation emitted at different angles with the radiator. The variation of the amount of radiation with thickness for different positions of the electroscop is shown in Fig. 77. The electroscop was placed in seven different positions ;

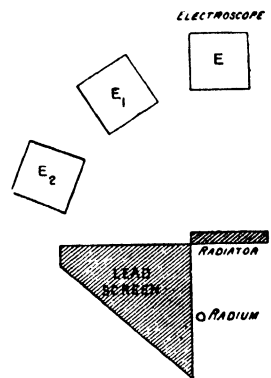

Fig. 76.

* Eve, *Phil. Mag.* **8**, p. 669, 1904.

† Kleeman, *Phil. Mag.* **15**, p. 638, 1908.

‡ Madsen, *Phil. Mag.* **17**, p. 423, 1909.

§ Florance, *Phil. Mag.* **20**, p. 921, 1910.

in the first (not given in the diagram) the direct effect of the rays was measured, in position VII the secondary γ radiation at right angles to position I was determined; the other positions were intermediate between the first and seventh. It is seen that the amount of radiation for position II increases with the thickness to a maximum and then decreases. The shape of the curve undergoes a progressive change until, when at right angles

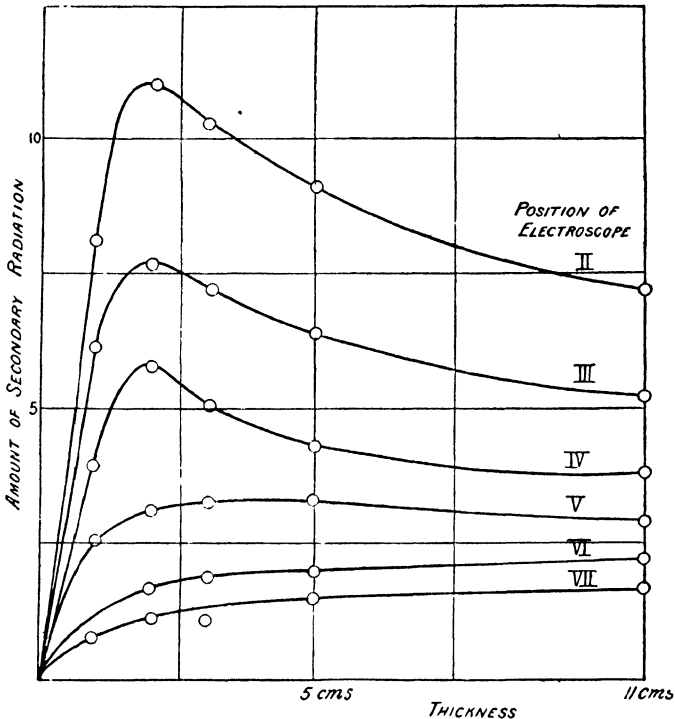

Fig. 77.

Relation between amount of secondary radiation and thickness of iron radiator.

to the original beam, the radiation increases slowly with the thickness of the radiator. The curve II is of the shape to be theoretically expected. For small angles, the amount of secondary radiation is nearly proportional to the thickness. The curve passes through a maximum and decreases owing to the decrease of intensity of the γ rays in passing through the absorbing screen. The angular distribution of the secondary radiation is shown

in Fig. 78 for different thicknesses of iron. It is seen that the secondary radiation falls off rapidly with angular distance from the pencil of γ rays and is small for a position at right angles. Florance found that using screens of different materials, of which the thickness multiplied by density was constant, *i.e.* of equal mass per unit area, the amount of secondary radiation was greater for carbon and iron than for lead. The quality of the secondary radiation was found to vary with the angle of the radiator. The radiation scattered through a large angle was much more easily absorbed than the primary γ radiation. The results are shown in the following table.

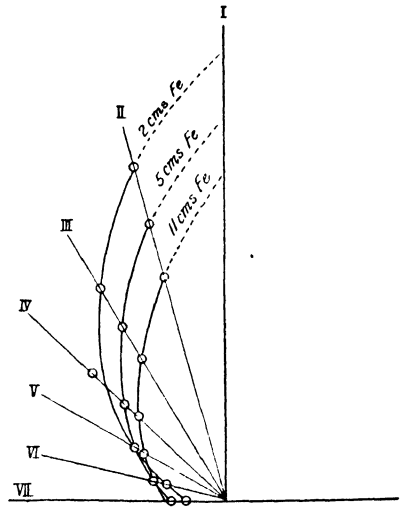

Fig. 78.

Position of electroscope.

Curves showing relation between position of electroscope and the amount of secondary radiation when the thickness is constant for each curve.

Coefficient of absorption μ (cms.)⁻¹ for lead.

Radiator	Direct radiation	Radiation at angle 25°	Radiation at angle 55°
Carbon 5 cms.	·68	1·20	1·77
Carbon 10 "	·65	1·18	1·70
Iron 2·2 "	·65	1·17	1·68
Iron 5 "	·59	1·05	1·55
Lead ·416 "	·625	1·11	1·65

The general results of the experiments indicate that the secondary γ rays are in reality scattered primary rays. The results admit of a simple explanation if it be supposed that the primary γ rays of radium are complex and consist of a mixture of γ rays of different penetrating powers. The softer rays are more readily scattered than the harder rays and consequently the penetrating power of the scattered radiation decreases progressively with angular distance from the direction of the primary

γ rays. It is not possible to decide definitely from the experiments whether the γ rays can be divided into distinct groups of rays. There is a progressive alteration of the quantity and quality of the scattered rays with angular distance, but there is no certain evidence that this is due to distinct groups of rays. No evidence has been obtained that these scattered γ rays can be ascribed to a *characteristic* radiation set up in the radiator by the primary γ rays. It appears far more probable that the main effects are to be ascribed to scattering of the primary rays. The amount of scattered radiation appearing on the side of incidence is very small compared with that on the side of emergence, and is much softer. Crowther and others have shown that the distribution of scattered X rays is somewhat similar, although the amount appearing on the side of incidence is more marked than for γ rays. For substances which emit a characteristic radiation when X rays fall upon them, the intensity of the radiation is nearly symmetrical on the sides of incidence and emergence.

103. Production of γ rays by β rays. When the cathode rays in a vacuum tube impinge on any material, they give rise to X rays which are not deflected by a magnetic field and are much more penetrating than the cathode rays which produce them. It is therefore to be expected that a type of X rays should be excited when β rays fall on matter. The γ rays emitted by radioactive substances appear with the β rays and apparently arise as a consequence of the expulsion of a β particle from the atom. Experiments to test whether β rays from radium in traversing matter gave rise to a type of penetrating γ rays were made by H. Starke* and Davisson† by different methods, but no very definite evidence of the production of γ rays was observed. Their experiments indicated that if γ rays were excited, their ionisation effect was very small compared with that due to the primary γ rays from the radio-active substance‡.

* H. Starke, *Le Radium*, 5, p. 35, 1908.

† Davisson, *Phys. Rev.* 28, p. 469, 1909.

‡ Chadwick in the laboratory of the writer has found that the β rays from radium excite γ rays in amount increasing with the atomic weight of the element on which they fall. The maximum amount of excited γ rays is only about one-half per cent. of that due to the primary γ rays from radium.

It has been pointed out in Section 100 that there are notable differences in the relative intensities of the β and γ rays from radio-active substances. For equal β ray intensity, the γ rays from uranium X are only 2 per cent. of those from radium C, while the γ rays from radium E produce a still smaller effect. Owing to its comparative poverty in primary γ rays, radium E is especially suitable as a source of β radiation to examine whether γ rays are excited by β rays. With this source of radiation, J. A. Gray* has shown definitely that γ rays are produced by β rays, and has examined the quantity and quality of the radiation set up by the impact of β rays in different substances. The active material initially employed was a preparation of radium D + E, mixed with lead, which had been separated from radium. Practically all the β radiation is due to radium E which was in equilibrium with radium D. This gave a very strong β radiation but weak γ rays.

It will be convenient to call the γ rays, produced in ordinary matter by the β rays, the "excited" γ rays. This serves to distinguish them from the "primary" γ rays emitted by the radio-active matter, and the "secondary" or "scattered" γ rays observed when γ rays traverse matter.

The presence of excited γ rays was shown in the following way. The active matter facing downwards was placed beneath an electroscopie E (Fig. 79). The base of the electroscopie was covered with sufficient aluminium or cardboard *FE* to absorb completely the primary β rays. The ionisation in the electroscopie was then due to the γ rays from the preparation itself and its surroundings. On placing a lead radiator *PB* below the active material, the ionisation in the electroscopie was increased. The additional effect was due to the γ rays excited by the β rays falling on the lead. The

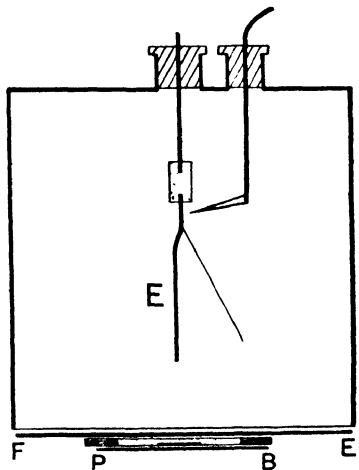

Fig. 79.

* J. A. Gray, *Proc. Roy. Soc. A*, 85, p. 131, 1911.

excited γ rays were of about the same penetrating power as the primary γ rays, and were not deflected by a magnetic field. The connection of these γ rays with the β rays was shown by interposing sheets of paper between the active matter and the lead radiator. Since the amount of γ rays excited in paper is much less than in lead, the intensity of the excited γ rays fell off in about the same proportion as the intensity of the β rays transmitted through the paper. Such a result shows that the effect observed cannot be due to a scattering or excitation of secondary γ rays in the lead radiator by the primary γ rays. The production of γ rays in different materials was simply studied by the arrangement shown in Fig. 80. The source was placed at *A* between the poles of a large electromagnet, and the radiator at *R* under the electroscope. The β rays could be prevented from falling on the radiator by applying a strong magnetic field. In some later experiments, a source of radium *E* was used spread in a very thin layer on filter paper. With this arrangement, the primary γ rays were only a small percentage of the γ rays excited when a lead plate was placed over the active material.

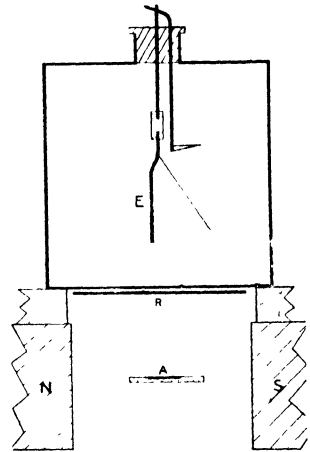

Fig. 80.

This showed that the greater part of the γ radiation observed with the first preparation which was less concentrated was in reality excited in the lead mixed with the active matter

It was found that the quantity and penetrating power of the excited γ radiation increased rapidly with the atomic weight of the radiator. This is shown by the table below. The numbers given refer to the ionisation due to excited γ rays in divisions per minute of the electroscope.

The γ radiation excited in paper is not much more penetrating than β rays, while that from lead was more penetrating than the primary γ radiation from the active material.

It was found that the amount of γ rays excited in a give radiator depended on its thickness and varied in direct proportion

with the amount of β rays absorbed by it. The amount of γ radiation appearing on the side of *emergence* was always greater

Radiator	No lead screen	Absorbing screen 0.05 mm. lead	Absorbing screen 0.1 mm. lead
2.7 mms. of paper56	.10	.02
0.3 mms. iron ...	1.10	.70	.40
0.12 mms. lead ...	2.18	1.72	1.35

than on the side of *incidence*. These results are illustrated in the following table.

Radiator	Incident γ rays	Emergent γ rays
.30 mm. iron ...	0.47	1.10
1 lead foil ...	0.37	1.05
2 " ...	0.75	1.60
3 " ...	1.15	2.00
4 " ...	1.40	2.16
5 " ...	1.57	2.20
7 " ...	1.80	2.17
9 " ...	1.84	1.99

When the β rays fall on the radiator, part are transmitted in the forward direction and part scattered back to the side of incidence. On an average, therefore, a certain fraction of the β particles in the radiation are travelling onwards and a certain fraction backwards. Taking this effect into consideration, the results indicate that the γ ray travels on the average *in the same direction* as the β ray which produces it. Such a result has an important bearing on the question of the nature of the γ ray and its connection with the β ray.

In the case of graphite, an effect was observed which indicated that the primary γ rays from the active material were markedly scattered by this substance. The active matter was placed under the electroscope and a sufficient thickness of graphite placed below to absorb the β radiation. On increasing the thickness of graphite, the effect in the electroscope steadily increased up to a

thickness of 4 cms. With lead instead of graphite, the increase was hardly noticeable. This effect was at first thought to be due to the excitation by the γ rays of the radiation characteristic of carbon, but was later shown to be due to scattering alone. In later experiments, Gray has obtained definite evidence that the primary γ rays of radium E are able to excite characteristic radiations (see Section 33) in elements of atomic weight between silver and didymium. Such results are of great interest in showing the identity of X and γ rays.

104. Nature of the γ rays. In addition to their great penetrating power, the γ rays differ from the α and β rays in not being deflected by a magnetic or electric field. In a strong magnetic field, it can be shown by the photographic method that there is an abrupt discontinuity between the β and γ rays, for the former are bent completely away from the latter. Paschen* passed γ rays through a very intense magnetic field and observed no deviation. He calculated that if the γ rays consisted of charged particles projected with nearly the velocity of light, they must have an apparent mass certainly greater than 45 times that of the atom of hydrogen. The heating effects of the γ rays from radium are of about the same magnitude as that due to the β rays, so that the last possibility is excluded.

It has generally been supposed that X rays and γ rays are analogous types of radiation, the main difference being that the γ rays are on the whole far more penetrating than the X rays. There are at first sight certain apparent differences in properties between the X rays and γ rays which might indicate a difference of nature. For example, ordinary X rays produce relatively far more ionisation in complex gases and vapours compared with air than penetrating γ rays. A further study has shown, however, that this relative ionisation is not a constant but depends on the penetrating power of the X rays employed. Eve† showed that the high relative values of the conductivity for some complex gases were greatly reduced when very penetrating X rays were used. Barkla has shown that "characteristic" radiations are set

* Paschen, *Ann. d. Phys.* **14**, pp. 164, 389, 1904; *Phys. Zeit.* **5**, p. 563, 1904.

† Eve, *Phil. Mag.* **8**, p. 610, 1904.

up in some elements when X rays traverse them. Such an effect has not so far been generally observed for γ rays, but we have seen that Gray has obtained some evidence that a characteristic radiation is set up in heavy elements by the soft γ rays from radium E (Section 103). The X rays in traversing matter liberate a type of β radiation of moderate velocity and penetrating power; the γ rays also liberate β particles but with still greater velocity. There is at present no definite evidence to indicate that the X rays and γ rays are fundamentally different kinds of radiation. There is every reason to believe that the γ rays arising from radio-active matter would show identical properties with X rays of the same penetrating power.

We have seen (Section 33) that the X rays were initially believed to be narrow spherical electromagnetic pulses set up by the sudden stopping of electrons by matter. On this view, the cathode rays are to be regarded as the parents of the X rays. In a similar way, there appears to be little doubt that the appearance of γ rays from radio-active matter is connected with the expulsion of β rays, for γ rays have only been observed from products which emit β rays. At present, there is no definite evidence of the mode of origin of the γ ray in the atom. It may, for example, be due to the rapid acceleration or retardation of an escaping electron in moving through the strong electric field inside the atom. A discussion of the possible origin of the β and γ rays and of their connection with atomic transformations is given in Chapter XVIII.

The spherical pulse theory at first seemed to offer a satisfactory explanation of the nature and origin of X rays, but a closer comparison of experiment with theory has raised many difficulties. The passage of X or γ rays through matter is always accompanied by the appearance of high speed electrons or β rays. The initial velocity of escape of these electrons is independent of the *intensity* of the rays and apparently does not depend on the nature of the material from which they arise. The initial velocity, however, does depend on the quality or penetrating power of the rays, increasing with the hardness of the rays. For example, soft X rays give slow velocity β particles, while penetrating γ rays from radium give rise to β particles which have a velocity greater

than $\cdot 9$ of the velocity of light. It is of interest to note that the initial velocity of expulsion of the β particle from matter traversed by X rays is of about the same magnitude as the velocity of the cathode particles which generate the X rays.

The evidence as a whole indicates that the energy of these secondary high speed β particles is derived mainly if not entirely from the *energy of the primary radiation*. It has been suggested that the energy of the β ray may possibly be derived at the expense of the internal energy of the atom by some sort of "trigger" action. There is no definite evidence in support of this view, and much indirect evidence against it. Experiments bearing on this point have been made by Bumstead* and Angerer†. The necessary concentration of the energy of the pulse in an atom in order to be emitted again in the form of the high speed electron raises many difficulties. These may be illustrated by consideration of the passage of the γ rays from radium through air. The total number of β particles emitted per second from one gram of radium in equilibrium is about 7×10^{10} . Assuming for simplicity that each β particle in escaping from the radio-active atom gives rise to one pulse, the number of pulses emitted per second is 7×10^{10} . The total energy of the γ rays from one gram of radium is certainly not much greater than 4 gram calories per hour or $4\cdot 7 \times 10^4$ ergs per second. Taking this value, the average energy in a pulse is thus $6\cdot 7 \times 10^{-7}$ ergs. The γ rays are half absorbed in passing through 115 metres of air, and the ionisation due to the γ rays from one gram of radium at 100 metres distance is easily measurable, for it would cause three to four times the natural rate of leak to a well insulated electroscope. Disregarding absorption, the energy per square centimetre of the surface of the advancing pulse at a distance of 100 metres from the source is $5\cdot 3 \times 10^{-16}$ ergs. Now we have seen that the γ rays liberate high speed β particles of velocity independent of the intensity of the rays and their distance from the source. Supposing that the β particle is ejected with a velocity $\cdot 9$ of that of light, the energy absorbed from the radiation corresponds to $7\cdot 5 \times 10^{-7}$ ergs. This energy is enormous compared with that contained in one

* Bumstead, *Phil. Mag.* **11**, p. 292, 1906.

† Angerer, *Ann. d. Phys.* **24**, p. 370, 1907.

square centimetre of the pulse at a distance of 100 metres. Supposing that the atom has the property of abstracting energy from one square centimetre of the surface of the pulse, and storing it up, 1.2×10^9 pulses must pass over the atom before it acquires sufficient energy to eject the β particle at the observed speed. As . . . as seems far more probable, that the atom can only abstract energy from the pulse for a distance comparable with the diameter of the atom, it is seen that an interval measured by years must elapse before the atom can acquire the requisite amount of energy from the pulses passing over it. Such a calculation brings out clearly the inadequacy of the ordinary spreading pulse theory to account for the observed facts, even when it is supposed that some of the atoms have the power of absorbing and storing up energy from the pulses and finally liberating it in the form of a high speed electron. The difficulty of explanation still remains even if it be supposed that the pulse is concentrated to some extent, for example, if it spreads out in a cone instead of a sphere.

From a recognition of these difficulties in the pulse theory and of the close similarity of the ionisation effects produced by X and γ rays with those due to α and β rays, Bragg* suggested that the γ rays were corpuscular in nature. As a simple working hypothesis, he supposed that the X or γ rays consisted of a negative electron united with a sufficient quantity of positive electricity to neutralise its charge. These "neutral doublets" were occasionally broken up in traversing the atoms of matter, when a negative electron appeared endowed with a velocity corresponding to that of the doublet before disintegration. On this view, the penetrating power of the X or γ ray depends on its velocity. This variation of velocity of the doublet offered a direct explanation of the variation of the velocity of the expelled electron with the quality of the γ rays. A definite proof that X or γ rays are propagated with the velocity of light would invalidate this special theory of the structure of the entity constituting the γ ray. The determination of the velocity of X rays is beset with great difficulties, but Marx has given strong evidence that they are propagated with the velocity of light. The essential point, however, involved in Bragg's theory is that the X or γ ray is a definite and concentrated entity

* Bragg, *Phil. Mag.* **14**, p. 429, 1907; **15**, p. 663, 1908; **20**, p. 385, 1910.

and not a spreading pulse or wave. If it be preferred, it may be assumed as has been done by Stark* that the γ ray is a concentrated bundle of electromagnetic energy which is propagated without change of form with the velocity of light.

According to Bragg's theory, the X or γ ray and the β ray are mutually convertible forms of energy. Consider, for example, the effects of a stream of cathode rays falling on the anti-cathode in a vacuum tube. Part of these rays are scattered back, while the others lose in energy by ionisation and collisions with the atoms of matter composing the anti-cathode. Occasionally one of the particles is suddenly stopped by an atom, and the energy of the particle is converted into another form and appears as an X ray which travels on in the original direction of the particle at the moment of absorption. For all practical purposes, the X ray then behaves as an uncharged corpuscle. As it is electrically neutral, it is far more penetrating than the cathode ray which produced it. The X ray travels through the gas suffering deflections of its path in passing through the atoms.

It will be seen in the next section that the experimental evidence shows that the X ray or γ ray does not itself ionise the gas to an appreciable extent, so that probably the γ ray loses but little of its energy in passing through many atoms. In consequence of a violent atomic encounter, the γ ray disappears and its energy is converted into that of a high speed β particle, which travels usually in the direction of the γ ray. The β particle suffers deflections from its path in the atomic encounters, and loses energy rapidly by ionisation. Occasionally a particle, however, may be suddenly stopped by an atom, and change again to an X ray. This theory offers a concrete and general explanation of the connection between the X or γ rays and the β rays. It suggests why the β particle excited by a γ ray travels on in the direction of the γ rays, and also why the γ ray travels on in the direction of the β ray which produced it.

We have already drawn attention to some of the difficulties of the spreading pulse theory, and the modifications of it that have been proposed. It is of interest at this stage to consider some

* J. Stark, *Phys. Zeit.* 10, p. 902, 1909; 11, pp. 24, 179, 1910.

experiments that have been made by E. Meyer* to decide between the two hypotheses. The general method adopted was similar to that described in Section 75 to show that the α and β radiations are discontinuous, and that there are always fluctuations when one source of ionisation is balanced against another. In Meyer's experiments the fluctuations of the balance were determined when the ionisation due to the γ rays was measured (1) in a hemisphere, (2) in a cone of small solid angle. On the spreading pulse theory, the same number of pulses would pass per second through the apparatus in both cases. But on a corpuscular theory of γ rays the number is not the same but varies in the ratio of the solid angles. From a comparison of the experimental results obtained in the two cases, Meyer found a better agreement with the corpuscular theory. The question is, however, somewhat more complicated than appears at first sight, since the ionisation due to γ rays is mainly, if not entirely, due to the β rays which they excite in matter. Campbell† has discussed in detail the theory of Meyer's method, and concludes that the observations of Meyer do not afford a decisive test between the two theories. The problem is a difficult one and is still under investigation.

Laby‡ balanced against each other the ionisation produced in two vessels by the γ rays and found that there were marked fluctuations of the balance. He concluded that either the energy of the γ rays is confined to one direction or that the ionisation produced by them is subject to variations.

If it be supposed that the pulse does not spread but consists of a bundle of energy propagated with a velocity of light, the main distinctions between the theories disappear, and it is difficult to obtain a decisive test between them. The general pulse theory in the hands of Barkla has proved of great utility in suggesting investigations which have brought to light some facts of great importance. Reference has already been made (Section 33) to the very remarkable results obtained by Barkla with regard to the excitation and absorption of the radiations which are set up when

* Meyer, *Ber. d. kgl. Preuss. Akad. d. Wiss.* **32**, p. 647, 1910, and *Phys. Zeit.* **11**, p. 1022, 1910. See also v. Schweidler, *Phys. Zeit.* **11**, pp. 225, 614, 1910.

† Campbell, *Phys. Zeit.* **11**, p. 826, 1910.

‡ Laby, *Nature*, **87**, p. 144, 1911.

X rays traverse matter. Barkla has found that certain substances can emit several types of characteristic radiations which vary widely in penetrating power. It is not yet settled whether these characteristic radiations are set up directly by the passage of the X rays through the atoms or whether the X rays are first converted into β particles which in their turn are converted into characteristic X rays.

Whiddington* has shown that the characteristic radiation of a given metal appears when the velocity of the cathode particles in a vacuum tube exceeds a certain definite value which is directly proportional to the atomic weight of the substance. The type of characteristic radiation can thus be expressed in terms of the velocity of the electrons required to excite it. It appears as if the β particle must possess a certain energy before it can penetrate the region of the atom where the β particle is converted into the X ray. The excitation of several types of characteristic radiations may be due to the existence of several such successive regions in the structure of the atom.

Since there is little doubt that the γ rays are of the type of penetrating X rays, it is to be expected that some evidence should be obtained of the excitation of characteristic radiations by the passage of γ rays through matter. We have seen that Gray has obtained evidence of effects of this kind using the γ rays from radium E. There are certain anomalies in the absorption of γ rays by different kinds of matter which are probably connected with the excitation of characteristic radiations by γ rays. The experimental evidence available is, however, too incomplete to draw definite conclusions.

It is evident that the passage of X rays and γ rays through matter is a very complicated phenomenon, and further examination promises to throw much light not only on the nature of X rays and γ rays but also indirectly on the structure of the atoms of matter.

105. The ionisation and absorption of γ rays. The intensity of the γ rays emitted from a radio-active substance is not influenced by temperature nor by placing the active matter in a strong magnetic field. In addition, the absorption of the

* Whiddington, *Proc. Roy. Soc. A*, **85**, p. 323, 1911; *Nature*, **88**, p. 143, 1911.

γ rays by matter depends only on the number of atoms traversed and is independent of their molecular combinations, and in this respect resembles that of α and β rays. W. Wilson* showed that the absorption of γ rays by iron was not influenced by raising the temperature of the iron block to a red heat. The ionisation due to the γ rays after the transmission through the iron block was found to be slightly greater for a high than for a low temperature. This, however, was completely accounted for by correcting for the change of the density of the iron with temperature.

There has been considerable discussion of the question whether X rays and γ rays themselves ionise the gas they traverse or whether the ionisation is due to the β particles which are released from matter by the action of the primary rays.

Bragg† has investigated the question for X rays, and concludes that on the whole the evidence indicates that the ionisation is due to the β radiation and not to the X rays themselves. In the case of the γ rays, some light is thrown on the question by measurements of the ionisation by γ rays in gases at high pressures. Experiments of this kind have been made by Laby and Kaye‡ and by W. Wilson§. It is found that the ionisation at first increases nearly proportionally with the pressure, but at higher pressures, *e.g.* from 20 to 100 atmospheres, the ionisation increases more slowly with rise of pressure. The shape of the curves giving the relation between ionisation and pressure depends upon the dimensions of the ionisation chamber. Suppose, for example, the ionisation due to an external source of γ rays is measured in a metal electroscope containing gas at high pressure. The ionisation in the electroscope is then due (1) to the β particles emitted from the walls of the vessel, (2) to the β particles emitted from the gas itself, and (3) to a possible volume ionisation of the gas by the γ rays themselves. The ionisation due to (1) tends to reach a maximum value when the pressure is sufficiently high to absorb the β particles before they have crossed the vessel. The ionisation due to (2) will increase steadily with pressure, since the emission of β particles is

* W. Wilson, *Phil. Mag.* **21**, p. 532, 1911.

† Bragg, *Phil. Mag.* **20**, p. 385, 1910; *Proc. Roy. Soc. A*, **85**, p. 349, 1911.

‡ Laby and Kaye, *Phil. Mag.* **16**, p. 918, 1908.

§ W. Wilson, *Phil. Mag.* **17**, p. 216, 1909.

proportional to the density of the gas, *i.e.* to the pressure of the gas. The ionisation (3) would be expected to vary directly as the pressure. By assuming that the ionisation in the electroscope was due to (1) and (3) alone, Wilson showed that the volume ionisation of the γ rays in a metal vessel could not be more than 1/6 of the ionisation due to the β rays. By taking the effect of (2) into account, this fraction becomes much smaller. The evidence from such experiments thus indicates that the greater part, if not all, of the ionisation in an enclosure is due to the excited β rays and not to the γ rays themselves. At the same time, it is very difficult to decide definitely that the γ rays themselves produce no ionisation at all.

According to Bragg's view, the γ ray does not produce any ionisation until its energy is transformed by an atomic encounter into a β ray. This β particle travels on and expends its energy in ionisation of the gas.

Eve* has made measurements to determine the ionisation due to the γ rays and the secondary rays produced by them at various distances from a given quantity of radium, which is surrounded by screens of sufficient thickness to stop completely the β rays. The ionisation I at a distance R from a point source of Q grams of radium is given by

$$I = \frac{KQ}{r^2} e^{-\mu r},$$

where μ is the coefficient of absorption of the γ rays by air and K is the constant which represents the number of ions per cubic centimetre due to one gram of radium as a point source at a distance of one centimetre. Eve found that $K = 3.8 \times 10^9$. Assuming the value of $\mu = 6.0 \times 10^{-6}$ for air given in Section 98, it follows that the total number of ions produced by complete absorption of the γ rays from one gram of radium is 7.8×10^{14} . Disregarding the small γ ray effect of radium B, and taking the number of γ rays or entities expelled from one gram of radium as equal to the number of β particles expelled from the radium C present, *viz.* about 3.4×10^{10} per second, it follows that each γ ray on the average produces 23,000 ions. Assuming that the energy required

* Eve, *Phil. Mag.* **22**, p. 551, 1911.

to produce an ion is equal to 5.5×10^{-11} ergs (Section 68) this ionisation would be produced by a β particle of initial velocity about .95 of the velocity of light. This velocity is of about the same magnitude as that observed for the swift β particles released by the γ rays from matter.

Moseley and Robinson in the laboratory of the writer repeated the experiments made by Eve and found the total number of ions produced by the γ rays to be about 13×10^{14} , a value somewhat higher than that obtained by Eve. From the theoretical discussion on the β and γ rays given in Chapter XVIII, it will be seen that there is strong evidence that several γ rays arise for the expulsion of each β ray from a radio-active atom. In such a case, the energy emitted in a single γ ray may be much less than the value calculated above.

CHAPTER VII

PROPERTIES OF THE RADIATIONS.

106. Luminous effects. Besides their power of acting on a photographic plate, and of ionising gases, the radiations from active bodies are able to produce marked chemical and physical actions in various substances. Most of these effects are due either to the α or β rays. The γ rays produce little effect in comparison. Since the β rays are similar in all respects to high velocity cathode rays, it is to be expected that they will produce effects similar in character to those produced by the cathode rays in a vacuum tube.

Becquerel* initially studied the action of radium rays in producing phosphorescence in various bodies. The substance to be tested was placed above the radium in the form of powder on a very thin mica plate. Examination was made of the sulphides of calcium and strontium, ruby, diamond, varieties of calcite, phosphorus and hexagonal zinc blende. Substances like the ruby and calcite, which phosphoresce under luminous rays, did not phosphoresce under the radium rays. On the other hand, those which were made luminous by ultra-violet light were also luminous under the action of radium rays. The radium rays show distinct differences from X rays. For example, a diamond which was very luminous with radium rays was unaffected by X rays. The double sulphate of uranium and potassium is more luminous than hexagonal zinc blende under X rays, but the reverse is true for radium rays; under the influence of these rays, sulphide of calcium gave a blue luminosity but was hardly affected by X rays.

* Becquerel, *C. R.* **129**, p. 912, 1899.

The following table shows the relative phosphorescence excited in various bodies.

Substance	Without screen. Intensity	Across screen of black paper
Hexagonal zinc blende	13.36	.04
Platino-cyanide of barium	1.99	.05
Diamond	1.14	.01
Double sulphate of uranium and potassium	1.00	.31
Calcium fluoride30	.02

In the last column the intensity without the screen is in each case taken as unity. The great diminution of intensity after the rays have passed through black paper shows that most of the phosphorescence developed without the screen is, in the majority of cases, due to the α rays.

Bary* has made a very complete examination of the class of substances which become luminous under radium rays. He found that the great majority of substances belongs to the alkali metals and alkaline earths. All these substances were also phosphorescent under the action of X rays.

Crystalline zinc sulphide (Sidot's blende) phosphoresces very brightly under the influence of the rays from radium and other very active substances. This property of zinc sulphide was initially observed by Giesel and has proved invaluable as a delicate optical means of comparing quantitatively the activity of substances emitting α rays. It is an especially sensitive means of detecting the presence of α rays, since it exhibits the "scintillating" property already discussed in Section 60. In order to show the luminosity due to the α rays, the screen should be held close to the active substance, as the rays are absorbed in their passage through a few centimetres of air. Zinc sulphide is also luminous under the action of the β rays, but the phosphorescence is far more persistent than when produced by the α rays and does not show obvious scintillations.

Very brilliant luminous effects can be produced by admitting a large amount of radium emanation into a glass tube coated

* Bary, *C. R.* 130, p. 776, 1900.

internally with zinc sulphide. In a similar way, if the radium emanation is concentrated in a very thin-walled glass tube which allows the α rays to escape with little absorption, intense luminosity is produced on a zinc sulphide screen brought near it.

Very beautiful luminous effects are produced by large crystals of the platinocyanides exposed to the radium rays. Those containing lithium give a brilliant pink colour. The calcium and barium salts fluoresce with a deep green light, and the sodium compound with a lemon yellow. The mineral willemite (zinc silicate) as discovered by Kunz, is an even more sensitive means of detecting the presence of the radiations than platinocyanide of barium. It fluoresces showing a beautiful greenish colour, and a piece of mineral exposed to the action of the rays appears quite translucent. The crystals of the platinocyanides of barium and lithium are especially suited for showing the action of the γ rays, and, in this respect, are superior to willemite.

A very striking effect is shown by the mineral kunzite—a new variety of spodumene discovered by Kunz*. This is a transparent gem-like crystal, often of very large size, which glows with a beautiful reddish colour under the action of the β or γ rays, but does not appear to be sensitive to the α rays. The luminosity extends throughout the crystal, but is not so marked as in the platinocyanides or willemite. The mineral sparteite †, a form of calcite containing a few per cent. of manganese, has been found by Ambrecht to fluoresce with a very deep orange light under the β and γ rays. The colour appears to depend on the intensity of the rays, and is deeper close to the radium than at some distance away.

If kunzite and sparteite are exposed to the action of the cathode rays in a vacuum tube, the colour is different from that produced by the radium rays. The former appears deep yellow, instead of deep red as observed with the radium rays.

The different actions of the radium rays on these fluorescent substances can be illustrated very simply and beautifully by the following experiment. A small U tube is filled with fragments of the fluorescent substances arranged in layers. The U tube is

* Kunz and Baskerville, *Amer. Journ. Science*, **16**, p. 335, 1903.

† See *Nature*, **69**, p. 523, 1904.

immersed in liquid air and the emanation from about 20 mgrs. of radium is condensed in the tube. On closing the tube and removing it from the liquid air, the emanation distributes itself uniformly in the tube. The shades of colour produced in the different substances are clearly seen.

It is observed that all the crystals increase in luminosity for several hours, on account of the growth of active deposit from the emanation. This effect is especially observed in kunzite, which at first hardly responds to the rays, since the β and γ rays, which cause it to fluoresce, are not given out by the emanation itself but by its later products. The intensity of the β and γ rays is, in consequence, small at first but rises to a maximum after several hours; the luminosity observed varies in a corresponding manner.

An account of the various luminous effects produced in different gems by exposure to the rays from radium and actinium has been given by Kunz and Baskerville*.

The effect of radium rays on the diamond has been examined by several observers. Some kinds of diamond are strongly luminous while others are not. Glew† and Regener‡ found that some diamonds give scintillations when exposed to α rays but these are of less intensity than those shown by zinc sulphide. The scintillations produced in a thin diamond plate were used by Regener to count accurately the number of α particles emitted from polonium (Section 61). Sir William Crookes§ has given an account of the changes of colour in a diamond exposed for a long time to the α , β and γ rays from radium.

When barium platino-cyanide is exposed to the action of α or β and γ rays, it rapidly changes to a brown or red colour and its luminosity rapidly decreases. Beilby||, who has made an extensive examination of the luminosity produced in various substances by β and γ rays, found that the luminosity of barium platino-cyanide rapidly sank to 1/12 its initial value and then remained constant. The luminosity was not regenerated by exposure to a strong light

* Kunz and Baskerville, *Science*, **18**, p. 769, 1903.

† Glew, *Arch. Röntgen Rays*, June, 1904.

‡ Regener, *Ber. d. Akad. d. Wiss. Berlin*, **38**, p. 948, 1909.

§ Crookes, *Proc. Roy. Soc. A*, **74**, p. 47, 1904.

|| Beilby, *Proc. Roy. Soc. A*, **74**, pp. 506, 511, 1905.

but could only be regained by solution and re-crystallisation. He concluded that the change in colour was due to the loss of the water of crystallisation under the influence of the rays. Giesel made a screen of platinocyanide of radio-active barium. The screen, very luminous at first, gradually turned brown in colour, and at the same time the crystals became dichroic. In this condition, the luminosity was much less, although the active substance had increased in activity after preparation.

The scintillations produced in zinc sulphide are of very short duration. R. W. Wood* concluded that the luminosity did not last more than $1/40,000$ of a second.

The action of continued bombardment of a zinc sulphide screen by α and β rays is of special importance on account of the extensive use of such screens for counting the number of α particles emitted by radio-active matter. Marsden† found that the number of scintillations produced by a constant source of α rays on a zinc sulphide screen was not altered when the screen had been exposed to a very intense bombardment of α particles, but each scintillation became much feebler. At the same time, owing to the bombardment, the average luminosity of the screen rapidly diminished to a small fraction of its initial value. The decay of the luminosity was observed in small glass tubes coated internally with zinc sulphide in which a large quantity of the radium emanation was introduced. After an initial rise due to the growth of the active deposit, the luminosity, measured by a photometer, was found to decrease far more rapidly than the activity of the emanation, and had diminished to a few per cent. of its initial value in a few days. A similar result was observed for willemite, but the loss of luminosity for a given α ray bombardment was somewhat slower than for zinc sulphide. In the case of barium platino-cyanide, the luminosity due to the α rays decreased with great rapidity and became small after a few hours. In explanation of these results, the writer‡ suggested that each of these phosphorescent substances contained a number of "active centres" which were dissociated by the radiations with

* R. W. Wood, *Phil. Mag.* 10, p. 427, 1905.

† Marsden, *Proc. Roy. Soc. A*, 83, p. 548, 1910.

‡ Rutherford, *Proc. Roy. Soc. A*, 83, p. 561, 1910.

the emission of light. Each centre after it had been struck ceased to be effective, and the decay of luminosity was ascribed to the gradual destruction of these active centres throughout the volume exposed to the α radiation. The gradual decrease in number of the active centres offered an explanation of the fact that an intense bombardment by α rays did not alter the number of scintillations but only their intensity. The observed curves of decay of the luminosity were in fair accord with the theory. From a knowledge of the range of the α particles in the material and the number of α particles falling on the screen, it was calculated that a single α particle, on the average, destroyed all the active centres in its path in zinc sulphide within a cylinder of length equal to the range of the α particle and of diameter 1.3×10^{-7} cms. This is comparable with the diameter of an atom and indicated that the luminosity of a scintillation must be due to the dissociation of molecules or small molecular aggregates and not, as had been suggested, to the mechanical disruption of the crystals. The corresponding cylinder of action for willemite was somewhat greater, viz. 2.5×10^{-7} cms. On the other hand, results for barium phosphide indicated that the α particle was instrumental in destroying all the active centres within a diameter 1.6×10^{-5} cms. This suggests that the disturbance due to an α particle in this substance extends for a considerable area around its path.

Stefan Meyer* observed that a specimen of kunzite after exposure for several days to radium rays lost its violet colour and became green.

Marsden (*loc. cit.*) made a detailed examination of the duration of the luminosity in zinc sulphide and willemite after exposure to β and γ rays. On exposing zinc sulphide to a constant source of β rays, the luminosity increased for about 20 minutes. On removing the source of β rays, the luminosity sank more gradually than it had risen. Willemite showed different effects. The luminosity due to β rays rose rapidly to a maximum in a few minutes, while, on removal of the β rays, the luminosity sank at once to a small fraction of its value. There was then a slow decay to zero.

* Stefan Meyer, *Phys. Zeit.* 10, p. 483, 1909.

107. Luminosity of radium compounds. All radium compounds are spontaneously luminous. This luminosity is especially brilliant in the dry haloid salts, and persists for long intervals of time. In damp air the salts lose a large amount of their luminosity, but they recover it on drying. With very active radium chloride, the Curies have observed that the light changes in colour and intensity with time. The original luminosity is recovered if the salt is recrystallized. The luminosity of radium persists over a wide range of temperature and is as bright at the temperature of liquid air as at ordinary temperatures. A slight luminosity is observed in a solution of radium, and if crystals are being formed in the solution, they can be clearly distinguished in the liquid by their greater brightness.

Very active preparations of actinium show a similar luminosity, the intensity depending on the nature of the impurities present. Becquerel* has observed that crystals of uranium nitrate were spontaneously but feebly luminous. Strutt† observed that crystals of the uranium mineral autunite showed a feeble spontaneous luminosity. It will be seen later (Section 191) that solidified radium emanation emits an intense orange coloured light at the temperature of liquid air.

While it is difficult to give an exact explanation of the origin and changes of luminosity in radium preparations, there appears to be no doubt that the phosphorescence is connected with the presence of small quantities of impurities which become luminous under the continuous bombardment by the radiations. It is known that radium compounds exposed in air undergo marked chemical changes and this, no doubt, is responsible for the gradual changes of luminosity with time.

108. Light emission of gases exposed to α rays. We have seen that radium salts are feebly self-luminous. The spectrum of this weak luminosity was initially examined by Sir William and Lady Huggins‡. On viewing the light with a

* Becquerel, *C. R.* **138**, p. 184, 1904.

† Strutt, *Proc. Roy. Soc. A*, **83**, p. 70, 1909.

‡ Sir William and Lady Huggins, *Proc. Roy. Soc. A*, **72**, pp. 196, 409, 1903; **76**, p. 488, 1905; **77**, p. 130, 1905.

Spectrum of Radium Bromide

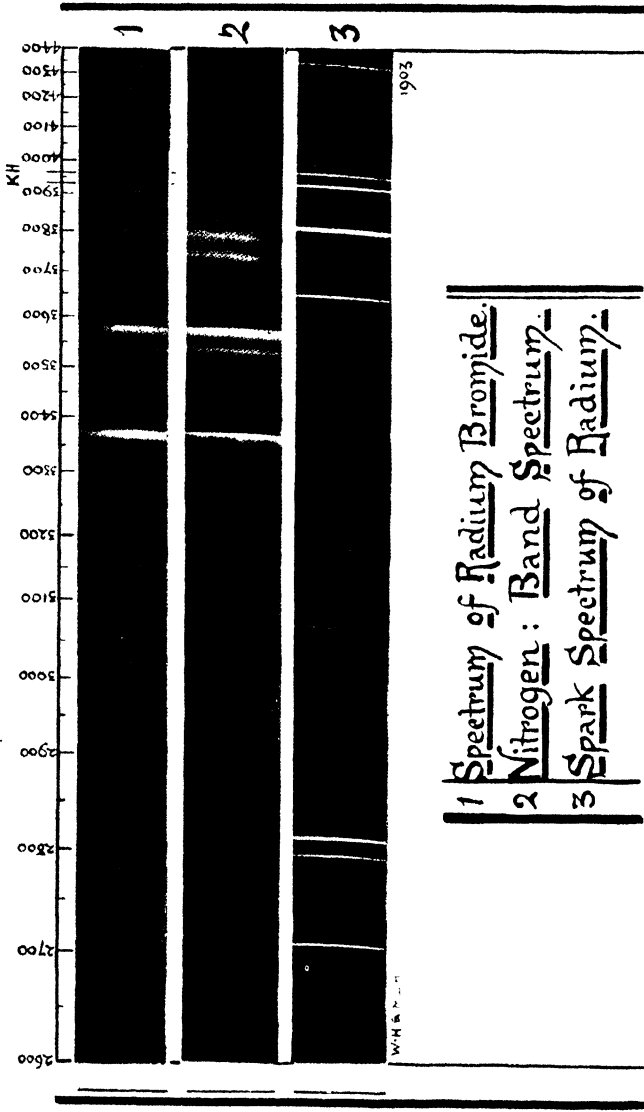

Fig. 81.

direct vision spectroscope, there were faint indications of variations of luminosity along the spectrum. In order to get a photograph of the spectrum within a reasonable time, they made use of a quartz spectroscope of special design which had been previously employed in a spectroscopic examination of faint celestial objects. After three days' exposure with a slit of $1/450$ of an inch in width, a negative was obtained which showed a number of bright lines. The magnified spectrum is shown in Fig. 81. The lines of this spectrum were found to agree not only in position but also in relative intensity with the band spectrum of nitrogen. The band spectrum of nitrogen and also the spark spectrum* of radium are shown in the same figure. Crookes and Dewar later showed that the spectrum of nitrogen was not obtained if the radium was contained in a highly exhausted tube. It thus appeared that the spectrum is due to the nitrogen of the air or to nitrogen occluded in the radium salt.

These results have been confirmed by a number of later observers, including Himstedt and Meyer†, Walter‡, and Pohl§. The spectrum of the luminous radium bromide is in part continuous due to the fluorescence of the crystals. In an atmosphere of helium, three helium lines were faintly observed. In hydrogen, carbon monoxide and carbon dioxide, no trace of a line spectrum was seen. There appears to be no doubt that the line spectrum observed in nitrogen and helium is due to the bombardment of the gas by the α particles. This is borne out by the observations of Walter, Marckwald and Herrmann||, who found that the α rays from polonium in air also produced the band spectrum of nitrogen. With a very active preparation, the luminosity can be detected some centimetres from the source of

* The spark spectrum of the radium bromide showed the *H* and *K* lines of calcium and also faintly some of the strong lines of barium. The characteristic lines of radium of wave-lengths 3814.59, 3649.7, 4340.6 and 2708.6, observed by Demarçay and others, are clearly shown in the figure. The strong line of wave-length about 2814 is due also to radium.

† Himstedt and G. Meyer, *Phys. Zeit.* **6**, p. 688, 1905; **7**, p. 762, 1906.

‡ Walter, *Ann. d. Phys.* **17**, p. 367, 1905; **20**, p. 327, 1906.

§ Pohl, *Ann. d. Phys.* **17**, p. 375, 1905; *Verh. d. D. Phys. Ges.* **7**, p. 458, 1905. Walter and Pohl, *Ann. d. Phys.* **18**, p. 406, 1905.

|| Marckwald and Herrmann, *Verh. d. D. Phys. Ges.* **7**, p. 227, 1905.

α rays. Stark and Giesel* using a strong polonium preparation observed that the source was surrounded by a luminous zone extending over the range of the α particles.

These results are of great interest, for they show that the α rays are able to excite a weak luminosity in the gases they traverse, of which the spectrum is similar to that produced by the electric discharge under special conditions. Sir William and Lady Huggins were initially led to examine the spectrum of the spontaneous luminosity of radium with the hope of throwing some light on the processes of transformation occurring in that substance. Taking into consideration the intense bombardment to which the radium compound is subjected by its own radiations as well as the violent atomic disruptions which occur, it is to be expected that the radium or its products of transformation should be set in vibration. So far, however, no indication of such an effect has been observed. Possibly the radiations emitted are either too feeble or of too short wave-length to be detected. Giesel† observed that the spectrum of the weak luminosity shown by a very active preparation of actinium showed three bright lines. An examination of the spectrum was made by Hartmann‡ and it was concluded that the lines were due to impurities present in the preparation and probably to didymium which gives a fluorescent spectrum under the action of cathode rays similar to that observed for the actinium preparation.

109. Thermo-luminescence. E. Wiedemann and G. C. Schmidt§ have shown that certain bodies after exposure to the cathode rays or the electric spark become luminous when they are heated to a temperature much below that required to cause incandescence. This property of thermo-luminescence is most strikingly exhibited in certain cases where two salts, one of which is much in excess of the other, are precipitated together. It is to be expected that such bodies would also acquire this property when exposed to the β rays of radium. This has been found to

* Stark and Giesel, *Phys. Zeit.* **8**, p. 580, 1907.

† Giesel, *Ber. d. D. Chem. Ges.* **37**, p. 1696, 1904; **38**, p. 775, 1905.

‡ Hartmann, *Phys. Zeit.* **5**, p. 570, 1904; **6**, p. 401, 1905.

§ Wiedemann and Schmidt, *Ann. d. Phys.* **59**, p. 604, 1905.

be the case by Wiedemann*. Becquerel showed that fluor-spar, exposed to the radium rays, was luminous when heated. The glass tubes in which radium is kept are rapidly coloured. On heating the tube, a strong luminosity is observed, and the colouration to a large extent disappears. The peculiarity of many of these bodies lies in the fact that the property of becoming luminous when heated is retained for a long interval of time after the body is removed from the influence of the exciting cause. It appears probable that the rays cause chemical changes in these bodies, which are permanent until heat is applied. A portion of the chemical energy is then released in the form of visible light.

110. Photographic action of the rays. Active preparations of all radio-active substances produce a marked action on the photographic plate. In the case of the α rays, the photographic action disappears when the α particles lose their power of ionisation and of producing scintillations in zinc sulphide. Fairly clear radiographs of objects can be obtained with the β or γ rays. On account of the marked scattering of the β rays, the edges of objects are not so clearly defined as with X rays. Radiographs obtained by the γ rays show a better definition than with β rays; but to obtain the best effects it is desirable to deflect away the β rays which accompany the γ rays with a magnetic field. There is not the same contrast for substances of different density which are shown by radiographs with X rays. For example, the bones of the hand do not show out so clearly with γ rays as with X rays.

A detailed examination of the photographic action of the α particles was made by Kinoshita†. A rod coated with radium C, which emits homogeneous α rays, was used as a source of radiation. The variation of the density of the photographic film on development with the number and the velocity of α particles incident upon it was experimentally determined under various conditions. By using several thin superimposed films, the variation of the photographic action at different points of the range of the

* Wiedemann, *Phys. Zeit.* **2**, p. 269, 1901.

† Kinoshita, *Prog. Roy. Soc. A*, **83**, p. 432, 1910.

α particle was measured. The general conclusion reached was that the photographic action was nearly constant along the greater part of the range of the α particle, but fell off rapidly near the end of its path.

We have seen that the ionisation due to a pencil of α rays increases with lowering of velocity to a well marked maximum, and then falls rapidly to zero. Since the law of absorption of α rays in solids is similar to that in gases, it is to be expected that there should be a similar variation of the ionisation due to the α particle along its path in the film. The constancy of the photographic effect along the range of the α particle indicated that each grain of the silver salt traversed by the α particle was rendered capable of development, independently of the number of ions produced in it. Microscopic measurements showed that the grains so produced were about the same size. By counting with a microscope the number of grains in a thin film after exposure to the α rays, Kinoshita found that the number of grains was equal to the number of α particles incident on the film, provided the density of the photographic impression was small. This is an important result, for it shows that each α particle produces a detectable photographic effect. Under suitable conditions, there appears to be no doubt that the photographic methods developed by Kinoshita could be employed to count the number of α particles emitted by the radio-active substances.

The effect of continued bombardment of a film by the α rays produces a different action to that of over exposure to light. For small densities of the film, the number of grains observed is directly proportional to the number of α particles falling on it. With increased bombardment the number of grains increases more slowly and finally reaches a maximum value when all the grains of silver salt are acted upon. As the fraction of the total number of grains traversed by the α particles approaches unity, it is to be expected that the additional photographic effect due to a given number of α particles would decrease since the α rays can only produce an effect on the free grains which have escaped the previous bombardment.

The photographic action of the β rays from the thin film of

radium C was found to be $1/3$ to $1/4$ that of the α rays, while the effect of the γ rays on thin films was negligible in comparison. Since, however, the β and γ rays are far more penetrating than the α rays, only a small fraction of their energy is spent in the photographic film. It is thus to be expected that for an equal number of β particles, the slower velocity rays will produce more photographic action in the thin film than the swifter, since the actual loss of energy in traversing the film is less for the latter. Examples of such effects have been observed experimentally by v. Baeyer, Hahn and Meitner in their work on the magnetic spectrum of β rays (Section 95). It is well known that the photographic effect of a thick layer of uranium is mostly due to the β rays, and that the effect due to the α rays is small in comparison*. This is to be expected from the relative photographic effects of α and β rays for thin films found by Kinoshita.

Reinganum† observed photographically the trail of an α particle in the film by allowing the α particle to strike at grazing incidence.

111. Colouration of bodies. The radiations from active bodies produce marked chemical actions in a number of substances. The effects due to the α rays are in general far more evident than those due to the β and γ rays. One of the most striking effects due to the radiation is the marked colouration of glass under the influence of the rays. This is produced by all three types of radiation but to different degrees. The initial observations on this subject were made by M. and Mme Curie. Ordinary soda glass is coloured a deep violet, and with long continued action the glass becomes almost black, even if it has no lead in its composition. Other kinds of glass are coloured brown or yellow. The colouration due to the α rays extends only for a short distance corresponding to the range of the α particles in the glass. The colouration due to more penetrating β and γ rays extends throughout the whole of the glass exposed to the radiation. Rudge‡ has shown that glass exposed to the radiation exhibits in

* Soddy, *Trans. Chem. Soc.* **81**, p. 860, 1902.

† Reinganum, *Verh. d. D. Phys. Ges.* **13**, p. 848, 1911.

‡ Rudge, *Roy. Soc. South Africa*, Oct. 18th, 1911; *Nature*, **88** p. 167, 1911.

many cases a zonal structure in its colourations and that there are abrupt changes in the depth of colouration depending upon the structure of the glass. The colouration of glass by radium rays is similar to that observed in X ray tubes which have been long in use.

Giesel* found that he could obtain as much colouration in rock-salt and fluor-spar by radium rays, as by exposure to the action of cathode rays in a vacuum tube. The colouration, however, extended much deeper than that produced by the cathode rays. This is to be expected, since the radium rays have a higher velocity, and consequently greater penetrating power, than the cathode rays produced in an ordinary vacuum tube. Goldstein observed that the colouration is far more intense and rapid when the salts are melted or heated to a red heat. Melted potassium sulphate, under the action of a very active preparation of radium, was rapidly coloured a strong greenish blue which gradually changed into a dark green. Salomonsen and Dreyer† found that plates of quartz were coloured by exposure to radium rays. When examined minutely, plates cut perpendicular to the optic axis showed the presence of lines and striae, parallel to the binary axes. Adjacent portions of the striated system differed considerably in intensity of colouration and clearly revealed the heterogeneity of the structure of the crystal. Similar observations have been recorded by Hönigschmid‡. Berthelot§ found that some specimens of quartz were not coloured by radium rays, indicating that the colouration observed in other specimens is due to the presence of some impurity. The writer observed that a fused quartz tube after continued exposure to the radium emanation became brittle and cracked, and the whole tube on examination showed a multitude of approximately circular cracks. Mme Curie found that quartz tubes cracked when exposed to the action of the α rays from a very active preparation of polonium. There seems to be no doubt that quartz for this reason is a very unsuitable substance in which to enclose very radio-active preparations.

* Giesel, *Verh. d. D. Phys. Ges.* 2, p. 9, 1900.

† Salomonsen and Dreyer, *C. R.* 139, p. 533, 1904.

‡ Hönigschmid, *Wien. Ber.* 120, p. 1617, 1911.

§ M. Berthelot, *C. R.* 145, p. 710, 1907; D. Berthelot, *C. R.* 145, p. 818, 1907.

Doelter* has made a detailed examination of the colouration produced in minerals by radium rays, and has suggested explanations of the effects observed in different cases. He found that the colouration rapidly disappeared under the action of ultra-violet light.

The cause of these colourations by cathode and radium rays has been the subject of much discussion. Elster and Geitel† observed that a specimen of potassium sulphate, coloured green by radium rays, showed a strong photo-electric action, *i.e.* it rapidly lost a negative charge of electricity when exposed to the action of ultra-violet light. All substances coloured by cathode rays show a strong photo-electric action, and, since the metals sodium and potassium themselves show photo-electric action to a very remarkable degree, Elster and Geitel have suggested that the colourations are caused by a solid solution of the metal in the salt.

Although the colouration due to radium rays extends deeper than that due to the cathode rays, when exposed to light the colour fades away at about the same rate in the two cases. The colouration of glass tubes is to a large extent destroyed by heating them to the temperature of luminescence.

112. Pleochroic halos. Plates of mica are rapidly coloured brown or black by α rays, the rapidity of colouration depending on the composition of the mica. Geologists long regarded with curiosity small coloured areas in certain kinds of mica, for example, in biotite, cordierite, and muscovite. The sections of these coloured areas are usually circular in shape, and exhibit the property of pleochroism under polarised light, and for this reason were called "pleochroic halos." The centres of these areas usually contain a minute crystal of foreign matter. Joly‡ first pointed out that these halos were of radio-active origin, and were due to the colouration of the mica by the α rays expelled from a nucleus which contains radio-active matter. This subject has been

* Doelter, *Le Radium*, 7, p. 58, 1910, "Das Radium und die Farben." Th. Steinkopf. Vienna.

† Elster and Geitel, *Phys. Zeit.* 3, p. 113, 1902.

‡ Joly, *Phil. Mag.* 13, p. 381, 1907.

investigated in great detail by Joly*, and Joly and Fletcher†, and many facts of great interest have been brought to light. There seems to be no doubt that in homogeneous material, the halos are spherical with a radio-active inclusion as centre. The diameter of the central section varies in different halos between about $\cdot 013$ mm. and $\cdot 04$ mm. The range of the α rays in any material can be calculated from a knowledge of its composition. Joly has deduced that in a specimen of biotite the range of the α particles from uranium and ionium is about $\cdot 013$ mm., from radium C about $\cdot 033$ mm. and from the swiftest α particle from thorium C $\cdot 04$ mm.

Joly has shown that the halos exhibit a well marked structure, and from the diameter of the halo it can be shown whether the radio-active nucleus contains a uranium or thorium mineral. The detailed structure of the halo is clearly shown in the micro-photograph of Fig. 82A. The central blackened area or pupil is produced by the α particles emitted from all the products contained in the mineral, and its limit is defined by the range of the α particles from radium itself. The limit of the second ring, which is much lighter in colour, marks the range of the swifter α particles from radium A, while the edges of the outer ring, or corona, mark the limit of action of the α rays from radium C. It was observed in all halos that the darkening due to the α particles from radium C is most intense near the end of their range. The reason of this is clear when we take into consideration the variation of the ionisation along the path of the α particle (Sections 66 and 67). The ionisation due to an α particle shows a sharp maximum near the end of its range and then falls rapidly to zero. Assuming that the colouration of the mica at any point depends upon the density of ionisation, it is to be expected that the darkening of the mica would show the type of gradation illustrated in the figure.

Joly has shown that halos in all stages of development can be seen in a single specimen of mica. If the radio-active nucleus is very small or only feebly active, the intensity of the α radiation is so small that only the inner ring shows colouration. The

* Joly, *Phil. Mag.* **19**, p. 327, 1910.

† Joly and Fletcher, *Phil. Mag.* **19**, p. 630, 1910.



Fig. 82 A.

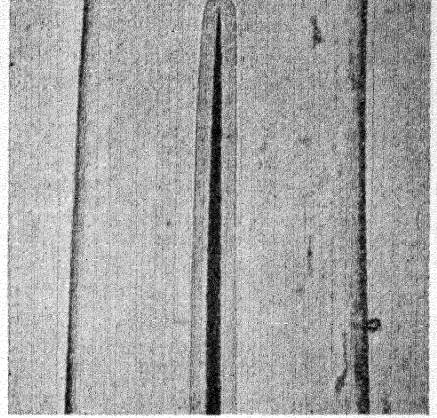

E *A C B* *F*
Fig. 82 B.

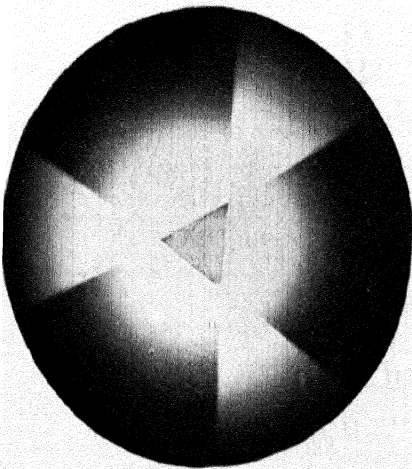

Fig. 83 A.

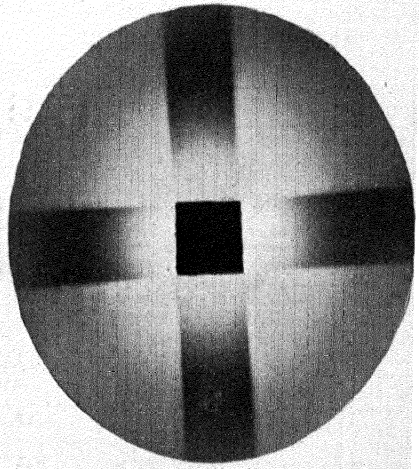

Fig. 83 B.

darkening due to the α rays from radium A and radium C is too feeble to be observed. Joly has found that a completely developed halo contains a nucleus which is often of diameter less than 5×10^{-4} cm. The corresponding volume is about 6×10^{-11} c.c. If composed of uraninite having the density 8, the mass would be approximately 5×10^{-10} gram, and the associated radium in each nucleus about 10^{-16} gram. From the known data of the number of the α particles expelled per second from one gram of uranium mineral in equilibrium (Section 170), it can be calculated that the nucleus gives off only one α particle in about 10 hours. This is a maximum estimate, since the nucleus in this case is supposed to be composed of the most radio-active of naturally occurring minerals. Even smaller nuclei than this sufficed to produce small simple halos whose radio-active origin is un-, mistakable. In certain embryonic halos, it can be shown that they must have been produced by a radio-active material which did not expel more than 80 α particles per year. It is, therefore, possible to recognise by the colouration of mica the presence of a quantity of radium of about 10^{-17} gram. This quantity is very much less than that which it is possible to detect by electric methods, viz. about 10^{-12} gram.

It is thus seen that the colouration of mica is due to the integrated effects of the α particles extending over geological ages. Joly pointed out that it is possible to draw another deduction of great importance from the examination of a substance like mica, which is easily coloured by the α rays. Mica is found unaltered and unaffected in association with many elements which are present in quantity enormous relatively to the amounts of uranium considered above. This appears to show conclusively that such elements do not expel any ionising rays even over intervals of time measured by geological epochs.

Rutherford* showed that an effect similar in character to the colouration produced in mica could be observed in glass. A large quantity of radium emanation was enclosed in a capillary tube and allowed to decay *in situ*. The microscopic examination showed that the glass was coloured to a depth of about .04 mm.

* Rutherford, *Phil. Mag.* 19, p. 192, 1910.

from the inner surface of the tube. This distance corresponded to the range of the α particles from radium C. A micro-photograph in illustration is shown in Fig. 82B, where EF is the glass tube, C is the base of the capillary, AB are the boundaries of the colouration.

113. The distribution of radiation. The general results of experiment show that α and β particles are expelled equally in all directions from a thin layer of active matter. By exposing solid bodies in the presence of the emanation of radium, thorium or actinium, they become coated with an exceedingly thin film of the active deposit from which particles escape at their maximum initial velocity. For these reasons the distribution of the radiation is in these cases very different from that observed for the same body when heated to a sufficient temperature to emit ordinary light*. In the case of light, the distribution is controlled by Lambert's Law, which supposes that the intensity of radiation in any direction is proportional to the cosine of the angle between the normal and the direction of the emitted light. In a thin film of radio-active matter, Lambert's law does not hold. For example, if a pinhole photograph be taken of a luminous sphere, *e.g.* the sun, the intensity of the photographic effect is nearly uniform over the cross section. If, however, we take a pinhole photograph of a small sphere uniformly coated with a thin film of active matter by the aid of the radiations emitted from it, the intensity of the radiation, and consequently, of the photographic impression, is greatest at the extreme edge of the image and shades off rapidly towards the centre. In a similar way, the photographic impression due to a cylinder coated with a thin film of active matter, after the rays have passed through a narrow slit parallel to the cylinder, is greatest at the edges of the geometrical image, and falls off rapidly towards the centre. If the photographic effect is weak, the image of the cylinder often appears to consist only of two straight lines corresponding to the edges of the image.

The effects of distribution can be simply and strikingly illustrated in another way. Suppose, for example, that a rod of triangular or square cross section, several centimetres long, is

* Rutherford, *Phil. Mag.* **12**, p. 152, 1906.

exposed in the presence of radium emanation. The active deposit is then nearly uniformly distributed over the surface. After removal, the rod is placed vertically on a photographic plate. Examples of the positives of the photographs produced in this way by the α rays are shown in Fig. 83. In the case of the rod of square cross section, the photograph is marked by four dark bands at right angles to each other, of the same width as the rod. In each of these dark bands, the photographic effect is due to the radiation from one side of the rod only. Immediately outside the dark bands, the radiations from two sides produce their effect, so that the intensity of the radiation varies very nearly in the ratio of one to two in crossing the boundary. By using very active bodies, this effect of distribution can be very clearly seen on a screen of zinc sulphide. The results obtained are to be expected theoretically if the α rays are expelled equally in all directions and escape from the metal without appreciable absorption.

In the experiments described the photographic effect is due almost entirely to the α rays; but no doubt somewhat similar effects would be observed if the thin film of active matter gave out only β rays.

Greinacher* has investigated the distribution of radiation around a prism of uranium metal, which is placed on a photographic plate. In this case the radiation is emitted from the whole volume of the material, and the photographic action is due mainly to the β rays of various velocities which emerge from the uranium. The distribution of the radiation was very different from that already shown. For thick films of active matter the photographic effect was greatest perpendicular to the surface of the triangle and small in the space formed by the continuation of the sides, where in the case of a thin film the intensity would be strongest.

In another experiment, a radium preparation was placed in a cubical lead box, which was placed on a photographic plate. The radiation was most intense opposite the sides, and least where the radiations from two sides of the box produced their effect.

This distribution of radiation was ascribed by Greinacher to

* Greinacher, *Phys. Zeit.* **9**, p. 385, 1908; **10**, p. 145, 1909.

the effect of secondary radiations. H. W. Schmidt* offered an alternative explanation by taking into account the distribution of β particles emitted in various directions from a thick layer of radio-active matter. According to the experiments of McClelland, the distribution of radiation from a plate is greatest in the direction of the normal, and falls off approximately as the cosine of the angle from the normal. Assuming such a cosine law of distribution, Schmidt showed that the calculated distribution of radiation was similar to that observed by Greinacher experimentally.

114. General chemical actions. We have already discussed the changes of colour in certain substances produced by the radiations from active matter. In addition, the radiations, and especially the α rays, produce marked chemical effects in a number of substances. In general, the chemical actions produced by the radiations in gases appear to be similar to those due to the silent electric discharge. In some cases, complex molecules are dissociated, in others, more complex molecules are built up.

The production of ozone by the rays of radium was early observed by M. and Mme Curie†, and was initially of great interest as illustrating in a striking way the energy connected with the radiations. If some radium is enclosed in a stoppered tube, on removing the stopper the presence of ozone can be detected either by the smell or by the action on iodide of potassium starch paper. The production of ozone appears to be mainly due to the α rays, and becomes very marked when a very intense α radiation is used. For example, if the emanation from about 50 milligrams of radium is enclosed in a thin-walled glass tube which allows the α rays to escape, a very marked odour of ozone is observed. A metal plate coated with the active deposit of radium shows a similar effect. The α rays rapidly oxidise mercury, lead, aluminium and other metals exposed in air. This effect is most simply shown by placing close to the metal a very thin walled glass tube containing a large quantity of radium emanation. The oxidation of metals is in this case mainly due to the α rays and is no doubt connected with the rapid production of ozone in the

* H. W. Schmidt, *Phys. Zeit.* **9**, p. 537, 1908.

† S. and P. Curie, *C. R.* **129**, p. 823, 1899.

surrounding air. Radium compounds are themselves chemically acted upon by the intense radiations to which they are subject. For example, radium bromide exposed to the air gives off bromine and is ultimately changed into carbonate. The water of crystallisation is decomposed into hydrogen and oxygen. Impure radium preparations containing barium undergo alteration and colouration.

The decomposition of water by the radiations, which will be discussed in detail later, is no doubt responsible for the occasional explosions of tubes containing radium compounds. If the radium preparation is not dry, the water is decomposed by the radiations into hydrogen and oxygen and the pressure may become high enough to burst the tube. The general evidence indicates that glass is itself acted on by the radiations and tends to become more brittle and diminishes in strength. Mme Curie* observed that a solution of chloride of radium contained in a platinum vessel rapidly attacks it, platinum passing into solution. This effect is probably the result of the production of nascent chlorine by the radiations. In general, the radiations rapidly decompose organic matter with evolution of gases. For example, the radiations from the radium emanation rapidly produce carbon dioxide from the grease of stop cocks, and for this reason such stop cocks have to a large extent to be dispensed with in purification of the radium emanation. Boltwood and Rutherford observed that a large volume of gas was produced when some radium emanation was enclosed in a glass tube coated with solid paraffin. The latter was changed in appearance and in properties by the action of the radiations. Under the action of an intense α radiation, paraffin and vaseline become hard and infusible. In experiments with large quantities of radium emanation the sticking of stop cocks coated with vaseline due to this cause is often very troublesome. Becquerel† found that white phosphorus is changed into the red variety by the action of radium rays. This effect is due mainly to the β rays. Radium rays, like ordinary light rays, also produce a precipitate of calomel in the presence of oxalic acid.

Hardy and Miss Wilcock‡ found that a solution of iodoform in

* Mme Curie, *Le Radium*, 4, p. 349, 1907.

† Becquerel, *C. R.* 133, p. 709, 1901.

‡ Hardy and Miss Wilcock, *Proc. Roy. Soc. A*, 72, p. 200, 1903.

chloroform turned purple after an exposure of a few minutes to a few milligrams of radium bromide. This colouration is caused by the liberation of iodine, and appears to be mainly due to the β rays. X rays produced a similar effect.

Hardy* also observed an action of the radium rays on the coagulation of globulin. Two solutions of globulin from ox serum were used, one made electro-positive by adding acetic acid, and the other electro-negative by adding ammonia. When the globulin was exposed close to the radium in naked drops, the opalescence of the electro-positive solution rapidly diminished, showing that the solution became more complete. The electro-negative solution was rapidly turned to a jelly and became opaque. These actions were found to be due to the α rays of radium alone.

Ramsay† and Cameron and Ramsay‡ made a detailed study of the action of the radium emanation on gases. The purified emanation from about 1/10 of a gram of radium was added to the gas contained in a closed vessel, and the emanation allowed to decay *in situ*. The changes in pressure of the gas were observed day by day, and the final products analysed. In this way they found that carbon dioxide was transformed into carbon, carbon monoxide and oxygen. Carbon monoxide was decomposed with the appearance of solid carbon and oxygen. Ammonia was changed into nitrogen and hydrogen, and hydrochloric acid gas into hydrogen and chlorine. They found that the amount of chemical change was proportional at any time to the activity of the emanation, showing that, under the conditions of the experiment, the transformation of each atom of the radium emanation produces a definite chemical effect. They also found that gases were re-combined by the action of the radiation. For example, nitrogen and hydrogen combined to form ammonia.

Jorissen and Ringer§ showed that hydrogen and chlorine combined to form hydrochloric acid under the influence of β and γ rays from radium. Usher|| repeated the results of Ramsay and

* Hardy, *Proc. Physiol. Soc.* May 16, 1903.

† Ramsay, *Journ. Chem. Soc.* **91**, p. 931, 1907.

‡ Cameron and Ramsay, *Journ. Chem. Soc.* **91**, p. 1593, 1907; **93**, pp. 966, 992, 1908.

§ Jorissen and Ringer, *Ber. d. D. Chem. Ges.* **39**, p. 2093, 1906.

|| Usher, *Journ. Chem. Soc.* **97**, pp. 389, 1193, 1910.

Cameron on the combination of nitrogen and hydrogen to form ammonia, but found that the rate of recombination was very small. He examined in detail the decomposition of ammonia by the radium emanation.

Frischauer* observed that the β rays of radium influenced the rate of crystallisation of sulphur. A layer of fine drops of sulphur was obtained by distillation between two glass plates. One half was exposed to β rays and the other half protected by a lead plate. The crystallisation, observed by a microscope, was found to proceed far more rapidly in the part exposed to β rays. It appears that the β rays provide additional nuclei for crystallisation.

115. The decomposition of water by the radiations.

A large number of investigations have been made on the decomposition of water by the action of the radiations from radio-active substances. On account of its importance this question will be discussed in some little detail.

Curie and Debierne† first observed that radium preparations placed in an exhausted vessel always lowered the vacuum. The gas evolved was always mixed with the radium emanation. Giesel‡ first drew attention to the rapid evolution of gas from solutions of radium compounds. From one gram of a radium preparation of 5 per cent. purity, 3.6 c.c. of gas was obtained in 16 days. The gas was found to be mainly hydrogen with about 12 per cent. of oxygen. In later experiments Ramsay and Soddy§ found that 50 milligrams of radium bromide in solution evolved gases at the rate of about .05 c.c. per day. An analysis of the gases showed that there was always an excess of hydrogen over that to be expected from the decomposition of water into two volumes of hydrogen and one of oxygen. The reason of this effect will be discussed later.

There appears to be no doubt that the decomposition of water is brought about by all three types of radiation; but the effect due to the α rays is much greater than that due to the β and

* Frischauer, *C. R.* **148**, p. 1251, 1909.

† Curie and Debierne, *C. R.* **32**, p. 768, 1901.

‡ Giesel, *Ber. d. D. Chem. Ges.* **35**, p. 3605, 1902.

§ Ramsay and Soddy, *Proc. Roy. Soc. A*, **72**, p. 204, 1903.

γ rays. Mme Curie and Debierne* and Bergwitz† found that a very active preparation of polonium, which emits only α rays, produced rapid decomposition of water into hydrogen and oxygen. Different observers have found very different rates of evolution of gases from radium solutions. This is to be expected since the intensity of the radiation acting on the water depends on the relative volume occupied by the solution and the free space above it. The α rays from radium itself no doubt produce gases at a constant rate in the solution; but a greater part of the action is due to the radium emanation which divides itself between the solution and the air space above it in amount depending on the relative volumes, and also on the temperature. This will be clear from the experiments described later (Section 143).

In addition, as Cameron and Ramsay have shown, the converse action takes place, and some of the hydrogen and oxygen recombine under the influence of the radiations to form water.

Estimations of the rate of evolution of the mixed gases have been made by Ramsay and Cameron, Debierne, Kernbaum and Usher.

Debierne‡ observed the decomposition of water in solutions of actinium and radium, and found that one gram of radium in solution produced about 13 c.c. of mixed gases per day. The production of gases by β rays has been examined by Debierne (*loc. cit.*) and Kernbaum§. The radium preparation was placed inside a double walled glass vessel containing water. Debierne found by pressure measurement that the evolution of gases proceeded at nearly a constant rate for over a month and then apparently somewhat more slowly. The rate of evolution in the gas was increased about 5 per cent. by placing a lead screen round the vessel. This increase was due to the effect of the β rays excited by the γ rays in the lead envelope. Kernbaum made a detailed study of the effect of β rays on water and showed that only hydrogen was evolved, while the oxygen remained with the water. He concluded that β rays like the rays of ultra-violet light decompose

* Mme Curie and Debierne, *C. R.* **150**, p. 386, 1910.

† Bergwitz, *Le Radium*, **7**, p. 181, 1910; *Phys. Zeit.* **11**, p. 275, 1910.

‡ Debierne, *C. R.* **148**, p. 703, 1909; *Le Radium*, **6**, p. 65, 1909.

§ Kernbaum, *C. R.* **148**, p. 705, 1909; *Le Radium*, **6**, pp. 225, 352, 1909.

water in an abnormal way, which is represented by the equation



It appears probable that the excess of hydrogen evolved from a radium solution, drawn as observed by Ramsay, is due to a similar action.

A definite comparison of the rate of evolution of gases by the α and β rays has been recently made by Usher*, using the radium emanation as a source of radiation. A known quantity of radium emanation was dissolved in a large quantity of water with no free space above it, and subjected to a pressure of about half an atmosphere. In the course of a month the emanation has decayed to a small fraction of its value. The gases were then pumped out and found to consist mainly of electrolytic gas with an excess of hydrogen, a little carbon dioxide and a trace of nitrogen. He deduced that the amount of gas produced by the decomposition of the emanation from one gram of radium was equal to 136.7 c.c. This is due to the combined action of the α and β rays. The corresponding amount for β rays was 6.49 c.c. The relative efficiency of the α and β rays from emanation in decomposing water is thus about 20 to 1. The energy required to produce the amount of gas observed is less than 3 per cent. of the total energy of the α radiation determined by its heating effect (Chapter XVII).

There appears to be no doubt that the marked chemical action of the α and β rays is connected with the ionisation they produce in all kinds of matter. The total number of ions produced in air by the complete absorption of the α rays from one gram of radium or from the emanation in equilibrium with it can be deduced from the tables given in Sections 67 and 70. If each pair of ions formed is responsible for the production of one molecule of gas, it can be calculated that the emanation from one gram of radium during its radio-active life should produce about 363 c.c. of gas. This is about three times the amount observed experimentally by Usher, but is of the same order of magnitude. There appears to be no doubt that the dissociation of matter by the radiations

* Usher, *Jahrb. d. Radiokt.* 8, p. 323, 1911.

is connected with the ionisation that must be produced in all matter by the action of the radiations. In the case of water, it appears probable that the ionisation of the molecule of water is accompanied by the chemical dissociation of the molecule or of its components.

We have already referred to this matter in Section 22, and have pointed out that it is difficult to decide whether this chemical dissociation is a direct effect of the radiations or a secondary effect brought about by the process of ionisation. The marked colouration in pleochroic halos (Section 112) near the end of the range of the α particles from radium C indicates that the chemical action is most intense where the ionisation is strongest. Apart from the greater ionisation, it is not improbable that the α particle may be relatively far more effective in producing dissociation when its velocity has fallen to a fraction of its initial value.

The mixed gases obtained from radium solutions or from the action of the radium emanation on water always contain a small quantity of helium. This important result is discussed in detail in Chapter XVII.

116. Attempts to transform matter by the radiations.

We have seen that the radiations from active matter produce a marked dissociation of complex molecules through which they pass. In addition to hydrogen and oxygen, radium and the radium emanation in solution in water always give rise to small quantities of helium. As we have already seen in Section 62, the α particles from radio-active matter consist of helium, and the helium observed is due entirely to the α particles absorbed in the solution. Since there are strong reasons for supposing that the radiations from active matter actually penetrate the atoms in their path, it seems not impossible that the radiations might themselves cause a disintegration of some of the atoms of matter which they traverse. In consequence of the great energy associated with the α particles expelled from active matter, it is to be expected that the α rays would be most effective.

A brief statement will be given of a number of experiments made by Cameron and Ramsay* in order to test whether ordinary

* Cameron and Ramsay, *Journ. Chem. Soc.* **91**, p. 1593, 1907; **93**, pp. 966, 992, 1908.

matter can be transformed by the radiations. The question is a difficult one on account of the smallness of the effects to be expected. Several positive results have been published; but these have not stood the test of more rigorous and careful examination. Ramsay and Cameron first investigated the action of the radium emanation on water. For this purpose, a large quantity of the emanation was added to a small bulb partly filled with pure water. In this case part of the emanation was absorbed in the water and part remained in the gases formed above it. They concluded that not only did the emanation produce helium but also neon and a small trace of argon. The experiment was repeated by Rutherford and Royds* who found evidence only of helium. The neon and argon observed in the experiment of Cameron and Ramsay were undoubtedly derived from the small quantity of air which admittedly leaked into the apparatus. Neon is so sensitive spectroscopically that by suitable methods its presence in 1/10 c.c. of air can be easily observed. Cameron and Ramsay also observed that the radium emanation added to a solution of salts of copper gave rise to small quantities of sodium, potassium, and lithium, and concluded that lithium was produced by the transformation of copper. The experiments were carefully repeated by Mme Curie and Mlle Gleditsch†, who were unable to confirm the results. The experiments are difficult since traces of lithium are ordinarily present in many substances. They found, for example, that when pure water had rested for some time in a glass vessel and then evaporated, a small residue was obtained consisting chiefly of sodium, but also containing a small quantity of lithium. Similar results were observed with quartz. To avoid these difficulties, experiments were carried out in platinum vessels, and in this case the presence of lithium could not be observed.

The question was attacked in another way by Mlle Gleditsch‡ and McCoy§ by determining the amount of lithium in radio-active minerals containing copper. If copper was transformed into lithium by the radiation, it would be expected that there would be some

* Rutherford and Royds, *Phil. Mag.* **16**, p. 812, 1908.

† M. Curie and Mlle Gleditsch, *C. R.* **147**, p. 345, 1908.

‡ Gleditsch, *C. R.* **145**, p. 1148, 1907; **146**, p. 331, 1908.

§ McCoy, *Nature*, **77**, p. 79, 1907.

relation between the proportions of copper, radium and lithium in the various minerals of about the same age, but no evidence was obtained of any such relation. Ramsay and Usher*, later, stated that carbon dioxide was produced by the radium emanation in solutions of thorium and zirconium. It is well known that the emanation gives rise to the carbon dioxide when any organic matter is present, and it is very difficult to prove that carbon dioxide is derived from the atomic transformation of thorium and zirconium.

The question attacked by Cameron and Ramsay is of great importance, but there is, so far, no good evidence that the ordinary inactive chemical elements can be transformed by the radiations from active matter. On the other hand, there is indubitable evidence that atomic transformations spontaneously occur in the radio-active elements themselves.

Physical Actions.

117. Electric effects. The rays from active matter have the same effect as ultra violet light and X rays in increasing the facility with which a spark passes between electrodes. Elster and Geitel† showed that if two electrodes were separated by a distance such that the spark just refused to pass, on bringing up a specimen of radium the spark at once passes. This effect is best shown with short sparks from a small induction coil. The Curies have observed that radium completely enveloped by a lead screen 1 cm. thick produces a similar action. The effect in that case is due to the γ rays alone. This action of the rays can be very simply illustrated by connecting two spark-gaps with the induction coil in parallel. The spark-gap of one circuit is adjusted so that the discharge just refuses to pass across it, but passes by the other. When some radium is brought near the silent spark-gap, the spark at once passes and ceases in the other.

Willows and Peck‡ found that under some conditions, especially

* Ramsay and Usher, *Chem. News*, **100**, p. 209, 1909; see also Ramsay, *C. R.* **153**, p. 373, 1911.

† Elster and Geitel, *Ann. d. Phys.* **69**, p. 673, 1899.

‡ Willows and Peck, *Phil. Mag.* **9**, p. 378, 1905.

for long sparks, the rays from radium hindered the passage of the spark.

Hemptinne* found that the electrodeless discharge in a vacuum tube began at a higher pressure when a strong preparation of radium was brought near the tube. In one experiment the discharge without the rays began at 51 mms. but with the radium rays at 68 mms. The colour of the discharge was also altered.

Himstedt† found that the resistance of selenium was diminished by the action of radium rays in the same way as by ordinary light.

F. Henning‡ examined the electrical resistance of a barium chloride solution containing radium of activity 1000, but could observe no appreciable difference between it and a similar pure solution of barium chloride. This experiment shows that the action of the rays from the radium does not produce any appreciable change in the conductivity of the barium solution.

Kohlrausch and Henning§ have made a detailed examination of the conductivity of pure radium bromide solutions, and have obtained results very similar to those for the corresponding barium solutions. Kohlrausch|| found that the conductivity of water exposed to the radiations from radium increased more rapidly than water which had not been exposed. This increase of conductivity may have been due to an increase of the conductivity of water itself or to an increased rate of solution of the glass of the containing vessel.

When the air space between plates of two different metals is ionised by the radiations, the plates rapidly acquire the contact difference of potential. This action of the radiations affords a very convenient and simple method of determining the contact difference of potential between metals.

Specimens of active material have been employed to obtain the potential at any point of the atmosphere. The ionisation due to the active substance is so intense that the insulated conductor

* Hemptinne, *C. R.* **133**, p. 934, 1901.

† Himstedt, *Phys. Zeit.* **1**, p. 476, 1900.

‡ Henning, *Ann. d. Phys.* **7**, p. 562, 1902.

§ Kohlrausch and Henning, *Verh. d. D. Phys. Ges.* **6**, p. 144, 1904.

|| Kohlrausch, *Verh. d. D. Phys. Ges.* **5**, p. 261, 1903.

to which it is attached rapidly takes up the potential of the air surrounding the active substance. In this respect, it is more convenient and rapid in its action than the ordinary taper or water dropper. Henning* found that a radium collector did not give the same potential as the water dropper, and concluded that this was due to the accumulation of ions near the conductor. A similar conclusion was reached by Linke†. On the other hand, Moulin‡ found that if the radium collector is exposed in free air and exposed to the wind, measurements may be made without sensible error. Moulin employed the sulphate of radio-active barium protected by varnish as a source of ionisation. Simpson and Wright§ employed a preparation of ionium for the purpose. This substance has the advantage of emitting only α rays of short range, so that the ionisation extends only a short distance from the collector.

118. Effect on liquid and solid dielectrics. P. Curie|| made the very important observation that liquid dielectrics became partial conductors under the influence of radium rays. In these experiments the radium, contained in a glass tube, was placed in an inner thin cylinder of copper. This was surrounded by a concentric copper cylinder, and the liquid to be examined filled the space between. A strong electric field was applied, and the current through the liquid measured by means of an electrometer.

The following numbers illustrate the results obtained :

Substance	Conductivity in mhos per 1 cm. ³
Carbon bisulphide ...	20×10^{-14}
Petroleum ether ...	15 "
Amyl alcohol ...	14 "
Carbon tetrachloride	8 "
Benzene	4 "
Liquid air	1·3 "
Vaseline oil	1·6 "

* Henning, *Ann. d. Phys.* **7**, p. 893, 1902.

† Linke, *Phys. Zeit.* **4**, p. 661, 1903.

‡ Moulin, *Le Radium*, **4**, p. 6, 1907.

§ Simpson and Wright, *Proc. Roy. Soc. A*, **85**, p. 175, 1911.

|| P. Curie, *C. R.* **134**, p. 420, 1902.

Liquid air, vaseline oil, petroleum ether, amyl alcohol, are normally nearly perfect insulators. The conductivity of amyl alcohol and petroleum ether due to the rays at -17°C . was only $1/10$ of its value at 0°C . There is thus a marked action of temperature on the conductivity. For very active material the current was proportional to the voltage for small voltages. With material of only $1/500$ of the activity, it was found that Ohm's law was not obeyed.

The following numbers were obtained :

Volts	Current
50	109
100	185
200	255
400	335

For an increase of voltage of 8 times, the current only increases about 3 times. The current in the liquid thus tends to become "saturated" as does the ordinary ionisation current through a gas. These results have an important bearing on the ionisation theory, and show that the radiation probably produces ions in the liquid as well as in the gas. X rays were found to produce a similar effect to radium rays.

The conductivity of liquid and solid dielectrics has been examined in detail by a number of investigators, who have obtained results of a similar character. The conductivity has been found to depend greatly on the purity of the material, so that special precautions are necessary to purify the substances as carefully as possible. In the case of liquids, all observers have found that the current increases at first nearly proportionally with the voltage and then more slowly as the potential difference is increased. Jaffé* concluded that the current through a liquid consisted of two parts, one of which increased with the voltage v according to Ohm's law, and the other of which tended to reach a maximum or saturation value.

The current i through the liquid is thus expressed by a relation of the form $i = \kappa v + f(v)$. In the case of purified petroleum ether, the part of the current represented by $f(v)$ reached a saturation

* Jaffé, *Journ. d. Phys.* **4**, p. 263, 1906; *Ann. d. Phys.* **25**, p. 227, 1908; **28**, p. 326, 1909.

value for a field of about 900 volts per cm. The value of i depends on the intensity of the radiations and also on the distance between the plates. In later experiments, Jaffé has carefully examined the nature of the conductivity shown by pure hexane under various conditions. Cacilia Bohm-Wendt and E. v. Schweidler* examined the conductivity of petroleum ether and vaseline oil under radium rays and estimated the mobility of the ions.

Bialobjesky† examined the conductivity of a number of liquid hydrocarbons which had been specially purified and deduced the mobility of the ions.

H. Becquerel‡ and A. Becker§ showed that the conductivity of solid dielectrics was increased by exposure to radium rays. Greinacher|| tested whether the conductivity of thin plates of solid dielectric was altered by exposure to the α rays from polonium but with negative results.

119. Motion of radium in an electric field. Joly¶ found that a disc, one side of which is coated with a few milligrams of radium bromide, exhibits, when an electrified body is brought near it, motions very different to those observed in the case of an inactive substance. The electrified body, whether positive or negative, repels the suspended body if brought up to it on the side coated with radium, but attracts it if presented to the naked side.

This effect is very simply shown by constructing a small apparatus like a radiometer. Two cover glasses are attached to the end of a glass fibre about 6 cms. long, the surfaces lying in the same plane. The apparatus is free to rotate on a pivot. The two vanes are coated on alternate faces with radium bromide, and the whole apparatus enclosed within a glass receiver. If an electrified rod of ebonite or sealing wax is brought up close to the receiver, a rotation is communicated to the vane which

* Bohm-Wendt and v. Schweidler, *Phys. Zeit.* **10**, p. 326, 1909.

† Bialobjesky, *Le Radium*, **7**, pp. 48, 76, 1910; **8**, p. 293, 1911; *C. R.* **149**, p. 279, 1909.

‡ H. Becquerel, *C. R.* **136**, p. 1173, 1903.

§ A. Becker, *Ann. d. Phys.* **12**, p. 125, 1903.

|| Greinacher, *Phys. Zeit.* **10**, p. 986, 1909; *Le Radium*, **6**, p. 219, 1909.

¶ Joly, *Phil. Mag.* **7**, p. 303, 1904.

increases as the pressure of the air is lowered to 5 or 6 cms. of mercury. By placing the apparatus between parallel plates connected with the terminals of a Wimshurst machine, a steady rotation is communicated to the vanes. The rotation is always in such a direction that the radium coated surface is repelled from the electrified body.

This action was examined still further by attaching the vanes to the glass beam of a Coulomb's balance. A metal sphere, which could be charged from without, was fixed facing the side coated with radium. A repulsion was always observed except when the charge was very strong and the vane near the sphere. If, however, the two vanes were connected by a light wire and a similar sphere placed exactly opposite the other, an attraction was observed if one sphere was charged, but a repulsion if both were charged. These effects were observed whether the vanes were of aluminium or glass.

Joly found that the effect could not be explained by any direct action due to the movement of the ions in an electric field. The recoil, due to the expulsion of α particles from one side of the vane, is far too small to account for the movement observed.

There appears to be no doubt that the movement observed is a result of the inequality of the ionisation on the two sides of the vane. This leads to a disturbance of the potential gradient and the vane is moved by the electric forces brought into play.

Some physiological actions.

120. Walkhoff first observed that radium rays produce burns of much the same character as those caused by Röntgen rays. Experiments in this direction have been made by Giesel, Curie and Becquerel, and others, with very similar results. There is at first a painful irritation, then inflammation sets in, which lasts from 10 to 20 days. This effect is produced by all preparations of radium, and appears to be due mainly to the α and β rays.

Care has to be taken in handling radium on account of the painful inflammation set up by the rays. If a finger is held for some minutes at the base of a capsule containing a radium preparation, the skin becomes inflamed for about 15 days and

then peels off. The painful feeling does not disappear for two months.

Another interesting action of the radium rays has been observed by Giesel. On bringing up a radium preparation to the closed eye, in a dark room, a sensation of diffuse light is observed. This effect has been examined by Himstedt and Nagel* who have shown that it is due to a fluorescence produced by the rays in the eye itself. The blind are able to perceive this luminosity if the retina is intact, but not if the retina is diseased. Hardy and Anderson† have examined this effect in some detail. The sensation of light is produced both by the β and γ rays. The eyelid practically absorbs all the β rays, so that the luminosity observed with a closed eye is due to the γ rays alone. The lens and retina of the eye are strongly phosphorescent under the action of the β and γ rays. Hardy and Anderson consider that the luminosity observed in a dark room with the open eye (the phosphorescent light of the radium itself being stopped by black paper) is to a large extent due to the phosphorescence set up in the eyeball. The γ rays, for the most part, produce the sensation of light when they strike the retina.

It would be out of place here to give an account of the very numerous investigations that have been made by physicists and physiologists on the effects of the rays of radium and of other active substances on different organisms. The use of radium rays has been found beneficial in certain diseases and "Radium Institutes" have been founded in several countries for therapeutic purposes.

* Himstedt and Nagel, *Ann. d. Phys.* **4**, p. 537, 1901.

† Hardy and Anderson, *Proc. Roy. Soc. A*, **72**, p. 393, 1903.

CHAPTER VIII.

CONTINUOUS PRODUCTION AND DECAY OF RADIO-ACTIVE MATTER.

121. Introduction. The earlier experiments with uranium and thorium had indicated that their activity was spontaneous and permanent, for no appreciable change in the intensity of the radiations emitted could be detected over a period of several years. This apparent permanency was further emphasised by the discovery of radium, for notwithstanding its enormous activity, this substance showed no appreciable decrease of activity with time. It was at first thought that the activity of polonium was also constant, and it was not till some years after its discovery that it was found to lose the greater part of its activity in the course of a year. On the other hand, in 1899 and 1900 a number of new facts were brought to light which indicated that some radio-active substances lost the greater part of their activity in the course of a few minutes or hours. For example, it was found that thorium emitted a radio-active gas or emanation which lost half of its activity in less than one minute. Substances exposed in the neighbourhood of an uncovered radium or thorium compound were found to acquire radio-active properties. For example, a metal plate exposed in the neighbourhood of thorium oxide for some hours was found to show considerable activity. The radiations of this plate were not permanent but decayed according to a definite law with the time, the activity falling to half value in about eleven hours, and practically disappearing in the course of a week. In a similar way, plates exposed in the presence of radium acquired temporary activity which disappeared in the course of a few hours. The evidence indicated that an invisible

film of radio-active matter had been deposited on the plates. This phenomenon was at first included under the name of "excited" or "induced" radio-activity. A full discussion of the properties of the emanations and of the activity produced by them is given in the following chapters.

It thus seemed clear that in addition to the more permanent radio-active elements, other active substances were present, which retained their activity for only a limited time. While it was recognised that this ephemeral activity was to be ascribed to the presence of minute quantities of radio-active matter, the full significance of such phenomena was not grasped until the year 1902.

We shall now consider some experiments which threw a flood of light on radio-active processes, and led to the development of a general theory in explanation of radio-active phenomena. At this stage, we shall confine ourselves to a consideration of a few experiments made with uranium and thorium, although it will be shown later that similar effects are exhibited by all the radio-active substances. In this respect, we shall be following the historical order of development, for it was from a consideration of the experimental results described in this chapter that the theory of the transformation of radio-active matter was initially put forward.

122. Uranium X. The initial experiments of Mme Curie had shown that the radio-activity of uranium is an atomic phenomenon, for the activity of any uranium compound depends only on the amount of that element present, and is unaffected by its chemical combination with other inactive elements. Since the activity of uranium is a specific property of that element, it did not appear probable that the activity could be diminished by chemical or physical agencies.

In 1900, however, Sir William Crookes* showed that, by a single chemical operation, uranium could be obtained photographically inactive while the whole of the activity could be concentrated in a small residue free from uranium. This residue, to which he

* Crookes, *Proc. Roy. Soc. A*, 66, p. 409, 1900.

gave the name of uranium X, was many hundred times more active photographically, weight for weight, than the uranium from which it had been separated. The method employed for this separation was to precipitate a solution of the uranium with ammonium carbonate. On dissolving the precipitate in an excess of the reagent, an insoluble residue remained behind. This was filtered off, and constituted the Ur X. The active substance Ur X was probably present in very small quantity, mixed with impurities derived from the uranium. No new lines were observed in its spectrum. A partial separation of the activity of uranium was also effected by another method. Crystallized uranium nitrate was dissolved in ether, and the uranium divided itself between the ether and water present in two unequal fractions. The small part dissolved in the water layer was found to contain practically all the activity when examined by the photographic method, while the other fraction was almost inactive. These results, taken by themselves, pointed very strongly to the conclusion that the activity of uranium was not due to the element itself, but to some other substance, associated with it, which had distinct chemical properties.

Results of a similar character were obtained later by Becquerel*. It was found that barium could be made photographically very active by adding barium chloride to a uranium solution and precipitating the barium as sulphate. By a succession of precipitations the uranium was rendered photographically almost inactive, while the barium was strongly active.

The inactive uranium and the active barium were laid aside; but, on examining them a year later, it was found *that the uranium had completely regained its activity, while the activity of the barium sulphate had completely disappeared.* The loss of activity of uranium was thus only temporary in character.

In the above experiments, the activity of uranium was examined by the photographic method. The photographic action produced by uranium under ordinary experimental conditions is due almost entirely to the β rays. The α rays, in comparison, have little if any effect. Now the radiation from Ur X consists entirely

* Becquerel, *C. R.* **131**, p. 137, 1900; **133**, p. 977, 1901.

of β rays, and is consequently photographically very active. If the activity of uranium had been measured electrically without any screen over it, the current observed would have been due very largely to the α rays, and little change would have been

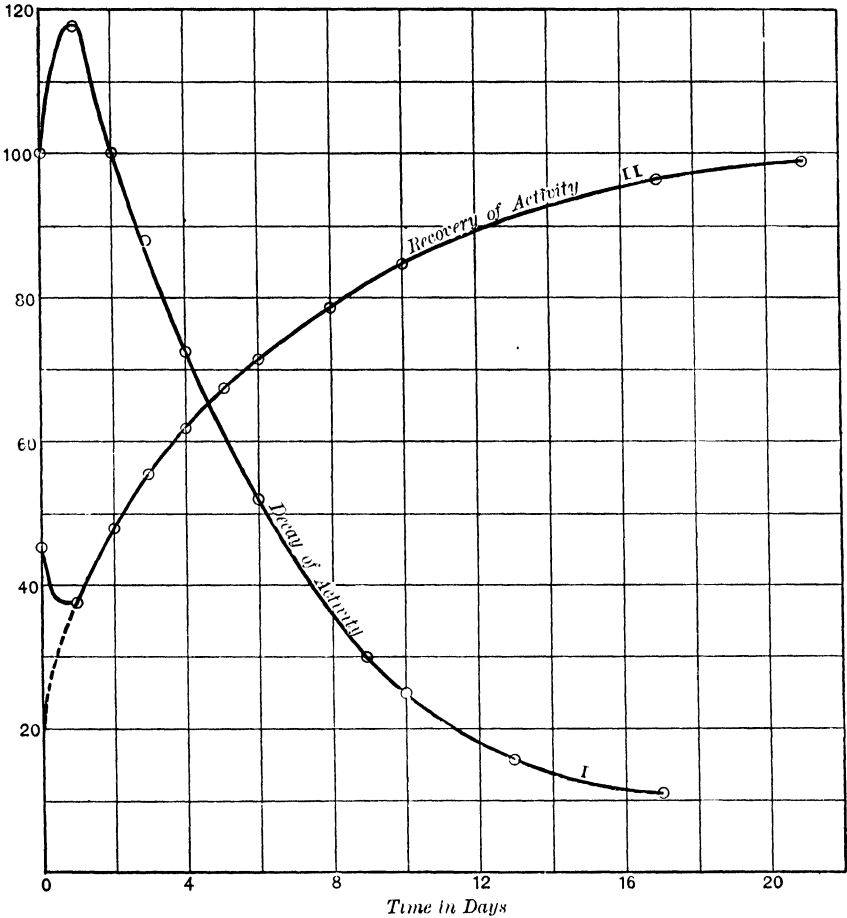

Fig. 84.

observed after the removal of Ur X, since only the constituent responsible for the β rays was removed.

123. Thorium X. Rutherford and Soddy*, working with thorium compounds, found that an intensely active constituent

* Rutherford and Soddy, *Phil. Mag.* 4, pp. 370, 569, 1902; *Trans. Chem. Soc.* 81, pp. 321 and 837, 1902.

could be separated from thorium by a single chemical operation. If ammonia is added to a thorium solution, the thorium is precipitated, but a large amount of the activity is left behind in the filtrate, which is chemically free from thorium. This filtrate was evaporated to dryness, and the ammonium salts driven off by ignition. A small residue was obtained which, weight for weight, was in some cases several thousand times more active than the thorium from which it was obtained, while the activity of the precipitated thorium was reduced to less than one half of its original value. This active constituent was named Th X from analogy to Crookes' Ur X.

The active residue was found to consist mainly of impurities from the thorium; the Th X could not be examined chemically, and undoubtedly was present only in minute quantity. It was also found that an active constituent could be partly separated from thorium oxide by shaking it with water for some time. On filtering the water, and evaporating, a very active residue was obtained which was analogous in all respects to Th X.

On examining the products a month later, it was found that the *Th X was no longer active, while the thorium had completely regained its activity.* A long series of measurements was then undertaken to examine the time-rate of these processes of decay and recovery of activity.

The results are shown graphically in Fig. 84, where the final activity of the thorium and the initial activity of the Th X are in each case taken as 100. The ordinates represent the activities determined by means of the ionisation current, and the abscissae represent the time in days. It will be observed that both curves are irregular for the first two days. The activity of the Th X increased at first, while the activity of the thorium diminished. Disregarding these initial irregularities of the curves, which will be explained later, it will be seen that, after the first two days, the time taken for the thorium to recover half its lost activity is about equal to the time taken by the Th X to lose half its activity. This time in each case is about four days. The percentage proportion of the activity regained by the thorium, over any given interval, is approximately equal to the percentage proportion of the activity lost by the Th X during the same interval.

If the recovery curve is produced backwards to meet the vertical axis, it does so at a minimum of 25 per cent., and the above conclusions hold more accurately, if the recovery is assumed to start from this minimum. This is clearly shown by Fig. 85, where the percentages of activity recovered, reckoned from the 25 per cent. minimum, are plotted as ordinates. In the same figure the decay curve, after the second day, is shown on the same scale. The activity of the Th X decays with the time

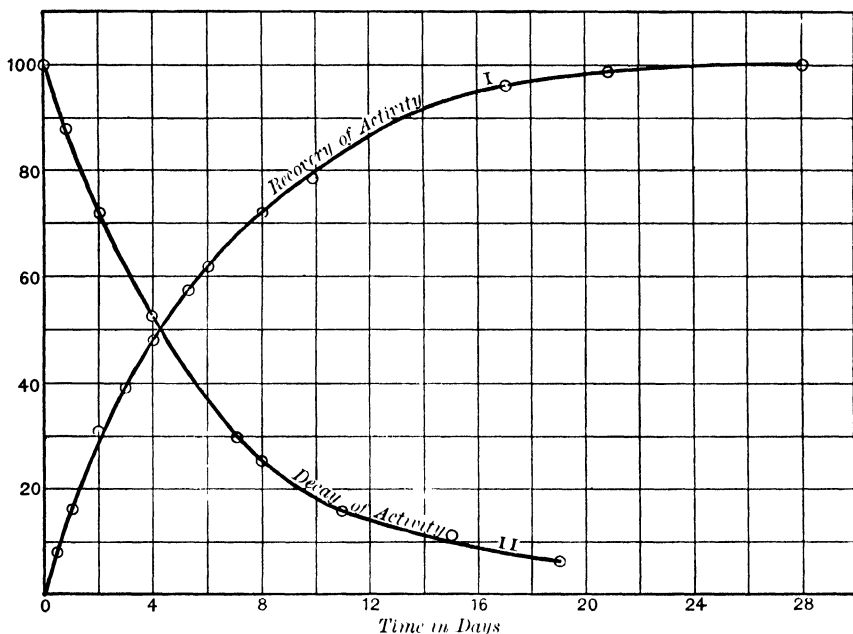

Fig. 85.

according to an exponential law, falling to half value in about four days. If I_0 is the initial activity and I_t is the activity after a time t , then

$$I_t/I_0 = e^{-\lambda t},$$

where λ is a constant and e the natural base of logarithms. The experimental curve of the rise of activity from the minimum to the maximum value is therefore expressed by the equation

$$\frac{I_t}{I_0} = 1 - e^{-\lambda t},$$

where I_0 is the amount of activity recovered when the state of constant activity is reached, I_t the activity recovered after a time t , and λ is the *same constant* as before.

Decay and rise of Uranium X. Similar results were obtained when uranium was examined. The Ur X was separated by Becquerel's method of successive precipitations with barium. The decay of the separated activity and the recovery of the lost activity are shown graphically in Fig. 86.

The curves of decay and recovery exhibit the same peculiarities and can be expressed by the same equations as in the case of

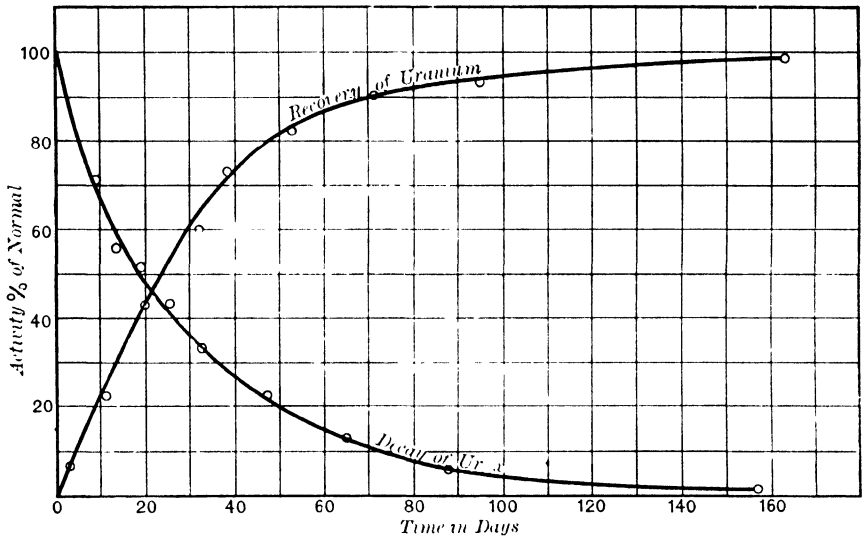

Fig. 86.

thorium. The time-rate of decay and recovery is, however, much slower than for thorium, the activity of the Ur X falling to half its value in about 22 days.

A large number of results of a similar character have been obtained with other radio-active products, separated from the radio-elements, but the cases of thorium and uranium will suffice for the present to form a basis for the discussion of the processes that are taking place in radio-active bodies.

124. Theory of the phenomena. These processes of decay and recovery go on at exactly the same rate if the substances are

removed from the neighbourhood of one another, or enclosed in lead, or placed in a vacuum tube. It is at first sight a remarkable phenomenon that the processes of decay and recovery should be so intimately connected, although there is no possibility of mutual interaction between them. These results, however, receive a general explanation on the following hypotheses :

- (1) That there is a constant production of fresh radio-active matter by the radio-active body ;
- (2) That the activity of the matter so formed decreases according to an exponential law with the time from the moment of its formation.

Suppose that q_0 particles of new matter are produced per second from a given mass of matter. The rate of emission of energy due to the particles produced in the time dt , is, at the moment of their formation, equal to Kq_0dt , where K is a constant.

It is required to find the activity due to the whole matter produced after the process has continued for a time T .

The activity dI , due to the matter produced during the time dt at the time t , decays according to an exponential law during the time $T-t$ that elapses before its activity is estimated, and in consequence is given by

$$dI = Kq_0e^{-\lambda(T-t)} dt,$$

where λ is the constant of decay of activity of the active matter. The activity I_T due to the whole matter produced in the time T is thus given by

$$\begin{aligned} I_T &= \int_0^T Kq_0e^{-\lambda(T-t)} dt \\ &= \frac{Kq_0}{\lambda} (1 - e^{-\lambda T}). \end{aligned}$$

The activity reaches a maximum value I_0 when T is very great, and is then given by

$$I_0 = \frac{Kq_0}{\lambda};$$

thus

$$\frac{I_T}{I_0} = 1 - e^{-\lambda T}.$$

This equation agrees with the experimental results for the recovery of lost activity. Another method for obtaining this equation is given later in Section 126.

A state of equilibrium is reached when the rate of loss of activity of the matter already produced is balanced by the activity supplied by the production of new active matter. According to this view, the radio-active bodies are undergoing change, but the activity remains constant owing to the action of two opposing processes. Now, if this active matter can at any time be separated from the substance in which it is produced, the decay of its activity, as a whole, should follow an exponential law with the time, since each portion of the matter decreases in activity according to an exponential law with the time, whatever its age may be. If I_0 is the initial activity of the separated product, the activity I_t after an interval t is given by

$$\frac{I_t}{I_0} = e^{-\lambda t}.$$

Thus, the two assumptions—of uniform production of active matter and of the decay of its activity according to an exponential law from the moment of its formation—satisfactorily explain the relation between the curves of decay and recovery of activity.

125. Experimental evidence. It now remains to consider further experimental evidence in support of these hypotheses. The primary conception is that the radio-active bodies are able to produce from themselves matter of chemical properties different from those of the parent substance, and that this process goes on at a constant rate. This new matter possesses the property of activity, and loses it according to a definite law.

The constant rate of production of new active matter by thorium was not difficult to verify experimentally. The thorium was first completely deprived of thorium X by successive precipitations with ammonia. It was then set aside and the new thorium X formed in a definite interval was again separated and its amount measured by its radio-activity. The amount I_t formed in an interval t was found to be in fair agreement with that to be expected on the theory, viz. $I_t/I_0 = 1 - e^{-\lambda t}$ or λt when the interval was short. The thorium nitrate which had been freed from

Th X was allowed to stand for one month, and was again subjected to the same process. The amount of Th X was found to be equal in amount to that obtained from an equal weight of the original thorium nitrate. In one month, therefore, the Th X had been regenerated, and had again reached a limiting maximum value*.

Over the interval examined, the results showed that Th X was continuously produced from the thorium compound at a constant rate. It will be seen later that the amount of Th X derived from one gram of thorium is exceedingly minute; but the electrical effects due to its radiations are so large that the process of production can be followed after very short intervals.

At the time at which these experiments were made there was a tendency to explain the temporary activity of substances on the principle of "radio-active induction." It was supposed, for example, that the mere process of mixture of an active substance with inactive matter conferred on the latter the property of radio-activity. On this view, the activity in the thorium filtrate, which we have ascribed to thorium X, might be due to an "induction" effect on the solution itself. If this be the case, however, it is to be expected that any re-agent capable of removing the thorium completely from the solution should yield active residues similar to those obtained from ammonia. This was however disproved by experiment; for example, when thorium nitrate is precipitated by sodium or ammonium carbonate, the residue from the filtrate after evaporation and ignition is practically free from activity, while the precipitated thorium carbonate retains the normal amount. We shall see later (Chapter XVI) that several re-agents besides ammonia have been found capable of separating Th X from a thorium solution. It has been shown that thorium and uranium behave quite differently with regard to the action of ammonia and ammonium carbonate. Uranium X is completely precipitated with the uranium in an ammonia solution, and the

* If thorium X were supplied at a constant rate, this process of production and separation of Th X could be continued indefinitely. It will be seen later, however, that another radio-active substance, mesothorium, is separated with the thorium X and that the effect of this is to decrease the rate of supply of thorium X over an interval of several years.

filtrate is inactive. On the other hand, Ur X is separated by ammonium carbonate. Ur X and Th X consequently behave like distinct types of matter with well-marked chemical properties, quite distinct from those of the substances from which they are produced. This point of view is completely borne out by an examination of the numerous distinct products which have been separated from uranium and thorium at later dates. It is not desirable at this stage to discuss the question why such chemical separations are effective even when the substance separated is present in infinitesimal amount. From the chemical point of view, the behaviour of radio-active substances present in extremely small amount is of great interest; for by radio-active methods it is possible to examine the chemical properties of substances present in such minute amount that it would be impossible to detect them by the most sensitive balance or by the spectroscope.

The initial rise of the activity of Th X and the initial decay of the thorium itself shown in Fig. 84 are explained later in Chapter XVI. It suffices to state here that Th X gives rise to the thorium emanation which behaves as a radio-active gas, and that the emanation in turn is transformed into the active deposit of thorium. The initial rise of activity is due to the production of the active deposit in the Th X, the activity of which is added to that of Th X and of the emanation. In a similar way, it will be shown that the active deposit remains behind with the thorium when Th X is separated. It consequently decays *in situ* and this results in an apparent decrease of the activity of the thorium.

126. Rate of decay of activity. It has been shown that the activity of Ur X and Th X decays according to an exponential law with the time. This, we shall see later, is the general law of decay of activity in any type of active matter, obtained by itself, and freed from any secondary active products which it may, itself, produce. In any case, when this law is not fulfilled, it can be shown that the activity is due to the superposition of two or more effects, each of which decays according to an exponential law with the time. The physical interpretation of this law still remains to be explained.

It has been shown that in uranium and thorium compounds

there is a continuous production of active matter which keeps the compound in radio-active equilibrium. The changes by which the active matter is produced must be atomic in nature, since the products are different in chemical properties from the matter in which the changes take place. The activity of the products has afforded the means of following the changes occurring in them. It now remains to consider the connection between the activity at any time, and the amount of radio-active change taking place at that time.

In the first place, it is found experimentally that the saturation ionisation current i_t , after the active product has been allowed to decay for a time t , is given by

$$\frac{i_t}{i_0} = e^{-\lambda t},$$

where i_0 is the initial saturation current and λ the constant of decay.

Now the saturation current is a measure of the total number of ions produced per second in the testing vessel. It has already been shown that the α rays, which produce the greater proportion of ionisation in the gas, consist of positively charged particles projected with great velocity. Suppose for simplicity that each atom of active matter, in the course of its change, gives rise to one projected α particle. Each α particle will produce a certain average number of ions in its path before it strikes the boundaries or is absorbed in the gas. Since the number of projected particles per second is equal to the number of atoms changing per second, the number of atoms n_t which change per second at the time t is given by

$$\frac{n_t}{n_0} = e^{-\lambda t},$$

where n_0 is the initial number which changes per second. On this view, then, the law of decay expresses the result that the number of atoms changing in unit time, diminishes according to an exponential law with the time. The number of atoms N_t which remain *unchanged* after an interval t is given by

$$\begin{aligned} N_t &= \int_t^{\infty} n_t dt \\ &= \frac{n_0}{\lambda} e^{-\lambda t}. \end{aligned}$$

If N_0 is the number of atoms at the beginning,

$$N_0 = \frac{n_0}{\lambda}.$$

Thus
$$\frac{N_t}{N_0} = e^{-\lambda t} \dots \dots \dots (1),$$

or the law of decay expresses the fact that the *activity of a product at any time is proportional to the number of atoms which remain unchanged at that time.*

This is the same as the law of mono-molecular change in chemistry, and expresses the fact that there is only one changing system. If the change depended on the mutual action of two systems, the law of decay would be different, since the rate of decay in that case would depend on the relative concentration of the two reacting substances. This is not so, for not a single case has yet been observed in which the law of decay was affected by the amount of active matter present.

From the above equation (1)

$$\frac{dN_t}{dt} = -\lambda N_t,$$

or the number of systems changing in unit time is proportional to the number unchanged at that time.

In the case of recovery of activity, after an active product has been removed, the number of systems changing in unit time, when radio-active equilibrium is produced, is equal to λN_0 . This must be equal to the number q_0 of new systems supplied in unit time, or

$$q_0 = \lambda N_0,$$

and

$$\lambda = \frac{q_0}{N_0};$$

λ has thus a distinct physical meaning, and may be defined as the proportion of the total number of systems which change per second. It has different values for different types of active matter, but is invariable for any particular type of matter. For this reason, λ will be termed the "*radio-active constant*" of the radio-element.

We are now in a position to discuss with more physical definiteness the gradual growth of Th X in thorium, after the

Th X has been completely removed from it. Let q_0 particles of Th X be produced per second by the thorium, and let N be the number of particles of Th X present at any time t after the original Th X was removed. The number of particles of Th X which change every second is λN , where λ is the radio-active constant of Th X. Now, at any time during the process of recovery, the rate of increase of the number of particles of Th X equals the rate of production, less the rate of change; that is

$$\frac{dN}{dt} = q_0 - \lambda N.$$

The solution of this equation is of the form $N = ae^{-\lambda t} + b$, where a and b are constants.

Now when t is very great, the number of particles of Th X present reach a maximum value N_0 .

Thus, since $N = N_0$ when $t = \infty$,

$$b = N_0;$$

since $N = 0$ when $t = 0$,

$$a + b = 0;$$

hence

$$b = -a = N_0,$$

and the equation becomes

$$\frac{N}{N_0} = 1 - e^{-\lambda t}.$$

This is equivalent to the equation already obtained in Section 123, since the intensity of the radiation is always proportional to the number of atoms present.

127. Influence of conditions on the rate of decay.

Since the activity of any product, at any time, may be taken as a measure of the rate at which radio-active change takes place, it may be used as a means of determining the effect of conditions on the changes occurring in radio-active matter. If the rate of change should be accelerated or retarded, it is to be expected that the value of the radio-active constant λ will be increased or decreased, *i.e.* that the decay curve will be different under different conditions.

No such effect, however, has yet been observed in any case of radio-active change, where none of the active products produced are allowed to escape from the system. The rate of decay is unaltered by any chemical or physical agency, and in this respect the changes in radio-active matter are sharply distinguished from ordinary chemical changes. For example, the decay of activity of any product takes place at the same rate when the substance is exposed to light as when it is kept in the dark, and at the same rate in a vacuum as in air or any other gas at atmospheric pressure. Its rate of decay is unaltered by surrounding the active matter by a thick layer of lead and under conditions where no ordinary radiation from outside can affect it. The activity of the matter is unaffected by ignition or chemical treatment. The material giving rise to the activity can be dissolved in acid and re-obtained by evaporation of the solution without altering the activity. The rate of decay is the same whether the active matter is retained in the solid state or kept in solution. When a product has lost its activity, resolution or heat does not regenerate it, and as we shall see later, the rate of decay of the active products, so far examined, is the same at a red heat as at the temperature of liquid air. In fact, no variation of physical or chemical conditions has led to any observable difference in the decay of activity of any of the numerous types of active matter which have been examined.

The recovery of the activity of a radio-element with time, when an active product is separated from it, is governed by the rate of production of fresh active matter and by the decay of activity of that already produced. Since the rate of decay of the activity of the separated product is independent of conditions, the rate of recovery of activity can be modified only by a change of the rate of production of fresh active matter. As far as experiments have gone, the rate of production, like the rate of decay, is independent of chemical or physical conditions. There are indeed certain cases which are apparent exceptions to this rule. For example, the escape of the radio-active emanations from thorium and radium is readily affected by heat, moisture and solution. A more thorough investigation, however, shows that the exception is only apparent and not real. These cases will be discussed

more in detail in the next chapter, but it may be stated here that the differences observed are due to differences in the rate of escape of the emanations into the surrounding gas, and not to differences in the rate of production.

These observations as well as many others made later show that neither the activity nor its rate of change can be altered by any physical or chemical agency. Since any change in the rate of production of a new substance would involve a change in the rate of decay of the parent substance, it is consequently to be expected that the recovery curve of any active matter should be uninfluenced by conditions provided that no radio-active materials are allowed to escape. All experiments made to detect any such change have so far yielded negative results.

128. Disintegration hypothesis. In the discussion of the changes in radio-active bodies, only the active products U X and Th X have been considered. It will, however, be shown later that these two products are only examples of many other types of active matter, and that each of these products has definite chemical as well as radio-active properties, which distinguish it, not only from the other active products, but also from the substance from which it is produced.

The full investigation of these changes will be shown to verify in every particular the hypothesis that radio-activity is the accompaniment of atomic changes of a special kind occurring in matter, and that the constant activity of the radio-elements is due to an equilibrium process, in which the rate of production of fresh active matter balances the rate of change of that already formed.

The nature of the process taking place in the radio-elements, which gives rise to the production at a constant rate of new kinds of active matter, will now be considered. Since in thorium or uranium compounds there is a continuous production of radio-active matter, which differs in chemical properties from the parent substance, some kind of change must be taking place in the radio-element. This change, by which new matter is produced, is very different in character from the molecular changes dealt with in chemistry, for no chemical change is known which proceeds at the

same rate at the temperatures corresponding to a red heat and to liquid air, and is independent of all physical and chemical actions. If, however, the production of active matter is supposed to be the result of changes, not in the molecule, but in the *atom itself*, it is not to be expected that the temperature would exert much influence. The general experience of chemistry in failing to transform the elements by the action of temperature is itself strong evidence that wide ranges of temperature have not much effect in altering the stability of the chemical atom.

The view that the atoms of the radio-elements are undergoing spontaneous disintegration was put forward by Rutherford and Soddy as a result of evidence of this character. The discovery of the *material* nature of the α rays added strong confirmation to the hypothesis; for it was difficult to explain the expulsion of an atom of matter with great velocity except on the basis of an atomic explosion. In addition, the loss of an α particle from an atom gave an obvious explanation of the change in chemical and physical properties of the new substance which reappeared as the result of the atomic transformation.

Taking the case of uranium as an example, the processes occurring in the atom may be pictured in the following way. The atoms of uranium are not permanently stable systems, but on an average a constant small proportion of them (about one atom in every 10^{18}) becomes unstable and breaks up each second. The atomic explosion is violent, and results in the expulsion from the atom of one, or possibly two, α particles with great velocity. Since the α particle is an atom of helium of atomic weight about 4, the residue of the atom after the expulsion of one α particle has decreased in atomic weight by 4 units. Consequently in addition to the helium atom, a new atom is formed of atomic weight less than that of the parent atom. These new atoms show physical and chemical properties quite distinct from those of uranium, and constitute the new substance, uranium X. The atoms of Ur X are far more unstable than those of uranium itself, for on an average one in 10^7 disintegrates per second. The transformation of Ur X gives rise in turn to a new substance, and the process of transformation continues through a long series of definite stages. The expulsion of α particles from uranium constitutes the radiation

from uranium, while the expulsion of β particles from Ur X constitutes the radiation from that substance. If it be assumed that one α particle or one β particle is expelled as a result of the explosion of each individual atom, the number of α particles or β particles projected per second from radio-active matter is obviously a measure of the number of atoms breaking up per second. It will be shown later that a process of transformation, very similar to that described for uranium, must be supposed to take place in thorium, radium and actinium. A full discussion of the transformation products of these substances is given in later Chapters.

In this chapter, the evidence of production and transformation of active matter has been based on measurements of activity. The actual amount of matter involved was in most cases far too small to detect by ordinary chemical methods. From the considerations advanced in Chapter XVI, it will be seen that the weight of the equilibrium amount of Th X, which can be separated from one gram of thorium, is about 7×10^{-13} gr. Notwithstanding the minuteness of the amount of matter involved, the Th X from one gram of thorium gives an inconveniently large electrical effect for measurement with an electroscope. The detection of small amounts of matter by their activity is extraordinarily delicate, and far surpasses in sensitiveness the balance or the spectroscope.

It will be seen later, however, that in some cases a sufficient amount of matter has been obtained to examine the correctness of this hypothesis by direct chemical methods. For example, the radium atom is transformed with the emission of an α particle into the atom of a gaseous substance, the radium emanation. A sufficient quantity of this emanation has been collected to isolate it by chemical methods and to examine its physical and chemical properties. It has been shown to be a new element with a characteristic spectrum, and well marked and distinctive physical and chemical properties. It is, however, not a permanent but a transition element, for it has practically all disappeared a month after its separation.

CHAPTER IX.

RADIO-ACTIVE GASES.

129. Introduction. In this and the following chapter, an account will be given of the general properties of the radio-active emanations and the active matter derived from them. These types of active matter, which show only a temporary activity, have been studied in more detail than many of the other radio-active substances. They exhibit a number of interesting general properties which can be most conveniently considered at this stage. The existence of radio-active matter in the gaseous state has proved of great utility in throwing light on radio-active processes, and affords a simple method of studying a number of radio-active substances quite apart from the active matter from which they arise. A most important and striking property possessed by radium, thorium, and actinium, but not by uranium, ionium or polonium, is the power of continuously emitting into the surrounding space a material emanation, which has all the properties of a radio-active gas. Each of these emanations is able to diffuse rapidly through gases and through porous substances, and may be separated from the gas with which it is mixed by condensation at a very low temperature. These emanations form the connecting link between the radio-elements themselves and their power of imparting activity to surrounding objects. The emanations from the three active bodies all possess similar radio-active properties, but the effects are most marked in the case of the radium emanation, on account of its relatively slow rate of decay.

The radium emanation has proved of great practical importance as a means of readily obtaining an intense source of radiation concentrated in a very small volume.

130. Discovery of the emanations. In the course of examination of the radiations of thorium, several observers had noted that some of the thorium compounds, and especially the oxide, were apparently very inconstant sources of radiation, when examined in open vessels by the electrical method. Owens* found that this inconstancy was due to the action of air currents. When a closed vessel was used, the current, immediately after the introduction of the active matter, increased with the time, and finally reached a constant value. By drawing a steady stream of air through the vessel, the value of the ionisation current was much reduced. It was also observed that the radiations could apparently pass through large thicknesses of paper, which completely absorbed the ordinary α radiation.

In an investigation of these peculiar properties of thorium compounds, the writer† found that the effects were due to an emission of radio-active particles of some kind from the thorium compounds. This “emanation,” as it was termed for convenience, possesses the properties of ionising the gas and acting on a photographic plate, and is able to diffuse rapidly through porous substances like paper. The emanation, like a gas, is completely prevented from escaping by covering the active matter with a thin plate of mica. The emanation can be carried away by a current of air; it passes through a plug of cotton-wool and can be bubbled through solutions without appreciable loss of activity. In these respects it behaves very differently from the ions produced in the gas by the rays from active substances, for these give up their charges completely under the same conditions. Special experiments showed that the emanation could not consist of particles of dust given off by the radio-active matter but appeared to be a type of gaseous or volatile radio-active matter.

Although the emanation from thorium is given off in minute

* Owens, *Phil. Mag.* **48**, p. 360, 1899.

† Rutherford, *Phil. Mag.* **49**, p. 1, 1900.

quantity, its ionisation effects are sufficiently large to be readily measured by means of an electrometer or electrometer.

For an examination of the emanation, an apparatus similar in principle to that shown in Fig 87 was employed.

The thorium compound, either bare or enclosed in a paper envelope, was placed in a glass tube *C*. A current of air from a gasometer, after passing through a tube containing cotton-wool to remove dust particles, bubbled through sulphuric acid in the vessel *A*. It then passed through a bulb containing tightly packed cotton-wool to prevent any spray being carried over. The emanation, mixed with air was carried from the vessel *C* through a plug of cotton-wool *D*, which removed completely all the ions carried with the emanation. The gas then passed into a long brass cylinder, which was insulated and charged to a suitable potential by means of a battery of accumulators. Three insulated electrodes, *E*, *F*, *H*,

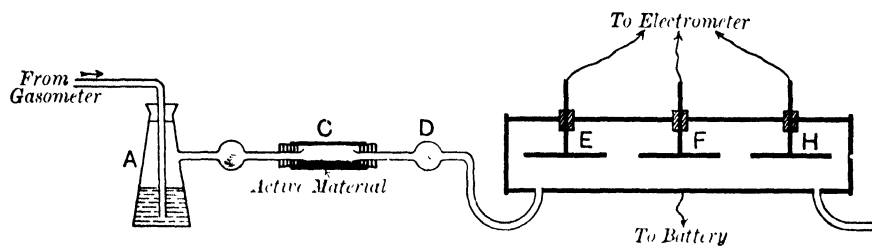

Fig. 87.

of equal lengths, were placed along the axis of the cylinder, supported by brass rods passing through ebonite plugs in the side of the cylinder. The current through the gas, due to the presence of the emanation, was measured by means of an electrometer. An insulating key was arranged so that any one of the electrodes *E*, *F*, *H* could be rapidly connected with one pair of quadrants of the electrometer, the other two electrodes being always connected with earth. The current observed in the testing cylinder was due entirely to the ions produced by the radiation from the emanation carried into the vessel by the current of air. On substituting a uranium compound for the thorium, not the slightest current was observed. After a constant flow has passed for about 10 minutes, the current due to the emanation reached a nearly constant value.

The variation of the current with the voltage was similar to that observed for a gas ionised by the direct radiations from the active bodies. The current at first increased with the voltage, but finally reached a maximum.

The emanation from thorium rapidly loses its activity with time. This is very readily shown with the apparatus of Fig. 87. When the emanation is conveyed with a current of air along the cylinder, the ionisation current is found to diminish progressively along the cylinder, and the variation from electrode to electrode depends on the velocity of the flow of air. Another convenient method of determining the rate of decay is to stop the flow of air and close the openings of the cylinder. The decrease of the saturation current with time is then a measure of the decay of activity of the emanation.

Shortly after the discovery of the thorium emanation, Dorn* showed that radium also gave off an emanation. The amount of emanation was small at ordinary temperatures but was much increased when the radium compound was heated. The emanation behaved similarly to that of thorium but lost its activity far more slowly.

We have referred in Section 7 to the discovery by Giesel of an emanation of very short life given out by the substance now known as actinium, and of the striking way in which its presence can be shown with the aid of a zinc sulphide screen.

131. Decay of the emanations. Each of these emanations loses its activity according to an exponential law with the time. From the point of view developed in the last chapter, the emanations are to be regarded as active substances in the gaseous state. If N_0 be the initial number of atoms present and N the number remaining after an interval t , then the exponential law of decay is expressed by $N/N_0 = e^{-\lambda t}$ where λ is the radio-active constant.

It is convenient to express the decay in terms of the half value period, *i.e.* the interval required for the activity or number of atoms present to fall to half value. In his initial experiments, Rutherford found that the half value period of the thorium emanation was about one minute. Later experiments by Rossignol and

* Dorn, *Abh. d. Naturforsch. Ges. für Halle-a-S.* 1900.

Gimingham* gave a value of 51 seconds. Bronson† measured the rate of decay of the emanation directly and found a value of 54 seconds, while Hahn‡, using the flow method, found a value of 53·3 seconds. The half value period will be taken as 54 seconds. The activity due to the emanation alone thus practically disappears ten minutes after its introduction into a vessel. The determination of the decay of the emanation is to some extent complicated by the gradual growth of active deposit during the time the measurements are in progress.

The period of decay of the actinium emanation was first measured by the flow method by Debierne§, who found a value of 3·9 seconds. A similar number was found by Hahn and Sackur||, who showed that the emanation from Giesel's "emanium" and Debierne's "actinium" had identical periods of decay. The disturbance of measurements in a given time due to the production of active deposit is far more marked with actinium than with thorium. The emanation practically disappears in the course of one minute. The rapidity of decay can be simply illustrated by blowing a puff of air mixed with emanation into a charged electroscope. There is a rapid rate of movement of the gold leaf for the first few seconds, but after about 30 seconds the movement becomes very small.

Radium emanation. It was early recognised that the radium emanation lost its activity slowly, but the first systematic measurements of its decay were made by P. Curie¶ in 1902, and Rutherford and Soddy** in 1903. On account of the use made of the radium emanation in many types of radio-active measurements, it is of importance to know its rate of decay with the greatest possible accuracy. The methods adopted to determine the decay may be conveniently divided into two types: (1) observations of the decrease of activity of the emanation alone or of the emanation in equilibrium with its products measured by the

* Rossignol and Gimingham, *Phil. Mag.* **8**, p. 107, 1904.

† Bronson, *Amer. Journ. Sci.* **19**, p. 185, 1905.

‡ Hahn, *Jahrbuch. d. Radioakt.* **2**, p. 233, 1905.

§ Debierne, *C. R.* **136**, p. 446, 1903.

|| Hahn and Sackur, *Chem. Ber.* **38**, p. 1943, 1905.

¶ P. Curie, *C. R.* **135**, p. 857, 1902.

** Rutherford and Soddy, *Phil. Mag.* **5**, p. 445, 1903.

α rays; (2) decrease of activity of the emanation in sealed vessels measured by the β and γ rays or the γ rays alone.

As an example of the first method, we may refer to the measurements of Rutherford and Soddy. A quantity of emanation mixed with air was contained in a small gasometer over mercury. At various intervals, a definite volume of the air plus emanation was removed and discharged into a testing vessel where the saturation ionisation current due to it was measured. In order to avoid a correction for the rapid increase of ionisation due to the growth of the active deposit, the current was determined at a definite interval after its introduction. Measured in this way, the activity of the emanation was found to decrease exponentially with the time with a half value period of 3.71 days.

Sackur* by a similar method found the period 3.86 days. Bumstead and Wheeler† determined the decay of the emanation in equilibrium with its products in a sealed vessel by measurement of the ionisation current and found the period 3.88 days. Rumelin‡ determined the decay by a somewhat different method. Emanation was uniformly distributed between two glass vessels *A* and *B*, of which *A* had a volume small compared with *B*. The emanation in *A* was transferred to an emanation electroscope and its effects measured. The emanation in *B* was allowed to decay several weeks and then transferred to the electroscope. Knowing the ratio of the volumes of *A* and *B*, the period of decay can be deduced from the observed effects in the electroscope in the two cases. Rumelin found a half value period of 3.75 days.

The second method was employed initially by P. Curie (*loc. cit.*). The emanation was contained in a sealed glass tube and the ionisation due to the more penetrating β and γ rays measured between two concentric cylinders. The general arrangement of the apparatus is clearly seen in Fig. 88. In this case, the radiation of the emanation itself is not measured but the radiation from the active deposit produced from the emanation and in equilibrium with it. The emanation emits only α rays which are absorbed by the walls

* Sackur, *Ber. d. D. Chem. Ges.* **33**, p. 1753, 1905.

† Bumstead and Wheeler, *Amer. Journ. Sci.* **17**, p. 97, 1904.

‡ Rumelin, *Phil. Mag.* **14**, p. 550, 1907.

of the tube, but the active deposit emits β and γ rays. About four or five hours after the introduction of the emanation into a tube, the active deposit reaches its maximum value, and finally decays at exactly the same rate as the emanation which produces it. By measuring the saturation current at intervals, the decay of the emanation itself is determined. P. Curie by this method found the emanation decayed exponentially with a period of 3.99 days.

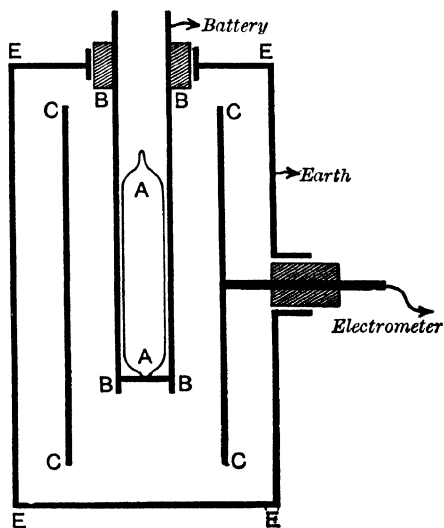

Fig. 88.

A careful series of measurements by a similar method were made by Mme Curie* in 1910. The activity of the tubes was measured for an interval of 30 to 40 days, and the decay was found to be accurately exponential. The following table shows the values of λ found in the various experiments.

Time of observation	λ (day) ⁻¹
460 hours	·1799
360 „	·1807
700 „	·1793
800 „	·1799
1040 „	·1768
Mean value	·1793

Another series of measurements were made on small quantities of emanation in a sealed vessel. The results are given in the table on the next page.

A mean value of

$$\lambda = \cdot 1801 \text{ (day)}^{-1} = \cdot 00751 \text{ (hour)}^{-1} = 2 \cdot 085 \times 10^{-6} \text{ (sec.)}^{-1}$$

was adopted. This corresponds to a half value period of 3.85 days.

* Mme Curie, *Le Radium*, 7, p. 33, 1910.

Time of observation	λ (day) ⁻¹
470 hours	·1811
450 "	·1807
430 "	·1804
430 "	·1811
580 "	·1807
Mean value	·1807

Recently the writer* made a determination of the decay of the emanation over an interval of more than 100 days corresponding to a change of intensity of the radiation of 100 million times.

The general principle of the method was as follows. The equilibrium quantity of emanation from about 50 milligrams of radium was collected in a small sealed tube. The γ rays effect of this emanation (see Appendix) was compared for several weeks with that due to a specimen of radium salt kept as a standard. In this way, the quantity of emanation present in the tube at any time could be expressed in terms of the amount of emanation in equilibrium with a known quantity of radium. The emanation was then allowed to decay to about $1/10^8$ of its initial value. The emanation remaining in the tube was then transferred into an "emanation electroscope" and its electric effect measured. The amount of emanation present was compared with that derived

Initial quantity of emanation	Final quantity of emanation	Interval	λ (day) ⁻¹
53·1 mg. Ra.	$3\cdot24 \times 10^{-7}$ mg. Ra.	105·2 days	0·1800
56·3 "	$2\cdot57 \times 10^{-7}$ "	106·3 "	0·1807
46·2 "	$5\cdot52 \times 10^{-7}$ "	101·2 "	0·1802
47·0 "	$2\cdot83 \times 10^{-7}$ "	105·15 "	0·1800
48·8 "	$2\cdot44 \times 10^{-7}$ "	106·2 "	0·1800
Mean value = 0·1802			

from a standard radium solution (see Appendix), which contained a *known* fraction of the radium in the γ ray standard. The accuracy of the standard solution which had been prepared five

* Rutherford, *Wien Ber.* **120**, p. 303, 1911.

years before was verified by a special series of experiments. The results of a number of experiments are included in the above table.

The decay constant λ is deduced on the assumption that the emanation decays exponentially over the whole interval of more than 100 days corresponding to a change of concentration in the ratio of about 1 to 200 millions. An error of 10 per cent. in the measurement of the quantity of emanation only leads to an error of about 1/2 per cent. in the value of λ .

The mean value $\lambda = 0.1802 \text{ (day)}^{-1} = 2.085 \times 10^{-6} \text{ (sec.)}^{-1}$ corresponds to a half value period of **3.846** days or to the nearest figure **3.85** days. This number is in excellent agreement with that deduced by Mme Curie by different methods.

The measurements as a whole thus indicate that the decay of the emanation follows accurately an exponential law over an enormous range. The period of decay of the emanation is uninfluenced by the *concentration*, indicating that its rate of transformation is not affected by the bombardment of its own radiations. This is shown by the independence of the rate of decay with the quantity of emanation over a very wide range. In order to test this point definitely, the writer (*loc. cit.*) compared the γ ray effect of nearly *pure* emanation in equilibrium, forced under pressure into a small capillary, with the γ ray effect when the same quantity was allowed to expand to a volume 2000 times greater. Allowing for the decay of activity in the few hours between the measurements, no appreciable change of activity could be detected.

P. Curie early showed that the decay of the emanation was unaffected by variation of temperature between 450°C. and the temperature -186°C. of liquid air. The writer (*loc. cit.*) using a balance method has been unable to detect any change of decay of the emanation between ordinary temperature and that of liquid air. In such experiments, it is essential to enclose the emanation in very small tubes, for otherwise the disturbance due to change of distribution alone may produce a marked disturbance of the balance.

Several observers have noted apparent slight irregularities in the decay of the emanation for the first two days after separation.

No definite evidence, however, of a real change of period has been obtained.

The value of λ for the emanation thus appears to be a definite and characteristic constant, which is independent of physical and chemical conditions. As P. Curie suggested, the decay of the radium emanation could be employed to fix a standard of time quite independent of all other units adopted in Physics.

The decay constants of the three emanations are compared in the following table. The average life T of an atom is expressed by $T = 1/\lambda$. (See Section 157.)

Emanations	Half-value period	Average life	Decay constant λ	Time taken to decay to 1/100 of initial value
Actinium	3.9 secs.	5.6 secs.	$\cdot 178 \text{ (sec.)}^{-1}$	26 secs.
Thorium	54 "	78 "	$\cdot 0128 \text{ "}$	6 minutes
Radium	3.85 days	5.55 days	$2.085 \times 10^{-6} \text{ "}$ $7.51 \times 10^{-3} \text{ (hr.)}^{-1}$ $\cdot 1800 \text{ (day)}^{-1}$	25.6 days

From considerations advanced in the last chapter, the emanations are to be regarded as distinct types of radio-active matter of comparatively short life, which are undergoing spontaneous transformation. There is no doubt that the emanations are distinct elements with characteristic physical properties. As far as observation has gone, the three emanations behave as chemically inert gases, and in this respect resemble the well-known helium-argon group. The differences in stability of the atoms of the three emanations are very marked. Taking the half value period as a measure of stability, it is seen that the emanation of radium is about 85,000 times more stable than that of actinium.

132. Radiations from the emanations. Special methods are necessary to examine the nature of the radiations from the emanations, for the radiations arise from the volume of the gas in which the emanations are distributed. Some experiments to examine the radiations from the thorium emanation were made by the writer in the following way.

A highly emanating thorium compound wrapped in paper was placed inside a lead box *B* about 1 cm. deep, shown in Fig. 89. An opening was cut in the top of the box, over which a very thin sheet of mica was waxed. The emanation rapidly diffused through the paper into the vessel, and after ten minutes reached a maximum. The penetrating power of the radiation from the emanation which passed through the thin mica window was examined by the electrical method in the usual way by adding screens of thin aluminium foil. The decrease of the current with thickness showed that only α rays were emitted. By a similar method, it can be shown that the emanation of actinium emits only α rays. In the latter case, it is necessary to take the observations rapidly, for the active deposit derived from the emanation increases quickly in amount and the radiations from it soon become relatively important. The emission of α rays can also be conveniently examined by a similar arrangement using the scintillation method, and in this way the ranges of the α particles from the emanations have been measured. The radium emanation also emits only α rays. The absence of β and γ rays from the radium emanation itself can be proved very conclusively by a simple experiment. The emanation freed from active deposit is rapidly introduced into a thin-walled glass tube which stops the α rays but allows the β rays to penetrate. No effect due to β rays and γ rays is initially observed. The appearance of β and γ rays from the tube later is not due to the emanation itself, but to the active deposit derived from it.

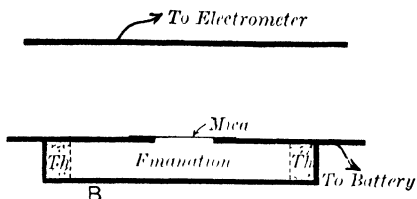

Fig. 89.

We have already referred in Section 75 to the emission of two α particles at nearly the same time from the emanation both of thorium and of actinium. Geiger* has observed that the actinium emanation under ordinary conditions emits two sets of α particles of different range. A similar result is observed for thorium, but the difference of range is not so marked. This peculiarity is due to the production from the emanation of another substance which has a very short life, and which is transformed with the

* Geiger, *Phil. Mag.* 22, p. 201, 1911.

expulsion of an α particle. If the emanation is exposed to a strong electric field, the new product is to a large extent removed from the gas to the negative electrode as fast as it is formed. This question will be discussed in detail later in Section 147.

133. Effect of conditions on the escape of thorium and actinium emanations. The amount of emanation to be obtained from a thorium compound, for example, the oxide or hydroxide, depends on the thickness of the layer. If the thorium oxide enveloped in paper is placed in a closed vessel, the ionisation current in the vessel is due mainly to the emanation, which diffuses through the paper, for the α rays emitted by the thorium are completely absorbed by the paper. It is then found that the amount of emanation increases at first with the thickness of the layer of thorium, but finally reaches a limiting value, when the emanation takes so long to diffuse from the lower layers into the gas that it has practically decayed in transit. The liberation of emanation from a thorium compound is not influenced by the nature of the gas surrounding it, and appears to be independent of the pressure over a wide range.

The compounds of thorium in the solid state vary widely in the amount of emanation they emit under ordinary conditions. It is convenient to use the term *emanating power* to express the amount of emanation given off per second by one gram of the compound. Since, however, we have no direct means of determining the volume of emanation present, all measurements of emanating power are of necessity comparative. In most cases, it is convenient to take a given weight of a thorium compound, kept under conditions as nearly as possible constant, and to compare the amount of emanation emitted by the compound under examination with this standard.

In this way comparisons of the emanating power of thorium compounds have been made by Rutherford and Soddy*, using an apparatus similar to that shown in Fig. 87.

It was found that thorium compounds varied enormously in

* Rutherford and Soddy, *Trans. Chem. Soc.* **81**, p. 321, 1902; *Phil. Mag.* **4**, p. 370, 1902.

emanating power, although the relative proportion of thorium present in the compound was not very different. For example, the emanating power of thorium hydroxide was generally 3 to 4 times greater than that of ordinary thorium oxide, obtained from the manufacturer. Thorium nitrate, in the solid state, had only 1/200 of the emanating power of ordinary thorium oxide, while preparations of the carbonate were found to show wide differences, depending upon slight variations in the method of preparation. The emanating power of different compounds of thorium and radium is much affected by the alteration of chemical and physical conditions. In this respect the emanating power, which is a measure of the rate of escape of the emanation into the surrounding gas, must not be confused with the rate of decay of the activity of the emanations themselves, which is unaffected by external conditions.

Dorn (*loc. cit.*) first observed that the emanating power of thorium and radium compounds was much affected by moisture. In a fuller investigation of this point by Rutherford and Soddy, it was found that the emanating power of thorium oxide is from two to three times greater in a moist than in a dry gas.

The rate of escape of emanation is much increased by dissolving the compound and by sending a current of air through the solution. For example, thorium nitrate, when in solution in water has an emanating power 600 to 800 times greater than in the solid state.

Actinium is usually separated with the rare earths lanthanum and cerium, and the oxides and oxalates of these substances are very porous and allow the emanation in the compound to diffuse rapidly into the surrounding gas. The marked emanating power of actinium preparations compared with that of radium is all the more remarkable when we consider the very short life of the actinium emanation; for obviously a slight retardation in the rate of diffusion of the emanation from the compound would enormously reduce its emanating power.

It is of special interest to consider the effect of temperature on the emanating power of thorium compounds. A temperature of a red heat increases the emanating power of ordinary thorium oxide three or four times. If the temperature is kept constant,

the emanation continues to escape at its increased rate but returns to its original value on cooling. If, however, the compound is heated for some time at a white heat, the emanating power is diminished, and on cooling is only ten per cent. of its original value. Rutherford and Soddy showed that the emanating power of the oxide decreased rapidly with the lowering of temperature, and was only about ten per cent. of its ordinary value at the temperature of solid carbonic acid. It regains its original value when the cooling agent is removed. A variation of temperature from -80°C . to about 800°C . thus increases the emanating power by about forty times, and between these ranges of temperature the effects of heating and cooling can be repeated without permanent change in the emanating power. We have seen that the emanating power of thorium oxide is greatly reduced by raising the temperature to a white heat. This is due to a physical alteration of the oxide, which tends to retard the escape of the emanation. The experimental evidence indicates that in all thorium compounds the rate of production of emanation is constant for equal weights of thorium in equilibrium, and that the differences in the escape of emanation depend purely on physical conditions. For example, we have seen that thorium nitrate in a solid state allows very little emanation to escape. On the other hand, the emanation is readily removed by bubbling air through the solution. If the rate of production of the emanation is the same in the solid as in solution, it is evident that the emanation which does not escape in the solid state must be stored up or occluded in the mass of the compound. This was simply illustrated by an experiment. Some thorium nitrate was rapidly dissolved by placing it in hot water and the emanation was swiftly removed by a current of air through the solution, and the amount tested in an apparatus similar to that in Fig. 87. The vessel containing the solution was then closed and the emanation again collected in the solution and in the space above it. After about ten minutes, when a state of equilibrium was reached, the emanation was again swept out rapidly into the testing vessel. The effects were found to be equal in the two cases, showing that the amount of occluded emanation in the solid was equal to the equilibrium amount in the state of solution. It is thus clear that

the emanation is produced at the same rate in the solid as in the solution.

134. Effect of conditions on escape of radium emanation. We have seen that ordinary radium compounds allow very little emanation to escape at ordinary temperatures, so that the greater part must be occluded in the radium compound. This occluded emanation can be completely liberated by heating the radium compound to a state of fusion, or by dissolving it. Under such conditions, practically the whole of the emanation can be removed either by an aspiration method or by means of a pump. In consequence of the slow rate of decay of the emanation, it takes nearly a month before the amount of emanation again reaches its equilibrium value.

On account of the importance of the radium emanation in radio-active measurements, it is desirable to consider somewhat in detail the effect of temperature and other conditions on the escape of the emanation. In the first place, it should be noted that most of the radium compounds allow only a few per cent. of the equilibrium amount of emanation to escape. This also holds true for preparations of radiferous barium. We have seen that the fraction of emanation escaping from the radium is affected to some extent by moisture and by the physical state of the compound. A radium compound when spread in a thin film loses a much greater proportion of its emanation than when spread in a thick layer. The whole of the occluded emanation can be removed by fusion or solution. Mme Curie has shown that the quantities of emanation obtained by the two methods are identical for equal weights of radium.

The effect of temperature on the rate of escape of the radium emanation has been closely investigated by Kolowrat*. The quantitative effects observed depend to a considerable extent upon the compound employed, and on its state of purity. In general, it is found that the amount of emanation released depends not only on the temperature to which it is exposed but also on the time of heating. The amount released at a given temperature increases at first with the time, but reaches a

* Kolowrat, *Le Radium*, 4, p. 317, 1907; 6, p. 321, 1909; 7, p. 266, 1910.

practical limit after three or four hours heating. In the case of radium chloride which has been previously melted, the effect of temperature does not become marked until above 300° or 400° . It then increases rapidly to about 830° . The results are shown graphically in Fig. 90, where the ordinates represent the fraction of the emanation released when the compound is raised rapidly to a fixed temperature and kept constant for 3.75 hours. The loss of emanation is comparatively small up to a temperature of about 300° . It then increases rapidly to *B* at 830° . Above this temperature, the loss of emanation diminishes again to a minimum

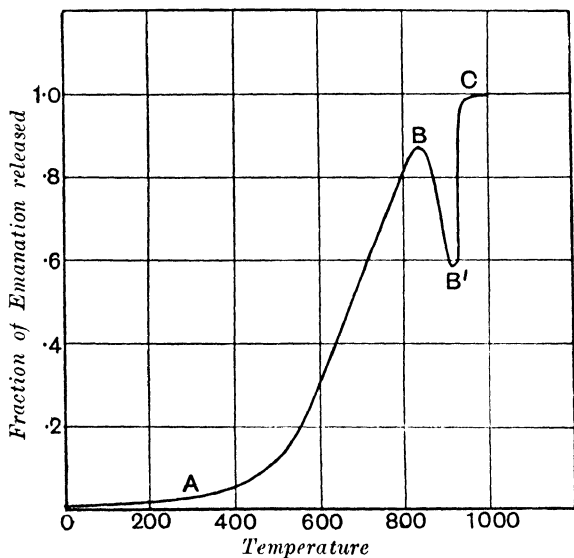

Fig. 90.

B' about 920° , and then increases again to the temperature of fusion, about 1000° , when the whole of the emanation is liberated. There is evidence that the fall of the curve to a minimum is connected with an actual change of the physical state of the compound. Kolowrat also observed the interesting point that the loss of emanation by heating to a definite temperature for a fixed interval of time is, under certain conditions, independent of the total amount of the emanation stored up in the compound. Suppose, for example, the emanation had been accumulating in a radium compound in the cold for an interval *T*. On heating for

a definite interval, *e.g.* from 2 to 4 hours, a certain quantity of emanation is released. On allowing the emanation to accumulate for a second interval T and then heating under the same conditions as before, the same quantity of emanation is again obtained, although the actual amount stored in the compound at the time of the second heating is much greater than in the first experiment. In explanation of these and other results of heating, Kolowrat suggests that the atoms of emanation formed in the radium preparation are not all held with the same degree of fixity. On heating the radium to a definite temperature, all those atoms of emanation which are lightly held in position are released and these constitute a definite fraction of the atoms produced. The residue of the atoms are so strongly held that they cannot be released until the temperature is increased further. If the emanation again accumulates in the cold, as in the case described above, a second heating under identical conditions releases the same definite fraction of the emanation accumulated in the interval, but has no effect on the part which previously remained with the radium after the first heating. In most of the experiments of Kolowrat the effects of temperature were studied on a radium compound which had been initially fused, for in this way it was found possible to bring the compound back to the same physical conditions for a repetition of experiments.

It is of importance to note that radium chloride with its water of crystallisation loses a greater part of its emanation at a temperature considerably below that of fusion. When once the water of crystallisation is removed, a much higher temperature at the second heating is required to drive off all the emanation. In this case, there is a considerable change in the physical and chemical state of the chloride after heating.

There does not appear to be any evidence that the emanation is held in chemical combination with the radium, for neither radium nor radiferous barium are able to absorb again appreciably the emanation which has once been released. The general results indicate that radium compounds are very impervious to the escape of emanation, and that the liberation of emanation is due mainly to the process of diffusion, which is much facilitated by rise of temperature. If the process of escape is one of pure diffusion, it is

to be expected that the amount of emanation released at a given temperature should be increased to some extent by increasing the fineness of division of the material so as to expose a large surface for the emanation to escape. In the case of thin films, another factor assists the loss of emanation. The atom of emanation is set in rapid motion due to the recoil produced by the α particle expelled from the parent radium atom. The velocity thus acquired is sufficient for some of the atoms of emanation to escape from the film. This effect should be more marked the thinner the layer of radio-active matter.

From the practical point of view, the most satisfactory method of obtaining the emanation from radium is to keep the radium in solution, and to remove by means of a mercury pump the emanation, together with the hydrogen and oxygen formed from the water by the radiations. A description of the methods employed for this purpose is given later in Chapter XIII.

135. Condensation of the emanation. The proof that the emanations could be condensed by the action of extreme cold was a step of great importance in the development of our knowledge of their nature, for it afforded a definite indication that the emanations were material and behaved like ordinary gases. During an investigation of the effect of physical and chemical agencies on the thorium and radium emanations, Rutherford and Soddy found that the emanations passed unchanged in amount through a white-hot platinum tube and through a tube cooled to the temperature of solid carbon dioxide. In later experiments the effects of still lower temperatures were examined, and it was then found that at the temperature of liquid air both thorium and radium emanations were condensed*.

If either emanation is conveyed by a slow stream of hydrogen, oxygen, or air through a metal spiral immersed in liquid air, and placed in connection with a testing vessel as in Fig. 87, only a small fraction of the emanation escapes in the issuing gas. When the liquid air is removed and the spiral plunged into cotton-wool, several minutes elapse before any deflection of the electrometer needle is observed, and then the condensed emanation volatilizes

* Rutherford and Soddy, *Phil. Mag.* 5, p. 561, 1903.

rapidly, and the movement of the electrometer needle is very sudden, especially in the case of radium. With a fairly large amount of radium emanation, under the conditions mentioned, a very few seconds elapse after the first sign of movement before the electrometer needle indicates a deflection of several hundred divisions per second. It is not necessary in either case that the emanating compound should be retained in the gas stream. After the emanation is condensed in the spiral, the thorium or radium compound may be removed and the gas stream sent directly into the spiral. But in the case of thorium, under these conditions, the effects observed are naturally small owing to the rapid loss of the activity of the emanation with time, which proceeds at the same rate at the temperature of liquid air as at ordinary temperatures.

If a large amount of radium emanation is condensed in a glass U tube, the progress of the condensation can be followed by the eye, by means of the phosphorescence which the radiations excite in the glass. If the ends of the tube are sealed and the temperature allowed to rise, the glow diffuses uniformly throughout the tube, and can be concentrated at any point to some extent by local cooling of the tube with liquid air. A simple experimental arrangement to illustrate the condensation and volatilization of the emanation and some of its characteristic properties is shown in Fig. 91. The emanation obtained from a few milligrams of radium salt by solution or heating is condensed in the glass U tube *T* immersed in liquid air. This U tube is then put into connection with a larger glass tube *V*, in the upper part of which is placed a piece of zinc sulphide screen *Z*, and in the lower part of the tube a piece of the mineral willemite. The stop-cock *A* is closed and the U tube and the vessel *V* are partially exhausted by a pump

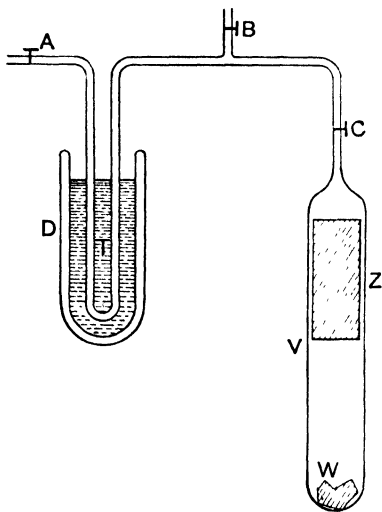

Fig. 91.

through the stop-cock *B*. This lowering of the pressure causes a more rapid diffusion of the emanation when released. The emanation does not escape if the tube *T* is kept immersed in liquid air. The stop-cock *B* is then closed, and the liquid air removed. No luminosity of the screen or the willemite in the tube *V* is observed for several minutes, until the temperature of *T* rises above the point of volatilization of the emanation. The emanation is then rapidly carried into the vessel *V*, partly by expansion of the gas in the tube *T* with rising temperature, and partly by the process of diffusion. The screen *Z* and the willemite *W* are caused to phosphoresce brilliantly under the influence of the rays from the emanation surrounding them.

If the end of the vessel *V* is then plunged into liquid air, the emanation is again condensed in the lower end of the tube, and the willemite phosphoresces much more brightly than before. This is not due to an increase of the phosphorescence of willemite at the temperature of the liquid air, but to the effect of the rays from the emanation condensed around it. At the same time the luminosity of the zinc sulphide gradually diminishes, and practically disappears after several hours if the end of the tube is kept in the liquid air. If the tube is removed from the liquid air, the emanation again volatilizes and lights up the screen *Z*. The luminosity of the willemite returns to its original value after the lapse of several hours. This slow change of the luminosity of the zinc sulphide screen and of the willemite is due to the gradual decay of the active deposit produced by the emanation on the surface of all bodies exposed to its action. The luminosity of the screen is thus due partly to the radiation from the emanation itself and partly to the radiation emitted by the active deposit. As soon as the emanation is removed from the upper to the lower part of the tube, the radiation due to the latter cause gradually diminishes in the upper and increases in the lower part of the tube.

136. Determination of the temperature of condensation. A detailed investigation was made by Rutherford and Soddy (*loc. cit.*) of the temperatures at which condensation and volatilization commenced for the two emanations. The experimental arrangement of the first method is shown clearly in Fig. 92.

A slow constant stream of gas, entering at *A*, was passed through a copper spiral *S*, over 3 metres in length, immersed in a bath of liquid ethylene. The copper spiral was made to act as its own thermometer by determining its electrical resistance. The resistance temperature curve was obtained by observation of the resistances at 0° , the boiling point of liquid ethylene -103.5° , the solidification point of ethylene -169° and in liquid air. The resistance of the spiral was deduced from the readings of an accurately calibrated Weston millivoltmeter, with a constant electric current through the spiral. The liquid ethylene was kept vigorously stirred by an electric motor, and was cooled to any desired temperature by surrounding the vessel with liquid air.

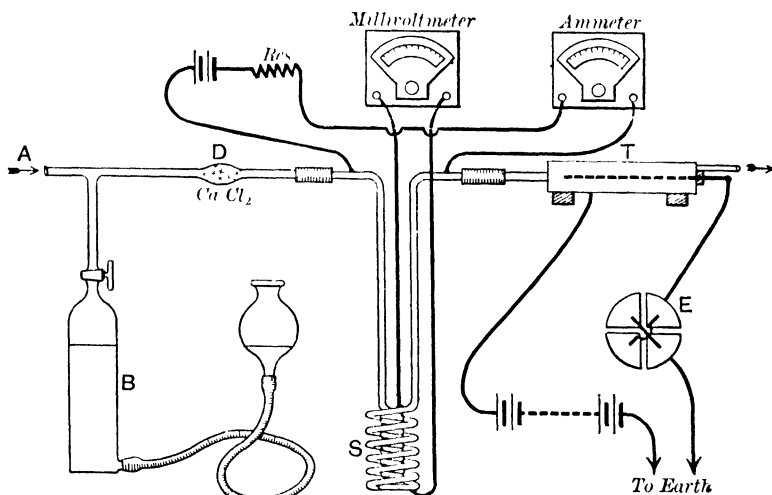

Fig. 92.

The general method employed for the radium emanation was to pass a suitable amount of emanation, mixed with the gas to be used, from the gas holder *B* into the spiral, cooled below the temperature of condensation. After the emanation was condensed in the spiral, a current of electrolytic hydrogen or oxygen was passed through the spiral. The temperature was allowed to rise gradually, and was noted at the instant when a deflection of the electrometer, due to the presence of emanation in the testing vessel *T*, was observed. The resistance, subject to a slight correction due to the time taken for the emanation to be carried into

the testing vessel, gave the temperature at which some of the emanation commenced to volatilize. The ionisation current in the testing vessel rose rapidly to a maximum value, showing that, for a small increase of temperature, the whole of the radium emanation was volatilized. The following table gives an illustration of the results obtained for a current of hydrogen of 1.38 cubic centimetres per second.

Temperature	Divisions per second of the electrometer
-160°	0
-156°	0
-154°·3	1
-153°·8	21
-152°·5	24

The following table shows the results obtained for different currents of hydrogen and oxygen.

	Current of Gas	T_1	T_2
Hydrogen ...	·25 c.c. per sec.	-151·3	-150
„ ...	·32 „ „	-153·7	-151
„ ...	·92 „ „	-152	-151
„ ...	1·38 „ „	-154	-153
„ ...	2·3 „ „	-162·5	-162
Oxygen ...	·34 „ „	-152·5	-151·5
„ ...	·58 „ „	-155	-153

The temperature T_1 in the above table gives the temperature of initial volatilization, T_2 the temperature for which half of the condensed emanation has been released. For slow currents of hydrogen and oxygen, the values of T_1 and T_2 are in good agreement. For a stream of gas as rapid as 2.3 cubic centimetres per second the value of T_1 is much lower. Such a result is to be expected; for, in too rapid a stream, the gas is not cooled to the temperature of the spiral, and, in consequence, the inside surface of the spiral is above the mean temperature, and some of the emanation escapes at a temperature apparently much lower. In

the case of oxygen, this effect appears for a gas stream of 0.58 cubic centimetres per second.

In the experiments on the thorium emanation, on account of the rapid loss of activity, a slightly different method was necessary. The steady stream of gas was passed over the thorium compound, and the temperature was observed at the instant when an appreciable movement of the electrometer appeared. This gave the temperature at which a small fraction of the thorium emanation escaped condensation, and not the value T_1 observed for the radium emanation, which gave the temperature for which a small fraction of the previously condensed emanation was volatilized.

The following table illustrates the results obtained.

	Current of Gas	Temperature
Hydrogen ...	71 c.c. per sec.	-155° C.
" ...	1.38 " "	-159° C.
Oxygen58 " "	-155° C.

On comparing these results with the values obtained for the radium emanation, it will be observed that with equal gas streams the temperatures are nearly the same.

A closer examination of the thorium emanation showed, however, that this apparent agreement was only accidental, and that there was, in reality, a very marked difference in the effect of temperature on the two emanations. It was found experimentally that the radium emanation was condensed very near the temperature at which volatilization commenced, and that the points of condensation and volatilization were defined fairly sharply.

On the other hand, the thorium emanation required a range of over 30° C. after condensation had started in order to ensure complete condensation. Fig. 93 is an example of the results obtained with a steady gas stream of 1.38 c.c. of oxygen per sec. The ordinates represent the percentage proportion of the emanation uncondensed at different temperatures. It will be observed that condensation commences about -120°, and that very little of the emanation escapes condensation at -155° C.

To investigate this difference in behaviour of the two emanations, a static method was employed, which allowed an examination of the two emanations to be made under comparable conditions. The emanation, mixed with a small amount of the gas to be used, was introduced into the cool spiral, which had been exhausted previously by means of a mercury pump. The amount of emanation remaining uncondensed after definite intervals was rapidly removed by means of the pump, and was carried with a constant auxiliary stream of gas into the testing vessel.

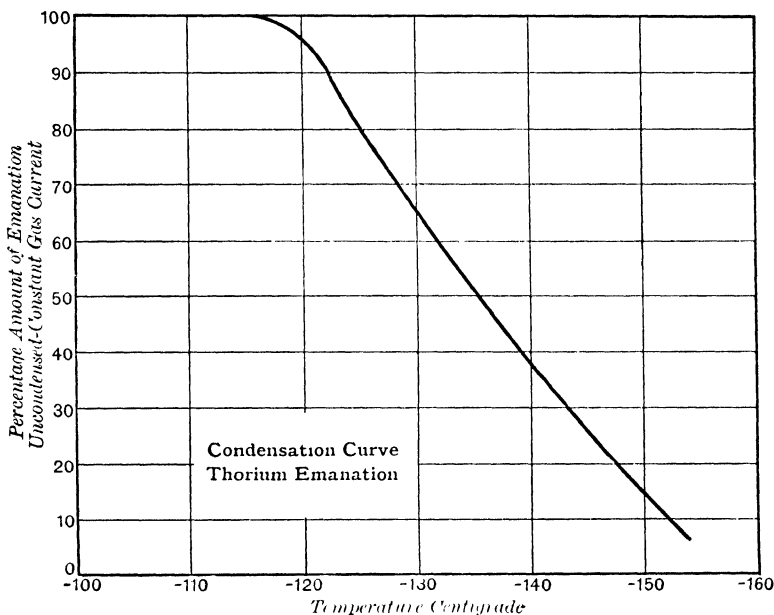

Fig. 93.

Tested in this way, it was found that the volatilization point of the radium emanation was very nearly the same as that obtained by the blowing method, viz. -150° C. With thorium, on the other hand, the condensation started at about -120° C., and as in the blowing method, continued over a range of about 30° C. The proportion of the emanation condensed at any temperature was found to depend on a variety of conditions, although the point at which condensation commenced, viz. -120° C., was about the same in each case. It depended on the pressure and nature of the gas, on the concentration of the emanation, and on the time for

which it was left in the spiral. For a given temperature a greater proportion of the emanation was condensed, the lower the pressure and the longer the time it was left in the spiral. Under the same conditions, the emanation was condensed more rapidly in hydrogen than in oxygen.

The condensation of the actinium emanation was first noted by Goldstein* and later investigated in more detail by Henriot† and Kinoshita‡. In Henriot's experiment, an actinium preparation was placed at one end of a glass tube in series with several U tubes and a screen of zinc sulphide was placed at the far end. The whole was exhausted so that the emanation diffused rapidly through the tubes, and the scintillations produced on the screen were counted with the aid of a microscope. The U tubes were initially cooled to a low temperature measured by a thermometer and the temperature then allowed to rise slowly. Scintillations were first observed at a temperature of about -143° C. and increased in number to about -103° C. These two temperatures mark the limits between complete and initial condensation.

Kinoshita employed a modification of the second method used in the experiments of Rutherford and Soddy. The emanation mixed with a gas at suitable pressure was allowed to remain a definite time in the condensation spiral and was then rapidly removed by expansion into an exhausted electroscope, where its amount was measured. He found that the emanations of thorium and actinium behaved very similarly. The temperature of complete condensation in both cases was about -150° C., and the emanations escaped condensation above a temperature of -120° C. Between these limits, the amount condensed depended not only on the temperature but on the pressure and nature of the gas, and the time allowed for condensation in the spiral. A comparison of the condensation of the emanations of thorium and actinium under similar conditions indicated that the former condensed at a temperature 2° or 3° higher than the latter.

There is seen to be a striking difference between the phenomena of condensation as exhibited by the radium emanation on

* Goldstein, *Ber. d. D. Phys. Ges.* **5**, p. 393, 1903.

† Henriot, *Le Radium*, **5**, p. 41, 1908.

‡ Kinoshita, *Phil. Mag.* **16**, p. 121, 1908.

the one hand and by the thorium and actinium emanation on the other; for the former appears to condense and volatilize between much narrower limits of temperature than the latter. This difference in behaviour is probably due to the wide variation in the amount of matter present in the two cases. It must be remembered that in the experiments described, the emanations were present in the gas with which they were conveyed in exceedingly minute proportion. A simple calculation shows that if 100 α particles were expelled per second due to emanation, it would give rise in air to an electric current easily measurable by an electrometer or electroscope. In order to produce an equal effect, however, the actual number of atoms of the three emanations present is very different. On the theory of transformation when N atoms are present λN break up per second. In order to give rise to 100 α particles per second, the number of atoms of emanation present of radium, thorium, and actinium is 4.3×10^8 , 7.8×10^3 , 5.62×10^2 , respectively. Consequently for equal electrical effects, the radium emanation must be present in about 5000 times greater quantity than that of thorium. The difference in behaviour during condensation is probably to be ascribed to this cause. The probability of the molecules coming into each other's sphere of influence will increase very rapidly as the concentration of the molecules increases, and, in the case of the radium emanation, once the temperature of condensation is attained, all but a small proportion of the total number of molecules present will condense in a very short time. In the case of the thorium emanation, however, the temperature might be far below that of condensation, and yet a considerable portion remains uncondensed for comparatively long intervals. On this view the experimental results obtained might reasonably be expected. A greater proportion of emanation condenses the longer the time allowed for condensation under the same conditions. The condensation occurs more rapidly in hydrogen than in oxygen, as the diffusion is greater in the former gas. For the same reason the condensation occurs faster the lower the pressure of the gas present.

There is every reason to believe that if the condensation of the emanation of radium could be examined under the same conditions and for the same partial pressure as for the thorium emanation, it

would show correspondingly wide differences between the temperatures of final and initial condensation.

The temperature of condensation observed for very small partial pressures of the emanation must not be confused with the true condensation temperature at atmospheric pressure. It will be seen later (Section 190) that the emanation of radium has been obtained in sufficient quantity to determine its boiling point at atmospheric pressure, and to measure its vapour pressure over a wide range of temperatures. Its boiling point -64°C . at atmospheric pressure is very different from the condensation point at low pressures, viz. about -150°C . When present in quantity, the radium emanation behaves in all respects like an ordinary gas, and for every temperature there is a definite vapour pressure.

Using the electric method, it is possible to examine the condensation behaviour of the emanations for partial pressures very much smaller than for any other gas. The effects observed are probably similar in general character to what would be shown by ordinary gases if their condensation could be followed at such minute pressures.

The condensation of the emanations has been observed for partial pressures certainly less than 10^{-16} of an atmosphere. At these small pressures, it is somewhat remarkable that the emanations can be condensed at all from the gas with which they are conveyed. The amount of emanation is far too small to form a layer of molecular thickness on even a small area. It does not appear probable that the effects observed can be due to a true condensation but rather to a surface attraction between the atoms of emanation and the atoms of the boundary. In order to test this point, Laborde* determined the temperature of condensation of the radium emanation in spirals of copper, lead, silver and glass. He observed that the temperatures of condensation were the same for the metals but different for glass. Boyle† confirmed the results in regard to metals but did not find so marked a difference for glass. It thus appears that the condensation of the emanation is not materially influenced by the nature of the condensing surface, where this does not appreciably absorb the emanation under

* Laborde, *Le Radium*, 6, p. 289, 1909; 7, p. 294, 1910.

† Boyle, *Phil. Mag.* 20, p. 955, 1910.

normal conditions. The effects observed would be quite different if the surface were a strong absorbent of the emanation, *e.g.* cocoa-nut charcoal. It is probable that the condensation of small quantities of radium emanation is due in part to a true condensation, *i.e.* to an attraction of the emanation atoms for each other and in part also to an absorption effect of the boundary, *i.e.* to an attraction of the atoms of emanation for the atoms of the boundary substance.

Boyle, using the flow method, found the temperature of volatilization of the radium emanation to be about -160°C ., which is a somewhat lower value than that found by Rutherford and Soddy. The condensed emanation appears to exhibit under all conditions a slight vapour pressure, which increases rapidly in the neighbourhood of -160°C . If a current of air is kept continually passing through a tube containing condensed emanation, the latter gradually escapes from the surface on which it is condensed and is removed by the gas stream. This effect is well exhibited when working with larger quantities of emanation. If the emanation is condensed in a glass tube, immersed in liquid air, continuous pumping slowly removes the emanation, indicating that the emanation has a sensible vapour pressure even at the temperature of -186°C .

In later experiments, Boyle* examined the condensation behaviour of larger quantities of emanation contained in glass tubes under small pressures. He concluded that the emanation behaved in all cases as if it had a vapour pressure corresponding to each temperature, and that there is no definite temperature at which the emanation may be said to condense or volatilize unless the pressure of emanation is kept constant. At the same time, there appears to be some evidence that when the emanation is condensed in a glass tube, the amount of free emanation in the space above it is dependent to some extent upon the quantity of emanation when this is small, and on the concentration of the emanation.

The condensation behaviour of the radium emanation at low partial pressures has been discussed in some detail partly because of its practical importance in many experiments, and partly on account of its theoretical interest as indicating the behaviour of a

* Boyle, *Phil. Mag.* **21**, p. 722, 1911.

gas when present in infinitesimal quantity. The condensation of the radium emanation at the temperature of liquid air has proved of great practical importance as affording a simple and reliable method of isolation of the emanation from the gases with which it is mixed, and is daily employed in a radio-active laboratory for concentration and purification of the emanation.

137. Absorption of emanation by liquids. Some early experiments by Mme Curie indicated that water was made active by exposure to the emanations, and that this was to be ascribed to the absorption of the emanation by the water. The discovery later that well water and springs contained considerable quantities of radium emanation but no radium suggested that the emanation must be soluble in water. The first definite investigations on this subject were made by von Traubenberg*, who showed that if air containing the radium emanation were shaken up with water, a state of equilibrium was soon reached where the emanation divided itself between the air and water in definite proportions. In this respect, the emanation behaves as an ordinary gas which obeys Henry's law, for the emanation is absorbed by the water until equilibrium is reached between the partial pressure of the emanation in the gas and liquid. The coefficient of absorption of the emanation by a liquid may be defined as follows. Suppose that the absorption vessel contains a volume V_1 of air or any other gas and V_2 of liquid. When equilibrium is reached, suppose the total amount of emanation mixed with the gas is E_1 and with the liquid E_2 . Then E_1/V_1 is a measure of the concentration of the emanation in the gas and E_2/V_2 in the liquid. The ratio of these concentrations $\frac{E_2/V_2}{E_1/V_1}$ or $\frac{E_2 V_1}{E_1 V_2}$ is a measure of the absorption coefficient α . The value of α is determined experimentally by shaking up the liquid and gas containing emanation until equilibrium is reached, and then by a suitable electric method measuring the relative amount of emanation in the air and water. v. Traubenberg found $\alpha = 0.33$; Mache†, later, $\alpha = 0.32$. Hofmann‡ showed

* von Traubenberg, *Phys. Zeit.* **5**, p. 130, 1904.

† Mache, *Wien Ber.* **113**, p. 1329, 1904.

‡ Hofmann, *Phys. Zeit.* **6**, p. 337, 1905.

that the value of α decreased with temperature and was equal to 0.245 at 3° C., 0.23 at 20° C. and 0.12 at 80° C. Kofler* found the value of α for a number of solutions of different concentrations, and observed that its value decreased with increase of the concentration of the dissolved substance.

The validity of the application of Henry's law of absorption to the radium emanation was closely examined by Boyle†. The amount of emanation in the gas and water was measured separately by the γ ray method. For a definite temperature, the value of α was found to be independent of the amount of emanation over a wide range, and also independent of the nature and pressure of the inactive gas mixed with the emanation. The value of α was found to decrease rapidly with the temperature. The results are included in the following table.

Absorption of the radium emanation by water at different temperatures.

Temperature	Coefficient of absorption, α	Temperature	Coefficient of absorption, α
0° C.	.507	20.3° C.	.250
4.3 "	.424	26.8 "	.206
5.7 "	.398	31.6 "	.193
10.0 "	.340	34.8 "	.176
14.0 "	.303	39.1 "	.160
17.6 "	.280		

The coefficient of absorption thus decreases to less than one-third of its value between temperatures 0° C. and 39° C. It is seen from the above table that if emanation is introduced into a vessel half filled with water at 20° C., when equilibrium is reached, 1/4 of the emanation is dissolved in the liquid and the remaining 3/4 in the gas.

Boyle found that salt water absorbs less emanation than fresh water. The absorption coefficient for salt water at 14° C. was .255, while that of fresh water was .303.

* Kofler, *Phys. Zeit.* 9, p. 6, 1908.

† Boyle, *Phil. Mag.* 22, p. 840, 1911.

A number of observers have noted that organic liquids are strong absorbents of the emanation. The coefficient of absorption for a few such liquids was determined by Boyle and for a large number by Eva Ramstedt*. Her results are included in the following table where α is the absorption coefficient.

The absorption of the emanations of thorium and actinium is difficult to measure with accuracy on account of the rapid decay of the emanations. Measurements made by Klaus† for the emanation of thorium gave a value of α of 1.05 for water at 19° C.,

Absorption of radium emanation by liquids.

Liquids	α		
	+ 18° C.	0° C.	- 18° C.
Glycerine ...	0.21	—	—
Water	0.285	0.52	—
Aniline	3.80	4.45	—
Absolute alcohol	6.17	8.28	11.4
Acetone	6.30	7.99	10.8
Ethyl acetate ...	7.35	9.41	13.6
Paraffin oil ...	9.2	12.6	—
Benzene	12.82	—	—
Xylene	12.75	—	—
Toluene	13.24	18.4	27.0
Chloroform ...	15.08	20.5	28.5
Ether	15.08	20.9	29.1
Hexane	16.56	23.4	35.2
Carbon bisulphide	23.14	33.4	50.3

and 5.01 for petroleum. v. Hevesy‡ found that the emanation of actinium was absorbed by liquids and found that the order of absorption for a number of liquids was the same as for the radium emanation. The evidence so far obtained indicates that the emanations are all readily absorbed by liquids but to different degrees.

The absorption of the emanations by liquids is of special interest both from the theoretical and practical point of view. The possibility of measurement of minute quantities of radio-active

* Ramstedt, *Le Radium*, 8, p. 253, 1911.

† Klaus, *Phys. Zeit.* 6, p. 820, 1905.

‡ v. Hevesy, *Phys. Zeit.* 12, p. 1214, 1911.

matter by the electric method affords an opportunity of testing the laws of absorption of a gas like the emanation over a very wide range, and for partial pressures exceedingly minute in comparison with those possible for inactive gases. The absorption by water of the emanations even when present in minute quantity appears to follow accurately Henry's law, and in these respects the emanations behave similarly to ordinary gases. The absorption of the radium emanation by fresh and salt water, and its variation with temperature are of importance in connection with the emanation content of spring and well water. They have also an important bearing on the relative distribution of the radium emanation over land and sea.

138. Absorption of the emanations by solids and by charcoal. When a substance is exposed for some hours in the presence of the radium emanation, it shows a strong activity on removal. This activity, which is due to the deposit of active matter from the emanation, decays rapidly with time and becomes exceedingly small after an interval of 12 hours. P. Curie and Danne* found, however, that certain substances, particularly celluloid and rubber, retained a considerable activity for some days after removal. This is due to an absorption or occlusion of the emanation by the substance. In free air, the activity due to this cause diminishes, partly due to the ordinary decay of the emanation *in situ* and partly to the escape of the emanation from the substance into the surrounding gas. A similar effect is shown to a small extent by metals, especially by lead, and is generally exhibited by porous substances, for example, by platinum black and charcoal.

The writer† showed that charcoal and notably cocoa-nut charcoal is a strong absorbent of the emanations of radium and of thorium. This can be illustrated by a simple experiment. A glass tube about 20 cms. long contains several grams of cocoa-nut charcoal at the lower end, and the upper part is coated with zinc sulphide. After heating the charcoal and exhaustion of the air,

* P. Curie and Danne, *C. R.* **136**, p. 364, 1903.

† Rutherford, *Nature*, **74**, p. 634, 1906; *Manch. Lit. and Phil. Soc.* **53**, No. 2, 1908; *Chem. News*, **99**, p. 76, 1909.

purified radium emanation is introduced into the tube. The phosphorescence of the zinc sulphide is observed to decrease rapidly with time due to the absorption of the emanation by the charcoal at ordinary temperatures. If the charcoal is then heated, a large part of the emanation is released, and this shows itself by a great increase in the luminosity of the zinc sulphide. The absorption by cocoa-nut charcoal increases with the lowering of the temperature. A tube containing 0.8 gram of cocoa-nut charcoal was heated and exhausted, and surrounded by a pentane bath at -150°C . The equilibrium amount of emanation from 83 milligrams of radium was then introduced and absorbed by the charcoal. The temperature of the bath was allowed to slowly rise, and the tube containing the charcoal connected at intervals with an exhausted space. The emanation which escaped from the charcoal was collected and its amount determined by the γ ray method. The emanation escaped slowly until the temperature rose to about -40°C . At 19°C . the amount still absorbed was 50 per cent. and at 100°C ., 19 per cent. The whole of the emanation was released by strong heating. The volume of emanation absorbed at 19°C . was about 0.2 cubic millimetre, but this is no indication of the amount that would be absorbed by the charcoal if surrounded by the emanation at atmospheric pressure. There appears to be little doubt that if the radium emanation could be obtained in quantities comparable with ordinary gases it would show an absorption in charcoal at ordinary temperatures comparable with carbon dioxide.

The conditions of absorption of the emanations by charcoal were investigated in detail by Boyle*. A large number of experiments were first made with the thorium emanation. The emanation was conveyed by a current of air through a tube containing charcoal, and the fraction absorbed was deduced by measurement of the activity of the issuing emanation. Absorption took place in all kinds of charcoal, but was most marked in cocoa-nut charcoal. The absorption increased with its fineness of division, and decreased with temperature. The results could be satisfactorily explained on the assumption that the absorption of the emanation by the charcoal at any point was proportional to the partial pressure of

* Boyle, *Phil. Mag.* 17, p. 374, 1909.

the emanation at that point, and that there was a definite equilibrium between the concentration of the emanation in the gas and the charcoal. The absorption of the radium emanation by charcoal can be very simply illustrated by introducing radium emanation into an electroscope, at the base of which is a tray containing charcoal. The emanation is rapidly absorbed, and this is indicated by a rapid decrease in the rate of discharge of the electroscope. Hevesy* observed that the emanation of actinium is also strongly absorbed by charcoal.

This property of charcoal has been utilised by Eve† and Satterly‡ to determine directly the amount of radium emanation in the atmosphere. A definite quantity of air is passed slowly through the charcoal, and a certain fraction of the emanation is absorbed by it. The charcoal is then removed and the emanation and other gases are driven off by strong heating. The collected gases are introduced into an electroscope, and the quantity of emanation measured. Under ordinary conditions the amount of emanation absorbed depends on the velocity of the current of air and the mass of charcoal. The fraction absorbed is determined by sending a known quantity of emanation through the charcoal and observing the fraction retained.

139. Diffusion of the emanation. We have seen that the emanations have the properties of radio-active gases released in minute quantity from radio-active material. In the case of the radium emanation, a sufficient quantity has been obtained in recent years to isolate it and measure its volume and density, and to determine its spectrum and boiling point. The evidence thus obtained shows that the radium emanation is to be regarded as a monatomic gas of high atomic weight, 222, with characteristic physical and chemical properties which distinguish it from all other gases. On account of the rapidity of decay of the emanations of thorium and of actinium, it has so far not been found possible to obtain a sufficient quantity to test them in a similar way; but from the similarity of their origin and of their behaviour compared with the radium emanation, there appears to be no doubt

* v. Hevesy, *Phys. Zeit.* **12**, p. 1214, 1911.

† Eve, *Phil. Mag.* **16**, p. 622, 1908.

‡ Satterly, *Phil. Mag.* **16**, p. 584, 1908; **20**, p. 778, 1910.

that they also must be regarded as radio-active gases with high but different atomic weights. In the earlier development of radio-activity, the question of the true nature of the emanations was a matter of conjecture and of some difference of opinion. While they appeared to behave as radio-active gases or vapours, they were emitted in such minute amount that it was not possible to settle the question by ordinary chemical or physical experiments. It consequently was of importance to utilize indirect methods to test their properties, and to form an estimate of their molecular weight. For this purpose, the diffusion method offered many advantages, for by using the electric method to determine quantitatively the amount of emanation present, it was found possible to compare the rates of inter-diffusion of the emanation into air and other gases with the corresponding values found for gases and vapours of known molecular weight, even though the emanation was present in exceedingly minute quantity.

We shall first consider the theory of a simple case where the emanation is diffusing along a cylinder filled with an inactive gas and where the concentration of the emanation is uniform over the cross section. Let N be the number of atoms per cubic centimetre at a distance x from a fixed point along the axis of the tube, and D the coefficient of diffusion of the emanation through the gas; then in consequence of diffusion, the rate of increase in the number of atoms of the emanation per cubic centimetre is equal to $D \frac{d^2 N}{dx^2}$.

Since the emanation is undergoing spontaneous transformation with the radio-active constant λ , the rate of decrease of the number of atoms in the emanation per cubic centimetre due to this cause is λN . Taking these two factors into account it is seen that

$$\frac{dN}{dt} = D \frac{d^2 N}{dx^2} - \lambda N.$$

When a steady state is reached

$$\frac{dN}{dt} = 0 \quad \text{and} \quad D \frac{d^2 N}{dx^2} = \lambda N.$$

In consequence of the wide differences in the rate of the decay of the three emanations, their distribution due to diffusion is very

different under ordinary experimental conditions. For example, consider a uniform layer of an actinium preparation spread on the bottom of a uniform tube. If the emanation is emitted at a constant rate into the gas, a steady state is soon reached in which the amount of emanation per unit volume decreases rapidly as we proceed from the surface of the preparation. For example, in air at atmospheric pressure and temperature, the amount of emanation falls to half value for each additional distance of 5.5 mms. Since the thorium emanation decays more slowly, the corresponding distance is greater and equal to about 1.9 cms. The corresponding distance for the radium emanation has not been determined experimentally; but is probably about 150 cms. On account of the slow decay of the radium emanation, the amount transformed during the time required for diffusion of the emanation into vessels of ordinary laboratory dimensions, is generally small, and in some cases may be neglected. Taking advantage of the smallness of this effect, Curie and Danne* showed that the radium emanation distributes itself between two vessels connected by a short tube of fairly wide bore in proportion to their volumes. In another case where one reservoir was kept at a temperature of 10° C. and the other at 350° C., the emanation divided itself between them in the same proportion as would a gas under the same conditions. In these respects the radium emanation thus behaved like an ordinary gas.

The rapidity of inter-diffusion of the emanations is increased by lowering the pressure of the gas through which it diffuses. For example, if the emanation is introduced into a reservoir in which the pressure of the gas is under one millimetre, the rate of diffusion is so rapid that the emanation is nearly uniformly distributed after an interval of several minutes.

140. Methods of measuring diffusion. Several methods have been employed to determine the inter-diffusion constant of emanations through various gases with the object of estimating the molecular weight of the emanation by comparing its rate of diffusion with those of gases of known molecular weight. These methods may be classified as follows:

* P. Curie and Danne, *C. R.* **136**, p. 1314, 1903.

(1) The diffusion of the emanation along tubes of wide cross section. (Rutherford and Miss Brooks, Debieerne, Russ, Bruhat.)

(2) The diffusion through narrow tubes. (Curie and Danne, Chaumont.)

(3) The diffusion through porous pots or other finely divided materials. (Bumstead and Wheeler, Makower, Perkins.)

(4) Effusion through small openings. (Debieerne, Miss Leslie.)

The first attempt to determine the molecular weight of the radium emanation was made by Rutherford and Miss Brooks* in 1901. The method employed was similar to that of Loschmidt† in 1871, in his investigations of the coefficient of inter-diffusion of gases.

A long brass tube 6 cms. in diameter was divided into two equal parts by a movable slide. One half contained air mixed with emanation. On opening the slide, the emanation gradually diffused into the other half. The relative amount of emanation in the two halves of the tube at any time was determined by the electric method. From this the value of the coefficient of diffusion of the emanation into air can be deduced. As the result of a number of experiments, the values of D were found to lie between $\cdot 07$ and $\cdot 09$.

Some experiments on the rate of diffusion of the radium emanation into air were made by P. Curie and Danne‡. If the emanation is contained in a closed reservoir, it has been shown that its activity, which is a measure of the amount of emanation present, decreases according to an exponential law with the time. If the reservoir is put in communication with the outside air through a capillary tube, the emanation slowly diffuses out, and the amount of emanation in the reservoir is found to decrease according to the same law as before, but at a faster rate. Using tubes of different lengths and diameters, the diffusion of the emanation was found to be in accord with the ordinary gas laws. The value obtained for D was $0\cdot 100$. This is a somewhat greater value than that observed by Rutherford and Miss Brooks.

* Rutherford and Miss Brooks, *Trans. Roy. Soc. Canada*, 1901; *Chem. News*, 1902.

† Loschmidt, *Wien Ber.* **61**, p. 367, 1871.

‡ P. Curie and Danne, *C. R.* **136**, p. 1314, 1903.

A series of experiments by a similar method were made later by Chaumont*. The emanation contained in one vessel diffused through a long narrow tube into another vessel of smaller size, in which the quantity of emanation present was measured at regular intervals. The whole apparatus was enclosed in a freezing mixture of ice and water in order to get rid of temperature disturbances. The value of D at standard pressure and temperature was found to be $D = 0.101$.

For the purpose of comparison, a few of the coefficients of inter-diffusion of gases, compiled from Landolt and Börnstein's tables, are given below.

Gas or vapour	Coefficient of diffusion into air	Molecular weight
Water vapour ...	0.198	18
Carbonic acid gas ...	0.142	44
Alcohol vapour ...	0.101	46
Ether vapour ...	0.077	74
Radium emanation ...	0.07 to 0.10	?

The table, although not very satisfactory for the purpose of comparison, shows that the diffusion constant decreases with increase of the molecular weight. According to the law of Graham, the constant of inter-diffusion of different gases should be inversely proportional to the square root of their molecular weights. It is seen, however, from the above numbers that the vapours of ether and alcohol show lower diffusion constants compared with carbonic acid than is to be expected from Graham's law. The estimation of molecular weights is very uncertain in cases where the diffusion of a monatomic gas like the emanation is compared with that of a complex vapour like ether or alcohol. From a general consideration of the results, it was concluded in these earlier experiments that the emanation behaved like a gas having a molecular weight approximately 100.

It is of interest to compare the value of $D = 0.1$ with the value of D determined by Townsend (Section 21) for the gaseous ions produced in air at ordinary pressure and temperature, by Röntgen

* Chaumont, *Le Radium*, 6, p. 106, 1909.

rays or by the radiations from active substances. Townsend found that the value of D in dry air was $\cdot 028$ for the positive ions and $\cdot 043$ for the negative ions. The uncharged radium emanation thus diffuses more rapidly than the ions produced by its radiation in the gas, and behaves as if its mass were smaller than that of the ions produced in air, but considerably greater than that of the air molecules with which it is mixed.

Diffusion through porous material.

Bumstead and Wheeler* compared the rates of diffusion of the radium emanation and of carbon dioxide through a porous plate, and, assuming Graham's law, concluded that the emanation had a molecular weight of about 180.

Makower† made a number of measurements by a similar method. The rate of diffusion of the emanation through a porous plug of plaster-of-Paris was compared with that of the gases oxygen, carbon dioxide, and sulphur dioxide. It was found that Graham's law, viz. that the coefficient of diffusion D is inversely proportional to the square root of the molecular weight M , was not strictly applicable. The value of $D\sqrt{M}$ was not found to be constant for these gases, but decreased with increase of molecular weight of the gas. If, however, a curve were plotted with $D\sqrt{M}$ as ordinate and D as abscissa, the points corresponding to the values of O, CO₂ and SO₂ were found to lie on a straight line. By linear extrapolation, the molecular weight of the emanation was estimated. The value obtained from experiments on three different porous plugs was 85.5, 97, and 99 respectively. This method indicates that the molecular weight of the radium emanation is about 100.

We have already pointed out that the deduction of the molecular weight of emanation by such methods is only approximate, since the rate of diffusion of the emanation which is present in minute quantity is compared with the rates of diffusion of other gases having complex molecules present in large quantity. In order to remove one of these difficulties, special experiments

* Bumstead and Wheeler, *Amer. Journ. Sci.* **17**, p. 97, 1904.

† Makower, *Phil. Mag.* **9**, p. 56, 1905.

were made by Perkins* to compare the rate of diffusion of the radium emanation with that of mercury vapour under the same conditions. Since the vapour of mercury behaves like a monatomic gas, and has an atomic weight not very different from that of the radium emanation, it is to be expected that a comparison of the rates of diffusion should give the molecular weight of the emanation with more certainty. In his experiments the diffusion of the radium emanation through an asbestos plug was compared with that of mercury vapour for temperatures varying between 250°C . and 275°C . In one case the diffusing vessel contained hydrogen and the emanation, and in the second case hydrogen and mercury vapour. The fraction of the amount of radium emanation and of mercury vapour, which diffused through the asbestos plate in a given time, was measured. In this way it was found that the diffusion coefficient for the emanation was $\cdot 034$, and for the mercury vapour $\cdot 037$. Assuming Graham's law, this gives a value for the molecular weight of the emanation of 234. This is not very different from the correct molecular weight, namely, 222.

141. Method of effusion. The difficulty of obtaining a reliable estimate of the molecular weight of the radium emanation by the ordinary methods of diffusion led Debiere† to apply a modification of the method of effusion used long ago by Bunsen. In this method, the rate of escape of a gas through a small orifice in a thin partition due to a difference of pressure, is proportional to the density of the gas. The apparatus used by Debiere consisted of two glass vessels, *A* and *B*, separated by a very thin platinum plate, in which was a very small hole. The vessel *B* was attached to a Gaede pump and kept exhausted to a very low pressure. The pressure p of the gas in *A* was found to vary exponentially with the time, and $p/p_0 = e^{-\mu t}$. Preliminary experiments made with a number of gases introduced in *A* at low pressures, measured by a Macleod gauge, showed that the value of the coefficient μ was inversely proportional to the square root of the molecular weight. The emanation, purified to some extent, was then introduced into *A*, and the value of μ determined, using

* Perkins, *Amer. Journ. Sci.* **25**, p. 461, 1908.

† Debiere, *C. R.* **150**, p. 1740, 1910.

the electric method to measure the amount of emanation in A at any time. The value of μ was found to be independent of the presence of other gases as impurities, even when the emanation was only present in the proportion of 1 in 200. Assuming the square root law, it was deduced that the molecular weight of the emanation was about 220—a result in good accord with the value to be expected theoretically.

142. Diffusion of the thorium and actinium emanations.

On account of the rapid decay of the emanations of thorium and actinium, it is in general not possible to determine the constant of diffusion by the methods employed for the radium emanation. The value of D can, however, be measured in the following way with considerable accuracy. Fig. 94 represents the arrangement used by the writer to determine the value of D for the thorium emanation, and is typical of the methods employed later for both the thorium and actinium emanations. A plate C covered with thorium hydroxide was placed horizontally near the base of a long brass cylinder P . The emanation released from the thorium diffuses upwards in the cylinder. A permanent state is soon reached where the rate of increase of atoms of emanation per unit volume by diffusion upward is balanced by the rate of decrease due to the transformation of the emanation. If N be the number of atoms of emanation per unit volume supposed uniform over the cross section at a distance x from the thorium,

$$D \frac{d^2 N}{dx^2} = \lambda N,$$

where λ is the radio-active constant of the emanation.

The solution of this equation is of the form

$$N = Ae^{-\sqrt{\frac{\lambda}{D}} \cdot x} + Be^{\sqrt{\frac{\lambda}{D}} \cdot x}.$$

Since $N = 0$ when $x = \infty$, $B = 0$.

If $N = N_0$ when $x = 0$, $A = N_0$.

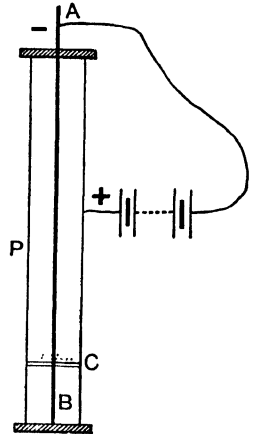

Fig. 94.

Consequently
$$N = N_0 e^{-\sqrt{\frac{\lambda}{D}} \cdot x},$$

or the concentration of the emanation should decrease exponentially with increase of x .

It is not convenient in experiments of this kind to determine directly the variation in the amount of emanation along the cylinder, but an equivalent method was used. A long rod AB charged negatively was fixed axially in the tube. Under these conditions, the amount of active deposit at each point of the rod some hours after its introduction is proportional to the amount of emanation at the corresponding height. After exposure for a day or more under constant temperature conditions, the rod was removed and the variation in the amount of active deposit along its length was determined by the electric method. In this way it was found that in dry air at ordinary temperature and pressure, the amount of emanation decreased to half value for successive distances of 1.9 cms.

Taking the half value period of the emanation as 54 seconds, $\lambda = .0128 \text{ (sec.)}^{-1}$. Substituting these values in the equation, $D = .096$.

A series of experiments by a similar method was made later by Russ* with air at different pressures. As is to be expected theoretically, the diffusion constant was found to vary inversely as the pressure of air over the range examined, viz. from 8 cms. to 76 cms. of mercury. The average value of $D = 0.103$ was found for the thorium emanation in air at ordinary temperature and pressure.

Miss Leslie † employed the method of effusion used by Debierne (Section 141) to determine the molecular weight of the thorium emanation. Assuming the half value period of the emanation was 54 seconds, she deduced that the molecular weight was about 200.

The diffusion of the actinium emanation in air has been measured by Debierne ‡, Russ § and Bruhat ||. In the arrangement

* Russ, *Phil. Mag.* **17**, p. 412, 1909.

† Miss Leslie, *C. R.* **153**, p. 328, 1911.

‡ Debierne, *Le Radium*, **4**, p. 213, 1907.

§ Russ, *Phil. Mag.* **17**, p. 412, 1909.

|| Bruhat, *C. R.* **148**, p. 628, 1909; *Le Radium*, **6**, p. 67, 1909.

of Debierne, the emanation from the actinium preparation diffused upwards between two parallel vertical plates placed close together. To ensure constant temperature conditions the whole apparatus was surrounded by a water bath through which water was circulated. The distribution of active deposit with or without an electric field is proportional at any point to the amount of emanation between the plates. As in the case of the thorium emanation, the amount of emanation decreases exponentially with the distance from the active matter. At ordinary pressure and temperature, the emanation decreased to half value through successive distances of 5.5 mms. The value of D was found to be 0.112. The values of D for gases besides air were determined with the same arrangement by Bruhat. The value of D in hydrogen was 0.412 and in carbon dioxide 0.077. The value of D was found to vary inversely as the pressure of the gas.

Russ by a similar method examined the diffusion of the actinium emanation with air, hydrogen, carbon dioxide, and sulphur dioxide, and found relative values in good accord with Graham's law. A special experiment was made to compare the diffusion of the emanation through air and through the monatomic gas argon. The values found were $D = .120$ for air and $D = .107$ for argon. These values are in good accord with Graham's law. Russ made a comparison of the value of D for thorium and actinium emanation under similar experimental conditions. The value for actinium emanation was $D = .123$, and for thorium emanation $D = .103$. The ratio of the diffusion constants is 1.19. Assuming Graham's law, it follows from these data that the molecular weight of the thorium emanation is $(1.19)^2$ or 1.42 times that of actinium emanation.

Miss Leslie working in the laboratory of the writer found that the values of D for the thorium and actinium emanations varied greatly with the experimental arrangements and with the activity of the emanations. This variation seems to be due to the diffusion of the atoms of the active deposit which have lost their charge by recombination with the ions. Experiments made with the thorium and actinium emanations under very similar conditions indicated that the value of D was about the same for both gases.

From the experiments already considered, it is clear that the

diffusion constants for the thorium and radium emanations are not very different. This would indicate that these emanations do not differ much in molecular weight—a result to be expected from our present knowledge of the transformation of these substances. On the other hand, the diffusion constant of the actinium emanation is not known with sufficient certainty to deduce its molecular weight. The results obtained by Miss Leslie, however, indicate that the molecular weight of the actinium emanation cannot differ much from that of the thorium emanation. In the absence of any definite knowledge of the atomic weight of actinium or any of its products, experiments on the diffusion of the actinium emanation afford the only means at present available of estimating its probable molecular weight.

143. Diffusion of the emanation into liquids. Experiments were made by Wallstabe* to determine the coefficient of diffusion of the radium emanation in various liquids. The liquid was contained in a cylinder, and the emanation passed into the space above it. After a definite time, samples of water at different levels were removed, and the amount of emanation present determined. The coefficient of the diffusion D into the liquid is obtained from the same equation used to determine the diffusion of the thorium and actinium emanations into a gas, viz.

$$N_x = N_0 e^{-\sqrt{\frac{\lambda}{D}} x},$$

where λ is the radio-active constant of the emanation and x the depth of the layer of water from the surface. The value of D for water was found to be $0.66 \frac{\text{cm.}^2}{\text{day}}$.

The value of D found by Stefan† for the diffusion of carbon dioxide into water was $1.36 \frac{\text{cm.}^2}{\text{day}}$. These results are thus in harmony with the conclusion drawn from the diffusion of the radium emanation into air, and show that the radium emanation behaves as a gas of high molecular weight.

* Wallstabe, *Phys. Zeit.* **4**, p. 721, 1903.

† Stefan, *Wien Ber.* **2**, p. 371, 1878.

CHAPTER X.

ACTIVE DEPOSITS.

144. Active deposits. One of the most interesting and remarkable properties of radium, thorium and actinium is their power under certain conditions of imparting temporary activity to all bodies in their neighbourhood. A substance which has been exposed for some time in the presence of radium, thorium or actinium, behaves as if its surface were coated with an invisible deposit of intensely radio-active matter. The activity thus produced on inactive substances was initially known as "induced" or "excited" radio-activity. But as there is now no doubt that it results from the deposit of active matter on the surface of the bodies and not from any change in the inactive body itself, it is not desirable to retain these terms. The active matter will in general be termed the "active deposit," thus emphasising the material origin of the activity observed.

This property was first observed by M. and Mme Curie* for radium and independently by the writer† for thorium.

If any solid body is placed inside a closed vessel containing an emanating compound of thorium, radium or actinium, its surface becomes radio-active. For thorium and actinium compounds the amount of activity on a body is in general greater the nearer it is to the active material. In the case of radium, however, provided the body has been exposed for several hours, the amount of activity is to a large extent independent of the position of the body in the vessel containing the active material. Bodies are

* P. and S. Curie, *C. R.* **129**, p. 714, 1899.

† Rutherford, *Phil. Mag.* **49**, p. 161, 1900.

made active whether exposed directly to the action of the radioactive substance or screened from the action of the direct rays. This has been clearly shown in some experiments of P. Curie. A small open vessel *a* (Fig. 95) containing a solution of radium is placed inside a larger closed vessel *V*.

Plates *A*, *B*, *C*, *D*, *E* are placed in various positions in the enclosure. After exposure for a day, the plates after removal are found to be radio-active even in positions completely shielded from the action of the direct rays. For example, the plate *D* shielded from the direct radiation by the lead plate *P* is as active as the plate *E*, exposed to the direct radiation. The amount of activity

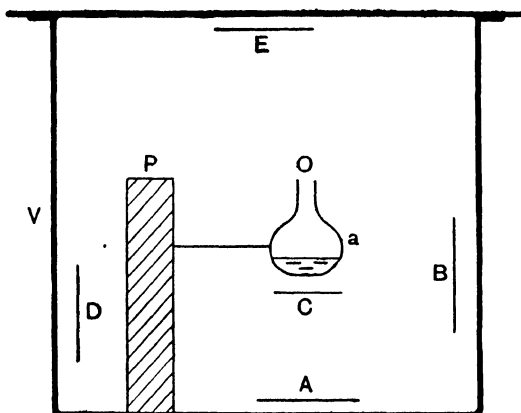

Fig. 95.

produced in a given time on a plate of given area in a definite position is independent of the material of the plate. Plates of mica, copper, cardboard, ebonite, all show equal amounts of activity. The amount of activity depends on the area of the plate and on the amount of free space in its neighbourhood.

145. Connection with the emanations. In an examination of the conditions under which the activity is observed, the writer (*loc. cit.*) found that the active deposit is only produced when the emanation is present. If a thorium, radium, or actinium compound is covered with a thin sheet of mica so that no emanation can escape, no activity can be communicated to

external bodies. Not only is the emanation necessary to produce this effect, but the amount of active deposit is always proportional to the amount of emanation. In fact, the power of imparting activity is a characteristic property of the emanations and is observed wherever any emanation is present. For example, the radium emanation stored by itself in a vessel will produce activity on bodies in contact with it as long as the emanation remains, and in amount always proportional to the amount of emanation present. On account of the rapid decay of the emanations of actinium and of thorium, the amount of emanation distributed by diffusion decreases rapidly from the surface of the emanating matter (Section 139). Consequently the amount of active deposit on a given plate decreases rapidly with its distance from the radio-active preparation. On account of the slow decay of the radium emanation, this want of uniform distribution is not noticeable in vessels of ordinary dimensions.

146. Production and decay of the active deposits. The active deposit arising from each of the emanations has characteristic radiating properties, and also a characteristic curve of decay with time. It will be shown later that the decay curve of each active deposit depends greatly on the time of exposure to the emanation, and also on the type of rays, whether α or β or γ , used for measurement. This variation in the decay curves is due to the complexity of the active matter considered. Under ordinary conditions, each of the three emanations give rise to a series of four or more successive products. It is not desirable at this stage to discuss the decay curves in detail, for this will be done later when the active deposits are analysed into their components. A close study of the phenomena shows clearly that each of the emanations is transformed into a new type of matter. For example, the atom of radium emanation in breaking up emits an α particle. The residue of the atom is lighter than before and becomes the atom of a new substance, radium A, which at ordinary temperature behaves as a solid and tends to adhere to the surface of bodies to which it diffuses or to which it is conveyed by an electric field. Radium A undergoes a series of transformations giving rise in turn to new types of matter, radium B, radium C,

etc. A similar result occurs in the cases of the thorium or actinium emanation. The first transformation product of the emanation in each case behaves as a solid known as thorium A, and actinium A respectively.

We have seen that the rate of decay of the active deposits depends on a number of conditions, resulting from the complexity of the active matter. The decay for the first few hours is in general not exponential, but ultimately each active deposit decays according to an exponential law with the time. The half value period is for the active deposit of

Radium	26·8 minutes
Actinium	36 „
Thorium	10·6 hours.

The activity of the radium and actinium deposits falls to a small fraction of its original value in four hours. On account of the slower decay of the deposit of thorium, its activity can be detected after several days.

The active deposits can be readily distinguished from each other by their characteristic decay curves, and by the penetrating power of the types of radiation emitted.

If a body is placed in a vessel containing a constant quantity of emanation, the activity imparted to it increases with the time and ultimately reaches a constant maximum value. The growth of activity is quite analogous to the recovery of activity of uranium after removal of uranium X, or of thorium after removal of thorium X, and the maximum is explained in a similar way. If a body is exposed in the presence of a constant quantity of emanation for sufficient time for the active deposit to reach an equilibrium value, the decay of activity with time, measured by one of the types of radiation is given by $I/I_{\max.} = f(t)$ where $f(t)$ is some function of the time t .

The curve showing the rise of activity with time measured by the same type of radiation is complementary to the decay curve. Consequently the rise curve is expressed by the relation

$$I/I_{\max.} = 1 - f(t).$$

Such a relation always holds between rise and recovery curves

provided the active matter in the latter case is supplied at a constant rate.

It follows from these considerations that the amount of active deposit to be derived from a constant supply of the emanations of radium and actinium reaches a practical maximum in 3 or 4 hours; in the case of thorium the corresponding interval is about 3 days.

147. Active products of very quick decay. In addition to the active matter derived from the emanations mentioned in the last section, proof has recently been obtained of the existence of an α ray product of rapid decay derived from the thorium and also from the actinium emanation. The history of the discovery of these products is of unusual interest as it illustrates possible methods of attack to detect the existence of very rapidly decaying products. Bronson* measured the relative α ray activity of the emanation of actinium and of its active deposit in equilibrium with it. Since it was known that the active deposit of the latter contained one α ray product, actinium C, it was to be expected that the number of α particles expelled from the emanation should be equal to the number of α particles expelled from actinium C in equilibrium with it. Bronson, however, found that twice as many α particles were expelled by the former. In a similar way, it was supposed at the time of the experiments that the active deposit of thorium contained two successive α ray products. On this view, experiment showed that the emanation of thorium emitted four α particles for one from each of the later products. Geiger and Marsden† investigated the question later by a different method. Using the experimental arrangement shown in Fig. 48 (Section 75) they observed that the majority of the α particles from the actinium emanation appeared as doubles, indicating that either the atom in breaking up emitted two α particles or that the emanation gave rise to another α ray product of very rapid transformation. In a similar way, they found that the scintillations from thorium did not appear as simultaneous doubles but one scintillation was always followed by another within an average interval of about $1/5$ of a second. They concluded that the thorium

* Bronson, *Phil. Mag.* **16**, p. 291, 1908.

† Geiger and Marsden, *Phys. Zeit.* **11**, p. 7, 1910.

emanation must contain two α ray products, the latter of which had an average life of about $1/5$ of a second. In 1911, Geiger* found evidence by the scintillation method that two sets of α particles of ranges 5.7 and 6.5 cms. were emitted by the actinium emanation. The product which emitted the α rays of long range was found to move in the electric field as if it carried a positive charge. This was clearly shown by the arrangement given in Fig. 96. The actinium emanation was sucked through a metal tube of rectangular section. The part AB of the tube, about 2.5 cms. long, was cut out and the opening covered by a thin sheet of mica through which the α particles escaped. An insulated wire W placed to one

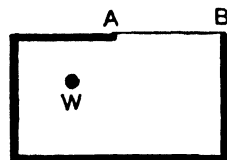

Fig. 96.

side could be charged negatively to any potential required. If the short-lived product following the emanation is positively charged, this product, as soon as it is formed, will be drawn to the negative electrode with a speed depending on the intensity of the electric field. This was found to be the case, for on charging the wire W to a high negative potential, the α rays of range 6.5 cms. were greatly reduced in number, while those of range 5.7 cms. were unaffected. By assuming that the charged radio-active atom had the same mobility as the positive ion in air, it was deduced that the period of the new substance of the actinium emanation was about $1/500$ of a second. In a similar way, evidence was found of the existence of two α ray products in the thorium emanation, but the difference of the ranges was less marked than in the case of the emanation of the actinium. There seems to be no doubt that these products of quick decay behave as solids and not as gases, and for this reason are to be regarded as the first members of the actinium and thorium active deposits†. These products will be called actinium A and thorium A respectively.

The presence of these substances can be shown in a striking way by a simple experiment. Suppose, for example, a highly emanating preparation of meso-thorium or radio-thorium is placed in a small metal box. An endless metal wire insulated from the box by ebonite stoppers and charged negatively is drawn at a

* Geiger, *Phil. Mag.* **22**, p. 201, 1911.† Rutherford and Geiger, *Phil. Mag.* **22**, p. 621, 1911.

constant rate through the box. Some of the positively charged atoms of thorium A are deposited on the wire. When a long screen of zinc sulphide is placed close to the wire where it issues from the box, a marked phosphorescence is observed, the intensity of which falls off rapidly with distance from the box. This luminosity is due to the α rays emitted from thorium A. The period of decay of thorium A can readily be estimated by observing the number of scintillations emitted from the wire at different distances from the box when the rate of translation of the wire is known. The presence of actinium A can be shown in a similar way using a strong actinium preparation. In consequence, however, of the rapidity of its decay, the wire has to be moved at a much greater speed to show the corresponding effects.

It is obvious that the ordinary methods for measuring the rate of decay of active matter are not directly applicable to such swiftly changing substances. The periods of thorium A and actinium A were, however, determined by Moseley and Fajans* by a new method devised by them. A rapidly rotating metal disc was employed. The active matter whose decay was to be tested was deposited from the emanation on the face of the disc by charging the disc negatively. The activity of the matter so deposited was examined at different angular distances from the point of deposit by electric methods. In this way, they found by direct measurement that actinium A has a half value period of $\cdot 002$ second, and thorium A of $0\cdot 14$ second. Actinium A has the shortest period of any product that has so far been detected. The principle of the method developed by Moseley and Fajans should be capable under suitable conditions of determining the decay of any α ray product whose period of decay is not less than $1/100,000$ of a second.

The product of the radium emanation which corresponds to actinium A and thorium A is called radium A, and has a period of 3 minutes. This product has long been known, and its life is long enough to permit a determination of its period by ordinary methods.

148. Concentration of the deposit on the negative electrode. When an emanating compound of thorium is placed

* Moseley and Fajans, *Phil. Mag.* **22**, p. 629, 1911.

in a closed vessel, the whole interior surface becomes strongly active. On the other hand, in a strong electric field, the writer* found that the activity was confined entirely to the negative electrode. By suitable arrangements, the whole of the active deposit, which was previously distributed over the surface of the vessel, could be concentrated on a small negative electrode placed inside the vessel. An experimental arrangement for this purpose is shown in Fig. 97.

The metal vessel *V* containing a large amount of thorium oxide is connected with the positive pole of a battery of about 300 volts. The wire *AB* to be made active is fastened to a stouter rod *BC*, passing through an ebonite plug inside a short cylinder *D*,

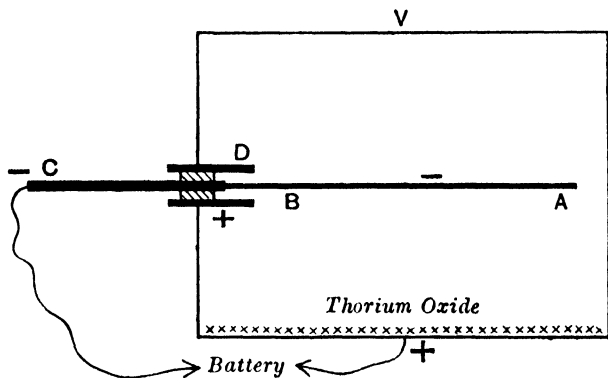

Fig. 97.

fixed in the side of the vessel. This rod is connected with the negative pole of the battery. In this way the wire *AB* is the only conductor with a negative charge, and it is found that the whole of the active deposit is concentrated upon it.

In this manner it is possible to make a short thin metal wire over 10,000 times as active per unit surface as the thorium oxide from which the active deposit is derived.

In a strong electric field at atmospheric pressure, the activity on the wire as anode is only about 1/200 of the amount deposited when the wire is cathode.

In a similar way, the active deposit of radium is mainly

* Rutherford, *Phil. Mag.* 49, p. 161, 1900.

concentrated on the cathode. Under ordinary experimental conditions about 5 per cent. is deposited on the anode. Wellisch and Bronson* have found that in a very strong electric field, the small activity which appears on the anode is due to the diffusion of uncharged atoms of the active deposit.

The distribution of the active deposit of actinium in an electric field has been examined by Russ† and Kennedy‡. In the experiments of Russ two parallel charged plates were supported symmetrically above an actinium preparation, which emitted emanation freely. The ratio of the amounts of the active deposits on the positive and negative plate was found to vary with the distance from the actinium. Close to the actinium, the activity mostly appeared on the cathode. At a considerable distance, the activity on the anode was about half that on the cathode. There is thus a wide difference under some conditions in the character of the distribution of the active deposits of actinium and thorium in an electric field.

The concentration of the active deposit on the cathode indicates that the carriers of the active matter must be *positively* charged. Since the emanation of thorium, for example, breaks up with the expulsion of an α particle which carries two unit positive charges $2e$, it would naturally be expected that the residue of the atom would retain a charge $-2e$, and would travel in an electric field to the *anode*. The reverse is observed. We have seen, however, that the passage of α particles through matter liberates a large number of δ particles, *i.e.* slow speed negative electrons. The escape of the α particle from the atom of the emanation may in a similar way liberate several electrons from the atom itself. If three electrons were emitted at the same time as the α particle, the residue of the atom would retain a charge $+e$. Whatever may be the actual process involved, the general evidence obtained from recoil phenomena in an electric field indicates that the residue of the atom after expulsion of an α particle retains a unit positive charge. While this accounts for the concentration on the cathode of the active deposits of

* Wellisch and Bronson, *Phil. Mag.* **23**, p. 714, 1912.

† Russ, *Phil. Mag.* **15**, pp. 601, 737, 1908.

‡ Kennedy, *Phil. Mag.* **18**, p. 744, 1909.

radium and thorium, it does not without other assumptions explain the complex effects observed for actinium.

The general results so far obtained in the case of actinium indicate that the carriers of the active deposit which have a negative charge increase relatively in number with the time that the carriers exist in the gas. This may possibly be connected with the presence of the α ray product of short life into which the emanation is transformed. Further investigation, however, is required before any definite explanation can be given.

149. Effect of electric field. In a strong electric field at atmospheric pressure, when the emanation is not present in large amount, the active deposit is mainly concentrated on the negative electrode. Without a field, the carriers of the active deposit diffuse through the gas, and are ultimately deposited on the walls of the containing vessel. The actual amount of active deposit to be derived from the emanation is the same whether it is concentrated by an electric field or diffused over the walls of the vessel. In an electric field of moderate strength, only a fraction of the active deposit is carried to the negative electrode. This is due to the fact that the positively charged carriers behave like positive ions, and some lose their charge by recombination with negative ions. Only the carriers which retain a positive charge are deposited on the negative electrode by the field. The uncharged carriers diffuse to the sides as in the case of no electric field.

The loss of charge by recombination has been clearly shown by Henning* and H. W. Schmidt†. In the experiments of the latter, the amounts of active deposit obtained in a given time on a negatively charged wire exposed in a vessel filled with radium emanation were compared for different voltages. The curve showing the relation between amount of active deposit and voltage was very similar in shape to the curve showing the relation between ionisation current through the gas and voltage applied. It will be seen later that the charged carriers travel in an electric field with about the same velocity as the positive ions formed in the same gas. Consequently the close similarity of the two curves shows that the

* Henning, *Ann. d. Phys.* **7**, p. 562, 1902.

† H. W. Schmidt, *Phys. Zeit.* **9**, p. 184, 1908.

carriers lose their charge by recombination at relatively the same rate as the positive ions produced by the radiations in the gas. In fact, from the point of view of recombination, they may be considered to be positive ions.

In order to concentrate most of the active deposit on the negative electrode, it is consequently necessary to apply a voltage sufficient to obtain "saturation" as regards ionisation of the gas. It is difficult to concentrate the deposit to any marked extent in the presence of a large quantity of emanation when the ionisation is very intense unless a very strong electric field is applied.

150. Effect of pressure. In the original experiments on the active deposit of thorium, the writer showed that the distribution of the active deposit in an electric field depended greatly on the pressure of the gas. The emanating thorium compound was placed inside a long closed cylinder about 4 cms. in diameter through which passed an insulated central rod, which was kept charged to -50 volts. Down to a pressure of about 10 mms. of mercury, the activity of the cathode was found to be independent of the pressure. With still further lowering of the pressure, the activity on the cathode steadily diminished, and at a pressure of $1/10$ mm. was only a fraction of its original value. This was not due to any change in the amount of active deposit formed from the emanation, but the active deposit at low pressure was found to be mainly distributed over the surface of the cylinder.

Experiments of a similar kind were made later by Makower* with the radium emanation, and a similar effect of pressure on distribution of the active deposit on the electrodes was observed.

The explanation of these phenomena is clear in the light of later experiments. The emanation, for example, of radium, breaks up with the emission of an α particle with great velocity. The residue of the atom acquires an equal and opposite momentum, and recoils at a considerable speed. Since the atomic weight of the emanation is 222 and the α particle is a helium atom of atomic weight 4, the residual atoms recoil with about $1/55$ of the velocity of the α particle and also about $1/55$ of its kinetic energy.

* Makower, *Phil. Mag.* **10**, p. 526, 1905. See also Jackson, *Phil. Mag.* **10**, p. 532, 1905.

In consequence, the residue of the atom is able to penetrate a certain thickness of matter before it is brought to rest. In consequence of its large kinetic energy, an electric field of ordinary strength has no appreciable effect in accelerating or retarding the charged atom, but is able to direct it to the cathode when once its velocity has been largely lost by collision with the gas molecules. The average distance traversed by the recoil atom before it is brought to rest depends on the pressure and nature of the gas through which it moves.

At ordinary pressures, the greater number of the recoil atoms is brought to rest in the gas within a short distance, and are then directed by the electric field to the cathode. At low pressures, however, a large proportion of the recoil atoms is able to pass through the gas before their velocity is much reduced, and embed themselves in the walls of the vessel. An electric field under these conditions has little effect in concentrating the recoil atoms on the cathode. It is consequently to be expected that at low pressures the deposit should be distributed on the interior surface of the vessel, and its distribution should be only slightly affected by an electric field. This is borne out by the experiments of Makower, and later of Russ*, who made a systematic examination of the distribution in an electric field of the active deposit of radium at various pressures. The amounts of active deposit obtained on a central wire in a vessel were compared when charged to equal and opposite potentials. For radium, the amount collected on the cathode at low pressures of air fell to a very small fraction of its value at ordinary pressure. The amount collected on the wire as anode increased slightly with lowering of pressure, but at the lowest pressure used, the amount was always slightly less than that obtained on the wire as cathode. A similar effect was observed in hydrogen and sulphur dioxide. In the case of hydrogen, the recoil atom has a larger range than in air, and consequently the amount of deposit on the cathode and anode was practically the same for all pressures lower than 1 mm. Kennedy† examined the distribution of the active deposit of actinium between two parallel plates placed close together. At ordinary pressure, the

* Russ, *Phil. Mag.* **15**, p. 601, 1908.

† Kennedy, *Phil. Mag.* **18**, p. 744, 1909.

active deposit was mainly directed to the cathode, but at low pressures tended to be equally distributed on the two plates.

151. Range of the recoil atoms. The distance traversed by the recoil atoms in a gas can be deduced from the observed distribution of the active deposit on the two electrodes. Suppose that the recoil atom has a range R in a gas before it is brought to rest by collision with the gas molecules and that this range varies inversely as the pressure p . The recoil atoms are all supposed to have a positive charge, and consequently travel to the cathode if they are stopped in the gas before reaching the anode. Suppose the emanation is uniformly distributed between two parallel plates, and the amount of active deposit on the electrodes is determined for a saturation voltage. Consider the emanation confined between two planes parallel to the plates distant x and $x + dx$ from the anode. Since the recoil atoms are on an average expelled equally in all directions, the recoil atom making an angle θ with the axis of x just reaches the plate if

$$\theta = \cos^{-1} \frac{x}{R}.$$

If n recoil atoms are generated per second per unit volume, the number per second which reaches unit area of the anode before they are stopped by the gas is given by

$$\frac{1}{2} n dx \int_0^{\cos^{-1} \frac{x}{R}} \sin \theta d\theta \text{ or } \frac{1}{2} n \left(1 - \frac{x}{R}\right) dx.$$

Integrating this over the distance d between the plates, the number per second reaching the anode by recoil is

$$\frac{1}{2} nd \left(1 - \frac{d}{2R}\right) \text{ if } R \text{ is } > d \dots \dots \dots (\text{Case 1}),$$

and $\frac{1}{4} nR$ if $R < d \dots \dots \dots (\text{Case 2}).$

The fraction ρ of the total number of recoil atoms which reach the anode in a strong electric field is consequently given by

$$\rho = \frac{1}{2} \left(1 - \frac{d}{2R}\right) \text{ for case (1),}$$

and $\rho = \frac{R}{4d}$ for case (2).

If R_1 be the range of the recoil atom at 1 mm. pressure, the range at a pressure p is R_1/p .

$$\text{Consequently } \rho = \frac{1}{2} \left(1 - \frac{pd}{2R_1} \right) \text{ for case (1),}$$

$$\text{and } \rho = R_1/4pd \quad \text{for case (2).}$$

In the case (2), the value of ρ varies inversely as the pressure of the gas. The accuracy of this theory can be tested by making use of the data given by Kennedy (*loc. cit.*) for the distribution of the active deposit of actinium between two parallel plates at various pressures of air. The plates were 2 mms. apart and a saturation P.D. of 250 volts was applied. The actual amount of active deposit on the two plates varied with the pressure on account of the variation of effects of diffusion of the emanation with pressure, but the relative amounts on the two plates need only be considered.

Pressure	$\frac{\text{Amount on cathode}}{\text{Amount on anode}}$	Fraction ρ on anode	Range R_1 at 1 mm. pressure (calculated)
5 mm.	1.03	.49	--
1 "	1.03	.49	--
2 "	1.09	.48	--
7.5 "	1.29	.44	6.2 cms. 6.0 " " 6.6 " " 6.0 " " 5.6 " " 5.6 " " 6.9 " " 6.6 " " 6.9 " " 12.2 " "
12 "	1.48	.40	
25 "	2.19	.31	
42 "	4.65	.18	
72 "	9.2	.098	
92 "	12.1	.076	
135 "	14.6	.064	
192 "	22.2	.043	
320 "	37.4	.027	
750 "	45	.021	

A simple consideration shows that we should not expect experiment and theory to agree well when the fraction on the anode becomes small, for under such conditions the presence in the gas of a small fraction of the recoil atoms which have lost their charge by recombination would have a large effect. In addition, it is necessary at higher pressures in the case of actinium to take account of the rapid transformation of actinium A and the possible

change of sign of the recoil atom. The values of the range R_1 , deduced for pressures between 7.5 and 92 mms. are in reasonable agreement, and show that the average range R_1 of the recoil atom from the emanation of actinium is about 6 cms. at 1 mm. pressure or .08 mm. at atmospheric pressure.

A consideration of the results given by Kennedy for hydrogen shows that the range in that gas is about 4 times that in air at a corresponding pressure. The ranges of the recoil atoms deduced in this way are in fair agreement with the ranges determined directly by Russ and Makower* and by Wertenstein† for the recoil of radium B from radium A. The latter found that the maximum range of the recoil atoms in this latter case was 0.12 mm. for air and about 0.7 mm. for hydrogen at atmospheric pressure. The average range of the recoil atoms was about one half of the maximum. The range of a recoil atom from different α ray products varies of course with the speed of the expelled α particle and also with the mass of the recoil atom, but the differences in range would not be large in ordinary cases.

152. Effect of gravity on the distribution. In the absence of an electric field, the active deposit is distributed on bodies near it by the process of diffusion. P. Curie observed that the amount of deposit obtained on parallel plates placed in a large vessel containing emanation was approximately proportional to the distance between the plates when the distance did not exceed 3 cms. Debierne‡ later examined the distribution in more detail and found that the amount of active deposit tended to reach a maximum limiting value for a certain distance. The limiting distance decreased with the amount of emanation present. This effect is difficult to explain unless it be supposed that the carriers of the active deposit tend in time to agglutinate together, and thus diffuse very slowly. An examination of the decay curves indicated that the matter diffusing to the plates was mainly radium A. The atoms of radium A must lose their positive charge very rapidly, due to recombination with the negative ions, especially

* Russ and Makower, *Proc. Roy. Soc. A*, **82**, p. 205, 1909.

† Wertenstein, *C. R.* **150**, p. 869, 1910; **151**, p. 469, 1910.

‡ Debierne, *Le Radium*, **6**, p. 97, 1909.

when a considerable amount of emanation is present. It appears probable, therefore, that the atoms of radium A are for the most part uncharged when they reach the walls by diffusion.

If the atoms of the active deposit remain as single molecules, it is not to be expected that their distribution would be affected by gravity. Mme Curie*, however, has described some interesting experiments which show that under certain conditions gravity does produce an effect. The arrangement employed is shown in Fig. 98.

A bell jar contained a number of pairs of parallel plates of equal size, some vertical and some horizontal. By covering the

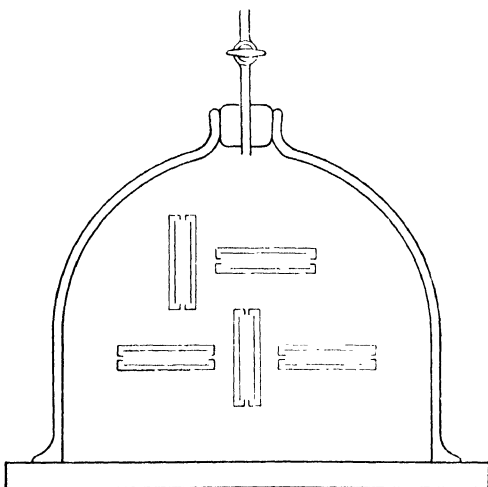

Fig. 98.

outer faces of the plates by metal foil, it was arranged that only the two opposing faces of the plates themselves were made active. After exposure for some days to the emanation, the vertical plates showed equal activities, but the activity on the lower of the horizontal plates was found to be several times greater than the corresponding upper plate.

This effect indicates that nuclei of some kind must be present in the gas on which the active deposit collects by diffusion. These nuclei fall slowly through the gas under gravity, and make the lower plate more active than the upper. In order to exhibit this

* Mme Curie, *C. R.* **145**, p. 477, 1907; *Le Radium*, **4**, p. 381, 1907.

effect, the gas must not be at too low a pressure and water vapour must be present in reasonable amount. It is produced in moist air, hydrogen, and carbonic acid. The effect increases with increase of distance between the plates, and is not appreciable for distances less than 2 mms. It increases also with increase of concentration of the emanation. The general results indicate that nuclei are produced in the gas by the radiations from the emanation when water is present. These nuclei are invisible, but act as centres for the collection of the active deposit, and gradually fall under gravity like a fine cloud, carrying the deposit with them. Mme Curie estimated that the particles fall with a velocity of the order of 10^{-4} cms. per second.

153. Velocity of the carriers in an electric field. We have seen that the carriers of the active deposit for thorium and radium are charged positively, and travel to the negative electrode at ordinary pressure. Fehrle* showed that the carriers travel along the lines of force in an electric field. For example, a negatively charged plate exposed in the presence of an emanation has more activity on the edges and corners than on the central part.

At the moment of their expulsion, the carriers are projected with a speed of about 3×10^7 cms. per second, but are brought to rest in air at atmospheric pressure after traversing about 1/10 mm. The carriers are then positively charged, and unless they lose their charge by recombination travel through the gas to the cathode.

In order to obtain some evidence of the size of these carriers, the writer† determined their velocity in an electric field, by a special method. The carriers were found to travel at the same rate as positive ions produced in the gas, and had a velocity of about 1.4 cms. per second for a gradient of one volt per cm. The velocity of the positively charged carriers in the recoil of thorium D from thorium C was later measured by Franck‡, and found to be about the same as for the positive ion in the same gas. There is good evidence that the carriers of the active deposit have a single

* Fehrle, *Phys. Zeit.* **3**, p. 130, 1902.

† Rutherford, *Phil. Mag.* **5**, p. 95, 1903.

‡ Franck, *Verh. d. D. Phys. Ges.* **11**, p. 397, 1909.

unit charge, and have an atomic weight above 200. The agreement of the velocity of the carrier with that of the positive ion does not of itself throw any definite light on the mass of the carrier. (See Section 22.)

Since the carrier of the active deposit travels at the same rate as a positive ion, and also loses its charge by recombination in the same way, the equations of its motion through a gas in an electric field are the same as for the positive ion.

Since under ordinary experimental conditions, the number of ions present in the gas is very large compared with the number of carriers of active deposit present, the fraction of the carriers which lose their charge by recombination must be the same as for the ordinary ions. For example, if the current through the ionised gas is 1/10 of its saturation value, 9/10 of the ions and of the carriers have lost their charge by recombination, and only 1/10 of the total number of positive ions and of carriers reach the cathode.

Physical and chemical properties of the active deposits.

In the original experiments on the active deposit of thorium, Rutherford showed that the activity observed must be due to an invisible film of radio-active matter deposited on the surface of the material. For example, the deposit on a platinum plate was to a large extent removed by placing the plate in strong hydrochloric or sulphuric acid. The activity was not destroyed by this process, for on evaporating the acid, it remained behind. In general, the active deposits of thorium, radium, and actinium are soluble in strong acids, and a solution of the active deposit can thus be readily obtained. The active deposits are only slightly soluble in water and alcohol. A detailed examination of the general physical and chemical properties of the active deposit of thorium was made initially by v. Lerch*. A solution of the active deposit was prepared by dissolving the metal which had been exposed for some time to the emanation. On dipping plates of different metals into the solution, active matter was deposited electro-chemically upon them. The amount of activity thus obtained depended upon the nature of the metal. In other experiments,

* F. von Lerch, *Ann. d. Phys.* **12**, p. 745, 1903.

various substances were precipitated in the solution and the amount and decay of the activity of the precipitate were determined. It was also found that active matter could be separated from a solution of the active deposit by electrolysis. Experiments of this kind were first made by Dorn using a radium solution, and v. Lerch* and Pegram† on the active deposit of thorium. The amount and decay of the activity obtained on the electrodes varied according to the condition of the experiments. In the light of later knowledge such results were to be expected, for the active deposit of thorium contains several distinct substances. A discussion of the electro-chemical and electrolytic methods of separation of active substances is given later in Chapter XVIII.

It was early observed that the active deposit of thorium on a platinum plate could be almost completely driven off at a temperature of a white heat. Miss Gates‡ showed that the activity was not destroyed by this process, but manifested itself on neighbouring bodies. When the active wire was heated electrically in a closed cylinder, the active deposit was transferred from the wire to the cylinder in unaltered amount. Similar results were found with the active deposit of radium. The effect of temperature appears to be mainly due to an actual volatilisation of the substances composing the active deposit. The effect of temperature on the active deposits of thorium, radium and actinium were later made the subject of a detailed examination. In general, it was found that the components of the active deposits volatilised at different temperatures, and in this way a partial separation of the products could be effected. The active deposit of actinium is much more easily volatilised than that of thorium or radium. The main results of these experiments will be discussed later when an account is given of the analysis of the active deposit into its various components.

* F. von Lerch, *Ann. d. Phys.* **12**, p. 745, 1903.

† Pegram, *Phys. Rev.* **17**, p. 424, 1903.

‡ Miss Gates, *Phys. Rev.* **16**, p. 300, 1903.

CHAPTER XI.

THEORY OF SUCCESSIVE TRANSFORMATIONS.

154. A brief account has already been given in Chapter VIII of the development of the disintegration theory and of some experimental evidence in support of it. Before considering the general application of the theory to any number of successive transformations a brief review will first be given of the working hypotheses which have served as a guide to the investigators in the field of radio-activity. These working theories have in many cases been modified or extended with the growth of experimental knowledge.

The early experiments of Mme Curie had indicated that radio-activity was an atomic and not a molecular phenomenon. This was still further substantiated by later work, and the detection and isolation of radium from pitchblende was a brilliant verification of the truth of this hypothesis.

The discovery that the β rays emitted by active matter were similar to the cathode rays produced in a vacuum tube was an important advance, and has formed the basis of several subsequent theories. J. Perrin*, in 1901, following the views of J. J. Thomson and others, suggested that the atoms of matter consisted of parts and might be likened to a miniature planetary system. In the atoms of the radio-elements, the parts composing the atoms more distant from the centre might be able to escape from the central attraction and thus give rise to the radiation of energy observed. In 1901, Becquerel† put forward the following hypothesis, which,

* Perrin, *Revue Scientifique*, April 13, 1901.

† Becquerel, *C. R.* **133**, p. 977, 1901.

he stated, had served him as a guide in his investigations. Adopting the view of J. J. Thomson, radio-active matter may be supposed to consist of negatively and positively charged particles. The former have a mass about 1/1000 of the mass of the hydrogen atom, while the latter have a mass about one thousand times greater than that of the negative particle. The negatively charged particles (the β rays) would be projected with great velocity, but the larger positive particles with a much lower velocity, forming a sort of gas (the emanation) which deposits itself on the surface of bodies. This in turn would subdivide, giving rise to rays (induced activity).

In 1901, Rutherford and McClung* calculated the amount of energy emitted per year from uranium and radium in the form of ionising radiations and showed that its value was large for the latter substance. The suggestion was made that this energy might be derived from a re-grouping of the constituents of the atom of the radio-elements, and it was pointed out that the possible energy to be derived from a greater concentration of the components of the atom was large compared with that given out in molecular reactions.

In the original papers† giving an account of the discovery of the emanation of thorium and of the active deposit produced by it, the view was taken that both of these manifestations were due to the presence of radio-active matter. The emanation behaved like a gas, while the matter which caused the so-called induced activity attached itself to solids and could be dissolved in some acids but not in others. Rutherford and Miss Brooks showed that the radium emanation diffused through air like a gas of heavy molecular weight. At a later date Rutherford and Soddy showed that the radium and thorium emanations behaved like chemically inert gases, since they were unaffected by the most drastic physical and chemical treatment.

P. Curie‡, who in conjunction with Debierne, had made a series of researches on the radium emanation, did not at first consider that there was sufficient evidence that the emanation was material

* Rutherford and McClung, *Phil. Trans. Roy. Soc. A*, **196**, p. 25, 1901.

† Rutherford, *Phil. Mag.* **49**, pp. 1, 261, 1900.

‡ P. Curie, *C. R.* **136**, p. 223, 1903.

in nature. He suggested that the emanation consisted of centres of condensation of energy attached to the gas molecules and moving with them.

M. and Mme Curie initially took a very general view of the phenomena of radio-activity, and did not put forward any definite theory. In 1902, they gave an account of the general working theory* which had guided them in their researches. Radio-activity was an atomic property, and the recognition of this fact had created their methods of research. Each atom acted as a constant source of emission of energy. This energy might either be derived from the potential energy of the atom itself, or each atom might act as a mechanism which instantly regained the energy which it lost. They suggested that this energy possibly might be borrowed from the surrounding air in some way not accounted for by the principle of Carnot.

In a paper announcing the discovery of the heat emission of radium, P. Curie and Laborde† state that the heat energy might be equally well supposed to be derived from a breaking up of the radium atom or from energy absorbed by the radium from some external source.

J. J. Thomson in an article on "Radium," communicated to *Nature*‡, put forward the view that the emission of energy from radium was probably due to some change within the atom, and pointed out that a large store of energy would be released by a contraction of the atom.

Sir William Crookes§, in 1899, proposed the theory that the radio-active elements possessed the property of abstracting energy from the gas. If the moving molecules, impinging more swiftly on the substance, were released from the active substance at a much lower velocity, the energy released from the radio-elements might be derived from the atmosphere. This theory was advanced again later to account for the large heat emission of radium, discovered by P. Curie and Laborde.

F. Re|| advanced a very general theory of matter with a

* M. and Mme Curie, *C. R.* **134**, p. 85, 1902.

† P. Curie and Laborde, *C. R.* **136**, p. 673, 1903.

‡ J. J. Thomson, *Nature*, **67**, p. 601, 1903.

§ Crookes, *C. R.* **128**, p. 176, 1899.

|| F. Re, *C. R.* **136**, p. 1393, 1903.

special application to radio-active bodies. He supposed that the parts of the atom were originally free, constituting a nebula of extreme tenuity. These parts had gradually become united round centres of condensation, and had thus formed the atoms of the elements. On this view an atom might be likened to an extinct sun. The radio-active atoms occupied a transitional stage between the original nebula and the more stable chemical atoms, and in the course of their contraction gave rise to the heat emission observed.

Lord Kelvin in a paper to the British Association meeting, 1903, suggested that radium might obtain its energy from external sources. If a piece of white paper is put into one vessel and a piece of black paper into an exactly similar vessel, on exposure of both vessels to light the vessel containing the black paper is found to be at a higher temperature. He suggested that radium in a similar manner might keep its temperature above the surrounding air by its power of absorbing unknown radiations.

Armstrong and Lowry* in 1903 suggested that radio-activity might be an exaggerated form of phosphorescence or fluorescence with a slow rate of decay.

In the course of a detailed study of the radio-activity of thorium, Rutherford and Soddy† found that it was necessary to suppose that thorium was continuously producing from itself new kinds of active matter, which possess temporary activity and differ in chemical properties from the thorium itself. The constant radio-activity of thorium was shown to be the result of equilibrium between the processes of production of active matter and the change of that already produced. At the same time, the theory was advanced that the production of active matter was a consequence of the disintegration of the atom. The work of the following year was devoted to an examination of the radio-activity of uranium and radium on similar lines, and it was found that the conclusions already advanced for thorium held equally for uranium

* Armstrong and Lowry, *Chem. News*, **88**, p. 89, 1903.

† Rutherford and Soddy, *Trans. Chem. Soc.* **81**, pp. 321, 837, 1902; *Phil. Mag.* **4**, pp. 370, 569, 1902.

and radium*. The discovery of the condensation of the radio-active emanations† gave additional support to the view that the emanations were gaseous in character. In the meantime, the writer had found that the α rays consisted of positively charged bodies atomic in size, projected with great velocity. The discovery of the material nature of these rays served to strengthen the theory of atomic disintegration, and at the same time to offer an explanation of the connection between the α rays and the changes occurring in the radio-elements. In a paper entitled "Radio-active Change," Rutherford and Soddy§ put forward in some detail the theory of atomic disintegration as an explanation of the phenomena of radio-activity, and at the same time some of the more important consequences which follow from the theory were discussed.

155. Discussion of theories. From the survey of the general hypotheses advanced as possible explanations of radio-activity, it is seen that they may be divided broadly into two classes, one of which assumes that the energy emitted from the radio-elements is obtained at the expense of the internal energy of the atom, and the other that the energy is derived from external sources, but that the radio-elements act as mechanisms capable of transforming this borrowed energy into the special forms manifested in the phenomena of radio-activity. Of these two sets of hypotheses the first appears to be the more probable, and to be best supported by the experimental evidence. Up to the present not the slightest experimental evidence has been adduced to show that the energy of radium is derived from external sources.

It was initially suggested that the radiation of energy from active bodies might be accounted for by supposing that space is traversed by a type of γ rays, and that the active substances possess the property of absorbing them. Later work has undoubtedly shown that γ rays are everywhere present on the earth's surface, but their energy is far too feeble to account even for the weak radiation of energy from an element like uranium.

* Rutherford and Soddy, *Phil. Mag.* **5**, pp. 441, 445, 1903.

† Rutherford and Soddy, *Phil. Mag.* **5**, p. 561, 1903.

‡ Rutherford, *Phys. Zeit.* **4**, p. 235, 1902; *Phil. Mag.* **5**, p. 177, 1903.

§ Rutherford and Soddy, *Phil. Mag.* **5**, p. 576, 1903.

The activity of radium measured by the γ rays is unaltered by any physical or chemical process. In addition, the γ ray activity of radium remains unchanged with time when it is hermetically sealed in a thick block of lead. Even supposing that the radio-active elements possess to a marked degree the power of absorbing energy from the outside, there still remains the fundamental difficulty of accounting for the peculiar radiations emitted by the radio-elements, and the series of transformations occurring in them. It is not sufficient to account for the heat emission only (Chapter XVII), for it has been found that the emission of heat is directly connected with the emission of the radiations.

In addition, the distribution of the heat emission of radium amongst the radio-active products which arise from it is extremely difficult to explain on the hypothesis that the energy emitted is borrowed from external sources. It has been found that more than three-quarters of the heat emitted by radium is due to the emanation together with the active deposit which is produced by it. When the emanation is separated from the radium, its power of emitting heat, after reaching a maximum, decreases with the time according to an exponential law. It would thus be necessary on the absorption hypothesis to postulate that most of the heat emission of radium, observed under ordinary conditions, is not due to the radium itself but to something produced by the radium, whose power of absorbing energy from external sources diminishes with time.

A similar argument also applies to the variation with time of the heating effect of the active deposit produced from the emanation.

The strongest evidence against the hypothesis of absorption of external energy is that such a theory ignores the fact, that, whenever radio-activity is observed, it is always accompanied by some change which can be detected by the appearance of new products having chemical properties distinct from those of the original substances. This leads to some form of "chemical" theory, and other results show that the change is atomic and not molecular.

156. Theory of radio-active change. The processes occurring in the radio-elements are of a character quite distinct from

any previously observed in chemistry. Although it has been shown that the radio-activity is due to the spontaneous and continuous production of new types of active matter, the laws which control this production are different from the laws of ordinary chemical reactions. It has not been found possible in any way to alter either the rate at which the matter is produced or its rate of change when produced. Temperature, which is such an important factor in altering the rate of chemical reactions, is, in these cases, entirely without influence. In addition, no ordinary chemical change is known which is accompanied by the expulsion of charged atoms with great velocity. Whatever hypothesis is put forward to explain radio-activity, it must account not only for the production of a series of active products, which differ in chemical and physical properties from each other and from the parent element, but must account also for the emission of rays of a special character. Besides this, it is necessary to explain the large amount of energy continuously radiated from active matter.

The radio-elements, besides their high atomic weights, do not possess in common any special chemical characteristics which differentiate them from the other elements, which do not possess the property of radio-activity to an appreciable degree. Of all the known elements, uranium, thorium, and radium possess the greatest atomic weights, viz.: radium 226, thorium 232.0, and uranium 238.5.

If a high atomic weight is taken as evidence of a complicated structure of the atom, it might be expected that disintegration would occur more readily in the heavier atoms. At the same time, there is no reason to suppose that the elements of the highest atomic weight must be the most radio-active; in fact, radium is far more active than uranium, although its atomic weight is less. This is seen to be the case also in other radio-active products; for example, the radium emanation is enormously more active weight for weight than the radium itself, and it is known that the emanation has an atom lighter than that of radium.

In order to explain the phenomena of radio-activity, Rutherford and Soddy have advanced the theory that the atoms of the radio-elements suffer spontaneous disintegration, and that each

disintegrated atom passes through a succession of well-marked changes, accompanied in most cases by the emission of α rays.

A preliminary account of this hypothesis has already been given in Section 128. The theory supposes that, on an average, a definite small proportion of the atoms of each radio-active substance becomes unstable at a given time. As a result of this instability, the atoms break up. In most cases, the disintegration is explosive in violence and is accompanied by the ejection of an α particle with great velocity; in a few cases, α and β particles are expelled together, while in others a β particle alone escapes. In a few cases, the change in the atom appears to be less violent in character, and is not accompanied by the expulsion of either an α or β particle. The expulsion of an α particle, of atomic weight 4, leaves behind it a new system lighter than the original one, and possessing chemical and physical properties quite different from those of the original element. This new system again becomes unstable, and expels another α particle. The process of disintegration, once started, proceeds from stage to stage at a definite measurable rate in each case.

At any time after the disintegration has commenced, there exists a proportion of the original matter, which is unchanged, mixed with the part which has undergone change. This is in accordance with the observed fact that the spectrum of radium, for example, does not change progressively with time. The radium breaks up so slowly that only a small fraction has been transformed in the course of a few years. The unchanged part still shows its characteristic spectrum, and will continue to do so as long as any radium exists. At the same time it is to be expected that, in old preparations of radium, the spectra of those products which have been formed in any quantity should also appear.

The striking dissimilarity which exists in many cases between the chemical and the physical properties of the parent matter and the product to which it gives rise is very well illustrated by the case of radium and the radium emanation. Radium is an element so closely allied in chemical properties to barium that, apart from a slight difference in the solubility of the chlorides and bromides, it is difficult to distinguish chemically between them. It has a

definite spectrum of bright lines similar in many respects to the spectra of the alkaline earths. Like barium, it is non-volatile at ordinary temperature. On the other hand, the emanation which is continually produced from radium is a radio-active and chemically inert gas which at very low pressures is condensed at a temperature -150°C . A sufficient amount of this gas has been collected to determine its volume, density, spectrum and boiling point (see chapter XIII). Both in its spectrum and in the absence of definite chemical properties, it resembles the argon-helium group of inert gases. The emanation must be considered to be an unstable gas of high molecular weight, which breaks up with the emission of α particles. After the expulsion of helium atoms, the residual atoms form a new substance called radium A, which behaves as a solid and is deposited on the surface of bodies. The chemical and physical properties of this new substance are again entirely distinct from radium and its emanation. Radium A in turn gives rise to a long series of successive products, each of which has certain distinctive chemical and physical properties which allow of its separation from a mixture of the others.

The mathematical theory of successive changes and its application to the analysis of radio-active substances was put forward by the writer* in the Bakerian Lecture to the Royal Society in 1904 and described in a paper entitled "The Succession of Changes in Radio-active Bodies." The general theory has been discussed by Stark†, Gruner‡ and Bateman§. The latter described a simple method of writing down in a symmetrical form the mathematical solution for any number of changes.

157. Theory of one transformation. Before considering the evidence from which these changes are deduced, the general theory of radio-active changes will be considered. It is very convenient in discussing mathematically the theory of successive changes to suppose that the initial matter called A changes into B , B into C , C into D , and so on. We shall first consider

* Rutherford, *Phil. Trans. Roy. Soc. A*, **204**, p. 169, 1904.

† J. Stark, *Jahrb. d. Radioakt.* **1**, p. 1, 1904.

‡ P. Gruner, *Arch. sc. phys. et nat.* (4) **23**, pp. 5, 113, 329, 1907; (4) **31**, p. 509 1911.

§ H. Bateman, *Proc. Camb. Phil. Soc.* **15**, p. 423, 1910.

the transformation of a single substance A . It has been found experimentally that any single radio-active substance, obtained by itself, decays according to an exponential law with the time. We have seen that this can be expressed by the relation $N/N_0 = e^{-\lambda t}$, where N_0 is the number of atoms initially present and N the number remaining after an interval t . This general law of transformation holds universally for all the products, but λ has a different but characteristic value for each product. Differentiating, $dN/dt = -\lambda N$, or, in other words, the rate of decrease of the number of atoms is proportional to the number present. If each atom of A changes into one of B , λN is equal to the number of atoms of B formed per second. Since the radiation accompanies the transformation, dN/dt is also proportional to the intensity of the radiation emitted by the product.

We have previously shown in Section 75 that the rate of transformation of a product is governed by the laws of probability. The number of atoms breaking up in a given time is subject to fluctuations round the average value of the magnitude to be expected from the general probability theory. In this case λ represents the *average* fraction of the number of atoms which break up per second. The value of N given by the relation $N/N_0 = e^{-\lambda t}$ has been shown by v. Schweidler to represent the most probable value. The experimental evidence so far obtained shows that the exponential law of transformation holds universally for all products, and is completely independent of physical and chemical conditions. The fraction of a product transformed per second, is independent, for example, of the age of the product, and is quite unaffected by the concentration of the active matter itself.

These conclusions are well illustrated by experiments on the rate of decay of the radium emanation under different conditions discussed in Section 131. It has been shown that radium emanation more than three months old decays at exactly the same rate as emanation freshly produced from radium. The constancy of the law of transformation is from the physical point of view very remarkable. It shows that the chance of any atom breaking up in a given time is independent of the age of the atom, and is the same, for example, whether it is produced a second before or has

existed independently for more than three months. Such results show that the decay of the emanation is independent of its past history. It does not seem possible, for example, to suppose that each atom at its birth begins to lose energy by radiation, and that its disintegration is a result of the drain of energy from the system. On such a view it would be expected that the rate of decay would increase with the age of the atoms. It would appear as if the rate of transformation of the atoms depends purely on the laws of probability, and is uninfluenced by their past history.

The law of transformation shows that theoretically any atom may exist unchanged for any time from zero to infinity. In practice, however, it is often convenient to speak of the *average* life of a large number of atoms. This has a definite value which can be simply calculated. Suppose that N_0 atoms of a substance are initially present. After a time t , the number which change in the time dt is equal to $\lambda N dt$ or $\lambda N_0 e^{-\lambda t} dt$. Each of these atoms has a life t , so that the average life of the whole number is given by $\int_0^{\infty} \lambda t e^{-\lambda t} dt$ or $1/\lambda$. The average life of an atom is consequently measured by the reciprocal of the radio-active constant.

158. Theory of successive transformation. We shall now consider a number of important cases where the active matter passes through a succession of changes.

Suppose that $P, Q, R \dots$ represent the number of particles of the matter $A, B,$ and $C \dots$ respectively at any time t . Let $\lambda_1, \lambda_2, \lambda_3 \dots$ be the constants of change of the matter $A, B,$ and $C \dots$ respectively.

Each atom of the matter A is supposed to give rise to one atom of the matter B , one atom of B to one of C , and so on.

The expelled "rays" or particles are non-radio-active, and so do not enter into the calculation.

It is not difficult to deduce mathematically the number of atoms of P, Q, R, \dots of the matter A, B, C, \dots existing at any time t after this matter is set aside, if the initial values of P, Q, R, \dots are given. In practice, however, it is generally only necessary to employ three special cases of the theory which correspond, for

example, to the changes in the active deposit, produced on a plate exposed to a constant amount of radium emanation and then removed, (1) when the time of exposure is extremely short compared with the period of the changes, (2) when the time of exposure is so long that the amount of each of the products has reached a steady limiting value, and (3) for any time of exposure.

There is also another case of importance which is practically a converse of case 3, viz. when the matter *A* is supplied at a constant rate from a primary source and the amounts of *A*, *B*, *C* are required at any subsequent time. The solution of this can, however, be deduced immediately from case 3 without analysis.

159. CASE 1. *Suppose that the matter initially considered is all of one kind A. It is required to find the number of particles P, Q, R, S ... of the matter A, B, C, D ... respectively present after any time t.*

Then $P = P_0 e^{-\lambda_1 t}$, if P_0 is the number of particles of *A* initially present. Now dQ , the increase of the number of particles of the matter *B* per unit time, is the number supplied by the change of the matter *A*, less the number due to the change of *B* into *C*, thus

$$dP/dt = -\lambda_1 P \dots\dots\dots(1),$$

$$dQ/dt = \lambda_1 P - \lambda_2 Q \dots\dots\dots(2).$$

Similarly $dR/dt = \lambda_2 Q - \lambda_3 R \dots\dots\dots(3).$

Substituting in (2) the value of *P* in terms of P_0 ,

$$dQ/dt = \lambda_1 P_0 e^{-\lambda_1 t} - \lambda_2 Q.$$

The solution of this equation is of the form

$$Q = P_0 (ae^{-\lambda_1 t} + be^{-\lambda_2 t}) \dots\dots\dots(4).$$

By substitution it is found that $a = \lambda_1 / (\lambda_2 - \lambda_1)$.

Since $Q = 0$ when $t = 0$, $b = -\lambda_1 (\lambda_2 - \lambda_1)$.

Thus
$$Q = \frac{P_0 \lambda_1}{\lambda_2 - \lambda_1} (e^{-\lambda_1 t} - e^{-\lambda_2 t}) \dots\dots\dots(5).$$

Substituting this value of *Q* in (3), it can readily be shown that

$$R = P_0 (ae^{-\lambda_1 t} + be^{-\lambda_2 t} + ce^{-\lambda_3 t}) \dots\dots\dots(6),$$

where

$$a = \frac{\lambda_1 \lambda_2}{(\lambda_2 - \lambda_1)(\lambda_3 - \lambda_1)}, \quad b = \frac{\lambda_1 \lambda_2}{(\lambda_1 - \lambda_2)(\lambda_3 - \lambda_2)},$$

$$c = \frac{\lambda_1 \lambda_2}{(\lambda_1 - \lambda_3)(\lambda_2 - \lambda_3)}.$$

Similarly it can be shown that

$$S = P_0 (ae^{-\lambda_1 t} + be^{-\lambda_2 t} + ce^{-\lambda_3 t} + de^{-\lambda_4 t}) \dots\dots\dots(7),$$

where

$$a = \frac{\lambda_1 \lambda_2 \lambda_3}{(\lambda_2 - \lambda_1)(\lambda_3 - \lambda_1)(\lambda_4 - \lambda_1)}, \quad b = \frac{\lambda_1 \lambda_2 \lambda_3}{(\lambda_1 - \lambda_2)(\lambda_3 - \lambda_2)(\lambda_4 - \lambda_2)},$$

$$c = \frac{\lambda_1 \lambda_2 \lambda_3}{(\lambda_1 - \lambda_3)(\lambda_2 - \lambda_3)(\lambda_4 - \lambda_3)}, \quad d = \frac{\lambda_1 \lambda_2 \lambda_3}{(\lambda_1 - \lambda_4)(\lambda_2 - \lambda_4)(\lambda_3 - \lambda_4)}.$$

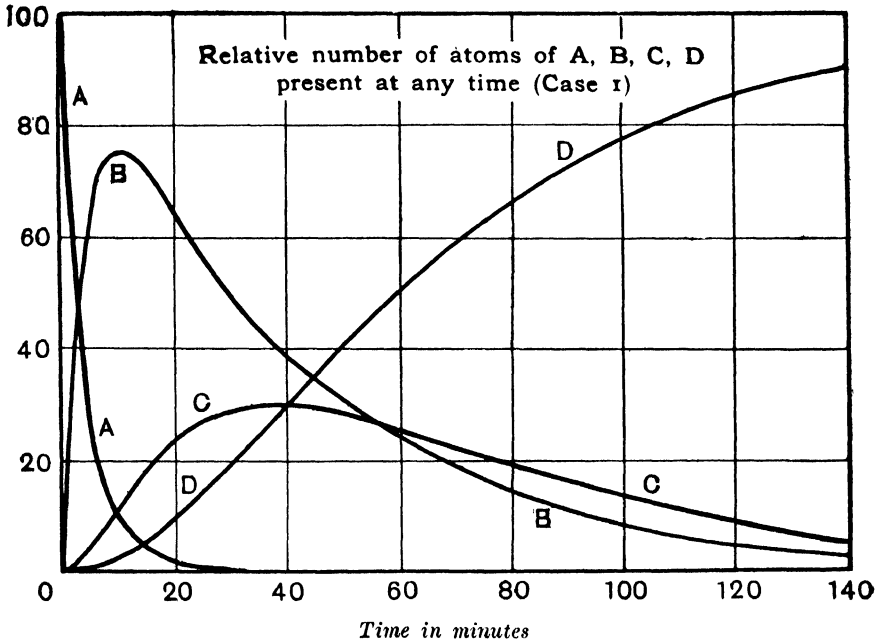

Fig. 99.

The method of solution of the general case of n products has been given in a symmetrical form by Bateman*. The amount of the n th product $N(t)$ at the time t is given by

$$N(t) = c_1 e^{-\lambda_1 t} + c_2 e^{-\lambda_2 t} \dots c_n e^{-\lambda_n t} \dots\dots\dots(8),$$

* Bateman, *Proc. Camb. Phil. Soc.* 15, p. 423, 1910.

where

$$c_1 = \frac{\lambda_1 \lambda_2 \dots \lambda_{n-1} P_0}{(\lambda_2 - \lambda_1) (\lambda_3 - \lambda_1) \dots (\lambda_n - \lambda_1)},$$

$$c_2 = \frac{\lambda_1 \lambda_2 \dots \lambda_{n-1} P_0}{(\lambda_1 - \lambda_2) (\lambda_3 - \lambda_2) \dots (\lambda_n - \lambda_2)},$$

.....etc.

The variations in the values of P, Q, R, S , with time t after removal of the source are shown graphically in Fig. 99, curves A, B, C and D respectively. The curves are drawn for the practical and important case of the first four products of the active deposit of radium, known as radium A, B, C , and D . The matter is supposed to consist initially only of radium A . This corresponds to the case of a body exposed for a few seconds in the presence of the radium emanation. The values of $\lambda_1, \lambda_2, \lambda_3$ are taken as $3.85 \times 10^{-3}, 4.33 \times 10^{-4}, 5.93 \times 10^{-4} (\text{sec.})^{-1}$ respectively corresponding to the half value periods of A, B and C of 3, 26.8 and 19.5 minutes respectively. The half value period of radium D is about 16.5 years. Over the small interval under consideration in the figure, one may suppose that the atoms of radium D suffer no appreciable decrease by transformation. The equation (7) can then be simplified for calculation by putting $\lambda_4 = 0$.

The ordinates of the curves represent the relative number of atoms of the matter A, B, C , and D existing at any time, and the value of P_0 , the original number of atoms of the matter A deposited, is taken as 100. The amount of matter B is initially zero, and in this particular case passes through a maximum about 10 minutes later, and then diminishes with the time. In a similar way, the amount of C passes through a maximum about 35 minutes after removal. After an interval of several hours the amount of both B and C diminishes very approximately according to an exponential law with the time, falling to half value in both cases in 26.8 minutes.

Over the interval considered, the amount of D increases steadily with time, although very slowly at first. A maximum is reached when B and C have disappeared. Finally the amount of D would decrease exponentially with the time with a period of 16.5 years.

160. CASE 2. A primary source supplies the matter *A* at a constant rate and the process has continued so long that the amount of the products *A*, *B*, *C*, ... has reached a steady limiting value. The primary source is then suddenly removed. It is required to find the amounts of *A*, *B*, *C*, ... remaining at any subsequent time *t*.

In this case, the number n_0 of particles of *A*, deposited per second from the source, is equal to the number of particles of *A* which change into *B* per second, and of *B* into *C*, and so on. This requires the relation

$$n_0 = \lambda_1 P_0 = \lambda_2 Q_0 = \lambda_3 R_0 \dots\dots\dots(9),$$

where P_0 , Q_0 , R_0 are the maximum numbers of particles of the matter *A*, *B*, and *C* when a steady state is reached.

The values of *Q*, *R*, and *S* at any time *t* after removal of the source are given by equations of the same form as (4), (6) and (7) for a short exposure. Remembering the condition that initially

$$P = P_0 = n_0/\lambda_1,$$

$$Q = Q_0 = n_0/\lambda_2,$$

$$R = R_0 = n_0/\lambda_3,$$

it can readily be shown that

$$P = \frac{n_0}{\lambda_1} e^{-\lambda_1 t} \dots\dots\dots(10),$$

$$Q = \frac{n_0}{\lambda_1 - \lambda_2} \left(\frac{\lambda_1}{\lambda_2} e^{-\lambda_2 t} - e^{-\lambda_1 t} \right) \dots\dots\dots(11),$$

$$R = n_0 (ae^{-\lambda_1 t} + be^{-\lambda_2 t} + ce^{-\lambda_3 t}) \dots\dots\dots (12),$$

where

$$a = \frac{\lambda_2}{(\lambda_2 - \lambda_1)(\lambda_3 - \lambda_1)}, \quad b = \frac{\lambda_1}{(\lambda_1 - \lambda_2)(\lambda_3 - \lambda_2)},$$

$$c = \frac{\lambda_1 \lambda_2}{\lambda_3 (\lambda_1 - \lambda_3)(\lambda_2 - \lambda_3)}.$$

Similarly for four changes it can be shown that

$$S = n_0 (ae^{-\lambda_1 t} + be^{-\lambda_2 t} + ce^{-\lambda_3 t} + de^{-\lambda_4 t}) \dots\dots(13),$$

where

$$a = \frac{\lambda_1 \lambda_2}{(\lambda_2 - \lambda_1)(\lambda_3 - \lambda_1)(\lambda_4 - \lambda_1)}, \quad b = \frac{\lambda_1 \lambda_3}{(\lambda_1 - \lambda_2)(\lambda_3 - \lambda_2)(\lambda_4 - \lambda_2)},$$

$$c = \frac{\lambda_1 \lambda_2}{(\lambda_1 - \lambda_3)(\lambda_2 - \lambda_3)(\lambda_4 - \lambda_3)}, \quad d = \frac{\lambda_1 \lambda_2 \lambda_3}{(\lambda_1 - \lambda_4)(\lambda_2 - \lambda_4)(\lambda_3 - \lambda_4)}.$$

Bateman has pointed out that the solutions for case 2 can be derived from case 1. This is obvious when it is remembered that the amount of C , for example, remaining after a definite interval t is made up of (1) supply from A through B , (2) supply from B , (3) part of C remaining. Remembering that the amounts of A , B , C initially present are n_0/λ_1 , n_0/λ_2 , n_0/λ_3 respectively, the solution can be written down with the aid of equations (5) and (6).

The relative numbers of atoms of P , Q , R existing at any time are shown graphically in Fig. 100 curves A , B , C respectively.

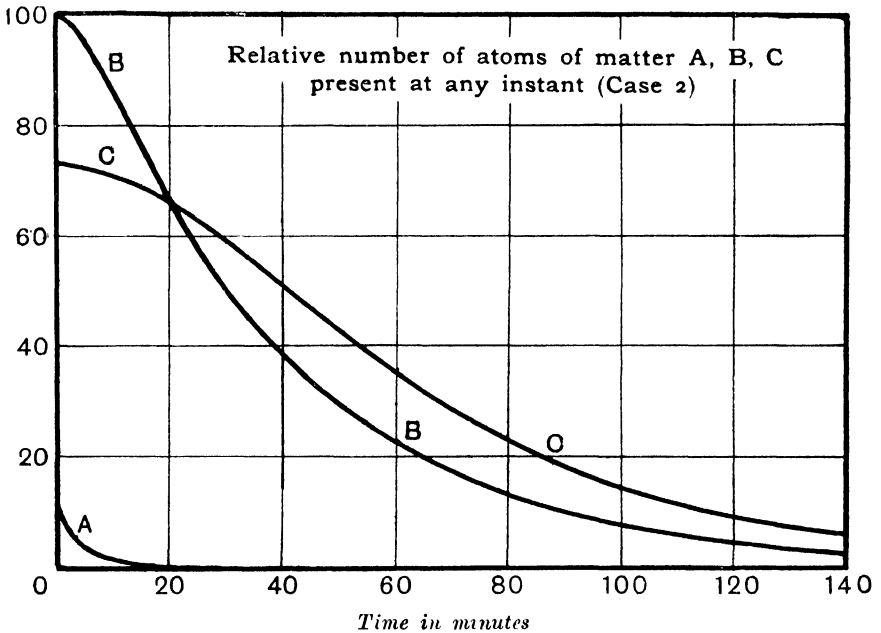

Fig. 100.

The number of atoms Q_0 is taken as 100 for comparison, and the values of λ_1 , λ_2 , λ_3 are taken corresponding to the 3, 26.8, and 19.5 minute changes in the active deposit of radium. It should be pointed out that the curves show the variation of A , B and C on removal of a body which has been exposed for a long interval to a *constant* amount of emanation. The curves are slightly different for the practical case where the body is exposed in a *decaying* source of emanation.

A comparison with Fig. 99 for a short exposure brings out very clearly the variation in the relative amounts of P , Q , R corresponding to cases 1 and 2. In case 2 the amount of R decreases at first very slowly. This is a result of the fact that the supply of C due to the breaking up of B at first nearly compensates for the breaking up of C . The values of Q and R after several hours decrease exponentially, falling to half value in 26·8 minutes.

A consideration of the formulae for cases 1 and 2 brings out the interesting point that the amount of C ultimately decreases according to an exponential law with the period of 26·8 minutes, which is characteristic of radium B and not of radium C. This is an expression of a general result that the product of longest period ultimately governs the decay curve in all cases.

161. CASE 3. *Suppose that a primary source has supplied the matter A at a constant rate for any time T and is then suddenly removed. Required the amounts of A, B, C at any subsequent time.*

Suppose that n_0 particles of the matter A are deposited each second. After a time of exposure T , the number of particles P_T of the matter A present is given by

$$P_T = n_0 \int_0^T e^{-\lambda_1 t} dt = \frac{n_0}{\lambda_1} (1 - e^{-\lambda_1 T}).$$

At any time t , after removal of the source, the number of particles P of the matter A is given by

$$P = P_T e^{-\lambda_1 t} = \frac{n_0}{\lambda_1} (1 - e^{-\lambda_1 T}) e^{-\lambda_1 t} \dots\dots\dots(14).$$

Consider the number of particles $n_0 dt$ of the matter A produced during the interval dt . At any later time t , the number of particles dQ of the matter B , which result from the change in A , is given (see equation 5) by

$$dQ = \frac{n_0 \lambda_1}{\lambda_1 - \lambda_2} (e^{-\lambda_2 t} - e^{-\lambda_1 t}) dt = n_0 f(t) dt \dots\dots\dots(15).$$

After a time of exposure T , the number of particles Q_T of the matter B present is given by

$$Q_T = n_0 [f(T) dt + f(T - dt) dt + \dots + f(0) dt]$$

$$= n_0 \int_0^T f(t) dt.$$

If the body is removed from the emanation after an exposure T , at any later time t the number of particles of B is in the same way given by

$$Q = n_0 \int_t^{T+t} f(t) dt.$$

It will be noted that the method of deduction of Q_T and Q is independent of the particular form of the function $f(t)$.

Substituting the particular value of $f(t)$ given in equation (15) and integrating, it can readily be deduced that

$$\frac{Q}{Q_T} = \frac{ae^{-\lambda_2 t} - be^{-\lambda_1 t}}{a - b} \dots \dots \dots (16),$$

where
$$a = \frac{1 - e^{-\lambda_2 T}}{\lambda_2}, \quad b = \frac{1 - e^{-\lambda_1 T}}{\lambda_1}.$$

In a similar way, the number of particles R of the matter C present at any time can be deduced by substitution of the value of $f(t)$ in equation (6).

$$\frac{R}{R_T} = \frac{ae^{-\lambda_1 t} + be^{-\lambda_2 t} + ce^{-\lambda_3 t}}{a + b + c} \dots \dots \dots (17),$$

where
$$a = \frac{\lambda_2}{(\lambda_2 - \lambda_1)(\lambda_3 - \lambda_1)} (1 - e^{-\lambda_1 T}),$$

$$b = \frac{\lambda_1}{(\lambda_1 - \lambda_2)(\lambda_3 - \lambda_2)} (1 - e^{-\lambda_2 T}),$$

$$c = \frac{\lambda_1 \lambda_2}{\lambda_3 (\lambda_1 - \lambda_2)(\lambda_3 - \lambda_2)} (1 - e^{-\lambda_3 T}).$$

In a similar way the amount of any product may be written down.

162. CASE 4. *The matter A is supplied at a constant rate from a primary source. Required to find the number of particles of A, B, C at any subsequent time t, when initially A, B, C are absent.*

The solution can be simply obtained in the following way. Suppose that the conditions of case 2 are fulfilled. The products A, B, C are in radio-active equilibrium and let P_0, Q_0, R_0 be the number of particles of each present. Suppose the source is removed. The values of P, Q, R at any subsequent time are given by equations (10), (11) and (12) respectively. Now suppose the source, which has been removed, still continues to supply A at the same constant rate and let P_1, Q_1, R_1 be the number of particles of A, B, C again present with the source at any subsequent time. Now we have seen, that the rate of change of any individual product, considered by itself, is independent of conditions and is the same whether the matter is mixed with the parent substance or removed from it. Since the values of P_0, Q_0, R_0 represent a steady state where the rate of supply of each kind of matter is equal to its rate of change, the sum of the number of particles A, B, C present at any time with the source, and in the matter from which it was removed, must at all times be equal to P_0, Q_0, R_0, \dots , that is

$$\begin{aligned} P_1 + P &= P_0, \\ Q_1 + Q &= Q_0, \\ R_1 + R &= R_0. \end{aligned}$$

This must obviously be the case, for otherwise there would be a destruction or creation of matter by the mere process of separation of the source from its products; but, by hypothesis, neither the rate of supply from the source, nor the law of change of the products, has been in any way altered by removal.

Substituting the values of P, Q, R from equations (10), (11), and (12), we obtain

$$\frac{P_1}{P_0} = 1 - e^{-\lambda_1 t} \dots\dots\dots(18),$$

$$\frac{Q_1}{Q_0} = 1 - (\lambda_1 e^{-\lambda_2 t} - \lambda_2 e^{-\lambda_1 t}) / (\lambda_1 - \lambda_2) \dots\dots\dots(19),$$

$$\frac{R_1}{R_0} = 1 - \lambda_3 (a e^{-\lambda_1 t} + b e^{-\lambda_2 t} + c e^{-\lambda_3 t}) \dots\dots\dots(20),$$

\dots\dots\dotsetc.,

where $a, b,$ and c have the values given after equation (12). The curves representing the increase of P, Q, R are thus, in all cases

complementary to the curves shown in Fig. 100. The sum of the ordinates of the two curves of rise and decay at any time is equal to 100. We have already seen examples of this in the case of the decay and recovery curves of Ur X and Th X.

163. Secular and transient equilibria. The theory of cases 2 and 4 have been worked out on the assumption that there is a permanent equilibrium between the successive products of transformation. This is impossible to realise completely in practice since the amount of every radio-active substance is always decreasing with time. No sensible error, however, is introduced when the *primary* source is transformed so slowly that there is no appreciable change in its amount in an interval of time required for the later products to attain approximate equilibrium with the primary source. This condition is very nearly fulfilled, for example, in the case of radium and the radium emanation, where the period of the former is 2000 years, and of the latter 3.85 days. The latter approaches its equilibrium value very closely after the emanation has been supplied continuously from the radium for an interval of 2 months. During this time, the fraction of the radium transformed is only about 6/100,000, so that for the interval under consideration, it may be regarded as a constant source without sensible error. It is convenient to apply the term "secular" equilibrium to this and similar cases.

Consider next the important case of the emanation and its products, radium A, B and C. A stage of equilibrium between the emanation and its products is reached after the emanation has been stored about 5 hours, and the amount of each of the products then decays exponentially with the period of the emanation. This is a case of "transient" equilibrium, for the amounts of the products are changing comparatively rapidly. The amounts of radium A, B and C at any subsequent time are always appreciably greater than the amounts for secular equilibrium if the supply of emanation were kept constant.

Consider, for example, the case of radium C. Using the notation of Section 159, the number of atoms S of radium C at any time t is given by

$$S = ae^{-\lambda_1 t} + be^{-\lambda_2 t} + ce^{-\lambda_3 t} + de^{-\lambda_4 t},$$

where $\lambda_1, \lambda_2, \lambda_3, \lambda_4$ are the constants of transformation of the emanation, radium A, B and C respectively. Since the value of λ_1 is much smaller than λ_2, λ_3 or λ_4 , by making t very large only the first term becomes important, *i.e.* when t is large

$$S = \frac{\lambda_1 \lambda_2 \lambda_3 P_0}{(\lambda_2 - \lambda_1)(\lambda_3 - \lambda_1)(\lambda_4 - \lambda_1)} e^{-\lambda_1 t} \dots\dots\dots(21).$$

For the instant t , the amount S_0 of radium C which would be in secular equilibrium with the emanation is given by

$$\lambda_1 P_0 e^{-\lambda_1 t} = \lambda_4 S_0.$$

Consequently
$$\frac{S}{S_0} = \frac{\lambda_2 \lambda_3 \lambda_4}{(\lambda_2 - \lambda_1)(\lambda_3 - \lambda_1)(\lambda_4 - \lambda_1)} = 1.0089$$

when the values of λ are substituted in the equation.

This shows that the amount of radium C present is 0.89 per cent. *greater* than corresponds to secular equilibrium. For example, consider a certain quantity of emanation existing alone by itself and an equal quantity of emanation associated with the amount of radium with which it is in equilibrium. The amount of radium C in transient equilibrium with the emanation in the first case is .89 per cent. greater than in the latter. Now the γ radiation (after passing through 2 cms. of lead) from radium in equilibrium or from a tube filled with radium emanation arises mainly from radium C. If the γ radiation from the emanation tube is compared with that due to a standard radium preparation through 2 cms. of lead, the amount of emanation actually present in the tube at the time of observation is obviously .89 per cent. *less* than that deduced by direct measurements of the γ ray effects.

In a similar way, it can be shown that the amount of radium A and radium B present are .054 and .54 per cent. greater respectively than the true equilibrium amount.

It is clear from these considerations that the decay curve of the active deposit after a long exposure to a source of radium emanation stored by itself does not follow exactly the theory given in Section 160, for the relative ratios of radium A, B and C above the true equilibrium are as 1.00054 : 1.0054 : 1.0089. It is obvious, however, that the differences from the theoretical curves given in Fig. 100 will be small.

The general question of the ratios which the amounts of substances in radio-active equilibrium bear to one another has been examined by Mitchell* and Lotka† for any number of successive changes. If the successive products have periods $T_1, T_2 \dots T_n$ of which T_1 has a period long compared with any of the others, then it can be simply shown from equations analogous to (21) that the ratio of the amount of the n th product to the first

$$\begin{aligned}
 &= \frac{T_n}{T_1} \left(1 + \frac{T_2}{T_1}\right) \left(1 + \frac{T_3}{T_1}\right) \dots \left(1 + \frac{T_n}{T_1}\right) \\
 &= \frac{T_n}{T_1} \cdot \frac{(T_1 + T_2 + \dots + T_n)}{T_1}.
 \end{aligned}$$

This question is of interest in considering the relative quantities of various radio-active substances in very old uranium minerals. These arise from uranium which is half transformed in about 6×10^9 years. The period of radium (2000 years) and of ionium (possibly 10^6 years) are so short compared with uranium, that secular equilibria should be reached in minerals about 10 million years old, and the ratio of the amount of the n th to the first product is practically T_n/T_1 . The case of uranium itself is of special interest and will be considered later in Section 171.

164. Application to some practical cases. In the analysis of radio-active transformations and in radio-active problems generally, frequent use has been made of the calculations previously discussed. It may be of value and of interest to consider the application of the general theory to several of the great number of problems to which it is applicable.

Growth of radium D and polonium (radium F) from radium. Suppose that radium initially deprived of all its products is placed in a closed vessel. The successive transformations occurring are shown below with the half value period of each product added.

Radium	Emanation	Rad. A	B	C	D	E	F
2000 years	3.85 days	3 min.	26.8 min.	19.5 min.	16.5 years	5 days	136 days

* Mitchell, *Phil. Mag.* 21, p. 40, 1911.

† Lotka, *Phil. Mag.* 22, p. 353, 1911.

The complete calculation of the amount of radium D or radium F present at any time t later would be very intricate, since it involves a large number of successive changes. In practice, however, if we are considering a time measured by days, the products A, B, C may be omitted without sensible error, and the emanation may be supposed to change directly into D.

If P_0 be the initial number of atoms of radium, the number R of atoms of radium D is obtained at once from equation (6), section 159, and is given by

$$R = P_0 (ae^{-\lambda_1 t} + be^{-\lambda_2 t} + ce^{-\lambda_3 t}),$$

where $\lambda_1, \lambda_2, \lambda_3$ refer to radium emanation and radium D respectively.

Noticing that λ_2 is very large compared with λ_1 and λ_3 , the values of a, b, c given after equation (6) reduce to

$$a = \lambda_1/\lambda_3 - \lambda_1, \quad b = \lambda_1/\lambda_2, \quad c = \lambda_1/\lambda_1 - \lambda_3.$$

Substituting the values of $\lambda_1, \lambda_2, \lambda_3$,

$$R = \cdot 00833P_0 (e^{-\lambda_1 t} - e^{-\lambda_2 t} + \cdot 00063e^{-\lambda_3 t}).$$

The third term must be retained in calculations for the first few weeks, since the first and second terms initially nearly cancel out. The curve showing the variation of R with time is similar in general shape to curve DD , Fig. 99. The amount of R rises slowly for the first few days, then increases nearly proportionally with the time for several years. R reaches half value in about 16 years, passes through a maximum in 81 years and finally decays according to the first term, viz. $R = \cdot 00833P_0 e^{-\lambda_1 t}$, showing that the ratio of the number of atoms of radium D and radium present at any subsequent time is $\cdot 00833$.

In a similar way the amount of polonium at any time may be calculated, but it involves five exponential terms. An approximate calculation can, however, be readily made by supposing that radium changes directly into radium D and radium D into radium F. This corresponds to the theory of three changes given in equation (6), section 159.

By a similar method, the amount of polonium present at any time in a tube filled with a known quantity of radium emanation may be deduced. This calculation has been utilised by Antonoff to determine the period of transformation of radium D.

165. Rayless changes. Certain important cases occur in the analysis of radio-active transformations where one of the products either does not emit rays at all (rayless) or emits such a weak radiation that it is difficult to detect. The presence of such a rayless product can, however, not only be inferred but its period and its physical and chemical properties can be determined by observations on the variations of the activity shown by the succeeding product.

Let us consider, for example, the case where the rayless matter A , initially all of one kind, changes into the matter B which gives out rays. The matter A is supposed to be transformed according to the same law as the radio-active products. Let λ_1 , λ_2 be the constants of change of A and B respectively. If P_0 is the number of particles of A , initially present, we see from the equation (5), section 159, that the number of particles of the matter B present at any time is given by

$$Q = \frac{P_0 \lambda_1}{\lambda_2 - \lambda_1} (e^{-\lambda_1 t} - e^{-\lambda_2 t}).$$

Differentiating and equating to zero, it is seen that the value of Q passes through a maximum at a time T given by the equation

$$\lambda_2 e^{-\lambda_2 T} = \lambda_1 e^{-\lambda_1 T}.$$

For the sake of illustration, we shall consider the variation of the activity of the active deposit of thorium, due to a very short exposure to the emanation.

The active deposit consists of four successive products called thorium A , B , C and D respectively. Thorium A disappears about one second after removal and need not be considered in the calculation. Thorium B then remains, and this gives out a very weak β radiation. B changes into C , which emits α rays, and the end product D emits β and γ rays only.

The half periods of transformation of thorium B , C and D are 10.6 hours, 1 hour, and 3.1 minutes respectively.

The α radiation from the deposit arises entirely from C , and is thus proportional to the amount of C present. If λ_1 , λ_2 are the constants of change of thorium B and C respectively, the amount of C present at any time t is given by equation (5), section 159. The variation of the amount of C , and consequently

of the α radiation with time is shown in Fig. 101. The activity rises to a maximum in 226 minutes and then decays ultimately according to an exponential law with the period of 10.6 hours.

There are several points of interest in connection with an activity curve of this character. The activity, some hours after removal, decays according to an exponential law, not at the rate of the product C , from which the activity rises, but at the same rate as the first rayless transformation. This will always be the case if the rayless product has a slower rate of change than the succeeding active product. Given an activity curve of the character of Fig. 101, we can deduce from it that the first change is not accompanied by rays and also the period of the

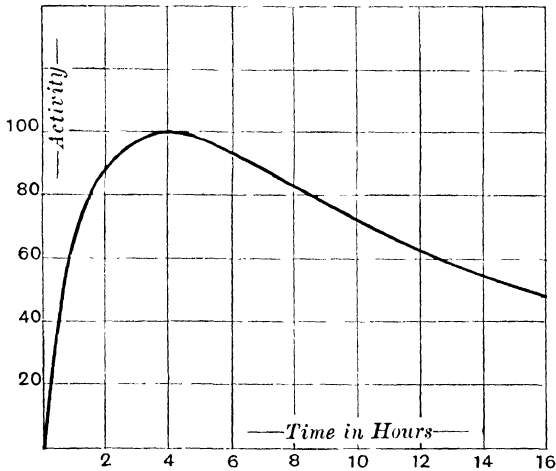

Fig. 101.

two changes in question. We are, however, unable to determine from the curve which of the periods of change refers to the rayless product. It is seen that the curve is unaltered in shape if the values of λ_1 , λ_2 , that is, if the periods of the products are interchanged, for the equation is symmetrical in λ_1 , λ_2 . For example, in the case of the active deposit of thorium, without further data it is impossible to decide whether the period of the first change has a value of 1 hour or 10.6 hours. In such cases the question can be settled only by using some physical or chemical means in order to separate the product B from C , and then testing the rate of decay of their activities separately.

In practice, this can often be effected by electrolysis or by utilizing the difference in volatility of the two products. If now a product is separated from the mixture of B and C which emits α rays and loses its activity according to an exponential law, falling to half value in one hour (and such is experimentally observed), we can at once conclude that the α ray product C has the period of one hour.

The characteristic features of the activity curve shown in Fig. 101 become less marked with increase of the time of exposure of a body to the emanation, that is, when more and more of C is mixed with B at the time of removal. For a long time of exposure, when the products B and C are in radio-active equilibrium, the activity after removal is proportional to Q , where

$$Q = \frac{n_0}{\lambda_1 - \lambda_2} \left(\frac{\lambda_1}{\lambda_2} e^{-\lambda_2 t} - e^{-\lambda_1 t} \right)$$

(see equation (11), section 160). The value of Q , in this case, does not increase after removal, but at once commences to diminish. The activity, in consequence, decreases from the moment of removal, but more slowly than would correspond to an exponential law. The activity finally decays exponentially, as in the previous case, falling to half value in 10.6 hours.

In the previous case we have discussed the activity curve obtained when both the active and inactive product have comparatively rapid rates of transformation. In certain cases which arise in the analysis of the changes in actinium and radium, the rayless product has a rate of change extremely slow compared with that of the active product. This corresponds to the case where the active matter B is supplied from A at a constant rate. The activity curve will thus be identical in form with the recovery curves of Th X and Ur X, that is, the amount N of B at any time t will be represented by the equation $N/N_0 = 1 - e^{-\lambda_2 t}$, where N_0 is the maximum amount of B and λ_2 its constant of change.

166. Analysis of activity curves. In the previous calculations we have seen how the number of atoms of each of the successive products varies with the time under different conditions. It is now necessary to consider how this number is connected with the activity due to a series of successive products.

If N is the number of atoms of a product, the number breaking up per second is λN , where λ is the constant of change. If each atom of each product, in breaking up, emits one α particle, we see that the number of α particles expelled per second from the mixture of products at any time is equal to $\lambda_1 P + \lambda_2 Q + \lambda_3 R + \dots$, where P, Q, R, \dots are the numbers of atoms of the successive products A, B, C, \dots . Substituting the values of P, Q, R already found from any one of the four cases previously considered, the variation with the time of the number of α particles expelled per second can be determined.

The ideal method of measuring the activity of any mixture of radio-active products would be to determine the number of α or β particles expelled from it per second. In practice, however, this is inconvenient and also very difficult experimentally.

Certain practical difficulties arise in endeavouring to compare the activity of one product with another. We shall see later that, in many cases, all of the successive products do not emit α rays. Some give out β and γ rays alone, while there are several almost "rayless" products.

In practice, the relative activity of any individual product at any time is usually determined by measurements of the saturation ionisation current produced between the electrodes of a suitable testing vessel.

Let us consider, for example, the case of a product which emits only α rays. The passage of the α particle through the gas produces a large number of ions in its path. Since the α particles from any individual product are projected with the same velocity under all conditions, the amount of the ionisation produced per second in the testing vessel serves as an accurate means of determining the variation of its activity. No two products of the same series, however, emit α particles with the same velocity. The ionisation due to an α particle depends on its range in air and the latter is different for each product. Thus the relative saturation current, due to two different products in a testing vessel, does not serve as an accurate method for comparing the relative number of α particles expelled per second. The ratio of the currents will in general depend upon the distance between the plates of the testing vessel, and, unless the relative ionisation due to the

average α particle from the two products is known from other data, the comparison of the currents can, at best, be only an approximate guide to the relative number of α particles escaping into the gas.

Some examples will now be considered to show how the factors, above considered, influence the character of the curves of activity obtained under different experimental conditions. For the purpose of illustration, we shall consider the variation of the activity on a body which has been exposed for different times to a constant supply of the radium emanation and then removed. The active deposit on removal consists in general of a mixture of the products radium A, B, and C. The nature of the rays from each product, the time for each product to be transformed to half value, and the value of λ are tabulated below for convenience:—

Product	Rays	T.	λ (sec. ⁻¹)
Radium A	α rays	3 min.	3.85×10^{-3}
Radium B	β, γ rays	26.8 min.	4.33×10^{-4}
Radium C	α, β, γ rays	19.5 min.	5.93×10^{-4}

Since radium B does not give out α rays, the number of α particles expelled from the active deposit per second is proportional to $\lambda_1 P + \lambda_3 R$. The activity measured by the α rays, using the electrical method, is thus proportional at any time to $\lambda_1 P + K\lambda_3 R$, where K is a constant which represents the ratio of the average number of ions, produced in the testing vessel, by an α particle from C compared with that from an α particle emitted by A. For this particular case, K is for some arrangements nearly unity. Taking $K = 1$, the activity at any time after removal is proportional to $\lambda_1 P + \lambda_3 R$.

CASE I. We shall first consider the activity curve for a short exposure to the radium emanation. The relative values of P , Q , and R at any time corresponding to this case have been graphically shown in Fig. 99. The activity measured by the α rays at any time will be the sum of the activities due to A and C separately.

Let curve AA (Fig. 102) represent the activity due to A. This decreases exponentially, falling to half value in 3 minutes. In order to show the small activity due to C clearly in the figure, the activity due to A is plotted after an interval of 6 minutes,

when the activity has been reduced to 25 per cent. of its maximum value. The activity due to C is proportional to $\lambda_3 R$, and in order to represent the activity due to C on the same scale as A, it is necessary to reduce the scale of the ordinates of curve CC in Fig. 99 in the ratio $\frac{\lambda_3}{\lambda_1}$.

The activity due to C is thus represented by the curve CCC, Fig. 102. The total activity is thus represented by a curve A + C whose ordinates are the sum of the ordinates of A and C.

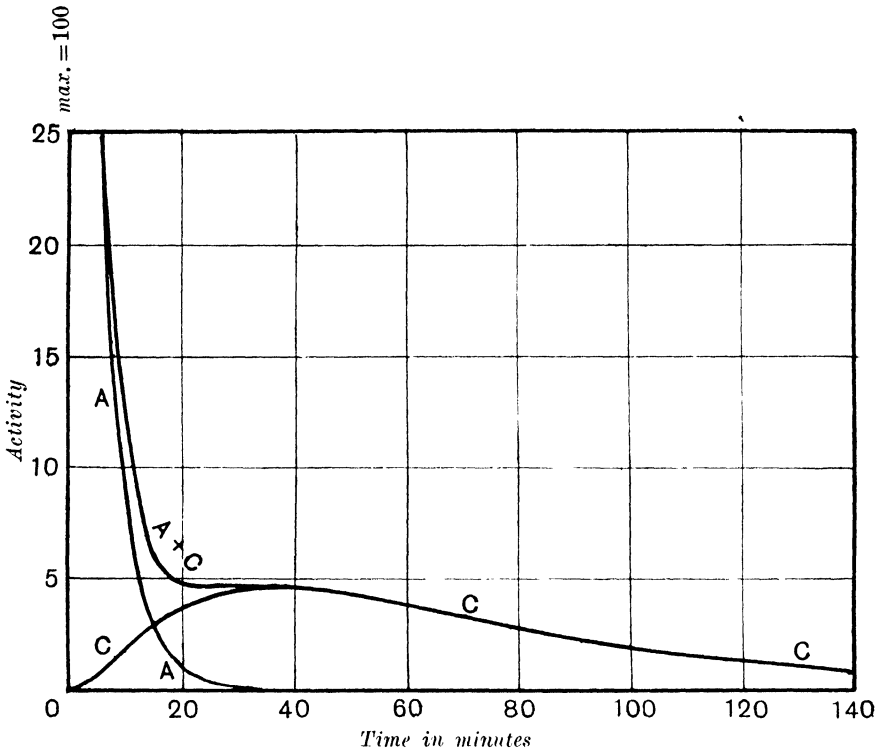

Fig. 102.

This theoretical activity curve is very similar in its general features to the curve found experimentally when the activity is measured by the α rays.

CASE 2. The activity curve for a long exposure to the emanation will now be considered. The activity after removal of A and C is proportional to $\lambda_1 P + \lambda_3 R$, where the values of P and R are graphically shown in Fig. 100 by the curves AA, CC.

Initially after removal, $\lambda_1 P_0 = \lambda_3 R_0$, since A and C are in radioactive equilibrium, and the same number of particles of each product breaks up per second. The activity due to A alone is shown in curve AA, Fig. 103. The activity decreases exponentially, falling to half value in 3 minutes. The activity due to C at any time is proportional to R , and is initially equal to that of A. The activity curve due to C is thus represented by the curve CC, which is the same curve as the curve CC of Fig. 100. The activity of A and C together is represented by the curve A + C (Fig. 103), where the ordinates are equal to the sum of the ordinates of the curves A and C. This theoretical curve is seen to be very similar in shape to the experimental curve showing

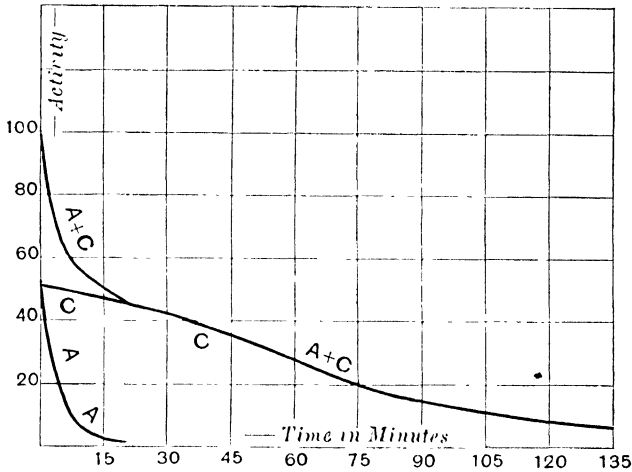

Fig. 103.

the decay of activity of the active deposit for a long exposure measured by the α rays.

The products B and C emit γ rays, but the rays from the former are far more easily absorbed. By passing the rays through a screen of lead 2 cms. thick, the γ rays from radium B are stopped, and the effect in an ionisation vessel is then due to the γ rays from radium C alone. Under these conditions, the activity will be proportional to the amount of C present at any time, that is, to the value of R at any time. For a long exposure, the variation of activity with time measured by the γ rays will thus be represented by the curve CC of Fig. 103, where the

ordinates represent activity. This curve is of importance in determining the amount of radium C by γ ray measurements.

167. Application to a case in thorium. We shall next consider a special case of importance connected with the transformation of thorium, which has several points of interest. The initial changes in thorium, discussed in Chapter XVI, are shown diagrammatically below and the half-value period of transformation of each product is added.

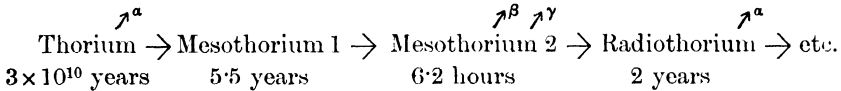

It will be shown in Chapter XVI that in the process of separation of thorium from thorium minerals, mesothorium 1 is completely *removed* from the thorium, while the whole of the radiothorium *remains* with the thorium.

We shall first consider the variation of the amount of radiothorium in the thorium preparations at different times after separation of the mesothorium. It is supposed that initially the thorium in the mineral is in secular equilibrium with all its products.

The amount of radiothorium existing at any time may be supposed to be made up of two parts, (1) the amount of old radiothorium remaining with the thorium, supposing it to decay with its period of 2 years from the moment that the mesothorium is separated, and (2) the amount of new radiothorium formed from the thorium in the interval under consideration.

Since thorium has a very long period of transformation compared with its products, it may be supposed to break up at a constant rate. Since mesothorium 2 has a very short period of transformation compared with mesothorium 1, the former product may without sensible error be omitted from the calculations, and mesothorium 1 may be supposed to form radiothorium directly. Suppose n_0 atoms of thorium break up per second. If P_0 , Q_0 are the number of atoms of mesothorium and radiothorium respectively in equilibrium with the thorium, then

$$n_0 = \lambda_1 P_0 = \lambda_2 Q_0,$$

where λ_1 , λ_2 are their respective constants.

The amount Q_1 of radiothorium due to (1) at a time t after separation is given by $Q_1/Q_0 = e^{-\lambda_2 t}$. The amount Q_2 of radiothorium formed afresh is given by equation (19), section 162,

$$Q_2/Q_0 = 1 - (\lambda_1 e^{-\lambda_2 t} - \lambda_2 e^{-\lambda_1 t})/(\lambda_1 - \lambda_2).$$

The variation of Q_1 with time is shown in Fig. 104, Curve I, Q_0 being taken as 100. The variation of Q_2 with time is shown on the same scale in Curve II. The amount of radiothorium present with the thorium is equal to $Q_1 + Q_2$, and is thus obtained by adding the ordinates of Curves I and II. The resultant curve

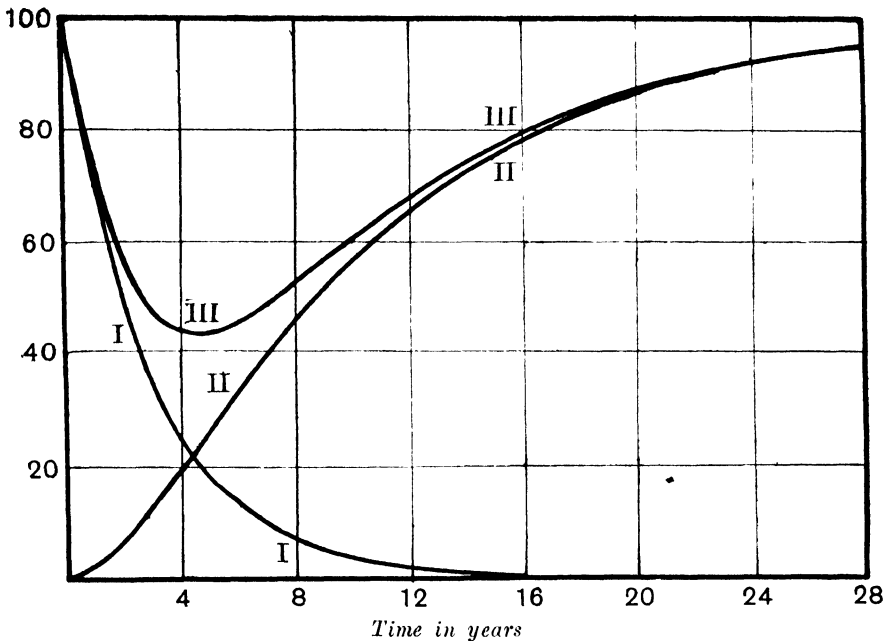

Fig. 104.

is shown in Curve III. It is seen from Fig. 104 that the amount of radiothorium present with the thorium decreases with the time, passes through a minimum after 4.6 years and then gradually rises towards the equilibrium value 100.

Mesothorium emits only β and γ rays while thorium, radiothorium and four of its successive products emit α rays. Since the periods of transformation of the products of radiothorium are short compared with the period of radiothorium, we may without much error suppose radiothorium to be in equilibrium with its

products, and that *five* α particles are expelled from the radiothorium series in equilibrium with thorium for *one* from thorium itself.

The number of α particles emitted from the thorium together with its products at any time after separation can be easily deduced. Suppose that the number of α particles emitted from the thorium series when in equilibrium is 100. Of this number, the thorium itself provides $1/6$ and the radiothorium series $5/6$. The number of α particles emitted from the thorium is shown by the straight line in Fig. 105, parallel to the axis of abscissae.

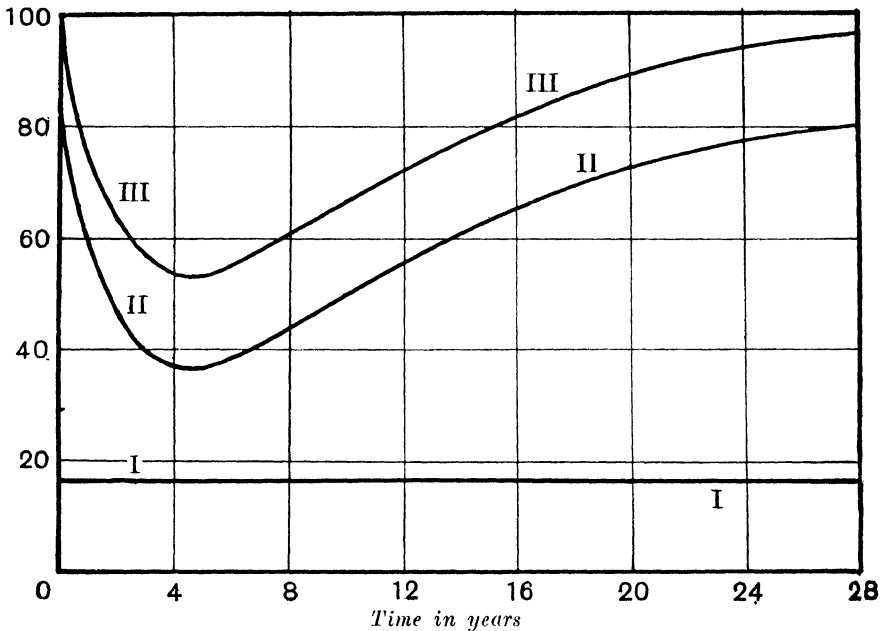

Fig. 105.

The number due to radiothorium is deduced from Curve III, Fig. 104, by multiplying the ordinates by $5/6$ and is shown in Curve II, Fig. 105. The resultant number of α particles is shown in Curve III by adding the ordinates of the two curves. This resultant curve showing the number of α particles passes through a minimum at the same time as the Curve III, Fig. 104 showing the amount of radiothorium alone.

If the variation of activity is measured by ionisation methods the curves obtained will be similar in shape but the drop in the

resultant curve will depend to some extent on the relative ionisation of an α particle from thorium itself, and from radiothorium and each of its α ray products.

It will be seen in Chapter XVI that the period of mesothorium assumed in these calculations has been deduced with the aid of theory from a knowledge of the period of radiothorium and from the variation of α ray activity of thorium preparations with age.

168. In this chapter we have considered the variation with time, under different conditions, of the number of atoms of the successive products, when the period and number of the changes are given. It has been seen that the activity curves to be expected under various conditions can be readily deduced from the simple theory. In practice, however, the investigator has been faced with the much more difficult inverse problem of deducing the period, number, and character of the products, by analysis of the activity curves obtained under various conditions.

In the case of radium, where at least seven distinct changes occur, the problem has been one of considerable difficulty, and a solution has only been possible by devising special physical and chemical methods for isolating some of the products.

In the following chapter the theory of successive changes will be applied to the analysis of radio-active matter, and will be shown to account satisfactorily for the complicated processes which take place.

CHAPTER XII.

URANIUM, IONIUM AND THE ORIGIN OF RADIUM.

169. Uranium and its products. Uranium has the highest atomic weight 238.5 of any known element. It is ordinarily separated from the mineral uraninite, where it is always found associated with the radio-active substances ionium, radium and actinium. Uranium occupies a very important place in the transformations which will be studied in the next three chapters, for it will be shown that uranium is the primary source from which ionium, radium and actinium are derived. In order to bring out clearly the main points that will be discussed in some detail in this chapter, it is necessary first of all to consider the relations that should exist between uranium and its transformation products. The evidence so far obtained indicates that the following series of transformations takes place :

Uranium → Ur X → Ionium → Radium and its series of products.

On this scheme, both ionium and radium are to be considered as products of uranium, and ionium is the direct parent of radium. The connection of Ur X with uranium has previously been discussed (Section 122). The most direct and convincing evidence of these relations is obtained from a study of the radio-active constituents of *old* primary uranium minerals, in which no sensible chemical alteration by the action of external agencies has occurred for periods of time measured by geological ages. Under such conditions, equilibrium should have been established between uranium and its products. Supposing, as will be seen to be the case later, that uranium is transformed very slowly compared with its

products, the number of atoms N_1 , N_2 , N_3 of uranium, ionium and radium respectively in the mineral should be connected by the relation $\lambda_1 N_1 = \lambda_2 N_2 = \lambda_3 N_3$, where λ_1 , λ_2 , λ_3 are the radio-active constants of the three substances mentioned. Then

$$N_2/N_1 = \lambda_1/\lambda_2, \quad N_3/N_1 = \lambda_1/\lambda_3, \quad N_3/N_2 = \lambda_2/\lambda_3;$$

or in other words, the ratio of the number of atoms of each substance compared with that of uranium is inversely proportional to the ratio of the constants of transformation. It follows from this that the amount of ionium and of radium in any old mineral should be directly proportional to the amount of uranium present. This has been most completely tested in the case of radium (Section 177), and it has been found that there is the direct proportionality to be expected from the theory. This relation cannot be expected to hold for relatively new minerals, or for those minerals which have undergone chemical alteration. The whole question is discussed in detail later in Section 177. Boltwood has shown that the amount of ionium separated from a mineral is always proportional to its content of uranium.

There is another and possibly more direct experimental method of attacking this problem. If uranium, ionium and radium are genetically connected and in equilibrium, the same number of atoms of each must break up per second. Since the number of atoms of each product transformed per second is proportional to the radiation from it, it follows that the relative energies of the radiations emitted by the uranium, ionium and radium contained in all old minerals should be the same. In addition, the energy emitted by uranium and by all its products in a mineral should be in a constant ratio to the energy emitted by uranium itself.

This question has been carefully examined by McCoy* using the electric method. In order to avoid corrections due to absorption of the radiations in the mineral itself, it is necessary to employ exceedingly thin films of active matter obtained by grinding the mineral to an impalpable powder. In order to obtain measurements which will be comparable under all conditions, it is desirable to use an ionisation vessel or electroscope chamber of

* McCoy, *Ber. d. D. Chem. Ges.* **37**, p. 2641, 1904; *Phil. Mag.* **11**, p. 176, 1906; *Journ. Amer. Chem. Soc.* **29**, p. 1698, 1907.

sufficient dimensions to absorb all the α rays in the gas before they strike the walls. Under these conditions, the energy of the α particles emitted from each product is directly proportional to the ionisation they produce. In this way McCoy found that the total activity of a mineral was in all cases proportional to the total activity of the uranium contained in it. McCoy (*loc. cit.*) and Boltwood* have determined the ratio of the total activity of the mineral to that of the uranium under the conditions mentioned above, and the latter found a value 4.64. In making this determination, it is necessary to correct the observed activity of the mineral for the loss of radium emanation which diffuses from it.

It is now necessary to consider how the activity is divided amongst the various products. For this purpose, it is necessary to separate each of the products ionium, radium and polonium from the mineral and determine its activity separately. The relative values of the activity due to radium and its short lived products, viz. emanation, radium A, B and C can be determined separately. As a result of a number of careful experiments on different minerals, Boltwood (*loc. cit.*) gives the following numbers, which refer to the relative ionisations produced when the α rays are completely stopped in the gas of the testing vessel.

Products	Relative total activity	Range of α particles at 15° C.
Uranium	1.00	average range 2.7 cm.
Ionium	0.34	3.00 cm.
Radium	0.45	3.30 "
Ra. Emanation	0.54	4.16 "
Radium A	0.62	4.75 "
Radium B	0.04	—
Radium C	0.91	6.94 "
Ra. F (polonium)	0.46	3.77 "
Actinium and its products	0.28	average range 5.36 cm.

$$\text{Total activity} = 4.64 \times \text{Uranium}$$

In this table several products, viz. Ur X, radium D and radium E are omitted, as they give out only β rays, and the ionisation due to them is very small compared with that due to the α ray products.

* Boltwood, *Amer. Journ. Sci.* 25, p. 269, 1908.

Boltwood found that under the conditions of measurement, the total ionisation due to an α particle was roughly proportional to its range. The range of the α particles at standard pressure and 15° C. from each product are added in the third column for comparison. The values of the activities given by Boltwood for emanation and radium A are transposed as they were based on the assumption that the range of the α particles from the emanation was greater than that for radium A.

It is noteworthy that the five α ray products of actinium, although their average range is greater than that of the five α ray products of radium, only constitute about 9 per cent. of the total activity due to all the latter. For these and other reasons, it has been concluded that actinium cannot be a product in the main uranium series like ionium or radium, but must arise as a side branch (see Section 209).

170. Complexity of uranium. Taking into consideration the range of their α particles, it is seen that ionium, radium and its products, including polonium, each contribute about the activity to be expected if the products are successive and if the same number of α particles are expelled at the disintegration of each atom. The activity of uranium itself is, however, more than twice the activity of radium. Boltwood consequently concluded that the disintegration of uranium contributed at least two α particles for one from ionium or from radium. This important conclusion has been confirmed by Geiger and Rutherford* by counting directly by the scintillation method the number of α particles from films of uranium and films of uranium minerals containing a known quantity of uranium. It was found that each gram of uranium emitted 2.37×10^4 α particles per second, while a mineral in radio-active equilibrium (correcting for loss of emanation) emitted 9.6×10^4 per second per gram of uranium present. Allowing for the presence of a small quantity of actinium, these results show that the mineral emits four times the number of α particles emitted by uranium. Since there are six α ray products in the ionium-radium series, and each breaks up with the emission of one

* Geiger and Rutherford, *Phil. Mag.* **20**, p. 691, 1910; see also J. Brown, *Proc. Roy. Soc. A*, **84**, p. 151, 1910.

α particle per atom, it follows that uranium breaks up with the emission of two α particles.

In order to explain this result, it is necessary to suppose either that (1) the uranium atom in disintegrating emits two α particles simultaneously, or (2) uranium contains two distinct substances in equilibrium, each of which breaks up with the emission of one α particle.

(1) has been disproved by Marsden and Barratt* by testing whether the scintillations from uranium appeared as doubles, using an arrangement similar to that shown in Fig. 48, page 191. No evidence of such doubles was observed. If uranium consisted of two α ray products, it was deduced that the latter must certainly have a life greater than a few seconds.

It therefore seemed probable that uranium itself must consist of two successive components, which are transformed with the emission of α rays. Numerous attempts have been made to reduce the α ray activity of uranium by chemical treatment, but without success. This indicates that the two components present in ordinary preparations of uranium are chemically so allied that none of the ordinary chemical methods are effective in separating them.

There is one indirect method, however, of throwing light on the question. Unless the two components emit α particles with very nearly the same velocity, it should be possible to detect in uranium the presence of two sets of α rays of different ranges by determining the Bragg curve showing the variation of the ionisation of a pencil of α particles along their path. Experiments on this question have been made by Foch† and Friedmann‡; the latter concluded that two sets of α rays were present of ranges 1.6 cms. and 2.7 cms.; but the method of proof deduction of the shorter range was uncertain. The determination of the ionisation curve, due to a narrow pencil of α rays, is very difficult on account of the very weak activity of thin films of uranium. Geiger and Nuttall§, however, have obtained definite evidence that the Bragg

* Marsden and Barratt, *Proc. Phys. Soc.* **23**, p. 367, 1911.

† Foch, *Le Radium*, **8**, p. 101, 1911.

‡ Friedmann, *Wien Ber.* **120**, p. 1361, 1911.

§ Geiger and Nuttall, *Phil. Mag.* **23**, p. 439, 1912.

curve for a narrow pencil of rays differs from that to be expected for a simple α ray product. Their results are shown in Fig. 106 where the ionisation curves due to the α rays from uranium and ionium are given. These two curves were determined under the same conditions. The ionium was mixed with uranium to avoid any possible difference due to absorption of the α rays in the thin film of uranium employed. The dotted line gives the corresponding ionisation curve for a single product, *e.g.* for ionium or

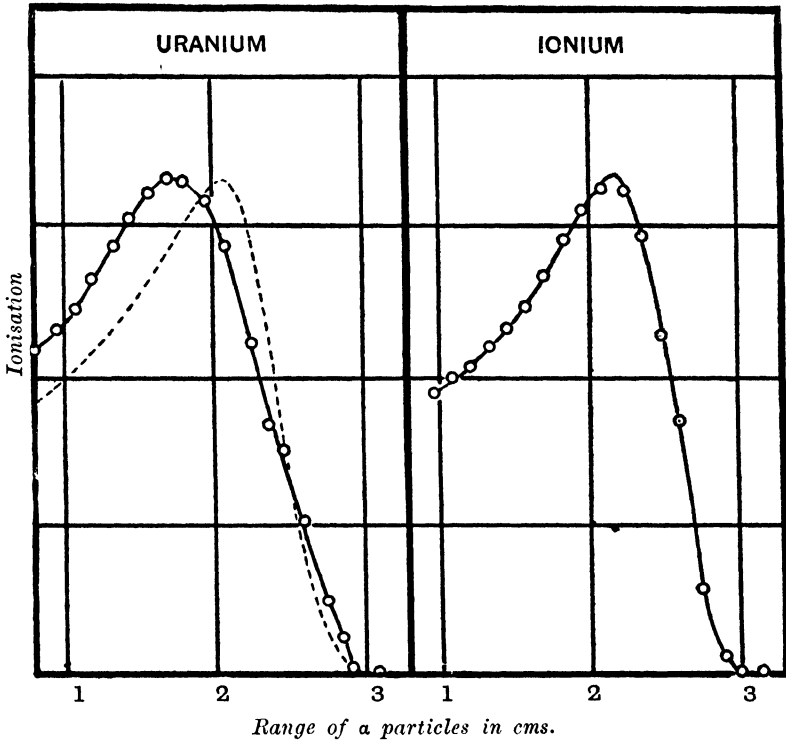

Fig. 106.

polonium. It is seen that the actual curve obtained for uranium is markedly different. Geiger and Nuttall showed that the difference between the dotted and full curves was explained by assuming that two groups of α rays are emitted from uranium, one of range 2.5 cms. and the other of range 2.9 cms. at 15° C. The evidence is thus in conformity with the view that uranium is a complex substance and must contain at least two components

which emit α rays. This conclusion is of great interest from the purely chemical point of view, for no method has yet been devised of separating these two components from each other. It is possible that the chemical properties of the two components are so similar that no separation is possible. Several examples of a similar kind have been observed in radio-active substances. For example, thorium and ionium, mesothorium and radium are chemically inseparable.

171. Period of uranium. The period of transformation of the primary component of uranium can be directly deduced from the number of α particles emitted per gram of uranium. This number was found to be 2.37×10^4 by Geiger and Rutherford. Since one gram of uranium of atomic weight 238 contains 5.2×10^{21} atoms (Section 63), the fraction λ disintegrating per year is 1.44×10^{-10} . From this it follows that the half value period of uranium is 4.8×10^9 years, while the average life is 7×10^9 years. In making this calculation it is assumed that the primary component of uranium emits one α particle per atom. It is of interest to compare these values with those obtained with the aid of quite distinct data. Boltwood has shown experimentally that radium has a half value period of 2000 years (see Section 176), while Rutherford and Boltwood have shown that 3.4×10^{-7} gram of radium is present in equilibrium with one gram of uranium in a mineral. Since the same number of α particles is emitted from each per second

$$\lambda_1 N_1 (\text{for uranium}) = \lambda_2 N_2 (\text{for radium}).$$

In this case N_1 , N_2 refer to the number of *atoms* of uranium and radium present. Taking N_1 to correspond to one gram of uranium and $N_2 = \frac{238}{226} \times 3.4 \times 10^{-7} N_1$ to correspond to 3.4×10^{-7} gram of radium of atomic weight 226, $T_1/T_2 = \lambda_2/\lambda_1 = 2.8 \times 10^6$, where T_1 , T_2 are the half value periods of uranium and radium respectively. Consequently $T_1 = 5.6 \times 10^9$ years. This is in fair agreement with the number 4.8×10^9 years deduced by direct counting of the α particles.

It is of interest to calculate the effect on the relative number of α particles if the two components of uranium supposed to be in

equilibrium with each other have periods of the same order of magnitude. It can readily be deduced from the equations given in Section 159 that the number of α particles emitted per second by the first component is $\lambda_1 P_0 e^{-\lambda_1 t}$, and by the second component $\frac{\lambda_1 \lambda_2 P_0 e^{-\lambda_1 t}}{\lambda_2 - \lambda_1}$, where P_0 is the number of atoms of the first component initially present, and λ_1, λ_2 are the constants of transformation of the two components. It should be pointed out that if the periods of transformation of the two components are of the same order of magnitude equilibrium would only be reached for an interval of time long compared with the age of the oldest known uranium mineral. This difficulty would be removed, however, if the uranium minerals known to us were supposed to be formed from uranium deposits in which equilibrium between the two components had been reached.

Remembering that the number of α particles emitted by radium in a mineral must be equal to that emitted by the *second* component, it is seen that the ratio of the number from the two components of uranium to the number from radium is $2 - T_2/T_1$. If $T_1 = 2T_2$, the fraction becomes 1.5, which is much less than the value 2 observed. We may consequently conclude that the period of the second component cannot be so great as 3×10^9 years. If $T_2 = 3 \times 10^8$ years, the fraction becomes 1.95, which does not differ from 2 by more than the experimental error.* This evidence is of interest in forming a *maximum* estimate of the period of the second component.

It will be shown in Chapter XVIII that a definite relation has been found to exist between the range of the α particles emitted from a product and its period of transformation. On this relation, the shorter the range of the α particle the longer its period. It thus seems probable that the α rays of range 2.5 cms. belong to the first component of longer period, uranium 1, and the rays of range 2.9 cms. to the second component of shorter period, uranium 2. Geiger and Nuttall have calculated from this relation that the period of the second component is about 10^6 years. Assuming the period of uranium 2 is about one million years, the amount in a uranium salt of uranium 2 relative to uranium 1 is 1 to 5000. Since the atomic weight of uranium 2 must be four units less than

uranium I, the presence of the second component does not materially influence the value of the atomic weight of uranium determined by ordinary chemical methods.

172. Uranium X. The ordinary preparations of uranium salts sold as chemically pure usually contain minute quantities of radium and other radio-active substances. By successive fractional crystallisations uranium can be obtained practically free from all radio-active impurities. Ordinary preparations of uranium emit α , β and γ rays. The β and γ rays arise, however, not from uranium itself, but from its transformation product Ur X. Uranium completely freed from Ur X emits only α rays.

Uranium X loses its activity according to an exponential law. Its decay of activity has been examined by Rutherford and Soddy*, and Soddy and Russell†, who have found that the half value period is 22 and 24.6 days respectively. Soddy and Russell separated a large quantity of Ur X from 40 kilograms of uranium nitrate, and examined the decay of activity over a long interval. It was found to decay to zero, for no appreciable residual activity was observed. Ur X emits β and γ rays but no α rays. When no absorbing screens are used, the activity of a thin film of uranium is due mainly to the α rays and shows only a very slight diminution when the Ur X is completely separated from it. On the other hand the photographic action of thick layers of uranium salt is due mostly to the β rays‡. This difference in the two methods initially led to some confusion. The β rays from uranium are fairly penetrating with an absorption coefficient $\mu = 15$ (cms.)⁻¹ in aluminium. It also emits some soft β rays of which $\mu = 500$ (cms.)⁻¹ in aluminium. The ionisation effect of these soft β rays was at first ascribed to the presence of some α rays emitted from Ur X. This was disproved by Levin§ and others.

Eve showed that uranium X emitted γ rays. Soddy investigated this question in detail, using relatively large quantities of

* Rutherford and Soddy, *Phil. Mag.* **5**, p. 441, 1903.

† Soddy and Russell, *Phil. Mag.* **18**, p. 858, 1909.

‡ Soddy, *Trans. Chem. Soc.* **81**, p. 460, 1902.

§ Levin, *Phys. Zeit.* **8**, p. 585, 1907; **9**, p. 655, 1908.

Ur X and showed that, in comparison with the β rays, the γ ray activity was very feeble, although of a penetrating power not much less than that of the γ rays emitted by radium or thorium (see Section 99).

173. Methods of separation of Ur X. One of the simplest methods of concentrating Ur X from uranium is to take advantage of the greater solubility of Ur X in water. This was first observed by Godlewski*. If a layer of crystals of the nitrate is heated and then allowed to cool slowly, so that crystallisation begins at the bottom, the Ur X is gradually pushed to the surface layers. In consequence of this the β ray activity of the upper surface increases rapidly to a maximum when the crystallisation is complete. In the course of some days the Ur X gradually diffuses from the surface layers through the crystals and becomes more uniformly distributed. This interesting property of Ur X was shown by Godlewski to account for the anomalous changes of the β ray activity of uranium first observed by Meyer and v. Schweidler†. Soddy and Russell‡ have utilised this method for the rapid concentration of the Ur X from a large quantity of uranium nitrate. They state that if a hot solution of density 2.05 be allowed to cool, about 2/3 of the salt crystallises and the mother liquor contains about 6/7 of the total amount of Ur X present. By successive crystallisations, it is obvious that the Ur X can be rapidly concentrated.

We have already drawn attention to the methods devised by Crookes (Section 122) for the separation of Ur X. The precipitation of Ur X by adding an excess of ammonium carbonate apparently depends on the presence of small quantities of iron and aluminium as impurities§.

The methods of separation of Ur X have been investigated in detail by Moore and Schlundt||. Various organic solvents were used, and it was found that in many cases the removal of Ur X

* Godlewski, *Phil. Mag.* **10**, p. 45, 1905.

† Meyer and v. Schweidler, *Wien Ber.* **113**, p. 1057, 1904.

‡ Soddy and Russell, *Phil. Mag.* **18**, p. 620, 1909.

§ Soddy and Russell, *Phil. Mag.* **18**, p. 861, 1909.

|| Moore and Schlundt, *Phil. Mag.* **12**, p. 393, 1906.

was much facilitated by the addition of a ferric salt to the solution. In this way, by precipitation with ammonium carbonate, it is generally possible to separate the greater part of Ur X in a single operation, since Ur X attaches itself to the iron precipitate. Lloyd* states that the Ur X can be separated, if necessary, from the iron by dissolving the precipitate in hydrochloric acid and extracting the solution with ether saturated with hydrogen chloride. Under these conditions, Ur X remains in the aqueous layer.

Becquerel† showed that Ur X is entrained when barium is precipitated as sulphate in the solution. The effect of conditions on the separation of Ur X by this method has been examined in detail by Berry‡. The absorption of Ur X by charcoal has also been used as a method of separation. Lampblack is added to the solution and part of the Ur X is separated with it. The carbon is then removed by ignition. Ritzel§ made a careful examination of the amount of Ur X separated by carbon under different conditions, and showed that it must be an absorption phenomenon. He found that if thorium were added to the uranium, the Ur X could not be separated by charcoal. This no doubt is a consequence of the fact that Ur X and thorium have very similar chemical properties. The Ur X in minerals is always removed with the ionium or the thorium, and it has generally been concluded that Ur X must have chemical properties very closely allied to those of thorium. The methods of separation of Ur X described above are quite consistent with this view.

174. Uranium Y. In the course of an examination of Ur X separated from pure uranium salts, Antonoff|| observed that the decay curve of Ur X for the first few days depended on whether it had been separated by precipitating barium in the uranium solution or by adding an iron salt and precipitating it by boiling. These two methods will be called the barium and ferric method

* Lloyd, *Journ. Phys. Chem.* **14**, pp. 476, 509, 1910.

† Becquerel, *C. R.* **131**, p. 137, 1900; **133**, p. 977, 1901.

‡ Berry, *Journ. Chem. Soc.* **97**, p. 196, 1910.

§ Ritzel, *Zeitsch. f. phys. Chem.* **67**, p. 724, 1909.

|| Antonoff, *Phil. Mag.* **22**, p. 419, 1911.

respectively. The decay curve of Ur X separated by the barium method, whether measured by soft or hard β rays, was quite exponential from the beginning with the period of 24 days. On the other hand, Ur X separated by the ferric method decayed more rapidly than the normal for the first few days, when the soft β rays were used for measurement. When a suitable screen was interposed to absorb most of the soft β rays, the decay was again quite normal from the beginning with a period of 24 days. Antonoff found that this anomalous initial decay could be explained by supposing that a new product, called uranium Y (Ur Y) was separated with Ur X by the ferric method but not by the barium method. It was deduced from the decay curve that Ur Y had a half value period of 1.5 days. It emits soft β rays for which $\mu = 300$ (cms.)⁻¹, and also some very easily absorbed rays for which $\mu = 2500$ (cms.)⁻¹ about. Some evidence was found that Ur Y emitted α rays, but in amount very small compared with the β rays. By determining the rise curve due to Ur X from uranium completely deprived of Ur X, it was found that Ur Y could not be the parent product of Ur X. The fact that the amount of Ur Y separated was independent of the age of the uranium preparation, indicated that it was not produced by Ur X. It appears probable that Ur Y is derived directly from the uranium, and is to be regarded as a lateral or branch product of the uranium series. The experiments were difficult on account of the smallness of the β ray activity of Ur Y compared with Ur X. The possibility of a branch product of uranium is of great interest as affording a possible explanation of the origin of actinium.

Danne* found evidence of the existence of another product in Ur X which he called radio-uranium. His experiments, however, have not been repeated, and it is difficult to draw any definite conclusion from the published data. It is essential in such experiments that the uranium should be carefully purified beforehand, for the ordinary commercial preparations contain traces of many radio-active substances.

175. Ionium. The discovery of ionium is intimately connected with the search for the radio-active substance which

* Danne, *C. R.* **148**, p. 337, 1909.

changes directly into radium. The constancy of the ratio between radium and uranium in radio-active minerals indicated that radium was derived from the transformation of uranium. If this were the case, radium should be produced at a rapid and easily measureable rate in uranium solutions. Experiments made to detect this growth of radium (see Section 178) had shown that radium, if produced at all, was generated at a rate very slow compared with that to be anticipated if uranium, or uranium X changed directly into radium. It therefore seemed probable that there must exist an intermediate substance of slow rate of transformation between uranium and radium, for the presence of such a product would greatly retard the initial appearance of radium.

During a search for this missing product, Boltwood* separated from the uranium mineral carnotite an active preparation which he supposed to be actinium. After dissolving the mineral and treatment with hydrogen sulphide, a small quantity of thorium was added, which was precipitated by the addition of oxalic acid. The precipitate so obtained was many times more active than the corresponding amount of thorium. From the analogy between the chemical properties of this active substance and those of actinium as initially described by Debierne, Boltwood at first concluded that the active substance separated with the thorium consisted of actinium. The active preparation, after conversion into the chloride, was dissolved and sealed up in a glass bulb. Two months later, the amount of radium present was determined by the emanation method and found to be 5.7×10^{-9} gr. Ra. The bulb was then sealed up and tested again for radium 193 days later. The amount now present was 14.2×10^{-9} gr. Ra, indicating that during this interval a quantity of radium 8.5×10^{-9} gr. Ra had been formed. This was equivalent to the production of 1.6×10^{-8} gr. Ra by the solution per year. It was consequently concluded that actinium was the parent of radium and the missing intermediate product between uranium and radium.

On repeating the experiments of Boltwood with a preparation of actinium obtained from Dr Giesel, the writer† found that

* Boltwood, *Amer. Journ. Sci.* **22**, p. 537, 1906.

† Rutherford, *Nature*, **75**, p. 270, 1907; **76**, p. 661, 1907; *Phil. Mag.* **14**, p. 733, 1907.

radium was formed rapidly in the preparation. By suitable chemical treatment it was found possible to obtain a preparation of actinium which did not grow radium to an appreciable extent, while another of about equal activity grew radium at a rapid rate. It thus seemed clear that the parent of radium was not actinium but an unknown substance present in the preparation, which could be wholly separated from the actinium. On a further examination of his original preparation, Boltwood found that it was not actinium at all but contained a new active substance which he named *ionium*.

By separating the ionium from a number of minerals, Boltwood* found that the amount of ionium present was proportional to the amount of uranium, and that the rate of production of radium was proportional to the amount of ionium. The latter was found to grow radium at a constant rate over an interval of measurement of 500 days.

Ionium emits α rays of characteristic range 3.0 cms., which is only slightly greater than the range of the α rays from uranium itself. Boltwood found that the ionium preparation showed initially a marked β ray activity. This, however, decayed with the time with a period of about 22 days, showing that it was due to the presence of Ur X separated from the mineral with the ionium.

Keetman†, to some extent independently of Boltwood, investigated the methods of separation of ionium from minerals and made a careful examination of its radio-active and chemical properties. Neither Boltwood nor Keetman was able to separate the ionium from the thorium with which it is always found associated. Keetman converted the thorium containing the ionium into thorium acetylacetone, which melts at 170° C., and sublimes at higher temperatures. It was not found possible to separate the ionium from thorium by fractional distillation in this way. The conclusion that ionium and thorium are so closely allied in chemical properties that no separation appears possible has been confirmed by Auer von Welsbach‡.

* Boltwood, *Amer. Journ. Sci.* **24**, p. 370, 1907; **25**, p. 365, 1908.

† Keetman, *Jahrb. d. Radioakt.* **6**, p. 265, 1909; *Thesis*, Berlin, 1909.

‡ Auer v. Welsbach, *Wien Ber.* **119**, p 1, 1910.

It, therefore, does not seem possible to isolate ionium chemically unless a mineral is found which contains no thorium. The uraninite obtained from Joachimsthal is relatively free from thorium, but even with this mineral the activity of thorium-ionium preparations does not exceed about 5000 times that of uranium. Boltwood* separated from some radio-active residues obtained from Joachimsthal a quantity of about 1.5 gr. of thorium oxide which was found to emit 1.51×10^8 α particles per second. The number of α particles emitted per gram of thorium plus ionium is equivalent to the number from about 4.3 milligrams of radium itself. From these numbers it is possible to calculate a superior-limit to the life of ionium. Assuming that the preparation was pure ionium, it cannot have an average life greater than 230 times that of radium. Since the average life of radium (Section 176) is about 2800 years, the life of ionium cannot be greater than 8×10^5 years. It is probable, however, that the material is mainly thorium, so that the life of ionium must be considerably shorter than this. From considerations based on the growth of radium in uranium (see Section 178) Soddy deduced that ionium cannot have an average life less than 30,000 years. We may consequently conclude that the average life of ionium lies between 3×10^4 and 8×10^5 years, and is probably about 100,000 years. If this be the case, ionium must be present in uranium minerals in about 30 times greater quantity than radium.

The simplest method of fixing accurately the life of ionium would be to determine the activity by the scintillation method of the ionium which is formed in a given time in a known weight of uranium. It can readily be shown from the data given in Section 171 that the number of atoms of ionium formed per year per gram of uranium is 3.7×10^{11} . If the average life of ionium be 100,000 years, 3.7×10^6 α particles are expelled from this quantity per year or about 7 per minute. Consequently 100 grams of uranium should give an easily measurable amount of ionium per year. From the relation between the period of a product and the range of the α particles emitted, Geiger and Nuttall have estimated that the period of ionium is about 200,000 years.

* Boltwood, *Proc. Roy. Soc. A*, **85**, p. 77, 1911.

Both Soddy and Boltwood have found that an α ray substance is separated with uranium X from uranium, but it has not yet been definitely proved to be ionium produced by uranium.

176. Life of radium. The discovery of ionium affords a simple method of determining experimentally the average life of radium itself. Consider a mineral in which the ionium and radium are in radio-active equilibrium. Then $\lambda_1 N_1 = \lambda_2 N_2$ where N_1, N_2 are the number of atoms of ionium and radium and λ_1, λ_2 their respective constants. Suppose the quantity of radium in the mineral has been accurately measured by the emanation method in terms of the ionisation current i_1 of the electroscope. Suppose next the ionium is completely separated from the mineral and the radium formed in it in the time t be measured in terms of the current i_2 of the same electroscope. Then since ionium initially produces radium at the rate of $\lambda_1 N_1$ atoms per second, the amount formed in time t is $\lambda_1 N_1 t$. Consequently

$$i_2/i_1 = \lambda_1 N_1 t/N_2 = \lambda_2 t, \quad \text{or} \quad \lambda_2 = i_2/i_1 t.$$

In this way, Boltwood* showed as the result of a number of experiments that the average life of radium was about 2880 years, and the period about 2000 years. Using the same general method, Keetman (*loc. cit.*) found the period to be 1800 years. It should be noticed that the method used by Boltwood does not involve any question of the purity of the radium standard which may be employed to determine the actual quantity of radium in the mineral.

The experimental value of the period may be compared with the value calculated by Rutherford and Geiger† from the number of α particles emitted per second per gram of the radium used as a standard. The period found, 1760 years, is somewhat less than the 2000 years found by Boltwood. The calculated value, however, depends on the accuracy of the radium standard. Corrected in terms of the Vienna standard, prepared by Hönigschmid (Section 182) the period becomes 1850 years. On the other hand, the method of Boltwood tends to give too high a value of the period

* Boltwood, *Amer. Journ. Sci.* **25**, p. 493, 1908.

† Rutherford and Geiger, *Proc. Roy. Soc. A*, **81**, p. 162, 1908.

since there is always the uncertainty of the complete separation of ionium from the mineral. It seems fairly certain, however, that the period of radium lies between 1700 and 2000 years and is probably about 1850 years. The period of radium can also be deduced from the observed volume of the radium emanation in equilibrium with one gram of radium. Taking the volume as 0.6 cubic mm. and the density of the emanation as 222, it can be calculated that the period of radium is about 1750 years.

177. Connection between radium and uranium. We have seen that ionium is the direct parent of radium and the amount of radium in a mineral is kept up by its supply from the transformation of ionium. Rutherford and Soddy early suggested that radium was a disintegration product of one of the radio-active substances present in pitchblende, and from the fact that uranium and radium were always found together, it appeared probable that uranium was the primary source from which radium was derived. If this were the case, the amount of radium in a mineral should always be in a constant ratio to the amount of uranium.

This question was attacked experimentally about the same time by Boltwood*, McCoy†, and Strutt‡. We have already referred to the work of McCoy in Section 169. The relative activities of different minerals in the form of thin films were compared with the amount of uranium in the mineral determined by chemical analysis. His results showed that the activity of uranium minerals was nearly proportional to their content of uranium. Since a large part of the activity of uranium minerals is due to radium and its products, these results indicated that the amount of radium was always proportional to the amount of uranium.

This problem was attacked in a more direct manner by Boltwood and Strutt. The amount of radium in a mineral was determined by the emanation method, while the amount of uranium was determined by chemical analysis. In many of Boltwood's experiments, a weighed quantity of the mineral was

* Boltwood, *Nature*, **70**, p. 80, 1904; *Phil. Mag.* **9**, p. 599, 1905.

† McCoy, *Ber. d. D. Chem. Ges.* **37**, p. 2641, 1904.

‡ Strutt, *Nature*, **69**, p. 473, 1904; **70**, p. 222, 1904; *Proc. Roy. Soc. A*, **76**, pp. 81, 312, 1905.

dissolved by acid in a closed vessel, and the amount of emanation released by boiling was measured by an electroscopic method. Boltwood showed that many of the minerals in the solid state allowed a considerable fraction of the emanation to escape into the air. This loss was corrected for. In this way, Boltwood made a very complete and accurate comparison of the radium and uranium content of a number of radio-active minerals. Only those minerals were selected in which there was no evidence of any alteration by the action of water or other agencies. The

Substance	Locality	I	II	III	IV
Uraninite ...	North Carolina	170.0	11.3	0.7465	228
Uraninite ...	Colorado ...	155.1	5.2	0.6961	223
Gummite ...	North Carolina	147.0	13.7	0.6538	225
Uraninite ...	Joachimsthal	139.6	5.6	0.6174	226
Uranophane ...	North Carolina	117.7	8.2	0.5168	228
Uraninite ...	Saxony ...	115.6	2.7	0.5064	228
Uranophane ...	North Carolina	113.5	22.8	0.4984	228
Thorogummite ...	North Carolina	72.9	16.2	0.3317	220
Carnotite ...	Colorado ...	49.7	16.3	0.2261	220
Uranothorite ...	Norway ...	25.2	1.3	0.1138	221
Samarskite ...	North Carolina	23.4	0.7	0.1044	224
Orangite ...	Norway ...	23.1	1.1	0.1034	223
Euxinite ...	Norway ...	19.9	0.5	0.0871	228
Thorite ...	Norway ...	16.6	6.2	0.0754	220
Fergusonite ...	Norway ...	12.0	0.5	0.0557	215
Aeschyrite ...	Norway ...	10.0	0.2	0.0452	221
Xenotime ...	Norway ...	1.54	26.0	0.0070	220
Monazite (sand)	North Carolina	0.88	—	0.0043	205
Monazite (crys.)	Norway ...	0.84	1.2	0.0041	207
Monazite (sand)	Brazil ...	0.76	—	0.0031	245
Monazite (massive)	Conn. ...	0.63	—	0.0030	210

results are included in the table above. Column I gives the total amount of emanation in arbitrary units in one gram of the mineral, corrected for loss of emanation from the solid mineral; Column II the percentage fraction of the emanation lost by the mineral; III the weight of uranium in one gram of the mineral, and IV the ratio obtained by dividing the quantity of emanation by the weight of uranium. The numbers in Column IV should be constant if the amount of radium bears a constant ratio to the amount of uranium.

With the exception of some of the monazites, the numbers show a surprisingly good agreement, and, taking into consideration the great variation of the content of uranium in the different minerals, and the wide range of locality from which they were obtained, the results afford a direct and satisfactory proof that the amount of radium in the minerals is directly proportional to the amount of uranium. Results of a similar character were given by Strutt.

The weight of pure radium per gram of uranium in a mineral in radio-active equilibrium should thus be a definite constant. This constant ratio Ra/Ur was determined by Rutherford and Boltwood* who compared by the emanation method the quantity of radium in a mineral of known uranium content with the amount of emanation from a standard solution of radium. The amount of radium per gram of uranium was found to be 3.4×10^{-7} gram. This is expressed in terms of the radium standard used by the writer. Consequently, one gram of radium is present in a mineral containing 3000 kilos of uranium.

Knowing the percentage of uranium in a given mineral, the amount of radium can be at once deduced without measurement. This is the first example of a case where the amount of one element can be inferred from the amount of another present.

In the formation of a uranium mineral it is probable that uranium is deposited without its products. Supposing that uranium changes into ionium and ionium into radium, an interval of about 10 million years will be required for the radium to reach a practical equilibrium with the uranium. In this calculation it is supposed that the period of ionium is not greater than one million years. If the period is only 100,000 years, one or two million years will suffice. The ratio Ra/Ur should thus only be constant for old minerals. It is to be expected that the ratio would also depend to some extent on whether the mineral has been altered by the action of percolating water or by other agencies. If one or more products are removed in this way, the equilibrium is disturbed and the ratio Ra/Ur will not be the same as for old unaltered minerals.

* Rutherford and Boltwood, *Amer. Journ. Sci.* **22**, p. 1, 1906. See also Boltwood, *Amer. Journ. Sci.* **25**, p. 296, 1908.

The first evidence of an effect of this kind was observed in a specimen of pyromorphite found at Issy L'Eveque and examined by Danne*. This contained a considerable quantity of radium but *no* uranium. Later investigation by McCoy† showed that the radium was confined to a surface layer which had been deposited by flowing water. The water had dissolved some radium in its passage through some uranium deposits in the neighbourhood.

Minerals	Locality	Activity	Radium per 100	Uranium per 100	Ratio Ra/Ur
Chalcolite ...	Saxony ...	—	0.714×10^{-5}	39.29	1.82×10^{-7}
Carnotite ...	Colorado ...	0.76	0.375 "	16.00	2.34 "
Gummite (soluble part)	Germany ...	—	0.31 "	12.20	2.54 "
Autunite ...	Autun ...	1.52	1.20 "	46.92	2.56 "
" ...	Tonquin ...	1.50	1.22 "	47.10	2.59 "
Chalcolite ...	Germany ...	1.20	0.905 "	28.80	3.14 "
Pitchblende ...	Joachimsthal	1.90	1.48 "	46.10	3.21 "
Gummite ...	Germany ...	1.23	0.58 "	17.37	3.34 "
Chalcolite <i>a.</i>	Portugal ...	1.70	1.30 "	39.03	3.33 "
" <i>b.</i>	" ...	1.70	1.21 "	36.20	3.33 "
" <i>c.</i>	" ...	0.04	0.024 "	0.724	3.35 "
Samarskite ...	India ...	0.42	0.295 "	8.80	3.35 "
Broeggerite ...	Norway ...	3.90	2.10 "	63.89	3.29 "
Clévécite ...	" ...	2.96	1.81 "	54.90	3.32 "
Uranothorite ...	" ...	0.76	0.16 "	4.83	3.31 "
Pitchblende 2	" ...	3.12	2.05 "	58.90	3.48 "
Fergusonite ...	" ...	0.30	0.223 "	76.30	3.55 "
Pitchblende 1	" ...	0.29	0.17 "	4.67	3.64 "
Thorianite ...	Ceylon ...	2.32	0.66 "	18.60	3.55 "
Chalcolite ...	Cornwall ...	2.00	1.70 "	48.66	3.49 "
Pitchblende ...	" ...	1.40	1.07 "	28.70	3.74 "

Recently attention has been drawn to a number of secondary minerals like autunite and chalcolite, where the ratio Ra/Ur is in some cases less than half the normal value. This question has been examined by Mlle Gleditsch‡, Soddy and Ruth Pirret§, Marckwald and Russell||. Mlle Gleditsch has made a careful

* Danne, *C. R.* **140**, p. 241, 1905.

† McCoy, *Journ. Amer. Chem. Soc.* **29**, p. 1698, 1907.

‡ Mlle Gleditsch, *C. R.* **148**, p. 1451, 1909.

§ Soddy and Ruth Pirret, *Phil. Mag.* **20**, p. 345, 1910; **21**, p. 652, 1911.

|| Marckwald and Russell, *Jahrb. d. Rad.* **8**, p. 457, 1911.

examination of the ratio Ra/Ur in a number of minerals by two methods. In one case barium was precipitated as sulphate in the solution of the mineral which entrained the radium with it. After obtaining the radium in solution, the amount of radium was determined by the emanation method. The amount of radium was also directly determined by observing the production of emanation in a solution of the mineral. Both methods usually gave concordant results. Her results are included in the table on p. 463.

While the average value Ra/Ur for a number of minerals is about the same as that found by Boltwood, some of the minerals, for example, the first six, give a value of the ratio distinctly below the normal, while the specimen of Cornwall pitchblende gives a high value of the ratio. Soddy and Pirret found the ratio Ra/Ur for autunite from Portugal to be 0.45 of that for Joachimsthal pitchblende. Marckwald and Russell examined specimens of autunite from Portugal and France, and found a ratio from 0.21 to 0.68 of the value for Joachimsthal pitchblende.

It should be pointed out that the minerals which give a low ratio Ra/Ur are believed to be of relatively recent formation and are secondary minerals, *i.e.* minerals derived from the decomposition of primary uranium minerals. The low ratio Ra/Ur may be ascribed to one or both of two causes, *viz.* (1) to the recent formation of the mineral, or (2) to the removal of part of the radium by percolating water or other chemical agencies. If (1) is correct, it is to be expected that not only should the ratio be low for radium but equally so for ionium. This point has been examined by Marckwald and Russell (*loc. cit.*) who found the ratio Io/Ur for autunite to vary between 0.76 and 0.93 of the ratio for pitchblende. These values are distinctly higher than the corresponding ratios for Ra/Ur, *viz.* 0.24 to 0.68.

The evidence, so far obtained, is not sufficiently precise to distinguish between the two possible explanations. It seems, however, probable that the alteration of the equilibrium by the action of water is in many cases of paramount importance.

It is difficult to explain the relatively high ratio found by Mlle Gleditsch for certain old minerals. If alteration has occurred, it is possible in some cases that the radium dissolved from one

part of a mineral may be deposited in another, and this will temporarily disturb the values of the ratio. Examples of this have been observed by Mlle Gleditsch.

Considering the chemical and other difficulties in determining accurately the relative amounts of radium or uranium in minerals, the evidence as a whole strongly supports the view that for *old unaltered* minerals, the ratio Ra/Ur is a definite constant with a value 3.4×10^{-7} by weight.

178. Production of radium from uranium. In putting forward the disintegration theory, Rutherford and Soddy suggested that uranium was the primary source from which radium was derived. If this were the case, radium should appear in the course of time in preparations of uranium initially freed from radium. Assuming that uranium passes *directly* into radium, it can readily be calculated that one kilogram of uranium in equilibrium with Ur X should produce 1.2×10^{-7} gr. Ra per year.

Initial experiments to test this point were made by Soddy*. A solution of uranium nitrate was deprived of radium by precipitating barium as sulphate in the solution. It was found that the rate of production of radium in the uranium solution was less than 1/1000 of the rate to be expected if uranium changed directly into radium. In later experiments, evidence was obtained of a slow but uniform growth of radium in the solution. Experiments of a similar kind were made by Boltwood† using uranium nitrate which had been carefully purified by a large number of successive crystallisations. He found no evidence of a detectable growth of radium in a solution containing 100 grams of uranium nitrate over a period of 390 days.

These results clearly showed that uranium did not change directly into radium but indicated that an unknown product of slow rate of transformation intervened between uranium and radium. This conclusion was ultimately verified by the discovery of ionium which changes directly into radium.

In the light of this discovery it is possible to estimate the rate

* Soddy, *Nature*, **70**, p. 30, 1904; **71**, p. 294, 1905; *Phil. Mag.* **9**, p. 768, 1905; **16**, p. 632, 1908; **18**, p. 846, 1909; **20**, p. 340, 1910.

† Boltwood, *Amer. Journ. Sci.* **20**, p. 239, 1905.

of formation of radium to be expected in a uranium solution. Let P_0 , Q_0 , R_0 be the number of atoms of uranium, ionium and radium in equilibrium with each other and λ_1 , λ_2 , λ_3 their respective constants of transformation. Then

$$\lambda_1 P_0 = \lambda_2 Q_0 = \lambda_3 R_0.$$

Disregarding the correction due to Ur X, the number of atoms of ionium formed in a time t , short compared with its period, is $\lambda_1 P_0 t$. The number R of atoms of radium formed in this time is given by

$$\int_0^t \lambda_1 \lambda_2 P_0 dt = \frac{1}{2} \lambda_1 \lambda_2 P_0 t^2 = \frac{1}{2} \lambda_2 \lambda_3 R_0 t^2.$$

It is seen from this calculation that in a solution of uranium initially freed from radium, the amount of radium formed should be proportional to the square of the time. The amount of radium formed in a given time can readily be calculated. Taking one kilogram of uranium,

$$R_0 \text{ (by weight)} = 3.4 \times 10^{-4}; \quad \lambda_3 = 3.4 \times 10^{-4} \text{ (year)}^{-1}.$$

Taking the average life of ionium as 100,000 years,

$$\lambda_2 = 10^{-5} \text{ (year)}^{-1}.$$

Substituting these numbers

$$R = 6 \times 10^{-13} t^2,$$

where t is expressed in years.

If the formation of 10^{-11} gram can be detected, the interval required is about 4 years. The formation of 10^{-10} gram will require about 13 years. The interval required will be larger if the period of ionium has been underestimated.

It is clear from these calculations that the slow growth of radium in uranium solutions, observed initially by Soddy, was due to a small quantity of ionium present as an impurity with the uranium. Soddy and Mackenzie* have shown that ordinary commercial preparations of uranium nitrate grow radium at a slow but constant rate due to the ionium initially present. No detectable growth of radium was observed by them in uranium solutions

* Soddy and Mackenzie, *Phil. Mag.* **14**, p. 272, 1907.

from which the ionium was initially separated. From observations of this kind it is possible to calculate a lower limit to the life of ionium by a comparison with the simple theory given above. In this way Soddy* has shown that ionium cannot have an average life less than 30,000 years.

This calculation supposes that no other product of life comparable with radium intervenes between uranium and ionium. If such a product be present it is easy to show that the formation of radium in one kilogram of uranium would not be detectable within the limits of a lifetime. No definite proof of the formation of radium from *pure* uranium has yet been obtained. Soddy† made experiments to test whether a large quantity of Ur X gave rise to ionium or radium in its transformation. No detectable amount of radium was observed, nor was any certain evidence obtained that an α ray product made its appearance. If ionium is the only product of long period between uranium and radium, the amount of radium formed should be proportional to the square of the time. If this relation is found to hold, it will afford a definite proof that no other product of long period is present in the series.

Some recent experiments of Russell and Rossi are of interest in this connection. Using a large Rowland grating, they obtained the arc spectrum of the thorium-ionium preparation separated by Boltwood, which has been mentioned on page 458. The spectrum of thorium was obtained but not a single line was observed that could be attributed to ionium. On the assumption that ionium has a life of 100,000 years, the preparation should have contained 10 per cent. of ionium. Since probably the presence of one per cent. of ionium would have been detected spectroscopically, it would appear that the ionium was present in small amount, indicating that the life of ionium must be much less than 100,000 years. The results suggest that the failure to detect the growth of radium in uranium may be due to the presence of an unknown product between Ur X and ionium rather than to the long period of ionium itself.

Hahn‡ showed that radium was produced in commercial

* Soddy, *Phil. Mag.* **18**, p. 858, 1909.

† Soddy, *Phil. Mag.* **20**, p. 342, 1910.

‡ Hahn, *Ber. d. D. Chem. Ges.* **40**, p. 4415, 1907.

preparations of thorium. This is due to the fact that the thorium minerals contain some uranium and the ionium produced by the latter is always separated with the thorium.

179. Uranium series. For convenience, the series of transformations considered in this chapter is given below. The product Uranium 2 is considered to break up in two ways, and to give rise to Uranium X and Uranium Y. The evidence indicates that the Ur Y is formed in amount small compared with Ur X, and is to be regarded as a branch product. There is no information available whether or not Ur Y gives rise to other successive products.

The atomic weights are also added. These are deduced by supposing that the loss of an α particle lowers the atomic weight by 4 units. There is supposed to be no appreciable change in atomic weight due to the expulsion of a β particle. The weight of each product in equilibrium with one kilogram of uranium is also added.

Uranium Series.

Uranium Series	Atomic weight	Weight per kilogram of Uranium	Half-value period	Rays	Range of α rays 15° C.	
Ur {	Uranium 1	238.5	10 ⁶ mg.	5 × 10 ⁹ yrs.	α	2.5 cms.
	↓					
	Uranium 2	234.5	196 ,, (?)	10 ⁶ yrs. (?)	α	2.9 ,,
	↓					
	Ur Y	230.5 (?)	8 × 10 ⁻⁷ mg.	1.5 days	β	—
	↓					
Uranium X	230.5	1.3 × 10 ⁻⁵ ,,	24.6 ,,	$\beta + \gamma$	—	
↓						
Ionium	230.5	39 mg. (?)	2 × 10 ⁵ yrs. (?)	α	3.00 ,,	
↓						
Radium	226.5	0.34 ,,	2000 yrs.	α	3.30 ,,	

CHAPTER XIII.

RADIUM AND ITS EMANATION.

180. We have given in Chapter I a brief account of the history of the discovery of radium and mentioned some of its properties. In the last chapter, it has been shown that radium is to be regarded as a transition element which is half transformed in about 2000 years. It is derived from the transformation of ionium, which in turn is derived from uranium. In old primary minerals, there is a definite relation between the amount of radium and uranium in the mineral. For each gram of uranium in equilibrium with its products, 3.4×10^{-7} gr. Ra is present. Consequently in 1000 kilos of a mineral containing 60 per cent. of uranium, the quantity of radium present is 204 milligrams. We have seen that in some secondary minerals of recent formation like autunite, the amount of radium is less than half of the normal amount.

It would be out of place here to give a detailed account of the methods of separation of radium from uranium minerals on a commercial scale. It suffices to say that radium is separated from the mineral by a process similar to that required to separate barium, and is ultimately obtained mixed with the relatively large amount of barium present in the mineral. The radium is then separated from the barium by the process of fractional crystallisation of the chloride or the bromide. These salts of radium are less soluble than the corresponding salts of barium and crystallise out first. The concentration of the radium by this method is comparatively simple and proceeds rapidly in the case of the bromide. Giesel found that fractionation with the bromide was far more effective than with the chloride, and that six or eight

crystallisations suffice to obtain the radium bromide in a nearly pure state. The main difficulty of purification is to separate the last traces of barium from the radium.

Radium salts crystallise in exactly the same form as the corresponding salts of barium. The crystals of radiferous barium chloride several hours after preparation usually assume a yellow or rose tint. The intensity of this colouration depends on the relative proportions of barium and radium present in the crystal. Nearly pure radium chloride crystals do not show this colouration, indicating that the presence of barium is necessary.

181. Spectrum of radium. The spectrum of radium was first determined by Demarçay* using material purified by

Spectrum of Radium.

Wave length	Intensity	Wave length	Intensity	Wave length	Intensity
6446·3	8	5505·8	4	4826·12	20
6439·1	4	5502·07	8	4699·43	6
6337·2	6	5488·83	6	4682·36	50
6200·6	10	5482·15	6	4641·41	6
6167·4	8	5406·78	8	4533·33	10
6151·3	4	5400·31	8	4436·49	20
5958·4	10	5319·69	6	4426·0	4
5861·0	5	5283·42	6	4366·5	4
5823·9	5	5264·57	6	4340·83	50
5813·85	15	5205·96	6	4334·5	4
5796·2	5	5097·49	6	4305·0	7
5778·5	5	5081·20	6	4265·1	4
5755·8	5	5041·52	6	4178·0	6
5729·2	23	5017·9	4	4010·53	6
5690·3	5	4982·10	6	3814·58	100
5660·81	10	4971·88	6	3649·75	50
5616·73	8	4918·61	3	2836·57	5
5601·72	8	4903·2	5	2813·84	10
5556·17	6	4856·25	8	2709·045	8
5553·81	6				

Mme Curie. He showed that radium gave a well marked and characteristic spectrum, similar in general aspect to the spectra of the alkaline earths. Later determinations of the spectrum

* Demarçay, *C. R.* **127**, p. 1218, 1898; **129**, p. 716, 1899; **131**, p. 258, 1900.

of radium have been made by Runge*, Exner and Haschek†, Crookes‡, and Runge and Precht§. The lines in the spark spectrum of radium and their relative intensities found by Runge and Precht are given on page 470. Lines below intensity 4 are omitted.

Recently Exner and Haschek|| compared the arc and spark spectrum of radium for barium-radium preparations containing .001 per cent., 0.1 per cent. and 70 per cent. of radium respectively. They conclude that the line 5017.9 observed by Runge and Precht belongs to barium and did not observe the line 6439.1, which Runge and Precht had concluded did not belong to calcium.

Giesel¶ observed that radium salts gave a beautiful carmine colour to the Bunsen flame. This flame spectrum was examined by Runge and Precht**. The following lines and bands show up clearly, 4826, 6130—6330, 6329, 6349, 6530—6700, and 6653.

The radium line 3815 can be detected in a barium-radium preparation of activity only 50. Exner and Haschek observed the two radium lines 3815, 4682 in a preparation containing only .001 per cent. of Ra. The spectroscopic test for the detection of radium, as for the other elements belonging to the alkaline earths, is thus very delicate, but does not compare in sensibility with the radio-active methods.

182. Atomic weight. Mme Curie†† has made successive determinations of the atomic weight of radium with specimens of steadily increasing purity. The purified radium chloride was treated with silver nitrate and the amount of silver chloride determined. The first definite determination gave a value of the atomic weight 225. A second determination made in 1907 with a larger quantity of radium gave a value 226.4. A determination

* Runge, *Ann. d. Phys.* **2**, p. 742, 1900; **12**, p. 407, 1903.

† Exner and Haschek, *Wien Ber.* **110**, p. 964, 1901.

‡ Crookes, *Proc. Roy. Soc. A*, **72**, p. 295, 1904.

§ Runge and Precht, *Ann. d. Phys.* **14**, p. 418, 1904.

|| Exner and Haschek, *Wien Ber.* **120**, p. 967, 1911.

¶ Giesel, *Phys. Zeit.* **3**, p. 578, 1902.

** Runge and Precht, *Ann. d. Phys.* **10**, p. 655, 1903.

†† Mme Curie, *C. R.* **129**, p. 760, 1899; **131**, p. 382, 1900; **135**, p. 161, 1902; **145**, p. 422, 1907.

of the atomic weight was also made by Thorpe*, using about 70 milligrams of radium. The value found was 226·7.

Recently a determination has been made by O. Hönigschmid† using more than one gram of radium chloride provided for the purpose by the Radium Institute of Vienna. A series of very concordant determinations were made which gave a value 225·95 for the atomic weight of radium. Silver and chlorine were taken as 107·88 and 35·457 respectively. Five standard preparations were made from this purified material containing 10, 31, 40, 237 and 680 mg. Ra Cl₂ respectively. It was found that the atomic weight was not altered by 50 additional crystallisations.

Another determination has been recently made by Gray and Ramsay‡ using about 200 mg. Ra. The atomic weight was found to be 226·45.

Mme Curie controlled the final purification of radium from barium by the spectroscopic method by comparison of the relative intensity of two neighbouring lines, viz. 4533·3 of radium with 4554·2, the strongest line in the spectrum of barium. By continued purification, the barium line became relatively very feeble.

In the last chapter evidence has been given that uranium emits two α particles for one from ionium. If the radium atom is derived by the loss of three α particles from the uranium atom, the atomic weight of uranium should be $225·95 + 3 \times 3·99 = 237·9$ on Hönigschmid's value, and 238·3 on Mme Curie's last value. The accepted value of the atomic weight of uranium, determined by Richards, is 238·5.

Evidence has been given in the last chapter that uranium contains two α ray components. These, if successive, should differ in atomic weight by 3·99 units. The observed atomic weight of uranium is a little higher than the values deduced above by the addition of 3 helium atoms to the radium atom. Assuming the correctness of the values for uranium and radium, this shows clearly that the second component of uranium must exist in such small amount compared with the primary component that it does not seriously influence the atomic weight of the mixture. For

* Thorpe, *Proc. Roy. Soc. A*, **80**, p. 298, 1908.

† O. Hönigschmid, *Wien Ber.* **120**, p. 1617, 1911.

‡ Gray and Ramsay, *Proc. Roy. Soc. A*, **86**, p. 270, 1912.

example, if the two components were present in equal amounts, the atomic weight of the first component, deduced from the mean atomic weight of radium, should be 238·1 and for the second 234·1. This would give an atomic weight 236·1 for the mixture. This is much lower than the observed value.

183. Metallic radium. Radium was obtained in a metallic state in 1910 by Mme Curie and Dr Debierne*. The method employed was similar to that used by Guntz in the preparation of metallic barium. About 0·1 gram of pure radium chloride was electrolysed with a cathode of mercury and an anode of platinum-iridium. The amalgam of radium so obtained was quite liquid and decomposed water. The radium amalgam was placed in an iron boat and the mercury slowly distilled in an atmosphere of hydrogen kept at a suitable pressure. At 400° C. the amalgam was solid but melted at higher temperatures. At 700° C. the last of the mercury was volatilised, and there was left behind a pure white metal constituting metallic radium. The radium metal melts at about 700° C. and the vapour given off rapidly attacks quartz. Radium metal is far more volatile than barium metal. Metallic radium alters rapidly when exposed to air, probably due to the formation of a nitride. It energetically decomposes water and dissolves in it.

Pure radium showed the radio-active properties to be expected if radio-activity is an atomic phenomenon. It produced radium emanation, and its activity increased with time at the theoretical rate. Ebler† made experiments to obtain metallic radium by the method of Curtius. The latter method was also used by Herschfinkel‡ but with negative results.

184. General properties. Radium forms a series of salts analogous in chemical properties and appearance to those of barium. In the course of time, radium salts are generally coloured by the action of their own radiations. The decomposition of salts of radium by the action of the radiation has

* Mme Curie and Dr Debierne, *C. R.* **151**, p. 523, 1910; *Le Radium*, **7**, p. 309, 1910.

† Ebler, *Ber. d. D. Chem. Ges.* **43**, p. 2613, 1910.

‡ Herschfinkel, *Le Radium*, **8**, p. 299, 1911.

been already mentioned (Section 114). The crystals of the chloride and bromide are isomorphous with those of barium and like the latter crystallise with two molecules of water.

The magnetic properties of pure radium chloride have been examined by P. Curie and Cheveneau. Radium chloride is paramagnetic and the value of susceptibility k is 1.05×10^{-6} . The corresponding salt of barium is diamagnetic with a value of $k = -0.40 \times 10^{-6}$.

In general properties, radium is analogous to the metals of the alkaline earths, and is to be regarded as a higher homologue of barium.

185. Radiations from radium. In preparations of radium some days old, most of the activity observed is contributed not by radium itself but by its products, viz. the radium emanation, radium A, B and C. By continued heating of a radium salt or by boiling the solution, the radium can be almost completely deprived of its products. Under these conditions, radium emits α rays of characteristic range 3.30 cms. in air at 15°C . The α ray activity of radium itself measured by the electric method is less than 20 per cent. of its activity in equilibrium with its products, while its γ ray activity is nil. Radium itself emits one α particle for four when in equilibrium with its products.

Hahn and Meitner* found that radium, completely freed from its short-lived products and also containing no radium D, E or F, emitted a β radiation of easily absorbed type with a coefficient of absorption μ in aluminium of about $312 (\text{cms.})^{-1}$. This was confirmed in a series of experiments by Kolowrat† who found a value of $\mu = 200 (\text{cms.})^{-1}$. This β ray activity due to radium measured by the electric method corresponds to about 2 per cent. of the total β ray activity of radium in equilibrium with its products.

v. Baeyer, Hahn and Meitner‡ have shown by the photographic method that the β rays from radium itself consist of two homogeneous groups of rays expelled with velocities 0.52 and 0.65 of the velocity of light.

* Hahn and Meitner, *Phys. Zeit.* 10, p. 741, 1909.

† Kolowrat, *Le Radium*, 7, p. 269, 1910.

‡ v. Baeyer, Hahn and Meitner, *Phys. Zeit.* 12, p. 1099, 1911.

The emission of β rays from a substance known to emit α rays is of great interest and importance. It suggests the possibility that radium may consist of two products, one emitting α rays and the other soft β rays. But so far no definite evidence of the existence of such a product has been observed. In the absence of such evidence, it is simplest to assume that the emission of slow β particles accompanies the emission of an α particle from the radium atom.

186. Radium emanation. A general account of the properties of the radium emanation has been given in Chapter IX. It has there been shown that the emanation is a radio-active gas of high molecular weight, which is chemically analogous to the inert group of gases, helium, argon, krypton and xenon. It is a transition element which is transformed according to an exponential law with a period of 3.85 days. Its average life is 5.56 days. It is absorbed by charcoal and by liquids. At very low pressures, it is condensed from the gas with which it is mixed at a temperature of about -150°C .

The radium emanation is produced by radium at a constant rate in amount proportional to the quantity of radium present. The radium atom disintegrates with the expulsion of an α particle and the residue of the atom forms the atom of the radium emanation. Starting with a radium compound freed from emanation by continued heating, the emanation accumulates according to the equation $Q/Q_{\text{max.}} = 1 - e^{-\lambda t}$ where Q is the quantity of emanation at a time t and $Q_{\text{max.}}$ the final equilibrium value. λ is the decay constant of the emanation and is equal to $2.085 \times 10^{-6} (\text{sec.})^{-1}$ and $0.180 (\text{day})^{-1}$. Tables for calculation of the fraction of the equilibrium quantity accumulated in a given interval are given in the appendix. The quantity of emanation reaches half value in 3.85 days, 75 per cent. in 7.70 days, and is within 1 per cent. of the equilibrium quantity in 30 days.

In a solid preparation of radium, most of the emanation is occluded in the compound and only a small fraction escapes. The calculations given above refer to the amount of emanation when the radium is enclosed in a sealed vessel when no emanation can escape.

We have seen that radium freed from all its products emits α rays and soft β rays. The variation of activity of radium preparations with time measured by the α rays is given by

$$I/I_{\max.} = a + (1 - a)(1 - e^{-\lambda t})$$

where λ is the radio-active constant of the emanation and a is a constant which depends on the thickness of the layer and the dimensions of the ionisation chamber. The value of a varies between about .12 and .17. If the radium salt is in the form of a thin film, a considerable fraction of the emanation escapes into the air. Assuming that the rate of escape of the emanation is proportional at any time to the amount of emanation present, it can readily be shown that the rise of activity to a maximum is more rapid than the normal. The value of λ in the equation is replaced by $\lambda + \kappa$ where κ represents the fraction of emanation escaping per second.

Since radium does not emit hard β rays or γ rays, the rise of activity of radium with time, measured by hard β rays or γ rays is given by $I/I_{\max.} = 1 - e^{-\lambda t}$. This equation requires a slight correction to take into account the fact that the β and γ rays arise not from the emanation itself but from the later products, radium B and C.

187. Separation and purification of the emanation.

The emanation occluded in radium preparations can be released by heating or dissolving them. The effect of heat on the escape of the emanation has been discussed in detail in Section 134. The most convenient method of collecting the emanation from radium is to keep the radium salt in solution and to pump off the emanation with the comparatively large quantities of hydrogen and oxygen formed in the solution by the action of the radiations (Section 115). This method, first used by Ramsay, is very simple and convenient, if supplies of radium emanation are required at intervals.

A simple arrangement used by the writer is shown in Fig. 107. It consists essentially of a bulb R containing the radium solution, and a small Toepler pump T for collecting the gases given off by the solution in the tube B over mercury. A ground glass joint at J allows the radium solution to be removed without trouble. There is a stopcock at S and a drying bulb of phosphorous pentoxide at P .

After the radium is obtained completely in solution, some hydrochloric acid is added to ensure that the radium will not precipitate itself in the course of time by the action of its radiations. The air is then completely removed by the pump. The stopcock *S* is then closed and the emanation and electrolytic gases which are formed collect in the solution and the space above it. The writer found that 0.25 gr. pure radium produced about 30 c.c. of mixed gases per week. It is desirable, therefore, that the bulb *R* and its connections should have a volume between 50 and 100 c.c. to ensure that the gas pressure will not rise to a dangerous degree in the course of a few weeks.

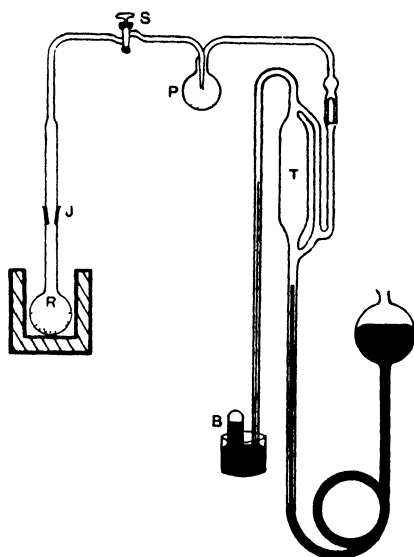

Fig. 107.

When it is required to collect the emanation, the stopcock *S* is slowly opened and the mixed gases allowed to expand into the exhausted pump. A large part of the water vapour is absorbed in *P*. *S* is then closed and the gases collected in the burette *B*. The gases in *R* are then allowed to expand again into the pump, and the process is repeated until the whole of the gases is removed. At a low pressure of the gas, the radium solution boils vigorously and this assists the complete removal of the emanation.

Since the mixed gases contain ozone, the mercury is attacked and the pump requires cleaning every few months.

The mixed gases consist of electrolytic gases with an excess of hydrogen, the emanation, helium and usually some carbon dioxide formed by the action of the emanation on the grease of the stopcock. The gases are transferred into a burette and exploded. The residual gases usually from (.1 to .5 c.c.) are then introduced over mercury into a small tube containing a small piece of caustic potash to absorb the carbon dioxide.

For the purification of the radium emanation, the writer has found the apparatus shown in Fig.

108 very convenient. The whole apparatus is exhausted by a Toepler pump not shown in the figure. By means of a mercury trough, the sparked gases are introduced into *C*. The stopcocks *A* and *B* are then closed and the U tube surrounded by liquid air. By alternately raising and lowering the mercury in *C*, practically the whole of the emanation is condensed in the U tube. *B* is then opened to the pump and the uncondensed gases, *e.g.* hydrogen and helium, are pumped out and collected over mercury. The mercury is then lowered in *D* and the

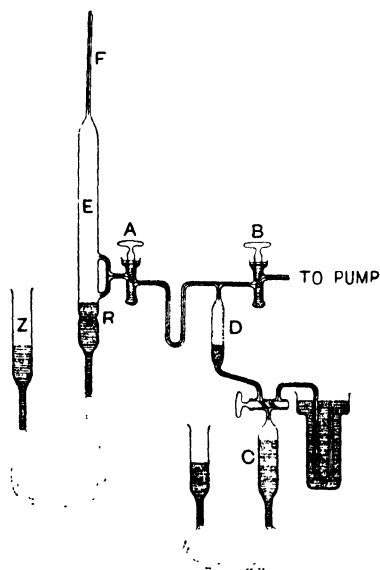

Fig. 108.

liquid air removed so that the emanation comes in contact with the caustic potash lining the tube *D* in order to remove the last traces of carbon dioxide. The emanation is condensed again in the U tube, and the whole apparatus completely pumped out. The emanation is then allowed to expand into the chamber *E*. To avoid loss of emanation in the U tube, the emanation may be all condensed in *E* by applying a pad of cotton wool soaked in liquid air to the side of the tube. The stopcock *A* is then closed and the emanation compressed into the apparatus required which is attached at *F*.

In order to avoid the formation of carbon dioxide and other gases by the action of the radiations during the purification, it is desirable that the stopcocks should be lubricated with phosphorous pentoxide. It is convenient in many cases to attach a charcoal tube to the tube *R* to allow of complete exhaustion of the vessel *E* when required. Instead of the caustic potash tube *D*, a side tube containing P_2O_5 and KHO and provided with a stopcock is very serviceable. After the preliminary purification, the emanation is removed, by condensation, to this tube and left for some time. If the emanation gives a red colouration when condensed at a point it is strong evidence that the emanation is practically pure. Ramsay found that the last traces of foreign gases could be removed from the emanation by exposing it to heated lime. The main difficulty of purification of the emanation arises from the fact that the volume of the emanation to be purified is seldom more than $\frac{1}{10}$ cubic millimetre. Using amounts of emanation from a hundred milligrams of radium, the phosphorescence produced by it in glass is very striking. In a dark room, this luminosity affords a very convenient method of determining the distribution of the emanation in the pump and its connections.

188. Volume of the emanation. The amount of emanation in equilibrium with one gram of pure radium is a definite quantity. At the Radiology Congress in Brussels in 1910, it was decided to call this equilibrium quantity a "curie," in honour of M. and Mme Curie. We shall see that a curie of emanation can be expressed as a weight or as the volume of the purified emanation at standard pressure and temperature. Since a curie is a comparatively large unit in comparison with the quantities of emanation ordinarily available in a laboratory, it is convenient to use the term millicurie as a smaller unit. Ten millicuries means the quantity of emanation in equilibrium with ten milligrams of pure radium.

The volume of the emanation from one gram of radium can be readily calculated from a knowledge of the number of α particles emitted per second per gram of radium itself. This number (Section 63) is 3.4×10^{10} . Since each radium atom after expulsion of an α particle becomes an atom of the emanation,

the number q of atoms of emanation formed per gram per second is 3.4×10^{10} . When equilibrium is reached, the number N of atoms of emanation present per gram is given by $N = q/\lambda$. Since $\lambda = 2.085 \times 10^{-6} (\text{sec.})^{-1}$, $N = 1.63 \times 10^{17}$. Since there are 2.78×10^{19} molecules in a cubic centimetre of any gas at standard pressure and temperature (Section 63) the volume of one curie of emanation, supposed monatomic, is 0.59 cubic millimetre. The rate of production of emanation per second is 1.24×10^{-9} c.c. per second.

The first experiments to determine the volume of the emanation were made by Ramsay and Soddy* using about 30 millicuries of emanation. The emanation was purified and its volume measured by compressing it into a capillary tube. The volume per curie was found to be about 1 cubic millimetre. Later Cameron and Ramsay† made a number of experiments with much larger quantities of radium, and found a volume of about 7 cubic millimetres per curie. This is much greater than the calculated value and was due to the presence of impurities. The question was examined in 1908 by the writer‡, who found a value of the volume about 0.6 cubic mms., viz. 0.58, 0.66, 0.59 in three separate experiments. This was in good accord with the calculated value. The emanation, after as complete a purification as possible, contracted in volume for the first few hours. The true volume of the emanation was taken as the minimum volume. These results were confirmed by Debierne§, who found values 0.60, 0.52, 0.61, 0.59 in four experiments. Finally Gray and Ramsay|| as a mean of three concordant experiments found a value 0.60 cubic mms. There is thus an excellent agreement between theory and experiment. The agreement of various observers is closer than would be expected considering the uncertainty of the relative values of the radium standards employed. The calculated value is based on the standard employed by the writer.

In experiments of this kind, it is essential that the amount of purified emanation in the measuring capillary should be

* Ramsay and Soddy, *Proc. Roy. Soc. A*, **73**, p. 346, 1904.

† Cameron and Ramsay, *Trans. Chem. Soc.* **91**, p. 1266, 1907.

‡ Rutherford, *Phil. Mag.* **16**, p. 300, 1908.

§ Debierne, *C. R.* **148**, p. 1264, 1909.

|| Gray and Ramsay, *Trans. Chem. Soc.* **95**, p. 1073, 1909.

standardized by comparison of its γ ray effect with that of a standard quantity of radium. In the process of purification, about 10 per cent. of the emanation is usually removed by the pump. Purified emanation obeys the ordinary laws of gases. All observers have found that partially purified emanation when forced into a capillary undergoes marked changes of volume during the first few hours. This is due to chemical action of the intense radiations on the gas mixed with the emanation. In some cases, the volume contracts and in other cases expands, depending upon the nature of the impurity present. After the initial changes, the volume generally does not alter much with time. With purified emanation, the volume usually does not change much as the emanation decays. The actual volume of the emanation should decrease at the same rate as its activity, but this is compensated for by the release of the helium which has been fired as α particles into the walls of the tube. Since the rate of release of helium from the walls of the capillary will depend on the nature of the glass, it is to be expected that the changes of volume of pure emanation will vary with the kind of glass employed. The presence of helium in the capillary is readily shown by sending a discharge through it. The spectrum of helium comes out brightly if the emanation has been kept in the capillary for some days.

189. Density of the emanation. Since radium is transformed into emanation with the emission of a helium atom of atomic weight 3.99, the atomic weight of the emanation should be $226 - 4$ or 222. Gray and Ramsay* measured the weight of a known volume of pure emanation by means of a very sensitive quartz micro-balance modelled upon the balance first devised by Steele and Grant†. This balance was sensitive to about one-millionth of a milligram. Assuming the emanation is a monatomic gas, they deduced that its atomic weight was 223 as a mean of five determinations giving values 227, 226, 225, 220, 218. The agreement between the measurements is surprisingly good, considering that the weight of the emanation itself was less than $\frac{1}{1000}$ milligram,

* Gray and Ramsay, *Proc. Roy. Soc. A*, **84**, p. 536, 1911.

† Steele and Grant, *Proc. Roy. Soc. A*, **82**, p. 580, 1909.

while the weight of the glass tube containing the emanation was usually about 30 milligrams.

The mean value obtained is in good accord with the theoretical value. The radium emanation has thus 111 times the density of hydrogen and is the heaviest gas known.

190. Spectrum of the emanation. Ramsay and Collie* in 1904, using a small quantity of purified emanation compressed in a small spectrum tube, observed visually a number of bright lines which were ascribed to the spectrum of the emanation. In 1908, Rutherford and Royds† photographed the spectrum of purified emanation, compressed into a small spectrum tube about 50 cubic mm. capacity provided with fine platinum electrodes. About 130 millicuries of emanation were used, corresponding to a volume of .08 cubic mm. at standard pressure. The photograph, which was found to consist of a large number of bright lines, is shown in Fig. 109. The spectrum of helium, which was used for comparison, is shown above and below the emanation spectrum. The colour of the discharge through the emanation was bluish, and not so intense as with a helium tube. The spectrum observed visually was a brilliant one of bright lines. The most noticeable were a group of strong lines in the green and another in the violet. By condensing the emanation in a side tube, the colour of the discharge completely changed, and the emanation lines disappeared. When a discharge passes through the emanation, it is driven into the walls of the tube, and the tube soon runs out. The emanation can then be released only by a strong and long continued heating of the tube. The wave lengths and intensities of some of the lines photographed are given on the next page. In addition to the lines recorded photographically the following lines of feeble intensity were observed visually:

6079, 5976, 5945, 5829, 5765, 5372, 5257, 5120.

Later, Cameron and Ramsay‡ published a list of emanation lines derived from three different photographs. With the

* Ramsay and Collie, *Proc. Roy. Soc. A*, **73**, p. 470, 1904.

† Rutherford and Royds, *Phil. Mag.* **16**, p. 313, 1908.

‡ Cameron and Ramsay, *Proc. Roy. Soc. A*, **81**, p. 210, 1908.

SPECTRUM OF RADIUM EMANATION.

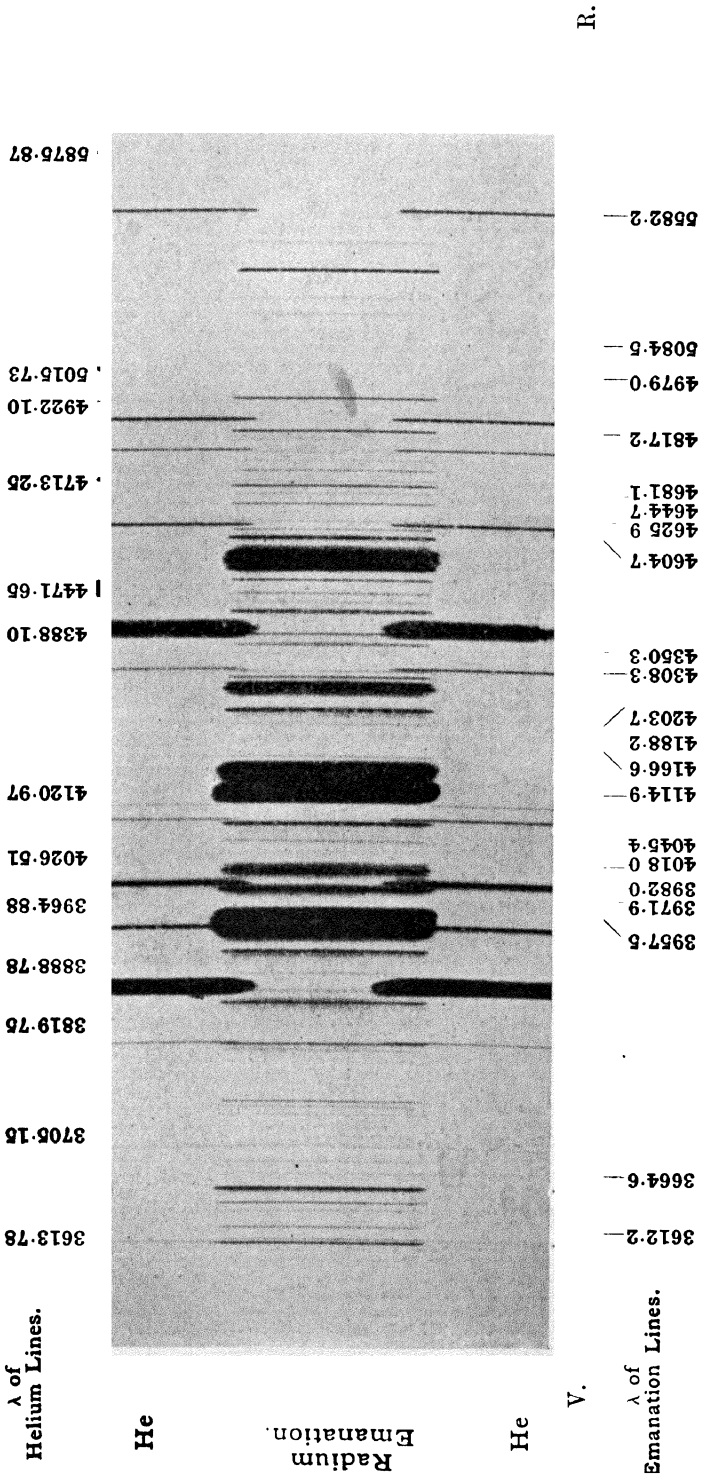

R.

Fig. 109.

exception of several of the strongest lines of the emanation, Royds* showed that the final spectrum was that of xenon. There had apparently been an accidental and unsuspected contamination of the emanation with this gas. Watson†, later, re-determined the spectrum of the emanation and found values in excellent agreement with the spectrum given by Rutherford and Royds. Royds‡ determined the grating spectrum of the emanation showing several additional lines in the ultra violet. The emanation has thus been

Intensity	Wave length	Intensity	Wave length	Intensity	Wave length
1	5715·0	7	4578·7	10	4018·0
8	5582·2	1	4549·9	12	3982·0
0	5392·4	9	4509·0	9	3971·9
4	5084·5	2	4504·0	7	3957·5
4	4979·0	10	4460·0	3	3952·7
0	4965·6	2	4440·6	3	3933·3
00	4949·4	8	4435·7	1	3927·7
00	4914·6	3	4384·0	2	3905·7
0	4889·5	4	4372·1	4	3867·6
—	4861·3	15	4350·3	2	3818·0
1	4827·8	7	4340·9	0	3811·2
4	4817·2	10	4308·3	10	3753·6
1	4796·7	2	4225·8	1	3748·6
3	4767·9	10	4203·7	7	3739·9
5	4721·5	5	4188·2	2	3690·4
2	4701·7	20	4166·6	1	3679·2
10	4681·1	7	4114·9	10	3664·6
1	4671·8	6	4102·2	0	3650·0
1	4659·3	2	4088·4	2	3626·6
10	4644·7	1	4055·7	1	3615·4
8	4625·9	2	4051·1	6	3612·2
7	4609·9	4	4045·4		
4	4604·7	1	4040·2		

shown to have a characteristic spectrum which is quite distinct from its parent substance, radium. No certain evidence of the presence of the emanation has been observed in stellar spectra.

191. Boiling point of emanation. We have seen in Chapter IX that the radium emanation at very low partial pressures condenses on a surface of matter between -150° C.

* Royds, *Proc. Roy. Soc. A*, **82**, p. 22, 1909.

† Watson, *Proc. Roy. Soc. A*, **83**, p. 50, 1909.

‡ Royds, *Phil. Mag.* **17**, p. 202, 1909.

and -160°C . If the emanation behaves as an ordinary gas, it is to be expected that the temperature of condensation will depend on the pressure of the emanation. An accurate determination of the variation of vapour pressure of the emanation with temperature is rendered difficult by the very small volume of radium emanation available for experiment. Most of the experiments discussed later were made with a volume of not more than 0.1 cubic mm. at atmospheric pressure.

The first experiments on this subject were made by the writer*. The emanation was purified and compressed in a fine capillary tube of internal diameter about 0.05 mm. The volume of emanation available occupied about 3 cms. length of this capillary. The end of the capillary containing the emanation was surrounded by a bath of pentane cooled with liquid air, the temperatures being measured by a thermocouple. The temperature of condensation was observed by the decrease of pressure and by the increased phosphorescence of the glass at the end of the capillary. At atmospheric pressure, it was found that the emanation started to condense at -65°C . The vapour pressures of the emanation at different temperatures determined in this way are given below.

Vapour pressure	Temperature
76 cms.	-65°C .
25 „	-78°C .
5 „	-101°C .
0.9 „	-127°C .

W. Gray and Ramsay† determined the vapour pressure of the emanation at higher temperatures by a different method. The purified emanation was compressed into a capillary tube with the aid of a modified Andrew's apparatus and the formation of liquid at the end of the capillary was observed with the aid of a low power microscope. Observations of the vapour pressure were made between -10°C . and 104.5°C ., the critical temperature of the emanation. The vapour pressure curve was compared with the known curve for methyl-alcohol and the values of the vapour

* Rutherford, *Nature*, **79**, p. 457, 1909; *Phil. Mag.* **17**, p. 723, 1909.

† Gray and Ramsay, *Trans. Chem. Soc.* **95**, p. 1073, 1909.

pressure of the emanation at temperatures below -10° C. deduced by extrapolation. The following values were given by them.

Pressure in mm.	Temp. $^{\circ}$ abs.	Pressure in mm.	Temp. $^{\circ}$ abs.	Pressure in mm.	Temp. $^{\circ}$ abs.
500	202·6°	5000	262·8°	30000	346·0°
800	212·4	10000	290·3	35000	356·0
1000	217·2	15000	307·6	40000	364·4
2000	234·5	20000	321·7	45000	372·9
4000	255·3	25000	334·5	47450	377·5 (crit.)

It will be seen that the numbers in the first column were not actually observed but obtained by extrapolation from the vapour pressure curve. The boiling point at standard pressure, -62° C., deduced by Gray and Ramsay is in good accord with the value -65° C. found by the writer.

The liquified emanation undergoes a marked variation of colour with lowering of the temperature. At ordinary temperatures the liquid is nearly colourless. Gray and Ramsay consider that the emanation cannot exist as a liquid below -71° C. On cooling below this temperature, the condensed emanation increases in brilliancy and shows as a brilliant point of light. As the temperature is decreased, the colour changes to yellow and becomes an orange red at the temperature of liquid air. On raising the temperature again, the red phosphorescence disappears about -118° C. The observation of these colour changes is complicated by the marked phosphorescence set up in the glass of the capillary containing the condensed emanation, but can be made most simply with the aid of a low power microscope. From measurements of the volume occupied by the emanation when condensed at the temperature of liquid air, it has been found that the density of solid emanation is between 5 and 6.

CHAPTER XIV.

ACTIVE DEPOSIT OF RADIUM.

192. In Chapter X the general properties of the active deposit derived from the transformation of the radium emanation have been discussed. It has been shown that the surface of bodies exposed to the emanation becomes coated with an invisible film of radio-active matter. On removal from the emanation, the activity of this deposit, which as a whole emits α , β and γ rays, decays with the time and has fallen to a minute fraction of its initial value after 24 hours. If, however, a body is exposed for several days to the radium emanation and then removed, there is always a small residual activity of the order of one-millionth of the initial activity. This residual activity measured by the α rays increases steadily with time over an interval of several years.

It will be shown in this Chapter that at least six successive transformations occur in the active deposit. The matter initially produced from the emanation is called radium A, and the succeeding products B, C, D, E, F. The equations expressing the quantity of A, B, C, present at any time are very complicated, but the comparison of theory with experiment may be much simplified by temporarily disregarding some unimportant terms: for example, the products A, B, C are transformed at a very rapid rate compared with D. The activity due to D + E + F is, in most cases, negligible compared with that of A or C, being usually less than 1/100000 of the initial activity observed for A or C. The analysis of the active deposit of radium may thus be conveniently divided into two stages:

- (1) Analysis of the deposit of rapid change, which is composed of radium A, B, and C;
- (2) Analysis of the deposit of slow change, which is composed of radium D, E, and F.

193. Analysis of the deposit of rapid change. The complete analysis of the active deposit of rapid change into its three components and the determination of the period of each product and the nature of the radiations emitted has been attended with considerable difficulty. Before considering the details of the transformations, it is desirable to give a brief review of the historical development of our knowledge of these transformations. It was early observed by Rutherford and Miss Brooks* that the active deposit decayed more rapidly and in a more complicated way than the active deposit of thorium. The decay of the activity was examined in detail by Curie and Danne†. They found that the decay of activity depended on the time of exposure of the body to the emanation. The decay curve was found to be independent of the time of exposure provided this was greater than four hours, and could be empirically expressed by a difference of two exponentials. The variation of the activity I (disregarding the first 20 minutes after removal) was expressed by

$$I/I_0 = ae^{-\lambda_1 t} - (a-1)e^{-\lambda_2 t},$$

where $\lambda_1 = 4.13 \times 10^{-4} (\text{sec.})^{-1}$, $\lambda_2 = 5.38 \times 10^{-4} (\text{sec.})^{-1}$

and the constant $a = 4.20$.

Several hours after removal, the decay of activity was nearly exponential with a half-value period of 28 minutes corresponding to λ_1 .

In an examination of the decay of activity of the deposit, the writer‡ found that the decay curves for different types of radiation could be explained by the assumption of three successive changes in the active deposit called radium A, radium B and radium C. Radium A had a period of 3 minutes and emitted only α rays. Radium B had a period of 21 minutes and was rayless, while radium C of period 28 minutes emitted α , β and γ rays. The empirical relation for the decay found by Curie and Danne was found to agree closely with the calculations based on the transformation theory, and the periods 21 and 28 minutes were deduced from the constants λ_2 , λ_1 given by them. It was shown that it

* Rutherford and Miss Brooks, *Phil. Mag.* **4**, p. 1, 1902.

† Curie and Danne, *C. R.* **136**, p. 364, 1903; **138**, pp. 683, 748, 1904.

‡ Rutherford, *Phil. Trans. A*, **204**, p. 169, 1905.

was impossible to decide from the decay curve whether the shorter period of 21 minutes was to be ascribed to radium B or radium C.

Curie and Danne* observed that the decay curves of the active deposit were much influenced by heating to a high temperature. This was investigated later by Bronson†, who showed that the effects observed were not due to any influence of high temperature on the rate of transformation of the products, but arose from the difference of the volatility of the products radium B and radium C. Radium B was volatilised from a metal wire far more readily than radium C. Under suitable conditions, he found that the decay curve of the wire after heating was exponential over a wide range with a period of 19 minutes. This showed clearly that the shorter of the two periods was to be ascribed to the last product radium C and not to radium B. Bronson found that the decay curves for short and long exposures agreed closely with theory if the periods of radium A, B and C were 3, 26 and 19 minutes respectively.

In the meantime, H. W. Schmidt‡ by measuring the changes of β ray activity of a body exposed for a short interval to the radium emanation, had found that radium B was not rayless as at first supposed, but emitted β rays. Most of the β rays emitted by radium B were much more easily absorbed than the corresponding rays from radium C, but a small fraction had about the same coefficient of absorption as the swifter rays from radium C. These results have recently been confirmed by Fajans and Makower§. Moseley and Makower|| have also shown that radium B emits some easily absorbed γ rays. The ionisation due to these under ordinary conditions is about 13 per cent. of those which arise from radium C in equilibrium with radium B. Von Lerch¶ showed that radium C could be obtained in a pure state by dipping a nickel plate into a solution of the active deposit. He

* Curie and Danne, *C. R.* **138**, p. 748, 1904.

† Bronson, *Amer. Journ. Sci.* **20**, p. 60, 1905; *Phil. Mag.* **11**, p. 143, 1906.

‡ H. W. Schmidt, *Ann. d. Phys.* **21**, p. 609, 1906.

§ Fajans and Makower, *Phil. Mag.* **23**, p. 292, 1912.

|| Moseley and Makower, *Phil. Mag.* **23**, p. 302, 1912.

¶ v. Lerch, *Ann. d. Phys.* **20**, p. 345, 1906.

found that radium C emitted α , β and γ rays and decayed with a period of 19.5 minutes.

Hahn and Makower and Russ (see Section 73) showed that radium B could be obtained in a pure state by recoil from radium A, and that radium C could be obtained by recoil from radium B. This new method of separation of the products has been of great assistance in making an accurate comparison of experiment with theory.

In the calculations of this Chapter, the periods of radium A, B and C will be taken as 3, 26.8, and 19.5 minutes respectively. Mme Curie* states that the decay curve of the active deposit between 5 and 7 hours after removal was found to be 27.2 minutes and between 7 and 10 hours 26.8 minutes. For this reason the value 26.8 minutes will be used for the period of B. The periods of B and C are slightly higher than those found by Bronson by analysis of the decay curves, viz. 26 minutes and 19 minutes respectively.

The sequence of changes of the emanation under consideration and the radiations emitted are shown graphically below.

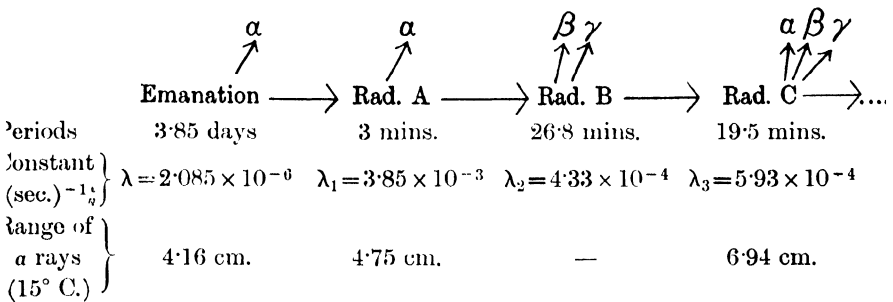

The half-value periods, the value of λ (sec.)⁻¹, and the ranges of the α particles emitted are added for comparison.

194. Decay curves for α rays. The decay curves are very different in shape according to the type of rays, whether α , β or γ , used for measurement. It is convenient to consider the decay curves for a very short and for a very long exposure, measured by α or β or γ rays. We shall first consider the decay curves measured by the α rays when the body has been exposed for a definite time to a constant quantity of emanation. It will be

* Mme Curie, *Radioactivité*, 2, p. 322, 1910.

shown later that these curves differ slightly from the practical case where the body is exposed to a naturally decaying source of emanation removed from the radium.

(1) *Very short exposure (a few seconds).* This case has already been considered in Section 166 as an example of the method of deducing the activity curves. The α ray activity at any time is due to the α rays from radium A, plus the rays from radium C. If P_0 be the number of atoms of radium A deposited, P, Q, R the number of atoms of A, B, C respectively after removal for a time t , the activity is proportional to

(1) $\lambda_1 P + \lambda_3 R$ when the decay is observed by counting scintillations,

(2) $k\lambda_1 P + \lambda_3 R$ when the decay is observed by the electric method.

$P = P_0 e^{-\lambda t}$ and R is given by equation 6, Section 159, while k is a constant.

Since the α rays from radium C have a longer range than those from radium A, the value of k varies with the dimensions of the ionisation chamber. Bronson for example found $k = 1.26$ when the active wire was placed in a cylinder of 2.5 cms. radius. In this case, the average α particle from radium A produced more ionisation than that from radium C. With a testing vessel of sufficient dimensions to absorb the long range α particles from radium C, the value of k would be less than unity. The following numbers given by Bronson* show the agreement between the observed and theoretical values of the activity for a short exposure to the emanation. The theoretical values in this case were calculated by Bronson on the assumption that the three periods under consideration were 3, 26 and 19 minutes. The theoretical values are only slightly different from those calculated for the accepted periods 3, 26.8, 19.5 minutes respectively. The value of k was taken as 1.26. The curve of decay for a short exposure analysed into its constituents, has been shown in Fig. 102, Section 166.

It is of interest to note that between 25 and 40 minutes, the α ray activity remains nearly constant.

* Bronson, *Phil. Mag.* **12**, p. 73, 1906.

The activity after several hours decreases to half value in about 27 minutes, *i.e.* according to the period of radium B. These measurements of the decay of activity were made by means of a Bronson resistance (Section 43), which was carefully calibrated.

Since the periods of decay of the products were determined with the same apparatus and using the same calibration constants, the close agreement between the observed and calculated numbers affords the strongest evidence of the correctness of the theory.

Decay of α ray activity. Short exposure.

Time in minutes	Activity observed	Activity calculated	Time in minutes	Activity observed	Activity calculated
0	---	100	50	3.65	3.65
2	64.0	63.2	60	3.27	3.26
4	39.9	40.2	70	2.81	2.84
6	25.9	25.9	80	2.36	2.40
9	13.8	14.0	100	1.60	1.64
15	5.73	5.72	120	1.03	1.07
21	4.12	4.11	140	.66	.68
25	3.92	3.91	160	.41	.43
30	3.92	3.93	180	.25	.26
40	3.91	3.91	200	.15	.16

(2) *Long exposure.* After exposure to a constant supply of emanation for at least 5 hours, the products *A*, *B* and *C* are in equilibrium and $\lambda_1 P_0 = \lambda_2 Q_0 = \lambda_3 R_0$. The activity as before is proportional to $k\lambda_1 P + \lambda_3 R$ where $P = P_0 e^{-\lambda_1 t}$ and *R* is given by equation 12, Section 160. The calculated decay curve is shown in Fig. 110, curve *A + B + C* assuming $k = 1$. The various constituents which make up the resultant activity curve are shown clearly in the figure. Curve *AA* gives the activity contributed by radium A, curve *LL* the activity contributed by radium C. The latter may be divided into two parts, (1) the activity (curve *CC*) due to radium C present at the moment of removal which decays exponentially with a period of 19.5 minutes, and (2) the activity (curve *BB*) contributed by the subsequent change of radium B into radium C. The activity due to the latter passes through a maximum after 35 minutes. After 20 minutes A has practically disappeared and the activity is then proportional to

$\lambda_3 R$. Bronson (*loc. cit.*) has shown, as in the case of short exposure, that the experimental and calculated values are in good agreement.

If the decay curve is obtained by covering the active body with an absorbing screen of sufficient thickness to absorb completely the α rays from radium A, but to allow some of the α particles from radium C to escape, the α ray activity at any time after removal is accurately proportional to $\lambda_3 R$. The curve of decay is then shown by curve *LL*, Fig. 110.

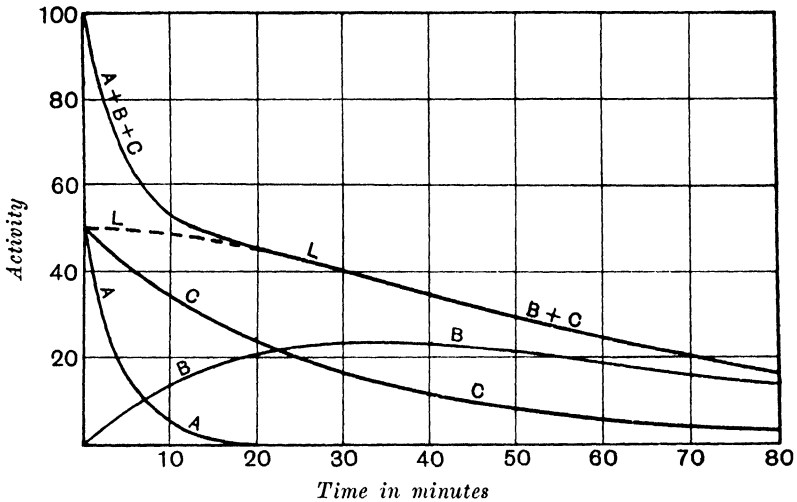

Fig. 110.

(3) *Any time T of exposure.* As in the other cases, the activity at any time t after removal is proportional to $k\lambda_1 P + \lambda_3 R$ where P is given by equation 14, and R by equation 17, Section 161. The decay curve for any time of exposure can be calculated from the equations. In this way, with increasing time of exposure, a family of curves is obtained which progressively changes from the shape of the curve for a short exposure to that for a long exposure. Examples of such decay curves have been given by Miss Brooks*, P. Curie and Danne† and H. W. Schmidt‡. The activity of A relative to C decreases with increase of time of

* Miss Brooks, *Phil. Mag.* 8, p. 373, 1904.

† P. Curie and Danne, *C. R.* 136, p. 364, 1903.

‡ H. W. Schmidt, *Ann. d. Phys.* 21, p. 609, 1906.

exposure, so that the initial rapid drop due to A becomes of relatively less importance. For an exposure of more than 4 hours, the curves are practically identical with that due to a longer time of exposure.

195. Decay curves for β rays. *Short exposure.* We have seen that Schmidt observed that radium B emits some soft β rays as well as a small number of β rays of about the same penetrating power as those from radium C.

The activity at any time t after a short exposure is consequently proportional to $k\lambda_2 Q + \lambda_3 R$ where Q and R are given by equations (5) and (6) respectively (Section 159).

The value of k varies very widely according to the thickness of screen placed over the active matter. For screens just thick enough to absorb the α rays $k=1$ nearly; for screens sufficiently thick to absorb most of the soft β rays, $k=.1$ about.

We have shown (Fig. 99) that for a short exposure, the amount of radium B reaches a maximum in 10 minutes, while the amount of radium C reaches a maximum in 35 minutes. If radium B emitted no β rays, the curve of activity, measured by β rays, would be identical with the curve CC (Fig. 99) showing the variation of the amount of C with time. In consequence of the emission of β rays from radium B, H. W. Schmidt* showed that the time of reaching a maximum depends upon the thickness of screen placed over the active deposit. For a thick screen, the β ray curve is not very different from the curve CC (Fig. 99). It rises, however, more rapidly at the beginning and reaches a maximum somewhat earlier.

The relative β ray activity due to radium B and C under different conditions is best examined by obtaining pure radium B by recoil from radium A, using a short time of exposure. Under such conditions, radium B is obtained nearly pure, and the variation of its activity with time can be conveniently studied. We have then to consider the case of two successive changes discussed in Section 159. Taking P and Q as the amounts of radium B and C respectively at any time t , the β ray activity is proportional to $k\lambda_1 P + \lambda_2 Q$ where λ_1 and λ_2 are taken as the

* H. W. Schmidt, *Ann. d. Phys.* **21**, p. 609, 1906.

constants of B and C, and P and Q are given by equations (1) and (4).

Fajans and Makower* in this way examined the fraction of the β rays supplied by radium B compared with radium C. The variation of β ray activity with time for different thicknesses of absorbing screens is shown in Fig. 111.

The maximum β ray activity is for each curve taken as 100. Curve A shows the rise of activity measured by the α rays. The

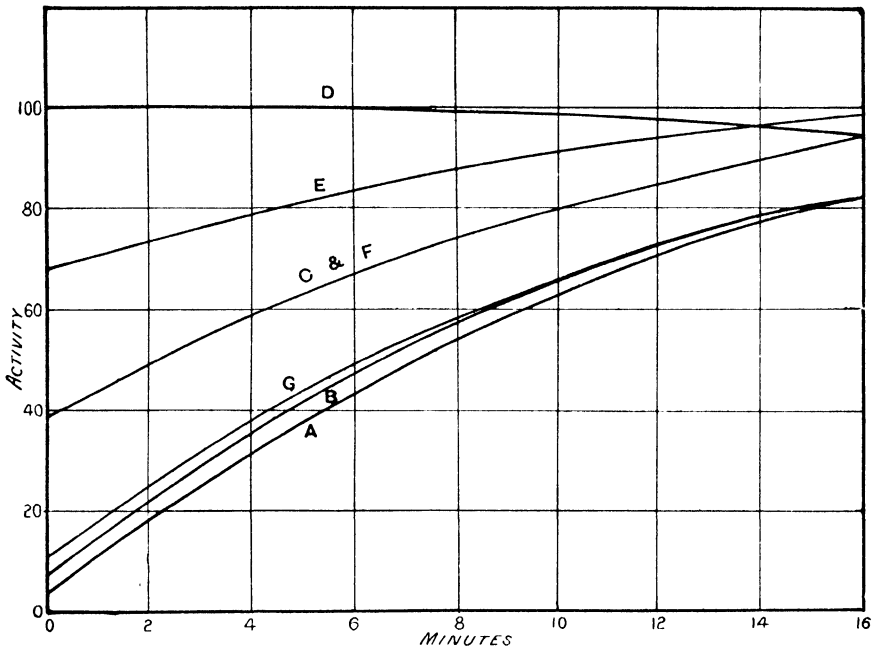

Curve A. No aluminium.

Curve E. 0.21 mm. of aluminium.

„ B. 0.0140 mm. of aluminium.

„ F. 0.36 „ „ „

„ C. 0.0305 „ „ „

„ G. 0.73 „ „ „

„ D. 0.0446 „ „ „

Fig. 111.

curve does not start exactly from zero, probably on account of the relatively large ionisation supplied by the soft β rays from radium B. Curves B and C, for thicknesses of aluminium not sufficient to stop the α rays, show that the ionisation supplied by β rays from radium B becomes relatively more important. Curve D shows the variation of β ray activity with time when

* Fajans and Makower, *Phil. Mag.* 23, p. 292, 1912.

the α rays are completely absorbed by the aluminium screen. It is seen that the curve starts to decrease from the origin, showing that a larger fraction of the β ray effect is due to radium B. With increasing thickness of aluminium, the β rays from radium B are relatively more absorbed than those from radium C. This is shown by curves *E*, *F* and *G*. The effect of the β rays from radium B compared with those from radium C becomes relatively smaller with increasing thickness up to 0.7 mm. of aluminium. For all thicknesses greater than this, the rise curves agree with curve *G*, which shows an initial activity about 10 per cent. of the maximum. These experiments show that radium B not only emits some very easily absorbed β rays but also a small quantity of more penetrating β rays which have about the same coefficient of absorption as the average β rays from radium C. Fajans and Makower deduced that the rays from radium B could be divided into two groups whose coefficients of absorption in aluminium were 91 (cms.)^{-1} and 18 (cms.)^{-1} .

β ray curves. Long exposure. The activity for a long exposure measured by β rays is proportional to $k\lambda_2 Q + \lambda_3 R$ where *Q* and *R* are given by equations (11) and (12), Section 160. The shape of the decay curve will obviously depend on the value of *k* which is determined by the thickness of the absorbing screen. By choosing a suitable value of *k*, Bronson (*loc. cit.*) showed that the decay curve obtained was in good agreement with the theory.

196. Decay curves for γ rays. *Long exposure.* Moseley and Makower* showed that radium B emits some soft γ rays, which produce about 13 per cent. of the ionisation due to the γ rays from radium C in equilibrium with it, when measured through 3 mm. of lead.

The activity for a long exposure is thus proportional to $k\lambda_2 Q + \lambda_3 R$ where *k* is not more than .13 under normal experimental conditions. By using an absorption screen of lead 2 cms. thick, the γ rays from radium B are completely absorbed and the activity is then proportional to $\lambda_3 R$. The variation of activity with time is thus shown by curve *LL* (Fig. 110). The presence of some γ rays from radium B does not, under ordinary conditions,

* Moseley and Makower, *Phil. Mag.* 23, p. 302, 1912.

very markedly alter the decay curve based on the assumption originally held that the γ rays arise entirely from radium C.

Moseley and Makower found that the effect of the γ rays from radium B shows itself most markedly in the initial part of the rise curve measured by γ rays through 3 mm. of lead. The emanation freed from active deposit was introduced into a small glass tube which was immediately sealed. The variation of γ ray activity with time for the first 10 minutes is shown by curve *F*' (Fig. 112). The theoretical curve obtained on the assumption

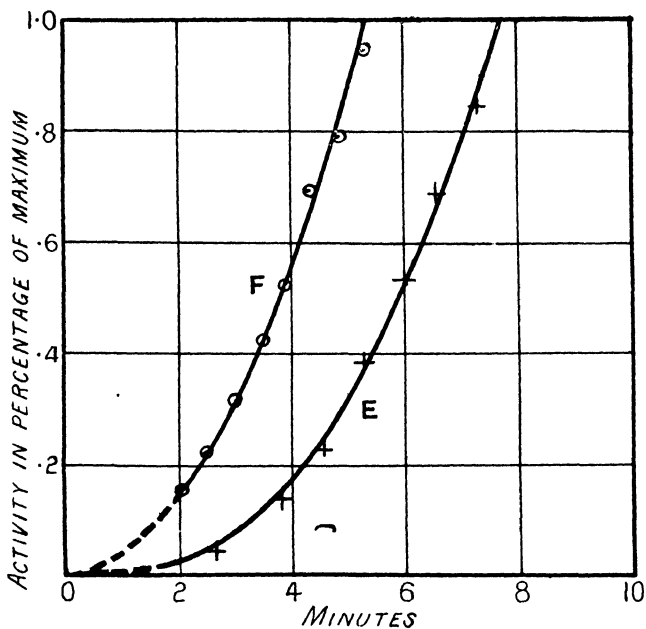

Fig. 112.

that the γ rays arise entirely from radium C is shown for comparison in curve *E*. The emission of γ rays from radium B offers an explanation of the similar curves given on page 394, 2nd Edition, *Radiation in Nature*.

Recovery curves. For exposure to a constant supply of emanation, the curve of rise of activity due to the active deposit is complementary to the decay curve for a long exposure (Section 194). Taking $k=1$, the dark line of Fig. 113 represents the rise of activity to a maximum of 100 measured by the α rays.

The α ray decay curve for a long exposure is added for comparison, and also the corresponding curves for rise and decay measured by penetrating γ rays. In the latter case, the rise curve is given for the γ rays after traversing 2 cms. of lead which cuts off the γ rays from radium B.

197. Practical cases of decay and recovery curves.

We have so far for simplicity of calculation, considered the rise and fall of the activity of a body exposed to a *constant* quantity of emanation. This corresponds to the case where the body is

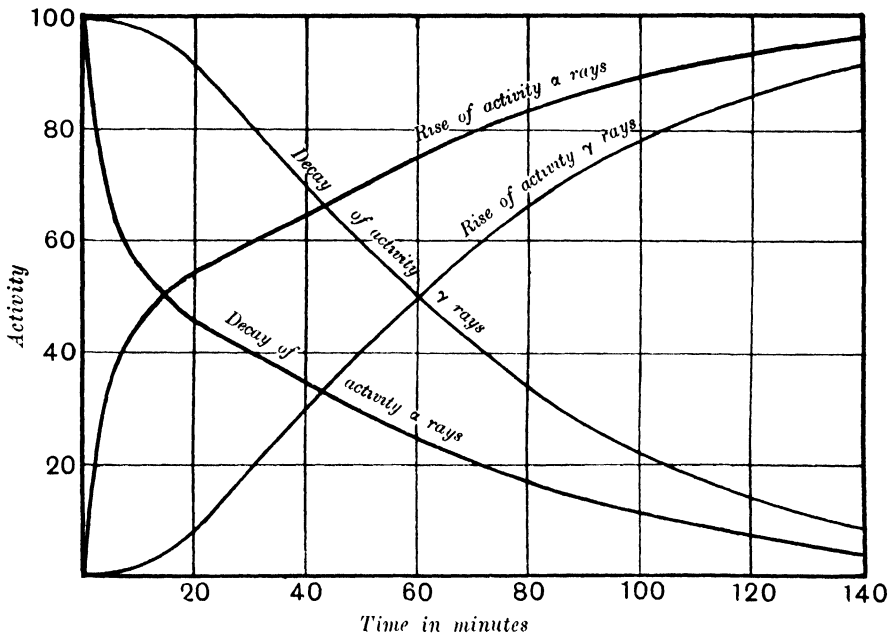

Fig. 113.

exposed in the air space above a radium solution which is in equilibrium with the emanation. In practice, however, it is usual to expose the body to be made active in the emanation removed from the radium. Since this is a decaying source, we have the case of "transient" equilibrium discussed in Section 163. The active deposit after about 6 hours, is in equilibrium with the emanation and diminishes afterwards at the same rate as the emanation itself.

We have shown in Section 163 that the amounts of radium A,

B and C are .054 per cent., .54 per cent., 0.89 per cent. respectively greater than corresponds to the *true* equilibrium with the amount of emanation present at the moment under consideration.

In order to obtain the true curve of decay, it is necessary to consider the case of four changes. Taking $\lambda_1, \lambda_2, \lambda_3, \lambda_4$ to refer to the emanation, radium A, B, and C respectively, it follows from Sections 159 and 163, that the number N_t of atoms of radium C at any time t is given by

$$N_t/N_{\max.} = \frac{\lambda_2\lambda_3\lambda_4}{.972} \sum \frac{e^{-\lambda_1 t}}{(\lambda_2 - \lambda_1)(\lambda_3 - \lambda_1)(\lambda_4 - \lambda_1)} \dots\dots(1),$$

the other three terms in $e^{-\lambda_2 t}, e^{-\lambda_3 t}, e^{-\lambda_4 t}$ included under the summation can be written down from symmetry.

The maximum value is attained after 258 minutes, and the factor .972 is introduced so that the right-hand side becomes unity after that interval. Rutherford and Chadwick* have shown experimentally that the maximum γ ray activity is attained at the time calculated from theory.

The decay of the amount of radium C is similarly given by the equation

$$N_t/N_0 = e^{-\lambda_1 t} - \frac{\lambda_2\lambda_3\lambda_4}{1.0089} \sum \frac{e^{-\lambda_1 t}}{(\lambda_2 - \lambda_1)(\lambda_3 - \lambda_1)(\lambda_4 - \lambda_1)} \dots(2).$$

It can easily be shown that this expression can be deduced from the equation (1) given above. Suppose for illustration that the emanation in equilibrium with its products in a tube *A* is removed to a tube *B*. The amount of radium C remaining in tube *A*, plus the amount formed in tube *B*, must be equal at any time to the amount of radium C which would have existed in tube *A* if the emanation had *not* been removed.

The rise and decay of radium C with time have been calculated from the equations (1) and (2) by Moseley and Makower. The half-value periods of the emanation, radium A, B and C are taken as 3.85 days, 3, 26.8 and 19.5 minutes respectively. The results are shown in columns II and IV of the following table. For the rise curve, the maximum amount of radium C is reached after 258 minutes and is taken as unity. For the decay curve, the initial amount of radium C is taken as unity.

* Rutherford and Chadwick, *Proc. Phys. Soc.* **24**, p. 141, 1912.

The numbers in column IV which refer to a long exposure represent (1) the relative amount of radium C at any time after removal from the emanation; (2) the decay of the γ rays from radium C provided the rays from radium B are absorbed by a thickness of more than 2.3 cms. of lead; (3) the decay of the α ray activity of the active deposit 25 minutes after the removal

I Minutes	II Calculated rise of Radium C from emanation	III Calculated rise of ionisation by γ rays through 3 mm. of lead	IV Calculated fall of Radium C after removal from emanation	V Calculated fall of ionisation by γ rays through 3 mm. of lead
0	0.0000	0.000	1.0000	1.000
2	.000252	.00143	.9995	.998
3	.000801	.00323	.9989	.997
4	.001770	.00570	.9978	.994
5	.003239	.00885	.9963	.991
6	.005244	.0126	.9942	.987
8	.01097	.0221	.9884	.978
10	.01899	.0338	.9805	.966
12	.02925	.0475	.9703	.953
14	.04154	.0630	.9582	.938
17	.06343	.0890	.9368	.912
20	.08876	.118	.9120	.884
25	.1368	.170	.8650	.883
30	.1897	.225	.8134	.779
40	.3015	.338	.7046	.669
50	.4118	.446	.5985	.566
60	.5125	.543	.4987	.469
70	.6021	.629	.4112	.385
90	.7440	.763	.2719	.253
120	.8775	.888	.1396	.129
150	.9468	.952	.06913	.0639
180	.9800	.982	.03347	.0308
240	.9994	1.00	.00752	.00691
258	1.000	1.00	.00477	.00438
270	—	—	.00352	—

of the emanation. The initial decay is complicated by the presence of radium A, but this has practically disappeared after 25 minutes. The activity due to radium C is at that moment 0.865 of its initial value.

It is often convenient to deduce the amount of radium C by comparison of the γ ray effect of the active deposit measured by

the γ rays through about 3 mm. of lead. In this case the γ ray effect of radium B is 11.5 per cent., and of radium C 88.5 per cent. of the total. The results calculated on this basis given by Moseley and Makower are shown in columns III and V of the table. It will be seen that the decay and rise curves differ sensibly from those deduced on the assumption, ordinarily made, that the γ rays arise entirely from radium C.

In order to determine by γ ray measurements the amount of radium C present, it is desirable to absorb the γ rays from radium B by using a screen of lead at least 2 cms. thick. The amount of radium C is then proportional to the ionisation produced by the γ rays.

198. Complex nature of radium C. In all the calculations previously given, it has been supposed that radium C is a simple product of period 19.5 minutes, which emits α , β and γ rays in its transformation. Since most products emit either α rays or β and γ rays, it seemed possible that radium C might be a complex substance, one component emitting α rays and the other β and γ rays. In order to examine this point, Hahn and Meitner* separated a large quantity of radium C, by placing a nickel plate in the solution of the active deposit of radium, and tested the nature of the recoil radiations from the plate. By placing a negatively charged conductor above the active plate in order to collect the recoil atoms, they obtained evidence of the existence of a short lived product of period estimated between 2 and 2.5 minutes. The activity of the new product measured by the electric method was very minute, compared with that due to the radium C on the nickel plate from which it was derived.

Fajans†, using larger quantities of emanation, examined this effect more in detail. He found that a new substance was separated by recoil, which emitted β rays but no α rays, and which was half transformed in 1.38 minutes. The experiments were, to some extent, complicated by a deposit of radium C itself on the collecting plate, due probably to a slight volatilisation of radium C at ordinary temperatures.

* Hahn and Meitner, *Phys. Zeit.* **10**, p. 697, 1909.

† Fajans, *Phys. Zeit.* **12**, p. 369, 1911.

The β rays were of about the same penetrating power as those emitted by radium C. The amount of the new product obtained by recoil was small, for it gave only about 1/6000 of the β ray activity due to the radium C from which it was derived. These experiments show clearly that radium C is complex. It is convenient to speak of the two components of radium C as radium C₁ and radium C₂. The latter refers to the new β ray product of period 1.38 minutes.

Fajans showed that pure radium C produced radium D by recoil in about the amount to be expected for a vigorous α ray recoil. The small amount of radium C₂ obtained by recoil indicated that it could not be a direct product of radium C.

By an examination of the rise curve of radium C from radium B, Fajans and Makower* showed that the new product could not come before radium C₁. From general consideration of the evidence, Fajans concluded that radium C₂ could not be a product in the main line of descent but must be a branch product. On this view the atoms of radium C may be supposed to break up in two ways. The greater fraction is transformed directly into radium D and a small fraction, about 1/6000, into radium C₂.

Such a deduction was of great interest, for it was the first time that definite evidence of the existence of a branch product had been obtained. On general grounds it seems not unlikely that atoms of a single product may break up in different ways (see Section 209).

In order to explain the small quantity of actinium in uranium minerals, the writer early suggested that actinium was not in the main line of descent of the uranium-radium series but belonged to a branch series. We have seen in Section 174, that Antonoff obtained evidence of the existence of another branch product (Ur Y) in the transformation of uranium. There are strong reasons for believing that not only radium C but also thorium C is transformed in an abnormal manner. Such exceptions to the general rule of transformations are of unusual interest, for they may help to throw some light on the mechanism of the transformations.

* Fajans and Makower, *Phil. Mag.* 23, p. 292, 1912.

199. Ionisation due to the emanation and active deposit. The total ionisation in air due to one curie of emanation or to one curie of emanation in equilibrium with its products radium A, B and C can be simply calculated from the data given in Section 67. One curie of emanation emits 3.4×10^{10} α particles per second, and the total number of ions due to one α particle from it is 1.74×10^5 . Consequently the total number of ions produced per second by the radiation from one curie of emanation by itself is 5.9×10^{15} . Taking the charge on each ion as 4.65×10^{-10} units, the corresponding saturation current is 2.75×10^6 e.s. units or 9.2×10^{-4} ampère. In a similar way, taking into account the ionisation due to radium A and radium C, it can be shown that one curie of emanation in equilibrium with its products gives a total ionisation current of 8.9×10^6 e.s. units.

Measurements of the ionisation due to one curie of emanation have been made by Duane* and by Duane and Laborde† in cylindrical vessels of different diameters. In this case it is necessary to determine the average fraction of the range of the α particles which is effective in producing ionisation. Making the necessary corrections, it was found that one curie of emanation gave a saturation current of 2.5×10^6 e.s. units‡. The value of the saturation current due to one curie of emanation was re-determined by Mache and St. Meyer§ and found to be 2.67×10^6 e.s. units in terms of the Vienna Standard. Considering the difficulties of the experiments, these results are in excellent accord with the calculated value.

200. Effect of temperature and other conditions. Miss Gates (see Section 153) first showed that the active deposit of radium was driven off from a platinum wire above a red heat, and was deposited on the surface of a cold cylinder surrounding it. These results were extended by Curie and Danne, who examined the decay of the activity of wires which were exposed for a short time to temperatures varying between 15° and 1350° . They examined the decay of the active matter left on the wire itself,

* Duane, *C. R.* **140**, pp. 581, 786, 1905.

† Duane and Laborde, *C. R.* **150**, p. 1421, 1910.

‡ See Mme Curie, *Radioactivité*, **2**, p. 365, 1910.

§ Mache and St. Meyer, *Phys. Zeit.* **13**, p. 320, 1912.

and also of the active matter which had been volatilised from it. They found that the variations of activity were much influenced by the temperature to which the wire was exposed. Bronson showed that the results obtained by Curie and Danne could be explained by supposing that radium B was more volatile than radium C. After heating a wire to a high temperature, the radium B was completely volatilised and the α ray activity of the wire then decayed exponentially with a period of 19 minutes, which was taken as the period of radium C. No evidence was obtained of any alteration of the rate of transformation of radium B or C at high temperatures. In another series of experiments, Bronson* showed that the γ ray activity due to some radium enclosed in a quartz tube was not appreciably altered by exposure to temperatures up to 1300° C.

The effect of temperature on the decay of the products of radium have been investigated by many observers including Makower†, Makower and Russ‡, H. W. Schmidt§, Schmidt and Cermak||, Engler¶, and Russell**. All observers agree that the γ ray activity due to the active deposit alone or to the emanation in equilibrium with the latter is not altered by exposure to high temperatures up to 1300° C. When the source of active matter was emanation enclosed in a quartz tube, it was found that the period of decay of the emanation when tested in the cold was not altered by the effect of temperature. On the other hand, marked variations have been observed when the activity is measured by the β rays. The results obtained by different observers were very conflicting some finding that rise of temperature caused a temporary increase of the activity, and others a temporary decrease. These anomalies have been examined in detail by Russell (*loc. cit.*) using radium emanation in small quartz tubes as a source of radiation. He found that the effects obtained by various observers could be completely explained by taking into account the

* Bronson, *Proc. Roy. Soc. A*, **78**, p. 494, 1907.

† Makower, *Proc. Roy. Soc. A*, **77**, p. 241, 1906.

‡ Makower and Russ, *Proc. Roy. Soc. A*, **79**, p. 158, 1907.

§ H. W. Schmidt, *Phys. Zeit.* **9**, p. 113, 1908.

|| H. W. Schmidt and Cermak, *Phys. Zeit.* **11**, p. 793, 1910.

¶ Engler, *Ann. d. Phys.* **26**, p. 483, 1908.

** Russell, *Proc. Roy. Soc. A*, **86**, p. 240, 1912.

distribution of the radio-active products at various temperatures. He obtained definite evidence that in a quartz tube the radium C began to volatilise at a much lower temperature than had previously been supposed. The distribution of the active matter throughout the volume of the quartz tube produces marked effects on the β ray activity measured by an electroscope in the ordinary way. For example, when the tube is cold, the active deposit is mainly distributed on the walls of the tube. As the temperature is raised the radium B and C commence to volatilise and an increasing fraction is distributed throughout the volume of the tube. At 600° C. both radium B and C and probably radium A are completely volatilised and are uniformly distributed throughout the volume of the heated tube. This change in distribution produces a marked effect on the β ray activity, for even in a small spherical bulb of uniform thickness the average absorption of the β rays in passing through the quartz depends on whether the active matter is on the walls of the tube or distributed throughout its volume. The absorption is always less when the active matter is volatilised. If one end of the quartz tube is kept cool, the active matter at temperatures below 600° is concentrated at the cold end. In this way, the whole of the active deposit can be shifted from one end of the tube to the other by suitably varying the temperature of the two ends. This effect can be simply shown by observing the variations of the luminosity at different points of the tube by means of a screen of barium platinocyanide. There are consequently marked variations of the β ray activity according to the experimental conditions up to a temperature of 600° . Above that temperature the active deposit exists in a gaseous form, and the β ray activity due to it does not alter by further increase of temperature. Russell showed that there was no evidence that the activity or period of transformation of the emanation or of its products, radium A, B and C, were in any way altered by high temperatures. The marked irregularities which are observed under different conditions are wholly due to the differences of partition of the radium A, B and C at different temperatures and consequent alterations in the average absorption of the β rays by the walls of the vessel.

Rutherford and Petavel* introduced some radium emanation into a high pressure bomb in which cordite was exploded. The γ ray activity of the emanation was found not to be altered at the moment of the explosion although the maximum temperature was about 2500° and the corresponding pressure about 1000 atmospheres. Certain subsequent changes of the activity, which extended over some hours, were no doubt due to the difference in distribution of the active deposit brought about by the explosion. Schuster† showed that the γ ray activity of radium was not altered by exposure to a pressure of 2000 atmospheres. A similar result was obtained by Eve and Adams‡. It is thus seen that no evidence has been obtained that high temperatures or pressures have any influence in accelerating or retarding the rate of transformation of any radio-active substance. The rate of transformation proceeds at the same rate at a temperature of liquid air -186° as at a temperature of 1500° . Such a result brings out clearly the difference between the atomic transformations dealt with in radio-activity and ordinary molecular changes in chemistry where alteration of temperature exerts a marked influence on the rate of reaction.

201. Volatility of the active deposit. We have already referred to the effect of temperature on the active deposit in Section 193. The experiments of Curie and Duane show that radium B volatilised freely from a plate coated with the active deposit at a temperature of about 600° C., while the radium C remained behind. Duane§ found some evidence that radium A was even more volatile than radium B. Makower|| investigated the temperatures of volatilisation of radium A by the following method. A thin platinum wire charged negatively was heated in a cylinder containing radium emanation. The amount of radium A obtained on a wire in a given time began to decrease when the wire was raised to a temperature of 800° , and was very small at a

* Rutherford and Petavel, *Brit. Assoc. Reports*, Section A, p. 456, 1907.

† Schuster, *Nature*, **76**, p. 269, 1907.

‡ Eve and Adams, *Nature*, **76**, p. 269, 1907.

§ Duane, *Journ. d. Phys.* **4**, p. 605, 1905.

|| Makower, *Manch. Lit. and Phil. Soc.* **53**, Pt. II, 1909; *Le Radium*, **6**, p. 50, 1909.

temperature of 900° . He consequently concluded that radium A commenced to volatilise at 800° and was completely volatile at 900° . By a similar method he showed that no appreciable amount of radium A, radium B, or radium C, could be collected on a platinum wire for temperatures above 900° whether the wire was charged negatively or positively.

Makower examined the volatilisation of radium C by using plates of nickel, platinum and quartz coated with the active deposit. In all cases volatilisation of radium C was appreciable between 700 and 800° . All the radium C was driven off from platinum and nickel at 1200° , but the volatilisation of radium C from a quartz surface was incomplete at 1300° . Such results show that the volatilisation of radium C depends upon the surface on which it is deposited.

We have seen in Section 199 that Russell found evidence that radium C was completely volatilised at a temperature of 600° C. in a quartz tube. It appears that the amount of volatilisation of a given product at any temperature depends on several factors. It is quite probable that the components of the active deposit may in some cases combine with the surrounding gases to form oxides or other compounds. In such cases it might be expected that the apparent temperature of volatilisation would depend on the nature of the gases to which the active deposit is exposed. Some experiments by Dr Schrader* in the Laboratory of the writer are of importance in this connection. Using the active deposit of actinium, he found that the temperature of volatilisation was much lowered when a platinum wire coated with active deposit had been exposed in an atmosphere of chlorine. The solubility of the active deposit in water was also much increased. These results are of great interest as indicating a method of studying the formation of chemical compounds by radio-active matter existing in a minute amount. In consequence of the production of ozone by the α rays in air, it appears likely that the components of the active deposit exposed in air would tend to form oxides. This is borne out by the experiments on the volatilisation of active products in an atmosphere of hydrogen. A number of volatilised products were found to deposit at a much

* Schrader, *Phil. Mag.* **24**, p. 125, 1912.

lower temperature in this gas than in oxygen. It appeared probable that the low temperature of volatilisation found by Russell for radium B and radium C was due to the presence of hydrogen with the emanation. This was verified by Russell* in later experiments. He showed that in an atmosphere of hydrogen, volatilisation takes place at about 360° C. for radium C. The temperature required for volatilisation of radium C in an atmosphere of oxygen was much higher.

The volatilisation here considered must not be confused with the distinct phenomenon of transference of radio-active matter by radio-active recoil. We have seen (Section 73) that numerous radio-active substances can be separated in a pure state by this process. In every case so far examined, the recoil atoms carry a positive charge and are concentrated on the negative electrode. No evidence has been obtained that volatilised active matter carries a charge.

202. Active deposit of slow transformation. Radium D + E + F. Mme Curie and Giesel early observed that bodies which have been exposed for a long interval in the presence of the radium emanation did not lose all their activity on removal. The magnitude of this residual activity depends on the quantity of emanation and on the time of exposure to the emanation.

The analysis of this small residual activity has yielded results of great importance and interest. The active matter will be shown to consist of three successive products called radium D, radium E and radium F. Radium D is a slowly decaying substance which emits soft β rays and is identical with the primary radio-active constituent present in the "radio-lead," separated by Hofmann and Strauss from uranium minerals. Radium E emits β rays and weak γ rays, and has a period of 5 days. Radium F emits α rays and has a period of 136 days. It is identical with polonium, the first radio-active substance separated from pitchblende by P. and Mme Curie.

Disregarding the complexity of radium C, the succession of changes which occur are shown diagrammatically on the next page.

* Russell, *Phil. Mag.* **24**, p. 134, 1912.

The initial experiments to show the complex nature of this deposit were made by the writer*. Plates of metal were exposed for several days in the presence of a moderately large quantity of radium emanation. One day after removal, the active deposit of rapid change had practically disappeared. The weak residual activity was then examined over a long interval. The activity measured by the α rays was found to increase steadily with time. The results obtained are shown in Fig. 114. The curve for the first few months is nearly a straight line, but after 300 days the rate of increase of activity is much slower. The activity is evidently tending to approach a maximum value.

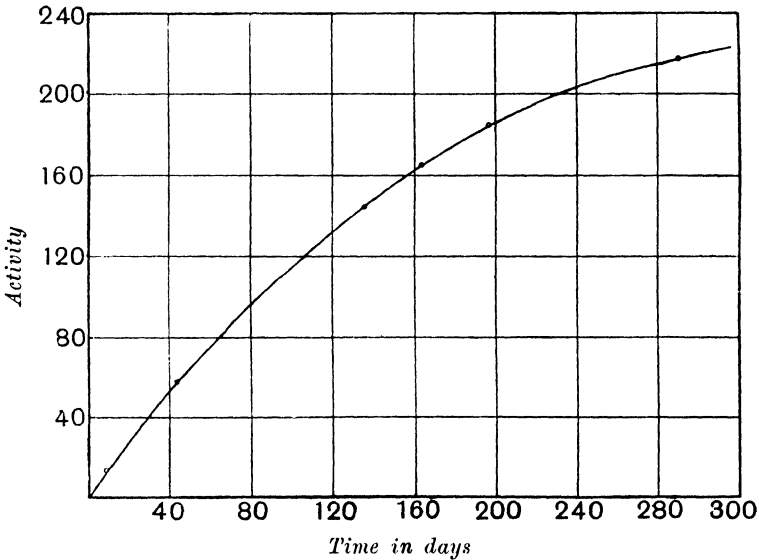
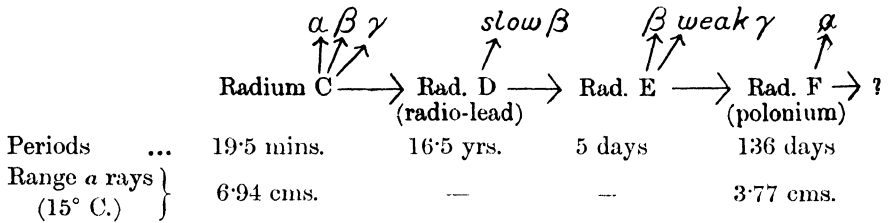

Fig. 114.

The activity measured by the β rays is shown in Fig. 115. The activity reaches a practical maximum after 40 days. This

* Rutherford, *Phil. Trans. A*, 204, p. 169, 1905; *Phil. Mag.* 8, p. 636, 1904; 10, p. 290, 1905.

rise curve showed the existence of a β ray product, radium E, of period about 6 days. It should be mentioned that the β ray activity of radium D measured by the electric method is small compared with that due to radium E. For this reason, radium D was initially supposed to be a rayless product.

The constancy of the β ray activity after reaching a maximum indicated that radium D was very slowly transformed.

In another experiment the emanation from about 30 mg. Ra was condensed in a glass tube and allowed to decay *in situ*. The active deposit on the surface of the glass was then dissolved in sulphuric acid and left to stand for a year. The α ray activity steadily increased in this interval. By introducing a polished

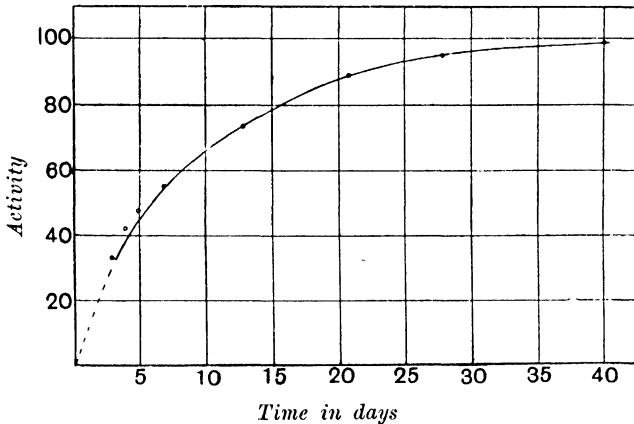

Fig. 115.

bismuth disc into the solution, the α ray product (radium F) was deposited electrochemically upon it. The bismuth disc emitted only α rays. The activity decayed exponentially with the time with a period of 143 days. The similarity of the nature of the α radiation and of chemical properties indicated that radium F was identical with the polonium of Mme Curie. A platinum plate coated with the active deposit of slow transformation was exposed for some minutes in a furnace to a temperature of over 1000°C . Most of the radium F was volatilised. The small α ray activity, observed immediately after removal from the furnace, increased rapidly for the first two weeks and then more slowly. The variation of α ray activity with time is shown in Fig. 116. A curve

of this character is to be expected if radium E is the parent of radium F. The action of the high temperature volatilised the greater part of radium D and radium F but did not drive off radium E. The radium E was then transformed with a period of about 4·5 days into radium F. On account of the uncertainty of the initial corrections required for the recovery curve of radium E after heating the platinum plate, the period of radium E was over-estimated in the rise curve and under-estimated in the decay curve. The true period of radium E found later by Antonoff and Meyer and v. Schweidler is 5·0 days.

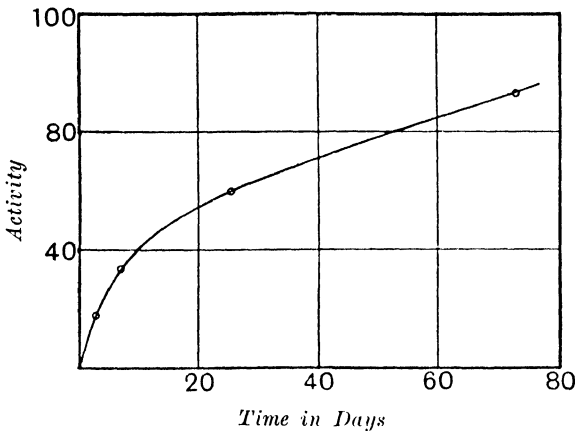

Fig. 116.

The general evidence indicated that radium D was the primary constituent in radio-lead, and that radium F was identical with polonium. Hofmann, Gonder and Wölf* had made a chemical examination of the constituents of "radio-lead" separated from uranium minerals. Various metallic salts were added to the solution and precipitated and the resulting activity measured. Some showed only an α ray activity, others a β ray activity. They stated that the β ray activity so obtained disappeared in six weeks and the α ray activity in one year. It appeared probable that the α ray product was radium F and the β ray product radium E.

The analysis of the active deposit of slow transformation of radium was confirmed in a series of important investigations by

* Hofmann, Gonder and Wölf, *Ann. d. Phys.* **15**, p. 615, 1904.

St. Meyer and v. Schweidler*. They examined also the products obtained from radio-lead and showed that the periods of decay were identical with those found for radium E and radium F produced from the radium emanation. It is now definitely established that radium F is identical with polonium and that radium D is the primary radio-active constituent separated with lead from uranium minerals.

It seemed probable that radium D was directly derived from the transformation of the product radium C. This has been recently confirmed by Fajans†, who found that radium D could be obtained by recoil from pure radium C. This was shown by the steady rise of the α ray activity due to radium F.

203. Radium D. We have seen in Section 9 that radium D is separated with the large amount of lead usually present in radio-active minerals. In the course of time, radium D produces radium F (polonium), and the α ray activity of the lead becomes about equal to that of uranium. The polonium can be separated by dissolving the lead nitrate in water and crystallising, when the polonium remains in solution. In chemical properties radium D is so closely analogous to lead, that no satisfactory methods have been found for concentration of this product. Experiments in this direction have been made by Hofmann and Wölfl‡, Szilard§ and Herchfinkel||. The amount of radium D present is tested by the β ray activity one month after separation. The radium E can in many cases be concentrated. This is shown by a high β ray activity which falls in the course of a month to the equilibrium value corresponding to the amount of radium D present.

The simplest way of obtaining pure radium D is to allow a large quantity of emanation to decay in a sealed vessel. The radium D can then be dissolved out by acid. Cameron and Ramsay found that after a large quantity of purified emanation

* St. Meyer and v. Schweidler, *Wien Ber.* **114**, p. 1195, 1905; **115**, pp. 63, 697, 1906.

† Fajans, *Phys. Zeit.* **12**, p. 369, 1911.

‡ Hofmann and Wolf, *Chem. Ber.* **40**, p. 2425, 1907.

§ Szilard, *Le Radium*, **5**, p. 1, 1908.

|| Herchfinkel, *Le Radium*, **7**, p. 198, 1910.

had been allowed to decay in a small capillary, the surface showed a black deposit which they ascribed to radium D derived from the emanation. This appears to be the simplest way of obtaining a sufficient quantity of pure radium D to determine its chemical and physical properties. The transformation of one curie of emanation should give rise to about 1/200 milligram of radium D.

Since radium D is a product of radium, another simple method of obtaining active preparations of radium D is to separate the latter from old preparations of radium. This can be done by precipitation with hydrogen sulphide, a little lead and bismuth being added to ensure the separation of radium D and radium F together.

204. Period of radium D. The transformation of radium D is too slow to deduce its period by direct measurements unless observations are continued for a decade or more. Estimates of the period of radium D by indirect methods were first made by Rutherford (*loc. cit.*) and Meyer and v. Schweidler*. Since the emanation changes into radium D, the number of atoms of radium D present after one month is nearly equal to the number N of atoms of emanation initially present. The number of atoms n_1 of emanation initially breaking up per second is $\lambda_1 N$; the corresponding number n_4 for radium D is $\lambda_4 N$ where λ_1 and λ_4 are the constants of transformation of emanation and radium D respectively. Then $\lambda_4/\lambda_1 = n_4/n_1$. If n_4/n_1 can be determined, the value of λ_4 can be deduced. An estimate of this ratio was initially made by the writer by comparing the β ray activity of radium D + E produced from the emanation with that due to radium C in equilibrium with the amount of emanation initially present. It was assumed that the average ionisation due to the β rays expelled from each atom was the same for both products. The period came out to be 40 years. In a similar estimate, Meyer and v. Schweidler found a period 37.5 years. The estimate by β rays is subject to large errors, for the average velocity of the β rays from each product is very different. It is better to determine n_4/n_1 by comparison of the initial α ray activity of the emanation with that due to radium F in equilibrium with radium D. In this case a

* St. Meyer and v. Schweidler, *Wien Ber.* 116, p. 701, 1907.

correction is required for difference in ionisation by the α particles from the two products. In this way Meyer and v. Schweidler found a period of 12.5 years.

The period was re-determined by Antonoff*. A known quantity of emanation was allowed to decay in a glass tube. The total number of α particles emitted by the polonium on its walls after a known interval of time was determined by the scintillation method. The number S of atoms of polonium existing at any time t after the introduction of the emanation is given by equation 7, Section 159. The quick period products radium A, B and C can be neglected without sensible error and $\lambda_1, \lambda_2, \lambda_3, \lambda_4$ in the equation are to be taken as the constants of transformation of the emanation, radium D, E and F respectively. P_0 is the initial number of atoms of emanation present. The latter value was deduced from Rutherford and Geiger's determination that one curie of emanation contains $3.4 \times 10^{10}/\lambda_1$ atoms of emanation. A number of concordant experiments gave a period of 16.5 years.

Mme Curie, as a result of direct measurements over a period of five years, of the α ray activity of radium D + E + F in equilibrium found that the decay observed is in approximate agreement with the above period. Taking the period of radium D as 16.5 years, the average life is 23.8 years and $\lambda = .042$ (year)⁻¹.

Starting with a preparation of radium freed from radium D, the amount of radium D will increase with time according to equation 5, Section 159, where λ_1 and λ_2 are the constants of transformation of radium and radium D respectively. The radium is here supposed to change directly into radium D. The amount of radium D will reach half its maximum value in 16 years and attain an equilibrium value with radium (period 2000 years) in 112 years. Ultimately, the amount of radium D will decrease according to the period of radium itself.

Since radium D is transformed into a β ray product radium E, the β ray activity of pure radium preparations will increase with time for a long interval. This presence of β rays due to radium E can readily be tested by dissolving the radium and driving off the emanation by continued heating over a period of several hours to allow the rapidly changing deposit to decay. The β ray activity

* Antonoff, *Phil. Mag.* 19, p. 825, 1910.

observed is then due mainly to radium D + E formed in it. In a similar way, since radium F is formed from radium D, the α ray activity will increase with time over a long interval. The interval required to reach a maximum value can readily be calculated from the known periods when suitable assumptions are made for the relative activity of the products under consideration.

Radium D was at first thought to emit no rays at all, but Hahn and Meitner* detected a feeble β radiation for which Kovarik† found $\mu = 130$ (cms.)⁻¹ in aluminium. Hahn and Meitner showed by the photographic method that the β rays consisted of two homogeneous beams emitted with velocities 0.37 and 0.31 of the velocity of light. No evidence has been obtained of the emission of γ rays from this substance. If any are emitted, they must be exceedingly feeble in quantity and penetrating power.

205. Radium E. Radium E can be readily separated from a solution of radium D + E + F by deposition on a nickel plate. The experiments of Meyer and v. Schweidler show that it is partially separated with polonium by a number of metals when these are dipped into the solution.

We have seen that the period found first by the writer for radium E by two methods was 6 and 4.5 days. Meyer and v. Schweidler (*loc. cit.*) obtained evidence that two β ray products were present in radio-lead with periods of 4.8 days and 6.2 days respectively. It was suggested that these products were successive and that the longer period product was rayless. For these reasons, the product radium E was for some time written as radium E₁ + radium E₂. Later work by Antonoff, using radium D derived directly from radium emanation, has indicated the presence of only one product. By precipitating barium in a solution of radium D + E + F, he found that radium D was entrained while radium E and F remained behind. The β ray activity of the filtrate was found to decay exponentially with a period of 5 days. The rise curve of radium E after an exposure of 24 hours to a large quantity of emanation was also determined.

* Hahn and Meitner, *Phys. Zeit.* **12**, p. 378, 1911.

† Kovarik, *Phil. Mag.* **20**, p. 849, 1910.

The results showed that only one β ray product having a period of 5 days was present. These observations were quite incompatible with the older view that two successive products of periods 5 and 6 days were produced. Giesel* found a β ray product of period 6 days which he separated with polonium and consequently called β -polonium. This is no doubt identical with radium E.

Radium E emits β rays which are absorbed exponentially with a value $\mu = 43$ (cms.)⁻¹ in aluminium. The β rays give a continuous spectrum and no resolution into homogeneous groups of rays has yet been observed. We have seen (Section 103) that radium E emits γ rays which are feeble in intensity and penetrating power.

206. Radium F (Polonium). We have seen that this product emits only α rays of range 3.8 cms. in air. The identity of radium F with the polonium of Mme Curie and the radio-tellurium of Marckwald was finally shown by comparison of the absorption of the α rays and of the periods of decay. The periods of decay found by various observers are shown below.

Substance	Half-value period in days	Observer
Radium F	138.2	St. Meyer and v. Schweidler†
α ray product from radio-lead	134.5	” ”
Radio-tellurium	136.5	” ”
Radio-active bismuth	138.9	” ”
Radium F	143	Rutherford‡
Radio-tellurium	143	”
Radio-tellurium	139.6	Marckwald and Greinacher§
Polonium	140.0	Mme Curie
Polonium	136	Regener¶

Considering the difficulty of determining such a long period with accuracy, the agreement of the numbers is excellent and

* Giesel, *Ber. d. D. Chem. Ges.* **39**, p. 780, 1906.

† Meyer and v. Schweidler, *Wien Ber.* **115**, p. 63, 1906.

‡ Rutherford, *Phil. Mag.* **10**, p. 290, 1905.

§ Marckwald and Greinacher, *Jahrb. d. Radioakt.* **2**, p. 136, 1905.

|| Mme Curie, *C. R.* **142**, p. 273, 1906; *Phys. Zeit.* **7**, p. 146, 1906.

¶ Regener, *Ber. d. D. Phys. Ges.* **13**, p. 1027, 1911.

shows the identity of the active matter under consideration. The half-value period is taken as 136 days, and $\lambda = \cdot 0051 \text{ (day)}^{-1}$. The latter value has been obtained by Regener when special precautions were taken to ensure complete saturation. It is seen that, after an interval of one year, $5/6$ of the polonium has been transformed. In a preparation of radium D, the amount of polonium present reaches a practical maximum in three years. It will finally decrease exponentially with the period of radium D.

207. Chemical properties of polonium. Polonium is separated from a uranium mineral with the bismuth that is ordinarily present. About 3 kilograms of bismuth oxychloride are usually obtained from one ton of Joachimsthal pitchblende. Mme Curie employed initially several methods of concentrating the polonium: (1) Precipitation by sulphuretted hydrogen in a strong hydrochloric acid solution. The polonium is concentrated in the sulphides. (2) Precipitation of basic nitrate with water. The polonium is concentrated in the precipitate. (3) Sublimation of mixed sulphide in a vacuum. The active sulphide is more volatile than that of bismuth.

We have referred in Section 8 to the separation by Marckwald of an intensely active preparation of polonium. By immersing plates of bismuth, copper or silver in the hydrochloric acid solution, practically all the polonium was deposited on the plates. Stannous chloride added to the same solution produced a small precipitate which consisted mainly of tellurium and contained most of the polonium. Methods were devised for separating the polonium from the tellurium. Finally 4 milligrams of intensely active material were obtained from two tons of material.

The separation of polonium on a bismuth or copper plate is a very simple and convenient method. With care the polonium may be obtained on a plate of very small area. An active plate of this kind is very useful in many experiments, for it emits homogeneous α rays and no β rays.

Polonium may always be obtained in considerable quantity from old preparations of radium. A preparation of radium D separated from radium is a convenient source for obtaining polonium at intervals.

The amount of polonium to be obtained from a uranium mineral can be simply calculated. The amount of polonium to be obtained from one gram of radium when radium D has reached its equilibrium value or from a mineral containing one gram of radium is nearly equal in grams to the ratio of the period of polonium to the period of radium, or about 0.19 milligram by weight.

Since a mineral containing 3 tons of uranium yields 1 gram of radium, it is seen how small a quantity of polonium can be obtained under the best conditions. Mme Curie and Debierne* recently made experiments to isolate a weighable quantity of polonium. Using several tons of pitchblende, about two milligrams of intensely active matter were finally obtained, probably containing about 1/10 milligram of pure polonium. The spectrum showed the presence of a number of elements but several new lines were observed, viz. 4642.0, 4170.5, 3193.6, 3652.1, which were ascribed to the spectrum of polonium. The line 4170.5 was strong. Several other lines were observed the connection of which with polonium was doubtful.

It can be calculated that one milligram of polonium in the pure state emits as many α particles as five grams of radium itself. An almost invisible amount of pure polonium will thus produce brilliant luminosity on phosphorescent screens which are brought near it. Mme Curie showed that the α rays from polonium produced chemical and physical effects similar to the corresponding rays from radium or its emanation.

Apart from the interest attaching to the isolation of a weighable quantity of polonium and the determination of its spectrum, it is of great importance to determine the substance into which polonium is transformed. There is strong reason to believe (Chapter XVIII) that, after the emission of a helium atom, polonium turns into lead. If this be correct, the spectrum of polonium should become feeble as the polonium decays, and the spectrum of lead should appear. The direct proof of the production of lead is obviously attended with great difficulties on account of the minute amount of polonium available for experiment.

After polonium has decayed, no residual activity has been

* Mme Curie and Debierne, *C. R.* **150**, p. 386, 1910.

observed, so that it is believed that the transformations of the uranium-radium series end at this stage, with lead as the final product.

In the following table various data in connection with radium and its series of products are collected for reference. In the third column, the weight of each product in equilibrium with one gram of radium is given.

Radium Series.

Radium Series	Atomic weight	Weight per gram of radium	Half-value period	Radiation	Range of α rays at 15° C.
Radium	226	1 gr.	2000 yrs.	$\alpha + \text{slow } \beta$	3.30 cms.
↓ Ra. Emanation	222	5.7×10^{-6} gr.	3.85 days	α	4.16 „
↓ Radium A	218	3.1×10^{-9} „	3.0 mins.	α	4.75 „
↓ Radium B	214	2.7×10^{-8} „	26.8 mins.	$\beta + \gamma$	—
↓ Radium C	214	2.0×10^{-8} „	19.5 mins.	$\alpha + \beta + \gamma$	6.57 „
↓ ↘ Ra. C ₂	—	—	1.4 mins.	β	—
↓ Radium D	210	8.6×10^{-3} „	16.5 yrs.	slow β	—
↓ Radium E	210	7.1×10^{-6} „	5.0 days	$\beta + \gamma$	—
↓ Radium F	210	1.9×10^{-4} „	136 days	α	3.77 „

CHAPTER XV.

ACTINIUM AND ITS PRODUCTS.

208. Separation of actinium. We have already referred to the history of the discovery of actinium in Section 7. Debierne*, in two papers published in 1899 and 1900, gave a brief account of the chemical properties of a new chemical element which he called actinium. It was stated that the chemical properties of this substance were similar to those of thorium, from which it had not been found possible to separate it. In 1902, Giesel† published an account of an active substance obtained from pitchblende. This body was separated with the cerium earths, and was ultimately obtained mixed with lanthanum. Giesel showed that this substance was characterised by the emission of a short-lived emanation, and for this reason he called it the emanating substance or "emanium." Emanium was not separated with thorium, and Giesel concluded that it could not be identical with actinium. Later Debierne‡ stated that his preparations also emitted an emanation similar to that found by Giesel for emanium. After some controversy§ it was finally agreed to retain the name of actinium for this substance. The chemical properties initially ascribed by Debierne to actinium are similar to those now known to belong to ionium. The rapid growth of radium observed by the writer in a preparation of emanium obtained from Giesel showed

* Debierne, *C. R.* **129**, p. 593, 1899; **130**, p. 906, 1900.

† Giesel, *Ber. d. D. Chem. Ges.* **35**, p. 3608, 1902; **36**, p. 342, 1903; **37**, p. 1696, 1904.

‡ Debierne, *C. R.* **139**, p. 538, 1904.

§ See Giesel, *Ber. d. D. Chem. Ges.* **37**, p. 3963, 1904; **38**, p. 775, 1905; Debierne, *Phys. Zeit.* **7**, p. 14, 1906.

that the latter substance certainly contained some ionium, and this no doubt was the case also with Debierne's preparations*. The identity of the emanations emitted by actinium and emanium were shown by Hahn and Sackur†. Marckwald‡ found some evidence that emanium and actinium were not the same substance but stood in a genetic relation with each other. The apparent difference was shown by Hahn§ to be due to the presence of a new product which he called "radio-actinium."

Giesel found that the activity of actinium preparations increased for a month after separation. This will be seen to be due to the production of a series of products by actinium. Giesel and Debierne have shown that actinium can be concentrated to some extent by fractional crystallisations of the double nitrate of the rare earths and magnesium, and also by precipitating barium as sulphate in the solution. By these methods preparations of actinium have been obtained showing about 100,000 times the activity of uranium. No new lines, however, have been observed in the spectrum, so that it appears probable that actinium, if it could be obtained in a pure state, would show an activity as great, if not greater than that of radium.

Auer von Welsbach|| made a number of experiments to separate actinium from the rare earths. He concludes that it has the chemical properties of an element between calcium and lanthanum. He found that actinium could be completely precipitated in the presence of manganese from basic solutions as a manganate, and used this method in separating the actinium from the mineral residues.

v. Hevesy¶ has found that the presence of actinium in uranium minerals can be shown directly by the emission of its short-lived emanation. A rapid current of air is aspirated through a solution of the mineral into an electroscope.

Far less is known about actinium itself as a radio-active element than of any other, for it has been found impossible to

* See Boltwood, *Amer. Journ. Sci.* **25**, p. 365, 1906.

† Hahn and Sackur, *Ber. d. D. Chem. Ges.* **38**, p. 1943, 1905.

‡ Marckwald, *Ber. d. D. Chem. Ges.* **38**, p. 2264, 1905.

§ Hahn, *Phil. Mag.* **13**, p. 165, 1907; *Ber. d. D. Chem. Ges.* **39**, p. 1605, 1906.

|| Auer von Welsbach, *Wien Ber.* **119**, 11 a, p. 1, 1910.

¶ v. Hevesy, *Phys. Zeit.* **12**, p. 1213, 1911.

isolate it from the rare earths with which it is mixed, or to locate its position in the scheme of transformations. The only evidence of its period is derived from some observations of Mme Curie*, who found a decrease of the β ray activity of old actinium preparations of about 10 per cent. in three years. This would give a mean life of actinium of about 30 years. If this be the case, it should not be difficult to locate the position of actinium in the uranium series, for the growth of actinium in its parent should be detectable within a few years. Taking into consideration the close analogy between the successive transformations of thorium and actinium, Mme Curie suggests that an unknown product of long period may exist between actinium and radio-actinium, which is separated with the actinium in excess of the equilibrium value. The decay observed would in that case be due not to actinium but to the new product.

Actinium freed from all its products is either rayless or emits radiations of very weak intensity. Actinium in equilibrium with its products emits α , β and γ rays. The β rays are only of moderate penetrating power. The γ rays, in comparison with the β rays, are relatively feeble and are much less penetrating than the γ rays from radium, thorium or uranium (Section 100).

209. Connection of actinium with the uranium series.

Boltwood† showed that the amount of actinium, measured by its activity, present in uranium minerals was approximately proportional to the percentage of uranium. This indicates that actinium, like radium, must belong to the uranium series and stand in some genetic relation with it. Boltwood, however, showed that the activity due to the actinium, together with its series of α ray products, separated from a mineral was much smaller than would be expected if actinium belonged to the main uranium-radium series. The total activity of actinium with its products in a mineral was only 0.28 of the activity of the uranium (see Section 169). Radium and its series of products, including polonium, showed an activity 3.06 times that of uranium, or 11 times that of actinium. This difference cannot be ascribed to the difference

* Mme Curie, *Le Radium*, 8, p. 353, 1911.

† Boltwood, *Amer. Journ. Sci.* 25, p. 269, 1908.

in the number of α ray products in the two cases, for actinium contains five α ray products of an average range greater than those of the radium products. There appears to be no doubt of the essential correctness of these conclusions. In order to explain this anomalous relation the writer* suggested that actinium was a branch product of the main series. In the majority of products, so far examined, the atom breaks up in only one way. For example, each atom of radium emanation emits one α particle and forms one atom of radium A. It seems not improbable, however, that the residue of an atom after losing an α or β particle may in some cases exist for some time in more than one stable form. The ejection of an α or β particle in the process of disintegration must result in a very violent disturbance of the atomic system, and this may lead to the formation of more than one arrangement of the component parts, which is temporarily stable. This would result in the appearance of at least two products in addition to the expelled α or β particle. These products, although of equal atomic weights, would probably have different chemical properties and be capable of separation from each other, and would be transformed in different ways. It is not necessary that the two products should be formed in equal amount. One might be formed in relatively large amount compared with the other. There are several other possibilities to be considered. The atom might break up into two parts of different atomic weight. In this case the number of atoms of each of the two products formed would be the same as for the parent product. If, for example, each atom emitted an α particle at disintegration, each of these products would supply the same activity as the parent substance.

In recent years some direct evidence has been obtained of the existence of such branch products. As we have seen (Section 198), Fajans concluded that the product radium C₂ of period 1.4 minutes derived from radium C must be a branch product. In a similar way Antonoff found some evidence that Ur Y is a branch product of uranium. It will be seen later that the mode of transformation of the product called thorium C is very anomalous and appears undoubtedly to indicate that the atoms of this substance can break up in two distinct modes.

* *Radio-active Transformations*, p. 170 (1906).

Taking the evidence as a whole, there is good reason to believe that actinium is a branch product at some point of the long uranium-radium series. There is as yet no definite evidence of its position in the scheme of changes. It may possibly be connected with the branch product Ur Y. The evidence obtained by Fajans of the absence of actinium in the active deposit of radium does not support the view that it can be derived from radium C₂. If it were possible to determine the atomic weight of actinium or of any of its products, the point of origin of actinium in the uranium series could be located. The only evidence bearing on the atomic weight is derived from comparison of the coefficients of diffusion of the thorium and actinium emanations (Section 142). The data so far obtained by this method indicates that the actinium emanation is of about the same atomic weight as the thorium emanation. Since the deduction of the atomic weight from the coefficient of diffusion involves the square of the period of decay of the emanation, a small error in the latter constant seriously affects the value deduced. The question is one that requires careful re-examination.

If actinium is genetically connected with uranium as a branch product, the ratio ρ of the number of atoms of actinium and radium formed per second in a mineral, can be approximately calculated from the measurements of their relative activity given by Boltwood. We have seen that the activity of radium together with its four α ray products in equilibrium with it is 3.0 times that of uranium. The activity of actinium together with its products is 0.28. Now the average range of the five groups of α rays from radium and its products is 4.3 cms. and for the five sets of α rays from actinium and its products is 5.1 cms. reduced to 0°C. Assuming the ionisation to be proportional to the range, it follows that the ratio $\rho = .08$, or in other words, only 8 per cent. of the atoms of the parent substance are transformed into actinium.

210. Analysis of the active deposit. It is convenient to consider first the products of the actinium emanation, for the former are obtained in a pure state by exposure of a metal plate to the actinium emanation.

Actinium A. We have seen that actinium preparations emit

an emanation of period 3.9 seconds (Section 131). The atom of the emanation breaks up with the emission of an α particle of range 5.7 cms. and gives rise to the atom of actinium A. This has the shortest life of any known product, for it is half transformed in 1/500 second. It breaks up with the emission of an α particle of range 6.5 cms. (Section 147). There appears to be no doubt that actinium A is a non-gaseous form of matter, but in consequence of its short life it is usually found associated with the emanation. At the moment of formation it carries a positive charge and is transferred to the negative electrode in a strong electric field. It

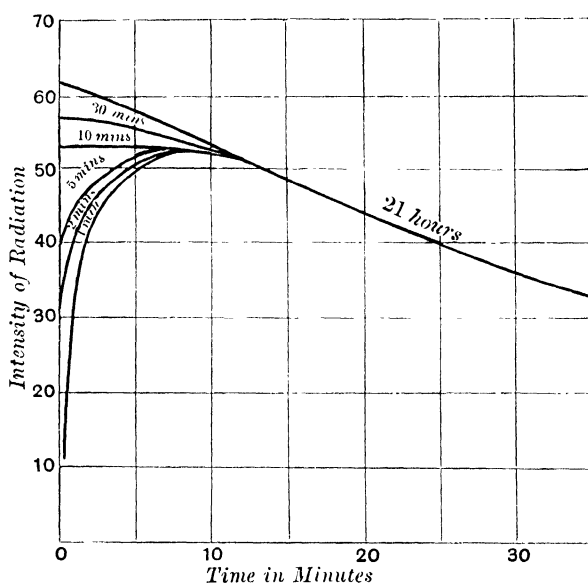

Fig. 117.

then gives rise to three successive products called actinium B, C and D, whose properties will now be considered.

Actinium B and C.* When a plate is exposed in the presence of the actinium emanation for several hours, it becomes active.

* To avoid confusion, it should be pointed out that the products here called actinium B and C were initially known as actinium A and B respectively. The change of nomenclature arose from the comparatively late discovery of the short-lived product of the emanation now called actinium A. A discussion of the reasons for the nomenclature of the active deposits adopted in this book was given by Rutherford and Geiger, *Phil. Mag.* **22**, p. 621, 1911.

The rate of decay of this active deposit which emits α , β and γ rays is independent of whether the activity is collected on the plate by diffusion or by the intermediary of an electric field. The initial part of the curve of decay measured by the α rays for a long exposure is shown in Fig. 117 (marked 21 hours). The activity falls slowly the first 10 minutes, but afterwards more rapidly, decreasing finally according to an exponential law with the time with a period of 36 minutes. No doubt, if observations were made within $1/500$ of a second after removal, the decay of activity due to actinium A could be observed. The half-value period was initially determined by Debierne*, who found a value of 40 minutes. Later observations by Bronson†, Elster and Geitel‡, Meyer and v. Schweidler§, Hahn and Sackur||, gave values of about 36 minutes.

Miss Brooks¶ found that the activity curves depended greatly on the time of exposure to the emanation. Examples of the α ray curves obtained by her for various times of exposure are shown in Fig. 117. The activity at first increases, passes through a maximum and ultimately decreases according to an exponential law with a period of 36 minutes. Bronson determined accurately the activity curve for a short exposure. This is shown in Fig. 118, the maximum activity being taken as 100. The shape of this curve indicated the presence of two products, one of which emits α rays and the other does not**. The activity I at any time is proportional to $e^{-\lambda_1 t} - e^{-\lambda_2 t}$. This is the relation (equation 5, Section 159) to be expected for a short exposure where two products are involved, one of which emits α rays and the other does not.

The final decrease of the activity according to an exponential law with a period of 36 minutes fixes the period of one product as 36 minutes. The corresponding value of $\lambda_1 = 0.0192 (\text{min.})^{-1}$. By comparison with the experimental curve, Bronson found the value of λ_2 to be $0.322 (\text{min.})^{-1}$. This corresponds to a product of period

* Debierne, *C. R.* **138**, p. 411, 1904.

† Bronson, *Amer. Journ. Sci.* **19**, p. 185, 1905.

‡ Elster and Geitel (see Giesel, *Ber. d. D. Chem. Ges.* **37**, p. 3963, 1904).

§ Meyer and v. Schweidler, *Wien Ber.* **114**, p. 1147, 1905.

|| Hahn and Sackur, *Ber. d. D. Chem. Ges.* **38**, p. 1943, 1905.

¶ Miss Brooks, *Phil. Mag.* **8**, p. 373, 1904.

** Rutherford, *Phil. Trans. Roy. Soc. A*, **204**, p. 169, 1904.

2·15 minutes. The difficulty here arises of determining which of the two products emits α rays (Section 165). This was settled by the observation of Miss Brooks* that in the electrolysis of the active deposit of actinium, an α ray product was separated, which decayed to half value in about 1·5 minutes. Later Meyer and v. Schweidler† showed that when a platinum plate coated with the active deposit of actinium was heated to a bright red heat, the residual α ray activity decayed with a period of about 1·5 minutes. In a similar experiment Hahn and Meitner‡ found that, correcting for the residual activity which decayed slowly, the α ray product decayed with a period of 2·15 mins.—a value in close agreement

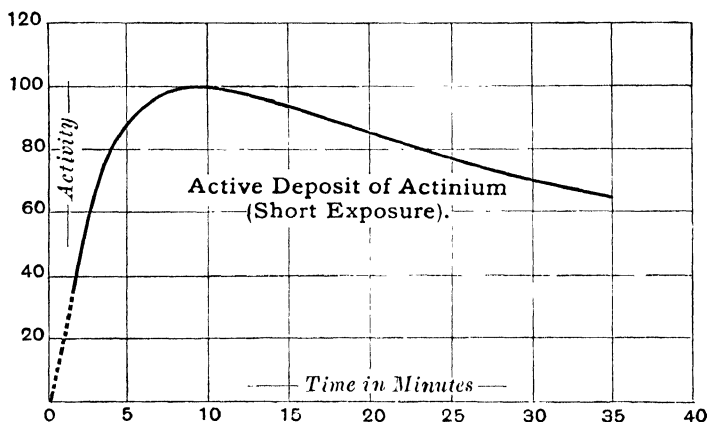

Fig. 118.

with the period deduced by Bronson from the activity curve. It was thus clear that the product of period 36 minutes was volatilised at a high temperature, and that the product of shorter period left behind emitted α rays. Levin§ showed that actinium B commenced to volatilise at 400° C. and actinium C at 700° C.

The active deposit thus consists of at least two successive products, viz. actinium B of period 36 minutes, which does not emit α rays, and actinium C of period 2·15 minutes which emits α rays.

* Miss Brooks, *Phil. Mag.* **8**, p. 373, 1904.

† Meyer and v. Schweidler, *Wien Ber.* **114**, p. 1147, 1905.

‡ Hahn and Meitner, *Phys. Zeit.* **9**, p. 649, 1908.

§ Levin, *Phys. Zeit.* **7**, p. 812, 1906.

Actinium D. The β and γ rays emitted from the active deposit were initially ascribed to actinium C. Hahn and Meitner*, however, showed later that another product, actinium D, of period about 5 minutes, followed actinium C. This product emitted β and γ rays, but no α rays. The presence of this substance is most simply shown by using the method of recoil. A negatively charged plate is brought near another parallel plate coated with the active deposit of actinium. After a few minutes' exposure the plate on removal shows a β ray activity which decays exponentially with a period, found by Hahn and Meitner, of 5.1 minutes. In this way about 20 per cent. of the total amount of actinium D formed in the interval of exposure is transferred to the recoil plate. Evidence of the existence of this product was obtained in several ways by Hahn and Meitner. If a platinum plate were exposed for a short interval to a high temperature, the actinium B and also the actinium D were almost completely volatilised. As we have already seen, the α ray activity due to actinium C, which is left behind, decays with a period of 2.15 minutes. Under similar conditions, however, the activity measured by the β rays rises at first, passes through a maximum after about 5 minutes, and finally decays exponentially with a period of 5.10 minutes. The increase of activity observed is due to the formation of actinium D by the transformation of actinium C. The decrease of activity is finally governed by the period of actinium D. It was also found that actinium D was separated out from a solution of the active deposit on spongy platinum and on carbon in the form of soot.

As the result of a number of concordant determinations of the decay of activity of actinium D obtained by recoil, Kovarik†, later, found its period to be 4.71 minutes.

Meyer and v. Schweidler‡ observed that a metal plate exposed for a long time in the presence of an actinium preparation showed a very small residual activity which decayed exponentially with a period of about 11 days. The origin of this activity was at first difficult to explain, but later Hahn§ showed that it was due

* Hahn and Meitner, *Phys. Zeit.* **9**, p. 649, 1908.

† Kovarik, *Phys. Zeit.* **12**, p. 83, 1911.

‡ Meyer and v. Schweidler, *Wien Ber.* **116**, p. 315, 1907.

§ Hahn, *Phys. Zeit.* **10**, p. 81, 1909.

to the recoil of actinium X during the transformation of radio-actinium. The recoil atoms carry a positive charge and are collected on the cathode.

211. Decay curves of the active deposit. For the ordinary practical cases of the calculations of activity curves, the effect of the short-lived product actinium A may be neglected and the three products B, C and D need only be considered. Since the third product of the deposit, viz. C, emits α rays and the fourth product D emits β rays, it is evident that the variation of β ray activity with time for a long or short exposure will be somewhat different from the curves given in Fig. 117 for α rays. For a short exposure, the β ray activity initially rises much less rapidly than the activity due to α rays and passes through a maximum later. For a long exposure, the activity due to β rays decreases more slowly for the first 10 minutes than for the α rays. The variation of β ray activity for a long exposure is proportional to the value of R (equation 12, Section 160), and for a short exposure to the value of R given by equation 6, Section 159, where $\lambda_1, \lambda_2, \lambda_3$ are the constants of decay of actinium B, C and D respectively. In a similar way, the rise or decay curve for any time of exposure can be deduced. Hahn and Meitner have shown that the experimental curves are in good agreement with the theory.

212. Actinium X. Godlewski* and Giesel† independently found at about the same time that a new product called actinium X could be separated from actinium preparations by treatment with ammonia. Actinium X is separated from actinium by the same method first employed to separate thorium X from thorium, and is similar to thorium X in chemical properties. On adding ammonia, the actinium is precipitated and actinium X remains in the filtrate. The active deposit is also removed with actinium X but is partially volatilised when the ammonium salts are driven off by heat. The α ray activity of the actinium X immediately after separation rises about 20 per cent., passes through a maximum and ultimately decays exponentially with a period, found by

* Godlewski, *Phil. Mag.* 10, p. 35, 1905.

† Giesel. *Jahrb. d. Radioakt.* 1. p. 345, 1904.

Godlewski, of 10.2 days. Godlewski showed that actinium X was the parent of the emanation, for the amount of emanation to be obtained from actinium X finally decreased at the same rate as its activity, while actinium deprived completely of actinium X initially gave off no emanation. The initial rise of the activity measured by α rays is due to the formation of the active deposit by the emanation. Actinium X emits α rays and some very easily absorbed β rays. Consequently, if actinium B and D are volatilised by strong heating of the preparation of actinium X, the β ray activity, as shown by Godlewski, is small at first but rapidly rises to a maximum in about four hours, and ultimately decays with the period of 10.2 days.

Debierne early found that barium precipitated in a solution of actinium showed an activity which decayed with the time. This was no doubt due to the separation of actinium X with the barium.

213. Radio-actinium. In the course of an examination of the activity of an actinium preparation freed from actinium X, Hahn* found that the activity increased to a maximum much more slowly than was to be expected if actinium were transformed directly into actinium X. This observation led to the discovery of radio-actinium, an α ray product intermediate between actinium and actinium X. It is in general difficult to effect a complete separation of radio-actinium from actinium. Hahn employed the following methods. On adding ammonia to an actinium solution, radio-actinium precipitates earlier than the actinium. In this way, by successive precipitations, it is possible to obtain radio-actinium almost free from actinium and actinium X. By adding hyposulphite of sodium to a hydrochloric acid solution of actinium, amorphous sulphur separates out and entrains the radio-actinium with it. On filtering off the sulphur and heating it, the radio-actinium is left behind.

The variation of α ray activity with time of a nearly pure preparation of radio-actinium is shown by the full curve I in Fig. 119. The α ray activity increases at first, passes through a maximum after about 17 days, and finally decreases exponentially

* Hahn, *Phil. Mag.* **12**, p. 244, 1906; **13**, p. 165, 1907.

with a period of 19.5 days, corresponding to the period of radio-actinium. The decay curve of radio-actinium by itself is shown on the dotted curve III. The rise of activity shown in curve I is due to the formation of actinium X and its successive products from the radio-actinium. This was proved by separating actinium X from a preparation of radio-actinium after reaching its maximum. The activity provided by actinium X and its products is shown by the dotted curve II. Curves II and III add up to form curve I.

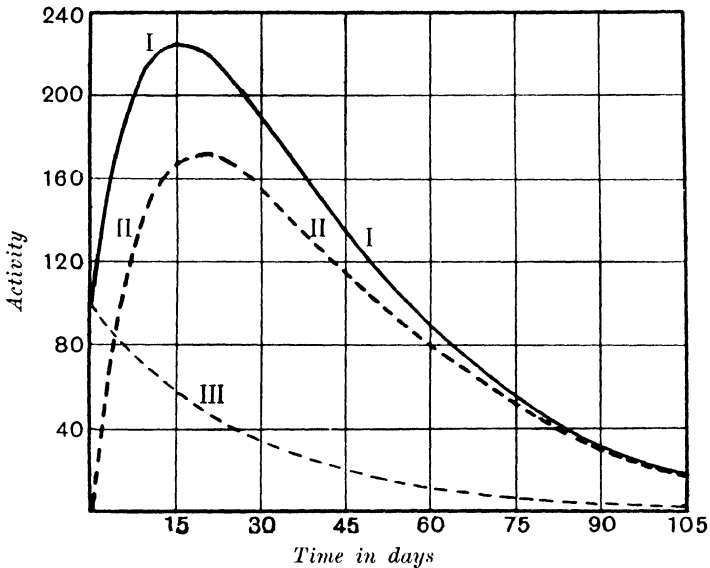

Fig. 119.

Since the successive products of actinium X are all of short period compared with that of radio-actinium or of actinium X, the calculation of the rise of activity of actinium with time corresponds to the case of two successive changes. The α ray activity at any time is proportional to $\lambda_1 P + k\lambda_2 Q$ where λ_1 , λ_2 are the constants of transformation of radio-actinium and actinium X respectively; P and Q are given by equations 1 and 5 (Section 159).

Since α rays are emitted by actinium X and three of its later products, it would be expected that $k=4$ about. Hahn found a good agreement between the calculated and experimental values taking $k=3.5$.

Levin*, who independently had obtained some evidence of the existence of radio-actinium, found that actinium deprived of all its actinium X showed a residual α ray activity of 25 per cent. of the equilibrium value. By removing as completely as possible all the radio-actinium as well as actinium X, Hahn found that the α ray activity of actinium itself could be reduced to about 2 per cent. of the equilibrium value. The rise curve, found by Hahn, is shown by the full curve in Fig. 120. The activity rises slowly at first and reaches half its maximum value after an interval of about 33 days, and requires 150 days to reach a practical maximum. The activity at any time is proportional to $\lambda_1 P_1 + k\lambda_2 Q$

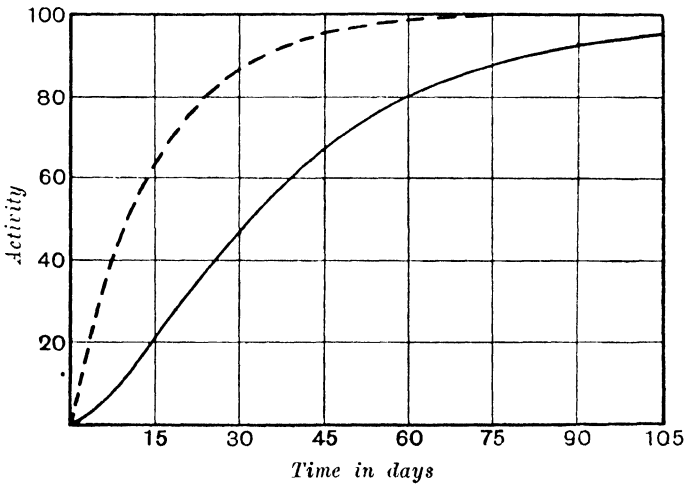

Fig. 120.

where P_1 and Q_1 are given by equations 18 and 19 in Section 162. Hahn showed that the experimental rise curve was in close agreement with theory. The rise curve to be expected if actinium changed directly into actinium X is shown by the dotted curve in the figure.

214. Radiations from actinium and its products. We have seen that Hahn was able to reduce the α ray activity of actinium to about 2 per cent. of the maximum. This indicates that actinium does not emit α rays. Levin (*loc. cit.*) showed that the β ray activity of actinium deprived completely of actinium X

* Levin, *Phil. Mag.* 12, p. 177, 1906.

sank to 5 or 6 per cent. of the maximum value. Since Hahn and Meitner found later that radio-actinium emits some penetrating β rays, the residual β radiation in actinium plus radio-actinium may have been due to the latter. The evidence is not sufficient to decide definitely whether actinium is rayless. If soft β rays were emitted, they would be difficult to detect by the electric method under ordinary conditions.

Hahn determined by the Bragg method the ranges of the α rays from actinium products. Some of the numbers have required correction as the short-lived α ray product, actinium A, was not known at the time of the experiments (see Section 147).

Hahn and Meitner* later made a systematic examination of the products of actinium which emit β rays. The greater part of the penetrating radiation arises from actinium D. The β rays from this substance are half absorbed in 0.24 mm. of aluminium. They also found some soft β rays from radio-actinium which were half absorbed in 0.04 mm. of aluminium. Evidence was also found of the presence of some penetrating β rays. Actinium B is not rayless but emits soft β rays.

Mlle Blanquies† has found some evidence that the α rays emitted from actinium C are complex. The Bragg curve showing the variation of the ionisation along the path of a pencil of α rays from actinium C was slightly different from the corresponding curves for simple α ray products like radium C and polonium. Further experiments gave some indication that actinium C was complex and consisted of two α ray products. These results, however, lack confirmation‡.

The two products radium C and thorium C both break up in an abnormal way. From the close analogy between the C products of the radium, thorium and actinium series, it might be expected that actinium C would show some peculiarities in its mode of transformation. Further investigation is required to clear up this point.

It will be shown later (Chapter XVIII) that there is a most

* Hahn and Meitner, *Phys. Zeit.* **9**, p. 697, 1908.

† Mlle Blanquies, *C. R.* **151**, p. 57, 1910; *Le Radium*, **6**, p. 230, 1909; **7**, p. 159, 1910.

‡ See also Moseley and Fajans, *Phil. Mag.* **22**, p. 629, 1911.

remarkable analogy between the modes of transformation and the chemical properties of the products of the actinium and thorium series. The products A, B, C, D exhibit a similar gradation of properties for both elements. Strömholm and Svedberg* showed that actinium X and thorium X are undistinguishable as regards chemical properties and probably belong to the group of alkaline earths. Radio-actinium has properties closely allied to thorium, while actinium has properties intermediate between calcium and lanthanum. Neither actinium, radio-actinium nor actinium X is appreciably volatilised at a red heat under ordinary experimental conditions.

215. Actinium series. The series of transformation products of actinium and some of their constants are given in the table below. In the absence of any definite knowledge of the place of origin of actinium in the uranium series, it is not possible to give the atomic weights of actinium or of its products. Taking the unknown atomic weight of actinium as A , the relative atomic weights are given in the second column. An expulsion of an α particle is supposed to lower the atomic weight by four units.

Actinium Series.

Actinium Series	Atomic weight	Half-value period	Radiation	Range of α rays at 15° C.
Actinium ...	A	?	rayless	—
↓				
Radio-actinium	A	19·5 days	$\alpha + \beta$	4·60 cms.
↓				
Actinium X ...	$A - 4$	10·2 days	α	4·40 „
↓				
Emanation ...	$A - 8$	3·9 secs.	α	5·70 „
↓				
Actinium A ...	$A - 12$	·002 sec.	α	6·50 „
↓				
Actinium B ...	$A - 16$	36 mins.	slow β	—
↓				
Actinium C ...	$A - 16$	2·1 mins.	α	5·40 „
↓				
Actinium D ...	$A - 20$	4·71 mins.	$\beta + \gamma$	—

* Strömholm and Svedberg, *Zeitschr. Anorg. Chem.* **63**, p. 197, 1909.

CHAPTER XVI.

THORIUM AND ITS PRODUCTS.

216. We have given in Section 4 a brief statement of the discovery of thorium and of its radio-active properties. In this chapter, the long series of transformations occurring in thorium will be discussed in some detail. For clearness, it is desirable first of all to consider the transformation of the thorium emanation. We have seen (Section 130 *et seq.*) that thorium compounds emit a characteristic emanation of period 54 seconds. On exposing a negatively charged plate in the presence of the emanation, it becomes coated with the active deposit. The concentration of the deposit on the cathode in an electric field shows that the carriers of the active matter have a positive charge. In the absence of an electric field, the surface of all bodies in contact with the emanation becomes active by diffusion of the carriers.

Thorium A. We have seen in Section 147 that an α ray product of short life was found by Geiger to be always associated with the thorium emanation. This substance, called thorium A*, is the first product of the emanation. The latter breaks up with the emission of an α particle and the residue of the atom becomes

* To avoid confusion, it should be pointed out that the product here called thorium B was initially known as thorium A. The complex product here called thorium C was initially considered as two and called thorium B and thorium C. The name, thorium D, remains unchanged. The alteration of nomenclature arose from the comparatively late discovery of the product in the emanation now called thorium A. A discussion of the reasons for the nomenclature, which is adopted in this book, was given by Rutherford and Geiger (*Phil. Mag.* **22**, p. 621, 1911).

the atom of thorium A. Geiger* and Rutherford and Geiger† showed that the atoms of thorium A were initially charged positively, and were transferred to the cathode in a strong electric field. Thorium A breaks up with the emission of α particles and is transformed into thorium B. The period of thorium A was measured by Moseley and Fajans‡ and found to be 0.14 second. Under ordinary experimental conditions, thorium A has practically disappeared before the activity of the deposit on a plate which has been exposed to the emanation can be measured. The activity on removal is then due to the products thorium B, C and D.

The range of the α particles from the emanation and thorium A are not very different. Barratt by the scintillation method found the ranges of the α particles from the emanation and thorium A to be 5.0 and 5.4 cms. respectively. Geiger and Nuttall by the electric method found the corresponding values 5.0 and 5.7 cms. at 15° C.

There appears to be no doubt that thorium A behaves as a non-gaseous substance. Its association with the emanation under ordinary conditions is due to the shortness of its life, for the greater part of it is transformed *in situ* before it has time to diffuse to the surface of the containing vessel. As we have seen, it is most conveniently separated by concentration on the cathode in an electric field.

Thorium A is very analogous in all its properties to the corresponding product of the actinium emanation, actinium A, of period 1/500 second.

217. Thorium B and C. If a plate be exposed for several days in the presence of a constant supply of thorium emanation, the activity on removal decays slowly at first, but after a few hours decreases exponentially with the time with a period of 10.6 hours. The decay of the active deposit is practically the same whether α , β or γ rays are used for measurement. The curve of decay for a long exposure is shown in Fig. 121, curve *BB*.

* Geiger, *Phil. Mag.* **22**, p. 201, 1911.

† Rutherford and Geiger, *Phil. Mag.* **22**, p. 621, 1911.

‡ Moseley and Fajans, *Phil. Mag.* **22**, p. 629, 1911.

The variation of activity with time was shown by Rutherford and Miss Brooks* to depend upon the time of exposure to the emanation. The curve for a short exposure of a few minutes is shown in Fig. 121, curve *AA*. The activity starts nearly from zero, passes through a maximum after about 220 minutes and ultimately decays with the time with a period of 10.6 hours. Miss Brooks† has examined the variation of activity for different times of exposure. The analysis of the activity curves was given by the writer‡. The observations were shown to accord with the assumption that thorium B, which does not emit either α rays or penetrating β and γ rays is transformed into thorium C which emits α , β and γ rays.

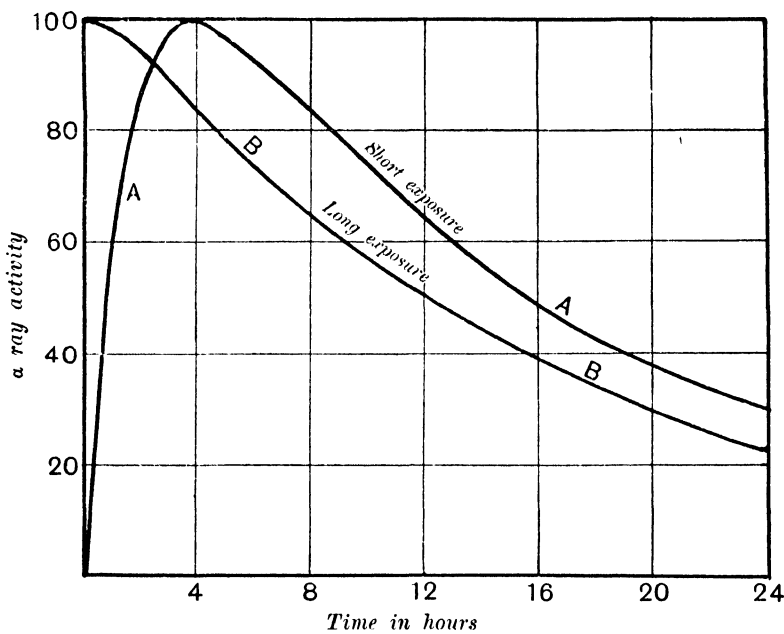

Fig. 121.

If P_0 be the amount of thorium B deposited during a short exposure, the amount Q of thorium C existing at a time t later is given by equation 5, Section 159, viz.

$$P = P_0 e^{-\lambda_1 t}, \quad Q = \frac{P_0 \lambda_1}{\lambda_2 - \lambda_1} (e^{-\lambda_1 t} - e^{-\lambda_2 t}),$$

* Rutherford and Miss Brooks, *Phil. Mag.* **4**, p. 1, 1902.† Miss Brooks, *Phil. Mag.* **8**, p. 373, 1904.‡ Rutherford, *Phil. Trans. A*, **204**, p. 169, 1905.

where λ_1 , λ_2 are the constants of thorium B and C respectively. The activity measured by the α rays is proportional to Q . The final exponential decay with a period of 10.6 hours fixes the period of one of the products, say thorium B, as 10.6 hours. The comparison of theory with experiment shows that the other product has a period of about 1 hour. As we have seen in Section 165, it is impossible to decide from the activity curve whether thorium B or C has the longer period of 10.6 hours. This question has been settled by the discovery of several methods of separating thorium B from thorium C. Miss Slater* showed that thorium B could be separated from thorium C by their difference in volatility. A platinum wire coated with the active deposit was heated for several minutes to a temperature of about 1000°C . Thorium B was completely volatilised and the activity of the wire measured by the α rays was then found to diminish exponentially with the time with a period of about 1 hour. This showed that the α ray product, thorium C, had the shorter period, and that the period of 10.6 hours must be ascribed to thorium B.

By exposing the wire for a few minutes to a temperature under 700°C ., the α ray activity of the wire was not diminished, showing that thorium C was not volatilised at this temperature, but the decay afterwards was always more rapid than the normal. The volatilised thorium B was collected on a cold cylinder surrounding the wire. The curve for the variation of the activity of the cylinder with time was identical with curve AA, Fig. 121, for a short exposure to the emanation. This is to be expected if thorium B alone is volatilised from the wire. By heating the wire to 1200°C ., all the thorium C was volatilised.

Miss Slater also observed that an active plate exposed to the cathode rays in a vacuum tube lost some of its activity. In this case the apparent volatilities of the products were reversed, for it was shown that thorium C was more readily removed from the plate than thorium B.

The results obtained by v. Lerch† and Pegram‡ by electrolysis of a solution of the active deposit also showed that two products

* Miss Slater, *Phil. Mag.* 9, p. 628, 1905.

† F. v. Lerch, *Ann. d. Phys.* 12, p. 745, 1903; *Wien Ber.* 114, p. 553, 1905

‡ Pegram, *Phys. Rev.* 17, p. 424, 1903.

were present. The activity on the electrodes was found to decay abnormally, falling to half value in times varying from 1 to 5 hours. These results showed that the matter obtained by electrolysis consisted of thorium B and C in varying proportions. F. v. Lerch* found that pure thorium C was deposited on a nickel plate placed in a solution of the active deposit. The decay of the activity on the nickel was exponential with a period of 60 minutes. Levin†

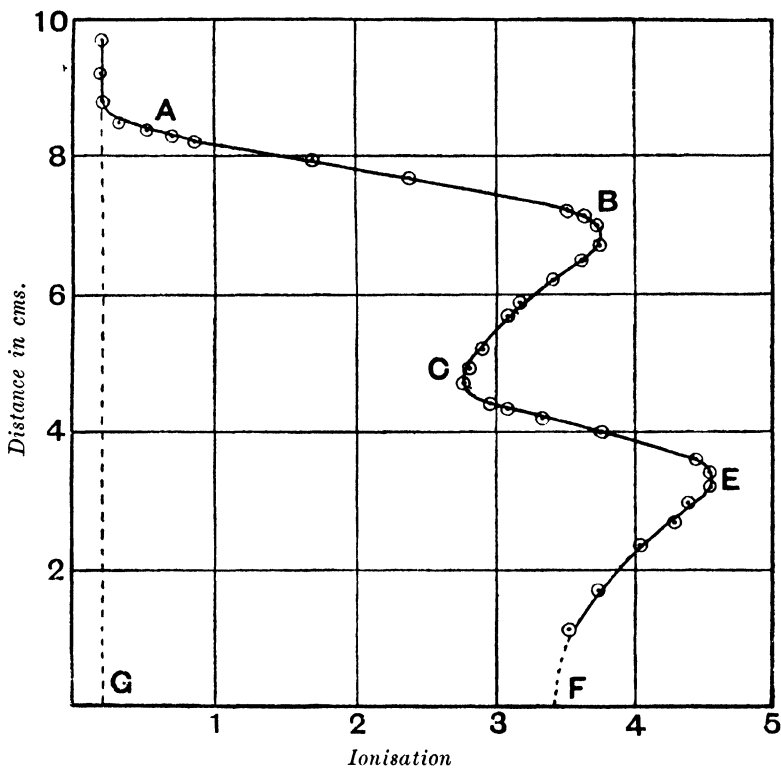

Fig. 122.

found that by adding carbon in the form of soot to a solution of thorium B + C, the thorium C was removed with the carbon and B remained in solution.

F. v. Lerch found that thorium B is not rayless as at first supposed but emits soft β rays. Hahn found the coefficient of absorption of these rays in aluminium to be 175 (cms.)^{-1} . The

* F. v. Lerch, *Ann. d. Phys.* **12**, p. 745, 1903; *Wien Ber.* **114**, p. 553, 1905.

† Levin, *Phys. Zeit.* **8**, p. 129, 1907.

velocities of the groups of β rays emitted have already been given in Section 95.

218. Complex nature of thorium C. In examining the range of the α particles from the active deposit of thorium by Bragg's method (Section 66), Hahn* showed that two groups of α rays of distinct range were present. The ionisation curve obtained by him is shown in Fig. 122. It is clear from the figure that one set of α rays has a range of 8.6 cms., and the other a range of 5.0 cms. The ranges were redetermined by Marsden and Barratt who found values in good accord, viz. 4.8 and 8.6 cms. From these results it was at first concluded that two successive α ray products were present. It was found impossible to separate these two products by chemical or physical methods, and for this and other reasons it was supposed that the product emitting rays of range 8.6 cms. had probably a short period of transformation.

A more detailed examination, however, has indicated that the two α ray products in thorium C are not successive. If the products were successive, it would be expected that the second would be separated by recoil from the first. Hahn†, however, could obtain no evidence of separation by this method. This result was confirmed by Geiger and Marsden under such conditions that if the α ray product were separated by recoil, it would be detected even if its period were of the order of a millionth of a second. Bronson‡ and Geiger and Marsden§ also showed that for three α particles emitted by the emanation plus the active deposit in equilibrium with it, one only was contributed by thorium C. Since there are only three α ray substances concerned, viz. the emanation, thorium A and thorium C, it is clear that the number of α particles emitted from thorium C corresponds to only one product in equilibrium with the emanation. Further light has been thrown on the question by Marsden and Barratt||. They found that the α particles from thorium C of range 4.8 and range 8.6 cms. were not equal in number as at first supposed, but

* Hahn, *Phil. Mag.* **11**, p. 793, 1906.

† Hahn and Meitner, *Verh. d. D. Phys. Ges.* **11**, p. 55, 1909.

‡ Bronson, *Phil. Mag.* **16**, p. 291, 1908.

§ Geiger and Marsden, *Phys. Zeit.* **11**, p. 7, 1910.

|| Marsden and Barratt, *Proc. Phys. Soc.* **24**, p. 50, 1911.

that .65 of the total number was of the longer range and .35 of the shorter range. Considering the evidence as a whole, it appears certain that thorium C breaks up in two distinct ways. The nature of the anomalous transformation of thorium C has been examined in detail by Marsden and Darwin*. The two component products generally included under the name thorium C, one of which emits α rays of range 4.8 and the other of range 8.6 cms., will for convenience be called thorium C₁ and thorium C₂ respectively. It was found that thorium C₁ and C₂ always appear together in constant ratio, and that it was impossible to effect a separation either by physical or chemical methods or by recoil from thorium B. They found, however, that thorium C emitted some β rays of greater penetrating power than those from thorium D. This was confirmed by measurements of the relative penetrating power of the β radiation from thorium B + C + D, C + D, and D. On the other hand, thorium C gave out little, if any, γ radiation compared with thorium D. The efficiency of the recoil of thorium D from thorium C was 12 per cent. when measured by β rays and 30 per cent. when measured by γ rays. Similar results were independently obtained by Hahn and Meitner†.

In explanation of these results, Marsden and Darwin suggest that the atoms of thorium C are transformed in two distinct ways. On the average about one-third of the atoms breaks up with the emission of α rays of range 4.8 cms. and two-thirds with the emission of β rays. The α ray transformation gives rise to thorium D, which breaks up with emission of β and γ rays, and the β ray transformation to thorium C₂ which breaks up with the emission of swift α particles of range 8.6 cms. It is seen that the order of transformation with regard to the emission of an α or β particle is reversed in the two branches.

The transformation of the active deposit discussed above is shown in the diagram. The letter α or β in the direction of the arrow, indicates the direction of the transformation of that component of the product which emits α or β rays. It would appear that the end product of both branches should have the same atomic weight.

* Marsden and Darwin, *Proc. Roy. Soc. A*, **87**, p. 17, 1912.

† Hahn and Meitner, *Phys. Zeit.* **13**, p. 390, 1912.

This system of transformation not only agrees with the experimental facts but also is not contrary to the relation found by Geiger and Nuttall (Chap. XVIII) between the range of the α particles and the period of transformation of the products. On this rule the period of thorium C₂, which emits the swiftest α particles known, is of the order of 10^{-12} seconds.

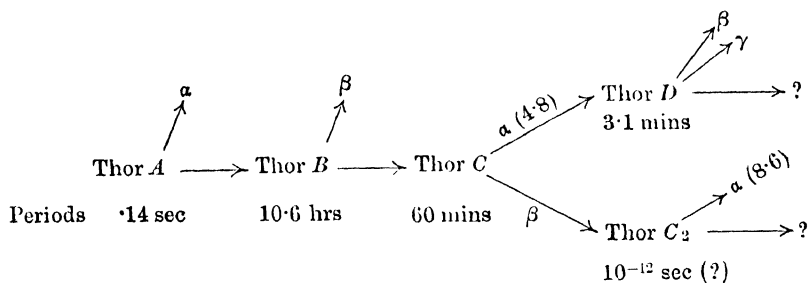

Further important evidence on this question has been obtained by L. Meitner*. By a special chemical method, she has succeeded in separating the two components of thorium C. A few drops of stannous chloride were added to a weak hydrochloric acid solution of the active deposit of thorium and several nickel plates were dipped successively into the boiling solution. The residue was then rapidly evaporated to dryness and the rise curves were measured by α rays and also by γ rays. The γ ray curve started from the origin while the α ray curve started from a minimum of 17 per cent. Without the addition of stannous chloride, the α and γ ray rise curves both start from the origin. These results indicate that nickel in the presence of stannous chloride separates only one component of thorium C. The component above designated C_a remains behind with thorium B. It would appear that the transformation of thorium B, rather than of thorium C, is anomalous and gives rise to two products.

This anomalous transformation is of great interest and importance, for it is the most definite example of a single substance which has two distinct modes of transformation. We have already seen (Section 198) that radium C also breaks up in two ways, but in a very different relative proportion to those observed in the present case.

* L. Meitner, *Phys. Zeit.* **13**, p. 623, 1912.

219. Thorium D. It was at first supposed that the β and γ rays from the active deposit arose entirely from the product thorium C. Hahn and Meitner* showed, however, that the emission of β and γ rays belonged to a successive product of thorium C, which will be called thorium D. Thorium D is most simply separated by the method of recoil. A negatively charged plate is exposed for a short interval above a plate coated with the active deposit. On removal the activity on the recoil plate is due entirely to β and γ rays, and decays exponentially with a period of 3.1 minutes. The amount received by recoil is proportional to the amount of thorium C present, and there appears to be no doubt that thorium D is to be regarded as the successive product of thorium C. Hahn and Meitner also succeeded in separating thorium D by chemical methods. Thorium D is entrained by precipitation with hydrogen sulphide or by the addition of animal charcoal to a solution of the active deposit. v. Lerch and v. Wartburg† found that thorium D was readily separated from the active deposit by heat. It volatilises more easily than thorium B or C.

It is at present not certain whether thorium D is formed as a result of each of the two modes of transformation of thorium C or whether it arises from only one of them, although we have seen in the last section that the latter is more probable. There appears to be no doubt that the separation of thorium D by recoil is a consequence of the expulsion of an α particle. Some light may be thrown on the origin of thorium D by an examination of the range of the recoil atoms of thorium D in air at reduced pressure.

Hahn and Meitner‡ found that the β rays from thorium D were absorbed exponentially with a coefficient of absorption in aluminium of about $\mu = 15$ (cms.)⁻¹. The velocities of the component groups of rays emitted from this product have already been given in Section 95. The γ rays from thorium D are slightly more penetrating than those emitted from radium C.

No residual activity has been observed after sufficient time

* Hahn and Meitner, *Verh. d. D. Phys. Ges.* **11**, p. 55, 1909.

† v. Lerch and v. Wartburg, *Wien Ber.* **118**, p. 1575, 1909.

‡ Hahn and Meitner, *Phys. Zeit.* **9**, p. 321, 1908.

has elapsed for the complete decay of the ordinary active deposit. Consequently thorium D is to be regarded as the last active product of the thorium series. The question as to the nature of the end product will be discussed later in Chapter XVIII.

220. Thorium X. An account of the discovery and properties of thorium X has already been given in Chapter VIII, Section 123. Thorium X is most simply separated from thorium salts by precipitation of the thorium by ammonia. The thorium X then remains in the solution. Rutherford and Soddy showed that thorium X was the parent of the thorium emanation, for the amount of the latter was always proportional to the amount of thorium X and decayed with it. Rutherford and Soddy found that the period of thorium X was about 4 days. Later observations by v. Lerch* and Levin† fixed the period as 3.65 days. By the ammonia method of separation, thorium X is separated by itself without the active deposit. In consequence of the production of the active deposit through the intermediary of the emanation, there is an initial rise of α ray activity of about 20 per cent. during the first twenty-four hours. After passing through a maximum, the activity ultimately decays with the period of thorium X, viz. 3.65 days.

Geiger and Nuttall have found that thorium X emits α rays of range about 4.3 cms. at 15° C. The variation of activity of thorium X with time can be simply calculated assuming that it is separated without the active deposit. We may neglect without sensible error the effects due to the quick period products, viz. the emanation and thorium A. Thorium X may be supposed to be transformed directly into thorium B and the latter into thorium C. Remembering that thorium X, the emanation, thorium A and thorium C emit α rays, while thorium B emits only soft β rays, the number of α particles emitted at any time t is given by $3\lambda_1 P + \lambda_3 R$ where λ_1 , λ_2 , λ_3 are the constants of thorium X, thorium B and thorium C respectively, and P and R are given by equations 5 and 6, Section 159. The activity measured by the electric method at any time t is proportional to

* v. Lerch, *Wien Ber.* **114**, p. 553, 1905.

† Levin, *Phil. Mag.* **12**, p. 177, 1906.

$3\lambda_1\dot{P} + k\lambda_3R$ where k is about 1.3, but its value depends on conditions of measurement.

The variation of activity of thorium after complete removal of thorium X can be calculated in a similar way. The activity curves have already been given in Fig. 84.

Schlundt and Moore* showed that thorium X could be separated from thorium if pyridine, fumaric acid, or meta-nitro benzoic acid were used instead of ammonia. With these reagents thorium B is separated with the thorium X, so that there is not the same initial rise of activity of the latter or decay of activity of the thorium, observed as when ammonia is used. If thorium is to be prepared freed as far as possible from the active deposit as well as from thorium X, these reagents are to be preferred.

Thorium X has chemical properties similar to the alkaline earths. It cannot be separated from radium nor from mesothorium. Strömholm and Svedberg† made a number of experiments upon the crystallisation of numerous salts mixed with a solution of thorium X. In most cases, thorium X was left in the mother liquor, but in the case of barium the relative concentration remained the same in the crystals and in the solution. They concluded that thorium X was isomorphous with barium and had similar chemical properties.

Thorium X can be separated by electrolysis in an alkaline solution. The active deposit present in a solution of thorium X can be electrolysed from an acid solution, leaving the thorium X behind.

221. Radiothorium. It was initially supposed that thorium X was derived directly from the transformation of thorium itself. Later investigation has revealed the presence of three products which intervene, known as mesothorium 1 and 2 and radiothorium. In examining some residues obtained from the separation of thorium from the mineral thorianite, Hahn‡ found that a new and

* Schlundt and Moore, *Journ. Phys. Chem.* **9**, p. 682, 1905.

† Strömholm and Svedberg, *Zeitsch. Anorg. Chem.* **61**, p. 338, 1909; **63**, p. 197, 1909.

‡ Hahn, *Proc. Roy. Soc. A*, **76**, p. 115, 1905; *Jahrb. d. Radioakt.* **2**, p. 233, 1905.

very active substance was present which he called radiothorium. This substance formed thorium X and some days after preparation gave off the thorium emanation freely. There is no doubt that radiothorium is the direct parent of thorium X. Hahn* found that radiothorium emitted α rays of range 3.9 cms., and decayed with a period of about two years.

G. A. Blanc† independently about the same time made a number of interesting observations which showed the presence of a new radio-active element in the sediment deposited by the hot springs of Echaillon, and of Salins Moutiers. This sediment was found to emit the emanation characteristic of thorium, and to give rise to the corresponding active deposit. In later work, he was able to separate from the sediment a new substance far more active than thorium itself, which gave rise to thorium X and its characteristic products. This substance was found to be identical with the radiothorium obtained by Hahn from thorianite. Blanc determined the period of decay of radiothorium and found it to be 737 days. Later observations have shown that radiothorium has properties so closely allied to thorium that it has not been found possible to separate one from the other. In the light of later results, it is clear that the radiothorium obtained by Hahn from the thorianite residues was not directly separated from the thorium but had been formed afresh from the parent substance, mesothorium, left in the residues.

Since radiothorium has chemical properties similar to thorium, it is precipitated from a solution of mesothorium by ammonia, the mesothorium remaining in the filtrate. This is the simplest way of obtaining very active preparations of radiothorium freed from mesothorium. No doubt the radiothorium separated by Blanc from the sediment of the hot springs was derived from mesothorium which had been dissolved in the water and brought to the surface.

222. Mesothorium. After the discovery of radiothorium, it was supposed that radiothorium was formed directly from

* Hahn, *Phil. Mag.* **12**, p. 82, 1906.

† G. A. Blanc, *Phys. Zeit.* **6**, p. 703, 1905; **7**, p. 620, 1906; **8**, p. 321, 1907.

thorium itself. In 1906, Boltwood* and McCoy and Ross† independently made a comparison of the relative activity of a number of thorium minerals. The activity of the mineral in the form of thin films was compared by the electroscopic method. After correcting for the activity due to the uranium which was present in some of the minerals, they found that the activity of the thorium in the mineral was proportional to its percentage content of thorium. The specific activity of the oxides prepared directly from the minerals was found one month after separation to correspond to that due to the thorium in equilibrium in the mineral. On the other hand, the activity of the oxides obtained from commercial salts possessed a much smaller activity, in some cases not more than half of the normal amount. Dadourian‡ confirmed these results by measurements of the amount of thorium emanation evolved by a solution of the thorium salt or of a mineral. The amount of emanation was compared by measuring the activity of the deposit obtained by exposing a negatively charged plate in the presence of the emanation. Since radiothorium forms thorium X and the latter the emanation, the amount of emanation or of its active deposit should be proportional to the amount of radiothorium contained in the solution. In this way, Dadourian found that the amount of radiothorium in commercial preparations was in some cases less than half of the equilibrium amount. Similar results were observed by Eve§ by comparing the intensity of the γ rays emitted by the mineral and by commercial preparations. It was at first natural to suppose that the deficiency of radiothorium was due to the separation of part of it from the thorium during the chemical processes of purification. On this assumption, Boltwood deduced from his measurements of the activity of commercial thorium preparations that the period of radiothorium must be as long as six years. This result was communicated to

* Boltwood, *Amer. Journ. Sci.* **21**, p. 415, 1906; **24**, p. 93, 1907; *Phys. Zeit.* **8**, p. 556, 1907.

† McCoy and Ross, *Amer. Journ. Sci.* **21**, p. 433, 1906; *Journ. Amer. Chem. Soc.* **29**, p. 1709, 1907.

‡ Dadourian, *Amer. Journ. Sci.* **21**, p. 427, 1906.

§ Eve, *Amer. Journ. Sci.* **22**, p. 477, 1906.

Hahn, who had found at this time by direct measurement that the radiothorium discovered by him had a period of transformation of about two years.

In order to reconcile these apparent differences, Hahn suggested that an unknown rayless product intervened between thorium and radiothorium, which was separated from the thorium during the process of purification. Hahn* was soon after able to verify this supposition by observations of the relative activity of commercial preparations of known ages supplied by Knöfler and Co. He found that the activity of thorium preparations was normal immediately after separation but gradually decreased with age to a minimum after an interval of 4.6 years. The activity then rose again slowly towards the initial normal value. The variation of activity with time is similar to curve III, Fig. 105, Section 167. Taking the period of radiothorium as 2 years, he deduced from the activity curve that the intermediate substance did not emit α rays and was half transformed in about 5.5 years. A similar value was deduced by McCoy and Ross (*loc. cit.*). This new substance was called *mesothorium*. On these assumptions, the variation of α ray activity with the age of the thorium preparation has been discussed in detail in Section 167. The resultant curve there given is in good agreement with the observed curve.

Boltwood afterwards showed that mesothorium was separated from thorium by the same process required to separate thorium X, viz. by precipitation of the thorium with ammonia. The mesothorium remains in the filtrate. The activity of the preparation of thorium X was found to decrease slowly to a small fraction of its initial value. After passing through a minimum, the activity was found to increase slowly but steadily with time. The preparation was found later to emit freely thorium emanation. The mesothorium in this case had been removed with the thorium X. It at once commenced to form radiothorium and the latter gave rise to the successive products, viz. thorium X, the emanation, and the active deposit. This method affords a very simple means of obtaining preparations of mesothorium directly from thorium salts. It is obviously an advantage to use a thorium salt as old

* Hahn, *Ber. d. D. Chem. Ges.* **40**, p. 1462, 1907; *Phys. Zeit.* **8**, p. 277, 1907; **9**, p. 392, 1908.

as possible in order that sufficient time shall have elapsed for the formation of a considerable fraction of the equilibrium amount of mesothorium.

Boltwood also observed that mesothorium is entrained by the precipitation of barium as sulphate in a thorium solution, and is thus removed with the radium. In chemical properties, mesothorium is closely allied to radium and is always separated with it.

Soddy* and Marckwald† showed that no separation of mesothorium from radium can be effected by fractional crystallisation of a preparation containing a mixture of radium and mesothorium.

223. Mesothorium 2. A few hours after preparation, mesothorium was found to emit β and γ rays. Hahn‡, however, showed later that the β and γ rays did not arise directly from mesothorium itself but from a successive product of short period, which he called mesothorium 2. The latter is readily separated from mesothorium 1, by the addition of a trace of zirconium or thorium salt to the active solution and precipitating with ammonia. Mesothorium 2 is precipitated with the zirconium or thorium while mesothorium 1 remains in the filtrate.

The activity of mesothorium 2 whether measured by the β or γ rays was found to decay exponentially with a period of 6.2 hours.

No doubt mesothorium 2 is transformed directly into radiothorium although no definite evidence on this point has been published. The activity of the radiothorium formed after the decay of mesothorium 2 would be small on account of the great difference in the periods of the two substances.

Hahn and Meitner showed that the β rays from mesothorium 2 were not absorbed exponentially. The coefficient of absorption in aluminium was found to vary between 20.2 and 38.5 (cms.)⁻¹. The complex nature of the β rays from mesothorium 2 has been shown in Fig. 70, and the velocity of the component sets of rays given in Section 95. Soddy and Russell (Section 99) found that the γ rays from this substance were somewhat less penetrating than those from radium. Mesothorium 1

* Soddy, *Trans. Chem. Soc.* **99**, p. 72, 1911.

† Marckwald, *Ber. d. D. Chem. Ges.* **43**, p. 3420, 1910.

‡ Hahn, *Phys. Zeit.* **9**, p. 246, 1908.

is supposed to be a rayless product, although from analogy with other products it is not unlikely that it may emit slow β rays.

224. Variation of activity of mesothorium with time.

With the data already given, it is a simple matter to deduce the variation of activity of a preparation of mesothorium with time. Since mesothorium 1 and 2 are in equilibrium two days after separation, we shall take for simplicity of calculation mesothorium 1 and 2 as one product, which is half transformed in 5.5 years and emits β and γ rays. This is transformed directly into radiothorium and its series of products. If P_0 be the amount of mesothorium

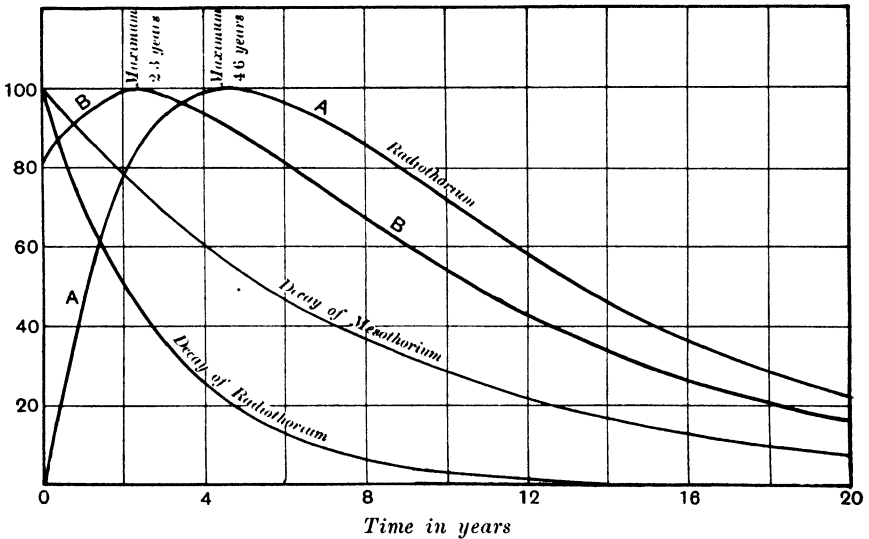

Fig. 123.

initially present, the amount P remaining after a time t is given by $P/P_0 = e^{-\lambda_1 t}$, where λ_1 is its radio-active constant. The curve of decay of mesothorium is shown in Fig. 123. If λ_2 be the constant of radiothorium, the amount Q of radiothorium present at a time t is given by equation 5, Section 159, viz.:

$$Q = \frac{P_0 \lambda_1}{\lambda_2 - \lambda_1} (e^{-\lambda_1 t} - e^{-\lambda_2 t}).$$

The variation of Q with time is shown in Fig. 123, curve A. The value of Q passes through a maximum after 4.6 years and

ultimately decays exponentially with the period of 5.5 years. Since radiothorium emits α rays and is followed by four α ray products of relatively short period, the number of α particles emitted by the preparation at a time t is equal to $5\lambda_2 Q$. Consequently the α ray activity of the preparation varies nearly according to curve A. The β or γ ray activity at any time t is proportional to $\lambda_1 P + k\lambda_2 Q$ when k is a constant which depends on the relative ionisation under the experimental conditions due to the β or γ rays from mesothorium and thorium C + D. Taking $k=1$, the variation of γ ray activity with time is shown in Fig. 123, curve B. The activity passes through a maximum after 2.3 years and ultimately decays exponentially with the period of mesothorium.

225. Separation of mesothorium on a commercial scale.

We have seen that mesothorium after separation forms radiothorium. The β and γ ray activity rises at first to a maximum after about 2.3 years, and ultimately decays with time with a period of 5.5 years. Since mesothorium has a comparatively long life and can be readily obtained in a concentrated state, it forms a very convenient source of strong activity. Shortly after the discovery of mesothorium, Knöfler and Co. in conjunction with Hahn arranged to separate the mesothorium on a commercial scale from thorium minerals. The main source of thorium is monazite sand. The latter always contains uranium and consequently radium. Since mesothorium has similar properties to radium, the latter is always separated with the mesothorium. Commercial preparations of mesothorium, consequently, contain radium, and generally the γ ray activity due to the radium in the preparation is about one-quarter of that due to the mesothorium. Such preparations of mesothorium are now sold commercially. The activity of the product is expressed in terms of the γ ray activity of radium in equilibrium. For example, 5 milligrams of mesothorium on this standard indicates that the γ ray activity of the mesothorium plus the radium contained in it one month after separation gives a γ ray activity equal to that of 5 milligrams of pure radium bromide. The preparations of mesothorium are usually more active weight for weight than pure radium bromide. A year or so after preparation a considerable amount

of radiothorium has been formed and this emits the thorium emanation freely.

The radiothorium might at any time be separated from old mesothorium preparations by the addition of a trace of thorium nitrate and precipitation with ammonia. The mesothorium and thorium X remain in the filtrate. Using active preparations of radiothorium, the rapid emission of the thorium emanation can be simply illustrated by a number of striking experiments. By blowing a current of air through the preparation on to a zinc sulphide screen, the latter becomes very luminous. With active preparations, the main properties of the emanation can be easily demonstrated on a large scale.

226. Constants of thorium series. The total number of α particles emitted per second per gram of thorium in equilibrium with all its products has been shown by Geiger and Rutherford* to be 2.7×10^4 . From the point of view of emission of α particles, the two α ray products included under thorium C are equivalent to one successive product. There are consequently six α particles emitted by thorium and its series of products compared with one from thorium itself.

From the method of calculation already given in Section 171 for uranium, it can be simply shown that the fraction of the thorium transformed per year is 4.2×10^{-11} . The half-value period of thorium is consequently 1.31×10^{10} years.

A list of the thorium products and some of their constants are given in the table on page 552. The atomic weights of the products are deduced from that of thorium by assuming that the expulsion of one α particle (helium atom) lowers the atomic weight by 4 units. No sensible change of atomic weight is supposed to occur in a transformation where β rays and γ rays are emitted. The weight of each product in equilibrium with 10^6 grams of thorium is also given. These values are deduced from the equilibrium relation $\lambda_1 N_1 = \lambda_2 N_2 = \text{etc.}$ (Section 160), taking the period of thorium as 1.3×10^{10} years and correcting for changes of atomic weights of the products.

It will be seen that the period of thorium is about three times

* Geiger and Rutherford, *Phil. Mag.* **20**, p. 691, 1910.

longer than that of uranium. In 1000 kilograms of thorium in equilibrium, less than half a milligram of mesothorium is present. The weight of thorium X per gram of thorium is 7.4×10^{-13} gram.

It will be seen that the final or end products of both branches of the thorium series should have an atomic weight 208—a value about that of bismuth. A general discussion of this question is given in Chapter XVIII.

Thorium Series.

Thorium Series	Atomic weight	Weight per 10^6 grams thorium	Half-value period	Radiation	Range α rays 15° C.
Thorium ...	232	10^9 mg.	1.3×10^{10} yrs.	α	2.72 cms.
↓					
Mesothorium 1	228	0.42 mg.	5.5 yrs.	rayless	—
↓					
Mesothorium 2	228	5.2×10^{-6} mg.	6.2 hrs.	$\beta + \gamma$	—
↓					
Radiothorium	228	0.15 „	2 yrs.	α	3.87 „
↓					
Thorium X ...	224	7.4×10^{-4} „	3.65 days	$\alpha + \beta$	4.3 „
↓					
Th. Emanation	220	1.2×10^{-7} „	54 secs.	α	5.0 „
↓					
Thorium A ...	216	3.1×10^{-10} „	0.14 secs.	α	5.7 „
↓					
Thorium B ...	212	8.5×10^{-6} „	10.6 hrs.	$\beta + \gamma$	—
↓					
Thorium C ...	212	7.9×10^{-6} „	60 mins.	$\alpha + \beta$	4.8 „
↓					
Th. C_2	212	—	very short (?)	α	8.6 „
↓					
Thorium D ...	208	1.3×10^{-7} „	3.1 mins.	$\beta + \gamma$	—

CHAPTER XVII.

PRODUCTION OF HELIUM AND EMISSION OF HEAT.

227. Discovery of helium. In this chapter we shall discuss two important properties of active matter which have been shown to be intimately connected with the emission of α rays, viz. the production of helium and the rapid emission of heat.

The history of the discovery of helium possesses some features of unusual dramatic interest. In 1868, Janssen and Lockyer observed in the spectrum of the sun's chromosphere a bright yellow line, which could not be identified with that of any known terrestrial substance. Lockyer gave the name "helium" to this supposed new element. Further comparison showed that certain other spectral lines in the chromosphere always accompanied the yellow line and were probably characteristic of helium. The spectrum of helium was observed not only in the sun, but also in many of the stars; and in some classes of stars now known as helium stars the spectrum of helium predominates. No evidence of the existence of helium on the earth was discovered until 1895. Shortly after the discovery of argon in the atmosphere, by Lord Rayleigh and Sir William Ramsay, a search was made to see if argon could be obtained from mineral sources. In 1895, Miers in a letter to *Nature*, drew attention to some results obtained by Hillebrande of the United States Geological Survey in 1891. In the course of the detailed analysis of many of the minerals containing uranium, a considerable quantity of gas was found by Hillebrande* to be given off on solution of the minerals. At the time he thought

* Hillebrande, *Bull. U.S. Geolog. Survey*, No. 78, p. 43, 1891.

this gas was nitrogen, although attention was drawn to some peculiarities of its behaviour as compared with ordinary nitrogen. The mineral cleveite especially gave off a large quantity of gas when heated or dissolved. Ramsay procured some of this mineral in order to see whether this gas might prove to be argon. On introducing the gas liberated from cleveite into a vacuum tube, a spectrum was observed entirely different from that of argon*. The spectrum was carefully examined by Lockyer† and found to be identical with that of the element helium, previously observed by him in the sun. After a lapse of thirty years since its discovery in the sun, helium had at last been found to exist on the earth. An examination of the properties of helium soon followed. It has a well-marked complex spectrum of bright lines, of which the most noticeable is a bright yellow line D_3 close to the sodium D lines.

Helium belongs to the group of chemically inert gases. The ratio of the two specific heats‡ is 1.66, indicating that helium is monatomic. On the latter assumption, the atomic weight of helium has been found by Watson§ to be 3.994.

The occurrence of helium in considerable quantity in certain minerals containing uranium and thorium was remarkable, for there appeared to be no obvious reason why an inert gaseous element should be found associated with minerals which in many cases are impervious to the passage of water or of gases. A new light was thrown on this subject by the discovery of radio-activity. On the disintegration theory of radio-activity, it was to be expected that the final or inactive products of the transformation of the radio-elements would be found in the radio-active minerals. Since many of the latter are of extreme antiquity, it was reasonable to suppose that the inactive products of the transformation of radio-active substances, provided they did not escape, would be found associated in some quantity with radio-active matter as its invariable companions. In looking for a possible disintegration

* Ramsay, *Proc. Roy. Soc. A*, **58**, p. 65, 1895.

† Lockyer, *Proc. Roy. Soc. A*, **58**, p. 67, 1895.

‡ Ramsay, Collie and Travers, *Journ. Chem. Soc.* **67**, p. 684, 1895. Behn and Geiger, *Verh. d. D. Phys. Ges.* **9**, p. 657, 1907.

§ Watson, *Journ. Chem. Soc.* **97**, p. 810, 1910.

product, the presence of helium in all radio-active minerals was noteworthy, for helium is mainly found in quantity in minerals which contain uranium and thorium.

For these and other reasons, Rutherford and Soddy* suggested that helium might prove to be a disintegration product of the radio-elements. Additional weight was lent to this suggestion by the discovery by the writer that the α particle expelled from radium had an apparent mass about twice that of the hydrogen atom and might prove to be an atom of helium.

The time was opportune to test the validity of this suggestion. In 1903, preparations of nearly pure radium bromide were placed on the market by Dr Giesel of Braunschweig. Using 30 milligrams of this material, Ramsay and Soddy† examined the gases released by dissolving the radium bromide in water. A considerable quantity of hydrogen and oxygen was released by the solution (Section 15). These gases were removed by their passage over a red hot spiral of partially oxidised copper wire and the resulting water vapour absorbed by phosphorus pentoxide. The residual gas was then passed into a small vacuum tube in connection with a small U tube immersed in liquid air in which most of the radium emanation and carbon dioxide present were condensed. On examining the spectrum of the residual gas in the vacuum tube, the characteristic line D_3 of helium was observed. This experiment was confirmed by using an older preparation of radium salt. In this case, a practically complete spectrum of helium was observed.

In later experiments, the purified emanation from about 50 milligrams of radium bromide was introduced into a small spectrum tube. No helium could be detected spectroscopically immediately after the introduction of the emanation, but after standing four days, the helium spectrum appeared with all its characteristic lines. These experiments showed that not only was helium present in old preparations of radium but that helium was produced directly by the transformation of the radium emanation.

The production of helium by radium was soon confirmed by a

* Rutherford and Soddy, *Phil. Mag.* **4**, p. 569, 1902; **5**, pp. 441, 561, 1903.

† Ramsay and Soddy, *Nature*, **68**, p. 246, 1903; *Proc. Roy. Soc. A*, **72**, p. 204, 1903; **73**, p. 346, 1904.

number of investigators. P. Curie and Dewar* placed about 400 milligrams of radium bromide in a quartz tube. The salt was heated to fusion and the tube exhausted to a low pressure and then sealed off. The spectrum of the gases in the tube was examined 20 days later by Deslandres and gave the complete spectrum of helium. This experiment showed conclusively that the presence of helium in old radium preparations could not be due to its absorption from the air.

The discovery of the production of helium by the radium emanation was of great importance, as it showed in a striking manner the remarkable nature of the processes occurring in radium and was the first definite evidence of the production of a known element during the transformation of radio-active matter.

228. Origin and rate of production of helium by radium. Following the discovery of the production of helium by the radium emanation, it became of great importance to fix the origin of helium in the series of transformations which occur in radium. It did not seem probable that helium could be the final product of disintegration of the emanation, for the latter after its rapid initial changes is transformed into a long period product radium D. In addition, all the radio-active products of the radium series appeared to be of high atomic weight. It was early pointed out by the writer† that the production of helium observed was probably due to the accumulated α particles expelled from the radio-active matter. On this view, the α particle after losing its charge became an atom of helium. This connection between the α particle and the helium atom was difficult to prove with certainty. An account of the experiments to determine the nature of the α particle has already been given in Sections 61 and 62. It was finally shown conclusively that the α particles from all types of radio-active matter were identical and consisted of helium atoms carrying two unit positive charges.

On this view, every active substance which emitted α particles during its transformation must give rise to helium in amount

* P. Curie and Dewar, *C. R.* **138**, p. 190, 1904.

† Rutherford, *Nature*, **68**, p. 366, 1903.

proportional to the rate of emission of α particles. This has been amply confirmed by numerous subsequent researches, for helium has been shown to be produced not only by the radium emanation but by polonium, ionium, and uranium, and also by preparations of thorium and actinium in equilibrium with their products.

The rate of production of helium from radium and its products can be readily calculated from our knowledge of the number of α particles expelled per second from one gram of radium. This number is 13.6×10^{10} for radium in equilibrium with its three α ray products, the emanation, radium A, and radium C. Since there are 2.78×10^{19} atoms of helium in one cubic centimetre at standard pressure and temperature, it can be simply calculated that the rate of the production of helium per gram of radium should be 158 cubic millimetres per year. Estimates of the rate of production of helium by radium were initially made by spectroscopic methods by Ramsay and Soddy*, and later by Debierne†; but the values obtained were much smaller than the calculated value given above. The first definite measurements of the rate of production of helium from a pure radium salt were made by Sir James Dewar‡. The radium salt contained in a glass tube was connected with a McLeod gauge and the whole apparatus was heated from time to time to liberate the helium formed in it. The helium was purified by means of cocoanut charcoal immersed in liquid air, and any hydrogen present was absorbed in the charcoal by cooling it with liquid hydrogen. A number of experiments were made and the final determination showed that the helium was produced at the rate of 0.463 cubic millimetres per gram per day. This corresponded to a rate of production of 169 cubic millimetres per gram per year.

Another determination was made later by Boltwood and Rutherford§. Radium chloride containing about 192 milligrams of radium was used; the polonium and radium D present in the preparation were removed by chemical methods. The dry radium

* Ramsay and Soddy, *Proc. Roy. Soc. A*, **73**, p. 346, 1904.

† Debierne, *C. R.* **141**, p. 383, 1905.

‡ Dewar, *Proc. Roy. Soc. A*, **81**, p. 280, 1908; **83**, p. 404, 1910.

§ Boltwood and Rutherford, *Wien Ber.* **120**, p. 313, 1911; *Phil. Mag.* **22**, p. 586, 1911.

chloride was placed in a platinum capsule which was contained in an exhausted Jena glass tube. After 83 days the radium was heated, the gases liberated were collected and purified, and the volume of helium measured. In order to be sure that all the helium had been removed by the heating, the radium salt was placed in an exhausted sealed vessel for another 132 days. At the end of this interval, by a suitable arrangement, the radium was completely dissolved *in situ* and the gases completely pumped off. Special precautions were taken to remove the last traces of hydrogen from the liberated gases. The amount of helium formed in the first determination was 6.58 cubic millimetres, and in the second 10.38 cubic millimetres. In each of these experiments, the radium was initially completely deprived of its emanation.

The calculation of the rate of production of helium by radium was made as follows:—If x is the volume of helium produced per day by the amount of radium (element) present in the salt, and y is the volume of helium produced per day by the emanation and the two α ray products (radium A and radium C) in equilibrium with the radium; then when the three latter products are present in equilibrium amounts $y = 3x$, or, in other words, the amount of helium produced by the three α products will be three times that produced by the radium itself.

At the beginning of each period of accumulation, however, all emanation had been removed from the radium salt. The amount of helium produced during a subsequent period of t days would be therefore equal to

$$xt + y \int_0^t (1 - e^{-\lambda t}) dt = xt + y \left[t - \frac{(1 - e^{-\lambda t})}{\lambda} \right],$$

where λ is the constant of change of the radium emanation, the unit of time being taken as the day; for a value of t greater than 40 days, $e^{-\lambda t}$ is very small and may be neglected. If Q is the total quantity of helium produced in the time t , and the value of $3x$ is substituted for y in the above expression, we obtain

$$Q = \left[t + 3 \left(t - \frac{1}{\lambda} \right) \right] x.$$

Substituting the known values of Q , t and λ , the value of x was found to be 0.0209 cubic millimetres for the first determination

and 0.0203 cubic millimetres for the second, or an average production of 0.0206 cubic millimetres of helium per day by the radium (element) present in the salt used for these experiments.

The quantity of radium contained in the salt was 192 milligrams. The production of helium per gram of radium was therefore 0.107 cubic millimetres per day and per gram of radium in equilibrium with its first disintegration products (the emanation, radium A and radium C), 156 cubic millimetres per year.

By the kindness of Sir James Dewar, Rutherford and Boltwood were enabled to determine the amount of radium chloride used by him in terms of their standard. On the latter standard, the rate of production of helium found by Dewar was 164 instead of 169 cubic millimetres per year. Considering the difficulty of the measurements, the two values are in good accord.

The observed rate of production of helium is in very close agreement with the calculated rate of production (158 cubic millimetres per year) referred to earlier, and confirms in a striking way the conclusions on which the calculations were based. There can be no doubt that the α particle consists of a helium atom carrying two unit positive charges, and that helium itself is monatomic.

Boltwood and Rutherford also determined the rate of production of helium from a known quantity of emanation. When radium emanation is enclosed in a glass tube, the α particles or helium atoms expelled from it penetrate some distance into the walls and some of them gradually diffuse back into the evacuated tube. In order to avoid this difficulty, the walls of the glass tube in which the radium emanation was introduced were coated with a thick layer of sulphur. After the emanation had decayed *in situ* the sulphur was melted and the helium fired into it was liberated and its volume measured. The volume of the helium so found was in fair accord with the calculated value.

229. Production of helium by other radio-active substances. If the α particle is a helium atom, each radio-active substance which emits α rays should produce helium at a rate proportional to the number of α particles emitted. Debiere*
*

* Debiere, *C. R.* 141, p. 383, 1905.

early showed that actinium in equilibrium with its products produced helium. Both polonium and ionium which emit α rays have been shown to produce helium. In order to measure the volume of helium produced in a reasonable time, active preparations of these substances are required. Experiments on polonium have been made by Mme Curie and Debierne* and Boltwood and Rutherford†. Mme Curie determined the volume of helium produced by a highly concentrated preparation of polonium and found it to agree closely with the volume calculated from the number of α particles emitted.

The production of helium by ionium was measured by Boltwood‡ and found to be about half of the calculated value. This difference was no doubt due to the fact that only a part of the helium formed was released from the ionium preparation under the experimental conditions.

The rate of production of helium by uranium and thorium and the minerals containing them can be readily calculated from a knowledge of the number of α particles emitted. The results are included in the following table.

Radio-active substance	Total number of α particles per gram per second	Production of helium per gram per year
Uranium	2.37×10^4	2.75×10^{-6} cubic mm.
Uranium in equilibrium with its products ...	9.7×10^4	11.0×10^{-6} „ „
Thorium in equilibrium with its products ...	2.7×10^4	3.1×10^{-6} „ „
Radium in equilibrium ...	13.6×10^{10}	158 „ „

The number of α particles emitted by uranium and uranium minerals and by thorium in equilibrium with its products have been determined by Geiger and Rutherford§ by the scintillation method.

* Mme Curie and Debierne, *C. R.* **150**, p. 386, 1909.

† Boltwood and Rutherford, *Phil. Mag.* **22**, p. 586, 1911.

‡ Boltwood, *Proc. Roy. Soc. A*, **85**, p. 87, 1911.

§ Geiger and Rutherford, *Phil. Mag.* **20**, p. 691, 1910.

Since a uranium mineral in equilibrium contains eight successive α ray products, the rate of production of helium by each product in equilibrium with one gram of uranium is 1.4×10^{-5} cubic millimetres per year. Since thorium in equilibrium contains the equivalent of six successive α ray products, each product in equilibrium with one gram of thorium produces 5.2×10^{-6} cubic millimetres per year.

The rate of production of helium by thorium and uranium minerals has been determined experimentally by Strutt* by measuring the volume of helium produced in a given time from a solution of the radio-active mineral from which all the helium had been initially removed. Special methods were employed to purify the small amount of helium to be measured.

Mineral	U ₃ O ₈ per cent.	Th O ₂ per cent.	Helium production per gram per annum	
			Observed	Calculated
Thorianite, Galle District ...	24.50	65.44	3.70×10^{-5} (mm.) ³	4.1×10^{-5} (mm.) ³
Ordinary thorianite	13.10	72.65	2.79 " "	3.2 " "
Pitchblende ...	37.6	none	3.16 " "	3.5 " "

The calculated values have been deduced from the table given above. Considering the difficulty of the experiments, the agreement between calculation and experiment is as good as could be expected.

A number of experiments have been made by Soddy† to estimate the rate of production of helium in commercial preparations of uranium and thorium nitrate, using in each case about a kilogram of material. The amount of helium formed in the solution in a given time was estimated by the spectroscopic method after all other gases had been removed by absorption by hot calcium. Evidence of the production of helium by thorium was observed, and it was found that the production of helium by uranium was certainly not greater than the calculated value.

* Strutt, *Proc. Roy. Soc. A*, **84**, p. 379, 1911.

† Soddy, *Phil. Mag.* **16**, p. 513, 1908.

Experiments of this kind are difficult, since a kilogram of uranium produces only 2.75×10^{-2} cubic millimetres of helium per year.

230. Estimate of the age of radio-active minerals.

Helium is only found in large quantity in old unaltered radio-active minerals which are rich in uranium or thorium or both. Since it is known that both uranium and thorium produce helium, it is thus reasonable to suppose that the greater part of the helium found in uranium and thorium minerals is due to the transformation of the radio-active matter which they contain. Some of the primary radio-active minerals are dense and compact and impervious to the passage of water. In these cases, it is probable that a considerable fraction of the helium formed in them has been retained. In other cases, the minerals are more porous and doubtless a large part of the helium formed has gradually diffused out. It is also to be expected that secondary minerals like the uraninite of Joachimsthal should contain relatively little helium compared with old primary minerals, for they are much more recent in origin.

Assuming that the mineral initially contained no helium and that the constant of transformation of uranium and thorium has remained unchanged since the formation of the mineral, it is a simple matter to calculate the interval of time required to produce the amount of helium observed in a mineral. This will give the minimum age of the mineral, for no correction is made for the probable loss of some of the helium by diffusion over the long interval considered. For example, a specimen of thorianite from Ceylon, which contained 11 per cent. of uranium and 68 per cent. of thorium, yielded 8.9 c.c. of helium per gram of mineral*. Since one gram of uranium in equilibrium in a mineral produces 1.10×10^{-4} cubic millimetres per year and one gram of thorium in equilibrium 3.1×10^{-5} cubic millimetres per year, the amount of helium formed per year per gram of mineral is 3.3×10^{-5} cubic millimetres. At this rate, the time required to produce 8.9 c.c. is 270 million years. In a calculation of this kind, the correction for the transformation of uranium or thorium over the interval considered is small and may be neglected. The crystals of

* See Strutt, *Proc. Roy. Soc. A*, 76, p. 95, 1905.

thorianite are usually very dense and compact and no doubt a considerable fraction of the helium has been retained. This mineral is very ancient, and probably belongs to the archæan period.

Consider next a primary uraninite from Glastonbury, Connecticut, which was analysed by Hildebrande. This mineral was very compact and of high density 9.62. It contained 76 per cent. of uranium and 2.41 per cent. of a gas supposed to be nitrogen, but which in the light of later knowledge was undoubtedly helium. This gave a percentage of helium 0.344, corresponding to 19 c.c. of helium per gram. The age of the mineral comes out to be 230 million years. Examples of this kind may be easily multiplied. These results indicate that some of the primary uranium and thorium minerals are certainly 200 million years old as a minimum estimate and may possibly be considerably older.

If it were certain that no helium escaped, this method would prove very reliable for the estimate of the age of minerals. There is no doubt, however, that a part of the helium escapes in all cases. Moss* and J. A. Gray† have shown that a part of the helium in thorianite is released by grinding the mineral. Strutt‡ examined the loss of helium from crystals of thorianite in a vacuum. The rate of escape of helium was found to be far greater than the rate of production. The comparatively rapid loss of helium was ascribed to abrasion and weathering of the surfaces of the crystals, and was obviously far in excess of the possible loss of helium in the unaltered mineral in the earth.

It will be seen in the next chapter that there is very strong evidence that lead is the final product of the transformation of the uranium-radium series. If this be proved, the amount of lead present in uranium minerals may be used, with suitable restrictions, to form a maximum estimate of the age of the mineral.

231. Amount of helium in radio-active minerals. Strutt§ has determined directly the content of radium and the amount of

* Moss, *Proc. Dublin Soc.* **8**, p. 153, 1904

† Gray, *Proc. Roy. Soc. A*, **82**, p. 301, 1909.

‡ Strutt, *Proc. Roy. Soc. A*, **82**, p. 168, 1909.

§ Strutt, *Proc. Roy. Soc. A*, **76**, p. 88, 1905.

helium in a number of radio-active minerals. Some of these are included in the following table, the percentage of uranium and thorium oxide present being given.

The helium content of a number of minerals found in the United States of America based on the analyses of Hildebrande have been given in a paper by Boltwood*.

Mineral	Locality	U ₃ O ₈ per cent.	ThO ₂ per cent.	Helium per gram mineral
Pitchblende	Joachimsthal	73.5	0	0.107 cubic cms.
Cupro-uranite	Cornwall ...	60.0	0	0.10 "
Pitchblende	" ...	29.15	0	0.08 "
Thorianite ...	Ceylon ...	13.0	77	8.9 "
Aeschynite	Hitteroe, Norway ...	9.42	1.26	1.09 "
Samarskite	N. Carolina, U.S.A. ...	10.30	1.46	1.5 "
Gadolinite ...	Ytterby ...	2.94	8.60	2.43 "
Aeschynite	Ural Mts. ...	2.50	8.18	0.98 "
Clyrtolite ...	Llano Co., Texas ...	3.67	5.05	1.15 "
Sipilite ...	Virginia ...	2.86	4.92	0.59 "
Euxenite ...	Arendal, Norway ...	2.84	2.72	0.73 "
Orangite ...	Brevig, Norway ...	1.0	48.5	0.11 "
Monazite ...	Norway ...	1.0	0.65	1.54 "
" ...	Virginia ...	0.1	2.43	1.57 "
" ...	Brazil ...	—	1.54	0.81 "

232. Amount of helium in ordinary substances. It is of great interest and importance to determine whether the amount of radio-active matter in ordinary rocks and minerals is sufficient to account for the amount of helium found in them. It is obvious that experiments of this kind may throw light on the question whether helium is produced from ordinary matter which does not show the property of radio-activity to an appreciable degree. In addition, such results are of importance in forming an estimate of the age of ordinary rocks and minerals. This problem has been attacked by Strutt, who has published a number of important

* Boltwood, *Amer. Journ. Sci.* **23**, p. 77, 1907.

papers on the subject. Special methods were devised of releasing the helium formed in the material under investigation, and of measuring its volume. At the same time, the amount of radium and consequently of uranium in the substance was determined by the emanation method. In some cases, the amount of thorium present was estimated by the emanation method or by direct determination of the activity of the substance.

It was found, in general, that all rocks and minerals contained small quantities of radium and also small quantities of helium. It is to be expected that if the helium is formed from the uranium and its products, that the amount of helium per gram of uranium should be about the same as for radio-active minerals of the same age. This has been shown by Strutt to be usually the case. Observations were also made to estimate the amount of neon and argon present compared with helium. The amounts of neon and argon observed were in general very small and negatived the idea that either of these substances could be regarded as a transformation product of the uranium or thorium.

Strutt* drew attention to some cases where helium was present in very large amount compared with the uranium present. For example, Julius Thomsen had observed that a mineral from Ivogut in Greenland similar to fluorite spar gave 27 c.c. of helium per kilogram of mineral. Strutt found that this mineral contained far too little radium to account for the helium present, but contained quite detectable quantities of thorium. No doubt the helium observed was derived from the transformation of the latter.

A striking exception was the mineral beryl. This was found to contain a quantity of helium far in excess of that possible of explanation by the small trace of radio-active matter present. Specimens of beryl from various parts of the world gave similar results. There seems to be no obvious reason why beryl should absorb helium during its formation, and in explanation Strutt has suggested that possibly one of the radio-active products of life short compared with uranium or thorium may have separated out with the mineral and decayed *in situ* giving rise to the helium observed.

* Strutt, *Proc. Roy. Soc. A*, 80, pp. 56, 572, 1907.

Strutt* made a number of experiments to test whether the helium-radium ratio could be used to form an estimate of the age of geological strata. Unfortunately many of the materials like the limestones most suitable for this purpose contained little helium or radium. He observed that the phosphatic nodules found in various geological strata contained easily measurable quantities of helium and radium. Assuming that the uranium was deposited by infiltration when the nodules were formed and that no helium escaped, minimum estimates were fixed of the age of the strata containing such nodules. Unfortunately many of the nodules are comparatively porous and undoubtedly lose part of their helium. It is difficult in such cases to estimate the age with any certainty.

Strutt† has given the following estimates of the age of some minerals and the geological strata in which they were found.

Mineral	Geological horizon	Minimum age
Sphaerosidenite from Rhine provinces	Oligocene	8 million years
Haematite, Co. Antrim ...	Eocene	31 " "
Haematite, Forest of Dean ...	Carboniferous limestone	150 " "
Sphene, Renfrew Co., Ontario	Archaean	710 " "

In order to throw further light on the age of geological strata, a series of investigations were made to determine the amount of helium and radio-active matter contained in specimens of zircon‡ found in igneous rocks of different geological age. This mineral is especially suited for such investigations, for it contains relatively large quantities of radio-active matter and helium, and is so dense and refractory in nature that a greater part of the helium formed would be expected to be retained. The results obtained by Strutt are included in the following table. It is seen that many of the zircons contain a considerable amount of thorium as well as of uranium, but the helium supplied by the thorium is calculated in terms of uranium, and the helium ratio, *i.e.* the number of cubic centimetres of helium equivalent to one gram of uranium is included in the last column.

* Strutt, *Proc. Roy. Soc. A*, **81**, p. 272, 1908.

† Strutt, *Proc. Roy. Soc. A*, **84**, p. 379, 1911.

‡ Strutt, *Proc. Roy. Soc. A*, **83**, p. 298, 1910.

Locality	Geological age	Per gram of Zircon				Helium ratio
		Helium c.c. $\times 10^{-4}$	U_3O_8 grams $\times 10^{-4}$	ThO_2 grams $\times 10^{-4}$	Total equivalent U_3O_8 grams $\times 10^{-4}$	
Vesuvius ...	Tertiary	<0.4	38.0	—	—	<0.01
Campbell I., N. Z.	"	0.807	3.17	8	3.62	0.223
Mayen, Eifel ...	"	1.14	12.7	0	12.7	0.090
Expailly, Auvergne ...	"	2.12	3.72	0	3.72	0.570
N. E. Tasmania ...	?	4.34	1.14	0	1.14	3.88
Brevig, Norway ...	Post Devonian	98.8	13.3	32.7	20.0	4.94
Cheyenne, Colorado ...	Palaeozoic	193	12.8	11.4	15.1	12.8
Green River, N. Car. ...	"	255	12.9	30.1	19.0	13.4
Ural Mts. ...	"	300	6.34	46.5	15.8	19.0
Kimberley Diamond Mines	"	323	10.8	1.32	11.1	29.2
Ceylon ...	Ancient	210	6.57	19.8	10.6	19.8
" ...	"	283	10.1	4.0	10.9	26.0
" ...	"	575	75.3	28.5	81.1	7.1
Sebastopol, Ontario ...	Archaean	114	1.83	0.92	2.02	56.6

Taking a general survey of the results, it is clear that the amount of helium in the zircon is obviously connected with its age. The helium ratios observed are about the same as those for uranium and thorium minerals of about the same age. From a number of results of this kind, it should be possible to estimate approximately the age of the igneous rocks provided the geological horizon of the latter could be fixed with certainty. Strutt* also made a systematic examination of the helium ratio in saline minerals from Stassfurt. The helium ratio was unusually large, and Strutt suggested that this may be connected with the undoubted radio-activity of potassium. It should, however, be pointed out that potassium emits only β rays and there is no certain evidence of the presence of α rays.

233. Heat emission of radium. It was soon recognised that a considerable amount of energy is emitted from the radio-active bodies in the form of their characteristic radiations. Most of the earlier estimates of the amount of this energy were based on the number and energy of the expelled β particles and were much too small. It has already been pointed out that the greater part of the energy emitted from the radio-active bodies is in the form of α rays, and that the β rays in comparison supply only a small fraction. An estimate of the energy emitted in the form of α rays by uranium, thorium and radium was given by Rutherford and McClung† who determined the number of ions produced and the energy required to produce an ion.

The first definite measure of the amount of energy radiated from radium was given by P. Curie and Laborde‡ in 1903. They found that a radium compound kept itself continuously at a temperature several degrees higher than that of the surrounding atmosphere. The rate of heat emission was first determined by a Bunsen ice calorimeter. A preparation of radium containing about 1/6 gram of radium enclosed in a glass tube was cooled in melting ice and then introduced into the calorimeter. The mercury column was found to move at a regular rate. On removing

* Strutt, *Proc. Roy. Soc. A*, **81**, p. 278, 1908.

† Rutherford and McClung, *Phil. Trans. Roy. Soc. A*, **196**, p. 25, 1901.

‡ P. Curie and Laborde, *C. R.* **136**, p. 673, 1903.

the radium, the movement of the column ceased. In the other method, the difference of temperature between a tube containing one gram of radiferous barium chloride of activity about $1/6$ of that of pure radium and an exactly similar tube containing barium chloride was determined by a thermo-couple and found to be 1.5° C. In order to measure the rate of emission of heat, a coil of wire of known resistance was placed in the pure barium compound and the strength of current required to raise the temperature to that of the radium tube observed. Both these methods showed that one gram of radium in equilibrium with its products emitted heat at the rate of about 100 gram calories per hour, or in other words, radium emits heat at a rate sufficient to melt more than its own weight of ice per hour. This emission of heat appeared to be continuous, so that in the course of a year, one gram of radium would emit about 876,000 gram calories. This property of radium of emitting heat at a rapid and uniform rate without apparent change in the radium itself naturally excited much attention, and several hypotheses were put forward in explanation. We shall see later, however, that the emission of heat from radium and other radio-active substances is, in a sense, a secondary effect, for it is a measure of the energy of the radiations expelled from the active matter which are absorbed by the active matter itself and the envelope containing it.

The heating effects of radium were soon confirmed by a number of experimenters, amongst others by Runge and Precht* and by Giesel†. Using one gram of radium bromide and a mercury thermometer, the latter found that the radium was at a temperature 5° higher than the surrounding air. The actual rise of temperature will obviously depend greatly on the experimental conditions.

By the use of a special method P. Curie and Dewar‡ showed that the heating effect of radium was unaltered at low temperatures. The method employed depended on the amount of gas volatilised when the radium preparation was placed inside a tube immersed in a liquified gas at its boiling point.

* Runge and Precht, *Sitz. Ak. Wiss. Berlin*, p. 783, 1903.

† Giesel, *Chem. Ber.* **36**, p. 2368, 1903.

‡ P. Curie and Dewar, *Proc. Roy. Inst.* 1904.

The small closed Dewar flask *A* (Fig. 124) contains the radium salt in a glass tube *R*, immersed in the liquid to be employed. The flask *A* is surrounded by another Dewar bulb *B*, containing the same liquid, so that no heat is communicated to *A* from the outside. The gas liberated in the tube *A* is collected in the usual way over water or mercury, and its volume determined. By this method, the rate of heat emission of the radium was found to be about the same in boiling carbon dioxide and oxygen, and also in liquid hydrogen. Especial interest attaches to the result obtained with liquid hydrogen, for at such a low temperature ordinary chemical activity is suspended.

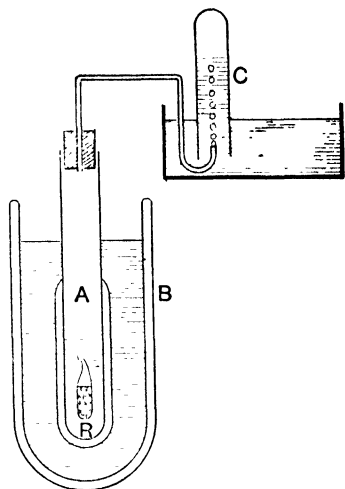

Fig. 124.

The use of liquid hydrogen is very convenient for demonstrating the rate of heat emission from a small amount of radium. From 0.7 gram of radium bromide (which had been prepared only 10 days previously) 73 c.c. of gas were given off per minute.

In later experiments P. Curie (*loc. cit.*) found that the rate of emission of heat from a given quantity of radium depended upon the time which had elapsed since its preparation. The emission of heat was at first small, but after a month's interval practically attained a maximum. If a radium compound is dissolved and placed in a sealed tube, the rate of heat emission rises to the same maximum as that of an equal quantity of radium salt in the solid state. This effect is considered in detail in the next Section.

Measurements of the heating effect of radium in radio-active equilibrium have been made later by a number of observers using different methods, but it is difficult to compare the values obtained on account of the uncertainty of the purity of the radium preparation employed.

Angström* determined the heating effect of 86.5 milligrams of radium bromide enclosed in a glass tube by a balance method.

* Angström, *Arkiv. f. Mat.* 1904, 1905; *Phys. Zeit.* 6, p. 685, 1905.

The calorimeters consisted of two equal hollow metal cylinders of thick wall, in one of which was placed the radium salt and in the other an insulated resistance coil of manganin. The cavities were filled with petrol. The current through the manganin coil was adjusted until there was no difference of temperature shown by thermo-couples embedded in the walls of the cylinders. The rate of emission of heat by the radium was then equal to the rate of supply of heat by the electric current. As the result of a series of experiments, Angström found that one gram of radium emitted 117 gram calories per hour.

A determination by a similar method was made in 1908 by v. Schweidler and Hess* using one gram of radium chloride which gave 118 gram calories per hour. This experiment was repeated by St. Meyer and Hess† in 1912 using about one gram of radium chloride which had been carefully purified by Hönigschmid for the determination of the atomic weight of radium. The heating effect of one gram of radium in equilibrium was found to be 132 gram calories per hour. Since both the β and γ rays contribute an appreciable fraction of the heating effect, it is of importance to define the exact conditions of measurement. In these measurements the radium was surrounded by a sufficient thickness of metal to absorb all the α and β rays and about 15 per cent. of the γ rays. The value of the heating effect of radium found by St. Meyer and Hess may be accepted with confidence, for the radium salt employed was pure and the measurements could be made with precision.

234. Connection of the heat emission with the radiations. The observation of Curie that the rate of heat emission depended upon the age of the radium preparation pointed to the conclusion that the phenomenon of heat emission of radium was closely connected with the radio-activity of that element. It had long been known that radium compounds increased in activity for about a month after their preparation, when they reached a steady state. It has been shown (Section 186), that this increase of activity is due to the continuous production by the radium of the

* v. Schweidler and Hess, *Wien Ber.* **117**, p. 879, 1908.

† St. Meyer and Hess, *Wien Ber.* **121**, p. 603, 1912.

emanation, which is occluded in the radium compound and adds its radiation to that of the radium proper. It thus seemed probable that the heating effect was in some way connected with the presence of the emanation. Some experiments upon this point were made by Rutherford and Barnes*. In order to measure the small amounts of heat emitted, a form of differential air calorimeter shown in Fig. 125 was employed. Two equal glass flasks of about 500 c.c. were filled with dry air at atmospheric pressure. These flasks were connected through a glass U-tube filled with xylene, which served as a manometer to determine any

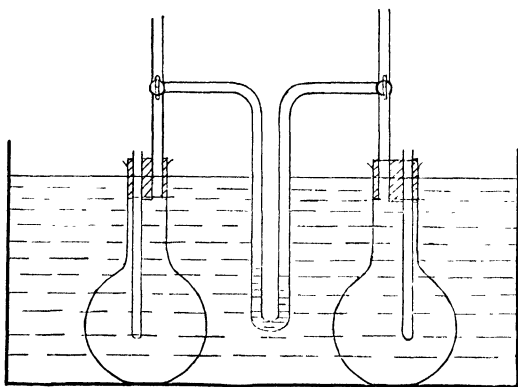

Fig. 125.

variation of pressure of the air in the flasks. A small glass tube, closed at the lower end, was introduced into the middle of each flask. When a continuous source of heat was introduced into the glass tube, the air surrounding it was heated and the pressure was increased. The difference of pressure, when a steady state was reached, was observed on the manometer by means of a microscope with a micrometer scale in the eye-piece. On placing the source of heat in the similar tube in the other flask, the difference in pressure was reversed. In order to keep the apparatus at a constant temperature, the two flasks were immersed in a water-bath, which was kept well stirred.

Observations were first made of the heating effect of 30 milligrams of radium bromide. The manometer was standardised by placing a small coil of wire of known resistance in place of the

* Rutherford and Barnes, *Phil. Mag.* 7, p. 202, 1904.

radium. The current was adjusted to give the same difference of pressure. In this way, it was found that the heating effect of one gram of radium corresponded to 110 gram calories per hour.

The emanation was then released from the radium salt by heating and condensed in a small tube surrounded by liquid air which was then sealed off. The variations of the heating effect of the radium and the emanation tube were then followed by means of the air calorimeter. The results obtained are shown in Fig. 126. The heating effect of the radium was found to decrease to a minimum (curve *A*) in the course of a few hours and then slowly

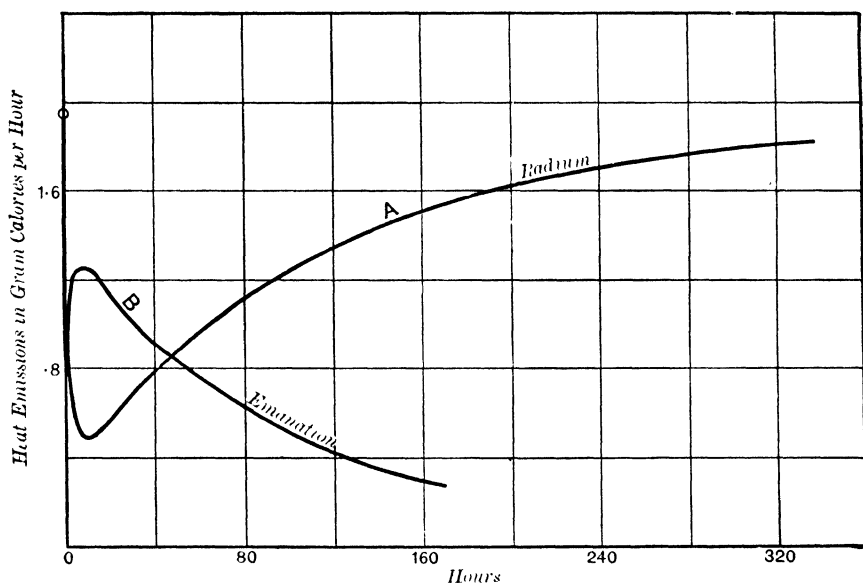

Fig. 126.

to increase with time, reaching in the course of a month a maximum which corresponded to the value obtained before releasing the emanation.

On the other hand (curve *B*), the heating effect of the emanation tube increased with time for several hours, passed through a maximum and then slowly decayed according to the period of transformation of the emanation. The sum of the heating effects of the radium and of the emanation tube was together equal at any time to that of the radium in equilibrium.

It was clear from these experiments that about three quarters

of the heating effect of radium in equilibrium was due to the emanation and its transformation products. It was found that the initial decrease of the heating effect of the radium and the initial rise of heating effect of the emanation tube were connected with the decay and growth respectively of the active deposit. This was shown by a special series of experiments by Rutherford and Barnes using a pair of differential platinum thermometers. Each thermometer consisted of 35 cms. of fine platinum wire, wound carefully on the inside of a thin glass tube 5 mms. in diameter,

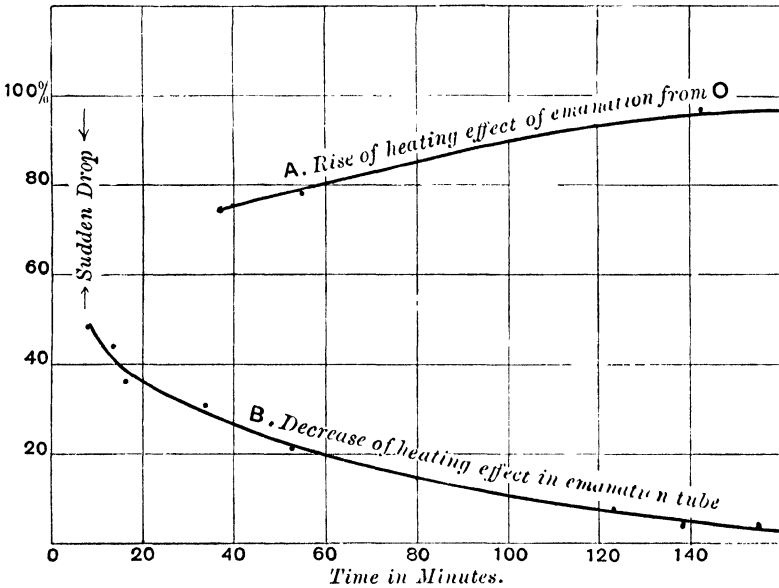

Fig. 127.

forming a coil 3 cms. long. The glass tube containing the radium and also the tube containing the emanation were selected to slide easily into the interior of the coils, the wire thus being in direct contact with the glass envelope containing the source of heat. The change in resistance of the platinum thermometers, when the radium or emanation tube was transferred from one coil to the other, was readily measured.

By this method the more rapid initial changes in the heating effect of radium and of the emanation could be followed. In one set of experiments, the emanation was introduced into a small glass tube and its heating effect measured as soon as possible.

The heating effect was found to increase with time (see Curve *A*, Fig. 127), reaching a practical maximum in three hours. The tube containing the emanation in equilibrium with its active deposit was then opened and the emanation swept out. There was a sudden drop in the heating effect and then a gradual decay (Curve *B*) in the course of a few hours to zero.

Ten minutes after the removal of the emanation, the heating effect of the tube had dropped to 48 per cent. of its initial value. The curve of decrease of the heating effect after 20 minutes shown in Fig. 127 was very similar to the curve of decay of the α ray activity due to radium C. After removal of the emanation the heating effect is due to the active deposit consisting of radium A, B, C which remains behind. Since radium A loses its activity according to a three minute period, the heating effect due to it should become very small after 20 minutes. The residual heating effect must then be due to radium B and C. It was deduced from the experiments that about 23 per cent. of the heating effect of radium in equilibrium was due to radium alone, 32 to radium C, and 45 per cent. to the emanation and radium A together. On account of the rapid transformation of radium A, its heating effect was difficult to distinguish from that of the emanation.

These experiments showed clearly that each α ray product present in radium supplied a fraction of the total heating effect observed. It seemed probable that the heat emission observed was a measure of the kinetic energy of the expelled α particles. On account of their small penetrating power, the α particles expelled from the radium and its products were absorbed either in the active matter itself or in the envelope surrounding it, and their energy of motion was transformed into heat. Experiments showed that the β and γ rays under ordinary experimental conditions supplied only a few per cent. of the total heat emission observed. The heating effect calculated from a knowledge of the number and energy of the expelled α particles was found to be in good accord with the experimental value. The question is discussed in more detail later (Section 235).

The relation verified by Geiger and Nuttall in 1911 between the velocity of the α particles emitted from a product and its period of transformation (Chapter XVIII) shows the possibility

that the heating effect of a product might not after all be a measure of the energy of the expelled particles. It might be supposed, for example, that the α particle gradually lost energy by radiation before its final escape from the atom. Under such conditions, the heating effect of a product might differ from the energy of the expelled particles.

In order to test this question, Rutherford and H. Robinson* examined carefully the relative heating effects of the radium emanation and of its products, radium A, B and C. The method adopted was similar to that originally employed by Rutherford and Barnes, but the conditions were arranged so that rapidly changing heating effects could be followed with certainty. About 100 millicuries of radium emanation were forced into a thin walled tube. After measurement of the heating effect, the emanation was rapidly expanded into an exhausted pump and the variations of the heating effect of the tube with time were followed for several hours.

It was found possible to separate the heating effects of the emanation from that due to radium A and to show that the heating effect of the latter decreased at the same rate as its activity. The variation of the heating effect due to radium B + C was accurately determined in order to throw light on the question whether the β ray product radium B supplied a measurable fraction of the heating effect. The curve of decrease of the heating effect was in close agreement with the curve of decay of radium C and showed that the main part of the heating effect was due to the rays from the latter.

The percentage heating effects of the emanation, radium A and radium C in equilibrium were found to be 29, 31 and 40 respectively. This is in good agreement (Section 235) with the relative heating effects measured by the energy of the α particles, but when account is taken of the heat supplied by the β rays from radium B and C, the heating effect found for radium B + C is slightly less than would be expected theoretically.

235. Calculated heating effect of radium and its emanation. The heating effect of radium can be readily calculated on

* Rutherford and Robinson, *Wien Ber.* (in course of publication).

the assumption that it is due entirely to the energy of its radiations. The kinetic energy of the α particles expelled from one gram of radium per second is given by $\frac{1}{2}mn\Sigma v^2$ where m is the mass of the α particle, v the velocity of the different groups of α rays and n the number emitted per second by each group. It is also necessary to add the energy of the recoil atoms which is converted into heat *in situ*. Since the momentum of the recoil atom is equal and opposite to that of the α particle, the energy of recoil of an atom of mass M is equal to $\frac{1}{2}\frac{m}{M}\cdot mv^2$. Consequently the total energy E of the radiations is given by

$$E = \frac{1}{2}mn \left(1 + \frac{m}{M}\right) \Sigma v^2 + E_1,$$

where E_1 is the energy of the β and γ rays absorbed under the conditions of measurement.

The values of $\frac{1}{2}mv^2$ for the α particles from radium and its products are given in Section 70. The value of m/M is 4/222 for radium and 4/218, 4/214, 4/210 for the emanation, radium A and radium C respectively. Taking n as 3.4×10^{10} , the emission of energy due to the α and recoil radiation from one gram of radium in equilibrium with its products is 1.38×10^6 ergs per second. This corresponds to a heat emission of 118 gram calories per hour. In a similar way, the heating effect of the emanation in equilibrium with one gram of radium can be shown to be 94.5 calories per hour.

In order to test the agreement between calculation and experiment, Rutherford and Robinson* determined accurately the heating effect of the radium emanation. Under conditions where about 90 per cent. of the β rays were absorbed, the heat emission was found to be 97.95 gram calories per hour, or in round numbers 98 gram calories. This result is in terms of the same radium standard for which the value of n was determined. It will be shown in the next Section that probably about 4 per cent. of the heating effect observed is to be ascribed to the energy of the absorbed β rays from radium B and radium C. The observed and calculated heating effects of one curie of radium emanation

* Rutherford and Robinson, *Wien Ber.* (in course of publication).

are thus 94 and 94.5 calories per hour respectively, and are in good accord.

There thus appears to be no doubt that the heat emission of radium can be accounted for by taking into consideration the energy of the radiations absorbed. The possible absorption or emission of energy due to the rearrangement of the constituents of the atom during transformation must be small compared with the energy of the expelled α particles.

236. The heating effect of β and γ rays. A number of investigators have observed that there is a small percentage increase of the heating effect of radium when surrounded by a sufficient thickness of matter to absorb all the β rays and some of the γ rays. Such results indicated that the emission of energy from radium in the form of β and γ rays was only a small fraction of the energy emitted in the form of α rays. Some early experiments indicated that the γ rays gave a heating effect comparable with the α rays; but this was disproved by Rutherford and Barnes*, who found that the γ rays contributed only a small percentage of the total heating effect of radium. Estimates of the energy of the β rays have been uncertain on account of the difficulty of estimating the energy of the β rays which are absorbed in the radium itself and the envelope surrounding it. A very careful series of measurements of the heating effect of the β rays was made by Petterson† using the balance method developed by Angström. He found that when the radium was surrounded by 4 mms. of lead the heating effect was 116.4 calories per hour per gram of radium, and 114.5 when the lead was replaced by aluminium 2 mms. thick. This difference was ascribed to the heating effect of the β rays. In the experiments, however, the rays first passed through absorbing material equivalent to 4 mms. of aluminium before entering the lead or aluminium cylinder. From later measurements of the ionisation due to the β rays discussed later in this Section, it is clear that practically all the energy of the β rays was absorbed in the envelope enclosing the radium,

* Rutherford and Barnes, *Phil. Mag.* **9**, p. 621, 1905.

† Petterson, *Arkiv. f. Mat. Fys.* **6**, July, 1910.

and that the difference observed by Petterson was mainly due to the energy of the γ rays absorbed in the lead.

The question of the relative energy supplied by α , β and γ rays was attacked by Eve* by an ionisation method. An electroscope was constructed whose walls consisted of thin sheets of aluminium. The ionisation in the electroscope is then practically unaffected by the material of the walls of the electroscope, and is nearly the same as in free air. The ionisation due to the β and γ rays was determined for different distances of the radium preparation from the electroscope. The total ionisation due to the β rays could thus be directly determined without any assumption of the absorption of the β ray by air. The total ionisation due to the γ rays was deduced from observation of the ionisation produced by the radium at such a distance that all the β rays were absorbed and from a knowledge of the absorption coefficient of the γ rays by air.

We have seen (Section 98) that Chadwick found by direct experiment that the coefficient of absorption of the γ rays by air at 760 mms. and 15° C. was $\cdot 000059$. Taking this value and the charge carried by an ion as $4\cdot 65 \times 10^{-10}$ units, the total number of ions found by Eve corresponds to $4\cdot 2 \times 10^{14}$ for complete absorption of the β rays, and $8\cdot 7 \times 10^{14}$ for the γ rays. In Eve's experiments, the radium was contained in a glass tube which must have absorbed a large part of the softer β rays. In order to correct for this absorption, measurements of a similar method were undertaken in the laboratory of the writer by Moseley and Robinson. The source of β and γ rays was a thin glass tube containing radium emanation, of which the thickness of wall corresponded to a stopping power of only 2 cms. of air. They concluded that the total number of ions produced by complete absorption of the β rays from radium in air was about 9×10^{14} , and for the γ rays 13×10^{14} . The number for the β rays is much higher than that found by Eve, indicating that a large part of the energy of the β rays in his experiments was absorbed by the radium and the envelope surrounding it. The total number of ions produced by the α rays from one gram of radium in radio-active equilibrium is $2\cdot 56 \times 10^{16}$. If it be assumed that the ionisation produced by these three types

* Eve, *Phil. Mag.* 22, p. 551, 1911.

of rays is proportional to the energies of the radiations, it follows that of the total energy emitted by radium in equilibrium 3·2 per cent. is emitted in the form of β rays, and 4·7 per cent. in the form of γ rays.

Measurements of the heating effect of the β and γ rays from the radium emanation were made by Rutherford and Robinson, by the methods described in Section 234. By direct ionisation measurements, it was found that about 90 per cent. of the energy of the β rays was absorbed in the experimental arrangement employed to measure the heating effect of the emanation. The heating effect under these conditions will, for convenience, be taken as 1. When the emanation tube was surrounded by a lead tube 1·1 mm. thick, the heating effect corresponded to 1·02; when surrounded by a thickness of mercury 4·6 mms. and 14·6 mms., the observed heating effects were 1·034 and 1·05 respectively. Since the thickness of 14·6 mms. of mercury absorbs at least 70 per cent. of the energy of the γ rays, it follows that the energy of the γ rays from the emanation was about 6 per cent. of that due to the α rays. This number is of about the magnitude to be expected from the total ionisation produced by the γ rays. It seems probable that the estimates of the heating effect of the β and γ rays based on the ionisation method are not seriously in error.

237. Distribution of the heating effect of radium amongst its products. We have seen (Section 234) that each of the products of the radium emanation provides a heating effect nearly proportional to the energy of the expelled α particles. The heating effect of one curie of emanation has been shown to be 98·5 calories per hour in terms of the Rutherford-Boltwood standard. Expressed in terms of the Vienna standard, the number is 103·5. Of this about 4 per cent. is to be ascribed to the β rays from radium B and C, so that the energy of the α rays and recoil atoms alone corresponds to 99·5. Taking account of the energy of the expelled α particles, the heating effect due to the α rays from one gram of radium itself should be 25 calories per hour. The following table shows the most probable distribution of the heating effects amongst the radiations and products of radium.

It is seen that the heating effect of the α rays and recoil atoms is 123.6 calories per hour per gram of radium; for the β rays 4.3; for the γ rays 6.5. The total emission of energy from radium comes out about 134.4 calories per hour per gram. This number is based on the Vienna standard, and is in very good accord with the latest experimental value found by Meyer and Hess, viz. 132 calories per hour per gram. Under the conditions of their measurement, the heating effect found by them corresponds to the total absorption of the α and β rays and about 15 per cent.

	Heating effect in gram calories per hour corresponding to one gram of radium			
	α	β	γ	Total
Radium	25.1	—	—	25.1
Emanation	28.6	—	—	28.6
Radium A	30.5	—	—	30.5
Radium B)	39.4	4.3	6.5	50.2
Radium C)				
Totals	123.6	4.3	6.5	134.4

of the γ rays. The general evidence indicates that the γ rays provide a greater fraction of the heating effect than the β rays.

238. Total heat emission of the emanation. It is of interest to calculate the total emission of energy during the transformation of one gram of emanation. It is shown in Section 237 that the heating effect of one curie of emanation for complete absorption of the α , β and γ rays emitted is 109 gram calories per hour. Now the volume of one curie of emanation is 0.6 cubic millimetres. Taking the atomic weight of the emanation as 222, the rate of heat emission of emanation in equilibrium with its products is 1.82×10^5 calories per hour per c.c. and 1.83×10^7 calories per hour per gram. The heat emission of the emanation decreases at the same rate as its activity, so that the heat emission E after a time t is given by $E = E_0 e^{-\lambda t}$ where E_0 is the value

initially. The total heat emission for complete transformation of the emanation is consequently

$$\int_0^{\infty} E_0 e^{-\lambda t} dt = E_0/\lambda.$$

Remembering that the value of the radio-active constant λ of the emanation is 0.0075 (hours) $^{-1}$, it follows that the total energy liberated during the transformation of the emanation is 2.43×10^7 calories per c.c., or 2.44×10^9 calories per gram. These calculations are based on experimental data which have been determined with considerable precision.

The enormous amount of energy released in transformations accompanied by the expulsion of α rays is clearly brought out by these calculations. The heat emitted during the combination of 1 c.c. of hydrogen and oxygen to form water is about 2 gram calories. The emanation during its successive transformations thus gives out more than 10 million times as much energy as the combination of an equal volume of hydrogen and oxygen to form water, although the latter reaction is accompanied by a larger release of energy than any other known to chemistry.

The total heat emission from any radio-active substance for complete transformation can be simply calculated from the rate of emission and energy of α particles, and the period of transformation of the substance. On the average, the total energy emitted from one gram of radio-active substance considered above is about one quarter of that due to the emanation and its products provided that it emits α rays. The total emission of energy per gram is consequently about 6×10^8 gram calories. In the course of its life one gram of radium with its transformation products including radium F emits about 3.7×10^9 calories.

The energy emitted by radio-active substances is manifested during the transformation of the atoms, and is derived from the internal energy of the atoms themselves. The enormous quantity of energy released during the transformation of active matter shows unmistakably that the atoms must contain a great store of internal energy. Since from the chemical point of view, the atoms of the radio-elements apart from their high atomic weight show no special chemical characteristics, it appears probable that

the atoms of all elements contain a large store of internal energy. The presence of this energy is only perceived in the case of those elements which undergo atomic transformation.

239. Heating effect of uranium and thorium. The heating effect of uranium and thorium and of the minerals containing them can be simply calculated on the assumption that it is a direct measure of the kinetic energy of the α particles. From the data given in Section 70 it is seen that the average energy of the two α particles emitted by uranium itself is 6.8×10^{-6} ergs. Since 2.37×10^4 α particles are emitted per second per gram of uranium, the heating effect should be $.161$ ergs per second or 1.4×10^{-6} gram calories per hour. Uranium in equilibrium with its series of products in a mineral emits 8 groups of α particles of average energy 8.8×10^{-6} ergs. Since 9.6×10^4 α particles are emitted per second per gram of uranium in a mineral, the heating effect of one gram of uranium and its products in a mineral should be 7.2×10^{-5} calories per hour.

In a similar way, the heating effect of thorium in equilibrium can be calculated. Six groups of α particles are emitted of average energy 1.07×10^{-5} ergs. In this deduction, thorium C, which emits two sets of α particles, is taken as one product, and the average energy per α particle is deduced from the known data that 61 per cent. of the α particles have a range 8.6 cms. and the remainder a range 4.8 cms. Since thorium in complete equilibrium with its products emits 2.7×10^4 α particles per gram per second, the heating effect should be 2.5×10^{-5} calories per hour per gram. In both cases, the heating effect to be expected should be increased by about 7 per cent. above the calculated value to include the energy of the β and γ rays.

Measurements of the heat emission of thorium were made by Pegram and Webb*. About 4 kilograms of thorium oxide were contained in an insulated vessel suspended in a metallic cylinder surrounded externally by ice and water and exhausted to a low pressure. When a steady state was reached, the difference of temperature between the vessel containing the thorium and the outer

* Pegram and Webb, *Phys. Rev.* **27**, p. 18, 1908.

ylinder was measured by a thermocouple. The emission of heat was standardised by sending an electric current through a resistance coil immersed in the thorium and observing the corresponding rise of temperature. In this way, it was found that the emission of heat per gram of oxide was 9.6×10^{-6} calories per hour. The thorium employed was not in radio-active equilibrium with its products, but gave only 46 per cent. of the activity of thorium in a mineral. Correcting for this, the heating effect of one gram of thorium in equilibrium with its products is about 2.4×10^{-5} calories per hour. This is in good accord with the calculated value 2.5×10^{-5} calories.

Poole* made a series of experiments of the heating effect of pitchblende. About 500 grams of pitchblende containing 64 per cent. of uranium was contained inside a Dewar flask, which was immersed in ice and water. The difference of temperature between the inner and outer surfaces was measured by a thermocouple and amounted to about 0.007°C . The rate of evolution of heat per gram of mineral was found to be 8.15×10^{-5} calories per hour or 12.8×10^{-5} per gram of uranium in the mineral. This number is considerably higher than the calculated value, viz. 7.2×10^{-5} calories.

Poole† found that the heat emission of the thorium mineral orangite was much greater than the calculated value, and concluded that a large part of the observed effect was to be ascribed to the heat liberated owing to some slow chemical change in the mineral.

The measurement of the small heating effects of uranium and thorium is difficult on account of the very small rise of temperature observed. The divergence of the observed heating effect from the calculated value may possibly be due to unsuspected chemical changes in progress in the large mass of mineral under examination.

Measurements of the heat emission of an active preparation of polonium were made by Duane and found to be in good agreement with the value to be expected from the energy of the expelled α particles.

* Poole, *Phil. Mag.* **19**, p. 314, 1910.

† Poole, *Phil. Mag.* **23**, p. 183, 1912.

240. Methods of measurement of small rates of heat emission. We have seen that a variety of methods have been employed to determine the heat emission of radium. In addition to those already mentioned, a sensitive method of measuring small heating effects has been designed by Callendar*. The heating effect of the radio-active substance under examination is neutralised by the Peltier effect due to the passage of a current through a thermo-junction. The active substance and the Peltier junction are enclosed in a copper cylinder and the current through the junction is adjusted until there is no difference of temperature

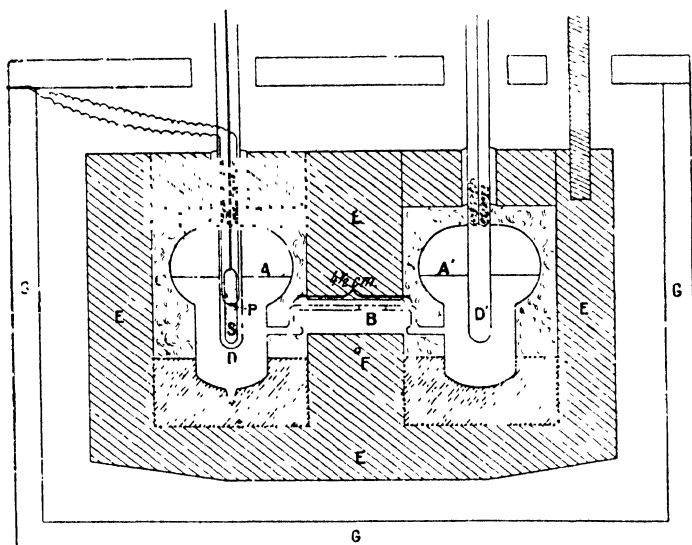

Fig. 128.

between the inner cylinder and an outer copper sphere. The balance of temperature is determined by means of a series of thermocouples. Callendar measured by this method the heating effect of radium and its emanation, and showed that the heating effect of the emanation and its products decayed at the same rate as its activity. The heat emission of one milligram of radium can easily be measured by this method.

Duane† has designed a differential gas calorimeter which can be used to measure small rates of heat emission. The general

* Callendar, *Proc. Phys. Soc.* **23**, p. 1, 1911.

† Duane, *Le Radium*, **7**, p. 260, 1910.

arrangement of the apparatus is shown in Fig. 128. The method depends on the increase of vapour pressure of a volatile liquid when the temperature is raised. Two similar vessels A and A' connected with a capillary tube B are partly filled with a volatile liquid, and the air exhausted. The movements of a short column of air introduced into the capillary tube B serves as a measure of the difference of pressure between A and A' . When a source of heat is placed in S , the air column moves towards A' . The heating effect may be measured directly by following the movement of the air column, or compensated for by passing a known current through an iron-nickel junction placed in S , so that heat is absorbed. With this apparatus, a quantity of heat $\cdot 0002$ calorie gave an easily measurable deflection of the index.

By this method, Duane* measured the heating effect of a preparation of polonium and showed that the heating effect of a radium preparation was unaltered by mixing it with any one of the phosphorescent materials, zinc sulphide, willemite, or barium platino-cyanide. These experiments showed that no appreciable amount of energy was liberated or absorbed in the chemical changes produced in the phosphorescent material by the rays.

* Duane, *C. R.* **151**, p. 379, 1910.

CHAPTER XVIII.

GENERAL RESULTS AND RELATIONS.

In previous chapters the series of transformations occurring in the well-known radio-elements and the nature of the radiations emitted from them have been discussed in detail. The present chapter will be devoted mainly to a consideration of the general properties shown in common by all radio-active substances and the relations and analogies existing between the three radio-active series and the radiations emitted from them. A brief sketch is given of the information gained from a study of radio-activity on the fundamental problem of the constitution of the atom. Certain other topics are dealt with which could not be conveniently included in the preceding chapters. The following subjects are considered :

Radio-activity of potassium and rubidium ; The apparent radio-activity of ordinary matter ; Final products of disintegration ; Chemistry of radio-active bodies ; Analogy between the radio-active series ; Relation between range and period of transformation ; Relation between β and γ rays from radio-active substances ; Constitution of the atom ; Structure and disintegration of the radio-active atoms.

241. Radio-activity of potassium and rubidium. We have referred in Section 5 to the discovery made by N. Campbell and Wood* that the salts of potassium and rubidium showed a much stronger activity than any of the known elements except

* N. Campbell and Wood, *Proc. Camb. Phil. Soc.* **14**, p. 15, 1907 ; Campbell, *Proc. Camb. Phil. Soc.* **14**, p. 211, 1907.

uranium and thorium and their products. The investigation of this property of potassium and rubidium is difficult on account of the very weak activity shown by the preparations. The activity due to a potassium salt is not more than $\frac{1}{10000}$ of the activity of the β rays due to an equal weight of uranium. The ionisation produced by the potassium salts under ordinary conditions is of the same order of magnitude as the natural ionisation observed in closed vessels.

Campbell showed that the potassium salts emitted only β rays, but no α rays. It was concluded that the β rays were not homogeneous, as they were not absorbed according to an exponential law. On an average, the β rays from potassium were less penetrating than the β rays from uranium X. Campbell, Levin and Ruer*, Henriot†, Strong‡ and Büchner§ have shown that the salts of potassium and rubidium emit a weak radiation, which affects the photographic plate. Campbell showed that the β rays from potassium were deflected in a strong electric field in the direction to be expected if they consisted of negative electrons.

The main conclusions of Campbell have been confirmed by later researches of McLennan and Kennedy|| and Henriot†. A number of investigations have been made to determine the absorption of the β rays by matter. Campbell found that the value of μ/D , the absorption coefficient divided by density, varied between 27.2 and 10.6 for tin. On the other hand, Henriot, by measuring the ionisation due to layers of potassium salt of different thicknesses, concluded that the rays were absorbed nearly according to an exponential law, and deduced the value $\mu/D = 11.3$ for potassium sulphate, and by direct absorption experiments $\mu/D = 14$ for tin. These results may be compared with the value $\mu/D = 9.5$ found for tin by Crowther, using the β rays of uranium X.

Both Campbell and Henriot have concluded that the radioactivity of potassium is an atomic property. Preparations of potassium from mineral and vegetable sources show the same

* Levin and Ruer, *Phys. Zeit.* **9**, p. 248, 1908.

† Henriot, *C. R.* **148**, p. 910, 1909; **150**, p. 1750, 1910; **152**, pp. 851, 1384, 1911; *Le Radium*, **7**, pp. 40, 169, 1910.

‡ Strong, *Phys. Rev.* **29**, p. 170, 1909.

§ Büchner, *Versl. K. Ak. van Wet.* **18**, p. 91, 1909; *Proc. Amst.* **12**, p. 154, 1909.

|| McLennan and Kennedy, *Phil. Mag.* **16**, p. 377, 1908.

activity. It has been found that variations of temperature over a considerable range have no effect on the activity. It might be supposed that the activity was connected with the well-known property of potassium and rubidium of emitting in great quantity slow speed electrons when exposed to ultra-violet light, but exposure to light has not been found to have any influence on the rates of emission of their characteristic radiations. McLennan and Kennedy (*loc. cit.*) showed that the activity of potassium could not be ascribed to a copious emission of β rays from the potassium due to the passage through it of the penetrating γ rays, which are known to be present in the atmosphere. Satterly* and Elster and Geitel† have found that the quantity of radium in potassium salts is much too small to account for the activity observed. Experiments have been made by Campbell, Elster and Geitel and Henriot to separate or concentrate a possible active constituent from potassium, but without success. The absence of α rays from the radiation of potassium is a definite proof that the β radiation cannot arise from the presence of a known β ray product which is separated with the potassium; for no β ray product of long period is known which is not transformed into an α ray product.

The general evidence shows that the emission of β rays is a specific property of the potassium atom, and, in this respect, potassium resembles a radio-active substance. Apart from this, no definite evidence has been obtained to show that potassium undergoes atomic transformation, which is the essential criterion of radio-activity.

The activity of rubidium has not been investigated with the same detail as that of potassium, but according to Campbell and Henriot it gives about the same amount of ionisation as potassium. Rubidium resembles potassium in emitting β rays but no α rays, but the β rays from it have only about $\frac{1}{10}$ the penetrating power as those from potassium. Campbell found a value $\mu/D = 8.23$ for potassium metal and $\mu/D = 53.2$ for rubidium metal. Under the experimental conditions, the activity of potassium metal measured by the ionisation produced was slightly larger than that

* Satterly, *Proc. Camb. Phil. Soc.* **16**, p. 67, 1910.

† Elster and Geitel, *Phys. Zeit.* **11**, p. 275, 1910.

of rubidium metal. Taking account of the wide difference in the absorption of the β rays emitted from the two metals, this would indicate that rubidium emits considerably more β rays per gram than potassium.

The emission of high speed β rays from elements of such low atomic weight as potassium and rubidium is of great interest and importance. There appears to be no explanation why, amongst all the light elements, potassium and rubidium alone should exhibit this property in a relatively marked degree. Caesium, which is chemically closely allied to rubidium, does not show an appreciable activity. With the exception of potassium and rubidium, the expulsion of high speed β particles has only been observed in the transformations of some of the well-known radioactive elements of high atomic weight. From analogy it would appear probable that potassium and rubidium are undergoing atomic transformation at a slow rate with the emission of β rays, but there is as yet no definite evidence in support of such a conclusion.

242. The apparent radio-activity of ordinary matter.

Schuster in 1903 pointed out that every physical property hitherto discovered for one element has been found to be shared by all the others in varying degrees. For example, the property of magnetism is most strongly marked in iron, nickel and cobalt, but all other substances have been found to be feebly paramagnetic or diamagnetic. From general analogy, it might thus be expected that all matter should exhibit the property of radio-activity in varying amounts. According to present views, the emission of high speed α and β particles is a definite indication of atomic instability. It does not, however, follow that because the atoms of one element become unstable and break up with the expulsion of α or β particles that therefore the atoms of all other elements should pass through similar phases of instability.

We have seen that besides the well-known radio-active elements, only potassium and rubidium show a well-marked activity. Every substance that has so far been examined shows, however, a very feeble activity which can be detected by the ionisation method. We shall now consider the development of our knowledge of this

subject, and the interpretation to be placed on the experimental results.

Since the time of Coulomb onwards several investigators have believed that a charged conductor placed inside a closed vessel lost its charge more rapidly than could be explained by the conduction leak across the insulating support. Matteucci, as early as 1850, observed that the rate of loss of charge was independent of the potential. Boys, by using quartz insulators of different lengths and diameters, arrived at the conclusion that the

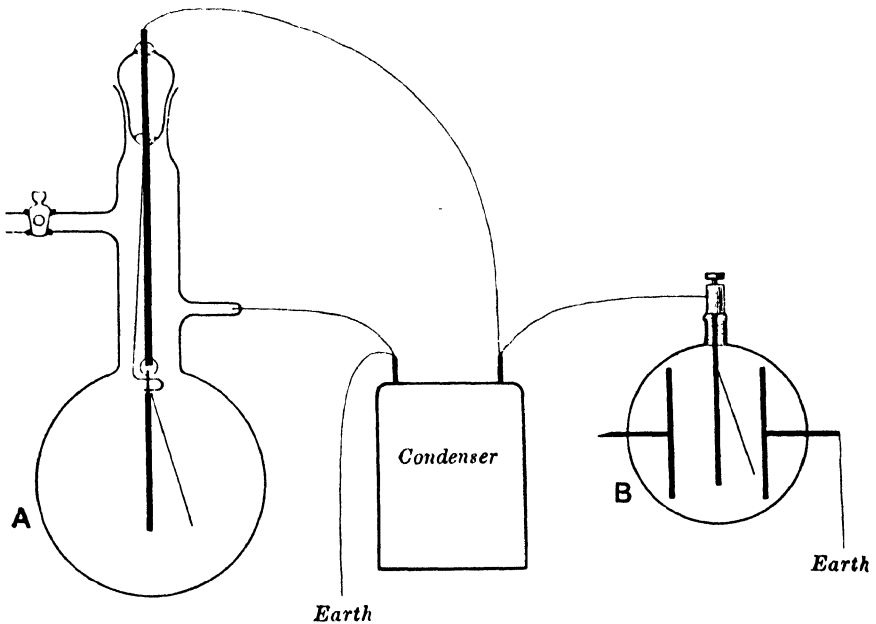

Fig. 129.

leakage must in part take place through the air. This loss of charge in a closed vessel was believed to be due in some way to the presence of dust particles in the air.

After the discovery that gases become temporary conductors of electricity under the influence of Röntgen rays and the rays from radio-active substances, attention was again drawn to this question. Geitel* and C. T. R. Wilson† independently attacked the problem,

* Geitel, *Phys. Zeit.* 2, p. 116, 1900.

† C. T. R. Wilson, *Proc. Camb. Phil. Soc.* 11, p. 32, 1900; *Proc. Roy. Soc. A*, 68, p. 151, 1901.

and both came to the conclusion that the loss of charge was due to a constant ionisation of the air in the closed vessel.

Geitel measured the loss of charge of an insulated conductor, attached to a small electroscope, which was placed in a large vessel of about 30 litres capacity. Wilson on the other hand used a vessel of very small volume in order to work with air which could be completely freed from dust. In his first experiments, a silvered glass vessel of volume 163 c.c. was used. The experimental arrangement is clearly shown in Fig. 129. *A* is the vessel in which there is an insulated gold leaf system of which the loss of charge is to be measured. In order to prevent the loss of electricity by leakage over the sulphur bead, the upper rod was always kept charged to a slightly higher potential than the insulated gold leaf system. The upper rod was connected to a sulphur condenser with an Exner electroscope attached to measure its potential. The method employed by Wilson in these experiments is very certain and definite when an extremely small rate of discharge is to be measured, and as we have seen (Section 35) has come into general use as a means of measuring minute ionisation currents.

Both Geitel and Wilson found that the rate of loss of charge was independent of the sign of the charge and of the potential over a considerable range. These observations indicated that the loss of charge was due to a minute volume ionisation of the air. Wilson also showed that the rate of loss of charge was approximately proportional to the pressure of the gas, and for different gases varied nearly as the density of the gas. These results indicated that the ionisation was produced by a radiation proceeding from the walls of the ionisation vessel. This point of view was confirmed by the experiments of Strutt*, who found that the rate of discharge of an electroscope depended on the material of which it was composed. By placing linings of various metals in an electroscope, he found that the rate of discharge varied for different metals, and also in some cases was markedly different for various specimens of the same metal. The variation of the ionisation due to the same metal indicated that part of the effect was due to radio-active impurities present. On the

* Strutt, *Phil. Mag.* 5, p. 680, 1903.

other hand, Campbell* as a result of an extensive series of measurements concluded that all metals showed a specific radio-activity and emitted characteristic radiations of the α ray type.

It is now necessary to consider the factors that influence the rate of discharge of a metal electroscope filled with air. The ionisation observed may be due to one or more of the following causes :

- (1) the presence of a small quantity of radium emanation mixed with the air ;
- (2) a superficial activity due to the exposure of the metal to the radio-active matter present in the atmosphere ;
- (3) the presence of traces of known types of radio-active matter throughout the volume of the metal ;
- (4) the escape of a radio-active emanation from the metal into the gas ;
- (5) the effect of the penetrating γ rays which arise from the earth and atmosphere.

The effect of (1) is usually small and does not amount to more than 1 or 2 ions per c.c. per second in the air. The radium emanation, if necessary, can be removed entirely by passing the air in the vessel through a charcoal tube immersed in liquid air. The effect of (2) may be considerable, for the surface of all metals exposed in the open air becomes temporarily active due to the presence of radium and thorium emanations in the atmosphere. McLennan and Burton†, for example, have observed that the ionisation due to a sheet of metal exposed in the open air always decreases for several hours after its introduction into a closed vessel. This no doubt is due to the active deposit of radium collected from the atmosphere. In addition, if the plate has been exposed long in the open air, radium D + E + F collect upon it. It is thus to be expected that a metal would produce less ionisation when its surface is removed or thoroughly cleaned to get rid of the active matter. This has been shown to be the case by

* Campbell, *Phil. Mag.* 9, p. 531, 1905.

† McLennan and Burton, *Phil. Mag.* 6, p. 343, 1903.

Cooke, who found that a brass electroscope showed only about one-third of its original activity after thorough cleaning. McLennan also found that the ionisation in large metal vessels, after an initial decrease, gradually rose for several days. The activity fell again when fresh air was substituted. This no doubt was due to the presence of a trace of radium in the metal and the release of a small quantity of radium emanation into the air of the ionisation chamber. It will be seen (Section 255) that Rutherford and Cooke and McLennan observed that a penetrating radiation of the γ ray type is present everywhere on the surface of the earth. This arises from the presence of radio-active matter in the earth and atmosphere. Cooke found that the ionisation in a well-cleaned brass electroscope was reduced about 30 per cent. by surrounding it by a large thickness of lead. A similar result was observed by McLennan when an ionisation vessel was surrounded by a large thickness of water.

When proper precautions are taken, the residual ionisation to be ascribed to the metal is reduced to a small quantity. For example, Cooke* found that in a brass electroscope of about one litre volume surrounded by lead, the rate of discharge corresponded to the production of about 7 ions per second, when the charge on an ion is taken as 4.65×10^{-10} units. A number of experiments have been made by McLennan† and Wright‡ to find the lowest value of the ionisation obtainable. For this purpose, the latter made measurements on the surface of Lake Ontario. The experiments showed that the water of the lake completely screened off the effect of the γ rays from the earth, and did not itself contain sufficient radium to provide a detectable amount of γ rays. In this way, the ionisation in an aluminium vessel was reduced to 4.8 ions per c.c. per second and in a lead vessel to 6.3.

It is difficult to decide with certainty whether this residual ionisation is due to an inherent radio-activity possessed by the metal itself or to the presence of a trace of known radio-active matter. Taking into consideration the wide dissemination of radio-active matter throughout the surface of the earth, it is to be

* Cooke, *Phil. Mag.* 6, p. 403, 1903.

† McLennan, *Phil. Mag.* 14, p. 760, 1907.

‡ Wright, *Phil. Mag.* 16, p. 295, 1909.

expected that traces of radio-active matter would be separated with all metals. This point of view has received strong support by experiments that have been made with lead, which is the most active of all the ordinary metals. It is known that radium D is always separated with the lead present in radio-active minerals, and no method has yet been found of isolating it from the lead. It would thus appear certain that if any radium is present in lead ores that the product radium D would be separated with the lead. Since radium D changes into radium F (polonium), which emits α rays, the activity of the lead should be mainly due to the latter. In order to test this point, Elster and Geitel* made a chemical examination of lead, and were able to extract a small quantity of active matter which they considered to be polonium. If the activity of lead is mainly due to the presence of radium D and its products, since radium D loses half its activity in 16.5 years, it is to be expected that the activity shown by lead would decrease with the age of the preparation. This was tested by McLennan†, who found that a lead sheet about 28 years old showed an activity much less than a sheet of lead of recent date. For example, the number of ions produced per c.c. per second by recent samples of lead from different works varied between 27 and 116, while the number from the sheet of old lead was 17—a number not much greater than that shown for commercial zinc and aluminium.

After taking account of the various factors which make up the apparent activity of metals, the residual activity to be ascribed to the metal itself produces on an average less than 6 ions per c.c. per second in air at standard pressure. As we have seen, the lowest rate of production of ions yet observed is 4. This is a very small volume ionisation and would be produced by an almost infinitesimal trace of radium or other substance of high activity separated with the metal. For example, suppose a spherical metal vessel is taken of volume one litre. The area of the interior surface is about 480 square cms. and the total number of ions produced per second in the chamber due to the metal is ordinarily less than 10^4 . Now it has been shown in Section 70 that an α particle from uranium, or radium itself, produces more

* Elster and Geitel, *Phys. Zeit.* 9, p. 289, 1908.

† McLennan, *Phil. Mag.* 14, p. 760, 1907.

than 10^6 ions in air before complete absorption. The ionisation observed thus corresponds to the expulsion of one α particle in ten seconds from the surface of the vessel, or about one α particle *per hour* from each square centimetre of surface of the metal. It can easily be calculated that the expulsion of one α particle per hour per gram of metal would account for the ionisation observed. The presence of 2×10^{-15} gr. of radium per gram of metal as an impurity would suffice to account for the observed activity.

Suppose, however, the ionisation observed is ascribed to a weak radio-activity of the metal itself which is accompanied by the expulsion of an α particle. One gram of uranium emits 2.7×10^4 α particles per second and is half transformed in about 5×10^9 years. Since one gram of the metal emits one α particle per hour, it follows that its corresponding rate of transformation is only 10^{-8} of that of uranium, and the metal would be half transformed in 5×10^{17} years.

Considering the evidence as a whole, there does not seem to be any adequate proof that ordinary metals possess an intrinsic activity corresponding to the well-known radio-active elements. The very weak activity actually observed is in all probability to be ascribed to the presence of traces of radio-active matter as impurities.

243. Final products of disintegration. We have seen that after a long series of transformations, each of the elements, uranium, thorium and actinium, gives rise to matter which is either entirely inactive or possesses such a feeble radio-activity that it cannot be detected by the sensitive methods at our disposal. If these final products of the transformation are stable, they must accumulate in quantity in the radio-active minerals and after the lapse of geological ages should be present in sufficient quantity to detect by ordinary chemical methods. Since the final products of the transformations are believed to be solids, the amount of the final product in an unaltered mineral should depend on the amount of the parent element originally present and on the age of the mineral.

Let us first consider the question of the end product of the uranium-radium series. It has been shown that the disintegration

of uranium results in the expulsion of eight atoms of helium. Since the atomic weight of helium is 3.994 and of uranium 238.5, the atomic weight of the end product should be $238.5 - 8 \times 3.994$ or 206.6. This is very near to the accepted value of the atomic weight of lead, viz. 207. In this calculation, the loss of mass is supposed to be inappreciable in a product which does not emit α rays.

The suggestion that lead was the end product of the uranium series was first made by Boltwood*, and has been supported by him from consideration of the relative amounts of lead and helium in old unaltered uranium minerals. He showed that the ratio Pb/U was nearly constant for unaltered minerals obtained from the same locality and presumably of the same geological age, but varied with the locality. For example, the analysis of five specimens of uraninite from Glastonbury (Conn.) gave a ratio $Pb/U = .041$; five specimens of uraninite from Branchville .053; uraninite, Llano Co., Texas, .170. In seventeen minerals from Norway and Sweden there were two groups, one giving a ratio $Pb/U = .125$ and the other .155. The greatest ratio observed, 0.20, was given by thorianite from Ceylon. The ratio of helium to lead was always less than the theoretical value calculated from the amount of lead, but varied widely in different minerals. This variation is to be expected since the amount of helium retained will depend greatly on the density and structure of the mineral.

The question was re-examined by Holmes†, who determined the ratio Pb/U for a number of radio-active minerals found in primary rock minerals obtained from the same locality in Norway. With one or two exceptions, the ratios Pb/U were in good agreement and gave an average value .045. The ratio Pb/U was found to be unaffected by the presence of thorium, showing that the latter element could not give rise to lead as a final product. Taking into account the probable geological age of the various minerals, the ratio Pb/U is found to vary in the manner to be expected if lead and uranium are genetically connected.

The evidence obtained from examination of a large number of

* Boltwood, *Amer. Journ. of Sci.* **23**, p. 78, 1907.

† Holmes, *Proc. Roy. Soc. A*, **85**, p. 248, 1911.

radio-active minerals undoubtedly affords very strong support for the view that uranium is ultimately transformed into lead. On this assumption, it is a simple matter to calculate approximately the age of the radio-active mineral from the amount of lead present. This will give a *maximum* estimate of the age, for there is always a possibility that a part of the lead was deposited during the formation of the mineral. On the other hand, the age determined from the helium content (Section 230) gives a *minimum* estimate, for in practically all cases a part of the helium formed must have escaped.

We have seen (Section 229) that the calculated rate of production of helium by one gram of uranium in equilibrium with its products is 11.0×10^{-5} cub. mm. per year, a value in good accord with a direct determination by Strutt. Since eight atoms of helium are formed for one of lead, it follows that the amount of lead formed per gram of uranium per year is 1.25×10^{-10} gram. Assuming that this rate of production has remained nearly constant since the formation of the mineral, the age of a mineral is given by $8 \times 10^9 \cdot Pb/U$ years.

The following table compiled by Holmes gives the ratio found for a number of radio-active minerals, of which the probable geological period is added. The age in millions of years has been

Geological period	Pb/U	Age in millions of years
Carboniferous ...	0.041	340
Devonian ...	0.045	370
Pre-carboniferous ...	0.050	410
Silurian or Ordovician	0.053	430
Pre-Cambrian		
a. Sweden ...	{ 0.125	1025
	{ 0.155	1270
b. United States	{ 0.160	1310
	{ 0.175	1435
c. Ceylon ...	0.20	1640

deduced on the assumption that all the lead observed is derived from the transformation of uranium. As is to be expected, the age calculated with lead as an index is several times greater than

the age calculated from the amount of helium present in the mineral (see Section 230).

The evidence derived from a study of uranium minerals supported by the indirect calculation of the atomic weight makes it almost certain that lead is the final product of uranium. A direct proof of this could be obtained by finding whether polonium, the last product of the uranium series, is transformed into lead. Experiments to test this point are being carried out by Mme Curie and Dr Debierne.

The evidence of the nature of the final product of the transformation of thorium is far less definite than in the case of uranium. Thorium contains in all six α ray products. The atomic weight of the end product should thus be $232.5 - 24$ or 208.5 . This suggests that bismuth (atomic weight 208.0) is the end product, but such a view is not supported by the mineralogical evidence. Remembering that thorium is transformed at about one-fifth of the rate of uranium, the weight of the end product formed per gram of thorium in a mineral should be about one-fifth of the weight of lead formed by the uranium in the same mineral. Since the ratio Pb/U for thorianite from Ceylon is about 0.20 , the ratio Bi/U for this mineral should be about 0.04 . The amount of bismuth actually observed in the mineral is much too small compared with the theoretical value, to give definite support to the view that bismuth is the end product of thorium. At the same time, the evidence of atomic weight based on considerations of the number of α particles emitted does not suggest any other possibility unless it be supposed that one or more of the transformations of thorium are abnormal in character. We have already seen (Section 218) that the product thorium B or thorium C has undoubtedly two distinct modes of transformation. The exact nature of these two transformations is as yet imperfectly understood, but it is quite possible that there may be two end products of the thorium resulting from this branching of the thorium series. The radio-active and mineralogical data, at present available, are, however, too imperfect to supply any definite information on this point.

No evidence has yet been obtained to throw light on the nature of the end product of the actinium series. In the absence

of definite knowledge of the atomic weight of actinium, or of any of its products, the method of deduction used in the cases of uranium and thorium is inapplicable.

244. Chemistry of radio-active bodies. We have seen that a variety of physical and chemical methods have been devised which are capable of isolating a given radio-active substance from a mixture of others. These methods are often surprisingly effective, even though the quantity of matter involved is far too small to detect except by radio-active methods. For example, radium B can be separated from radium C and thorium B from thorium C by their difference in volatility when deposited on a clean metal surface. Again, pure radium C can be obtained from a solution of radium B + C either by electrolysis or by dipping a nickel plate in the solution. Uranium X can be separated from a solution of uranium by precipitating barium as sulphate in the solution or by adding charcoal to the solution. Radium D is separated from radium by precipitating lead in the solution.

It is now necessary to consider whether any definite information of value as to the chemical nature of a radio-active substance can be drawn from its behaviour when present in exceedingly small quantity. The general methods of separation employed can be conveniently divided into four groups :

- (1) Difference in volatility of products.
- (2) Absorption by charcoal, entrainment by barium sulphate, etc.
- (3) Precipitating in a solution a substance of analogous chemical properties.
- (4) Separation by electrolysis or by electrochemical methods.

With reference to (1), we have seen that the differences of volatility of the components of the active deposit have often been employed to effect a partial separation of one or more products of the group. There appears to be no doubt that the volatility of a given product depends on its chemical state. For example, if the active deposit of radium is heated in the presence of hydrogen, both radium B and radium C volatilise at much lower temperatures than in an atmosphere of oxygen. The work of Schrader* has

* Schrader, *Phil. Mag.* **24**, p. 125, 1912.

shown clearly that different compounds of a product can be obtained by suitable chemical treatment, and their presence shown by their change in volatility. For example, in the presence of hydrogen, radium B probably exists as a metal, but in the presence of oxygen it is converted into an oxide, and in the presence of chlorine into a chloride. The change of volatility or the change in the solubility of a product in acids is one of the few methods at present available of studying the formation of compounds of radio-active elements present in infinitesimal quantity.

In regard to (2), it appears that no very definite evidence of the chemical nature of a product can be drawn from its separation with substances like charcoal, barium sulphate or ferric hydroxide; for each of these methods is effective in separating not only one substance but a number of substances which from other evidence are believed to differ widely in chemical properties. In these cases, the active matter is entrained or absorbed by the dense precipitate, but it does not follow that similar methods of separation would be effective if the active matter could be obtained in weighable quantity. Ritzel* has examined carefully the conditions of separation of uranium X from uranium by charcoal and concluded that it is a true case of adsorption of the matter by the charcoal. The adsorption is, however, only appreciable when dealing with minute traces of the matter involved. For example, Ritzel has shown that the charcoal method fails if a small quantity of thorium salt is added to the uranium solution. The explanation of this effect seems clear in the light of later knowledge. Uranium X is chemically closely analogous to thorium, and is separated by the same general methods as the latter. In the absence of thorium, the charcoal is able to absorb completely the minute quantity of uranium X present, but with the addition of a relatively large quantity of thorium, which behaves like a very large quantity of uranium X, the charcoal is able to adsorb only a minute fraction of each of the two substances. It does not appear that the active matter forms definite chemical compounds in such cases, for Lloyd† has shown that the radium when separated by the barium sulphate method is only lightly held by the precipitate.

* Ritzel, *Zeitschr. f. phys. Chem.* **67**, p. 724, 1909.

† Lloyd, *Journ. Phys. Chem.* **14**, p. 476, 1910.

By agitation with water, the greater part of the adsorbed radium passes into solution again.

Without further study, it seems doubtful whether the method (3) gives a definite indication of the chemical character of the product. For example, mesothorium 2 is separated from mesothorium by precipitating a zirconium salt in the solution. Though it may possibly belong to the same chemical group as zirconium, there is no reason to believe that mesothorium 2 if present in large quantity could not be separated from zirconium by direct chemical methods. Again, radium D is always associated with the lead obtained from uranium minerals but a satisfactory method of separating the two elements has not been discovered. This difficulty may be due to the fact that one substance is present in minute quantity compared with the other, and not due to any very close similarity in their chemical properties in bulk. Similarly no method has yet been found of separating ionium from thorium. In this case, there would appear to be a close similarity of chemical properties, for it seems probable that in some preparations the ionium is present in quantity comparable with the thorium. In a similar way, mesothorium cannot be separated from the radium with which it is separated from a mineral containing both uranium and thorium. Soddy has shown that the relative concentration of the two components is unaltered by fractional crystallisation. There is a number of products known which appear to be so analogous in chemical properties that no methods of separation have yet been devised. For example, thorium, radio-thorium, ionium, and uranium X form an apparently non-separable group; radium, mesothorium and thorium X another.

The electrochemical properties of the active deposits in solution were first investigated by v. Lerch*, who showed that one or more of the component products could be separated by electrolysis under specific conditions. In a similar way, he found that the components of the active deposit in solution could be separated electrochemically by dipping metal plates into the solution. For example, v. Lerch* found that radium C was deposited on the cathode by electrolysis, using a small current density, and was

* v. Lerch, *Ann. d. Phys.* **12**, p. 745, 1903; **20**, p. 345, 1906.

also deposited on nickel by dipping a plate of the latter in an acid solution.

A detailed study of the conditions of separation of the active substances by electrolysis has been made by v. Hevesy*. He has shown that the following groups of radio-active substances possess nearly the same electrochemical properties.

Radium, Thorium X, Actinium X.

Radium B, Thorium B, Actinium B.

Radium C, Thorium C, Actinium C.

Thorium D, Actinium D.

The experiments were carried out not by applying a difference of potential between the electrodes but by dipping a metal into a solution of one of its salts containing the radio-active substance under investigation. For instance, the action of zinc on the active deposit of radium was investigated by dipping a zinc plate into a solution of zinc sulphate containing radium B and radium C in solution. By using electrochemically definite systems, the drop of potential between the solution and the metal could be determined with certainty.

If a neutral solution containing B and C products in radio-active equilibrium be electrolysed, the smaller the potential drop of the cathode the purer is the C product obtained on it. When this potential drop has a value $E_{H_0} = -0.6$ volts with a calomel electrode, B and C are deposited in equilibrium ratio. If it exceeds this value, however, B is deposited in more than equilibrium amount. v. Hevesy has shown that the separation of products by dipping a metal plate into a solution can be explained in a similar way. For example, if a silver plate be dipped into normal silver nitrate containing B and C in equilibrium, pure C is deposited on it, because in this case a potential drop at the surface of the metal is $E_{H_0} = +0.5$ volts. If a zinc plate, however, be dipped into a normal zinc sulphate solution B is deposited in great excess over C because the potential drop of the electrode is here $E_{H_0} = -1$ volt.

Fig. 130 shows the relation between the percentage of actinium B or C of the total B and C deposited on the plate and the

* v. Hevesy, *Phil. Mag.* 23, p. 628, 1912.

potential drop necessary, measured against the calomel electrode, for producing this deposition. Fifty per cent. represents a deposit of B and C in equilibrium amount. Active bodies are deposited also on non-metals such as glass, quartz, etc., though in smaller amount than on metals. The active matter so obtained consists chiefly of C products. The deposit of the active matter in these cases is no doubt connected with the double layers which are always present. Although the capacity of these double layers may be very small, it is sufficient to bring about the deposition of some active material. This type of deposition is best shown with

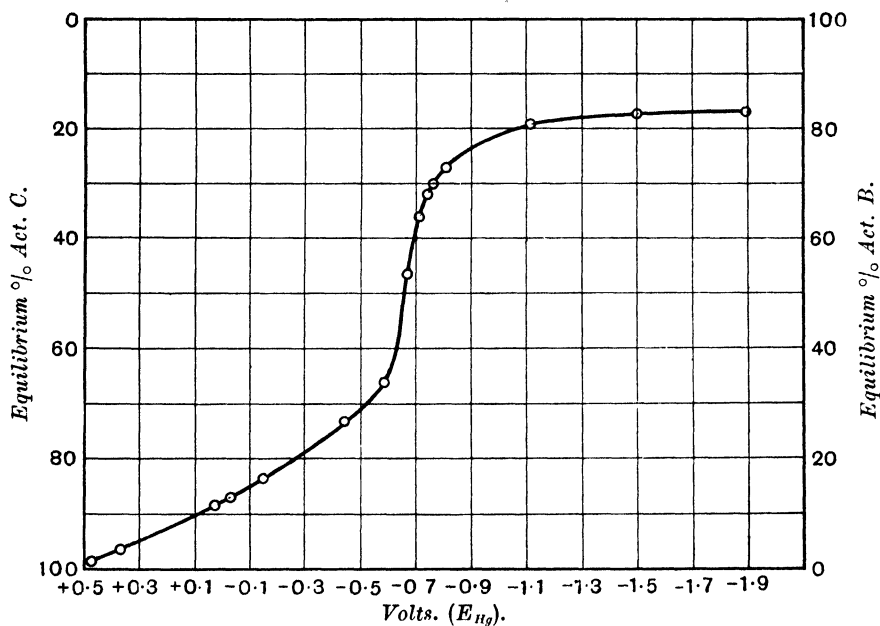

Fig. 130.

radium F (polonium). This substance is deposited very readily on glass and metallic surfaces, and in consequence it is always difficult to separate polonium from glass, and still more from metallic surfaces by treatment with acids, as part of the polonium is always re-deposited from the solution.

245. Analogies between radio-active series. In considering the modes of transformation of uranium, thorium and actinium, and the chemical properties of their successive products,

it is at once obvious that there are several striking resemblances. Each element gives rise to a radio-active emanation which behaves like a monatomic gas of the helium-argon group, and each emanation in turn gives rise to a similar series of products included under the name "active deposit." In these groups of products, the similarity is very close not only in the nature of the transformations but also in the chemical characters of corresponding products. Each emanation is transformed with the emission of an α particle and gives rise to a non-volatile product of short life known as radium A, thorium A and actinium A respectively. Each of the A products breaks up with the expulsion of an α particle giving rise to a B product. Each of the B products has the longest life of the group, and is transformed into a C product. There is evidence that in all three cases the C products break up in an abnormal way. Radium C emits α , β , and γ rays and gives rise to radium D and a branch product called radium C₂ of short life, which emits β rays. Thorium C also breaks up in a complicated way, emitting two groups of α rays and also β rays. There is also some evidence, though not of a very definite character, which indicates that the transformation of actinium C is abnormal. The products thorium D and actinium D are very similar, both emitting β and γ rays, and having a life short compared with the B products. Thorium D and actinium D differ in some respects from radium D. It seems probable that the product of radium analogous to thorium D is included under radium C, for it is quite possible that the β and γ rays from the latter do not accompany the expulsion of α rays.

The general analogy between the modes of disintegration of the first four products of the emanation is thus very striking. The similarity extends to the chemical nature of the products, for it has been shown that the B and C products of the series show almost identical chemical behaviour. On the other hand, the series of products radium D + E + F has no counterpart in the thorium or actinium series.

Passing backwards in the series, the parent products of the emanations, viz. radium, thorium X and actinium X show again a strong similarity both in chemical properties and mode of disintegration. The corresponding products ionium, radio-thorium and

radio-actinium are also closely allied in radio-active and chemical properties, especially the two former.

As we approach the heads of the three series, the similarity becomes less marked. Uranium X and mesothorium 2 appear to be similar, for both have relatively short lives and emit β and γ rays, but no counterpart is known in the actinium series. Mesothorium is analogous in some respects to actinium, for both suffer a rayless transformation, but, on the other hand, they differ somewhat in chemical properties.

It is of interest to note that the atomic weights of the thorium products passing from mesothorium 2 to thorium D is in each case two units less than the corresponding product of the uranium-radium series. The comparison cannot be extended to the actinium series, as its atomic weight is unknown.

It is of interest to consider the changes in chemical properties in passing from one element of the series to the next. Soddy has pointed out that in many cases where the transformation is accompanied by the loss of a helium atom, there is apparently a change of two in the valency. For example, ionium, which has properties so similar to thorium that it is to be regarded as tetravalent, gives rise to divalent radium, and the latter to non-valent emanation. In the case of thorium, the valency of the first few products appears to alternate. Tetravalent thorium changes into divalent mesothorium, which then undergoes changes of valency similar to ionium. The change of two in the valency in consequence of the loss of an α particle, is probably connected with the fact that, in order to remain electrically neutral, the atom which has lost an α particle which carries two unit positive charges must also lose two unit negative charges probably in the form of electrons from the surface of the atom.

The products which are transformed without the emission of α rays are of especial interest, for the atomic weight is not appreciably changed by the transformation. Such a change, however, often results in a marked alteration of chemical properties. In such cases, it is possible that the chemical differences observed may be due mainly to a change of valency, rather than to a drastic re-arrangement of the structure of the atom.

In comparing the electrochemical properties of radium B, C,

D, E and F, it was found that radium C was more readily deposited electrochemically than radium B, radium E more than radium D, and radium F more than radium E. These observations led to a generalisation, known as v. Lerch's or Lucas' rule, which states that each member of a disintegration series is nobler than its parent. The proof that a relation of this kind existed would be of great importance, for it would indicate a connection between the chemical properties of a product and its position in the series of transformations. A more detailed examination of the active deposits of radium, thorium and actinium has shown, however, that this rule does not hold generally. For example, v. Lerch and v. Wartburg found that thorium D is less easily deposited than thorium C, while v. Hevesy showed that radium A is more easily deposited than radium B, but less easily than radium C, while radium C is much more easily deposited than radium D. It was pointed out by v. Hevesy that the products which emit α rays appear to be more easily deposited electrolytically than the products which emit only β rays. Apart from this, no definite relation appears to exist between the properties of successive products in the series of transformations included under the active deposits.

246. Relation between range and period of transformation. The writer* early observed that there appeared to be a relation between the period of transformation of a product and the velocity of the α rays expelled from it. The speed of the α particle appeared to be greater the shorter the period of transformation. The data at the time were insufficient to more than suggest that a relation existed, and there were several apparent exceptions to the general rule. Geiger and Nuttall† made a careful study of the ranges of the α particles from the radio-active products of the uranium, thorium and actinium series and showed that in the great majority of cases, the range of the α particle increased with decrease of the period of transformation. This relation is shown in its simplest form by plotting the logarithm of the range of the α particle against the logarithm of the constant

* Rutherford, *Phil. Mag.* **13**, p. 110, 1907.

† Geiger and Nuttall, *Phil. Mag.* **22**, p. 613, 1911; **23**, p. 439, 1912.

of transformation. Plotted in this way, it is seen in Fig. 131 that the products of the uranium and radium series lie nearly on a straight line. The two α ray products of the uranium series whose periods are unknown are ionium and radium C. The former fits on the curve if the period of transformation is taken as about 200,000 years, and the latter if its period is taken to be of the order of one-millionth of a second. The results for the thorium and actinium series are shown in the same figure. Here again most of the products lie approximately on a straight line parallel with the line showing the relation for the uranium-radium series.

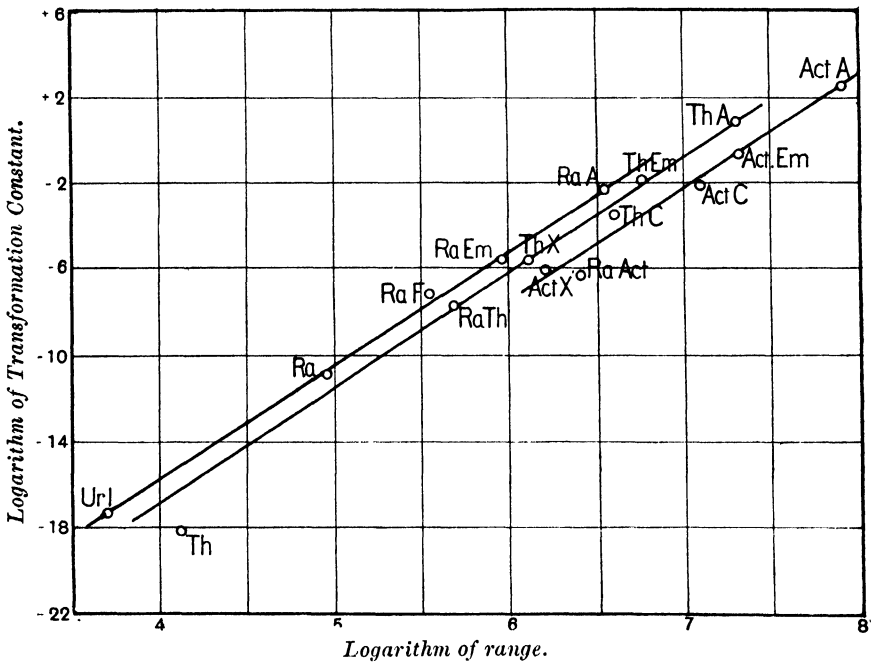

Fig. 131.

We have seen that in the case of thorium C, the atom breaks up in two ways with the emission of α particles of range 4.8 and 8.6 cms. respectively. In order to fit the curve, it is necessary to assume that the period of transformation of the product which emits rays of range 8.6 cms. is exceedingly short.

The only exception in the case of the actinium series is radio-actinium, which has a longer period than actinium X but emits a swifter α particle than the latter. It is possible that the

exception is more apparent than real and that a closer study of the transformations may remove this difficulty. The results given in Fig. 131 contain the final results of an examination of the ranges of all the α ray products of the three series. Some of the numbers given in the table, Section 70, have been found to be slightly in error.

The relation found by Geiger is of exceptional interest, for it supplies undoubted evidence that a connection exists between two of the fundamental magnitudes in radio-active transformations, viz. the velocity of expulsion of the α particle and the constant of transformation of the product. It is not difficult to find several mathematical relations between the transformation constant λ and the velocity V of the α particle which approximately express the relation. For example, the relation $\log \lambda = a + bV^n$ where a and b are constants and $n = 1$ or 2 has been suggested by Swinne*. The ranges of the α particles must be known with great accuracy before the correctness of any definite formula can be adequately tested.

There are several points of view from which these relations may be regarded. It might be supposed, for example, that the lower velocity of expulsion of the α particle from a long period product is connected with a gradual drain of the energy of the α particle by radiation before it escapes the atomic system. Under these conditions, it would be expected that the heating effect of a radio-active product would not be directly proportional to the energy of the expelled α particle. This point has been discussed earlier (Section 234) and it has been shown that the experimental evidence is not yet sufficiently definite to decide finally the question. The simplest point of view of regarding the relation is to suppose that the chance of an atom breaking up is greater, the greater the surplus energy to be got rid of to form the next product of the series. It is quite probable from general considerations that the rate of transformation would depend on the amount of the energy that must be released for the atom to form another temporarily stable system. On the assumption that the relation between period of transformation and range of α particles holds generally, Geiger has shown that in order that a radio-active

* Swinne, *Phys. Zeit.* 13, p. 14, 1912.

substance may emit an α particle of short range, for example 1 cm., the period of transformation would be so long that the activity of the product would be too small to detect even by the sensitive electric methods at our disposal. This may account for the fact that no product has been found which emits α particles of short range.

It is of interest to note that a relation of a similar, though not nearly so definite a character as that found by Geiger for the α rays, appears to hold between the velocity of expulsion of β particles and the period of transformation of the product concerned. In each of the three series, the β ray products which emit the swiftest β rays have a short period of transformation. For example, radium C, radium E, thorium D, and actinium D all have short periods and emit swift β rays. On the other hand, radium D, which emits β rays of relatively slow speed, has a long period of transformation.

247. Relation between β and γ rays from radio-active substances. Attention has previously been drawn to the remarkable complexity of the β rays emitted from most of the radio-active products. This complexity has been brought out most clearly by the study of those products which emit β rays of great penetrating power, for example, radium B + C, thorium D and mesothorium 2. On the other hand, products which emit β particles of comparatively slow speed, for example, radium itself and radium D, do not show the same complexity, for in each of these cases only two groups of homogeneous rays are emitted.

We have seen that the β rays from the products radium B and radium C together are remarkably complex, for about 30 groups of homogeneous rays are emitted from these two products together. Similarly the β rays from thorium C and D and mesothorium 2 consist of a number of groups of homogeneous rays. This complexity is all the more striking when it is remembered that, with the exception of thorium C, no product is known which emits more than one group of α rays.

It is now necessary to consider whether any explanation can be offered of the complexity of the β radiation emitted from a single product. In the first place, it is definitely established that the atom of each α ray product breaks up with the emission

of only one α particle. The number of β particles expelled per atom is not known with the same definiteness, but the work of Moseley* has shown clearly that in the case of radium B and radium C, each atom on the average emits only about one β particle during disintegration (Section 80). In order to account for the emission of groups of homogeneous rays from a single product, it is thus necessary to suppose either that the atom breaks up in a number of distinct ways, each of which is characterised by the emission of β particles of definite velocity, or that the β rays are altered in velocity in some definite way during their escape from the disintegrating atom. On the first hypothesis, it might be anticipated that the different modes of transformation of a β ray product would give rise to a series of new products, but only one is observed. In addition, the energy emitted during transformation from one definite type of matter into another would vary widely for different atoms of the same substance, and this seems improbable. On the second hypothesis, it is supposed that the disintegration of each atom takes place in exactly the same way with the emission of the same amount of energy, but that the energy of the β particle may be decreased by definite but different amounts due to transformation of its energy in its passage through the atomic system. Since it is known that β rays in escaping from an atom give rise to γ rays, it is natural to suppose that the loss of energy of the β particle in escaping from the atomic system is in some way connected with the excitation of γ rays.

The work of Barkla and others on the X rays has brought out clearly that under suitable conditions of excitation, each element emits one or more definite types of X radiation which are characteristic of the element. Barkla has determined the coefficient of absorption in aluminium of the characteristic X rays for elements up to atomic weight 140. The value of μ/D for aluminium decreases rapidly with the atomic weight and varies between 435 for calcium of atomic weight 40.1 to 0.6 for cerium of atomic weight 140.25. Plotting the logarithms of the values of μ/D against the logarithms of the corresponding atomic weights, the points for the heavier elements lie nearly on a straight line.

* Moseley, *Proc. Roy. Soc. A*, **87**, p. 230, 1912.

If this straight line be produced, it can be shown that an element of atomic weight 214 should emit a characteristic radiation whose value of $\mu/D = \cdot 04$ for aluminium. This is in good accord with the value $\mu = \cdot 0406$ for aluminium found by Soddy and Russell (Section 98) for the penetrating γ rays from radium C. It would thus appear that the penetrating γ radiation from radium C is to be regarded as the characteristic radiation of that element excited by the escape of β particles from the atomic system.

This conclusion is also supported by evidence of another kind. Whiddington has shown that the β or cathode particle incident on matter must have a definite minimum speed for each element before the characteristic radiation of the latter is excited. Over the range examined, this velocity is equal to $A \times 10^8$ cms. per second, where A is the atomic weight of the element. If this law holds generally for all the elements, the velocity of the β particle required to excite the characteristic radiation of radium C of atomic weight 214 should be 0.71 of the velocity of light. It is not improbable that the energy $\frac{1}{2}mv^2$ rather than the velocity u is the determining factor for high speed β particles. Taking this into consideration, the velocity required to excite the characteristic radiation is given by $u = 10^8 A \sqrt{\frac{m_0}{m}}$ where m_0 is the mass of the β particle for slow speeds. On this hypothesis $u = \cdot 63$ of the velocity of light. The mean value for the two methods of calculation gives $u = \cdot 67$. The corresponding energy of the β particle for the mean value of u is $1.5 \times 10^{13} e$ ergs when e is the charge carried by the β particle. If the whole energy of the β particle is converted into γ radiation, the energy absorbed in exciting the characteristic γ ray should be $1.5 \times 10^{13} e$ ergs.

It is of interest to examine whether any relation exists between the energies of the individual β particles comprising the different groups of homogeneous rays emitted by radium B and C. The velocities of the different groups found by Danysz have been previously given on page 255 and each group of homogeneous rays is marked by a number.

The energy of the β particles $= \frac{1}{2}mv^2 = \frac{1}{2}H\rho\beta Ve$ where the values of $H\rho$ and β are given in the table; V is the velocity of light, and e the charge carried by the β particle. Starting from

group No. 21, the differences between the energies of the individual β particle in the different groups is shown in column 2 of the following table.

Number of group	Difference in energy	$pE_1 + qE_2$	Calculated
(21)—(20)	$\cdot45 \times 10^{13} e$	E_1	$\cdot456 \times 10^{13} e$
" —(19)	1·37 "	$3E_1$	1·37 "
" —(18)	1·56 "	E_2	1·56 "
" —(17)	1·84 "	$4E_1$	1·82 "
" —(16)	2·05 "	$E_1 + E_2$	2·01 "
" —(15)	3·11 "	$2E_2$	3·11 "
" —(14)	4·03 "	$2E_1 + 2E_2$	4·02 "
" —(13)	4·48 "	$3E_1 + 2E_2$	4·48 "
" —(12)	4·92 "	$4E_1 + 2E_2$	4·94 "
" —(11)	6·03 "	$3E_1 + 3E_2$	6·03 "

On examining these differences, it is seen that they can be expressed closely by the relation $pE_1 + qE_2$ where $E_1 = 0\cdot456 \times 10^{13} e$, and $E_2 = 1\cdot556 \times 10^{13} e$, and p and q are whole numbers which may have any values 0, 1, 2, 3, etc. The differences calculated on this hypothesis are shown in the last column and are observed to be in close agreement for the whole series of lines from No. 21 to No. 11. This relation does not hold below line No. 11, but in all probability most of the lines Nos. 1 to 10 belong to radium B and not to radium C. The energy of the β particle for group No. 21 is $8\cdot63 \times 10^{13} e$, while its velocity is $\cdot962$ of the velocity of light. Groups 22 and 23 are not included in the calculation, for Danysz states that No. 22 includes from 3 to 5 groups of β rays of which only the average velocity is given; similarly No. 23 is a complex group.

The values of the velocity of the β particles will require to be known with great accuracy before such a relation as is indicated can be definitely established; but it does not appear likely that the connection is accidental. It is of interest to note that the value of $E_2 = 1\cdot556 \times 10^{13} e$ is in fair accord with the calculated energy of the β particle, viz. $1\cdot5 \times 10^{13} e$, which should be required to excite the characteristic radiation from radium C. The value of E_1 may in a similar way be connected with the energy required

to excite the second type of characteristic X radiation which has been observed in a number of elements by Barkla.

According to these views, the same total energy is emitted during the disintegration of each atom, but the energy is divided between β and γ rays in varying proportions for different atoms. In some atoms, most if not all of the energy is emitted in the form of a high speed β particle, in others the energy of the β particles is reduced by definite but different amounts by the conversion of part of its energy into γ rays. Suppose, for example, the total energy liberated in the form of β and γ rays during the transformation of one atom is E_0 . If the β particle before it escapes from the atom passes through two regions where the energy required to excite a γ ray is E_1 and E_2 respectively, the resulting energy of the β particle is $E_0 - (pE_1 + qE_2)$ where p and q are whole numbers corresponding to the number of γ rays excited in each region. The energy emitted in the form of γ rays is $pE_1 + qE_2$ and p γ rays of energy E_1 and q of energy E_2 appear.

According to this view, the transformation of one atom gives rise to only one β ray, but to p γ rays of one kind and q of another. The groups of homogeneous β rays observed are the statistical effect due to a large number of disintegrating atoms. The relative distribution of β particles amongst the numerous groups of homogeneous rays will depend on the probability that one or more of the units of energy E_1 and E_2 are abstracted from the β particle in traversing the atom.

The analysis of the β rays from radium C suggests that the number of γ rays emitted from radium C is considerably greater than the number of β rays. Assuming that each γ ray from radium C was converted into one β ray, Moseley found that at least two γ rays appeared for the transformation of one atom of radium C. There is reason to believe that this is a minimum estimate, and that the actual number is two or three times greater.

It is of interest to calculate the energy E_0 liberated per atom in the form of β and γ rays during the transformation of radium C. It has been shown in Section 236 that the heating effect of the β and γ rays from one gram of radium in equilibrium is about 11 gram calories per hour. Part of this energy arises from the

transformation of radium B, but there will not be much error if it be supposed that the energy of the β and γ rays from the radium C in equilibrium with one gram of radium is about 8 calories per hour. Supposing, as Moseley found, that one β ray is on the average expelled from each atom of radium C, the energy emitted per atom of radium C in the form of β and γ rays is 3.1×10^{-6} ergs or $18 \times 10^{13} e$, since 3.4×10^{10} β particles are emitted per second from radium C in equilibrium with one gram of radium. This corresponds to the emission of a β particle with a velocity about .99 of the velocity of light. This approximately corresponds with the average energy of the β particle included in group No. 22 in the table given on page 255, and would indicate that this is the head of the β ray series. On the other hand, this leaves out of account the swifter β rays observed by Danysz. Unless the energy of the γ rays has been underestimated, it does not seem possible to suppose that the swiftest β ray, which has an energy $27 \times 10^{13} e$, can be the head of the β ray series. The existence of such a swift group of β rays is, however, open to some doubt, as Danysz expressly states in his paper. The photographic effects of such swift β rays are very feeble and difficult to detect in the presence of a strong photographic action due to the γ rays.

We have so far confined our discussion to the connection between the β and γ rays emitted from radium C, for in this case the necessary data are far more definite and complete than for any other product. It seems probable, however, that the same general explanation will apply to the emission of β and γ rays from mesothorium 2 and thorium D, both of which emit a number of groups of homogeneous β rays and also penetrating γ rays. In each of these three products, the energy emitted in the form of γ rays is of the same order of magnitude as the energy emitted in the form of β rays.

We have seen, however, that in the case of certain β ray products like uranium X, radium E, and actinium D, the energy emitted in the form of γ rays is small compared with the energy emitted in the form of β rays. The poverty of γ rays compared with β rays is very marked in the case of radium E. The β rays from the latter product have been found to give a continuous spectrum, and in this respect differ from the products

like radium C and thorium D, which emit groups of homogeneous rays.

On the views which have been discussed, the relative poverty of γ rays may be explained by supposing either that the β rays have not sufficient energy to excite penetrating γ rays or that the β rays in escaping from the atom do not traverse a region of the atom in which γ rays can originate. On this hypothesis, however, the complex character of the β rays still requires explanation.

Whatever may be the explanation of the relation between the emission of β and γ rays from radio-active matter, there appears to be no doubt that an intimate connection exists between them and that the β and γ rays appear together as the result of the same atomic explosion. The general results indicate that the complexity of the β rays is connected with the property of the atom of transforming part of the energy of a β ray into the form of a γ ray, and *vice versa*. The atomic explosion which results in the loss of a β particle is particularly favourable to the excitation of γ rays, and, under these conditions, it would appear that more than half of the total energy appears as γ rays. The efficiency of the conversion of β into γ rays is far greater for a disturbance originating within the atom than when a stream of β rays falls on ordinary matter. It is known that in the latter case less than one per cent. of the energy of the β rays is transformed into γ rays.

248. Constitution of the atom. The theory that the atoms of matter are all built up of some simple fundamental unit or protyle has been advanced at various times by prominent chemists and physicists. One of the earliest hypotheses of this kind was that due to Prout, who supposed that all the elements were built up of hydrogen. This general point of view has received strong support from observations that the properties of elements vary in a periodic manner with their atomic weight. This is exemplified by the classification of the elements according to the well-known periodic law. In order to explain the electrical and optical properties of matter, it was generally supposed that the atom consisted of a number of positively and negatively charged particles, held in equilibrium by electrical forces. The properties

of such electrical atoms were early studied by Larmor and Lorentz.

The proof of the existence in all kinds of matter of negative electrons which have a mass small compared with that of the hydrogen atom, gave a great impetus to the study of atomic constitution. Lord Kelvin devised a model atom which consisted of a uniform sphere of positive electrification throughout which a number of negative electrons was distributed. The properties of this type of atom have been worked out in great detail by J. J. Thomson*. He investigated the possible stable arrangements of a number of electrons moving about in a sphere of uniform positive electrification. In order to produce an electrically neutral atom, the distributed positive charge must be equal and opposite to the charge carried by the electrons. The properties of such a model atom are very striking, and indirectly suggest a possible explanation of the periodic law in chemistry. J. J. Thomson has shown that the electrons, if in one plane, arrange themselves in a number of concentric rings; and generally, if they are not constrained to move in one plane, in a number of concentric shells like the coats of an onion.

The mathematical problem is much simplified if the electrons are supposed to rotate in rings in one plane, the electrons in each ring being arranged at equal angular intervals. J. J. Thomson has determined the number of rings and the number of electrons in each ring which are necessary to ensure stability of the atom.

Different arrangements of electrons vary widely in stability; some may acquire an extra electron or two and yet remain stable; others readily lose an electron without disturbing their stability. The former would correspond to the electro-negative atom, the latter to the electro-positive. In order for an atom to remain stable, it is necessary that the radiation of energy by the electrons in the atom should be small. A single electron rotating in a circular orbit is a powerful radiator of energy and would soon lose all its energy in the form of electromagnetic radiation. J. J. Thomson showed, however, that the radiation of energy from a ring of electrons diminishes rapidly with the number of electrons in the ring. For example, he found that the radiation from a

* J. J. Thomson, *Phil. Mag.* 7, p. 237, 1904.

symmetrical group of six particles moving with a velocity of $1/10$ of the velocity of light is less than one-millionth part of the radiation from a single particle describing the same orbit with the same velocity. When the velocity is $1/100$ of that of light the amount of radiation is only 10^{-16} that of a single particle moving with the same velocity in the same orbit.

Results of this kind indicate that an atom consisting of a large number of revolving electrons may radiate energy extremely slowly, and yet, finally, this minute but continuous drain of energy from the atom must result either in a rearrangement of its component parts into a new system, or in an expulsion of electrons, or groups of electrons, from the atom. J. J. Thomson suggested that this continuous loss of energy in the form of radiation might be the cause of the disintegration of the radio-elements.

Since the mass of the electron at slow speeds is about $1/1700$ of the mass of the hydrogen atom, it was natural at first to suppose that the hydrogen atom, for example, was composed of a large number of electrons, and that possibly the whole mass of the atom might be due to the electrons which composed it. J. J. Thomson* showed later, however, from several lines of argument, that the number of electrons comprising an atom was about three times its atomic weight. If this were the case, only a minute fraction of the mass of the atom could be due to the electrons, and the rest presumably was associated with the positive electricity.

Simple models of atoms to imitate the behaviour of polonium in shooting out α particles, and of radium in shooting out β particles, have been discussed by Lord Kelvin†. It is possible to devise certain stable arrangements of positively and negatively electrified particles, supposed to constitute an atom, which, on the application of some disturbing force, break up with the expulsion of a part of the system with great velocity.

One of the most powerful methods of obtaining information on the internal structure of the atom lies in the study of the scattering of high speed particles, for example, of α and β particles, in their passage through matter. In consequence of their great

* J. J. Thomson, *Phil. Mag.* **11**, p. 769, 1906.

† Kelvin, *Phil. Mag.* **8**, p. 528, 1904; **10**, p. 695, 1905.

energy of motion, a high speed α or β particle must pass through the atom which lies in its path. The deflection of the charged particle from its rectilinear path as the result of an atomic encounter throws light on the intensity and distribution of the electrical forces within the atom to which these deflections are due. One of the most noticeable features of the scattering of α particles by thin films of matter is that a small fraction of the α particles is deflected through angles of more than 90° . There appears to be no doubt that the large deflection sometimes suffered by an α particle is the result of a close encounter with only one atom of matter. The type of atom devised by Kelvin and J. J. Thomson, in which the positive electricity is distributed throughout a sphere of radius comparable with the diameter of the atom, does not seem capable without modification of producing the large deviations of an α particle which are observed.

The writer* found, however, that the single large scattering of α particles could be satisfactorily explained by supposing that the atom consisted of a concentrated positive charge at its centre and surrounded by a distribution of electrons to render it electrically neutral. It was necessary to suppose that the greater part of the mass of the atom was associated with the positive charge which for distances up to 3×10^{-12} cms. behaved as if it were concentrated at a point.

The large angle scattering of the α particle is then almost entirely due to the passage of the α particle through the intense electric field surrounding the central charge. Supposing the electrical force to vary as the inverse square of the distance from the central charge, the positively charged α particle in passing close to the centre of the atom describes a hyperbolic orbit, the angle of deflection being greater the nearer the α particle passes the centre of the atom. The laws of scattering to be expected on this hypothesis have been given in Section 74. These laws of scattering have recently been verified experimentally by Geiger and Marsden in the laboratory of the writer. They found, for example, that the theoretical relation between the number of α particles scattered and the scattering angle held within the limits of experimental error over an enormous range. The scattering of

* Rutherford, *Phil. Mag.* 21, p. 669, 1911.

α particles by thin films of matter can be completely explained on the assumption that the atom contains a strong central charge concentrated over a very minute volume. The comparison of experiment with the theory shows that the central charge in an atom corresponds to about $\frac{1}{2}Ae$, where A is the atomic weight of the element and e the charge on the electron. This relation holds closely for atoms of atomic weight between aluminium and gold. The theory of scattering requires a slight modification when the mass of the scattering atom is comparable with the mass of the α particle, *i.e.* with the mass of the helium atom.

On these views, the atom of gold, for example, of atomic weight 196, is supposed to contain at its centre a concentrated charge about $100e$, and to be surrounded by a distribution of 100 negative electrons. The electrons may be supposed to be distributed throughout a spherical volume or in concentric rings in one plane.

On this theory the α particle in rapid motion consists of two unit positive charges concentrated throughout a volume minute compared with the volume of the atom, as ordinarily understood. Since it does not seem possible that the α particle can retain any of its constituent electrons in escaping from the radio-active atom and in its violent encounters with the atoms of matter it traverses in its path, it is reasonable to suppose that the neutral helium atom contains two unit positive charges and two negative electrons.

This type of "Saturnian" atom was first suggested in 1904 by Nagaoka*, who investigated mathematically the stability of an atom composed of a central attracting mass surrounded by rings of rotating electrons. He showed that such a system was stable if the attractive force was large, and the electrons in rapid motion.

249. Structure and mode of disintegration of the radio-active atoms. The study of the transformations of radio-active matter has brought to light the important fact that helium appears to be one of the more elementary substances from which the heavier atoms are built up. For example, uranium in its series of transformations expels eight helium atoms and thorium six.

* Nagaoka, *Phil. Mag.* 7, p. 445, 1904.

It thus seems reasonable to suppose that the heavier atoms are made up in part of helium atoms. This may also hold for the lighter atoms, for it is significant that the atomic weights of a number of elements differ nearly by four, the atomic weight of helium, or by an integral multiple of four. No doubt hydrogen as well as helium is one of the fundamental units of which the heavier atoms are composed. The view that the heavier atoms are largely built up of helium atoms seems to be confirmed by the observation (see last section) that the central charge of the atom is about half its atomic weight. For example, the uranium atom of atomic weight 238 may be made up of about 59 atoms of helium carrying a positive charge $118 e$.

The atom of uranium may be supposed to consist of a central charge of positive electricity surrounded by a number of concentric rings of negative electrons in rapid motion, the outer ring being comparable in diameter with the diameter of the atom. Practically the whole charge and mass of the atom are concentrated at the centre, and are probably confined within a sphere of radius not greater than 10^{-12} cm. No doubt the positively charged centre of the atom is a complicated system in movement, consisting in part of charged helium and hydrogen atoms. It would appear as if the positively charged atoms of matter attract one another at very small distances, for otherwise it is difficult to see how the component parts at the centre are held together.

For some cause, at present unknown, the central system of the atom of uranium becomes unstable. One of the component helium atoms escapes from the central mass and increases in velocity in passing through the intense electrical field due to the atom. It is difficult to be certain how much of the energy of the expelled α particle was originally possessed by the particle before its release from the central mass, and how much is acquired in its escape from the atom. It would appear likely that the greater part of the energy of the α particle is acquired in traversing the atomic field, and that only a small part is due to its original energy of motion.

The escape of the α particle carrying two positive charges must lead to the expulsion of two electrons from the atom, probably from its surface, in order for the atom to be electrically

neutral. The fact that the recoil atoms resulting from the expulsion of an α particle, always carry a positive charge would suggest that at least three electrons are emitted in most cases. The escape of an α particle alters the system of forces acting on the central charge and on the rotating electrons. The residual atom is now more unstable than before and ultimately loses another α particle. The loss of two α particles carrying four unit charges must alter entirely the forces holding the electrons in equilibrium. One of these rings becomes unstable and breaks up. Part of the surplus energy of a ring of electrons is released in the form of a high speed β particle and part in the form of γ rays, the division between the two forms of energy depending on factors which are not at present understood. On the point of view here outlined, it is seen that the instability of the atom may be conveniently considered to be due to two causes, although these are not mutually independent, viz. the instability of the central mass and the instability of the electronic distribution. The former type of instability leads to the expulsion of an α particle, the latter to the appearance of β and γ rays. It is noteworthy that the period of transformation of β ray products is on the whole much shorter than for the α ray products. This suggests that any want of stability of the electronic distribution leads more rapidly to a breaking up of the atom than a want of stability of the central mass.

Since the centre of an atom is positively charged, the observed velocity of escape of a β particle from the atom affords no definite information as to the velocity of the β particle at the moment of its escape from its original position within the atom. Unless the β particle comes from the surface of the atom, its velocity must be much reduced in passing through the strong central field.

It has not so far been found possible to hasten or retard the rate of transformation of radio-active matter by the physical or chemical forces available in the laboratory. Even the exposure of a radio-active substance like the radium emanation to an intense bombardment by its own radiations has no observable effect on its rate of transformation. For these reasons it is difficult to offer any explanation of the causes operating which lead to the ultimate disintegration of the atom. It was at first suggested that the

disintegration might be a result of the instability brought about by a continuous drain of energy by radiation. Unless the atoms of the same substance at the moment of their formation have different degrees of stability, it is difficult to account on this view for the exponential law of transformation.

In the absence of any definite information of the causes which bring about the disintegration of atoms, it appears simplest, as pointed out in Section 157, to regard the law of transformation as an expression of the law of probability.

No evidence has yet been obtained that the process of transformation taking place in the radio-elements is reversible. It is conceivable, for example, that a trace of radium might appear in the course of the transformation of the radium emanation. The writer tried the experiment but with negative results. In a similar way, it might be anticipated that lead when bombarded by α particles might give rise to polonium, but no detectable effect was noted in experiments made by the writer. No evidence has so far been obtained that any substance can be made radio-active by bombardment with α , β or γ rays. It seems reasonable to suppose that under some conditions of the earth's history the converse process took place, and the heavy atoms were built up from the lighter and more elementary substances. It does not follow, however, that the process of transformation as shown by the radio-elements is completely reversible. The stages of building up of complex atoms out of simpler forms may be very different to the stages of transformation observed.

CHAPTER XIX.

RADIO-ACTIVITY OF THE EARTH AND ATMOSPHERE.

250. Radio-active matter in the air. In this chapter a brief account will be given of experiments that have been made upon the distribution and nature of the radio-active matter observed in the atmosphere and throughout the earth's crust. A large amount of work has been done in this interesting field of investigation, but it is only possible in the compass of a single chapter to draw attention briefly to the main results of importance that have been obtained.

The pioneers in this important field of enquiry were Professors Elster and Geitel, and no investigators have contributed more to our knowledge of the radio-activity of the earth and atmosphere. In 1901 Geitel* and C. T. R. Wilson† had shown independently that a charged conductor placed inside a closed vessel gradually lost its charge, and that this was due to a small volume ionisation of the air inside the vessel. Elster and Geitel also found that a charged body exposed in the open air lost its charge rapidly, and that the rate of discharge was dependent on the locality and on atmospheric conditions. It occurred to Elster and Geitel‡ that the ionisation of the air might be due in part at least to a distribution of radio-active matter in the atmosphere. The time was opportune to test this hypothesis, for the writer had shown in 1900 the existence of the thorium emanation, and the active deposit to which it gave rise. It was known that the active

* Geitel, *Phys. Zeit.* 2, p. 116, 1901.

† C. T. R. Wilson, *Proc. Roy. Soc. A*, 68, p. 151, 1901.

‡ Elster and Geitel, *Phys. Zeit.* 2, p. 590, 1901.

deposit was concentrated on a negatively charged conductor exposed in the presence of the emanation. In the first experiment a cylinder of wire-netting, charged negatively to 600 volts, was exposed for several hours in the open air. The cylinder was then removed, and quickly placed in a large bell-jar, inside which was placed an electroscope to measure the rate of discharge. It was found that the rate of discharge was increased to a slight extent. In order to multiply the effect, a wire about 20 metres in length was exposed at some height from the ground, and was kept charged to a high potential by connecting it to the negative terminal of an influence machine. After exposure for some hours, this wire was removed and placed inside the ionisation vessel. The rate of discharge was found to be increased many times by the presence of the wire. No increase was observed when the wire was charged positively instead of negatively. It was found that the radio-active matter could be removed from the wire in the same way as from a wire made active by exposure in the presence of the thorium emanation. A piece of leather moistened with ammonia was rubbed over the active wire. On testing the leather, it was found to be strongly radio-active. When a long wire was used, the amount of activity obtained on the leather was comparable with that possessed by a gram of uranium oxide.

The activity produced on the wire was not permanent, but disappeared to a large extent in the course of a few hours. The amount of activity produced on a wire of given size, exposed under similar conditions, was independent of the material of the wire. Lead, iron and copper wires gave about equal effects.

These experiments were repeated in 1902 by Rutherford and Allen* in Montreal. The activity obtained on a negatively charged wire exposed in the open air was found to be mainly due to α rays and to decay to half value in about 45 minutes. The rate of decay was found to be independent of the material and potential of the wire, and of the time of exposure in the atmosphere. It seemed probable that the active matter collected on the wire was derived from an emanation mixed with the atmosphere, and it was of importance to decide whether the decay of the active wire could be explained by the presence in the air of the

* Rutherford and Allen, *Phil. Mag.* 4, p. 704, 1902.

radium or thorium emanation. This was definitely proved to be the case by Bumstead*, who showed that the greater part of the activity imparted to a wire exposed for several hours near the surface of the earth decayed at a rate identical with that of the active deposit of radium. After a sufficient interval had elapsed to allow the active deposit of radium to disappear, some residual activity was always observed, which decayed slowly, falling to half value in about 11 hours. This showed that the active deposit of thorium as well as that of radium was present in the atmosphere.

If it be supposed that the atoms of the active deposit are conveyed at a constant rate to the charged wire, the activity due to the radium active deposit will reach a practical maximum after three or four hours' exposure. On account, however, of the long period of transformation of thorium B (about 11 hours), an exposure of two or three days is necessary to obtain the maximum activity due to the thorium active deposit. From the results obtained by Bumstead at New Haven, it followed that about 30 per cent. of the maximum activity obtained for a long exposure was due to the thorium active deposit. This interesting result has been confirmed by a number of observers in different countries. Blanc† found that about 70 per cent. of the total activity obtained at Rome was due to the active deposit of thorium; W. Wilson‡ in Manchester, and S. J. Allen§ in Pittsburg, found values of about 60 per cent. These results show that the emanations of radium and of thorium are everywhere present in the atmosphere near the surface of the earth.

It will be seen later that the emanations in the atmosphere undoubtedly arise from the presence of radium and thorium in the earth's crust. It is consequently to be expected that the actinium emanation would also be present close to the surface of the earth. On account, however, of the rapidity of decay of the actinium emanation, the activity due to it would be small and difficult to distinguish from that due to the radium emanation.

* Bumstead, *Amer. Journ. Sci.* **18**, p. 1, 1904.

† Blanc, *Phil. Mag.* **13**, p. 378, 1907.

‡ W. Wilson, *Phil. Mag.* **17**, p. 321, 1909.

§ S. J. Allen, *Phys. Rev.* **26**, p. 483, 1908.

C. T. R. Wilson* found that freshly fallen rain was radio-active. In order to test this point about 50 c.c. of water was evaporated in a platinum dish and the activity of the residue examined in an electroscope. The activity so obtained fell to half value in about 30 minutes, and disappeared in the course of a few hours. C. T. R. Wilson† in England, and S. J. Allen‡ and McLennan§ in Canada, showed that freshly fallen snow was also radio-active, and that the activity decreased to half value in about 30 minutes. The activity shown by rain and snow is to be expected since the drops or flakes in their fall pass through air in which atoms of the active deposit of radium are distributed. Some of the atoms of active matter diffuse to the surface of the falling particles and are removed with them. No doubt the activity obtained would be increased if the falling particles carried a negative charge, for they would act as centres for collection of the active deposit on account of the electric field surrounding them.

McLennan|| determined the amount of active matter to be derived from the air filled with fine spray. The experiments were made at the foot of the American falls at Niagara. The amount of activity collected on a wire was only about one-fifth of the amount at the neighbouring city of Toronto. No doubt the greater part of the active matter was removed from the air by the heavier water drops which were not collected by the wire. The falling spray was found to be negatively charged, for it permanently charged the wire to a potential of about -7500 volts.

251. Theory of collection of active matter. We have seen (Section 148) that in a strong electric field, the active deposits of radium and thorium are concentrated on a negatively charged conductor. The radium emanation in breaking up gives rise to positively charged atoms of radium A, which travel to the negative electrode. In a similar way, the atoms of the thorium emanation give rise to positively charged atoms of thorium A. The charged atoms of the active deposit in the absence of an electric

* C. T. R. Wilson, *Proc. Camb. Phil. Soc.* **11**, p. 428, 1902; **12**, p. 17, 1903.

† C. T. R. Wilson, *Proc. Camb. Phil. Soc.* **12**, p. 85, 1903.

‡ S. J. Allen, *Phys. Rev.* **16**, p. 306, 1903.

§ McLennan and Burton, *Phys. Rev.* **16**, p. 184, 1903.

|| McLennan and Burton, *Phys. Rev.* **16**, p. 184, 1903; McLennan, *Phil. Mag.* **5**, p. 419, 1903.

field behave like positive ions and recombine with the negative ions which are present in the air, and become electrically neutral. Consider now a uniform distribution of radium emanation in the atmosphere near the surface of the earth. In the absence of an electric field there must be radio-active equilibrium between the emanation and its quick period products radium A, B and C. Under the normal potential gradient due to the earth's electric field, there is a steady movement of positive ions, and of positively charged atoms of active matter to the surface of the earth. Since the earth is under normal conditions negatively charged, the active deposit of radium must be deposited on its surface by the action of the electric field. There will be a local concentration of active matter on projecting surfaces, and it is to be expected that a projecting peak will receive more activity per unit area than the plain below.

When, as in the experiments of Elster and Geitel, a negatively charged wire is suspended horizontally some distance above the earth, the positively charged atoms of active matter travel to the charged wire and are deposited on its surface. Several attempts have been made to determine the "average collecting distance" of the wire, *i.e.* the radius of the cylindrical surface with the wire as axis from which all the atoms of active deposit are collected by the charged wire*. It is difficult, however, to draw very definite conclusions on account of the uncertainty of the data involved. It has been generally supposed that only positively charged atoms of radium A are collected on the wire, and that they travel in an electric field at the same rate as positive ions. Account has to be taken of the rate of recombination of the charged atoms of radium A with the negative ions of the air, for only those atoms reach the wire which retain their charge. The constant of recombination is no doubt much affected by atmospheric conditions, and the number of dust nuclei present. Since the atom of radium A in breaking up gives rise to a positively charged atom of radium B, it would be necessary in a complete theory to take account of the number of charged atoms of radium B as well as of radium A which reach the wire. In the theory advanced by Kinoshita†,

* Mme Curie, *Radio-activité*, 2, p. 486.

† Kinoshita, S. Nishikawa, S. Ono, *Phil. Mag.* 22, p. 821, 1911.

account was taken of the effect of a wind of a constant velocity blowing at right angles to the charged wire, and the shape of the collecting boundary was determined. It appears that the velocity of the wind theoretically has little, if any, effect on the amount of active matter collected by the wire. The collecting distance obviously will depend on the potential of the charged wire. By comparing the amount of activity obtained on a wire exposed in a metal cylinder open to the air with that obtained on a wire charged to the same potential in the open air, Eve* deduced that the collecting distance of a wire charged to $-10,000$ volts was from 40 to 80 cms.

252. Effect of meteorological conditions. Elster and Geitel† made a detailed examination of the effect of meteorological conditions on the amount of active matter to be derived from the atmosphere. For this purpose a portable apparatus was devised. The active matter was collected on a wire of constant diameter, which was always kept charged to the same potential, and the activity of the wire was measured in a standard electroscope. Under these definite conditions, the rate of discharge of the electroscope served as a measure of the amount of active matter collected on the wire. Elster and Geitel found that the amount of active matter collected was subject to great variations. The extreme values obtained varied in the ratio of 16 to 1. Lowering of the temperature increased the amount of active matter; for example, the average activity for temperatures below 0°C . was 1.44 times the average value for temperatures above 0°C . The height of the barometer was found to exert a marked effect. A lowering of the pressure was always accompanied by an increase in the amount of active matter. An effect of this kind is to be expected if the emanation in the atmosphere is derived mainly from diffusion through the soil. A lowering of pressure would cause the air rich in emanation to be drawn up through the capillaries of the soil into the atmosphere.

No definite connection was found to exist between the amount of active matter and the volume ionisation of the air. The largest

* Eve, *Phil. Mag.* 10, p. 98, 1905.

† Elster and Geitel, *Phys. Zeit.* 4, pp. 138, 522, 1903.

amount of active matter was observed during a fog when the ionisation was apparently very small. It appears, however, fairly certain that a connection must exist between the ionisation and the amount of emanation in the air. It is difficult, however, to prove such a relation, since the activity collected on a wire and the ionisation measured by ordinary methods are affected to different degrees by the distribution of nuclei in the atmosphere. The ionisation measured during a fog or in a smoke-laden atmosphere appears to be small, as there is a rapid recombination between the ions and the dust nuclei. On the other hand, the active matter would deposit on the water drops or other nuclei, and be collected by the charged wire (see p. 627).

The amount of active matter in the air does not appear to be much affected by moisture, for about the same amount is observed in the atmosphere during the dry winter in Canada with a snow covered soil as in the moist air of summer.

It should be pointed out that the amount of activity collected on a charged wire under definite conditions is not necessarily proportional to the amount of emanation in the atmosphere. The amount of activity obtained on the wire undoubtedly depends on the amount of nucleation of the atmosphere as well as on the amount of emanation present.

253. Distribution of active matter over land and sea.

Numerous observations made in various parts of the world show that the radium emanation is everywhere present in the atmosphere. The thorium emanation is also observed over land areas, but is either absent or present in very small quantity over the sea. There appears to be no doubt that the emanations present in the atmosphere must be liberated from the surface of the land. The period of transformation of the radium emanation is sufficiently long to allow the emanation to be transported over long distances by air currents, and to be mixed with the atmosphere for a considerable height, before it has lost much of its activity. For example, Fleming* from balloon observations found that active matter was present in the air at an altitude of 3000 metres. At this height about the same amount was collected as at the surface

* Fleming, *Phys. Zeit.* 9, p. 801, 1908.

of the earth. Saake* and Gockel† found that the amount of active matter collected at high altitudes was greater than at the sea level. It does not necessarily follow that the air at great altitudes contains more radium or thorium emanation, for the amount of active matter collected for a given volume distribution of emanation will depend on the pressure of the air and the amount of dust or other nuclei in the atmosphere.

When we take into account the quick period of transformation of the thorium emanation (half value in 54 seconds), it at first sight appears remarkable that the active deposit should be present at considerable heights in the atmosphere above the land. The emanation, however, is converted *in situ* into thorium B, which has the comparatively long period of 11 hours. Some of the thorium B, like the radium emanation, lasts sufficient time to be transported over considerable distances. Taking account of the difference in their periods, it is to be expected, however, that the ratio of the amount of thorium to radium emanation should progressively diminish with height above the earth level.

The amount of active matter in the air does not appear to depend in any way upon the sun. Simpson‡, who made experiments at Karasjoh in Norway, found that the amount of active matter collected on a charged wire was about the same in summer as in winter, when the sun did not arise above the level of the horizon. The amount of active matter in the air was considerably greater than the normal amount observed by Elster and Geitel in Germany, although the ground was frozen hard and covered with snow. Similar observations have been made by Allen during the Canadian winter. Since it does not seem possible that much emanation can escape from a frozen soil covered with snow, it appears probable that the greater part of the emanation observed must have been transported from more temperate regions.

If the radium emanation is derived from the surface of the land, it is to be expected that the amount of radium emanation would be much greater over the land than over the sea, especially at great distances from land. It will be seen later (Section 258)

* Saake, *Phys. Zeit.* 4, p. 626, 1903.

† Gockel, *Phys. Zeit.* 8, p. 701, 1907.

‡ Simpson, *Phil. Trans. Roy. Soc. A*, 205, p. 61, 1905.

that sea water contains far too little radium to provide an amount of emanation in the air comparable with that observed over the land. This appeared probable from the early observations of Elster and Geitel, Simpson, Linke, and Dike, who found that air from the sea contained much less emanation than air from the land. This conclusion, however, did not appear to be supported by the observations made by Eve* in crossing the Atlantic from Montreal to England. The amount of activity collected on a charged wire in mid-ocean was about the same as that collected on land in Montreal. These results were only explicable on the supposition that the air from the land containing the radium emanation had been transported to mid-ocean before the activity of the emanation had much diminished. This explanation is entirely borne out by the later and more systematic experiments of Simpson and Wright†, which were made on the Antarctic ship "Terra Nova" on her voyage from England to New Zealand. The mean value of the activity obtained on a negatively charged wire on the voyage from England to Melbourne was found to be 6 in terms of the arbitrary unit adopted by Elster and Geitel, the maximum value 21 and the minimum 1. The mean value in terms of the same unit found by Elster and Geitel in Wolfenbüttel (Germany) was 19, the maximum 64 and the minimum 4. The corresponding values found by Simpson at Karasjøh in Norway were 93, 432 and 20. Special interest attaches to observations near the Cape. The mean activity at Matjesfontein, 200 miles inland and 2970 feet above sea level, was 124. With an offshore breeze, the activity observed on the vessel leaving the Cape was 130. With a change of wind to the south-west, the mean activity fell to 4. It was thus abundantly clear that air over the sea contained much less emanation than on land. It was observed that over the Atlantic in both hemispheres, the amount of emanation increased from latitude 40° towards the equator, but within 10° of the equator the amount of emanation showed a low value. The amount of emanation over the sea was found to be much more constant than over the land, and only small variations were observed for measurements extending over several days.

* Eve, *Phil. Mag.* 13, p. 248, 1907; *Terr. Mag.* March, 1909.

† Simpson and Wright, *Proc. Roy. Soc. A*, 85, p. 175, 1911.

254. Amount of emanation in the atmosphere. The first attempt to determine the actual amount of radium emanation present per cubic metre of the atmosphere was made by Eve*, by comparing the activity obtained on a negatively charged wire with the amount derived from a known quantity of radium emanation. The uncertainty, however, of deduction of the amount of radium emanation in the air from observations of this kind made it desirable to measure the actual amount of radium emanation present in a given volume by a method which was independent of meteorological conditions. This was accomplished by Eve† and Satterly‡ by using the property of charcoal, and especially of cocoanut charcoal, of absorbing the emanation from the air at atmospheric temperature. For this purpose, a known constant current of air was drawn through tubes of cocoanut charcoal for some hours or days. The charcoal was then heated to drive off the radium emanation and the collected gases were introduced into an emanation electroscope, which had been previously standardised. The charcoal was found to absorb only a part of the emanation from the air. The efficiency of the absorption was determined by aspirating air through a very weak radium solution which supplied emanation at a constant rate. The amount of emanation per cubic metre is most conveniently expressed in terms of the weight of radium which would be in equilibrium with that quantity of emanation. The following average results were obtained by Eve in Montreal, Satterly in Cambridge, and Ashman in Chicago.

Eve	60	$\times 10^{-12}$	gr. Ra per cubic metre.
Satterly	100	„	„
Ashman	89	„	„

The amount of emanation in the air was determined by Ashman§ by a different method. Air was passed for some time through a tube immersed in liquid air and the amount of emanation condensed in the tube was then measured.

* Eve, *Phil. Mag.* **10**, p. 98, 1905.
 † Eve, *Phil. Mag.* **14**, p. 724, 1907; **16**, p. 622, 1908.
 ‡ Satterly, *Phil. Mag.* **16**, p. 584, 1908.
 § Ashman, *Amer. Journ. Sci.* **26**, p. 119, 1908.

The mean value of these three observers is 83×10^{-12} gr. Ra. If it be supposed that the average height of the emanation atmosphere is 10 kilometres, the quantity of radium per square kilometre of the earth's surface required to keep up this supply of emanation is about one gram. Since the radium emanation can only escape from a small depth of soil, this calculation brings out clearly the very large quantity of radium in the aggregate that must be distributed close to the earth's surface.

Eve and Satterly made an extensive series of observations of the variation in the amount of emanation under different meteorological conditions. It does not seem possible, however, to draw any definite deductions on the variation of amount of emanation with meteorological conditions which will hold for all localities. It is necessary to take into account whether the prevailing winds come from the sea or have crossed over large areas of land. For example, Eve working in Montreal found the amount of emanation greatest during the approach of a cyclone accompanied by rain or a rapid thaw of the snow. On the other hand, Satterly in Cambridge observed that the amount of emanation was least during cyclones accompanied by wet weather. These conflicting results are no doubt capable of explanation when geographical considerations are taken into account. It is obvious that systematic observations of the amount of emanation over land and sea, at all parts of the world, will be required before any very definite conclusions can be reached. The results as a whole, however, strongly support the original suggestion of Elster and Geitel that the emanations in the atmosphere arise mainly from the soil.

255. Penetrating radiation from the earth. It will be shown later that both uranium and thorium are distributed in measurable quantity throughout the surface of the earth. Since the products of both uranium and thorium emit γ rays of a penetrating character, it is to be expected that γ rays should be detected in the atmosphere near the earth. The proof of the presence of such a penetrating radiation was first given independently by Rutherford and Cooke* and by McLennan†. The

* Rutherford and Cooke, *Amer. Phys. Soc.* Dec. 1902.

† McLennan and Burton, *Phys. Rev.* **16**, p. 184, 1903.

latter measured by an electrometer the natural ionisation in a large closed metal cylinder. This cylinder was then placed in another, and the space between them filled with water. For a thickness of water of 25 cms., the ionisation was decreased by about 27 per cent. Rutherford and Cooke observed that the rate of discharge of a sealed brass electroscope was diminished by surrounding the electroscope with lead. A detailed investigation was made by Cooke* to determine the decrease of the ionisation in the electroscope for screens of different material and thickness. A thickness of 3 cms. of lead round the electroscope decreased the ionisation by 30 per cent. When the apparatus was surrounded by 5 tons of lead, the reduction of the ionisation was no greater than for a screen of lead 3 cms. thick. An iron screen was also found to decrease the ionisation. By suitably arranging lead screens, it appeared as if the radiation at the basement of the building came equally from all directions. This penetrating radiation has been observed in about equal amounts at all points over the surface of the land. From considerations, discussed in the next section, it appears that in the open air the radiation comes almost entirely from the earth. The amount of γ radiation supplied by the active matter in suspension in the atmosphere must be relatively insignificant. Cooke observed that ordinary building bricks emitted a strong β radiation, and no doubt also γ rays of a penetrating character.

Wood and Campbell† state that the ionisation in closed vessels showed a double diurnal variation, which appeared to be connected with the changes of the potential gradient in the atmosphere. Such a diurnal variation was not observed in similar experiments by Wright in Toronto. A diurnal variation of the ionisation in a sealed vessel in the open air could only be brought about by a change in the intensity of the γ radiation from the earth and atmosphere. Since it seems improbable that the γ radiation from the mass of the soil itself can be subject to much variation in the course of a day, a diurnal variation can only be explained by supposing that the active matter present in the atmosphere is deposited on the surface of the earth at very different rates during

* Cooke, *Phil. Mag.* 6, p. 403, 1903.

† Wood and Campbell, *Phil. Mag.* 13, p. 265, 1907.

the course of the day. The γ radiation due to the active matter suspended in the atmosphere is too small to produce the effect observed.

If the γ radiation arises mainly from the land itself, it is to be expected that the intensity of this radiation in the atmosphere will diminish rapidly with altitude on account of the absorption of the γ rays by air. The decrease of intensity to be expected with altitude has been calculated by Eve*, and he has shown that at a height of 100 metres, the intensity should be only 0·32 at the surface. For a height of 1000 metres, the intensity should be 0·001. This decrease of intensity with altitude is to some extent confirmed by the observations of McLennan and Macallum† and Wulf‡. The latter found that the penetrating radiation from the earth produced about 6 ions per c.c. in a closed vessel at the base of the Eiffel Tower in Paris, and only 3·5 at the top at a height of 300 metres. The decrease observed is smaller than that to be expected theoretically, but it must not be forgotten that the active matter distributed on the structure may contribute some γ rays. It is to be expected that the γ radiation should be present in very small intensity over the sea. Wright§ and others have found that the γ radiation is not detectable on the surface of a lake; for the water absorbs the γ radiation from the soil and does not itself contain sufficient active matter to supply γ rays in measurable quantity.

It is of interest to calculate the amount of radium, supposed uniformly distributed in the surface soil, to give rise to the intensity of the γ radiation observed at the earth's surface. The number N of ions produced per c.c. per second in air by the γ rays from a point source of Q grams of radium after traversing a thickness r cms. of soil is given by $N = KQ/r^2e^{\mu r}$ where K is a constant and μ the coefficient of absorption of the γ rays by the soil. In the actual case, however, the radium in the earth is not distributed at a point but supposed to be uniformly distributed throughout its volume. It can simply be shown that the number of ions N

* Eve, *Phil. Mag.* **21**, p. 26, 1911.

† McLennan and Macallum, *Phil. Mag.* **22**, p. 639, 1911.

‡ Wulf, *Phys. Zeit.* **10**, p. 997, 1909.

§ Wright, *Phil. Mag.* **17**, p. 295, 1909.

produced per c.c. per second in a cavity deep in the earth is given by $N = 4\pi KQ/\mu$ where Q is the amount of radium per c.c. of the soil. It is easily seen that the value of N at the surface of the earth is one half of this, or $2\pi KQ/\mu$.

Measurements at various points of the earth's surface indicate that the value of N due to the penetrating radiation varies between 3 and 5 in an aluminium vessel. We shall not be far in error in taking $N = 3$ in the air close to the earth. The value of K found by Eve was 3.8×10^9 (Section 105). In a more recent determination Moseley and Robinson found a value 6×10^9 . Taking the latter value, and taking $\mu/D = .04$ where D is the density of the soil, the amount of radium per gram of soil to produce 3 ions per c.c. close to the earth comes out to be 3×10^{-12} gram. This is in fair accord with the value found experimentally by Strutt and Joly in representative rocks (see Section 258). No doubt part of the penetrating radiation is supplied by the thorium distributed in the earth. The above calculation thus shows that the γ radiation from the thorium and radium distributed in the earth is equivalent to that emitted by 3×10^{-12} gr. Ra per c.c.

256. Ionisation in the atmosphere. Measurements to determine the relative ionisation of the air at different localities and for varying meteorological conditions were first made by Elster and Geitel. For this purpose, a charged body exposed in the open air was attached to a portable electroscope and the rate of loss of charge was observed by the movement of the gold or aluminium leaf. This apparatus, while very convenient for comparative observations, is not suitable for quantitative measurements, and the deductions drawn from the observations are somewhat indefinite. Ebert later designed a portable apparatus for this purpose which has come into general use. A constant current of air is drawn between two concentric cylinders by means of a fan actuated by a falling weight. The inner cylinder is insulated and connected with an electroscope. Knowing the capacity of the apparatus and the velocity of the current of air, the rate of movement of the aluminium leaves of the electroscope affords a definite measure of the number of ions present per c.c. in the air which are drawn into the electrodes. Observations made

in various localities indicate that the number of ions n per c.c. in the open air is on the average from 1000 to 2000. The value of n_+ obtained when the inner cylinder is negatively charged is usually greater than the value n_- when the potential is reversed. The average ratio n_+/n_- is about 1.17. An apparatus for a similar purpose has been devised by Gerdien.

Many of the ions present in the air have about the same mobility as the ions produced in dust-free air by X rays or the rays from active substances. Mache and v. Schweidler* found that the positive ions in air had a velocity 1.02 cms. per second, and the negative ions 1.25 cms. for a potential gradient of one volt per cm. Ions of this type are removed to the electrodes in passing through the apparatus of Ebert. Langevin†, however, observed that a large number of slow moving ions were present in the air which were not removed by the electric field in Ebert's apparatus. A very much stronger field or a much slower current of air is required in order to abstract them from the air. The mobility of these large ions is about 1/3000 cms. per second for one volt per cm.

Measurements of the number of these large ions at different localities have been made by Langevin, Gockel‡, Daunderer§ and Pollock||. The latter found that three types of ions were present in the air, which may for convenience be called small, intermediate, and large. The relative numbers of these three types of ions observed at Sydney are given below.

Type	Number of ions per c.c.	Mobility in cms. per second
Small	0 to 157	about 1.0 to 1.8
Intermediate ...	200 to 1000	about 1/15 to 1/150
Large	600 to 5500	about 1/1280 to 1/3370

From the numbers given it would appear that many of the "intermediate" ions must be normally caught in the apparatus

* Mache and v. Schweidler, *Phys. Zeit.* **6**, p. 71, 1905.

† Langevin, *C. R.* **140**, p. 232, 1905.

‡ Gockel, *Phys. Zeit.* **10**, p. 396, 1909.

§ Daunderer, *Phys. Zeit.* **10**, p. 113, 1909.

|| Pollock, *Science*, June 11, 1909; *Le Radium*, **6**, p. 129, 1909.

of Ebert. Pollock found more negative large ions than positive. This is the reverse to what is observed in Ebert's apparatus.

The conditions existing in the atmosphere are unusually favourable for the formation of complex ions. The number of ions present per c.c. is usually so small that on the average the ions have a comparatively long life before recombination occurs. It would appear that the large ions are due to the ordinary ions acting as nuclei for the formation of minute water drops. The presence of dust and other nuclei in the atmosphere to which the ions attach themselves no doubt is also an important factor in producing large ions. Eve* has investigated the effect of conditions on the ratio of the number of positive to negative ions in the air measured by the apparatus of Ebert. The ratio is very variable, depending on the number and character of the nuclei present in the air. The excess of small positive ions over negative is no doubt to be explained mainly by the greater facility with which the negative ions form large ions which are not caught by the apparatus. Since the upper atmosphere is usually positively charged with regard to the earth, on the average the number of positive ions in the air should be slightly in excess of the negative. The average ratio, 1.17, observed in the apparatus of Ebert, is far larger however than is required to account for this effect. This large excess in the number of positive small ions is no doubt neutralized by the excess in the number of negative large ions. Pollock showed that for the large ions the ratio of the numbers of positive to negative was less than unity.

It is of great importance and interest to test whether the rate of production of ions in the atmosphere near the earth can be explained by the radio-active matter present in the earth and atmosphere. This question has been carefully examined by Eve†. The rate of production of ions is in part due to (1) the radio-active matter suspended in the atmosphere, and (2) to the penetrating rays from the soil. The ionisation due to (1) is mainly caused by the α rays from the emanations of radium and thorium and their products. The calculated rate of production of ions per c.c. due to the known amount of radium emanation in

* Eve, *Phil. Mag.* 19, p. 657, 1910.

† Eve, *Phil. Mag.* 21, p. 26, 1911.

the air is 1·7; that due to thorium probably about 1·0, while that due to the penetrating γ rays from the soil is between 3 and 4 close to the surface of the earth. The average rate of production of ions probably lies between 5 and 6, close to the earth, but should diminish with altitude. If α is the average constant of recombination of the ions in the atmosphere $q = \alpha n^2$ where q is the rate of production and n the equilibrium number per c.c. Taking $\alpha = 3400e$, the value in dust-free air, and $q = 5$, $n = 1800$. This is of the same order as the value of n observed experimentally.

257. Radio-activity of the soil. Elster and Geitel early observed that the air in caves and cellars was in most cases abnormally radio-active. In order to be certain that the emanation did not arise from the stagnant air itself, Elster and Geitel shut up the air in a large boiler for several weeks, but did not observe any increase of the activity or ionisation. It thus seemed probable that the active matter diffused from the soil and gradually collected in quantity in confined spaces. The presence of radium emanation in the soil was proved by placing an open pipe in the earth and sucking the air into a large electroscope by means of a water pump. The air entering the electroscope was found to be markedly active, and gave rise to an active deposit on the walls of the testing vessel. The rate of decay of the active deposit indicated that the radium emanation was mainly responsible for the activity observed.

Similar observations were recorded by Ebert and Ewers* in Munich. They found a strongly active emanation present in the soil, and showed that the rate of decay of this emanation in a sealed vessel was about the same as for the radium emanation. Later Ebert observed that the radio-active emanation could be removed from the air by passing it through a tube surrounded by liquid air. This property of condensation of the radium emanation was independently discovered by Ebert† before he was aware of the direct proof of the condensation of the emanations of thorium and radium by Rutherford and Soddy.

* Ebert and Ewers, *Phys. Zeit.* **4**, p. 162, 1903.

† Ebert, *Ber. d. Bay. Ak. d. Wiss. München.* **33**, p. 133, 1903.

J. J. Thomson found that air bubbled through Cambridge tap-water showed more conductivity than ordinary air. This was ultimately traced to the presence of radium emanation in the tap-water. Adams showed that a trace of radium was present in the tap-water, for after boiling the water to get rid of the emanation, and leaving it for some time in a closed vessel, it was found to yield again about 10 per cent. of the amount of emanation first observed. It was thus obvious that the water contained some radium in solution and an initial excess of the radium emanation.

Bumstead and Wheeler showed that the long period emanation obtained from the surface water and soil of New Haven, Connecticut, was identical with the radium emanation in all respects. Bumstead also observed that a considerable quantity of thorium emanation was present in the atmosphere. Dadourian* examined the underground air and found it contained an easily measurable amount of thorium emanation. For this purpose, a circular hole was cut into the ground. A number of insulated wires were placed in the hole and kept negatively charged by means of an influence machine, and the top of the hole covered over. After a long exposure, the active deposit collected on the wire lost its activity at a rate that showed it to be a mixture of the active deposits of thorium and of radium.

The discovery of the existence of the radium emanation in soil and waters led to systematic measurements of the amount of radium emanation in various hot and mineral springs. A very large number of investigations have been made in recent years on this subject in all parts of the world, and it is not possible to mention even briefly the very large number of papers dealing with this question. Among the earlier investigators in this field were H. S. Allen and Lord Blythswood and Strutt, who examined the hot springs of Bath and Buxton for the radium emanation. Various thermal springs in Germany were tested by Himstedt, Elster and Geitel, Dorn, Schenke and H. Mache, while Curie and Laborde made a systematic examination of the amount of radium emanation in a number of well-known thermal springs in France. Boltwood extended these observations to a number of springs in

* Dadourian, *Amer. Jour. Sci.* **19**, p. 16, 1905.

America. In the great majority of cases, the radium emanation was found to be present, often in considerable quantity, in the issuing waters. In some cases a trace of radium was found in the water, and in the sediment deposited by the spring water.

In this connection, it is of interest to refer to the waters of Salins-Moutiers. Curie and Laborde found that little radium emanation was present, but Blanc* later found that the sediment was very active. A closer examination showed that the activity was due to thorium products, for the sediment emitted freely the thorium emanation and gave rise to the characteristic active deposit of thorium. Blanc later separated from this sediment a very active constituent which we now know to be identical with radiothorium. It would appear that mesothorium was deposited from the water and gave rise to the radiothorium observed.

A number of different methods have been employed to compare the amounts of radium emanation in various waters. In some cases the air is aspirated through the liquid and the ionisation current due to the released emanation is measured by an electroscope. A very satisfactory and definite method of determining the quantity of radium emanation in water was first used by Boltwood. The emanation released from a known quantity of water by vigorous boiling is introduced into an emanation electroscope. The readings of the latter are standardised by observing the effect due to a quantity of emanation released from a radium solution containing a known quantity of radium. In this way the amount of radium emanation in the water is expressed in terms of the quantity of emanation in equilibrium with a known weight of radium.

The radium emanation is always present in matter, whether liquid or gaseous, which escapes from some depth of the earth's crust. For example, Elster and Geitel observed that the carbonic acid obtained from great depths of volcanic soil was radio-active while Burton found that the petroleum from a deep well in Canada contained a considerable quantity of radium emanation. In order to explain the radio-activity of thermal springs it does not appear necessary to suppose that the waters in their passage from the interior pass through rich uranium deposits. The small quantity

* Blanc, *Phil. Mag.* 9, p. 148, 1905.

of radium which is found distributed in the earth's materials (see Section 258) appears sufficient in the aggregate to account for the amount of radium emanation in the great majority of thermal springs. The notable quantity of helium found in the water of many hot springs, for example in those of Bath, is no doubt due to the release of the small quantities of helium formed in the rocks by the disintegration of radio-active matter (see Section 232).

Sanderson* has examined the amount of thorium and radium emanation present in the air contained in the soil in the neighbourhood of New Haven, U.S.A. For this purpose, a constant current of air was drawn through a small iron vessel provided with suitable openings which was buried deep in the soil. The current of air passed through a suitable electroscope in which the activity of the air was examined. Both the radium and thorium emanations were present in considerable quantity. Estimates were made of the amount of free emanation in the underground air. One cubic centimetre was found to contain radium emanation equal to the amount in equilibrium with 2.4×10^{-13} gram radium. It is seen (Section 254) that this is about 4000 times greater than the normal amount of radium emanation per c.c. in the atmosphere. No doubt only a fraction of the radium or thorium emanation formed is released from the radium or thorium salts in the soil, so that this method does not give definite information of the actual amount of radium or of thorium present. The method, however, should prove useful in comparing the amounts of thorium or radium emanation present in soils of different kinds and in different localities, and thus throw light on the amounts of these emanations which escape into the atmosphere.

258. Distribution of radium in the earth's crust. We have seen that the presence of radium and thorium emanations in the atmosphere indicated the widespread existence of radio-active substances in the surface materials of the earth. This was confirmed by the observations of Elster and Geitel of the high content of radium in caverns and confined places, and by the presence of the radium emanation in air sucked from the soil. Since all

* Sanderson, *Amer. Jour. Sci.* **32**, p. 169, 1911.

radio-active substances emit heat in amount proportional to the energy of their radiations, it thus appeared probable that the heating effect of radio-active matter was an important factor in considerations of the maintenance of the internal heat of the earth.

It had been ordinarily assumed that the earth was a cooling body, and from considerations of the temperature gradient observed in the surface of the earth, Lord Kelvin (Appendix D, Thomson and Tait's *Natural Philosophy*) had deduced that not more than 100 million years was required for the earth to cool down from a molten mass to its present state. If, however, heat was constantly supplied by the disintegration of active matter, such calculations no longer rested on a firm basis. On the assumption that one gram of radium emitted 100 calories per gram per hour, the writer* deduced that the presence of 4.6×10^{-14} gram of radium per gram uniformly distributed throughout the volume of the earth would produce as much heat as that lost from the earth by conduction to the surface. In other words, with such a distribution of radium, the temperature gradient of the earth would remain constant.

It was thus of great importance to determine the average radium content of the earth's crust. The first quantitative experiments in this direction were made by Strutt†, who determined the quantity of radium present in a number of representative rocks. For this purpose, the rock was obtained in solution by suitable methods and left in a closed flask for the emanation to accumulate. After a definite interval, the solution was boiled to remove the emanation. The latter was then introduced into an emanation electroscope which had been previously standardized by observing the increased rate of discharge due to the introduction of the emanation released from a known quantity of radium. The results obtained by Strutt for igneous and sedimentary rocks, corrected by Eve‡ for an error in the radium standard, are given below.

* *Radio-activity*, 2nd edition. p. 494.

† Strutt, *Proc. Roy. Soc. A*, **77**, p. 472, 1906; **78**, p. 150, 1907.

‡ Eve, *Phil. Mag.* **14**, p. 231, 1907.

Igneous Rocks.

				Radium in grams per gram
Granite	Rhodesia	4.78×10^{-12}
"	Cornwall	4.67 "
Zircon syenite	Norway	4.65 "
Granite	Cornwall	4.21 "
"	Cape of Good Hope	3.57 "
"	Cornwall	3.45 "
"	Westmorland	3.31 "
Syenite	Norway	2.44 "
Granite	Devon	1.84 "
Blue ground	Kimberley	1.68 "
Leucite basanite	Vesuvius	1.66 "
Hornblende granite	Egypt	1.22 "
Pitchstone	Isle of Eigg	1.03 "
Hornblende diorite	Heidelberg	0.99 "
Augite syenite	Norway	0.93 "
Peridotite	Isle of Rum	0.68 "
Olivine basalt	Skye	0.66 "
Olivine euchrite	Isle of Rum	0.64 "
Basalt	Victoria Falls	0.63 "
Hornblende granite	Leicestershire	0.62 "
Dolerite	Isle of Canna	0.62 "
Greenstone	Cornwall	0.57 "
Basalt	Antrim	0.52 "
Serpentine	Cornwall	0.50 "
Granite	Isle of Rum	0.36 "
Olivine Rock	" "	0.34 "
Dunite	Lock Scaivig	0.33 "
Basalt	Greenland	0.31 "

Sedimentary Rocks.

				Radium in grams per gram
Oolite	Bath	2.92×10^{-12}
"	St Alban's Head	2.02 "
Marble	East Lothian	1.93 "
Kimmeridge clay	Ely	1.88 "
Oil-bearing sandstone	Galiccia	1.52 "
Roofing slate	Wales (?)	1.28 "
Gritty slate	Cornwall	1.25 "
Gault clay	Cambridge	1.06 "
Clay	Essex	0.86 "

Sedimentary Rocks (continued).

				Radium in grams per gram
Red sandstone	...	East Lothian	...	0.84×10^{-12}
Fine gravel	Essex	0.71 „
Red chalk	Hunstanton	0.53 „
Flint	Essex	0.53 „
White marble	India	0.27 „
Marble	East Lothian	0.26 „
Chalk, bottom of pit		Cambridge	0.39 „
„ top of same pit		„	0.12 „

It is seen that the average amount of radium in rocks is about 20 times greater than the amount calculated by Rutherford to be necessary to retain the temperature gradient unaltered. Before considering the interpretation to be placed on these data, it is desirable to consider the results of later experiments on the amount of thorium and radium in rocks and sea-water. The results of Strutt have been confirmed by the experiments of Eve and McIntosh* on the radium content of typical rocks in the neighbourhood of Montreal; by Farr and Florance† on the sub-antarctic rocks, and by Büchner‡ on the rocks of Sumatra and Borneo. Joly has made a systematic examination of the radium content of typical igneous and sedimentary rocks, and found values in general agreement with Strutt, but in many cases obtained a value several times greater than the latter.

An accurate determination of the amount of radium in rocks by the solution method is beset with many difficulties. Apart from the difficulty of obtaining about fifty grams of rock in complete solution, any trace of a precipitate may involve the separation of the minute quantity of radium present. Under such conditions, only a fraction of the emanation formed from the radium is released by boiling. The chemical operations are so long and tedious that only a few rocks can be properly tested.

In order to avoid some of these difficulties, Joly§ has devised

* Eve and McIntosh, *Phil. Mag.* **14**, p. 231, 1907.

† Farr and Florance, *Phil. Mag.* **18**, p. 812, 1909.

‡ Büchner, *Kon. Akad. v. Wet. Amsterdam*, **13**, p. 359, 1910; **13**, p. 818, 1911; **13**, p. 1063, 1912.

§ Joly, *Phil. Mag.* **22**, p. 134, 1911.

a fusion method which is far more rapid and more reliable than the solution method. This method depends on the release of the radium emanation in a rock by heating it with a suitable flux in a closed furnace to a temperature of over 1000°C . The rock after grinding was generally mixed with about four times its weight of the mixed carbonates of sodium and potassium and introduced into a platinum crucible, which was heated electrically in an outer crucible of Berlin porcelain. The liberated radium emanation, mixed with air and other gases, is transferred into an emanation electroscope and its quantity measured. It is assumed that the rocks in the cold do not allow more than a small percentage of the emanation to escape into the air even after grinding. This seems to be borne out in most cases by direct observation.

Locality	Wt. of Rock grms.	Wt. of Carbs. grms.	Result by solution	Result by fusion
Killiney Hill ...	6	24	1.76×10^{-12}	2.9×10^{-12}
Glencullen ...	6	24	1.2 "	1.9 "
Glenmaluce ...	6	24	0.41 "	1.0 "
Ballyellin ...	6	24	2.08 "	2.2 "
Aughrim ...	6	24	1.02 "	1.8 "
Blackstairs Mt.	6	24	2.41 "	3.0 "
Same ...	6	24	2.41 "	3.0 "
		Means	1.48 "	2.13 "

A typical comparison of the results obtained by the two methods on Leinster granite is shown in the table. The solution results were obtained by Fletcher*.

It is seen that the fusion method gives a distinctly higher value in these cases. On the other hand, measurements on the basalt from the Deccan gave by the solution method an average value of 4.3×10^{-13} and by the fusion method 2.2×10^{-12} .

Joly† made an extensive examination of the rocks of the St. Gothard Tunnel both by the fusion and solution methods. The average results of the radium content found by the fusion method is given in the following table. The amount of thorium

* Fletcher, *Phil. Mag.* **21**, p. 102, 1911.

† Joly, *Phil. Mag.* **23**, p. 201, 1912.

in the rocks, the method of estimation of which will be discussed later, is also added.

Rock type	Ra per gram	Th per gram
Granite and gneiss of the Finsteraarhorn Massif	6.0×10^{-12}	2.64×10^{-6}
Altered sediments of the Usernmulde	2.6 "	1.70 "
Schists, etc. of the St. Gothard Massif	2.8 "	1.10 "
Altered sediments of the Tessinmulde	2.0 "	0.44 "

It is seen that there is twice as much radio-active matter in the granite as in the schists of the St. Gothard Massif.

Joly and Fletcher have carefully examined by both methods the radium content of secondary rocks. The following table gives the mean results of various types of sedimentary rocks given by Fletcher*.

Table of Mean Results.

Rock type	Number of expts. on which average is based	Radium in grms. per gram
Coarse detrital sediments	24	1.5×10^{-12}
" " " (Metamorphosed)	9	1.5 "
Fine detrital sediments Argillaceous ...	16	1.3 "
" " " (Schistose)	9	1.1 "
Calcareous sediments	24	0.8 "

It is seen from the results both of Strutt and Fletcher that the radium content of the sedimentary rocks is distinctly lower than for the igneous rocks. Fletcher observed that all types of sedimentary rocks with the exception of the calcareous rocks have nearly the same radium content.

Joly† found that the radium content of lavas from Vesuvius

* Fletcher, *Phil. Mag.* 23, p. 279, 1912.

† Joly, *Phil. Mag.* 18, p. 577, 1909.

was abnormally high, the mean value for lavas ejected since 1631 being 12×10^{-12} gr. Ra per gram.

An examination of the amount of radium in sea-water has been made by Joly and Eve. The amount of radium present per litre of sea-water is so small that accurate measurement is difficult, and the results obtained by these two authors are somewhat conflicting. Eve* found an average of 0.94×10^{-12} gr. per kilogram of sea-water for specimens taken in a voyage across the North Atlantic. Joly† has examined sea-water from a number of localities and concludes that there is a marked variation in the radium content, and on an average finds much higher values than Eve—in some cases more than 20 times. The results of both observers show that the radium content for sea-water is very small compared with the radium content of rocks. It seems clear that the active matter carried down to the sea by denudation must rapidly be deposited in the bed of the ocean. This seems to be borne out by the observations of Joly on the high radium content of the deep sea deposits obtained in the Challenger expedition. The amount of radium was greatest in radiolarian ooze (36.7×10^{-12}) and least in globigerina ooze (7.2×10^{-12}).

259. Distribution of thorium in the earth's crust.

The evolution of the thorium emanation from the soil indicated that thorium was widely distributed in the earth's crust. The first measurements of the thorium contents of typical rocks were made by Blanc‡ and Joly§. The latter has made a systematic examination of the thorium content of igneous and sedimentary rocks. The rock to be tested is obtained in solution and vigorously boiled for some time to expel all traces of radium emanation. The thorium emanation which is released at a constant rate by boiling is carried by a known current of air into an emanation electroscopes, and the increased rate of discharge determined. The readings are standardized by boiling a similar solution containing a known weight of thorium in radio-active equilibrium. We have already given in the last section the

* Eve, *Phil. Mag.* **18**, p. 102, 1909.

† Joly, *Phil. Mag.* **15**, p. 385, 1908; **18**, p. 396, 1909.

‡ Blanc, *Phil. Mag.* **18**, p. 146, 1909.

§ Joly, *Phil. Mag.* **18**, p. 140, 1909.

thorium content of the rocks obtained from the St. Gothard Tunnel. Joly* has shown that the amount of thorium in sedimentary rocks depends on the type of rocks. In calcareous and dolomitic rocks, the amount of thorium is so small that it is hardly measurable. In the arenaceous and argillaceous rocks, the average thorium content is 1.3×10^{-5} gr. per gram and in the calcareous rocks not more than 0.06×10^{-5} gr. per gram. Since the argillaceous rocks form about 80 per cent. of the sedimentaries, the average thorium content of the sedimentary rocks may be taken as 1.16×10^{-5} gr. per gram. Thorium is found to be as widely distributed as radium in the earth's crust. We shall see later that the amount of thorium in rocks is on the average about the same as the amount of uranium, although there appears to be no definite connection between the relative amounts in any given type of rock.

260. Earth's internal heat. We shall now consider the effect of radio-active matter on the maintenance and distribution of the earth's internal heat. It will be taken that on the average each gram of the earth's surface materials contains 2×10^{-12} gram radium and 1.2×10^{-5} gram thorium. The radium itself would soon be transformed, but it is supposed that it is in equilibrium with its parent uranium. Since 3.4×10^{-7} gram of radium is associated with one gram of uranium, the average amount of uranium in one gram of the earth's crust is 0.6×10^{-5} gram. This is about half the average amount of thorium, but the relative amount of these two elements in different rocks is very variable. Joly† and Werner found by direct chemical tests that uranium was present in rocks in about the amount calculated from the radium content.

We have seen (Section 239) that in radio-active equilibrium, one gram of uranium emits heat at a rate 7.7×10^{-5} cal. per hour and one gram of thorium 2.7×10^{-5} cal. per hour. Taking the density of the average rock as 2.7, it follows that the heating effect of the uranium present in one c.c. of rock is 11×10^{-6} cal. per year and of the thorium 8×10^{-6} cal. per year. The total

* Joly, *Phil. Mag.* **20**, pp. 125, 353, 1910.

† Joly, *Phil. Mag.* **16**, p. 190, 1908.

heating effect of the uranium and thorium combined is 1.9×10^{-5} cal. per year per c.c. Consequently if we suppose a quantity of rock of specific heat 0.2 thermally insulated so that none of the heat generated was lost, its temperature would rise at the rate of about 35°C . in one million years.

Consider next the loss of heat from the earth's surface by conduction through the earth's crust. On an average the temperature rises 1°C . for each 32 metres. The temperature gradient T near the surface is consequently $.00031^\circ \text{C}$. per cm. The amount of heat Q lost by conduction per sq. cm. of surface is given by $Q = KT$ where K is the average conductivity, taken as .004, and T is the observed temperature gradient. The quantity of heat conveyed to the surface by conduction per sq. cm. is thus 39 cal. per year. Since the amount of heat generated in each c.c. by thorium and uranium is 1.9×10^{-5} cal. per year, the escape of heat from the surface is equal to that generated by a uniform distribution of radio-active matter extending to a depth of 2×10^6 cms. or 20 kilometres of the earth's crust. Consequently if the crust of the earth is to retain its thermal gradient unchanged, the uniform distribution of radio-active matter cannot extend for a depth of more than 20 kilometres. In this calculation, we have left out of account the decreasing generation of heat due to the gradual transformation of uranium and thorium. Since the time required for half the uranium to be transformed is 5×10^9 years and for half the thorium 1.3×10^{10} years, it is obvious that not much decrease in the generation of heat will be observed over a period of 100 million years.

It is seen that if the radium were uniformly distributed throughout the whole volume of the earth in the same amount as at the surface, the heat generated by radio-active matter is about 200 times greater than the amount lost by conduction. On such a view, the earth as a whole would be getting steadily hotter. As this does not seem likely, we are driven to the suggestion, first put forward by Strutt, that the radio-active matter is mainly confined to a thin surface shell of the earth. In order to retain the present thermal state of the earth unchanged, the depth of this shell if the active matter is uniformly distributed cannot be much more than 20 kilometres.

It is of interest to calculate the temperature at a depth x from the surface of the earth on these assumptions. It is supposed that below a depth D (about 20 kilometres) no radio-active matter is present, and that the inner core is in thermal equilibrium. It is easily shown that when a steady state is reached the temperature θ (the outside of the earth being supposed to be at 0°) at a depth x is given by $\theta = \frac{hx}{K} \left(D - \frac{x}{2} \right)$ where h is the heat generated per unit volume per second and K the conductivity. At the depth D , $\theta = hD^2/2K$. Substituting the value $D = 2 \times 10^6$ cms., $h = 6 \times 10^{-13}$ cal. per c.c. per sec., $K = .004$, the value of the temperature $\theta = 300^\circ$. This maximum temperature seems too small to fit in with the facts, for there is reason to believe that a temperature of about 1300° exists some distance below the surface. It is of interest to consider the distribution of active matter which would give rise to such a maximum temperature consistent with the observed temperature gradient at the surface of the earth.

If the heat lost by conduction balances the heat generated in a shell of thickness D , $Dh = KT$, and as we have seen the maximum temperature $\theta = hD^2/2K = KT^2/2h$ in terms of observed quantities. It is seen from the above formula for θ that the greater the amount of active matter, *i.e.* the greater the value of h , the *smaller* is the maximum temperature inside the earth, consistent with the observed temperature gradient at the surface. This result at first sight seems paradoxical; but it is a necessary consequence of the assumptions that are made. Now there is no reason to believe that the value of h is too large, and from the data at present available it does not seem possible to alter materially the values assumed for K and T . The final temperature θ , however, is increased if the total quantity of active matter is assumed to be the same but instead of being uniformly distributed is supposed to decrease with depth from the surface. For example, if the active matter falls off exponentially with the depth according to the equation $h/h_0 = e^{-\frac{x}{D}}$, where D is the average depth calculated before, it is easily shown that the maximum temperature $\theta = KT^2/h$, or twice the maximum found for a uniform distribution. On the data at present available, it appears

necessary to assume that the amount of radio-active matter decreases with depth if the earth is to retain its present thermal condition. The distribution of active matter throughout the volume of the earth, even though in small amount per unit volume compared with that observed at the surface, would suffice to give a high temperature to the inner core of the earth.

While the distribution of active matter in the earth is undoubtedly a very important factor in the origin and maintenance of the earth's internal heat, it does not supply any definite evidence as to the age of the earth. We have seen, however, that valuable information on this point is given by the amount of helium and of lead in radio-active minerals. The age of the earth obtained by the study of the oldest primary radio-active minerals is distinctly higher than that deduced from direct geological considerations. This question has been very fully discussed by Joly*. An interesting account of the distribution of radio-active matter in the earth's crust and its possible connection with geological changes has been given by Joly in his book *Radio-activity and Geology* (Constable and Co.).

261. Cosmical radio-activity. We have seen that radio-active matter is uniformly distributed throughout the crust of the earth and throughout the atmosphere. Strutt† examined a number of meteorites for the presence of radium. Iron meteorites did not contain a detectable quantity, but a stony meteorite contained about as much radium as the terrestrial rock which it resembled in general composition. If the earth originated from the same material as the sun, it is reasonable to suppose that the sun should contain the known radio-active elements. The large quantity of helium observed in the sun indirectly suggests the existence there of radio-active matter. Recently some very interesting evidence has been obtained of the presence of radium and its emanation in the sun and in the new star, Nova Gemino-rum 2. H. Giebeler‡ observed a number of new lines in the spectrum of the latter which have been ascribed to uranium, radium

* Joly, *Phil. Mag.* **22**, p. 357, 1911.

† Strutt, *Proc. Roy. Soc. A*, **77**, p. 472, 1906.

‡ Giebeler, *Astr. Nachr.* **191**, No. 4582, June, 1912.

and the radium emanation. A definite proof of the existence of radio-active matter in the new star is spectroscopically difficult on account of the displacement of the spectral lines due to the movement of the source. Most of the stronger radium lines appear to be present, although their relative intensity is in some cases very different to that observed in the spark spectrum of radium. The evidence in support of these conclusions has been discussed by Kustner and Kayser*. The latter has suggested a theory in explanation of new stars based on radio-active processes occurring in them. F. W. Dyson† has given evidence which indicates the existence of radium and of radium emanation in the sun's chromosphere. It must be remembered that the possible amount of radium present in the sun must be small—only about three parts in ten million of uranium. On the other hand, radium is easily detected spectroscopically. Further confirmations of these conclusions of the presence of radio-active matter in the sun and stars will be of great interest.

It was suggested by Birkeland‡ in 1896 that the aurora was caused by a type of electric radiation emitted from the sun. Following the discovery of the corpuscular nature of the cathode rays, it was generally supposed that the sun emitted swift β particles which penetrated some distance into our atmosphere and gave rise to the luminosity observed in the aurora. The theoretical question of the orbits of the β particles in the earth's magnetic field has been worked out and discussed in detail by Störmer§. Later Vegard|| suggested that certain peculiarities occasionally observed in the aurora, for example the curtain or drapery forms, received a simple explanation if it were supposed that the sun emitted radiations of the α ray type. We have seen that the α rays of a given velocity have a definite range in air, and this offers an explanation of the abrupt termination of the luminosity observed in the drapery bands of the aurora. The indirect evidence obtained from the study of the aurora

* Kayser, *Astr. Nachr.* **191**, No. 4583, June, 1912.

† Dyson, *Astr. Nachr.* **192**, No. 4589, July, 1912.

‡ Birkeland, *Arch. d. Sci. Geneva*, 1896; *The Norwegian Aurora Polarix Expedition*, 1902-3.

§ Störmer, *Arch. d. Sci. Geneva*, **24**, 1907.

|| Vegard, *Phil. Mag.* **23**, p. 211, 1912.

undoubtedly suggests that the sun emits rays similar in type to the α and β rays. This would suggest the presence of considerable quantities of radio-active matter near the surface of the sun. So far no evidence has been obtained that a penetrating radiation corresponding to the γ rays is emitted from the sun. This, however, does not imply the absence of radio-active matter, for even if the sun were composed of pure radium it would hardly be expected that the γ rays emitted would be detectable at the surface of the earth, since the rays would be almost completely absorbed in passing through the atmosphere, which corresponds to a thickness of 76 cms. of mercury.

From the known data of the absorption of the γ rays by air (Section 98) it can readily be shown that the intensity of γ rays emitted from the sun at the surface of the earth would only be about e^{-50} of the intensity at the confines of the earth's atmosphere.

The origin and duration of the sun's heat has been discussed in detail by Lord Kelvin in Appendix E of Thomson and Tait's *Natural Philosophy*. Kelvin calculated the energy lost in the concentration of the sun from a condition of infinite dispersion, and concluded that it seems "on the whole probable that the sun has not illuminated the earth for 100 million years and almost certain that he has not done so for 500 million years. As for the future we may say, with equal certainty, that inhabitants of the earth cannot continue to enjoy the light and heat essential to their life for many million years longer, unless sources now unknown to us are prepared in the great storehouses of creation."

The discovery of the enormous amount of energy emitted during the transformation of radio-active matter renders it possible that this estimate of the age of the sun's heat may be much increased. In a letter to *Nature* Sir George Darwin* drew attention to this probability, and at the same time pointed out that on Kelvin's hypotheses, his estimate of the duration of the sun's heat was probably much too high. He stated that "The lost energy of the sun, supposed to be a homogeneous sphere of mass M and radius a , is $\frac{3}{8}\mu M^2/a$, where μ is the constant of gravitation. On introducing numerical values for the symbols in this formula, I find the lost energy to be $2.7 \times 10^7 M$ calories,

* Darwin, *Nature*, 68, p. 496, 1903.

where M is expressed in grams. If we adopt Langley's value of the solar constant, this heat suffices to give a supply for 12 million years. Lord Kelvin used Pouillet's value for that constant, but if he had been able to use Langley's, his 100 million would have been reduced to 60 million. The discrepancy between my results of 12 million and his of 60 million is explained by a conjectural augmentation of the lost energy to allow for the concentration of the solar mass towards its central parts."

It appears that the heat emission of the sun cannot be seriously influenced by the presence of known types of radioactive matter, for a simple calculation shows that if the sun consisted entirely of uranium in equilibrium with its products, the generation of heat due to active matter would only be about one-fourth of the total heat lost by radiation. There is, however, another possible factor which should be considered. At the enormous temperature of the sun, it appears possible that a process of transformation may take place in ordinary elements analogous to that observed in the well-known radio-elements. We have seen that the total emission of energy for the complete transformation of one gram of radium is about 3.7×10^9 calories. There is every reason to suppose that a similar amount of energy is resident in the atoms of the ordinary elements. If the atomic energy of the atoms is available, the time during which the sun may continue to emit heat at the present rate may be much longer than the value computed from ordinary dynamical data.

APPENDIX A

COMPARISON OF QUANTITIES OF RADIUM

IN consequence of the extensive use of radium in experimental researches, an account will be given of the methods that have been devised for quantitatively determining the amount of radium present in any preparation. Two general methods have been utilised (1) *the γ ray method*, which is suitable for comparing quantities of radium varying from 1/100 of a milligram to one gram, and (2) *the emanation method* for measuring small quantities of radium of the order of one millionth of a milligram.

The γ ray method. This method of measurement depends on the fact that the radium in a radium salt about one month after its preparation is in equilibrium with its products, and emits γ rays of great penetrating power, the intensity of which is proportional to the amount of radium present. The intensity of the γ radiation from the radium to be tested is compared with that due to a preparation of known radium content used as a standard. I have found the electroscopic method very suitable for such a comparison. The electroscope employed is similar in type to that shown in Fig. 13 but made entirely of lead about 3 mms. thick, and of volume about one litre. The β rays are completely absorbed by the lead and the ionisation inside the electroscope is a measure of the intensity of the γ rays. In such an electroscope, a quantity of about one milligram of radium, placed about 30 cms. away, gives a convenient rate of leak.

A standard radium preparation of known radium content in a thin glass tube is placed some distance from the electroscope and the rate of leak measured. The radium preparation to be compared with the standard, sealed in a similar tube, is placed at exactly the same distance from the electroscope and the rate of leak again observed. For accurate measurements it is essential that the electric field should be strong enough to produce saturation. Under these conditions, the rate of discharge is a measure of the intensity of the radiation. The ionisation in the electroscope is due to the γ rays and the secondary β rays, to which they give rise, and saturation is much more easily obtained than in the case of equal ionisation by the α rays.

The quantity of radium in each preparation is proportional to the rate of movement of the gold-leaf over a definite part of the scale corrected for the natural leak.

If a number of observations are taken, the comparison should be accurate to within one per cent. It is obviously more difficult to compare by this method quantities of radium which differ largely in amount. For example, if the radium standard contains one milligram and the substance to be compared 100 milligrams, the rates of leak observed, corrected for the natural leak, are in the ratio of 1 to 100. In order to ensure that the saturation current is obtained in the electroscope for the larger quantity, it has to be placed so far away from the electroscope that the leak due to the standard 1 milligram at the same distance is small, and comparable with the natural leak. The probable error of measurement in such a case is greater than when the quantity of radium under comparison is not very different from that of the standard. This difficulty may be overcome by employing a graduated series of standards, whose relative values are accurately known. For example, standards of about 1/10, 1 and 10 milligrams are very serviceable. The advantages of this electroscopic method of comparison depend on the fact that the β rays and the soft γ rays are absorbed by the walls of the electroscope, and that the correction for the absorption of the γ rays in the thin tube containing the radium and in the radium salt itself is small, and can, if necessary, easily be estimated by calculation. In addition, the test preparation is placed at such a distance from the electroscope that the errors due to distribution of the radium in the tube are comparatively unimportant. At the same time it is, of course, preferable that the radium should be contained in a tube of as small dimensions as possible.

A balance method for accurately comparing quantities of radium has been devised by Rutherford and Chadwick*. The radium preparation is placed at such a distance from a lead ionisation chamber that the ionisation current in the latter due to the γ rays from the radium is balanced against an equal and opposite ionisation current supplied by a constant source of radiation, *e.g.* uranium oxide in another ionisation chamber. The balance distances are determined for the test preparation and for the radium standard with which it is to be compared. From these distances the quantity of radium in the test preparation can be accurately determined. A small correction is necessary for the absorption of the γ rays by the air. By this method the quantity of radium in a preparation may be determined to about 1 part in 400.

Another reliable method has been used by Mme Curie. The radium is placed on top of a large plate condenser consisting of two sheets of lead. The ionisation current between the lead plates when a large potential difference is applied is balanced by the use of the Quartz piezo-electrique (see Section 45). The relative saturation currents produced by the test and standard preparations afford a definite measure of the quantity of radium present.

* Rutherford and Chadwick, *Proc. Phys. Soc.* **24**, p. 141, 1912.

It will be noted that in these methods of comparing quantities of radium, it is not necessary to open the tube containing the radium. Such a method of estimation is only possible in the case of a radio-active element like radium which emits a very penetrating radiation. It is important that the tube containing the radium preparation should be hermetically sealed for about a month before observations are made. In this way the possible error due to escape of emanation and consequent decrease of the γ radiation is avoided.

It should, however, be pointed out that these methods of comparing quantities of radium are only applicable when the preparation does not contain radio-thorium or meso-thorium. Both of these latter substances give rise to γ rays of about the same penetrating power as those emitted by radium, and their presence can only be detected by further examination of the preparation.

The methods above outlined can be used not only for comparing quantities of radium but also for comparing quantities of radium emanation and of the product radium C. It is often necessary to obtain a measure of the quantity of radium emanation contained in a sealed tube. About four hours after the emanation is introduced, the γ ray effect reaches a maximum, and thereafter remains very nearly proportional to the amount of emanation in the tube. The γ ray effect due to the emanation is then compared with that due to the standard quantity of radium, and expressed in terms of milligrams of radium.

The γ ray activity of the emanation after reaching its maximum decays exponentially with the time with a half value period of 3.85 days. Consequently the amount of emanation present at any time can be calculated from observations made some time after the separation of the emanation. The reason that the γ ray method can be used both for radium and its emanation depends on the fact that the penetrating γ rays arise not from radium itself but from its products radium B and radium C. For reasons discussed in Section 197, the quantity of emanation is about 0.8 per cent. less than that determined by direct comparison of its γ ray effect with that of the radium standard. In a similar way, we can measure by the γ ray method the amount of the product radium C in terms of the amount in equilibrium with the radium standard. In this case, however, it is desirable to pass the rays through a lead screen about 3 cms. thick in order to absorb the less penetrating γ rays from radium B (see Section 197). It may be mentioned here that Hahn has utilised the γ ray method to standardise very active preparations of meso-thorium and radio-thorium. Both of these substances give rise to γ rays of approximately the same penetrating power as those from radium. Consequently the amount of meso-thorium present may conveniently be expressed in terms of the quantity of radium which would give the same γ ray effect.

Emanation method. The accurate determination of minute quantities of radium is often of such importance in radio-active work that it is desirable to give a fairly complete account of the most suitable methods adopted for this purpose. The emanation method depends on the fact

that radium produces a characteristic emanation of a comparatively long period of transformation, which can be completely separated from radium solutions. If a radium solution is contained in a sealed vessel, the emanation present reaches its equilibrium quantity in about one month, and the amount present is then proportional to the content of radium. Since the emanation can be completely expelled from a solution by boiling, the amount Q_t of emanation present at a time t after boiling the solution is given by $Q_t/Q = 1 - e^{-\lambda t}$, where Q is the maximum quantity and $\lambda = .180$ (day)⁻¹; the interval of collection being expressed in days. The amount of emanation in the specimen under examination can be compared directly with the amount of emanation from a standard solution by introducing the emanation mixed with air into a suitable electroscope, or into a suitable testing vessel connected with an electrometer. Under the proper conditions, the saturation currents due to the emanation from the two solutions are proportional to the quantities of radium present. For comparisons of this kind, it is necessary to prepare a standard radium solution. This can be simply done in the following way:—a quantity of radium salt is accurately determined by the γ ray method in terms of the radium standard. Suppose, for example, the radium salt contains one milligram of radium. This radium salt is dissolved in water and hydrochloric acid added to ensure complete solution. By adding distilled water, the volume is then increased to a known amount, say one litre. A definite fraction of this solution, about 1 c.c., determined by weight or by an accurate pipette is removed, and this is again diluted to one litre. Under these conditions one cubic centimetre of the last solution should contain 1/1,000,000 of a milligram of radium. For most experimental purposes, this will serve as a convenient standard radium solution, for it gives a reasonable rate of leak in an emanation electroscope.

This method of solution can obviously be used to obtain a standard solution of any strength desired. In preparing such standard solutions, it is essential to take great precautions that the radium is initially in solution, and that the solutions are thoroughly mixed. In addition, it is necessary to add hydrochloric acid to the solutions to ensure that the radium will remain permanently dissolved. The importance of this procedure is exemplified by the difficulties that arose in the case of the first standard solutions prepared by Rutherford, where no acid was added. Eve* found some years later that a large part of the radium had been precipitated from the solution in a non-emanating form on the surface of the glass vessels. The amount of emanation to be obtained from such solutions was consequently much less than that to be expected from the amount of radium present. The method outlined above for the preparation of standard solutions was used by Boltwood and Rutherford†. These solutions are now over five years old, and some recent determinations have demonstrated that their

* Eve, *Amer. Journ. Sci.* **22**, p. 4, 1906.

† Rutherford and Boltwood, *Amer. Journ. Sci.* **20**, p. 55, 1905; **22**, p. 1, 1906.

strength has not altered during this interval, showing that all the radium still remains in solution.

After introduction into a flask, the radium solution is boiled so as to expel all the emanation present; the containing flask is then sealed before the solution becomes cold. About one month later the emanation approximately reaches its equilibrium amount, and is then removed. For this purpose the end of the tube is opened and air rushes into the partially exhausted vessel so that no emanation can escape. The solution is boiled, and the emanation mixed with air is collected over a surface of boiling water. The emanation is then transferred into a partially exhausted electroscopes. Boltwood has shown experimentally that the radium emanation is completely removed from a solution by rapid boiling for several minutes. It is necessary to collect the emanation over hot water in order to prevent its partial absorption by the water. If the water is nearly at boiling temperature, the absorption is very small (see Section 137). The rate of leak due to the emanation in the electroscopes increases rapidly at first and then more slowly, reaching a maximum at about three hours after the introduction of the emanation. This increase is due to the production by the emanation of its products, radium A, B and C. For accurate work, it is desirable to determine the rate of leak, when this maximum is reached. When the measurements are completed, the electroscopes is completely freed from emanation by aspiration or by exhaustion, and the instrument is again ready for use when the active deposit has decayed.

This emanation method is a very certain and delicate method of determining the quantity of radium in a solution. The emanation from 1/1,000,000 of a milligram of radium gives a comparatively rapid discharge, and with care 1/100 of this quantity can be measured with certainty. In the earlier observations of the amount of radium in solutions, it was usual to aspirate air through the solutions, and to measure the ionisation produced by the released emanation under definite conditions in the electroscopes. Unless the greatest precautions are taken that the conditions of successive experiments are identical, it is difficult to obtain an accurate comparison by the procedure. The method of boiling the solution is undoubtedly far more certain and reliable.

INTERNATIONAL RADIUM STANDARD

A number of magnitudes connected with radium are capable of measurement with considerable accuracy, for example, the rate of emission of α particles, the production of helium, the volume of the emanation, the heating effect, and the total ionisation. The values of all these quantities depend on the purity of the radium standard which is employed. In order to compare the values obtained by different workers, it is thus of great importance that they should be expressed in terms of the same radium standard. In order to meet this purpose, the Congress of Radiology and Electricity held in Brussels in 1910

appointed a Committee to make arrangements for the preparation of an International Radium Standard. In the course of the following year, Mme Curie prepared a standard containing 21.99 milligrams of pure radium chloride sealed up in a thin glass tube. In March 1912 the Committee met in Paris and compared the standard of Mme Curie with similar standards prepared by Hönigschmid from the material in the possession of the Academy of Sciences in Vienna, which had been purified for atomic weight determinations (see page 472). The Vienna standard consisted of three tubes containing 10.11, 31.7, and 40.43 milligrams of radium chloride. In all cases the preparations had been obtained from the uraninite at Joachimsthal, which contains only a small trace of thorium. The relative quantities of radium in the standards prepared in Paris and Vienna were determined by the two balance methods described on p. 658. The comparison showed that the standards agreed within the limits of error of measurement, and certainly within 1 part in 300.

The standard prepared by Mme Curie was accepted as the International Radium Standard, and it was arranged that it should be preserved in the Bureau International des poids et mesures at Sevre near Paris. It was also arranged that one of the Vienna preparations should be preserved as a secondary standard in Vienna.

The Committee have made arrangements for the preparation of duplicate standards for Governments who require them. The cost of the radium used by Mme Curie in the preparation of the International Standard has been generously defrayed by Dr and Mrs G. T. Beilby.

APPENDIX B

THE TRACKS OF IONISING PARTICLES IN GASES

WE have referred in Section 60 to the method devised by C. T. R. Wilson of rendering visible the track of a single α or β particle through air. This depends on the fact mentioned in Section 17 that the positive and negative ions become centres of condensation when a suitable supersaturation of the water vapour is produced by an adiabatic expansion. A more detailed account of the experimental method and the results obtained have been communicated in a recent paper to the Royal Society. (*Proc. Roy. Soc. A*, 87, p. 277, 1912.)

By a timing arrangement, instantaneous photographs were taken of the trails of particles at short intervals after the expansion. These photographs bring out in a striking and concrete way the essential properties of ionising agencies. The method is one of remarkable power, and promises to throw much light on the distribution and nature of the ionisation produced by the radiations. I am indebted to Mr C. T. R. Wilson for the photographs shown in Figs. 1 and 2.

Fig. 1 shows the magnified trails of two α particles expelled from radium. The number of ions produced by the α particle, and consequently the number of drops, is so large that the trail of the α particle is shown by a continuous line and the individual drops are not visible. The trail on the left is seen to show two abrupt bends, the first through about $10\cdot5^\circ$, the second through about 43° . These are undoubtedly due to the "single" scattering of the α particle, the explanation of which has been given in Section 74. There is a well-marked spur at the second bend, which is no doubt due to the ionisation produced by the recoil of an atom in consequence of the collision with the α particle. This velocity of recoil has been calculated in certain cases by the writer*.

Wilson found that the great majority of the α particles showed a characteristic bend or hook near the end of the trail. The chance of a "single" scattering through a large angle increases rapidly with decrease of velocity of the α particle, and would be expected to be most in evidence near the end of the range of the α particle. When

* Rutherford, *Phil. Mag.* 21, p. 669, 1911.

some emanation is present in the expansion chamber, the complete track of the α particle can be obtained. The beginning of the trail is marked by an enlarged head in which the cloud is of greater density than elsewhere. This probably represents the ionisation by recoil of the atom from which the α particle has escaped.

Fig. 2 shows part of the trail of two β particles liberated by the passage of γ rays through the expansion chamber. It is seen that the β particle follows a tortuous path due to scattering by the air, and the individual ions formed in the gas are clearly visible. The density of the ionisation along the path is very variable, and in some cases a cluster of ions is produced showing probably that a β particle of slow speed has been liberated by collision with the atoms. The experiments of Wilson bring out clearly that the ionisation of the gas due to X rays and γ rays, as Bragg first supposed, is due not to the rays themselves but to the β particles which are liberated from the atoms of matter traversed by the rays.

THE COUNTING OF α PARTICLES

The electrical method of counting α particles by means of an electrometer has been described in Section 59. Since the electrometer needle responds slowly to a potential difference applied to it, it is not possible to count accurately by this method when more than ten α particles enter the detecting vessel per minute. With the aid of a string electrometer (see Section 42), which has a short period of vibration and responds rapidly to the potential difference applied, the rapidity of counting is much increased*. If the movements of the quartz fibre of the string electrometer are photographically recorded on a moving film, it is possible to detect with certainty the effect of each individual α particle by the throw of the fibre even when 1000 α particles enter the detecting vessel per minute.

Fig. 3 shows examples of the photographic record of the electrical effect of the α particles for different rates of entrance of the α particles in the detecting vessel. The upper record corresponds to the entrance of 600 α particles per minute into the detecting vessel and the lower record to 900 per minute. The film was moved at the rate of about 150 cms. per minute. A few deflections of twice the normal length are clearly seen. These represent the entrance of two α particles in very quick succession. The entrance of α particles at an interval of 1/100 second is easily distinguished on the record.

* See Geiger and Rutherford, *Phil. Mag.* 24, p. 618, 1912.

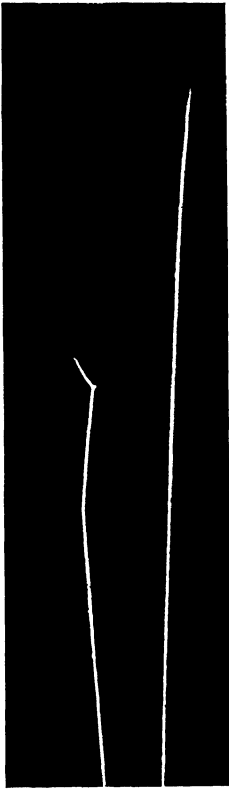

Fig. 1.

Track of α particles

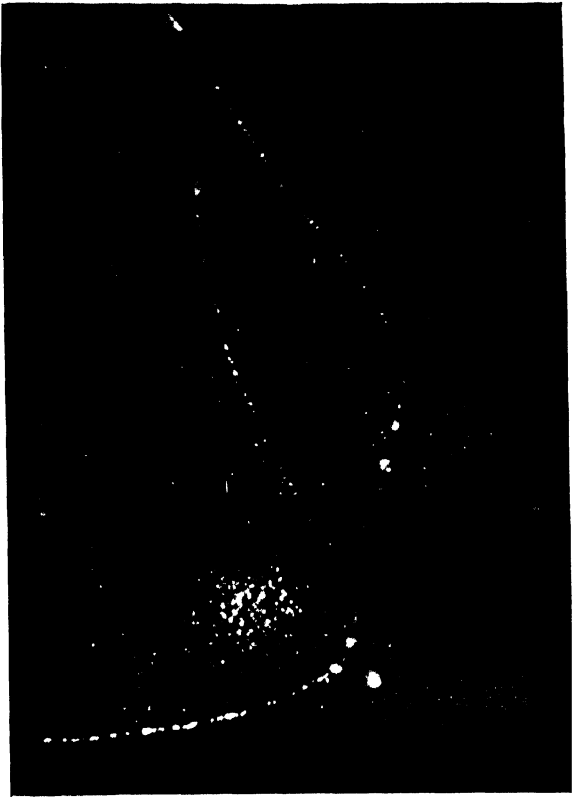

Fig. 2.

Track of β particles

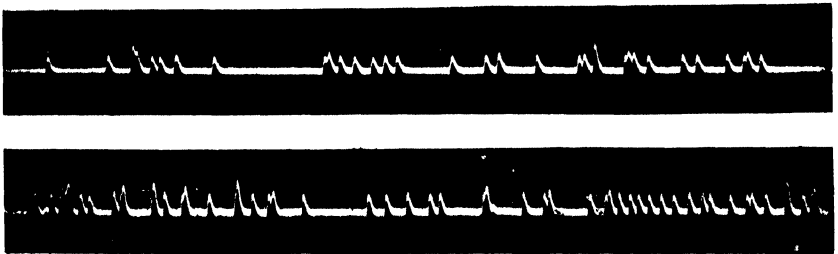

Fig. 3.

Photographic registration of α particles with string electrometer

APPENDIX C

Tables of decay and growth of radium emanation.

$$\lambda = \text{transformation constant of emanation} = \cdot 0075 \text{ (hr)}^{-1} \\ = \cdot 1800 \text{ (day)}^{-1}.$$

$e^{-\lambda t}$ = fraction of emanation remaining after time t .

$1 - e^{-\lambda t}$ = fraction of equilibrium amount of emanation formed in t days.

The value of $e^{-\lambda t}$, for example after 5 days 16 hours, may be obtained by multiplying the value $e^{-\lambda t}$ for $t=5$ days by the value $e^{-\lambda t}$ for $t=16$ hours.

Time t	$e^{-\lambda t}$	$1 - e^{-\lambda t}$	Time t	$e^{-\lambda t}$	$1 - e^{-\lambda t}$
0	1·0000	·0000	8 days	·2369	·7631
1 hr	·9925	·0075	9 "	·1979	·8021
2 "	·9851	·0149	10 "	·1653	·8347
3 "	·9777	·0223	11 "	·1381	·8619
4 "	·9704	·0296	12 "	·1153	·8847
5 "	·9632	·0368	13 "	·0963	·9037
6 "	·9560	·0440	14 "	·0805	·9195
7 "	·9489	·0511	15 "	·0672	·9328
8 "	·9418	·0582	16 "	·0561	·9439
9 "	·9347	·0653	17 "	·0469	·9531
10 "	·9277	·0723	18 "	·0392	·9608
11 "	·9208	·0792	19 "	·0327	·9673
12 "	·9139	·0861	20 "	·0273	·9727
13 "	·9071	·0929	21 "	·0228	·9772
14 "	·9003	·0997	22 "	·0191	·9809
15 "	·8936	·1064	23 "	·0159	·9841
16 "	·8869	·1131	24 "	·0133	·9867
17 "	·8803	·1197	25 "	·0111	·9889
18 "	·8737	·1263	26 "	(2) 928	·9907
19 "	·8672	·1328	27 "	(2) 775	·9923
20 "	·8607	·1393	28 "	(2) 647	·9935
21 "	·8543	·1457	29 "	(2) 541	·9946
22 "	·8479	·1521	30 "	(2) 452	·9955
23 "	·8416	·1584	40 "	(3) 747	·9993
1 day	·8353	·1647	50 "	(3) 123	·9999
2 "	·6977	·3023	60 "	(4) 204	—
3 "	·5827	·4173	70 "	(5) 337	—
4 "	·4868	·5132	80 "	(6) 558	—
5 "	·4066	·5934	90 "	(7) 922	—
6 "	·3396	·6604	100 "	(7) 152	—
7 "	·2837	·7163			

The numbers in brackets, e.g. (6) refer to the number of 0's before the first significant figure.

Exponential Table.

If P = half-value period of substance, and λ = constant of transformation, average life $L = 1/\lambda = 1.443P$. Taking amount of matter present at time 0 as 1, the amount remaining after a time t is $e^{-\lambda t}$ or $e^{-t/L}$.

As an example, suppose it is required to find the fraction of the amount of Ur. X which remains untransformed after 55.4 days. The period is 24.6 days, average life L is 35.5 days, $t/L = 55.4/35.5 = 1.560$. Amount remaining can be deduced by interpolation between given values of exponentials in table for $t/L = 1.5$ and 1.6, or more simply, since $e^{-1.56} = e^{-1.5} \times e^{-0.06}$, by multiplying value for $t/L = 1.5$ by value for $t/L = .06$, *i.e.* amount remaining is $.223 \times .942$ or .223 less 5.8 per cent.

λt or t/L	$e^{-\lambda t}$ or $e^{-t/L}$	λt or t/L	$e^{-\lambda t}$ or $e^{-t/L}$	λt or t/L	$e^{-\lambda t}$ or $e^{-t/L}$
.00	1.0000	1.9	.1496	4.7	(2) 9095
.01	.9900	2.0	.1353	4.8	(2) 8230
.02	.9802	2.1	.1225	4.9	(2) 7447
.03	.9704	2.2	.1108	5.0	(2) 6738
.04	.9608	2.3	.1003	5.1	(2) 6097
.05	.9512	2.4	(1) 9072	5.2	(2) 5517
.06	.9418	2.5	(1) 8208	5.3	(2) 4992
.07	.9324	2.6	(1) 7427	5.4	(2) 4517
.08	.9231	2.7	(1) 6721	5.5	(2) 4087
.09	.9139	2.8	(1) 6081	5.6	(2) 3698
.1	.9048	2.9	(1) 5502	5.7	(2) 3346
.2	.8187	3.0	(1) 4979	5.8	(2) 3028
.3	.7408	3.1	(1) 4505	5.9	(2) 2739
.4	.6703	3.2	(1) 4076	6.0	(2) 2479
.5	.6065	3.3	(1) 3688	7	(3) 9188
.6	.5488	3.4	(1) 3337	8	(3) 3355
.7	.4966	3.5	(1) 3020	9	(3) 1234
.8	.4493	3.6	(1) 2732	10	(4) 4540
.9	.4066	3.7	(1) 2472	11	(4) 1670
1.0	.3679	3.8	(1) 2237	12	(5) 6144
1.1	.3329	3.9	(1) 2024	13	(5) 2260
1.2	.3012	4.0	(1) 1832	14	(6) 8315
1.3	.2725	4.1	(1) 1657	15	(6) 3059
1.4	.2466	4.2	(1) 1500	16	(6) 1125
1.5	.2231	4.3	(1) 1357	17	(7) 4140
1.6	.2019	4.4	(1) 1228	18	(7) 1523
1.7	.1827	4.5	(1) 1111	19	(8) 5603
1.8	.1653	4.6	(1) 1005	20	(8) 2061

The numbers in brackets, *e.g.* (6), refer to the number of 0's before the first significant figure.

Tables of mass of electron.

m_0 = mass of electron at slow speeds.

m = transverse mass of electron at any speed.

v = velocity of electron in cms. per sec.

$mv/e = H \cdot \rho$, where ρ is the radius of curvature of the path of the electron in a field of strength H perpendicular to the direction of projection.

β = ratio of the velocity of the electron to the velocity of light.

e/m_0 is taken as 1.770×10^7 electromagnetic units.

β	m/m_0	mv/e	mv^2/e
.01	1.000	1.695×10	5.085×10^9
.05	1.001	8.483 "	1.272×10^{11}
.10	1.005	1.703×10^2	5.109 "
.20	1.020	3.458 "	2.075×10^{12}
.25	1.033	4.377 "	3.283 "
.30	1.048	5.329 "	4.796 "
.35	1.067	6.330 "	6.646 "
.40	1.091	7.397 "	8.876 "
.45	1.120	8.542 "	1.153×10^{13}
.50	1.155	9.784 "	1.422 "
.55	1.197	1.116×10^3	1.841 "
.60	1.250	1.271 "	2.288 "
.62	1.274	1.339 "	2.490 "
.64	1.301	1.411 "	2.710 "
.66	1.331	1.489 "	2.948 "
.68	1.364	1.572 "	3.207 "
.70	1.400	1.661 "	3.488 "
.72	1.441	1.759 "	3.798 "
.74	1.487	1.865 "	4.140 "
.76	1.538	1.981 "	4.517 "
.78	1.598	2.113 "	4.944 "
.80	1.667	2.260 "	5.424 "
.82	1.747	2.428 "	5.973 "
.84	1.843	2.624 "	6.612 "
.86	1.960	2.857 "	7.371 "
.88	2.105	3.140 "	8.289 "
.90	2.294	3.499 "	9.448 "
.91	2.412	3.720 "	1.016×10^{14}
.92	2.552	3.979 "	1.098 "
.93	2.721	4.289 "	1.197 "
.94	2.931	4.670 "	1.317 "
.95	3.203	5.157 "	1.470 "
.96	3.571	5.810 "	1.673 "
.97	4.113	6.762 "	1.968 "
.98	5.025	8.347 "	2.454 "
.99	7.089	1.190×10^4	3.533 "
.992	7.922	1.332 "	3.964 "
.994	9.142	1.540 "	4.593 "
.996	11.19	2.072 "	6.190 "
.998	15.82	2.676 "	7.995 "

It should be noted that the energy of the electron for velocities comparable with that of light is not given by the value $\frac{1}{2}mv^2$ (see Planck, *Phys. Zeit.* 7, p. 753, 1906).

*Radio-active elements and their constants.**Abbreviations.*

A = atomic weight.

P = time to be half transformed expressed in secs, mins, hours, days or years.

L = average life = $1.443 P$.

$\lambda = 1/L = .6931/P$ = transformation constant expressed in $(\text{sec})^{-1}$, $(\text{min})^{-1}$, etc.

R = range of α rays in air at 760 mms. and 15°C .

μ = absorption coefficient of β rays in terms of cms. of aluminium.

μ_1 = absorption coefficient of γ rays in terms of cms. of lead.

β = velocity of group of β rays in terms of the velocity of light.

The products of each of the three main series are placed in their genetic order. A branch product is suitably indicated.

The latest data for ranges of α rays obtained by Dr Geiger have been added. The numbers given are in some cases different from those given in the main body of the book.

Uranium—Radium Series.

- U { Uranium 1. A 238.5; P 5×10^9 yrs; L 7.2×10^9 yrs; λ 1.4×10^{-10} yrs; α rays, R 2.50.
- U { Uranium 2. A 234.5; P 10^6 yrs?; α rays, R 2.90; non-separable
- ↓ from uranium 1.
- Uranium Y. A 230.5?; P 1.5 dys; L 2.16 dys; λ .46 day; β rays, μ 300; separated from uranium with ferric hydroxide; exists in small quantity, probably branch product.
- ↓
- Uranium X. A 230.5; P 24.6 dys; L 35.5 dys; λ .0282 day; $\beta + \gamma$ rays; β rays continuous spectrum, μ 510, 15; γ rays in small quantity μ_1 .72; soluble in water; separated from uranium with ferric hydroxide and barium sulphate; chemical properties allied to thorium.
- Ionium. A 230.5; P 2×10^5 yrs?; L 3.5×10^5 yrs?; α rays, R 3.00; chemical properties of thorium from which it is non-separable.
- Radium. A 226; P 2000 yrs; L 2880 yrs; λ .000346 yr; $\alpha + \beta$ rays, R 3.30; weak β rays μ 200, two groups β .52, .65; chemical properties analogous to barium.
- Emanation. A 222; P 3.85 dys; 92.4 hrs; L 5.55 dys; λ .1800 day, .0075 hr, 2.083×10^{-6} secs; α rays, R 4.16; inert gas, density 111 H, boiling point -65°C ., critical point 104.5°C ., density solid 5 to 6, condenses at low pressures about -150°C .; diffusion constant in air 0.1; absorption coefficient in water at 14°C . .303; volume from one gram Ra .59 cub. mm.
- Radium A. A 218; P 3.0 mins; L 4.32 mins; λ .231 min.; α rays, R 4.75; behaves as solid, carries positive charge, volatile in H about 400° , in O about 550° .

- Radium B. A 214; P 26·8 mins; L 38·7 mins; λ ·0258 min.; $\beta + \gamma$ rays; β rays, μ 13·1, 80, strongest groups β ·36, ·41, ·63, ·70, ·74; γ rays weak in intensity, μ_1 4 to 6; metal volatile about 400° C. in H; separated in pure state by recoil from radium A, also by volatilisation and by electrochemical methods, precipitated on zinc.
- Radium C. A 214; P 19·5 mins; L 28·1 mins; λ ·0355 min.; $\alpha + \beta + \gamma$ rays; R 6·94; β rays complex μ 13·2, 53, strongest groups β ·786, ·862, ·949, ·957; γ rays, μ_1 ·50; separated from solution of active deposit on nickel plate, volatile in H about 430°, in O about 1000°.
- Radium C₂. A 210?; P 1·4 mins; L 2·0 mins; λ ·495 min.; β rays, μ 13; obtained by recoil from pure radium C, present in small quantity; probably branch product.
- Radium D (Radio-lead). A 210; P 16·5 yrs; L 23·8 yrs; λ ·042 yr; soft β rays, μ 130, groups β ·33, ·39; always separated from uranium minerals with lead, no methods of separation from lead yet known.
- Radium E. A 210; P 5·0 dys; L 7·2 dys; λ ·139 day; $\beta + \gamma$ rays; β rays complex, continuous spectrum, μ 43; γ rays very feeble in intensity and easily absorbed; separated from solution of radium D on nickel and by electrolysis.
- Radium F (Polonium). A 210; P 136 dys; L 196 dys; λ ·00510 day; α rays, R 3·77; separated from mineral with bismuth, deposited from solution on bismuth or copper-plate and separable by electrolysis; probably converted into lead.

Actinium Series.

- Actinium rayless; period unknown; probably branch product at some point of the uranium series; chemical properties allied to lanthanum.
- Radio-actinium. P 19·5 dys; L 28·1 dys; λ ·0355 day; $\alpha + \beta$ rays; R 4·60; weak β rays, μ 140; not precipitated by ammonia and adsorbed by finely divided sulphur.
- Actinium X. P 10·2 dys; L 14·7 dys; λ ·068 day; α rays, R 4·40; chemical properties analogous to radium.
- Emanation. P 3·9 secs; L 5·6 secs; λ ·178 sec.; α rays, R 5·70; inert gas, condenses between -120° and -150°.
- Actinium A. P ·002 sec.; L ·0029 sec.; λ 350 secs; α rays, R 6·50; analogous to radium A.
- Actinium B. P 36 mins; L 52 mins; λ ·0193 min.; soft β rays; analogous to radium B.
- Actinium C. P 2·1 mins; L 3·0 mins; λ ·33 min.; α rays, R 5·40; analogous to radium C.
- Actinium D. P 4·71 mins; L 6·8 mins; λ ·147 min.; $\beta + \gamma$ rays; μ 28·5; γ rays, μ_1 ·217 for aluminium; obtained by recoil from actinium C.

Thorium Series.

- Thorium. A 232; P 1.3×10^{10} yrs; L 1.9×10^{10} yrs; λ 5.3×10^{-11} yrs; α rays, R 2.72.
- Mesothorium 1. A 228; P 5.5 yrs; L 7.9 yrs; λ .126 yr; rayless; chemical properties analogous to radium from which it is non-separable.
- Mesothorium 2. A 228; P 6.2 hrs; L 8.95 hrs; λ .112 hr; $\beta + \gamma$ rays; β rays, μ 20 to 38.5, groups β .37, .39, .43, .50, .57, .60, .66; γ rays penetrating μ_1 .53; separated from mesothorium 1 by precipitating zirconium in solution and by electrolysis.
- Radio-thorium. A 228; P 2.0 yrs; L 2.88 yrs; λ .347 yr; α rays, R 3.87; chemically allied to thorium, non-separable from it.
- Thorium X. A 224; P 3.65 dys; L 5.27 dys; λ .190 day; α rays, R 4.30; analogous in chemical properties to radium.
- Emanation. A 220; P 54 secs; L 78 secs; λ .0128 sec.; α rays, R 5.00; inert gas, condenses at low pressures between -120°C . and -150°C .
- Thorium A. A 216; P .14 sec.; L .20 sec.; λ 4.95 secs; α rays, R 5.70; positively charged and collected on negative electrode.
- Thorium B. A 212; P 10.6 hrs; L 15.3 hrs; λ .0654 hr; β rays, μ 110, groups β .63, .72; analogous in chemical properties to radium B.
- Thorium C. $\left\{ \begin{array}{l} \text{Th. C}_1. \quad A \text{ 212; } P \text{ 60 mins; } L \text{ 84.6 mins; } \lambda \text{ .0118 min.;} \\ \quad \alpha + \beta \text{ rays; } R \text{ 4.80; } \beta \text{ rays } \mu \text{ 15.6; } \gamma \text{ rays weak;} \\ \quad \text{analogous in chemical properties to radium C.} \\ \text{Th. C}_2. \quad A \text{ 212; } P \text{ very short?; } \alpha \text{ rays, } R \text{ 8.60.} \end{array} \right.$
- Thorium D. A 208; P 3.1 mins; L 4.47 mins; λ .224 min.; $\beta + \gamma$ rays; β rays μ 24.8, for thorium C + D μ 18.8, groups for Th. C + D, β .29, .36, .93—95; γ rays μ_1 .46; separated by recoil from thorium C; possibly transformed into bismuth.

INDEX

The numbers refer to the pages

a rays

nature of, 9
difficulty of saturation with, 32
trails of, by condensation method, 49
total ionisation by, in different gases, 65
electroscope for measurement of, 90
use of, for ionisation standards, 111
general properties of, 114 *et seq.*
discovery of, 118
magnetic and electric deflection of, 120
magnetic and electric deflection of homogeneous, 123 *et seq.*
counting of, by electrical methods, 128 *et seq.*
counting of, by scintillations, 133
detection of, by condensation method, 134
charge carried by, 135
chemical nature of, 137
connection of, with helium, 139, 556
retardation of, 141
photographic effect of, from thick layers, 143
absorption of, 146
ionisation curves for pencils of, 148
ionisation due to one *a* particle, 153
ionisation curves for, in different gases, 155
explanation of the ionisation curve for, 156
energy required to produce an ion by, 158
decrease of ionisation with distance for, 159
range of, 161
stopping power of, in different substances, 165
secondary radiations from, 170
delta rays from, 170
recoil radiation from, 170, 174, 401
nature of recoil radiation from, 174

a rays (*cont.*)

ionisation due to recoil atom from, 179
scattering of, 180
theory of scattering of, in thin films, 184
probability variations in emission of, 186
double scintillations from, 191
phosphorescence produced by, 296 *et seq.*
scintillations in zinc sulphide by, 297
effect of continued bombardment of, on zinc sulphide, 300
luminosity in gases produced by, 302
photographic effect of, 305
effect of, in producing halos, 309
distribution of, from thin films, 312
decomposition of water by, 317
possible transformation of matter by, 320
complex nature of, from uranium, 448
decay of active deposit of radium measured by, 487 *et seq.*
complex nature of, from thorium C, 539
connection of, with production of helium, 556 *et seq.*
connection of, with heat emission, 571
heating effect of, 577
change of valency due to expulsion of, 606
relation between range of, and period of transformation, 607
possible origin of, 621
connection of, with aurora, 654
photograph of trails of, 663
photographic record of, 664

Abraham
electrical mass of charged particle, 71

Absorption of *a* rays
by solids and gases, 146
theory of, by matter, 148

- Absorption of β rays**
 exponential law of, 211, 223
 effect of conditions on measurement of, 224
 table of coefficients of, for β rays from different products, 225
 connection of, for β rays with chemical constitution, 226
 from uranium X by elements, 226, 233
 by liquids, 228
 by radio-active matter, 229
 from radium by air, 229
 theories of, 230
 of homogeneous, 234
 variation of, with speed, 238
- Absorption of emanations**
 by liquids, 375
 by solids and charcoal, 378
- Absorption of γ rays**
 from radium, 258
 variation of, with conditions, 261
 connection of, with density, 263
 by gases, 266
 table of, for radio-active products, 267
 variation of, with temperature, 293
- Actinium**
 discovery of, 18 *et seq.*
 emanation from, 19
 connection with emanium, 19, 519
 spectrum of luminosity of, 304
 activity of, in uranium minerals, 447
 history of discovery of, 519
 chemical properties of, 520
 period of, 521
 radiations from, 521
 connection of, with uranium series, 521
 origin of, as branch product, 522
 analysis of active deposit of, 523
 series of transformations of, 533
 relation between range of α rays and period of transformation for products of, 607
- Actinium A**
 discovery and properties of, 396, 523
- Actinium B**
 period and properties of, 524
 volatilisation of, 526
 radiations from, 532
 electro-chemical properties of, 603
- Actinium C**
 separation and properties of, 525
 period of, 526
 volatilisation of, 526
 possible complexity of, 532
 electro-chemical properties of, 603
- Actinium D**
 separation and properties of, 527
 volatility of, 527
- Actinium D (cont.)**
 radiations from, 532
 electro-chemical properties of, 603
- Actinium emanation**
 rapid emission of, 19
 decay of, 351
 effect of conditions on escape of, 359
 temperature of condensation of, 371
 absorption of, by liquids, 377
 absorption of, by charcoal, 380
 diffusion of, 387
 number of α particles expelled by, 395
 transformation of, 524
- Adams**
 range of α particles in gases, 166
 presence of radium emanation in tap-water, 641
- Adams and Eve**
 effect of pressure on γ ray activity of radium, 505
- Age**
 of radio-active minerals, 562, 598
 of geological strata, 566
 of earth, 644, 653
 of sun, 655
- Allen (S. J.)**
 compensation method of measurement, 103
 absorption of β rays by liquids, 228
 velocity of β rays excited by γ rays, 274
 thorium emanation in atmosphere, 626
 activity of snow, 627
- Allen (S. J.) and Rutherford**
 active matter in the atmosphere, 625
- Allen (H. S.) and Blythswood (Lord)**
 radium emanation in hot springs, 641
- Angerer**
 on the energy of β rays excited by X rays, 288
- Angström**
 heating effect of radium, 570
- Antonoff**
 properties of uranium Y, 454
 period of radium D, 513
 period of radium E, 514
- Armstrong and Lowry**
 theory of radio-activity, 413
- Aeschkinass**
 charge carried by α rays, 156
- Ashman**
 amount of radium emanation in atmosphere, 633
- Atmosphere**
 discovery of active matter in, 624
 theory of collection of active matter in, 627
 effect of meteorological conditions on active matter in, 629

Atmosphere (*cont.*)

distribution of active matter in, 630
 amount of radium emanation in, 633
 origin of penetrating radiation in, 634
 ionisation of, 637
 absorption of γ rays from sun in, 655

Atoms

number of, in one gram of H, 140
 constitution of, 617
 structure of, to explain scattering, 619
 Saturnian type of, 620
 structure and mode of disintegration of, 620

Aurora

radio-active origin of, 654

Autunite

luminosity of, 302

 β rays

nature of, 9
 general properties of, 114 *et seq.*
 discovery of, 193
 magnetic deflection of, by photographic method, 194
 complexity of, 196
 magnetic deflection of, by electric method, 197
 charge carried by, 198
 determination of e/m and variation with speed for, 204
 passage of, through matter, 209
 scattered or reflected, 212
 scattering of transmitted, 218
 scattering of, by thin sheets of matter, 219
 absorption of, 223
 connection of absorption of, with chemical constitution, 226
 absorption of, by air, 229
 total ionisation produced by, 230, 579
 theories of absorption of, 230
 absorption of homogeneous, 234
 variation of absorption of, with speed, 238
 retardation of, in traversing matter, 240
 variation of ionisation with velocity of, 245
 distribution of velocity of, in radium, 250
 emission of homogeneous groups of, 252
 connection of γ rays with, 270
 excited by γ rays, 271
 incidence and emergence β rays excited by γ rays, 273
 variation of amount of, excited with material, 274, 278
 production of γ rays by, 282
 origin of energy of, from γ rays, 288

 β rays (*cont.*)

phosphorescence produced by, 296 *et seq.*

decay of luminosity produced by, 301

photographic effect of, 305

distribution of, from uranium, 313

decomposition of water by, 319

decay of active deposit of radium measured by, 493

variation of distribution of, with temperature, 504

heating effect of, from radium, 578

origin of, in transformations, 610

relation between groups of, from radium, 613

transformation of energy of, into γ rays, 613

connection of, with aurora, 654

photographs of trails of, 664

v. Baeyer

retardation of β rays, 244

v. Baeyer, Hahn and Meitner

homogeneous groups of β rays, 212, 252

velocity of β rays from radium, 474

Balance methods

of measuring ionisation currents, 103

of comparing quantities of radium, 658

Barium platinocyanide

luminosity of, 298, 299

Barkla

characteristic Röntgen rays, 85, 291
 absorption of characteristic radiations, 611

Barnes and Rutherford

heating effect of radium and its products, 572

heating effect of α , β and γ rays, 578

Barratt

ranges of α particles from thorium emanation, 164, 535

Barratt and Marsden

probability distribution of α particles, 190

absence of doubles in scintillations from uranium, 448

analysis of a radiations from thorium C, 539

Bary

phosphorescence produced by radium rays, 297

Baskerville and Kunz

phosphorescence produced by radium rays, 299

Bateman

theory of successive changes, 418, 422

- Bateman, Geiger and Rutherford**
probability variations of α particles, 188
- Beattie, R.**
theory of electrometer, 97
- Beattie, Kelvin (Lord) and Smolan**
discharging action of uranium rays, 9
- Becker**
conductivity of dielectrics under radium rays, 326
- Becquerel, H.**
discovery of photographic effect of uranium, 7
phosphorescence of uranium salts, 7
discharging action of uranium, 8
reflection, refraction, and polarisation of uranium rays, 9
radiations, types of, from uranium, 9
magnetic deflection of α rays, 122
curvature of α rays in magnetic field, 144
magnetic deflection of β rays, 193
complexity of β rays from radium, 196
deflection of β rays in electric field, 204
discovery of γ rays, 257
phosphorescence produced by radium rays, 296
luminosity of crystals of uranium nitrate, 302
action of radium rays on phosphorus, 315
conductivity of dielectrics under radium rays, 326
separation of uranium X, 331, 454
structure of the atom, 410
- Beilby**
phosphorescence produced by β and γ rays, 299
- Bemont (G.), M. and Mme Curie**
discovery of radium, 15
- Bergwitz**
decomposition of water by polonium, 318
- Berry**
separation of uranium X by barium, 454
- Berthelot**
effect of radium rays on quartz, 308
- Beryl**
origin of helium in, 565
- Bestelmeyer**
determination of e/m for cathode rays, 208
- Bialobjesky**
conductivity of hydrocarbons under radium rays, 326
- Birkeland**
theory of aurora, 654
- Bismuth**
separation of polonium with, 20
deposit of polonium on, 21
possible end product of thorium, 599
- Blanc**
thorium emanation in atmosphere, 626
active sediment containing thorium products, 642
amount of thorium in rocks, 649
- Blanquies (Mdlle)**
complex nature of actinium C, 532
- Blythwood (Lord) and Allen (H. S.)**
radium emanation in hot springs, 641
- Bohm-Wendt and v. Schweidler**
conductivity of oils under radium rays, 326
- Boiling point**
of radium emanation, 483
- Boltwood**
discovery of ionium, 21, 456
range of α particles from ionium, 162
activity of uranium minerals, 446
relative proportion of uranium and ionium, 457
activity of ionium, 458
life of radium, 459
constancy of radium-uranium ratio in minerals, 460
production of radium by uranium, 465
properties of actinium, 520
activity of actinium in uranium minerals, 521
activity of thorium minerals, 546
separation of meso-thorium, 547
amount of helium in minerals, 564
lead as end product of radium, 597
amount of lead in uranium minerals, 597
radium emanation in thermal springs, 641
method of measurement of amount of radium emanation in water, 642
estimation of small quantities of radium, 660
- Boltwood and Rutherford**
amount of radium in uranium minerals, 16, 462
action of emanation on paraffin, 315
rate of production of helium by radium, 557
production of helium by polonium and ionium, 560
- Boyle**
effect of surface condensation of emanations, 373
vapour pressure of radium emanation, 374

- Boyle (*cont.*)
 absorption of radium emanation by liquids, 376
 absorption of thorium emanation by charcoal, 379
- Bragg
 total ionisation by α particles in different gases, 64
 corpuscular theory of X rays, 84
 emission of α rays, 123
 curvature of α rays in magnetic field, 144
 theory of absorption of α rays, 147
 determination of range of α rays from uranium and thorium, 162
 stopping power of combination of two plates, 168
 on the range of β particles, 230
 incidence and emergence β radiation, 275
 variation of γ ray ionisation with material of electroscope, 278
 corpuscular theory of γ rays, 289
 origin of ionisation by X rays, 293
- Bragg and Cooke
 ionisation curve for α rays in different gases, 167
- Bragg and Kleeman
 difficulty of saturation with α rays, 33
 absorption of α rays, 147
 measurement of ranges of α particle in different substances, 165
- Bragg and Madsen
 variation of emergence β radiation with atomic weight, 275
- Bronson
 construction of radio-active resistance, 102
 decay of thorium emanation, 351
 number of α particles from emanations, 395, 539
 effect of temperature on decay of active deposit of radium, 488
 decay of α ray activity of active deposit of radium, 490
 effect of temperature on decay of products of radium, 503
 period of actinium B, 525
 analysis of active deposit of actinium, 525
- Bronson and Wellisch
 charge on active deposit, 399
- Brooks (Miss)
 apparent volatilisation of radium B, 175
 decay of active deposit of radium, 492
 analysis of active deposit of actinium, 525
 separation of actinium C by electrolysis, 526
- Brooks (Miss) and Rutherford
 absorption of α rays, 146
 diffusion of radium emanation, 383
 decay of active deposit of radium, 487
 active deposit of thorium, 536
- Bucherer
 variation of mass of electron with speed, 71, 207
- Büchner
 activity of potassium, 588
 amount of radium in rocks, 646
- Bumstead
 emission of delta rays, 173
 energy of β rays excited by X rays, 288
 radium and thorium emanation in atmosphere, 626, 641
- Bumstead and Wheeler
 decay of radium emanation, 352
 diffusion of radium emanation, 385
- Burton
 presence of radium emanation in petroleum, 642
- Burton and McLennan
 radio-activity of ordinary materials, 593
 penetrating γ rays in atmosphere, 594, 634
- Callendar
 method of measuring small heating effects, 585
- Cameron and Ramsay
 decomposition of gases by α rays, 316
 rate of decomposition of water by radium, 318
 transformation of matter by α rays, 320
 volume of radium emanation, 480
 spectrum of radium emanation, 482
- Campbell (N. R.)
 activity of rubidium and potassium, 12
 construction of high resistances, 102
 velocity of expulsion of delta rays, 171
 explanation of emission of delta rays, 173
 comparison of emergent and incident delta radiation, 174
 theory of probability variations of α particles, 188
 absorption of β rays by liquids, 228
 discontinuous nature of γ rays, 291
 absorption of β rays from potassium, 588
 activity of potassium as atomic property, 588

- Campbell (N. R.)** (*cont.*)
 activity of rubidium, 589
 radio-activity of ordinary matter, 593
- Campbell and Wood**
 activity of potassium salts, 587
 diurnal variation of ionisation in closed vessels, 635
- Canal rays**
 properties of, 81 *et seq.*
- Cathode ray**
 discovery and properties of, 76 *et seq.*
- Cermak and Schmidt (H. W.)**
 effect of temperature on decay of products of radium, 503
- Chadwick**
 absorption of γ rays by gases, 265
 production of γ rays by β rays, 282
- Chadwick and Rutherford**
 γ ray activity of emanation, 498
 balance method of comparing radium standards, 658
- Changes**
 (*see* Transformations)
- Characteristic radiations**
 of elements, 85, 611
- Charge**
 carried by an ion, 50 *et seq.*
 value of, used for calculation, 53
 carried by α particle, 135
 carried by β rays, 198
 carried by β rays from radium B and C, 202 *et seq.*
 nature and origin of, carried by active deposit, 399
- Chaumont**
 diffusion of radium emanation, 384
- Chemical action**
 produced by α , β and γ rays, 314 *et seq.*
 produced on water by α , β and γ rays, 317
 amount of, in water, 319
- Chemistry**
 of radio-active bodies, 600 *et seq.*
- Chevèneau and P. Curie**
 magnetic properties of radium, 474
- Child**
 potential gradient, 67
 variation of current with voltage for surface ionisation, 67
- Classen**
 determination of e/m for cathode rays, 208
- Clock**
 radium, 199
- Clouds**
 formation of, by condensation of water round ions, 46 *et seq.*
- Collie and Ramsay**
 spectrum of radium emanation, 482
- Collision**
 ionisation by, 36 *et seq.*
 detection of a particle by ionisation due to, 129
- Colouration**
 of bodies by radium rays, 307
 of glass, 307, 311
 theory of, 309
 of mica plates, 309
 of bunsen flame by radium, 471
- Concentration**
 decay of radium emanation independent of, 355
 of active deposit on the cathode, 398
- Condensation**
 of water on ions, 46 *et seq.*
 of emanations, 366
 temperature of, for emanations, 366
- Condensers**
 use of, in measurements of currents, 108
 construction of, with small capacity, 110
- Conductivity**
 of gases produced by α , β and γ rays, 62 *et seq.*
 of radium solutions, 323
 of dielectrics under radium rays, 324
- Constants**
 values of atomic and radio-active, 140
 meaning of radio-active, 341
- Contamination**
 by radio-active substances, 112
- Cooke**
 natural ionisation in electroscope, 594
 presence of γ rays from earth, 594, 635
- Cooke and Rutherford**
 penetrating radiation from the earth, 594, 635
- Cosmical radio-activity**
 discussion of, 653
- Counting of a particles**
 by electric method, 128
 by scintillation method, 133
 by cloud method, 134
 by photographic method, 306
 by string electrometer, 664
- Crookes (Sir William)**
 cathode rays, 76
 nature of α rays, 119
 scintillations due to α rays in zinc sulphide, 133
 change of colour in diamond due to radiations, 299
 discovery of uranium X, 330
 origin of heat energy of radium, 412
- Crookes and Dewar**
 spectrum of phosphorescent light of radium, 303

- Crowther**
 scattering of β rays from uranium, 218
 scattering of β rays by thin screens, 219
 initial drop in absorption curve for β rays, 224
 absorption of β rays from uranium X by elements, 227
 connection of scattering with chemical constitution, 227
 absorption of homogeneous β rays, 236
- Crystallization**
 effect of β rays on, 317
 effect of, on activity of uranium, 453
- Curie**
 definition of, 479
- Curie (P.)**
 magnetic deflection of β rays, 193
 conductivity of liquids under radium rays, 324
 decay of radium emanation, 352
 effect of temperature on decay of emanation, 355
 distribution of active deposit, 392
 nature of the emanation, 411
- Curie (Mme)**
 discovery of activity of thorium, 10
 activity of minerals, 13
 activity of uranium compounds, 13
 radio-activity an atomic property, 14
 nature of α rays, 119
 photographic record of α particles, 133
 absorption of α rays from polonium, 147
 action of radium on platinum, 315
 decay of radium emanation, 353
 effect of gravity on active deposit, 406
 atomic weight of radium, 471
 period of polonium, 515
 decay of actinium, 521
- Curie (M. and Mme)**
 separation and purification of radium, 14 *et seq.*
 discovery of polonium, 20
 concentration of polonium, 20, 21
 charge carried by β rays, 199
 changes of colour in radium salts, 302
 colouration by radium rays, 307
 production of ozone by α rays, 314
 effect of radium rays on spark, 322
 discovery of induced activity, 391
 theories of radio-activity, 412
- Curie (J. and P.)**
 construction of quartz piezo-electric, 104
- Curie (P.) and Chevreneau**
 magnetic properties of radium, 474
- Curie (Mme) and Debierne**
 decomposition of water by the emanation, 317
 decomposition of water by polonium, 318
 metallic radium, 473
 isolation of polonium, 517
 production of helium by polonium, 560
- Curie (Mme) and Gleditsch (Mdle)**
 transformation of copper into lithium, 321
- Curie (P.) and Danne**
 absorption of emanations by solids, 378
 distribution of radium emanation with temperature, 382
 diffusion of radium emanation, 383
 decay of active deposit of radium, 487, 492
 effect of temperature on decay of active deposit of radium, 488
- Curie (P.) and Dewar**
 production of helium by radium, 556
 heating effect of radium at low temperatures, 569
- Curie (P.) and Laborde**
 origin of heat energy, 412
 heating effect of radium, 568
 radium emanation in thermal springs, 641
- Dadorian**
 activity of thorium minerals, 546
 thorium emanation from the soil, 641
- Danne**
 radio-uranium, 455
 absence of uranium in pyromorphite, 463
- Danne and Curie (P.)**
see Curie and Danne
- Danzysz**
 groups of β rays from radium, 254
- Darwin (Sir George)**
 duration of sun's heat, 655
- Darwin (C.) and Marsden**
 complexity of thorium C, 540
- Dauderer**
 large ions in the atmosphere, 638
- Davison**
 production of γ rays by β rays, 282
- Debierne**
 discovery of actinium, 19, 519
 decay of actinium emanation, 351
 distribution of active deposit, 405
 volume of radium emanation, 480
 rate of production of helium by radium, 557
 production of helium by actinium, 559

- Debiere and Mme Curie
see Curie and Debiere
- Decay
 radio-active, meaning of, 340
 effect of conditions on, 342
- Deflection of ions
 in magnetic field, 72
 in electric field, 75 *et seq.*
- Delta rays
 170 *et seq.*
 discovery and nature of, 170
 number produced by one α particle, 173
 emission of, in direction of α particle, 174
 set free by β rays, 204
- Demarcay
 spectrum of radium, 471
- Density
 of radium emanation, 481
- Deposit active
 distribution of radiations from, 312
 discovery of, 391
 connection of, with the emanations, 392
 production and decay of, 393
 of very rapid rate of decay, 395
 concentration of, on the cathode, 398
 distribution of, in electric field, 400
 effect of pressure on distribution of, 401
 range of recoil atoms from, 403
 effect of gravity on distribution of, 405
 velocity of carriers of, in electric field, 407
 physical and chemical properties of, 408
 collection of, in atmosphere, 624
 theory of collection of, 627
 effect of meteorological conditions on amount of, 629
 distribution of, over land and sea, 630
- Deposit active of actinium
 decay of, 394
 products of quick decay in, 395
 distribution of, in electric field, 399
 range of recoil atoms forming, 404
 analysis of, 523
 rise and decay curves of, 524
 radiations from, 531
- Deposit active of radium
 discovery of, 391
 distribution of, 392
 decay of, 393
 distribution of, in electric field, 399
 distribution of, at low pressures, 401
 effect of gravity on distribution of, 405
 physical and chemical properties of, 408
- Deposit active of radium (*cont.*)
 deduction of activity curves of, for short and long exposures, 437, 439
 analysis of, 486 *et seq.*
 rise and decay curves of, by α , β and γ rays, 490 *et seq.*
 total ionisation due to, 502
 effect of temperature on, 502
 volatility of, 505
 heating effect of, 574
 distribution of heating effect amongst products of, 580
 presence of, in atmosphere, 625
 distribution of, over land and sea, 630
- Deposit active of radium of slow transformation
 analysis of, 507 *et seq.*
 variation of activity of measured, by α , β rays, 508
- Deposit active of thorium
 discovery of, 391
 production and decay of, 393
 product of quick decay, 395
 distribution of, in electric field, 398
 distribution of, with pressure, 401
 velocity of carriers of, 407
 physical and chemical properties of, 408
 deduction of rise curves of, for short and long exposures, 433
 analysis of, 534 *et seq.*
 volatility of, 537
 mode of transformation of, 541
 presence of, in atmosphere, 626
 distribution of, over land and sea, 630
- Des Coudres
 value of e/m of α particle, 122
- Dewar (Sir James)
 rate of production of helium by radium, 557
- Dewar and Crookes
 spectrum of luminosity of radium, 303
- Dewar and Curie (P.)
see Curie (P.) and Dewar
- Diamond
 scintillations in, 299
 changes of colour in, 299
- Dielectrics
 effect of radium rays on resistance of, 324
- Diffusion
 of ions in gases, 53 *et seq.*
 general theory of, 380
 methods of measuring, 383
 of radium emanation, 383
 of emanations through porous materials, 385
 of emanations through small opening, 386

- Diffusion (*cont.*)
of thorium and actinium emanations, 387
variation of, with pressure, 388
of emanation into liquids, 390
- Disintegration (*see* Transformation)
- Dissociation
of molecules during ionisation, 58
of gases by radiations, 316
of water by radiations, 317
- Distribution
of α particles according to probability, 186
of β rays from radium with velocity, 250 *et seq.*
of α rays from thin films, 312
of β rays from uranium, 313
- Doelter
colouration by radium rays, 309
- Dorn
bursting of radium tubes, 200
deflection of β rays in electric field, 204
discovery of radium emanation, 350
radium emanation in thermal springs, 641
- Doublet
theory of γ rays, 289
- Dreyer and Salomonsen
effect of radium rays on quartz, 308
- Duane
photographic record of α particles, 133
number of delta particles emitted for each α particle, 173
total ionisation due to one curie of emanation, 502
volatilisation of radium A and B, 505
apparatus for measuring small heating effects, 585
heating effect of polonium, 586
heating effect of radium mixed with phosphorescent materials, 586
- Duane and Laborde
total ionisation due to one curie of emanation, 502
- Durack
ionisation per unit path by cathode and β rays, 245
- Dyson
radium in the sun, 654
- Earth
distribution of radium in, 643
heat of, 644
origin of internal heat of, 650
- Ebert
apparatus for measuring ionisation in atmosphere, 637
condensation of radium emanation from air, 640
- Ebert and Ewers
presence of radium emanation in soil, 640
- Ebler
attempts to separate metallic radium, 473
- Effusion
determination of molecular weight of radium emanation by, 386
- Einstein
variation of mass of electron with speed, 71
- Electro-chemical
methods of separation of products, 600, 603
- Electrolysis
of active deposits, 409
separation of products by, 600, 603
- Electrometers
use of, in radio-activity, 97 *et seq.*
practical details in use of, 98 *et seq.*
string, 100
capacity of, and measurement of capacity of, 109 *et seq.*
- Electron
velocity gained by, between collisions, 38
radius of, 72
effect of magnetic and electric field on, 72 *et seq.*
origin of name of, 79
mass of, and variation with speed, 204
number of, in atoms, 618, 621
tables of mass and energy of, for different speeds, 667
- Electroscopes
description of, 90 *et seq.*
practical points in construction of, 94
for β and γ rays, 94
tilted, 95
with quartz fibres, 96
- Elster and Geitel
experiments on radio-lead, 21
string electrometer, 101
scintillations in zinc sulphide, 133
magnetic deflection of β rays, 193
photo-electric action, 309
effect of radium rays on spark, 322
period of actinium B, 525
amount of radium in potassium salts, 589
presence of polonium in lead, 595
presence of active matter in atmosphere, 624
effect of meteorological conditions on collection of active deposit from atmosphere, 629

- Elster and Geitel (cont.)**
 activity of air in caves and cellars, 640
 radium emanation in thermal springs, 641
- Emanations**
 from thorium, 10
 from radium used as a source of radiation, 18
 of short life from actinium, 19
 discovery of, 348
 decay of, 350
 decay of radium, 351
 radiations from, 356
 effect of conditions on escape of, 358
 effect of conditions on escape of, from radium, 361
 condensation of, 364
 temperature of condensation of, 366
 absorption of, by liquids, 375
 absorption of, by solids and charcoal, 378
 diffusion of, 380
 methods of measuring diffusion of, 382
 effusion of, 386
 diffusion of thorium and actinium, 387
 diffusion of, into liquids, 390
 connection of, with active deposits, 392
 number of a particles emitted by, 395
 products of quick decay in, 395
 correction for measurement of amount of, by γ rays, 430
 methods of measuring quantities of radium by, 659
- Emanation of actinium (see actinium emanation)**
Emanation of radium (see radium emanation)
Emanation of thorium (see thorium emanation)
- Energy**
 electro-magnetic, of moving ion, 70
 required to produce an ion, 158
 of a particles, 164
 emitted by radium, 568 *et seq.*
 of β and γ rays from radium, 578
 origin and amount of, in transformations, 581
 division of, between β and γ rays, 614
 table of variation of mass of electron with speed, 667
- Engler**
 effect of temperature on decay of products of radium, 503
- Equilibria**
 secular and transient, 429
- Erikson**
 effect of temperature on recombination, 41
- Evans and Makower**
 velocity and mass of recoil atoms, 177
- Eve**
 conductivity of gases for penetrating X rays, 64
 effect of electric field on range of a particle, 165
 scattering of β rays, 213
 absorption of β rays by air, 229
 ionisation of β rays per unit path, 246
 absorption of γ rays, 259
 absorption of γ rays from thorium, 267
 β rays excited by γ rays, 272
 β rays excited by γ rays in different materials, 273
 variation of emergence β radiation with atomic weight, 275
 variation of γ ray ionisation with material of electroscopie, 278
 scattered γ rays, 279
 conductivity of gases for X rays and γ rays, 286
 total ionisation produced by γ rays, 294
 absorption of radium emanation by charcoal, 380
 γ rays from commercial preparation of thorium, 546
 relative energies of α , β and γ rays, 579
 distance of collection of active deposit in atmosphere, 629
 amount of active deposit in air over the sea, 632
 amount of radium emanation in atmosphere, 633
 decrease of intensity of γ rays with height of atmosphere, 636
 origin of excess of positive ions in atmosphere, 639
 amount of ionisation due to active matter in atmosphere, 639
 amount of radium in sea water, 649
- Eve and Adams**
 effect of pressure on γ ray activity of radium, 505
- Eve and McIntosh**
 amount of radium in rocks, 646
- Ewers**
 velocity of expulsion of delta rays, 171
- Ewers and Ebert**
 presence of radium emanation in soil, 640

- Eye
 luminosity produced in, by radium rays, 328
- Fajans
 complex nature of radium C, 500
 recoil of radium D from radium C, 511
- Fajans and Makower
 β rays from radium B, 488
 effect of β rays from radium B on rise curves, 494
 rise curves of radium C from radium B, 501
- Fajans and Moseley
 decay of thorium A and actinium A, 397
 complex nature of actinium C, 532
 period of thorium A, 535
- Farr and Florance
 amount of radium in rocks, 646
- Fehrle
 distribution of active deposit in electric field, 407
- Flemming
 activity of atmosphere at high altitudes, 630
- Fletcher
 amount of radium in granites, 647
 amount of radium in sedimentary rocks, 648
- Florance
 variation of absorption of γ rays with arrangement, 263
 scattered γ radiation, 279
 variation of scattering of γ rays with material and angle, 281
- Florance and Farr
 amount of radium in rocks, 646
- Foch
 range of α particles from uranium, 448
- Franck
 mobility of heavy ions, 57
 mobility of recoil atoms, 407
- Franck and Pohl
 mobility of ions in helium, 45
- Friedmann
 range of α particles from uranium, 448
- Frischauer
 effect of β rays on crystallisation, 317
- γ rays
 nature of, 9, 286
 general properties of, 115 *et seq.*
 discovery of, 257
 absorption of, from radium, 258
 connection of absorption of, with density, 263
- γ rays (*cont.*)
 absorption of, by gases, 265
 absorption of, from different substances, 267
 connection of, with primary β rays, 270
 secondary β rays excited by, 271
 amounts of incident and emergent β rays excited by, 274
 theory of emission of β rays, 277
 variation of ionisation in vessels produced by, 278
 scattering of, 279
 production of, by β rays, 282
 theories of nature of, 286
 discontinuous nature of, 291
 ionisation and absorption of, 292
 total ionisation produced by, from radium, 294, 579
 photographic effect of, 305
 decay of active deposit of radium measured by, 495
 rise and fall of activity due to radium emanation measured by, 499
 heating effect of, from radium, 578
 connection of, with β rays, 610
 theory of origin of, 611
 number and energy of, 614
 emission of, from earth, 634
 decrease of intensity of, in atmosphere with height, 636
 use of, in comparing quantities of radium, 657
- Gates (Miss)
 effect of temperature on active deposit, 409
- Geiger
 decrease of velocity of α particles with range, 142
 ionisation due to one α particle, 153
 decrease of number of α particles with distance, 157
 scattering of α rays, 180
 laws of scattering of α rays by thin films, 185
 probability variation of α particles, 187
 complexity of emanations, 357
 α particles from actinium emanation, 396
 properties of thorium A, 535
- Geiger and Kovarik
 ionisation by β rays per unit path, 246
 ionisation produced by β particles, from a number of active substances, 250
- Geiger and Marsden
 large angle scattering of α rays, 183

- Geiger and Marsden (*cont.*)
 double scintillations, 191
 number of α particles from the emanations, 395
- Geiger and Nuttall
 range of α particles, 162
 complex nature of α rays from uranium, 448
 range of α particles from thorium emanation and thorium A, 535
 relation between range and period of transformation, 607
- Geiger and Rutherford
 charge carried by α particle, 52, 136
 electrical method of counting α particles, 129
 atomic and radio-active constants, 140
 number of α particles from uranium minerals, 447
 radio-active nomenclature, 524
 properties of thorium A, 535
 number of α particles from thorium, 551
 number of α particles emitted by uranium and thorium, 560
- Geiger, Rutherford and Bateman
 probability variations of α particles, 188
- Geitel
 natural ionisation of air, 592, 624
- Geitel and Elster
see Elster and Geitel
- Gerdien
 apparatus for measuring ionisation in atmosphere, 638
- Giebeler
 radium in a new star, 653
- Giesel
 separation of radium by crystallisation, 15
 preparation of commercial salts of radium, 17
 discovery of emanium, 19
 experiments on radio-lead, 21
 phosphorescence of zinc sulphide by α rays, 133, 297
 magnetic deflection of β rays, 193
 spectrum of luminosity of actinium, 304
 colouration by radium rays, 308
 dissociation of water by radium, 317
 effect of radium rays on the eye, 328
 flame spectrum of radium, 471
 separation of radium E, 515
 discovery of emanium, 519
 separation of actinium X, 528
 heating effect of radium, 569
- Giesel and Starke
 luminosity of air due to rays from polonium, 304
- Gimingham and Rossignol
 decay of thorium emanation, 351
- Glasson
 ionisation by cathode rays per unit path, 245
- Gleditsch (Mdlle)
 connection between lithium and copper in radio-active minerals, 321
 ratio of radium to uranium in minerals, 463
- Glew
 scintillations in the diamond, 299
- Gockel
 activity of atmosphere at high altitudes, 631
 large ions in the atmosphere, 638
- Godlewski
 absorption of β rays, 225
 absorption of γ rays from actinium, 267
 solubility of uranium X in water, 453
 separation of actinium X, 528
- Goldstein
 canal rays, 81
 condensation of actinium emanation, 371
- Gonders, Hofmann, and Wolf
 constituents of radio-lead, 510
- Gradient potential
 in ionised air, 65
- Grant and Steele
 micro-balance, 481
- Gray (J. A.)
 deflection of β rays from radium E, 212
 production of γ rays by β rays, 213
 production of γ rays by β rays from radium E, 283
 distribution of γ rays excited by β rays, 285
 emission of characteristic radiations by γ rays, 286
 escape of helium from minerals by grinding, 563
- Gray (J. A.) and Wilson (W.)
 complex nature of β rays from radium E, 238
- Gray (R. W.) and Ramsay
 atomic weight of radium, 472
 volume of radium emanation, 480
 density of radium emanation, 481
 vapour pressure, 484
- Gravity
 effect of, on distribution of active deposit, 405

- Greinacher
 charge carried by α rays, 157
 distribution of β rays from uranium, 313
 conductivity of dielectrics with polonium rays, 326
- Greinacher and Marckwald
 period of polonium, 515
- Grüner
 theory of successive changes, 418
- Hackett
 variation of emergence β radiation with atomic weight, 275
- Hahn
 discovery of meso-thorium and radio-thorium, 11, 544, 547
 range of α particles, 162
 on radio-active recoil, 175
 separation of new products by recoil, 176
 recoil of radium C from radium B, 177
 decay of thorium emanation, 351
 growth of radium in thorium, 467
 radio-actinium, 520
 recoil of actinium X from actinium, 527
 separation and properties of radio-actinium, 529
 analysis of α rays from thorium C, 539
- Hahn and Meitner
 exponential law of absorption, 211
 coefficient of absorption of β rays, 225
 β radiations from radium, 474
 complex nature of radium C, 500
 β rays from radium D, 514
 separation of actinium C by volatilisation, 526
 separation of actinium D, 527
 radiations from actinium D, 532
 analysis of thorium C, 539
 complexity of thorium C, 540
 separation of thorium D, 542
 β radiation from thorium D, 542
 β rays from meso-thorium 2, 548
- Hahn, v. Baeyer and Meitner
see v. Baeyer, Hahn and Meitner
- Hahn and Rutherford
 velocity and mass of α particles from radio-thorium, 128
- Hahn and Sackur
 identity of emanations from actinium and emanium, 351, 520
 period of actinium B, 525
- Haitinger and Ulrich
 separation of radium, 16
- Halos
 origin and dimensions of, 309
- Hardy and Anderson
 luminosity of eye due to radium rays, 328
- Hardy and Wilcock (Miss)
 action of radium rays on iodoform, 315
- Hartmann
 spectrum of luminosity of actinium, 304
- Hauser
 on velocity of expulsion of delta rays, 171
- Heat
 emission of, by radium, 568
 emission of, by radium at low temperatures, 570
 measurements of emission of, from radium, 571
 connection of emission of, with the radiations, 571
 emission of, by the radium emanation and its products, 573
 calculated emission of, by radium and its emanation, 576
 emission of, due to β and γ rays, 578
 distribution of emission of, between radium and its products, 580
 total emission of, by the emanation, 581
 emission of, by uranium and thorium, 583
 methods of measurement of emission of, 585
 emission of, by radio-active matter in earth, 650
 origin of earth's internal, 650
 origin of sun's, 655
- Heating effect
 suggested explanation of, for radium, 412
 importance of, in radio-active theories, 415
- Heaviside
 electrical mass of charged body, 71
- Helium
 connection of, with α particles, 137
 calculated rate of production of, by radium, 141
 discovery of, 553
 production of, by radium and its emanation, 555
 origin and rate of production of, by radium, 556
 production of, by radio-active substances, 559
 connection of, with age of minerals, 562
 amount of, in radio-active minerals, 563
 amount of, in ordinary substances, 564

- Helium** (*cont.*)
 age of geological strata by estimation of, 566
- Helmholtz and Richarz**
 action of ions on steam jet, 47
- Hemptinne**
 effect of radium emanations on electrodeless discharge, 323
- Henning**
 conductivity of barium radium-solution, 323
 radium collector, 324
 recombination of ions with active deposit, 400
- Henning and Kohlrausch**
 conductivity of radium bromide solutions, 323
- Henriot**
 condensation of actinium emanation, 371
 activity of potassium, 588
- Herrmann and Marekwald**
 luminosity of air due to α rays, 303
- Herschfinkel**
 attempts to separate metallic radium, 473
 concentration of radium D, 511
- Hess**
 absorption of γ rays from radium by air, 267
- Hess and St Meyer**
 heating effect of radium, 571
- Hess and v. Schweidler**
 heating effect of radium, 571
- Hevesy**
 absorption of actinium emanation by liquids, 377
 absorption of actinium emanation by charcoal, 380
 emanation method of detecting actinium in minerals, 520
 electro-chemical properties of active deposits, 603
- Hillebrande**
 gases in radio-active minerals, 553
- Himstedt**
 effect of radium rays on resistance of selenium, 323
 radium emanation in thermal springs, 641
- Himstedt and Meyer (G.)**
 luminosity of air due to α rays, 303
- Himstedt and Nagel**
 effect of radium radiations on the eye, 328
- Hofmann, Gonder and Wolf**
 constituents of radio-lead, 510
- Hofmann and Strauss**
 discovery of radio-lead, 21
- Hofmann and Wolf**
 concentration of radium D, 511
- Holmes**
 amount of lead in uranium minerals, 597
 age of uranium minerals, 598
- Hönigschmid**
 effect of radium rays on quartz, 308
 atomic weight of radium, 472
- Hopkinson (J.)**
 theory of electrometer, 97
- Huff**
 value of e/m of a particle, 123
- Huggins (Sir William and Lady)**
 spectrum of phosphorescent light of radium, 302
- Hupka**
 determination of e/m for electrons, 208
- Induction**
 radio-active, 338
- Ions**
 production of, by radiations, 26 *et seq.*
 velocity of, in electric field, 28, 31
 production of, by collision, 36 *et seq.*
 recombination of, 38
 mobility of, 41 *et seq.*
 difference between positive and negative, 42, 44
 effect of water vapour on mobility of, 44
 variation of mobility of, with temperature and pressure, 46
 condensation of water on, 46 *et seq.*
 difference between positive and negative, 49
 charge carried by, 50 *et seq.*
 diffusion of, 53 *et seq.*
 size and nature of, 56 *et seq.*
 number and distribution of, from active substances, 58
 magnetic field produced by motion of, 69
 electrical mass of, 70 *et seq.*
 total number produced by α particle, 153
 distribution of, along path of a particle, 154
 effect of velocity of a particle on production of, 157
 energy required to produce, by a particle, 158
 total number of, produced by β rays from radium, 230, 579
 number of, produced per cm. by β particle, 245
 total number of, produced by one β ray, 250
 total number of, produced by absorption of γ rays from radium, 294

Ions (*cont.*)

- number produced by penetrating rays from earth, 637, 640
 - types of, in the atmosphere, 638
 - excess of positive over negative, in atmosphere, 639
 - photographic record of trails of, produced by α and β rays, 663
- Ionisation
- theory of, for gases, 26 *et seq.*
 - variation of, with pressure and nature of gas, 31
 - difficulty of saturation of, with α rays, 32 *et seq.*
 - by collision, theory of, 36 *et seq.*
 - mechanism of, 56 *et seq.*
 - distribution of, due to active bodies, 58
 - total, due to α rays in different gases, 65
 - standards of, 111
 - relative, produced by α , β and γ rays, 117
 - variation of, from active matter with distance, 146, 159
 - of the α particle along its path, 149, 154
 - total, due to one α particle, 153
 - of α particles in air and hydrogen, 154
 - total produced by one gram of radium, 155
 - explanation of variation due to pencil of α rays, 156
 - variation of, with velocity, 157
 - energy required for, 158
 - production of, by recoil atoms, 179
 - total, produced by β rays from one gram of radium, 230, 579
 - variation of, with velocity of β particle, 245
 - law of decrease of, with velocity, 249
 - produced per cm. by β rays from active substances, 250
 - variation of, for γ rays with material of electroscope, 278
 - origin of, produced by γ rays, 293
 - total produced by absorption of γ rays, 294, 579
 - natural, in sealed vessels, 591
 - variation of, in sealed vessels with gas and pressure, 592
 - causes of, in sealed vessels, 593
 - natural, in screened vessels, 594
 - measurement of, in atmosphere, 637
 - character of, in atmosphere, 638
 - radio-active origin of, in atmosphere, 639

Ionisation current

- nature of, 26
- variation of, with voltage, 27

Ionisation current (*cont.*)

- difficulty of saturation of, with α rays, 32
 - increase of, by collision, 36
 - variation of, with voltage for surface distribution, 67 *et seq.*
 - measurement of, 93
 - measurement of, by steady deflection method, 101
 - by balance and compensation methods, 103
 - apparatus for measurement of, 106
 - direct measurement of, 108
- Ionium
- discovery of, 21
 - use of, as potential collector, 324
 - connection of, with uranium, 444
 - activity of, in uranium minerals, 446
 - method of discovery of, 455
 - growth of radium from, 456
 - radiation from and chemical properties of, 457
 - discussion of period of, 458, 467
 - amount of, in certain minerals, 464
 - effect of, on growth of uranium in radium, 466
 - attempt to determine spectrum of, 467
 - presence of, in thorium, 467

Jackson

- distribution of active deposits at low pressures, 401

Jaffe

- conductivity of liquids under radium rays, 325

Janssen

- helium in the sun, 553

Joly

- pleochroic halos, 309
- motion of radium in electric field, 326
- amount of radium and thorium in rocks of St Gothard Tunnel, 647
- amount of radium in sea water, 649
- amount of thorium in rocks, 649
- age of the earth, 653

Joly and Fletcher

- pleochroic halos, 310

Jorissen and Ringer

- action of β rays on hydrogen and chlorine, 316

Kaufmann

- variation of mass of electron with speed, 71
- measurement of e/m for cathode rays, 78
- variation of e/m of β particle with speed, 205

- Kaye and Laby**
 variation of ionisation of γ rays with pressure, 293
- Kayser**
 on radio-active origin of new stars, 654
- Keetman**
 properties of ionium, 457
- Kelvin (Lord)**
 origin of heat energy of radium, 413
 structure of the atom, 617, 618
 duration of earth's heat, 644
 duration of sun's heat, 655
- Kelvin (Lord), Smolan and Beattie**
 discharging power of uranium rays, 9
- Kennedy**
 distribution of active deposit of actinium, 399
 distribution of active deposit of actinium at low pressures, 402
- Kennedy and McLennan**
 activity of potassium, 588
- Kernbaum**
 rate of decomposition of water by radium, 318
- Kinoshita**
 photographic effect of α rays, 88, 305
 counting of α particles by photographic method, 134
 condensation of actinium emanation, 371
- Kinoshita, Nishikawa and Ono**
 theory of collection of active matter from atmosphere, 628
- Klaus**
 absorption of thorium emanation by liquids, 377
- Kleeman**
 saturation with α rays, 33
 conductivity of gases, 62
 total ionisation by α particle in different gases, 64
 comparison of emergent and incident delta radiation, 174
 complex character of γ rays, 262
 scattered γ radiation, 279
- Kleeman and Bragg**
see Bragg and Kleeman
- Kofer**
 absorption of emanation by liquids, 376
- Kohlrausch**
 probability variation of α particles, 187
 effect of radium rays on conductivity of water, 323
- Kohlrausch and Henning**
 conductivity of radium bromide solution, 323
- Kolowrat**
 effect of temperature on escape of radium emanation, 361
 β radiation from radium itself, 474
- Kovarik**
 effect of pressure on mobility of ions, 46
 mobility of ions at high pressures, 68
 reflected β rays, 216
 effect of scattering of β rays on absorption curve, 224
 β rays from radium D, 514
 period of actinium D, 527
- Kovarik and Geiger**
see Geiger and Kovarik
- Kovarik and Wilson (W.)**
 variation of scattering of β rays with velocity, 217
- Kucera and Masek**
 range of a particle from polonium, 162
 variation of stopping power of a particle with range, 168
- Kunz**
 phosphorescence of willemite and kunzite, 298
- Kunz and Baskerville**
 phosphorescence produced by radium rays, 299
- Kustner**
 amount of radium in new stars, 654
- Laborde**
 effect of surface on condensation of radium emanation, 373
- Laborde and Curie**
see Curie and Laborde
- Laby**
 total ionisation in different gases, 64
 string electrometer, 101
 discontinuous nature of γ rays, 291
- Laby and Kaye**
 variation of ionisation of γ rays with pressure, 293
- Langevin**
 coefficient of recombination of ions, 40
 mobility of ions, 44
 effect of pressure on mobility of ions, 46
 on theory of movement of ions in gases, 57
 large ions in the atmosphere, 638
- Larmor (Sir J.)**
 theory of radiation, 80
 radiation of energy from accelerated electron, 82
 electrical structure of atom, 617
- Lattes**
 velocity of expulsion of delta rays, 171

- Lead
 activity of, from uranium minerals, 21
 transformation product of polonium, 517
 activity of old, 595
 possible end product of radium, 597
 amount of, in uranium minerals, 597
 estimation of age of minerals by amount of, 598
- Le Bon
 discharge by quinine sulphate, 6
 absence of polarisation in uranium rays, 9
- Lenard
 discovery of cathode rays, 1
 ionisation by ultra-violet light, 5
 passage of cathode rays through matter, 76
 measurement of e/m for cathode rays, 78
 absorption of cathode rays, 209, 210
 absorption of β rays in different materials, 226
- Lerch, von
 chemical properties of active deposit, 408
 electrolysis of active deposit, 409
 separation of radium C, 488
 electrolysis of active deposit of thorium, 537
 separation of thorium C on nickel, 538
 period of thorium X, 543
 electro-chemical properties of active deposits, 603
- Lerch, von and Wartburg
 volatility of thorium D, 542
- Leslie (Miss)
 diffusion of thorium emanation; 388
 diffusion of actinium emanation, 389
- Levin
 range of α particles from polonium, 162
 absence of α rays in uranium X, 452
 volatilisation of actinium B and C, 526
 activity of actinium deprived of its products, 531
 separation of thorium C by carbon, 538
 period of thorium X, 543
- Levin and Ruer
 photographic action of potassium rays, 588
- Linke
 radium collector, 324
- Lithium
 possible product of transformation of copper, 321
- Lloyd
 separation of uranium X, 454
 separation of radium by barium, 601
- Lockyer
 helium in the sun, 553
 spectrum of helium, 554
- Lodge (Sir Oliver)
 electro-magnetic energy of moving charge, 69
- Logeman
 on velocity of expulsion of delta rays, 171
- Lorentz
 variation of electron with speed, 71
 theory of radiation, 80
 electrical structure of atom, 617
- Loschmidt
 theory of diffusion, 383
- Lotka
 radio-active equilibrium, 431
- Lowry and Armstrong
 radio-activity a form of phosphorescence, 413
- Luminosity
 of substances exposed to radium rays, 296 *et seq.*
 decay of, in zinc sulphide and willemitite, 301
 of radium compounds, 302
 spectrum of, in radium salts, 302
 spectrum of, in actinium salts, 304
 of air surrounding polonium, 304
- Lutz
 string electrometer, 101
- Macallum and McLennan
 variation of penetrating radiation with altitude, 636
- Mache
 absorption of radium emanation by liquids, 375
 radium emanation in thermal springs, 641
- Mache and Meyer (St.)
 total ionisation due to one curie of emanation, 502
- Mache and v. Schweidler
 velocity of ions in atmosphere, 638
- Mackenzie
 value of e/m for α particle, 122
 complex nature of α rays from radium, 143
 on emergence and incidence β radiation, 274
- Madsen
 scattering of β rays by thin screens, 219
 scattered γ radiation, 279
- Madsen and Bragg
 variation of emergence β radiation with atomic weight, 275
- Magnetic field
 produced by an ion in motion, 69

- Makower**
 charge carried by β rays of radium, 202
 absorption of β rays, 203
 diffusion of radium emanations, 385
 distribution of active deposit at low pressures, 401
 effect of temperature on decay of products of radium, 503
 volatilisation of radium A, B and C, 505
- Makower and Evans**
see Evans and Makower
- Makower and Fajans**
see Fajans and Makower
- Makower and Moseley**
 emission of γ rays by radium B, 269, 488
 effect of γ rays from radium B on rise curve, 495
- Makower and Russ**
 radio-active recoil, 175
 absorption of recoil atoms, 176
 recoil of radium C from radium B, 177
 range of recoil atoms, 405
 effect of temperature on decay of products of radium, 503
- Marckwald**
 separation of radio-tellurium, 20
 identity of emanations from actinium and emanium, 520
 separation of radium and mesothorium, 548
- Marckwald and Greinacher**
 period of polonium, 515
- Marckwald and Herrmann**
 luminosity of air due to α rays, 303
- Marckwald and Russell**
 ratio of radium to uranium in minerals, 463
- Marsden**
 effect of bombardment on scintillations, 300
 decay of luminosity produced by, 300, 301
- Marsden and Barratt**
see Barratt and Marsden
- Marsden and Darwin**
 complexity of thorium C, 540
- Marsden and Geiger**
see Geiger and Marsden
- Marx**
 velocity of X rays, 289
- Masek and Kucera**
see Kucera and Masek
- Mass**
 electrical, of moving ion, 70 *et seq.*
 of electron at slow speeds, 79
 of canal rays, 81
 measurement of, for α particle, 121 *et seq.*
- Mass (cont.)**
 of atom of H, 140
 of electron and variation with speed, 204, 667
 origin of, 618
 distribution of, in structure of atom, 619
- Matter**
 apparent radio-activity of ordinary, 590
- McClelland**
 distribution of scattered β rays, 214
 connection of scattering with chemical constitution, 215
 theory of absorption of β rays, 231
 absorption of γ rays, 259
- McClung**
 coefficient of recombination of ions, 40
 ionisation curve for radium C, 149
- McClung and Rutherford**
 energy emitted from active substances, 411, 568
- McCoy**
 uranium standards, 111
 relation between copper and lithium in radio-active minerals, 321
 activity of uranium minerals, 445
 constancy of radium to uranium in minerals, 460
 surface distribution of radium in pyromorphite, 463
- McCoy and Ross**
 activity of thorium minerals, 546
- McIntosh and Eve**
 amount of radium in rocks, 646
- McLennan**
 emission of delta rays, 173
 penetrating radiation from earth, 594, 634
 activity of old specimens of lead, 595
 activity of snow, 627
 effect of spray on collection of active matter, 627
- McLennan and Burton**
 activity of ordinary matter, 593
- McLennan and Kennedy**
see Kennedy and McLennan
- McLennan and Macallum**
see Macallum and McLennan
- Meitner**
 separation of components of thorium C, 541
- Meitner and Hahn**
see Hahn and Meitner
- Meitner, v. Baeyer and Hahn**
see v. Baeyer, Hahn and Meitner
- Meso-thorium**
 discovery of, 11
 effect of, on decay of thorium X, 338
 separation and property of, 546

- Meso-thorium (cont.)**
 variation in amount of, in preparations of thorium, 546
 period of, 547
 separation with thorium X, 547
 chemical properties of, 548
 variation of activity with time, 549
 separation of, on commercial scale, 550
- Meso-thorium 2**
 absorption of γ rays from, 268
 proportion of γ rays to β rays, 271
 separation and properties of, 548
 radiations from, 548
- Methods of measurement**
 in radio-activity, 87 *et seq.*
 comparison of photographic and electrical, 87
 description of electrical, 88 *et seq.*
- Meyer (E.)**
 structure of γ rays, 291
- Meyer (St.)**
 phosphorescence in kunzite, 301
- Meyer (St.) and Hess**
 heating effect of radium, 571
- Meyer (St.) and Mache**
 total ionisation due to one curie of emanation, 502
- Meyer and Regener**
 probability variation of α particles, 187
- Meyer (St.) and v. Schweidler**
 absorption of α rays, 146
 magnetic deflection of β rays, 193
 changes of activity in uranium, 453
 analysis of radio-lead, 511
 period of radium D, 512
 period of polonium, 515
 period of actinium B, 525
 separation of actinium C by volatilisation, 526
 residual activity on bodies exposed to actinium emanation, 527
- Meyer (G.) and Himstedt**
 luminosity of air due to α rays, 303
- Millikan**
 measurement of charge on ion, 52
- Minerals**
 activity of uranium and thorium, 13
 separation of radium from uranium, 14
 active substances present in uranium, 444
 constancy of ratio of radium to uranium in, 446, 460
 deficiency of radium in some uranium, 463
 production of helium by uranium and thorium, 560
 age of radio-active, 562, 598
- Minerals (cont.)**
 amount of helium in uranium and thorium, 564
 heating effect of uranium, 583
 final transformation products of radio-active, 596
 amount of lead in radio-active, 597
- Mitchell**
 radio-active equilibria, 431
- Mobility**
 of ions, 41 *et seq.*
 difference in, for positive and negative ions, 42, 44
- Molecules**
 number of, per c.c. of gas, 140
- Moore and Schlundt**
 methods of separation of uranium X, 453
 separation of thorium X, 544
- Moseley**
 charge carried by β rays from radium, 204
 number of β rays from radium B and radium C, 611
 number of γ rays per β ray, 614
- Moseley and Fajans**
see Fajans and Moseley
- Moseley and Makower**
see Makower and Moseley
- Moseley and Robinson**
 total ionisation produced by β and γ rays, 230, 295, 579
- Moss**
 escape of helium from minerals by grinding, 563
- Moulin**
 saturation with α rays, 33
 velocity of expulsion of delta rays, 171
 radium collector, 324
- Nagaoka**
 structure of the atom, 620
- Neon**
 possible transformation product of radium emanation, 321
- Nishikawa, Kinoshita and Ono**
 theory of collection of active matter from atmosphere, 628
- Nomenclature**
 of radio-active substances, 23 *et seq.*
 origin of, for radiations, 115
 change in, for active deposits, 524, 534
- Nuttall and Geiger**
see Geiger and Nuttall
- Occlusion**
 of emanation in thorium and radium, 359, 361

- Ono, Kinoshita and Nishikawa
theory of collection of active matter
from atmosphere, 628
- Owens
effect of smoke on recombination, 41
absorption of α rays, 146
on thorium emanation, 348
- Ozone
production of, by radium rays, 314
- Paschen
apparent charge carried by γ rays,
272
attempt to deflect γ rays by a mag-
netic field, 286
velocity distribution of β rays, 251
- Peck and Willows
effect of radium rays on spark, 322
- Pegram
electrolysis of active deposit, 409
electrolysis of active deposit of
thorium, 537
- Pegram and Webb
heating effect of thorium, 583
- Penetrating power
comparison of, for α , β and γ rays, 117
of β rays, 223
variation of, with energy of β par-
ticle, 239
of γ rays, 258 *et seq.*
- Perkins
diffusion of radium emanation, 386
- Perrin
measurement of charge on ion, 52
charge carried by cathode rays, 76
structure of the atom, 410
- Petavel and Rutherford
effect of high temperature and pres-
sure on decay of emanation, 505
- Petterson
heating effect of β rays from radium,
578
- Phillips
effect of temperature on recombina-
tion, 41
effect of temperature on mobility of
ions, 46
- Phillips (C. E.)
conducting glass fibres, 94
- Phosphorescence
of uranium salts, 7
due to radium rays, 296
of zinc sulphide, 297
of barium platinocyanide, willemite
and kunzite, 298
of diamond, 299
effect of bombardment of α particles
on, 300
decay of, for willemite and zinc sul-
phide, 301
- Phosphorescence (*cont.*)
spectrum of, shown by radium, 302
spectrum of, shown by actinium, 302
production of, by heat (thermo-lumin-
escence), 304
- Phosphorus
discharge by, 5
- Photographic action
of α rays from thick layers, 143
of α , β and γ rays, 305
produced by one α particle, 306
- Photographic method
use of, in radio-activity, 87
application of, to deflection of β
rays, 194
decrease of velocity of β rays by,
244
records by, of trails of α and β par-
ticles, 663
registration of α particles by, 664
- Physical actions of radium rays
on spark, 322
on electrodeless discharge, 323
on resistance of selenium, 323
on conductivity of radium solutions,
323
on contact difference of potential,
323
equalization of potential, 324
on resistance of liquid and solid
dielectrics, 324
- Physiological actions
of radium rays, 327
- Piezo-electric
of quartz, 104 *et seq.*
- Pirret (Ruth) and Soddy
ratio of radium to uranium in mine-
rals, 463
- Pohl
luminosity of air due to α rays, 303
- Pohl and Franck
mobility of ions in helium, 45
- Pollock
large ions in the atmosphere, 638
- Polonium
discovery and properties of, 14, 20
connection with radio-tellurium, 20,
515
luminosity of air surrounding, 304
decomposition of water by, 318
connection of, with radium F, 515
chemical properties of, 516
amount of, in uranium minerals, 517
spectrum of, 517
possible transformation of, into lead,
517
heating effect of, 586
- Poole
heating effect of uranium and thorium
minerals, 584

- Potassium**
 discovery of activity of, 12
 radio-activity of, 587
 absorption of β rays from, 588
 effect of conditions on activity of, 589
- Precht and Runge**
 flame spectrum of radium, 471
 heating effect of radium, 569
- Pressure**
 effect of, on mobility of ion, 46
 effect of, on current through gases, 60
 effect of, on ionisation due to γ rays, 293
 effect of, in distribution of active deposit, 401
 vapour for radium emanation, 484
 effect of, on γ ray activity of radium, 505
- Probability**
 variations in emission of β particles, 186 *et seq.*
 variation in number emitted in given interval, 189
 variation in ionisation due to γ rays, 291
 bearing of, on law of transformation, 419
- Products**
 final products of disintegration, 596
 tables and properties of, 668
- Przibram**
 mobility of ions in vapours, 45
 condensation of vapours round ions, 50
- Pulse**
 theory of X rays, 83
 connection of, with γ rays, 287
 distribution of energy in, for γ rays, 288
- Quartz**
 piezo-electric, 104 *et seq.*
 effect of radium rays on, 308
- Quinine sulphate**
 discharge by, 6
- Radiation**
 discovery of, from uranium, 7
 constancy of, from uranium, 8
 theories of, 80
 of energy, from moving electron, 82
 secondary, accompanying α rays, 170
 recoil, 174 *et seq.*
 secondary, accompanying β rays, 204
 from uranium, 447
 from uranium X, 452
 from uranium Y, 455
 from ionium, 457
 from radium, 474
- Radiation (cont.)**
 from radium A, B, C, 489
 from radium D, E, F, 508
 from actinium products, 531
 penetrating from earth and atmosphere, 594, 634
- Radio-actinium**
 discovery and properties of, 529
 rise and decay curves due to, 530
 chemical properties of, 533
- Radio-active**
 definition of term, 4
- Radio-lead**
 discovery of, 21
 connection with radium D, 21, 511
 radio-active constituents of, 510
- Radio-tellurium**
 separation of, 20
 connection with polonium, 21
 connection of, with radium F, 515
 separation of, 516
- Radio-thorium**
 discovery of, 11
 separation and properties of, 544
 radiations from, 545
 growth of, from meso-thorium, 549
 separation of, from meso-thorium, 551
- Radium**
 discovery of, 12 *et seq.*
 separation of, 14 *et seq.*
 amount of, in minerals, 16
 radiations from, 17
 number of a particles emitted by, 132
 groups of α rays present in, 150
 clock, 199
 number of β particles emitted by, 202 *et seq.*
 absorption of β rays from, in air, 229
 distribution with velocity of β rays from, 251
 velocity of groups of β rays from, 254
 absorption of γ rays from, 258
 luminosity of compounds of, 302
 spectrum of light emitted by, 303
 chemical actions produced by radiations from, 314
 decomposition of water by, 317
 effect of radiations of, on spark, 322
 effect of, on resistance of selenium, 323
 use of, as potential equaliser, 324
 effect of radiations from, on conductivity of dielectrics, 324
 motion of, in electric field, 326
 physiological actions produced by radiations from, 327
 connection of, with uranium, 444
 activity of, in uranium minerals, 446

Radium (*cont.*)

- life of, 459
 - genetic connection of, with uranium, 460
 - poverty of, in certain minerals, 463
 - production of, from uranium, 465
 - separation of, 469
 - spectrum of, 470
 - atomic weight of, 471
 - production of metallic, 473
 - general properties of, 473
 - radiations from, 474
 - emanation from, 475
 - discovery of helium in, 555
 - rate of production of helium by, 556
 - heating effect of, 568
 - measurements of heating effect of, 571
 - connection of heating effect of, with radiations of, 571
 - calculated heating effect of, 576
 - heating effect of β and γ rays from, 578
 - distribution of heating effect of, amongst its products, 580
 - heating effect of, mixed with phosphorescent materials, 586
 - end product of, 597
 - electro-chemical properties of, 603
 - relation between ranges and periods of transformation for products of, 607
 - distribution of, in earth's crust, 643
 - amount of, in igneous and sedimentary rocks, 645
 - amount of, in rocks of St Gothard tunnel, 647
 - amount of, in sea water, 649
 - possible presence of, in sun and new stars, 653
 - effect on heat of sun, 656
 - comparison of quantities of, 657
 - balance methods from comparison of, 658
 - standard solution of, 660
 - preparation of International standard of, 661
- Radium emanation
- decay of, 351
 - effect of conditions on decay of, 355
 - radiation from, 357
 - effect of conditions on escape of, 361
 - condensation of, 364
 - temperature of condensation of, 366
 - effect of conditions on condensation of, 373
 - vapour pressure of, 374
 - absorption of, by liquids, 375
 - absorption of, by solids and charcoal, 378

Radium emanation (*cont.*)

- diffusion of, 383
 - distribution of active deposit from, 392
 - general properties of, 475
 - rise of activity of radium due to, 476
 - separation and purification of, 476
 - volume of, 479
 - density of, 481
 - spectrum of, 482
 - boiling point and vapour pressure of, 483
 - rate of production of helium by, 556
 - heating effect of, 571
 - calculated heating effect of, 576
 - total heat emission of, 581
 - amount of, in the atmosphere, 633
 - effect of meteorological conditions on amount of, 634
 - presence of, in soil, 640
 - presence of, in tap water and underground air, 641
 - presence of, in hot and mineral springs, 641
 - measurement of amount of, in soil, 643
 - presence of, in sun and new stars, 653
 - tables of decay and growth of, 665
- Radium A
- decay of, 487
 - effect of, on activity curves, 490
 - volatility of, 505
 - heating effect of, 576
- Radium B
- value of e/m for, 178
 - discovery of, 487
 - volatility of, 488, 505
 - β rays from, 488
 - γ rays from, 488
 - separation of, by recoil from radium A, 489
 - effect of β rays from, on activity curves, 493
 - effect of γ rays from, on activity curves, 495
 - heating effect of, 576
 - electro-chemical properties of, 603
- Radium C
- absorption of γ rays from, 264, 268
 - proportion of γ rays to β rays emitted by, 271
 - discovery of, 487
 - separation of, by nickel, 488
 - volatility of, 488
 - effect of, on α ray decay curves, 489
 - effect of, on β ray decay curves, 493
 - effect of, on γ ray decay curves, 495
 - maximum amount of, in decaying emanation, 498

- Radium C** (*cont.*)
 decay of, measured by soft and hard γ rays, 499
 complex nature of, 500
 effect of temperature and pressure on, 502
 volatility of, 505
 effect of gases on volatility of, 506
 heating effect of, 576
 electro-chemical properties of, 603
- Radium C₂**
 separation and properties of, 500
 origin of, 501
- Radium D**
 calculation of growth of, from radium, 431
 period and properties of, 507
 rise of α and β ray activity due to, 508
 separation of, by recoil from radium C, 511
 separation of, from uranium minerals, 511
 methods of obtaining pure preparations of, 511
 period of, 512
 radiations from, 514
- Radium E**
 production of γ rays by β rays from, 283
 period and properties of, 507, 514
 rise of activity due to, 509
 separation of, from radium D, 514
 radiations from, 515
- Radium F**
 period and properties of, 507
 rise of activity due to, 508
 volatilisation of, 509
 period of, 515
 connection of, with polonium and radio-tellurium, 515
 chemical properties of, 516
 amount of, in uranium minerals, 517
 spectrum of, 517
 possible transformation of, into lead, 517
- Rain**
 activity of, 627
- Ramsay (Sir William)**
 decomposition of gases by α rays, 316
 discovery of helium, 554
- Ramsay and Cameron**
see Cameron and Ramsay
- Ramsay and Collie**
 spectrum of radium emanation, 482
- Ramsay and Gray**
see Gray and Ramsay
- Ramsay and Soddy**
 dissociation of water by radium, 317
- Ramsay and Soddy** (*cont.*)
 volume of radium emanation, 480
 discovery of helium in radium, 555
 rate of production of helium by radium, 557
- Ramsay and Usher**
 on production of carbon dioxide in thorium solution, 322
- Ramstedt**
 absorption of thorium emanation by liquids, 377
- Range**
 of recoil atoms in gases, 176, 403
- Range of α particles**
 in air, 149
 from radium, 150
 methods of determination of, 161
 table of, 164
 effect of strong electric field on, 165
 variation of, with nature of material, 165
 in mica and glass, 310
 from uranium, 448
 connection of period of transformation with, 607
- Ré (F.)**
 theory of matter, 412
- Recoil**
 radiation, 174 *et seq.*
 velocity of, 175
 separation of active substances by, 176
 distance traversed in gases during, 176
 velocity and mass of atoms liberated by, 177
 use of, to determine atomic weights, 178
 ionisation due to atoms liberated by, 179
 range of atoms liberated by, 403
- Recombination**
 of atoms of active deposit with ions, 400
- Recombination of ions**
 27, 38
 theory of initial (Bragg), 33
 coefficient of, 41
 effect of pressure and temperature on, 41
 effect of dust on, 41
- Reflection**
 apparent for β rays, 212
- Regener**
 difficulty of saturation with α rays, 35
 measurement of charge on α particle, 52, 137
 scintillations produced by β particle, 133
 counting of scintillations, 133

- Regener (*cont.*)
 decrease of number of α particles
 with distance, 166
 scintillations in the diamond, 299
 period of polonium, 515
- Reinganum
 effect of electric field on range of α
 particle, 165
 photographic trail of α particle, 307
- Retardation
 of α particle, 141
 law of, 142
 of β particles in traversing matter,
 240
- Richarz and Helmholtz
 actions of ions on steam jet, 47
- Righi
 scattering of β rays, 215
- Ringer and Jorissen
 action of β rays on hydrogen and
 chlorine, 316
- Ritzel
 separation of uranium X by charcoal,
 454, 601
- Robinson and Moseley
see Moseley and Robinson
- Robinson (H.) and Rutherford
 heating effect of radium and its pro-
 ducts, 576, 577
 heating effect of β and γ rays from
 radium, 580
- Rocks
 amount of radium in, 644
 amount of thorium in, 649
- Röntgen rays
 discovery of, 1
 theories of nature of, 83 *et seq.*
- Ross and McCoy
 activity of thorium minerals, 546
- Rossi and Russell
 spectrum of ionium, 467
- Rossignol and Gimingham
 decay of thorium emanation, 351
- Royds
 spectrum of radium emanation, 483
- Royds and Rutherford
 nature of α particle, 137
 action of emanation on water, 321
 spectrum of radium emanation, 482
- Rubidium
 radio-activity of, 12, 587
 absorption of β rays from, 589
- Rudge
 colouration of glass by radium rays,
 307
- Ruer and Levin
 photographic action of potassium
 rays, 588
- Rumelin
 decay of radium emanation, 352
- Runge and Precht
see Precht and Runge
- Russ
 diffusion of thorium emanation, 388
 distribution of active deposit of acti-
 nium, 399
 distribution of active deposit at low
 pressures, 402
- Russ and Makower
see Makower and Russ
- Russell
 effect of temperature on decay of
 products of radium, 503
 effect of gases on volatilisation of
 radium C, 507
- Russell and Marckwald
 ratio of radium to uranium in mine-
 rals, 463
- Russell and Rossi
 spectrum of ionium, 467
- Russell and Soddy
 absorption of γ rays from radium, 259
 correction for absorption using wide
 cone of γ rays, 261
 absorption of γ rays from radio-
 active substances, 267
 period of uranium X, 452
 separation of uranium X, 453
- Russell and Soddy (Mr and Mrs)
 absorption of γ rays by lead, 260
- Saake
 activity of atmosphere at high alti-
 tudes, 631
- Sackur
 decay of radium emanation, 352
- Sackur and Hahn
see Hahn and Sackur
- Salomonsen and Dreyer
 effect of radium rays on quartz, 308
- Sanderson
 amount of radium and thorium ema-
 nation in air drawn from the soil,
 643
- Satterly
 absorption of radium emanation by
 charcoal, 380
 amount of radium in potassium salts,
 589
 amount of radium emanation in
 atmosphere, 633
- Saturation current
 meaning of, 29
 difficulty of obtaining with α rays,
 32 *et seq.*
- Scattering of α rays
 laws of, 180 *et seq.*
 through large angles, 183
 theory of, 184
 single and compound, 186

- Scattering of β rays
 effect of, on distribution, 215
 amount of, by different materials, 217
 variation of, with velocity, 217
 by transmission, 218
 by thin sheets of matter, 219
 theories of, 220
- Scattering of γ rays, 279
 variation of amount of, with material
 and angle, 281
- Schenke
 radium emanation in thermal springs,
 641
- Schlundt and Moore
see Moore and Schlundt
- Schmidt (G. C.)
 discovery of activity of thorium, 10
- Schmidt (H. W.)
 use of quartz fibre in electroscopes, 94
 reflected β rays, 216
 absorption of β rays, 224
 coefficients of absorption of β rays,
 225
 absorption of β rays by liquids, 228
 theory of absorption of β rays, 281
 velocity of β rays from radium E
 and uranium X, 238
 distribution of β rays, 314
 recombination of atoms of active
 deposit, 400
 β rays from radium B, 488
 decay of active deposit of radium, 492
 effect of β rays from radium B on
 rise curve, 493
 effect of temperature on decay of
 products of radium, 503
- Schmidt (H. W.) and Cermak
 effect of temperature on decay pro-
 ducts of radium, 503
- Schrader
 effect of gases on volatilisation of
 active deposit, 506, 600
- Schuster
 measurement of e/m for cathode
 rays, 78
 pulse theory of X rays, 83
 effect of pressure on γ ray activity
 of radium, 505
- v. Schweidler
 probability variations in transforma-
 tions, 187
- v. Schweidler and Bohm-Wendt
 conductivity of oils under radium
 rays, 326
- v. Schweidler and Hess
 heating effect of radium, 571
- v. Schweidler and Mache
 velocity of ions in atmosphere, 638
- v. Schweidler and Meyer (St.)
see Meyer and Schweidler
- Scintillations
 discovery of, 133
 method of counting α particles by,
 134
 double, 191
 in zinc sulphide, 297
 in diamond, 299
 duration of, in zinc sulphide, 300
 effect of continued bombardment on,
 300
- Searle
 electrical mass of a charged body, 71
- Sea-water
 amount of radium in, 649
- Seitz
 absorption of β rays, 225
- Selenium
 effect of radium rays on resistance
 of, 323
- Simon
 measurement of e/m for cathode rays,
 78, 206
- Simpson
 amount of active matter in atmo-
 sphere, 631
- Simpson and Wright
 use of quartz fibre electroscopes, 96
 ionium collector, 324
 amount of active deposit in air over
 the sea, 632
- Slater (Miss)
 emission of delta rays from active
 substances, 171
 volatilisation of thorium B and
 thorium C, 537
- Smolan, Kelvin (Lord), and Beattie
 discharging power by uranium rays, 9
- Snow
 activity of, 627
- Soddy
 photographic action of β rays, 307
 photographic action of uranium, 452
 production of radium by uranium,
 465
 period of ionium, 467
 separation of radium and meso-
 thorium, 548
 rate of production of helium by
 uranium, 561
- Soddy (Mr and Mrs) and Russell
 absorption of γ rays by lead, 260
- Soddy and Mackenzie
 production of radium by uranium, 466
- Soddy and Pirret (Ruth)
 ratio of radium to uranium in
 minerals, 463
- Soddy and Ramsay
see Ramsay and Soddy
- Soddy and Russell
see Russell and Soddy

- Soddy and Rutherford**
 theory of transformation, 2, 335 *et seq.*
 discovery of thorium X, 332
 decay of thorium X, 333
 decay and rise of uranium X, 335
 decay of radium emanation, 352
 effect of conditions on emanating power of thorium, 358
 condensation of thorium and radium emanations, 364
 temperature of condensation of radium emanation, 366
 development of disintegration theory, 413
 period of uranium X, 452
 origin of helium in radio-active substances, 555
- Soil**
 radio-activity of, 640
 presence of radium and thorium emanations in, 643
- Spectrum**
 of ionium, 467
 of radium, 470
 of radium emanation, 482
 of polonium, 517
- Spinthariscopes**, 133
- Standards**
 of ionisation, 111
 of radium, 660 *et seq.*
- Stark (J.)**
 nature of γ rays, 290
 theory of successive changes, 418
- Stark and Giesel**
 luminosity of air due to rays from polonium, 304
- Starke (H.)**
 determination of e/m for cathode rays, 208
 production of γ rays by β rays, 282
- Steele and Grant**
 micro-balance, 481
- Stokes**
 terminal velocity of small sphere in air, 51
 pulse theory of X rays, 83
- Stoney (Johnstone)**
 origin of name "electron," 79
- Stopping power**
 definition of, for α particle, 165
 law of, 165
 variation of, with velocity, 168
- Störmer**
 theory of aurora, 654
- Strauss and Hofmann**
 discovery of radio-lead, 21
- Strömholm and Svedberg**
 chemical properties of thorium X and actinium X, 533, 544
- Strong**
 activity of potassium, 588
- Strutt**
 conductivity of gases, 62
 nature of α rays, 119
 radium clock, 199
 absorption of β rays from radium, 227
 luminosity of autunite, 302
 constancy of radium to uranium in minerals, 460
 rate of production of helium by uranium and thorium minerals, 561
 escape of helium from thorianite, 563
 amount of helium in radio-active minerals, 564
 origin of the helium in beryl, 565
 age of geological strata, 566
 amount of helium in specimens of zircon, 566
 amount of helium in saline minerals, 568
 radio-activity of ordinary materials, 592
 radium emanation in hot springs, 641
 amount of radium in rocks, 644
 radium in meteorites, 653
- Sun**
 presence of radium in, 654
 duration of heat of, 655
- Svedberg and Strömholm**
see Stromholm and Svedberg
- Swinne**
 relation between range of α particle and period of transformation, 609
- Szilard**
 concentration of radium D, 511
- Taylor**
 ionisation of α particle, 65
 variation of ionisation with range for gases, 154
 variation of stopping power with velocity, 168
- Temperature**
 effect of, on decay of radium emanation, 355
 effect of, on escape of thorium emanation, 359
 effect of, on escape of radium emanation, 361
 effect of, on condensation of emanations, 366
 effect of, on active deposits, 409
 effect of, on volatility of active deposit of radium, 503
 independence of rate of transformation on, 503

- Temperature (*cont.*)
of volatilisation of radium products
in different gases, 506
- Thermo-luminescence, 304
- Thomson (Sir J. J.)
difference between positive and negative ions, 49
measurement of charge on ion, 51
electrical mass of a charged body, 71
charge carried by cathode rays, 76
electrostatic deflection of cathode rays, 77
measure of e/m for cathode stream, 78
canal rays, 81
pulse theory of X rays, 83
distribution of energy in pulse theory, 84
emission of delta rays, 135
properties of delta rays, 170
theory of scattering of β rays, 220
origin of heat energy of radium, 412
structure of the atom, 617
number of electrons in atoms, 618
radio-activity of tap water, 641
- Thomson (J. J.) and Rutherford
theory of ionisation, 26
- Thorianite
production of helium by, 561
age of, 562
escape of helium from, 563
- Thorium
discovery of activity of, 10
nature of radiations from, 10
emanation from, 10
changes in activity of, 11
calculation of variation of activity of
commercial preparations, 440, 546
transformations of, 534 *et seq.*
number of α particles emitted by, 551
period of, 551
series of transformations of, 552
rate of production of helium by, 560
heating effect of, 583
end product of, 599
relation between range and period of
transformations of, 607
distribution of, in rocks, 649
- Thorium emanation
discovery and properties of, 348
decay of, 350
radiations from, 357
effect of conditions on escape of, 358
condensation of, 364
absorption of, by liquids, 377
absorption of, by solids, 379
diffusion of, 387
number of α particles expelled by, 395
transformation of, 534
presence of, in atmosphere, 626
emission of, by soil, 641
- Thorium emanation (*cont.*)
emission of, by sediment, 642
measurement of amount of, in soil,
643
- Thorium A
discovery and properties of, 396
period and properties of, 534
- Thorium B
period and properties of, 535
volatilisation of, 537
electrolysis, 537
radiations from, 538
electro-chemical properties of, 603
- Thorium C
separation and properties of, 535
volatilisation of, 537
separation of, on nickel plate, 538
analysis of α radiations from, 539
complex nature of, 539
modes of disintegration of, 541
electro-chemical properties of, 603
- Thorium C₁
component product of thorium C, 540
- Thorium C₂
component product of thorium C, 540
- Thorium D
absorption of γ rays from, 268
proportion of γ rays to β rays, 271
separation and properties of, 542
radiations from, 542
electro-chemical properties of, 603
- Thorium X
discovery of, 333
decay and rise of, 333
separation and properties of, 543
radiations from, 543
chemical properties of, 544
electro-chemical properties of, 603
- Thorpe (Sir T. E.)
atomic weight of radium, 472
- Townsend
ionisation by collision, 36
coefficient of recombination of ions, 40
diffusion of ions in gases, 53 *et seq.*
proof that charge on ion equals charge
carried by hydrogen atom in elec-
trolysis, 55
compensation method of measure-
ment, 103
- Transformation
products of, 22 *et seq.*
decay and exponential law of, 22
of matter by radiations, 320
meaning of exponential law of, 341
theory of, 344, 410 *et seq.*
development of theory of, 413
theory for one, 419
theory of successive, 420
rayless, 433
analogies between series of, 605

- Transformation (cont.)**
 relation between range and period of, 607
 origin of β and γ rays in, 611 *et seq.*
 mode of, 620
 causes of, 621
 irreversible character of, 623
- Trautenberg**
 absorption of radium emanation by liquids, 375
- Tuomikoski**
 absorption of γ rays, 259
- Ulrich and Haitinger**
 separation of radium, 16
- Ultra-violet light**
 discharge by, 5
- Uranium**
 discovery of activity of, 6
 phosphorescence of salts of, 7
 activity of compounds of, 13
 use of, as ionisation standard, 111
 absorption of α rays from, 146
 range of α rays from, 163
 absorption of β rays in, 229
 absorption of γ rays from, 264, 268
 proportion of γ rays to β rays from, 271
 luminosity of nitrate of, 302
 connection with ionium and radium, 444
 activity of minerals containing, 445
 relative activity of products of, in minerals, 446
 complexity of, 447
 presence of two groups of α rays in, 449
 period of, 450
 effect of periods of two components on relative activity of, 451
 connection between radium and, 460
 production of radium in, 465
 series of products of, 468
 rate of production of helium by, 560
 heating effect of, 583
 end product of, 597
 relation between range and period of transformation of, 607
 amount of, in earth, 650
- Uranium 1**, 449, 468 (*see Uranium*)
Uranium 2, 449, 468 (*see Uranium*)
Uranium X
 absorption of γ rays from, 264, 268
 proportion of γ rays to β rays, 271
 discovery of, 330
 methods of separation of, 331
 decay of, 331
 decay and rise of, 335
 period of, 452
 radiations from, 452
- Uranium X (cont.)**
 methods of separation of, 453
 chemical properties of, 454, 603
- Uranium Y**
 discovery and properties of, 454
- Usher**
 action of α rays on hydrogen and nitrogen, 316
 rate of decomposition of water by actinium and radium, 318
- Valency**
 change of, in α ray transformations, 606
- Varley**
 discovery of cathode rays, 76
- Vegard**
 theory of aurora, 654
- Velocity**
 of ions, 27 *et seq.*
 of α particles, 123, 128
 variation of absorption of β rays with, 238
 decrease of, for β rays in traversing matter, 240
 variation of ionisation of β rays with, 245
 distribution with, of the β rays, 250
 of homogeneous groups of β rays, 254
 of atoms of active deposit, 407
 of ions in atmosphere, 638
- Villard**
 discovery of γ rays, 257
- Volatilisation**
 of radium products, 504, 505
 effect of gases on, 506
- Volatility**
 separation of products by, 600
- Waklhoff**
 production of burns by radium, 327
- Wallstabe**
 diffusion of radium emanation in liquids, 390
- Walter**
 luminosity of air due to α rays, 303
- v. Wartburg and v. Lerch**
 volatility of thorium D, 542
- Water**
 decomposition of, by radiation, 317 *et seq.*
- Watson**
 spectrum of radium emanation, 483
 atomic weight of helium, 554
- Webb and Pegram**
 heating effect of thorium, 583
- Wellisch**
 mobility of ions, 45
 mobility of ions in gaseous mixtures, 46

- Wellisch (*cont.*)
 theory of movement of ions in gases, 57
- Wellisch and Bronson
 charge on active deposit, 399
- Welsbach (Auer v.)
 attempts to separate ionium and thorium, 457
 separation of actinium, 520
- Wertheimstein
 distance traversed by recoil atoms, 176
 ionisation due to recoil atoms, 179
 range of recoil atoms, 405
- Wheeler and Bumstead
see Bumstead and Wheeler
- Wheelock
 saturation with α rays, 35
- Whiddington
 characteristic X rays, 85
 variation of absorption of β rays with speed, 239
 retardation of cathode rays, 244
 velocity of electron to excite characteristic rays, 292
- Wiechert
 velocity of cathode rays, 79
 pulse theory of X rays, 83
- Wiedemann
 thermo-luminescence due to β rays, 305
- Wiedemann and Schmidt
 thermo-luminescence, 304
- Wien
 canal rays, 81
 charge carried by β rays of radium, 201
- Wigger
 absorption of γ rays, 259
- Willemite
 luminosity of, 298
 decay of luminosity of, 300, 301
- Willows and Peck
 effect of radium rays on spark, 322
- Wilson (C. T. R.)
 condensation of water on ions, 47 *et seq.*
 difference between positive and negative ions, 49
 electroscopes constructed by, 92
 tilted electroscopes, 95
 detection of single α particle, 134
 natural ionisation of air, 591, 624
 variation of natural ionisation with pressure and nature of gas, 592
 activity of rain and snow, 627
 record of trails of α and β particles, 663
- Wilson (H. A.)
 measurement of charge on ion, 51
- Wilson (W.)
 exponential law of absorption of β rays, 211
 absorption of homogeneous β rays, 235
 retardation of β rays in traversing matter, 241
 variation of ionisation of β particles with speed, 248
 velocity distribution of β rays, 251
 variation of absorption of γ rays with temperature, 293
 variation of ionisation of γ rays with pressure, 293
 thorium emanation in atmosphere, 626
- Wilson (W.) and Gray (J. A.)
 complex nature of β rays from radium E, 238
- Wilson (W.) and Kovarik
 variation of scattering of β rays with velocity, 217
- Wolf, Hofmann and Gonder
 constituents of radio-lead, 510
- Wolf and Hofmann
 concentration of radium D, 511
- Wood (R. W.)
 duration of scintillations, 300
- Wood and Campbell
see Campbell and Wood
- Wright
 rate of leak of screened electroscopes, 594
 absence of penetrating radiation over water, 636
- Wright and Simpson
see Simpson and Wright
- Wulf
 quartz fibre electroscopes, 96
 variation of penetrating radiation with altitude, 636
- Zeeman
 effect of magnetic field on spectrum lines, 80
- Zeleny
 mobility of ions, 42, 44
 potential gradient, 65
- Zinc sulphide
 scintillating property of, 297
 duration of scintillations in, 300
 effect of continued bombardment on, 300
 theory of decay of luminosity of, 301
- Zircon
 amount of helium and radium in, 566

*

Cambridge :

PRINTED BY JOHN CLAY, M.A.

AT THE UNIVERSITY PRESS.

*

