

THE GEORGE FISHER BAKER
NON-RESIDENT LECTURESHIP IN CHEMISTRY
AT CORNELL UNIVERSITY

CHEMICAL KINETICS

BY

FARRINGTON DANIELS

THE GEORGE FISHER BAKER
NON-RESIDENT LECTURESHIP IN CHEMISTRY
AT CORNELL UNIVERSITY

Chemical Kinetics

BY
FARRINGTON DANIELS,

*Professor of Chemistry in the
University of Wisconsin*



ITHACA · NEW YORK
CORNELL UNIVERSITY PRESS
LONDON: HUMPHREY MILFORD
OXFORD UNIVERSITY PRESS
1938

COPYRIGHT 1938 BY
CORNELL UNIVERSITY

PRINTED IN THE UNITED STATES OF AMERICA
The Collegiate Press
GEORGE BANTA PUBLISHING COMPANY, MENASHA, WISCONSIN

PREFACE

THIS book is based on lectures delivered at Cornell University under the George Fisher Baker Non-Resident Lectureship in Chemistry from February to June 1935. So rapidly is our understanding of Chemical Kinetics changing that it has been necessary to include additional material up to the time of the completion of the manuscript in 1937.

I appreciate the opportunity accorded me by the George Fisher Baker Fund. This lectureship, established a decade ago, has enabled Cornell to do much for Chemistry in America. It has brought the stimulus of foreign chemists to us and it is now leading in a much needed visitation of professors among our own universities. Wisconsin University and Cornell University have much in common. I am glad to have had the privilege of telling each about the other.

Particularly I wish to thank Professor J. Papish and all the members of the chemistry department for their cordial hospitality during our pleasant visit in Ithaca.

FARRINGTON DANIELS

Madison, Wisconsin,
October, 1936.

CONTENTS

I.	INTRODUCTION	1
II.	GENERAL PRINCIPLES	8
	Order of reaction	8
	Specific reaction rate	14
	Chemical equilibrium	15
	The Arrhenius equation	18
	The kinetic theory of gases	24
	Complicated reactions	27
III.	THEORIES OF UNIMOLECULAR REACTIONS	31
	The radiation hypothesis	31
	The collision hypothesis	37
	Chain reactions	44
	Free radicals	49
IV.	GAS PHASE REACTIONS	56
	Experimental technique	57
	The decomposition of nitrogen pentoxide	60
	The decomposition of ethyl bromide	72
	Literature	86
V.	CHEMICAL KINETICS OF REACTIONS IN SOLUTION	90
	Collision frequency	91
	Comparison between reactions in gas and in solution	93
	Solvation	96
	The decomposition of nitrogen pentoxide	100
	The decomposition of chloroacetate ion	107
	Ionic reactions	110
	The decomposition of ammonium amalgam	114
VI.	PHOTOCHEMISTRY	117
	Photochemical principles	118
	Absorption of radiation	120
	Photochemical kinetics	124
	Experimental technique	127
	Quantum yield	135
	The photolysis of nitrogen oxides: N_2O_3 , N_2O_4 and NO_2	137
	The photolysis of acetone	147
	The photobromination of cinnamic acid	157
	The photolysis of beta-caryophyllene nitrosite	167
	The formation of vitamin D	169
	Photosynthesis by chlorophyll	172
	Literature	176
VII.	ELECTRICAL ACTIVATION	181
	Electrical discharges in gases	182
	Chemical reactions in electrical discharges	185
	Chemical effects of alpha particles	188
	Chemical effects of cathode rays	191
	Chemical effects of X-rays	195
	Chemical effects of low voltage electrons	198
VIII.	INFRARED SPECTROSCOPY	201
	Experimental technique	202

	Ethyl bromide.....	204
	Acetic acid.....	214
	Theoretical considerations.....	216
IX.	THEORETICAL CALCULATION OF ACTIVATION ENERGIES.....	220
	Energy and interatomic distance.....	222
	The semi-empirical method. The bromination of ethylene.....	227
	Chemical applications.....	234
	The statistical mechanical method.....	239
X.	ISOTOPIC TRACERS.....	244
	Isotopic carbon.....	245
	Literature.....	257
INDEX.....		263

CHAPTER I

INTRODUCTION

ACCORDING to the announcement of the Department of Chemistry of Cornell University, I am "to present the most recent advancements and the results of my own investigations in the field." I shall try to do this in chemical kinetics, and, in describing my researches and those of others, I shall try to illustrate current theories and to give glimpses of present frontiers. It is my hope that interest in the subject will not be confined to physical chemists alone, for important applications are waiting in many fields. With this in mind I shall endeavor to make the discussions rather elementary.

In these lectures the author has a special privilege for he need not "address himself only to experts in the field," and he is not handicapped by the limitations of space which are necessary in technical journals. Moreover, he is not only permitted but expected to talk chiefly about his own work.

Chemical kinetics deals with the speed and mechanisms of chemical reactions. It is a recent development in chemistry and a difficult one—one in which it is easy to raise more questions than answers. It is more difficult than the prediction of chemical equilibria and the applications of thermodynamics, for these are concerned merely with the initial and final states and not with time nor with intermediate steps.

At the close of these lectures you will realize that in chemical kinetics we have a very complex field, in which we have not as yet established many exact laws nor simple generalizations, but you will realize also that it is a field full of opportunity for pioneer work. For this reason it is an intriguing field of research.

The prediction of reaction rates is a matter of practical importance as well as theoretical interest. This is particularly true in organic chemistry where reactions are slow and many possible reactions are competing for the available material. That reaction

which goes fastest will produce the greatest yield. An ability to predict reaction rates enables an investigator to suppress undesired reactions just as a gardener eliminates weeds. At the present time the organic chemist does this empirically, but in the future we expect that chemical kinetics will provide a more certain approach.

Looking at chemical kinetics from an historical viewpoint we find that the mass law proposed in 1867 by Guldberg and Waage was the first fundamental contribution to theory. According to this law, now thoroughly established by experiment, the speed of a chemical reaction is proportional to the active masses of the reacting substances, and, as a first approximation, concentrations may be substituted for the active masses. One of the earliest experimental researches in this field was that of Harcourt and Essen in 1880 on the reaction between oxalic acid and potassium permanganate. The several factors involved in this complex reaction were varied, one at a time, and the speed of the reaction was measured experimentally.

In the beginnings of classical physical chemistry, starting with the publication of the *Zeitschrift für Physikalische Chemie* in 1887, we find the problem of chemical kinetics being attacked in earnest. Ostwald found that the speed of inversion of cane sugar (catalyzed by acids) could be represented by a simple mathematical equation, the so-called "compound interest law." Nernst and others measured accurately the rates of several reactions and expressed them mathematically as first order or second order reactions. Arrhenius made a very important contribution to our knowledge of the influence of temperature on chemical reactions. His empirical equation forms the foundation of much of the theory of chemical kinetics which will be discussed in the following chapter.

Following the period of early exploration and experimental measurement came three decades in which reaction rates in solution were studied and classified. A tremendous amount of semi-quantitative work of an empirical nature has been accumulated, especially in the field of organic chemistry. Many useful generalizations have been drawn from these experimental investigations but the progress of chemical kinetics suffered for lack of stimulating hypotheses.

The radiation hypothesis in 1918, wrong though it was, ushered in a period of stimulating theoretical approaches which have done

much to advance our understanding of the subject. In fact the attack along theoretical lines has now progressed so rapidly that confusion exists and the weakest link in the chain of development now seems to lie in the determination of exact experimental facts regarding significant, simple reactions.

It is one of my tasks to evaluate critically with you the many hypotheses, designed to correlate facts and predict behavior, which are now springing up all over the field of chemical kinetics. The answer to the riddle of chemical action is not simple and the situation is rapidly becoming more complicated rather than less complicated, but there is no reason to be pessimistic. The progress of chemistry, or any science, may be pictured as a cooperative program between the fact finders and the generalizers and it will be unfortunate for the next generation of students if the fact finders get too far ahead of the generalizers. There are already enough isolated facts to remember. But it will be just as unfortunate if the theorists get too far ahead.

In attacking the problem of the mechanism and speed of chemical reaction I have followed several different lines of research each of which will be described in one of the following chapters.¹

The study of reactions in gases constitutes the simplest approach from a theoretical standpoint, and it is here that much help can be obtained from the kinetic theory of gases as developed by mathematical physics. Many of the interesting gases are corrosive in nature so that it has been necessary to avoid experimental pitfalls such as stopcock grease, rubber tubing and mercury surfaces. Elimination of these standard laboratory tools has forced us to adopt an all-glass technique in nearly all branches of the work. The decompositions of nitrogen pentoxide and of ethyl bromide constitute the principal work which I will describe in the chemical kinetics of gas reactions.

Reactions in solution are more difficult from a theoretical, but easier from an experimental standpoint. From a practical standpoint they are vastly more important than gas reactions because the large majority of reactions in chemistry and biology occur in solutions. The field, however, is so enormous that we shall not go into it extensively and we shall exclude from consideration the

¹ I wish to express at this time my appreciation for the substantial support which I have received for my research program from the Wisconsin Alumni Research Foundation and from Charles S. Slichter, Dean Emeritus of the Graduate School of the University of Wisconsin.

large amount of material on aqueous solutions. We shall be concerned chiefly with non-aqueous solutions and their correlation with gas-phase reactions, particularly with solutions of nitrogen pentoxide and the chloroacetates, and with amalgams.

The activation of molecules is the fundamental problem in the theory of chemical kinetics and any means of producing activation is worthy of special study. Photochemical kinetics thus becomes an important subject and more time will be devoted to it than to the other branches of kinetics. The chief objective in our photochemical work has been to determine accurately the number of molecules reacting for each quantum of radiation absorbed and to deduce mechanisms consistent with this value. This ratio gives a direct measure of the number of molecules involved in a particular activation. In chain reactions this ratio permits a calculation of the so-called "chain length." It has been necessary to develop special apparatus, large monochromators, large-area thermopiles and capillary lamps of great intensity. In this way it is usually possible to obtain sufficient energy of known intensity, over a narrow range of frequencies, to give a measurable reaction in a reasonable time. The photodecomposition of the nitrogen oxides, the photodecomposition of acetone and the photobromination of double-bond carbon compounds have been chosen for special consideration; the first because it is directly connected with our work in other branches of kinetics, the second because it is a simple reaction characteristic of organic chemistry, and the third because the energy of activation lends itself to comparatively simple mathematical calculation and because it is a good example of a chain reaction. In addition, some more complicated reactions of special interest have been included.

Molecules may be activated not only by molecular collisions and by light quanta but also by bombardment with electrons or ions. We are interested here in finding the relation between the number of units involved and the number of molecules reacting. The effect of varying voltage is interesting; it is in a way similar to changing the frequency of light in photochemical reactions. Two types of apparatus are employed, the first a simple electrical discharge for qualitative work, and second the more complicated cathode ray tube which discharges electrons at high velocity into a gaseous or liquid system. Here we have studied particularly the formation of ozone and the decomposition of the nitrogen oxides.

Infrared absorption spectra give information regarding the vibrations of atoms within molecules and, accordingly, they are of significance in chemical kinetics. When atoms vibrate with sufficient amplitude the molecule disrupts. Any information regarding these vibrations should be of value in interpreting the mechanisms of disruption. The exact mathematical description of such a situation is more difficult. We should like to know, particularly, to what extent we can associate definite bands in the absorption spectrum with definite bonds in the chemical molecule. Some physicists insist that the spectrum of the molecule, strictly speaking, is a function of the whole molecule and that attempts to assign definite bands to definite bonds are not significant. In answer to these criticisms one can simply use the individuality of chemical bonds as an approximation and point to the epoch-making successes of the organic chemist who speaks of them with complete confidence. The infrared spectra discussed in a later chapter are chiefly those of the nitrogen oxides, the ethyl halides and acetic acid. The fundamental vibration frequencies, determined from infrared measurements, are used in calculating activation energies and equilibrium constants by the methods of statistical mechanics.

The next branch of chemical kinetics which I will discuss illustrates the usefulness of the mathematical calculations of quantum mechanics. In the presentation of this material I shall refer largely to the pioneer work of my former associate, Professor Henry Eyring and to the work of one of his former students, Dr. Albert Sherman who has been associated with me in chemical kinetics at the University of Wisconsin. Based only in part on rigorous derivations and relying in part on bold approximations and empirical rules, these calculations are nevertheless of great utility in predicting reaction rates and in deciding between different mechanisms. Frequently the fundamental constants and the approximations involved do not permit the calculation of absolute rates with accuracy, but the *relative* rates of two or more reactions can often be calculated with useful accuracy. Sometimes it is sufficient for the purpose at hand to show that one reaction is so slow in comparison with another (perhaps one per cent or less) that it may be entirely neglected—and calculations of this type can often be made quite easily. At first sight the solutions of the equations involved in these calculations appear to be hopeless, because they involve equations sometimes running up to fourteenth order. But various

devices for simplification and approximation have been worked out and, although they involve much routine computation, they are not at all impractical. Moreover, if the fundamental equations are taken for granted, the problems may be solved without full knowledge of higher mathematics.

The newest and most fruitful tool available in chemical kinetics at the present moment is the isotopic tracer. Fifty years ago an organic chemist idly dreamed of unraveling some of the mysteries of chemical reaction by tying red and blue ribbons to the individual atoms and seeing where they went. When radio-activity was discovered this dream was realized and radioactive lead and bismuth and isotopes of several of the heavy elements were followed in various physical and chemical operations by means of their radio-activity, determined with an ionization chamber and electrometer. This subject of the radio-indicators has been fully discussed by two of my predecessors on this lectureship. Only recently have we thought of the possibility of using light elements in this way. Two marvelous and unexpected developments are responsible for these new techniques. The production of artificial radio-activity in ordinary light elements has given us marked atoms which we can follow quantitatively by means of a highly sensitive ionization chamber. The concentration and isolation of deuterium has given us marked atoms of hydrogen as a comparatively inexpensive laboratory reagent so that we can trace them through chemical reactions and physical processes with a common laboratory technique—merely by measuring the density of water with high precision. I have had little laboratory experience with radioactive atoms or with deuterium but I would like to present my preliminary attempts to concentrate and measure the heavier isotope of carbon (C^{13}). Carbon is of great importance among the elements and an ability to mark carbon atoms and trace them through the reactions of organic chemistry and through biochemical processes would be thrilling. For example, plants grown in an atmosphere of heavier carbon dioxide would provide tracers to various parts of animals fed on them. Carbon laid down in different geological ages might have different isotopic ratios, for a considerable amount of carbon dioxide has gone out of circulation since the world began. Many hypotheses of organic chemistry could be established or discarded on the basis of carbon "tracer" experiments.

Of course the separation of the carbon isotopes, C^{12} and C^{13} , is much more difficult than the separation of the isotopes of hydrogen, H^1 and H^2 , but calculations, which I will give later, show that it should be possible to effect by chemical means a concentration sufficient for use in chemical kinetics as "tracer experiments." If material containing carbon can be reduced to one per cent of its original quantity by the breaking of a carbon-carbon bond at room temperature the concentration of C^{13} should increase from its normal ratio of one per cent up to 1.25 per cent. At this concentration it may be possible to follow the course of a carbon atom by density measurements. Since the limiting factor is the precision of the analytical methods, I have spent much time in developing a balance capable of measuring the relative density of carbon dioxide gas with an accuracy of one or two parts in a million.

The breaking of a carbon-carbon bond at room temperature seems, at first sight, very unlikely, but perhaps it can be effected by fractional electrolysis or fractional fermentation. Enrichment of the heavier isotope may be realized even at higher temperatures although the process is less effective, and it is possible that some geological process or some manufacturing operation of industrial chemistry may have provided material with a slightly increased concentration of the heavier isotope. Low temperature reactions would be much the best but they are rare. Possibly certain photochemical reactions of the right type may be effective at the temperature of solid carbon dioxide.

CHAPTER II

GENERAL PRINCIPLES

AS ALREADY stated, chemical kinetics is concerned with the speed and mechanism of chemical reactions. No complete generalization can be made regarding mechanism because there are so many different types; but the mass law, according to which the speed of a chemical reaction is proportional to the active masses of the reacting material, still remains the fundamental generalization regarding the speed. If the effective concentrations of all the materials involved in the reaction are known at all times during the course of the reaction, we have a complete description of the course of the reaction. In some cases we can describe the whole process by simple mathematical formulas. Occasionally we can draw important conclusions regarding the type and "order" of the reaction from these mathematical formulas. More often, it is not possible nor convenient to determine the concentrations of all the reacting materials over the course of the whole reaction and various short cuts have been adopted. Some of these short cuts are perfectly satisfactory but others have introduced confusion into the situation. The percentage conversion at a definite time or the "period of half life" are often satisfactory for comparison purposes. The temperature at which appreciable reaction takes place is less satisfactory.

ORDER OF REACTION

In the simplest case in chemical kinetics only one substance is changing, and the rate at which it changes is at all times directly proportional to the amount of material reacting. When these conditions obtain the reaction is said to be of the "first order."

Mathematically expressed this relation is

$$-\frac{dc}{dt} = kc \quad (1)$$

where t is time in seconds, minutes or other units and c is concentration in moles per liter or in other units, and k is a constant.

On integration

$$-\log_e c = kt + \text{constant}; \text{ or } -\log c = \frac{kt}{2.303} + \text{constant} \quad (2)$$

or integrating between limits

$$k = \frac{2.303}{t_2 - t_1} \log \frac{c_1}{c_2} \quad (3)$$

where c_1 and c_2 represent the amounts of material at times t_1 and t_2 respectively. The velocity constant k , or the specific reaction rate, can be obtained from equation (1) by plotting the rate of change in concentration against the average concentration; from equation (2) by plotting the logarithm of the concentration against time and multiplying the slope of the resulting straight line by 2.303; or by substitution of concentrations at two different times into equation (3). Usually the initial concentration, c_0 , at time $t=0$ is a convenient point to use and equation (3) becomes

$$k = \frac{2.303}{t} \log \frac{c_0}{c} \quad (4)$$

TABLE I
CHANGE IN CONCENTRATION (PRESSURE IN MM.) OF NITROGEN PENTOXIDE
WITH TIME AT 45°.

Time Seconds	$c_{N_2O_5}$ mm.	Δc	$\frac{\Delta c}{\Delta t}$	$c_{av.}$	$\log c$	k (equation (3)) sec.^{-1}
0*		—	—	—		—
600	247	—	—	—	2.3927	—
1200	185	62	0.103	216	2.2672	0.000481
1800	140	45	0.075	162	2.1461	.000462
2400	105	35	0.058	122	2.0212	.000478
3000	78	27	0.045	91	1.8921	.000493
3600	58	20	0.033	68	1.7634	.000484
4200	44	14	0.023	51	1.6435	.000478
4800	33	11	0.018	38	1.5185	.000475
5400	24	9	0.015	28	1.3802	.000501
6000	18	6	0.010	21	1.2553	.000451
7200	10	8	0.007	14	1.0000	.000515
8400	5	5	0.004	7	0.6990	.000590
9600	3	2	0.002	4	0.4771	.000467
∞	0					

* The measurements cannot be started instantaneously because a short time is required for attainment of thermal equilibrium and adjustment of the manometer. Zero time as given in the table is actually a short time after the reaction flask is placed in the thermostat.

These formulas are nicely illustrated in Table I and in Figs. 1, 2 and 3 with data taken from the next following chapter on the decomposition of nitrogen pentoxide at 45° .

It is seen in Table I and Fig. 1 that the concentration, expressed as gas pressure in millimeters of mercury, decreases and approaches zero as the time increases, doing so at a decreasing rate. The average rates of decrease between two concentrations are represented by the slopes of straight lines joining the points in Fig. 1. When they are plotted against the average concentra-

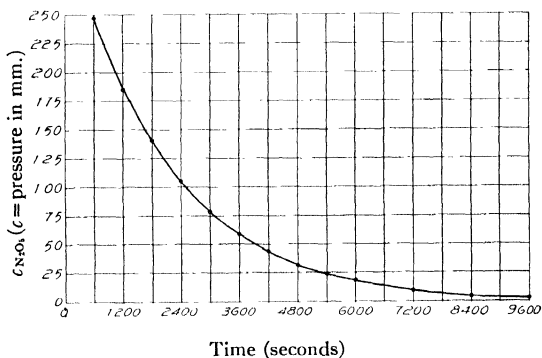

FIG. 1.—Concentration of nitrogen pentoxide plotted against time in seconds.

tions c_{av} a straight line is obtained as shown in Fig. 2. In this graph increments are used instead of differentials but the increments are sufficiently small so that the validity of equation (1) is demonstrated. The slope of the line gives at once the value of k .

When the logarithms of these concentrations are plotted against time, as in Fig. 3, a straight line is produced and when multiplied by the conversion factor for natural logarithms the value of k is obtained according to equation (3). It is seen that k obtained in these two different ways is practically the same ($0.00048 \text{ sec.}^{-1}$), and that it agrees with the value obtained by integration using equation (3) as shown in the last column of Table I.

This is a simple example of a first order reaction. Next in simplicity comes the second order reaction in which the rate of disappearance of one of the reactants is proportional not just to

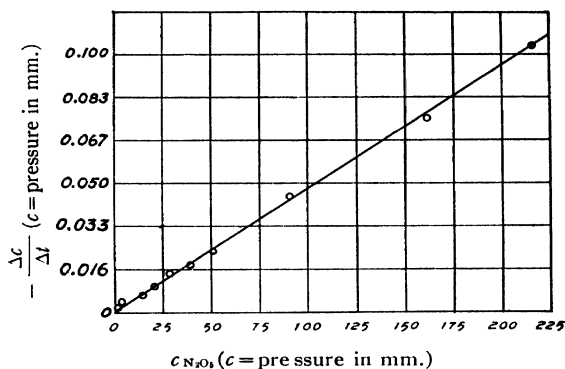

FIG. 2.—Rate of change of concentration of nitrogen pentoxide plotted against concentration.

$$\text{Slope} = \frac{0.100}{210} = 0.00048.$$

This is equal to k by equation (1).

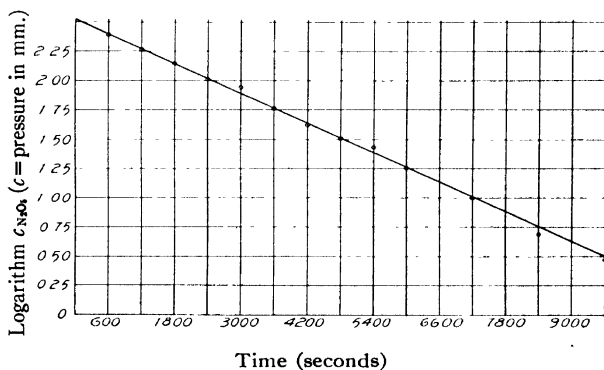

FIG. 3.—Logarithm of concentration of nitrogen pentoxide plotted against time.

$$\text{Slope of line} = \frac{-2.05}{9600} = -0.000213.$$

$$\text{Slope} \times 2.303 = -0.00048.$$

This is equal to $-k$ by equation (2).

the amount of material present but to its concentration multiplied by the concentration of a second reacting substance.

Reaction is here intimately connected with collisions between the two kinds of molecules. Mathematically expressed, when A and B react in equimolecular proportions, thus $A + B \rightarrow AB$,

$$\frac{-dc_A}{dt} = kc_Ac_B; \quad \text{and} \quad \frac{-dc_B}{dt} = kc_Ac_B. \quad (5)$$

A special case of the second order reaction arises when there is only one substance reacting, i.e. $A + A \rightarrow A_2$. When A reacts with A equation (5) becomes simplified, giving

$$\frac{-dc_A}{dt} = kc_A^2. \quad (6)$$

Integration of equation (6) between the limits c_A^0 at zero time and c_A at time t gives

$$k = \frac{1}{t} \cdot \frac{c_A^0 - c_A}{c_A^0 c_A}. \quad (7)$$

Integration of equation (6) shows also that a straight line is produced when $1/c_A$ is plotted against time. The slope of this line gives the value of k .

In the more general case, the integration of equation (5) gives

$$k = \frac{2.303}{t(c_A^0 - c_B^0)} \log \frac{c_B^0 c_A}{c_A^0 c_B} \quad (8)$$

where c_A^0 and c_B^0 are the initial concentrations of A and B at zero time, i.e. when $t=0$. In this integration $c_B = c_A + (c_B^0 - c_A^0)$.

When $\log \frac{c_A}{c_B}$ is plotted as ordinate against time a straight

line is obtained if the reaction is of the second order and the slope of this line multiplied by $\frac{2.303}{c_A^0 - c_B^0}$ gives at once the value of the specific reaction rate k .

When the rate of the reaction depends on the collision of three molecules of A, B, and C a third order reaction results

$$\frac{-dc_A}{dt} = \frac{-dc_B}{dt} = \frac{-dc_C}{dt} = kc_Ac_Bc_C. \quad (9)$$

If all the reacting molecules are alike

$$\frac{-dc_A}{dt} = kc_A^3 \quad (10)$$

and if there are but two different types, $A+2B$ or $B+2A$,

$$\frac{-dc_A}{dt} = kc_Ac_B^2; \quad \text{or} \quad \frac{-dc_B}{dt} = kc_A^2c_B \quad (11)$$

depending on whether the reaction is $A+2B$ or $2A+B$. These differential equations may be solved by standard methods of integral calculus. Third order reactions are rare because triple collisions are statistically improbable, and equations of the fourth order and higher orders do not even need to be considered.

There is one other type however, the zero order reaction, which is fairly common, particularly in photochemical reactions where the intensity of light is the limiting factor in the reaction rate, or in saturated systems where the concentration of the reacting material is automatically maintained at constant concentration as described later on page 65. The zero order reaction, in which the rate of reaction is constant and independent of concentration, is given simply by equation (12).

$$\frac{-dc}{dt} = k. \quad (12)$$

As just shown, reactions may be classed as first, second or third order reactions depending on the mathematical formula which describes their behavior. They may be classified also according to the number of molecules which take part in the reaction as written in the stoichiometrical equation for the reaction. Thus a reaction is unimolecular if only one molecule is necessary for reaction, as in the reactions



A reaction is bimolecular if two molecules are required for the reaction, thus

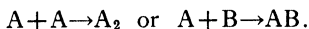

In a termolecular reaction three molecules must come together in order to give the products.

SPECIFIC REACTION RATE

It is important to understand the exact meaning of these velocity constants designated by k . In a first order reaction if k is 0.002 sec.^{-1} , for example, the material is changing at the rate of two-tenths of one per cent per second. If the value of k is small it may be said that k gives the fraction of the material at any time which will decompose during the next second. If k is expressed in reciprocal minutes its numerical value will of course be sixty times as great. In a second order reaction the numerical value of k is no longer independent of the units in which concentration is expressed. It is to be noted that in equations of the first order the units of concentration conveniently cancel out. In equations of the second order it is standard practice to express time in seconds and concentrations in moles per liter and then k may be visualized as the number of moles of A or of B reacting each second in each liter of the reaction mixture when the concentrations of A and B are both one mole per liter.

The object of the mathematical analysis is to determine the type of reaction and to evaluate the constant, k . This may be done from two experimental observations with the help of the integrated formulas. Methods will be developed later for calculating k at various temperatures, and sometimes k can be estimated even without experimental determinations. The determination of the numerical value of k is the practical goal from which useful, quantitative predictions can be made. For example, when k is known for simple reactions, the rate of reaction at any time, or the per cent conversion of material after any length of time can be calculated.

Theoretically k can be determined from any two experimental observations if the order is known but in practice a large number of observations should be used to obtain a reliable value. The accuracy obtained in experiments of chemical kinetics is usually poor—in fact these measurements are among the least accurate in physical chemistry—not so much because measuring instruments are crude but because secondary reactions and complicating phenomena are usually present. At first sight it might seem to be an easy matter to get the best value of k from several individual measurements, but the problem is not simple. The experimental errors are often greatest at the beginning of a reaction when the change is very rapid, and, in fact, the temperature of the reacting

system or the uniformity of mixture may not be satisfactory during an indefinite, initial period. Likewise, in the last stages of the reaction the change is very slight and errors in small differences become greatly magnified in the formulas.

Furthermore, in the case of formula (3) for example, it is not legitimate to add up a series of consecutive values of k and take an average because the form of the equation is such that the intermediate points cancel out leaving only the first and last values of k which are often the least accurate. This situation is illustrated in Table I on page 9, where the average of the first and last values in the last column is 0.000474, a number which is identical and equally significant with the value obtained by averaging all the values. There is much to be said in favor of getting the best values of k by graphical means from functions of the experimental data which give straight lines. This is particularly useful because, as stated before, the errors in chemical kinetics are rather large—larger than the usual errors of graphing. The best way of calculating more exact values of k from experimental data and the proper applications of the method of least squares have been discussed in detail by Roseveare¹ and by Reed and Theriault.²

The most obvious way of determining whether a reaction fits the first, second, or third order formula is to try the formulas over a wide range of data and see which formula gives a constant value of k throughout the whole course of the reaction. A determination of the type of graph which gives a straight line is another convenient method. There are various other methods such as finding the ratio of the period of half life (i.e. the time required for half of the material to decompose) to the period of three-quarter life, or the determination of the change in the rate of reaction when the initially reacting materials, are subjected, one at a time, to large increases in concentration.

CHEMICAL EQUILIBRIUM

Chemical kinetics is intimately bound up with chemical equilibrium as given in the simple formula for the reaction $aA + bB + \dots \rightleftharpoons gG + hH + \dots$

$$K = \frac{k}{k'} = \frac{c_G^g c_H^h \dots}{c_A^a c_B^b \dots} \quad (13)$$

¹ Roseveare, *J. Am. Chem. Soc.*, **53**, 1651 (1931).

² Reed and Theriault, *J. Phys. Chem.*, **35**, 673 (1931).

where the equilibrium constant K is equal to the ratio of the two velocity constants, k for the forward reaction and k' for the reverse reaction. This relation follows directly from the mass law, because the velocity constant multiplied by the effective concentrations c gives the rate of reaction, and, when the rates of the forward reaction and the reverse reaction become equal, there is no further detectable change and a dynamic equilibrium exists.

The effective concentration at equilibrium of the products divided by those of the reactants is, by definition, the equilibrium constant K . If the reaction happens to be first order in one direction and second order in the reverse, the relation still holds because the effective concentrations occur with the same exponent (e.g. a, b, g, h , etc. in equation (13)) in both rate and equilibrium formulas.

This formula is of great importance in kinetics, for frequently it is not possible to determine the rate of a given chemical change because it is too fast, or too slow, or because the measurements of concentrations can not be determined by direct experimental methods yet devised. The determination of the equilibrium constant K is usually comparatively simple and a knowledge of it and one of the velocity constants permits a ready calculation of the other by equation (13). It is surprising to realize that, except possibly in one or two cases, this important formula has not been subjected to complete experimental test, by measuring all three quantities. There is, however, no question as to the validity of the relation if the reaction proceeds in the manner indicated.

It should be emphasized that it is possible to calculate K by thermodynamic methods but that thermodynamics can not give k ; it gives only the ratio of the two k 's. Thermodynamics has nothing to do with time for it is concerned with systems in a state of equilibrium and therefore can never predict reaction rates. On the other hand when chemical kinetics reaches such a state of perfection that the two k 's can be predicted, then K can be calculated easily and we will have all that chemical thermodynamics now gives and, in addition, we will have the time factor.

It is now established that, usually, in order to react molecules must be put first into an activated state by the absorption of energy. This concept has done much to put chemical kinetics on a quantitative basis. It happens, frequently, that the energy of activation is known, or can be determined, for one of the reactions

and the heat of reaction can usually be determined from direct thermochemical data or estimated from the bond strengths (a table of energies required to break various bonds is given in Chapter IX) and then, by simple subtraction it is easy to obtain the energy of activation in the reverse reaction. According to this relation

$$q = E_A - E_B \quad (14)$$

where q is the heat of reaction and E_A is the energy required to bring the reactants A into an activated state so that they will give the products B; and E_B is the energy required to activate the products B and bring about the reverse reaction. The idea is brought out clearly by reference to Fig. 4 where energy content is represented along a vertical axis and a displacement upwards corresponds to the absorption of energy.

Another important application of this relation is covered by the statement that *in endothermic reactions* the energy of activation must be at least as great as the endothermic heat of reaction. The heat of reaction depends on the energy of activation of both the forward and the reverse reactions, but it is clear from an examination of Fig. 4 that the reactants must go over a peak of activation energy which is at a higher energy level than the products. When the reaction is exothermic the energy level of the products is lower than the energy level of the reactants and no statement can be made connecting the energy of activation with the heat of reaction. When, however, the reaction is endothermic and the products are at a higher energy level than the reactants the energy required to activate the reactants must be at least as great as the heat absorbed by the reaction. Of course it may be much greater. Even this much information is often very useful.

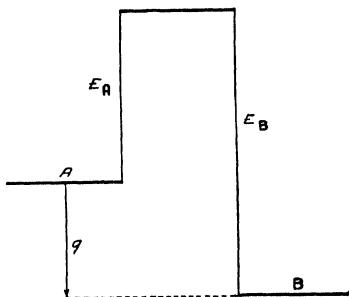

FIG. 4.—Relation between heat of reaction q and the energies of activation E_A for the reaction $A \rightarrow B$; and E_B for the reaction $B \rightarrow A$.

It is important to keep clearly in mind the distinction between heat of reaction and energy of activation, for the former is easily

calculated and sometimes used loosely for energy of activation. The lack of correlation between heats of reaction and energy of activation may be shown by two examples. The oxidation of hydrogen by oxygen evolves a great amount of heat but the reaction below the explosion temperatures is very slow (i.e. the activation energy is very large). The combination of nitrogen dioxide to give nitrogen tetroxide is only slightly exothermic and yet it goes so fast at room temperature (because the energy of activation is small) that it can not be measured by ordinary means.

THE ARRHENIUS EQUATION

Early in the development of classical chemical kinetics Arrhenius proposed a formula for describing the effect of temperature on a chemical reaction. It may be expressed as follows:

$$k = se^{-E/RT} \quad (15)$$

where k is the specific reaction rate, e is the base of natural logarithms, T is the absolute temperature, R is the gas constant, and, s and E are constants. In practical work, at least for the present, this may be considered one of the most important formulas of chemical kinetics. It expresses the facts in a surprisingly large number of reactions. Eventually it will be found to be only a part-truth—a special case of a more general and more rigorous formula. This in fact has just been pointed out by Eyring.³

The assignment of physical meanings to the constants s and E is a matter of great interest but it is fraught with difficulties. It must be emphasized that the Arrhenius formula works satisfactorily as an empirical relation, and that it is not really necessary to give a physical meaning to its terms. Since the gas constant R is expressed in energy per degree, E has the dimensions of energy and is usually given in calories. It is customary to define E as the *energy of activation*, the extra energy required to put the molecules into such a condition that they can react. Arrhenius originally thought of two different types of molecules, one active and one passive; but according to present views the difference is one of energy levels within the molecules.

The energy of activation E can be determined readily from the temperature coefficient of the reaction rate either by direct substitution into equation (15) of the value of k at two different temper-

³ Page 240.

atures, or by plotting $\log k$ against the reciprocal of the absolute temperature and multiplying the slope by 2.303 R .

The differential equation on which this relation is based is:

$$\frac{d \ln k}{dT} = \frac{E}{RT^2} \quad (16)$$

and integrating,

$$\log k = \frac{-E}{2.303RT} + \text{constant.} \quad (17)$$

This calculation is illustrated in Fig. 5 using data on the decomposition of nitrogen pentoxide (page 64). The data of Table II are obtained by interpolation and extrapolation with this formula.

The more rigorous derivation of equation (16) by statistical mechanics is given by Tolman.⁴ The energy of activation E is defined as the average energy of all the molecules which react minus the average energy of all the molecules. It represents the

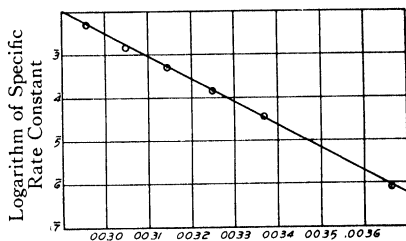

Reciprocal of Absolute Temperature

FIG. 5.—Logarithm of the specific decomposition rate of nitrogen pentoxide plotted against the reciprocal of the absolute temperature.

TABLE II
EFFECT OF TEMPERATURE ON THE DECOMPOSITION OF N_2O_5 .

Temperature	Reaction Velocity Constant	Period of Half-Life
300°	$3.1 \times 10^4 \text{ sec.}^{-1}$	0.000039 second
200	1.6×10^2	0.0039 second
150	7.7	0.088 second
125	1.2	0.56 second
100	1.5×10^{-1}	4.6 seconds
75	1.4×10^{-2}	51 seconds
50	8.7×10^{-4}	13 minutes
25	3.3×10^{-6}	5.7 hours
0	7.3×10^{-7}	11 days
-25	7.3×10^{-9}	5 years
-50	2.7×10^{-11}	830 years
-75	2.3×10^{-14}	940,000 years
-100	2.7×10^{-18}	8.4 billion years

⁴ Tolman, *Statistical Mechanics with Applications to Physics and Chemistry*, The Chemical Catalog Co. New York (1927), p. 260.

extra energy which must be introduced to bring about reaction at a given temperature. Some workers prefer to consider the total amount of energy which is required to make the molecules react, i.e., the excess of energy over what the normal molecules would have at absolute zero. This latter quantity is usually referred⁵ to as the *critical increment*. These quantities differ only by the quantity $(3/2)RT$, and at room temperature the critical increment is greater than the energy of activation by 900 calories, a quantity which can often be neglected in comparison with the large values of E which are usually encountered.

The fundamental equation of van't Hoff can be obtained easily from the Arrhenius equation. It is written as follows:

$$\frac{d \ln K}{dT} = \frac{q}{RT^2}$$

where K is the equilibrium constant and q is the heat of the chemical reaction. It has been shown that

$$K = \frac{k}{k'}, \text{ that } q = E - E', \text{ and that } \frac{d \ln k}{dT} = \frac{E}{RT^2} \text{ and } \frac{d \ln k'}{dT} = \frac{E'}{RT^2}$$

where E and E' are respectively the energy of activation of the forward and reverse reactions.

Subtracting,

$$\frac{d \ln k}{dT} - \frac{d \ln k'}{dT} = \frac{E}{RT^2} - \frac{E'}{RT^2}$$

and substituting,

$$\frac{d \ln k/k'}{dT} = \frac{d \ln K}{dT} = \frac{q}{RT^2} \quad (18)$$

It is clear that the Arrhenius equation can be used to obtain the well-established and easily proved van't Hoff equation—a fact which shows that it is not inconsistent with other experimental data.

It can be shown from considerations based on the distribution of velocities among molecules (described later on page 24) that

⁵ Kassell, *Kinetics of Homogeneous Reactions*, The Chemical Catalog Co. New York (1932), p. 98.

$e^{-E/RT}$ represents the fraction of the molecules which have the energy E or greater. Mathematically expressed

$$\frac{n^*}{n} = e^{-E/RT} \quad (19)$$

where n^* is the number of activated molecules and n is the total number of molecules.

The physical meaning of the constant s in equation (15) is less definite than the meaning of E . In bimolecular reactions, which demand a collision between two molecules before reaction can occur, s refers to the number of molecules colliding, and, as just explained, $e^{-E/RT}$ is the fraction of molecules which are activated. The rate constant, k , when expressed in the proper units, is then equal to the number of activated molecules per unit volume colliding. This assumption that every collision of an activated molecule leads to reaction is valid only in a few cases and it is necessary to put another factor, a , into the equation to allow for a steric effect of some kind. Perhaps the activated molecules have to be orientated in a definite way when they collide, in order that reaction may occur. Equation (15) then becomes

$$k = ase^{-E/RT} \quad (20)$$

but the constant a is not much less than unity, except in a few cases where it varies greatly from unity. Obviously, with more constants at one's disposal it is possible to fit experimental data better, but the significance of the formula becomes still more doubtful.

In unimolecular reactions, where the connection with collision frequency is not obvious, s is usually but not always found to have a value of about 10^{13} and this is about the frequency of vibration of atoms in a molecule as revealed by near-infra red absorption spectra. Since $e^{-E/RT}$ is merely a number, s has the same dimensions as k , namely, a number per second. If it is desired to visualize the factor s , it may be considered roughly as the vibration frequency of an atom in a molecule. After a molecule receives sufficient energy for activation it may disrupt at a given bond, but it can not do this in less time than the normal frequency of vibration of the atoms at this bond. A more complete but more complicated conception of s will be given later.

It is essential that a student of chemical kinetics have a comprehension of the magnitude of activation energies and reaction rates at various temperatures. Accordingly, in this section are presented tables and graphs which will enable anyone to estimate, at a glance, how fast a reaction of a given activation energy will go at a given temperature. Two sets of constants are given, one for first order and one for second order reactions.

It should be emphasized that the only reactions of practical importance in kinetics are those which proceed with measurable velocities—and require times of the order of a few seconds to a few months for measurable completion. Velocity constants from 1 to 10^{-7} sec. $^{-1}$ are all that need be considered then, although faster and slower reactions will be included in some of the tables for the sake of theoretical interest.

The period of half-life $t_{1/2}$, or the time taken for half of the material to react, is the easiest way of visualizing a velocity constant. The half-life in a first order reaction is related to the velocity constant by the following relation which is obvious from equation (4);

$$k = \frac{2.303}{t_{1/2}} \log \frac{1}{1/2} = \frac{0.693}{t_{1/2}} \quad (21)$$

Another quantity t_{av} is equally important, namely, the period of average life. It can be defined as the period of total life of all the molecules divided by the number of molecules and it follows from equation (1) by simple integration from zero time to infinite time, thus

$$t_{av} = \frac{1}{c_0} \int_0^{\infty} c dt = \frac{1}{k} \quad (22)$$

where c_0 is the number of molecules at time $t=0$, and c is the number at time t .

Still another way of visualizing $1/k$ is to consider it as the time required for sixty-three per cent of the material present at any time to decompose, thus

$$k = \frac{2.303}{t_{0.63}} \log \frac{1}{0.37} = \frac{2.303}{t_{0.63}} \times 0.43 = \frac{1}{t_{0.63}} \quad (23)$$

For the approximate purpose of these tables, it makes little difference whether one considers the time required for fifty per cent

or sixty-three per cent reaction and the latter leads to simpler mathematical computations.

In Table III the periods of half-life and sixty-three per cent life are given for a first order reaction in seconds and in larger units of time for various practical values of k .

TABLE III
VELOCITY OF FIRST ORDER REACTIONS

$k = 10$	1	10^{-1}	10^{-2}	10^{-3}	10^{-4}	10^{-5}	10^{-6}	10^{-7} sec. ⁻¹
$t_{0.63} = 10^{-1}$	1	10	10^2	10^3	10^4	10^5	10^6	10^7 sec.
$t_{1/2} = 0.069$	0.69	6.9	69	690	6900	69000	690,000	6,900,000 sec.
$t_{1/2} = 0.069$	0.69	7	1.1	11	1.9	19	8	2.6
sec.	sec.	sec.	min.	min.	hr.	hr.	days	months

k = specific reaction rate = fraction of molecules reacting per second.
 $t_{1/2}$ = period of half-life = $\ln 2/k = 0.69/k$.
 $t_{0.63}$ = time required for 63 per cent to decompose = $1/k$.

The same idea is illustrated more simply in Fig. 6 where each

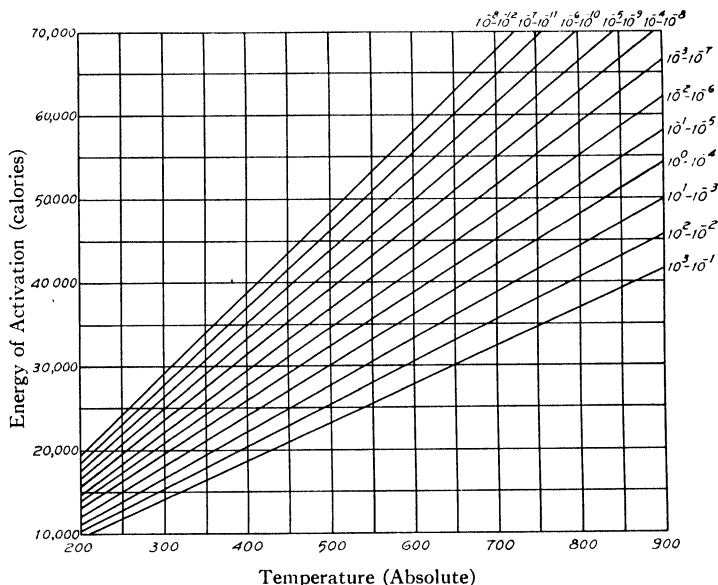

FIG. 6.—Approximate values of k at different temperatures for various energies of activation, calculated on the assumption that for first order reactions $k = 10^{13}e^{-E/RT}$ and for second order reactions $k = 10^9e^{-E/RT}$. The first order value is given first in the upper right hand corner.

line in the graph corresponds to a definite value of k at various temperatures and activation energies. Each line has two values—one for first order reactions and one for second order. In most first order reactions, s has a value of about 10^{13} independent of the units in which concentration is expressed. In many second order reactions, s has a value of about 10^9 when concentrations are expressed in moles per liter. Accordingly for a given value of E the rate constant k is about ten thousand times as great for first order reactions as for second order reactions, when the latter refers to concentrations expressed in moles per liter.

THE KINETIC THEORY OF GASES

The activation of molecules in ordinary reactions is thought to be caused by collisions between molecules. Fortunately the laws governing the collisions of molecules have been well developed in the kinetic theory of gases. The random distribution of velocities among a large number of molecules is given by the laws of probability and the following formula⁶ expresses accurately the various relationships.

$$\frac{dn}{n_0} = 4\pi \left(\frac{M}{2\pi RT} \right)^{3/2} e^{-E/RT} w^2 dw = \frac{8\pi\sqrt{M}}{(2\pi RT)^{3/2}} E e^{-E/RT} dw \quad (24)$$

where n_0 is the total number of molecules, w is the velocity and dn is the number of molecules having velocities between w and dw . The molecular weight of the gas is designated by M and for nitrogen pentoxide with a molecular weight of 108 equation (24) reduces to

$$\frac{dn}{n_0} = \frac{2.19 \times 10^{-11} E e^{-E/RT} dw}{T\sqrt{T}}. \quad (25)$$

E is the energy expressed in calories per mole. It is calculated from the velocity w expressed in meters per second by the relation $E = 0.0129 w^2$. The quantity $e^{-E/RT}$ is defined on page 21 as the fraction of the molecules which have an energy of E calories per mole or greater (i.e. from E to infinity). The fraction of the molecules dn/n_0 having velocities between w and $w + 0.01$ as calculated by equation (23) is recorded in Table IV for various velocities and temperatures. They are shown graphically in Fig. 7 where dn/n_0 is given in per cent. In Table IV, w is expressed in meters per

⁶ Taylor, *Treatise on Physical Chemistry*. D. van Nostrand Co., New York, N. Y. 1931. p. 107.

second, E in calories per mole, and dn/n_0 has the following values $4.21 \times 10^{-15} E e^{-E/RT}$ at 300° ; $4.02 \times 10^{-15} E e^{-E/RT}$ at 310° ; $2.74 \times 10^{-15} E e^{-E/RT}$ at 400° ; and $1.96 \times 10^{-15} E e^{-E/RT}$ at 500°A .

TABLE IV
*DISTRIBUTION OF ENERGY AMONG MOLECULES OF NITROGEN PENTOXIDE

w	E	$T = 300^\circ \text{A}$.		$T = 310^\circ \text{A}$.	
		$e^{-E/RT}$	$\frac{dn}{n_0}$	$e^{-E/RT}$	$\frac{dn}{n_0}$
25	8.07	0.987	1.40×10^{-4}	0.987	
50	32.3	0.947	5.37×10^{-4}	0.947	
100	129	0.806	1.83×10^{-3}	0.811	1.34×10^{-4}
200	516	0.421	3.83×10^{-3}	0.433	5.15×10^{-4}
215†	595	0.369	3.87×10^{-3}		1.76×10^{-3}
219†	613			0.364	
300	1162	0.144	2.94×10^{-3}	0.153	3.78×10^{-3}
400	2065	3.14×10^{-2}	1.14×10^{-3}	3.51×10^{-2}	2.99×10^{-3}
500	3230	4.52×10^{-3}	2.56×10^{-4}	5.35×10^{-3}	1.22×10^{-3}
600	4640	4.26×10^{-4}	3.47×10^{-7}	5.42×10^{-4}	2.90×10^{-3}
800	8260	8.32×10^{-6}	1.21×10^{-9}	1.52×10^{-6}	4.22×10^{-7}
1000	12,910	4.17×10^{-10}	9.43×10^{-13}	8.42×10^{-10}	2.11×10^{-9}
1393‡	25,000	5.49×10^{-19}	2.43×10^{-21}	2.09×10^{-18}	1.83×10^{-12}
1500	29,100	5.62×10^{-22}	2.88×10^{-21}	3.16×10^{-21}	8.82×10^{-21}
2000	51,700	2.81×10^{-38}	2.55×10^{-40}	5.02×10^{-37}	1.55×10^{-23}
					4.35×10^{-39}

TABLE IV (continued)

w	E	$T = 400^\circ \text{A}$.		$T = 500^\circ \text{A}$.	
		$e^{-E/RT}$	$\frac{dn}{n_0}$	$e^{-E/RT}$	$\frac{dn}{n_0}$
25	8.07	0.990	9.20×10^{-7}	0.992	6.57×10^{-7}
50	32.3	0.960	3.55×10^{-6}	0.968	2.57×10^{-6}
100	129	0.850	1.26×10^{-5}	0.878	9.28×10^{-6}
200	516	0.523	3.10×10^{-5}	0.593	2.51×10^{-5}
248†	392	0.369	3.35×10^{-5}		
277†	987			0.369	3.00×10^{-5}
300	1162	0.232	3.09×10^{-5}	0.310	2.95×10^{-5}
400	2065	7.50×10^{-2}	1.78×10^{-5}	0.124	2.09×10^{-5}
500	3230	1.74×10^{-2}	6.43×10^{-6}	3.88×10^{-2}	1.03×10^{-4}
600	4640	2.97×10^{-3}	1.58×10^{-6}	9.28×10^{-3}	3.53×10^{-6}
800	8260	3.02×10^{-5}	2.87×10^{-8}	2.41×10^{-4}	1.64×10^{-7}
1000	12,910	9.32×10^{-8}	1.38×10^{-10}	2.29×10^{-6}	2.42×10^{-9}
1393‡	25,000	2.00×10^{-14}	5.76×10^{-17}	1.00×10^{-11}	2.06×10^{-14}
1500	29,100	1.22×10^{-18}	4.08×10^{-19}	1.66×10^{-13}	3.97×10^{-18}
2000	51,700	6.30×10^{-29}	3.73×10^{-31}	2.25×10^{-28}	9.53×10^{-28}

† These values correspond to the maxima in the distribution curves of Fig. 7.

‡ The velocity 1393 meters per second is included because it is equivalent to an energy of exactly 25,000 calories which is close to the experimentally determined activation energy of nitrogen pentoxide.

There are many interesting things to be learned from an examination of this figure and table. It will be noted that at each temperature there is a velocity which is the most probable and that there are few molecules with very low or very high velocities. Now it is only the occasional molecule of very high velocity that has enough energy to bring about activation sufficient for chemical

reaction and it is only those molecular velocities at the extreme right of Fig. 7 (plotted on a greatly enlarged scale) that have any chemical significance.

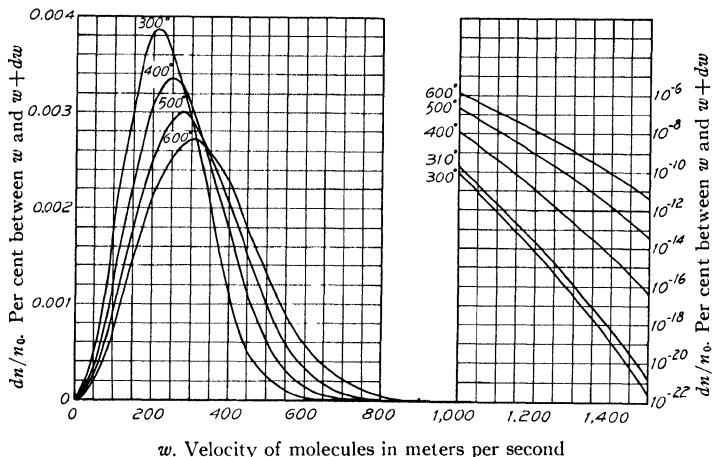

FIG. 7.—Distribution of velocities, w , in a gas (N_2O_5) at various temperatures.

The influence of temperature on this distribution of energies is important. An increase of ten degrees at 27° increases the average translational energy about $10/273 + 27$ or about 3.3 per cent but it increases greatly the number of rapidly moving molecules as seen in Table IV. It is this large effect of temperature on the number of high-velocity molecules that gives to chemical reactions their large temperature coefficient—a doubling or trebling for a change of ten degrees. The significant thing in this connection is the value of $e^{-E/RT}$ which gives the fraction of molecules having energies equal to or greater than E calories per mole. When the temperature is raised from 300° to 310° A. the fraction of molecules having energies of 25,000 or more jumps from 5.49×10^{-19} to 2.09×10^{-18} . The number of molecules having energy over 25,000 is thus increased by a factor of 3.8. This factor is in close agreement with the experimental fact that a ten degree rise at room temperature increases the decomposition rate of nitrogen pentoxide by a factor of nearly 3.8.

The fraction of activated molecules, 5.49×10^{-19} for example, seems at first sight to be utterly negligible but it must be remem-

bered that the rate expression contains another constant s which is very large. For a first order reaction s is usually about 10^{13} and in this case $k = se^{-E/RT} = 10^{13} \times 5.49 \times 10^{-19} = 5.49 \times 10^{-6}$, a value in fair agreement with the experimentally determined rate of decomposition of nitrogen pentoxide at 300°A .

COMPLICATED REACTIONS

Too often the impression is gained that chemical kinetics involves only unimolecular and bimolecular reactions and occasionally termolecular reactions. Unfortunately, the actual situation is not so simple. In fact, these clean cut reactions, giving the same order throughout the whole course of the reaction, are comparatively rare but it is from this small group that examples must be given in textbooks. Actually the ordinary laboratory or technical reaction, which proceeds at such a rate that it can be readily measured, is much more complicated. Few fit completely in these three categories. The reasons for these complications are numerous. Usually there are two or more reactions involved. The reactants may give several different products or the products may again react to give further reactions. Only when there is one single reaction being measured throughout will these simple formulas describe the facts.

An example of consecutive first order reactions is given as follows:

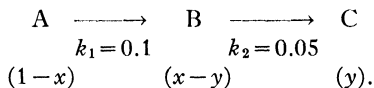

At the beginning of the reaction there is 1 mole of A per unit volume and no B nor C. Since $k=0.1$, A decomposes at the rate of 10 per cent per hour. After time t , x moles of A have decomposed into B leaving $1-x$ moles of A and producing x moles of B. But as fast as B is produced it, too, starts to decompose into the stable substance C at the rate of 5 per cent per hour. After time t , y moles of C have been produced. At time t , then, the amount of B is represented by $x-y$. It is the result of the balance between formation and decomposition.

The decomposition of A is given by the equations

$$\frac{-d(1-x)}{dt} = k_1(1-x) \quad (26)$$

$$-\int_1^{1-x} \frac{d(1-x)}{1-x} = k_1 t \quad (27)$$

$$\ln \frac{1}{1-x} = k_1 t \quad (28)$$

$$1-x = e^{-k_1 t}. \quad (29)$$

For this case where $k_1 = 0.1$, $1-x = e^{-0.1t}$.

The formation of C is given by the equations

$$\frac{dy}{dt} = k_2(x-y) \quad (30)$$

$$\frac{dy}{dt} + k_2 y = k_2(1 - e^{-k_1 t}) \quad (31)$$

$$y = \frac{k_2(1 - e^{-k_1 t}) - k_1(1 - e^{-k_2 t})}{k_2 - k_1}. \quad (32)$$

Substituting the values of k_2 and k_1

$$y = \frac{0.05(1 - e^{-0.1t}) - 0.1(1 - e^{-0.05t})}{0.05 - 0.1} \quad (33)$$

$$y = 2(1 - e^{-0.05t}) - (1 - e^{-0.1t}). \quad (34)$$

The amount of B at any time is merely the difference between x and y .

Numerical values of the amounts of A, B and C at various times as calculated from these formulas are given in Table V.

TABLE V

CONSECUTIVE REACTIONS $A \rightarrow B \rightarrow C$. AMOUNTS OF A, B AND C AT VARIOUS TIMES

Time t	Amount A $e^{-0.1t}$ or $(1-x)$	$e^{-0.05t}$	Amount C y	Amount B $x-y$
0	1.	1.	0	0
5	0.606	0.779	0.048	0.346
10	0.368	0.606	0.156	0.476
15	0.223	0.472	0.279	0.498
20	0.135	0.368	0.399	0.466
25	0.0821	0.287	0.508	0.410
30	0.0498	0.223	0.604	0.346
35	0.0302	0.173	0.684	0.286
40	0.0183	0.135	0.748	0.234
45	0.0111	0.105	0.801	0.188
50	0.00674	0.0821	0.8425	0.1508
55	0.00409	0.0635	0.8771	0.1188
60	0.00248	0.0498	0.9029	0.0946

In Fig. 8 the amounts of A, B and C at any time are given by the three curves A, B and C. A decreases exponentially as a simple first order reaction. If there were no intermediate step such as B, C would accumulate at the same rate that A decomposed. It would follow the formula $1 - e^{-0.1t}$ as given by the dotted line D. However, A decomposes first into B and the decomposition of B is slower than its formation

so that there is an accumulation of B increasing up to a maximum and then decreasing as the supply from A becomes less. The actual curve of production of C does not follow a simple law and the induction period of slow reaction is plainly evident at the beginning. If only B is being determined by chemical analysis, the reaction rate will not be easily understood since the concentration will first increase and then decrease. When the data are known for each of the contributing reactions it is easy, as shown in the table, to calculate what the sum total effect will be, but in laboratory

practise the situation is reversed and we try to find out what reaction steps and what rate constants are operating to give us our observed facts. This is a much more difficult task and frequently the differential equation can not be solved by ordinary methods. Furthermore, if a set of reaction steps is found to reproduce the facts we can not be sure that it is the only set of reactions which will account for the over-all observed rate. Excellent examples of these consecutive reactions are found among the disintegrations of the radioactive elements. Frequently the kineticist has to work out intermediate steps in this way for ordinary chemical reactions. It is always to be hoped that one

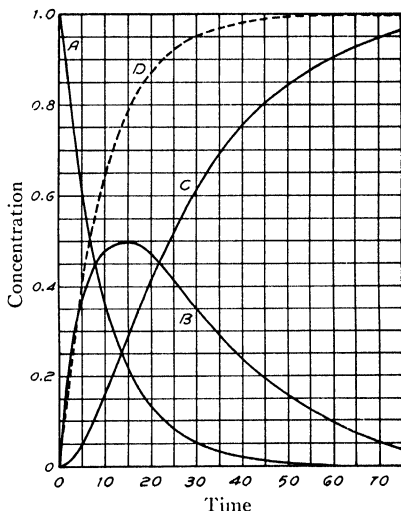

FIG. 8.—Result of consecutive reactions, when each velocity is of the same order of magnitude.

of the reaction steps will be slow in comparison with the others for then the slow reaction can be easily measured and studied by itself. When two or more of these reaction steps have rates which are of the same order of magnitude the situation is difficult.

When the materials react by several different competing reactions the over-all effect is again confusing. If reverse reactions are negligible, that reaction which goes fastest will produce most of the product and, again, it is hoped, for the sake of simplicity, that all the other competing reactions will be so slow in comparison with the principle one that they can be neglected. This is the ideal practical condition which gives a "100 per cent yield." But these situations are not common.

Again the reaction may actually reverse itself and go only partially to completion.

Often the secondary reactions are important only during part of the reaction and show up only at the end or beginning of a reaction.

In addition to all these complications of regular homogeneous reactions there are four additional enemies of simplicity which are sometimes disturbing factors—often unsuspected. They are air, moisture, light and surface walls. These will be discussed in later chapters.

CHAPTER III

THEORIES OF UNIMOLECULAR REACTIONS

IN A first order reaction the fraction of the molecules decomposing per unit of time is constant, irrespective of concentration. In other words the rate of decomposition is independent of collision. Consider, for example, molecules of a gas in a cylinder decomposing at a definite rate. Now imagine that a piston is raised and the volume doubled. The number of collisions is one-fourth as large as before and yet experiments show that if the reaction is first order the decomposition will nevertheless take place at the same rate as before.

The most natural source of energy for the activation of molecules is molecular collision, but since the rate is independent of the number of collisions it would appear at first sight that the simple collision mechanism can not be responsible for the activation. Three hypotheses have been proposed to account for the activation process: the radiation hypothesis, the elaborated collision hypothesis, and the hypothesis of chain reactions.

THE RADIATION HYPOTHESIS¹

At the outset it must be emphasized that the radiation hypothesis has been disqualified. However, dead hypotheses have a way of coming to life once in a while, and furthermore, one can often learn as much from apparent mistakes as from apparent successes.

The radiation hypothesis was proposed in an indefinite way by Perrin as early as 1913. Simultaneously, about 1918, and 1919, Perrin in France, and W. C. Mc. Lewis in England, and Trautz in Germany proposed the hypotheses which have been grouped together as the radiation hypothesis. Perrin undoubtedly had

¹ More details are given in *Chem. Rev.*, V, 39-66 (1928).

priority, but Lewis contributed most to chemical kinetics, and Trautz did more in experimental work.

The postulates of the radiation hypothesis may be summarized as follows:

- (1) Activation of molecules in chemical reaction is produced by radiation emitted from the walls of the containing vessel.
- (2) Energy of activation E is given by the relation

$$\frac{d \ln k}{dT} = \frac{E}{RT^2} .$$

- (3) The frequency of the activating radiation may be calculated from the energy of activation E by the quantum relation $E = Nh\nu$.
- (4) The relation between chemical reaction and radiation is reversible; the radiation of the activating frequency is emitted when the reaction is reversed.

According to the first postulate the cause of activation is radiation. Perrin was impressed by the fact that reaction rate in a unimolecular reaction does not depend on the collision frequency, and so he sought for some source of energy other than collisions. Radiation is a natural source to consider. Furthermore, he pointed out that the temperature coefficient of the emission of monochromatic light from a heated solid is the same as the temperature coefficient of most chemical reactions. The similarity might be coincidence, but at the time it seemed significant.

The second postulate is well established by statistical mechanics.

According to the third postulate the energy of activation may be set equal to $h\nu$ (Planck's constant \times frequency of light absorbed) in agreement with the quantum theory which has been so successful in many different fields. There is no support for this hypothesis, except the general success of the quantum theory whenever applied to radiation phenomena, and chemical activation was assumed to be a radiation phenomenon.

According to the fourth postulate radiation is emitted when the products are formed, just as radiation is absorbed when the reactants are activated. The formation and decomposition of ozone may serve as an example. It is known experimentally that ultraviolet light at 2,800 Å will decompose ozone and it is known that

light of still shorter wave length at 1,800 Å will convert oxygen into ozone. These two reactions are fully established by experiment, and it seems perfectly natural to add these two facts together and make a reversible reaction. It is well known that the reaction $3O_2 \rightleftharpoons 2O_3$ is reversible in a thermochemical sense. It does not seem much of a stretch of the imagination to make it reversible also in a photochemical sense, thus

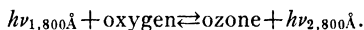

For four or five years this hypothesis was received with considerable enthusiasm, and it was hoped that a relation between chemical kinetics, black body radiation laws and absorption spectra would permit a prediction of reaction rates. However, the simple radiation hypothesis was disqualified for several reasons, as follows:

- (a) The radiation density was calculated to be insufficient.)
- (b) Discrepancies were found between calculated and observed absorption bands.
- (c) Infrared radiation was found to be chemically inactive.
- (d) Experiments with cold walls and hot gas and with hot walls and cold gas showed that the rate of reaction doesn't depend on the temperature of the walls.

In the first place it was calculated that a rapidly reacting chemical system would require more energy than could be supplied by the black body radiation of the containing vessel, particularly if this activating radiation was confined to a narrow range of frequencies. One specific case may be cited.

A very concentrated solution of nitrogen pentoxide in carbon tetrachloride was plunged into a thermostat at 50°. A very rapid decomposition occurred, and oxygen was evolved at the rate of 1.7 cc. per second, measured at room temperature. The decomposition of a mole of nitrogen pentoxide would evolve 13,400 cc., and the activation energy required for this decomposition is 24,700 calories. Accordingly activation energy was being supplied at the rate of $(1.7/13,400) \times 24,700$ or 3.1 calories per second. The area of the walls was 18.1 sq. cm., and the maximum total radiation at 323°A is 0.015 calories per sq. cm. per second, as calculated by the Stefan-Boltzmann Law. In other words, 18.1×0.015 gives a maximum radiation of 0.27 calorie per second, whereas twelve times as much is needed to supply the energy requirements of the

reaction which actually takes place. If it were assumed that only a restricted region of the spectrum could be utilized, the case would be much worse because in these calculations the radiation at all wave lengths has been utilized.

Secondly, applying the quantum theory as in the third postulate, one should be able to calculate from the energy of activation the frequency of the monochromatic light which is bringing about the activation. In one or two cases there seemed to be a relationship between these two quantities, but it should be pointed out that the energy of activation of all unimolecular reactions which proceed at about room temperature is in the neighborhood of 20,000 to 30,000 calories, and this energy of activation corresponds to a frequency in the near infrared. Almost all molecules, except the simplest symmetrical diatomic molecules, do have absorption in the near infrared, and accordingly no particular significance can be attached to this fact. Again one case is cited in support of the incorrectness of this hypothesis.

The frequency of radiation corresponding to the 24,700 calories required for the activation of nitrogen pentoxide is 1.16μ . This is in a region where glass prisms can be used, and in a region where radiation of high intensity is available in ordinary tungsten filaments. Even a slight absorption could have been found. There is intensive absorption at 5.8μ , and attention was called² to the fact that 5.8 is exactly five times 1.16. Supporters of the radiation hypothesis hoped that there might be significance in this relationship, and thought that five photons of 5.8μ might be as effective as one photon of 1.16μ . There is no justification for this view, and the relationship of one to five is undoubtedly fortuitous.

One of the most damaging findings was the discovery that infrared radiation is not chemically active. Near infrared radiation, by the calculations of the third postulate, was supposed to be the effective radiation, but even if one could obtain this radiation in sufficient intensity it develops that no chemical reaction would result.

Perhaps the most conclusive evidence for the inactivity of infrared radiation was obtained in the case of nitrogen pentoxide.^{3,4} Nitrogen pentoxide was streamed through a bulb of quartz having

² Daniels and Johnston, *J. Am. Chem. Soc.*, **43**, 72 (1921).

³ Daniels, *J. Am. Chem. Soc.*, **48**, 607 (1926).

⁴ Taylor, *J. Am. Chem. Soc.*, **48**, 577 (1926).

thin walls, and the bulb was placed for ten minutes immediately in front of a Nernst lamp, which gave intense emission of radiation throughout the infrared. The nitrogen pentoxide and decomposition products were absorbed in sodium hydroxide, and the extent of the decomposition was determined by analysis for total acidity and for nitrite. The total energy of radiation passing through the bulb was determined calorimetrically by filling the same bulb with an aqueous solution of cupric chloride, which absorbed all the radiation longer than 0.6μ . In a typical experiment the temperature rose from 35° to 37° in two minutes, giving for a ten minute interval an absorption of radiation averaging 1,350 calories. The intensity of radiant energy was determined throughout the spectrum with an infrared spectrometer and plotted against the wave length. The percentage of light absorbed by the nitrogen pentoxide was also plotted at the different wave lengths. The area of absorption divided by the total area under the curve gave the percentage of the total radiation which was absorbed by the nitrogen pentoxide. Actually 2.5 cc. of 0.01 N potassium permanganate was sufficient to titrate the nitrogen pentoxide decomposed, whereas 440 cc. should have been consumed if all the infrared energy absorbed had been photochemically active. The slight amount of decomposition, corresponding to 2.5 cc., is readily accounted for by the thermal decomposition. Additional experiments confirmed the conclusion that infrared radiation will not decompose nitrogen pentoxide unless the heat absorbed raises the temperature sufficiently to bring about a normal thermal decomposition. Simultaneously and independently, H. A. Taylor carried out similar experiments with nitrogen pentoxide and came to the same conclusions regarding the chemical inactivity of infrared radiation.

Other experiments were carried out also on the decomposition of carbon dioxide, the decomposition of hydrochloric acid gas and the oxidation of alcohol vapor. In no case was chemical action brought about by the absorption of an intense beam of infrared radiation. Furthermore, no case of chemical reactivity produced by longer infrared radiation has been established in the literature. Increases in reaction rates in early experiments can be traced to an increase in the temperature of the solution produced by the absorption of the heat rays. A few cases of activity of short infrared rays of 1μ and less are on record in special reactions.

Finally, chemical reaction was found in heated gases, surrounded by cold walls. This result would not be expected if the activating agent were the radiation from the containing walls. Again a single experiment will suffice.

Nitrogen pentoxide at room temperature was passed through a glass jet and mixed with a stream of air which had been heated to 200°. The experiment was carried out in an open room at 20°. The radiation density in the room was that corresponding to a black body at 20°. Nitrogen pentoxide at 20° does not decompose rapidly enough to give a detectable brown color within a period of a few minutes. In this experiment, however, the nitrogen pentoxide was decomposed instantly, giving the intense brown color of nitrogen dioxide as soon as it came into contact with the heated air. In this case the activation was produced by molecular collision and not by radiation. Two other significant experiments have been reported. Rice, Urey and Washburne⁵ passed nitrogen pentoxide at a low temperature in a fine molecular beam through a heated tube and condensed the products with liquid air. Analysis showed that there was no decomposition. The walls of the tube were so hot that if the infrared radiation emitted by them had been effective in decomposing nitrogen pentoxide, extensive decomposition would have been found. Analysis of the condensed product gave no evidence of the decomposition product of nitrogen pentoxide. Ure and Tolman⁶ amplified the experiment, making use of infrared radiation considerably longer in wave length, and yet no decomposition was obtained.

These several experiments have been sufficient to disqualify the radiation hypothesis, but objections to this disqualification can be raised.

Our knowledge of black body radiation laws is so incomplete that we cannot apply them with confidence to chemically reacting systems. All our knowledge of these radiation laws has been obtained from measuring instruments placed outside of a heated enclosure. The behavior of a chemically reacting system within the heated enclosure may be different. Again it must be realized that most reactions contain complicated intermediate steps, and the activating frequency calculated by the radiation hypothesis from the experimentally measured energy of activation may have

⁵ Rice, Urey and Washburne, *J. Am. Chem. Soc.* **50**, 2402 (1928).

⁶ Ure and Tolman, *J. Am. Chem. Soc.*, **51**, 974 (1929).

no significance for the reaction as written. The argument that monochromatic radiation cannot supply a sufficient amount of radiation to bring about the observed chemical reaction can be met with the idea that the energy of products can be returned to the reactants. There is no denying these possibilities but there seems little experimental evidence for them.

In dismissing the radiation hypothesis it is interesting to consider one hypothetical experiment.

Imagine a mass of ozone molecules in front of an opening in a high-temperature furnace. Radiation is passing from the furnace through the opening and into the mass of ozone molecules. Some of the radiation is of wave lengths around $2,800 \text{ \AA}$, so that the ozone is being decomposed photochemically. Now remove these ozone molecules from the front of the furnace, and place them inside of the furnace. Decomposition is very rapid because of the high temperature, and yet some of the decomposition must take place photochemically from the radiation at $2,800 \text{ \AA}$. It was effective outside the furnace; it must be much more effective inside the furnace. So then it appears that radiation from the walls of the containing vessel can be a factor in chemical reactions, but it is a very small factor and undoubtedly without significance for chemical kinetics. There is something very intriguing about the reversibility of radiation and chemical reactions as postulated in the radiation hypotheses. It is involved in chemiluminescence and fluorescence. The reason for the inactivity of infrared radiation will be discussed later.

COLLISION HYPOTHESIS

We have seen that the radiation hypothesis is not supported by experiment and that it can not be used to explain the fact that unimolecular reaction rates are uninfluenced by collisions. When investigators found this avenue of explanation closed they resumed consideration of the collision hypothesis. As early as 1922 Lindemann suggested that since a time interval exists between activation of a molecule and its dissociation the apparent connection between the two phenomena would ordinarily be lost. This view was received with increasing favor as the radiation hypothesis became more and more discredited. Rodebush⁷ in 1923 showed that the known facts could be explained on the basis of collisions

⁷ Rodebush, *J. Am. Chem. Soc.*, **45**, 606 (1923).

without calling on radiation. These concepts gradually acquired more quantitative expression, and led to considerable activity in the last half of the 1920's. These mathematical theories would not have been taken so seriously but for the fact that they were able to predict that the specific decomposition rate of unimolecular reactions would decrease at decreased pressures, and furthermore, they predicted the pressure at which this falling off in the velocity constant would occur and connected it with the complexity of the molecule. Agreement of these predictions with experimental fact lent considerable weight to the extended collision hypothesis.

Lindemann's suggestion was amplified in 1926 by Hinshelwood⁸ and by Fowler and Rideal.⁹ Independently and practically simultaneously Rice and Ramsperger¹⁰ proposed the fairly complete mathematical treatment for the collision theory which accounted for all the facts and predicted quantitatively the decrease in reaction velocity constant at decreased pressures. Kassel¹¹ amplified these theories still further and introduced a refinement based on the quantum theory.

The idea of the elaborated collision hypothesis can be made clear by reference to a mechanical analogy of a reservoir. Such analogies have serious limitations and are distinctly out of style in 1935, but in introducing new concepts they serve a useful, if temporary, purpose. Fig. 9 shows a reservoir of water at a given level. The water is pumped up to a higher reservoir which is connected with a large overflow pipe extending back to the original reservoir. From the bottom of the upper reservoir a small exit pipe leads to a tank at a lower level. It is clear that the rate at which the water flows from the upper reservoir into the lower tank depends on the height of the water in the tank, and if this is maintained at a constant level, the rate of discharge into the lower tank will be constant. In this particular system the constancy of discharge will be maintained, even if the lifting pump is accelerated or retarded, because any extra water pumped into the upper reservoir by accelerating the pump will simply overflow and run back into the first tank. However, if the pump is greatly reduced in speed and the overflow no longer functions, the level in the reservoir will fall. The rate of discharge in the lowermost tank will

⁸ Hinshelwood, *Proc. Roy. Soc., London*, **113A**, 230 (1926).

⁹ Fowler and Rideal, *Proc. Roy. Soc., London*, **113A**, 570 (1927).

¹⁰ O. K. Rice and Ramsperger, *J. Am. Chem. Soc.*, **49**, 1617 (1927).

¹¹ Kassel, *J. Phys. Chem.*, **32**, 1065 (1928).

decrease, and a level, corresponding to the dotted line, will be reached at which the rate of discharge does depend directly on the rate at which the pump operates.

These concepts may be transferred to gas phase reactions by imagining that the pump corresponds to the activation of molecules by collision, that the overflow pipe corresponds to the deactivation of activated molecules by collision, and that the discharge

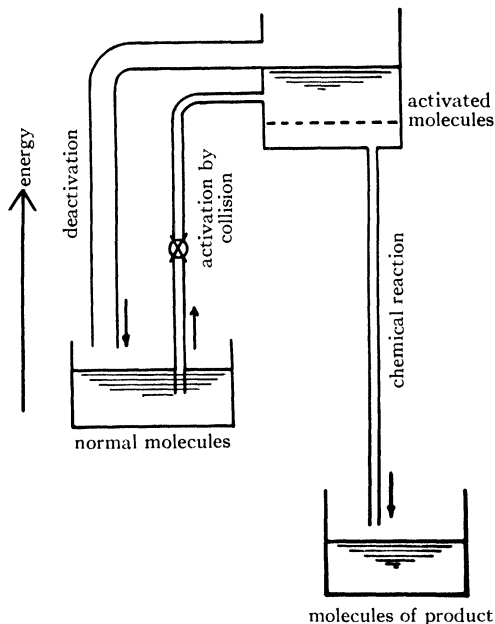

FIG. 9.—Reservoir analogy illustrating the application of the collision theory to unimolecular reactions.

pipe corresponds to the chemical reaction which the activated molecules undergo. It is clear that the number of molecules in the activated state at any time does not depend on the rate of activation, provided that the deactivation by collision is easily accomplished. There is a statistical equilibrium of activated molecules maintained by the activation and deactivation processes, and changing the rate of activation makes no appreciable difference in the number because the rate of deactivation changes also. How-

ever, the actual number of activated molecules in this steady state determines the rate of the chemical reaction, and it is thus seen that reaction rate does not depend on frequency of collision. This has been found to be the case for nitrogen pentoxide between 1,000 millimeters and 0.05 of a millimeter, and for many other decomposing gases.

Continuing the analogy, it is to be expected that when the rate of activation falls off to such an extent that the equilibrium number of activated molecules is no longer maintained, then the reaction rate must decrease. When the time between collisions is sufficiently long so that it is of the same order of magnitude as the lifetime of an excited molecule, then the specific reaction rate falls off at lower pressures and depends upon frequency of collision. After passing through a region of indefinite order as the pressure is lowered the reaction eventually becomes second order at sufficiently low pressure.

The mathematical approach to the collision theory is better. If the initial molecules are represented by A, activation is produced according the reaction

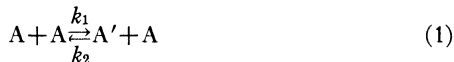

where A' is an activated molecule and k_1 and k_2 represent respectively the specific reaction rate for activation and for deactivation.

The activated molecule A' may become deactivated or it may decompose to give the products B with a specific reaction rate k_3 , thus



When a steady state is reached and the activated molecules either decompose or become deactivated as fast as they are formed, $c_{A'}$ is constant and

$$\frac{dc_{A'}}{dt} = -k_3c_{A'} - k_2c_{A'}c_A + k_1c_A^2 = 0. \quad (3)$$

Then

$$k_3c_{A'} + k_2c_Ac_{A'} = k_1c_A^2$$

and

$$c_{A'} = \frac{k_1c_A^2}{k_3 + k_2c_A}. \quad (4)$$

The rate at which B is formed from A' by the unimolecular reaction is given by the expression

$$\frac{dc_B}{dt} = k_3 c_{A'} = \frac{k_3 k_1 c_A^2}{k_3 + k_2 c_A} = \frac{k_1 c_A^2}{1 + \frac{k_2}{k_3} c_A} \quad (5)$$

When c_A is large with respect to 1, equation (5) reduces to the expression for a first order reaction which is independent of collision and

$$\frac{dc_B}{dt} = \frac{k_1 k_3}{k_2} c_A = k c_A \quad (6)$$

When c_A is very small in comparison with 1, as it is at low pressures, the term $\frac{k_2}{k_3} c_A$ may be neglected and the reaction becomes dependent on collisions and reduces to the equation for a second order reaction.

$$\frac{dc_B}{dt} = k_1 c_A^2 \quad (7)$$

Now there is experimental evidence which is in agreement, qualitatively and quantitatively, with this situation. Several gas reactions show a decrease in specific reaction rate at low pressures and change from first order to second order. When the frequency of collision is so low that the equilibrium of activated molecules is not maintained constant and the specific reaction rate, k , decreases, as already explained, it should be possible to restore the number of excited molecules by mixture with a foreign, inert gas, thereby bringing the lower velocity constant up to its normal value. There is experimental evidence that such is the case.

The more complicated the molecule, the greater is the chance that energy once received into the molecule will surge around inside the molecule before reaching a position necessary for chemical decomposition. When molecules are activated by collisions it is assumed that only a part of the kinetic energy of the moving molecule is available for activation. Each molecule contributes to the collision only that fraction of the energy which can be resolved along a straight line joining the two molecules. This system of two colliding molecules is considered to have two degrees of freedom, and in a similar way each of the plausible motions

inside of a complex molecule is considered to contribute to the absorption of energy. The picture is not very definite, but in general it may be considered that each valence bond corresponds to a degree of freedom. The more complex the molecule is, the greater is the chance for independent vibrations of atoms. This results in a greater number of degrees of freedom and a greater chance for a time-lag between activation and decomposition. This concept of increasing energy absorption with increasing complexity is familiar in the study of specific heats, and undoubtedly there is a close connection between the molar heat capacity of a gas and the number of degrees of freedom which should be used in making the calculations of the elaborated collision hypothesis. Unfortunately, there are not many accurate data on heat capacities of complicated organic molecules, and rough estimates of the degrees of freedom are made simply on the basis of the number of atoms and the number of valence bonds in the molecule.

The influence of increasing complexity of the molecule on the decomposition in a unimolecular reaction is expressed mathematically by the introduction of additional terms into the Arrhenius equation, $k = se^{-E/RT}$, as follows:

$$k = \frac{se^{-E/RT}(E/RT)^{(\frac{1}{2}n-1)}}{(\frac{1}{2}n-1)} \quad (8)$$

and in differential form

$$\frac{d \ln k}{dT} = \frac{E - (\frac{1}{2}n - 1)RT}{RT^2} \quad (9)$$

In these equations n is a number, related approximately to the number of degrees of freedom or internal vibration. It is equal to $3a - 6$ where a is the number of atoms in the molecule. On this basis nitrogen pentoxide with seven atoms should have an n value of fifteen while nitrous oxide with three atoms would have an n value of three. These formulas have been stressed particularly by Hinshelwood¹² and the English investigators. It is evident that as n increases the numerator in equation (8) increases rapidly at first, but that the larger increases are gradually diminished by the increasing value of n in the denominator.

¹² Hinshelwood, *Proc. Roy. Soc., London* **113A**, 230 (1926); *Kinetics of Chemical Change in Gaseous Systems*, Oxford University Press, Oxford (1933).

The mathematical theory of the unimolecular decomposition of complex molecules has been further elaborated by Rice and Ramsperger¹³ and by Kassel, details of which are given in his comprehensive book on *Kinetics of Homogeneous Gas Reactions*,¹⁴ The general argument follows. Molecules become activated by collision and then either react or become deactivated by collision. The rate of activation depends on the collision frequency and there is a time-lag between activation and decomposition. At equilibrium the rate of activation is equal to the rate of deactivation, which in turn is equal to the number of collisions per second made by activated molecules, because the number of activated molecules decomposing is so small at ordinary pressures compared with the number undergoing deactivation that it can be neglected. Even when equilibrium is not maintained, the rate of activation is still equal to the rate of deactivation which would exist at equilibrium and a quantitative calculation of the activation rate is thus made possible. Two theories of decomposition are possible—according to Theory I a molecule reacts as soon as it contains energy equal to or greater than the energy of activation. According to Theory II the molecule decomposes only when this energy of activation becomes localized in a particular part of the molecule—a valence bond. Moreover, the chance of localizing the energy of activation in a particular region depends on the amount of energy in excess of the minimum energy of activation.

These two different concepts lead to different mathematical expressions which can be tested with the experimental data. The derivation is similar to that of equations (1-5) but with the inclusion of a term, calculated from the Maxwell-Boltzmann distribution, for the fraction of molecules in the activated state. With these formulas it can be shown that when the reciprocal of the velocity constant is plotted against the reciprocal of the initial pressure a straight line is produced, according to Theory I, but a curved line is produced if Theory II is correct. Moreover the extent of the curvature depends on the complexity of the molecule. It is found that simple molecules like nitrous oxide give a straight line, and more complicated molecules, like azomethane, give a curved line.

¹³ O. K. Rice and Ramsperger, *J. Am. Chem. Soc.*, **49**, 1617 (1927); Ramsperger, *Chem. Rev.*, **10**, 27 (1932).

¹⁴ Kassel, *Kinetics of Homogeneous Gas Reactions*. The Chemical Catalog Co. New York. (1932). Chapters V and X.

According to another criterion, Theory I should give the same energy of activation at all pressures but according to Theory II the energy of activation should be lower at low pressures.¹³

The majority of the data seem to favor the hypothesis that in complex molecules the energy must become localized in a particular valence bond before reaction can take place. This seems to be a reasonable assumption, and furthermore, it offers a mechanism for the time-lag which is necessary between activation and decomposition. We saw that this was particularly true of the complex molecules, and, as a matter of fact, the simple molecules such as nitrous oxide are so small that there is no chance for special localization of energy.

CHAIN REACTIONS

We have seen that neither the requirements for activation energy nor the fact that the rates of unimolecular reactions are independent of collision frequency can be explained on the basis of the simple collision hypothesis or the radiation hypothesis. The elaborated collision hypothesis is able to explain them on the assumption of a time-lag in complex molecules between activation and decomposition. In this way a single molecule can collect energy from many successive collisions and store up a sufficient amount for activation. Just because a given hypothesis accounts for the facts, is no reason to consider that the hypothesis has been proved. There may be other hypotheses which will account equally well for the facts. The hypothesis of chain reaction offers a competing hypothesis which up to the present time has been increasing in favor.

A chain reaction is defined as a reaction in which the products react with the initial material, and, again, the products of this second step then react with more of the initial material, thus involving a series of reaction cycles. A series of reactions can be built up in such a way as to give an equilibrium or steady state in which the concentration of material for the rate-determining step is directly proportional to the concentration of the initial material. These are the conditions required for a unimolecular reaction. Thus we have another way of explaining the independence of reaction rates and total collision frequency.

As a simple illustration suppose that A reacts with B to give AB, and AB then undergoes either a reverse decomposition back

into A and B, or a rearrangement to give (BA)', according to the equation



The rate of formation of (BA)' depends on the amount of AB which in turn depends on the amounts of A and B. At first sight one might expect that increasing the concentrations of A and B by compressing the gas would accelerate the formation of (BA)' because the reaction between A and B is accelerated. However, it is the quantity of AB that determines the rate of formation of (BA)' and the quantity of AB depends on a steady state—a balance between formation and decomposition of AB.

Increasing the frequency of collision by compression does not affect the quantity of AB (2AB has the same volume as $A_2 + B_2$) and hence there is no effect on the rate of reaction $AB \rightarrow (BA)'$. However, the initial quantity of A and B determines the amount of AB and hence the rate of production of (BA)'. This is the criterion of a first order reaction, that the rate of reaction shall be proportional to the quantity of the initial material and yet the reaction rate is independent of collision frequency. The situation is similar to that depicted in the reservoir analogy of Fig. 9 where a steady state is reached—deactivation by collision described there being replaced in this case by chemical dissociation into the original material.

Two types of chain reaction have been proposed—stoichiometrical chains and energy chains. In stoichiometrical chains a regular chemical reaction is responsible for carrying on the chain, and actual combination takes place at collisions. These reacting substances may be molecules or fragments of molecules such as atoms or free radicals. According to the hypothesis of energy chains the molecules of the product contain an abnormal amount of energy from the reaction, which is utilized in activating more of the original material before it becomes dissipated as heat in the average increased velocity of all the molecules. The idea is applicable only to exothermic reactions. The earlier quantitative developments of the chain theory depended on this concept of energy chains, but the stoichiometrical chains are now preferred in most non-explosive reactions. In many chain reactions the idea of an energy chain or "hot-molecule chain" has now been displaced by stoichiometrical chains involving regular chemical reactions. //

In order to provide material for carrying on these chemical chains it has been necessary in many cases to assume the existence

of free radicals. There seems to be other evidence for these free radicals, and the increasing number of reactions explained in this way demands serious consideration of this point of view. However, we must not repeat the mistakes which followed the earlier hypotheses. There is no reason why nature should demand that all chemical reactions follow one particular mechanism. All the mechanisms may be possible, and they may even operate simultaneously in the same reaction.

The existence of large quantum yields in certain photochemical reactions constitutes the most direct evidence for chain reactions. The quantum yield, defined as the number of molecules reacting for each photon of radiation absorbed, will be discussed in a later chapter where the matter of photochemical chains will be presented in more detail.

The classical chain reaction in photochemistry is the combination of chlorine and hydrogen in the presence of light, a reaction which has been studied by a great many investigators. The stoichiometrical chain is represented by the following set of reactions, originally proposed by Bodenstein in 1913

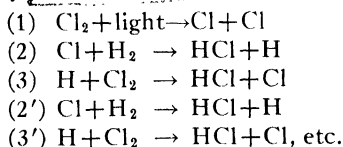

Step (2') is the same as (2) and (3') is the same as (3) and so the chain continues indefinitely.

The energy chain for the same reaction is represented by the following set of reactions proposed first by Nernst. The asterisk indicates that the molecule contains an extra amount of energy in the form of displaced electrons or displaced atoms, or in the form of abnormal translational or rotational energy.

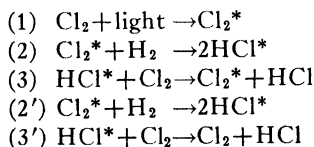

There is a large amount of evidence now favoring the stoichiometrical chain rather than the energy chain, but in spite of a great deal of work by many investigators this reaction between

hydrogen and chlorine is not yet fully understood. Other examples of chain reactions will be given later.

Chains may be initiated in a variety of ways. We have spoken of the introduction of photons. Bombardment of hydrogen-chlorine mixtures by alpha particles gives results which are very similar to the bombardment with photons.¹⁵ The temperature coefficient is practically the same in the two cases and in each case several hundred thousand molecules react for each photon or ion produced. It seems likely, then, that the mechanism of the chain is the same in the two cases and the way in which the chain is started is relatively unimportant.

Chain reactions may be started also by chemical reactions or by the introduction of atoms or of free radicals into the reacting mixture. Sodium vapor reacting with alkyl halides gives a simple type of chemical reaction which has been studied extensively by Polanyi.¹⁶ These results are easily interpretable on the basis of chain reactions initiated by atoms. Introduction of hydrogen atoms obtained by passing hydrogen gas through an electrical discharge at low pressures also initiates certain chains. In still other cases they are started by a chemical reaction taking place on the walls of the containing vessel. An example is the explosion of ozone and bromine in which an unstable bromine oxide condenses on the walls.¹⁷

The stopping of chains is a matter of theoretical interest and practical importance. If one writes a series of chemical reactions in a chain it is clear that the cycles can continue indefinitely unless stopped by some other mechanism. The carriers of the chain, atoms or free radicals, for example, can combine with each other or with some foreign material. Again, collision with the walls of the containing vessel is a sufficient reason in many cases for the breaking of the chain. In the case of energy chains it is clear that the extra energy of the hot molecules produced in the reaction can be dissipated by collision with normal molecules or by collision with the walls of the vessel. The specific effect of certain gases suggests that the theory of the stoichiometrical chains in these reactions is more applicable than the theory of energy chains.

The phenomenon of negative catalysis is one of the strong argu-

¹⁵ Porter, Bardwell and Lind, *J. Am. Chem. Soc.*, **48**, 2603 (1926).

¹⁶ Polanyi and coworkers, *Z. physik. Chem.*, **B11**, 97 (1930); **B19**, 139 (1932).

¹⁷ B. Lewis, *Chem. Rev.*, **10**, 72 (1932).

ments for the existence of chain reactions. Positive catalysis has been much studied and it is a very common phenomenon. One molecule of the catalyst can cause the decomposition of one molecule of the reactant and then, since it remains unchanged, it can continue the process with other molecules. An appreciable amount of the positive catalyst is required and it can be used over and over again. In the case of negative catalysis an unbelievably small trace of material will often greatly reduce or stop the chemical reaction.

According to one of the early hypotheses of negative catalysis a positive catalysis was thought to be operating and the negative catalyst simply destroyed the effectiveness of the positive catalyst. A poisoning effect of a surface catalyst is easily understood. In other cases this explanation did not seem at all adequate. An explanation which seems entirely satisfactory for most cases of negative catalysis involves simply the breaking of the chain reactions by a chemical combination with one of the active units in the cycle—one of the links in the chain. If the reaction is taking place through the mechanism of chain reactions and each activated molecule is responsible for the reaction of hundreds or millions of molecules, it is clear that a negative catalyst which stops the series of reactions early in the chain will produce an effect quite out of proportion with the small concentration of the negative catalyst.

One of the strongest supports for this theory of negative catalysis is found in photochemical investigations. In these cases the actual quantum yield is reduced enormously by the negative catalyst. In such cases one can see that the negative catalyst functions by breaking the chain, and it is easy to carry over this mechanism to thermal reactions. In fact, several investigations have shown that the effective inhibitors are the same for the thermochemical as for the photochemical reactions.

Explosions offer an extreme case of chain reactions. The reactions take place so rapidly that the energy of activation can never be supplied by the simple medium of collision and the Maxwell-Boltzmann distribution. These explosions are always exothermic reactions. According to the hypothesis of the energy chain this energy evolved becomes immediately available for activating more molecules.

This phenomenon differs from the ordinary, mild type of explosion where it is necessary to keep the reaction cold in order to

prevent a violent reaction. In such cases the heat of the reaction raises the temperature of the whole reacting system and when the temperature is raised the reaction goes faster; and the faster the reaction goes the more rapidly does the temperature rise, and so on until the material is consumed in a violent reaction. The explosions discussed here are not of this type, the reaction depending on molecules of product rather than on the increased temperature of the whole reacting system. There is a good deal of similarity in the two cases, but this temperature explosion is usually slower and involves a considerable time-lag while the temperature of the whole system is increasing.

Several characteristics of these gas phase explosions are interesting. There are certain pressure limits below which the explosion will not take place. One of the classical examples is the oxidation of phosphine. The size of the vessel and the pressure of the gas determine the chance that a molecule will reach the walls of the containing vessel, thereby breaking the chain. In small vessels or at low pressures the carriers of the chain will be deactivated by the walls so fast that an explosion does not occur. The whole subject of chain reactions has been discussed in great detail by Semenov¹⁸ both from a theoretical and experimental standpoint.

FREE RADICALS

The theory of reaction chains is able to account for many experimental facts in kinetics, but there is a large group of reactions, particularly in organic chemistry, which can be given a chain mechanism only if one admits the temporary existence of fragments of molecules or free radicals (CH_3 for example) which are forbidden by classical rules of valence. Any hypothesis which involved the existence of such non-conformist units would have been condemned immediately a few years ago, but at the present time the existence of free radicals is quite generally accepted. The advocacy of free radical chains as important factors in chemical kinetics has been due chiefly to F. O. Rice who has summarized this field in an interesting book.¹⁹ In evaluating this hypothesis it is first necessary to find proof for the existence of free radicals, and then to decide whether the presence of free radicals in low concentration is part

¹⁸ Semenov, *Chemical Kinetics and Chain Reactions*, Oxford University Press, Oxford (1935).

¹⁹ Rice and Rice, *The Aliphatic Free Radicals*, The Johns Hopkins Press, Baltimore (1935).

of the fundamental process or only an unimportant side issue. After establishing these facts in some reactions it is then necessary to determine whether the hypothesis is capable of explaining all the facts and finally whether it is the only hypothesis capable of so doing. These questions become increasingly difficult to answer. A brief historical sketch may be helpful.

A century ago the idea of free radicals was accepted but it was later completely discredited on the basis of the then-available experimental facts. For decades carbon was thought to have no other valence than four and a unit such as CH_3 was unthinkable. There were a few puzzling phenomena which suggested the idea of free radicals, as, for example, the production of methane by the electrolysis of acetate ions. Gomberg²⁰ broke the tradition at the beginning of the present century by establishing the independent existence of triphenylmethyl in solution. Abnormal lowerings of the freezing point of solutions of hexaphenylethane combined with lack of electrical conductivity firmly established the right of free radicals to exist. Many other free radicals of a similar nature among the aromatic compounds have been established.

The first suggestion of a free radical chain came in 1925 from H. S. Taylor²¹ who was studying the hydrogenation of ethylene photosynthesized by mercury vapor. He suggested the following reaction to account for the fact that many molecules of ethylene and hydrogen reacted for each photon of light absorbed. His mechanism was

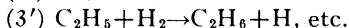
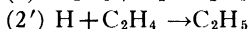
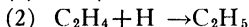
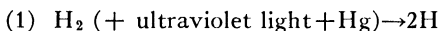

Paneth²² first demonstrated that the decomposition by heat of certain organic compounds furnished products which removed metallic mirrors of silver, tellurium and other metals from the walls of the tube. For example when vapor of lead tetraethyl was heated a silver coating on the inside of the exit tube was removed for a considerable distance. The results were interpreted to mean that ethyl radicals were liberated in the thermal decomposition and

²⁰ Gomberg, *J. Am. Chem. Soc.*, **22**, 757 (1900).

²¹ H. S. Taylor, *Trans. Faraday Soc.*, **21**, 560 (1925).

²² Paneth and Hofeditz, *Ber.*, **62**, 1335 (1929); and later publications.

that they collided with the metal coating and formed volatile compounds. The analysis of the products supported this view of the temporary existence of free radicals. F. O. Rice²³ extended the technique and calculated the time of half-life of the radicals from the distance and the rate of gas flow between the decomposing substance and the place where the mirror was removed. Extensive experiments on free radicals are summarized in his book.

Experimental evidence of the part played by free radicals in a chemical reaction was soon forthcoming. In 1934 Frey²⁴ found that butane decomposed very slowly at 525° but that if one per cent of dimethyl mercury was introduced the decomposition proceeded rapidly. In the same year Sickman and Allen²⁵ found that acetaldehyde was stable at 300° but that it was decomposed completely when a few per cent of azomethane was added. The introductions of dimethyl mercury or azomethane at these temperatures apparently liberated free radicals which initiated chains. Moreover when mixed gases decomposed simultaneously they did not do so independently. The products contained groups from each in a way that could be easily explained on the assumption of the liberation and recombination of free radicals. Again the appearance of butane from the decomposition of propane is difficult to explain on any hypothesis except on the assumption that some free radicals of CH₃ are split out and that they become attached to propane molecules. More direct examples will be given later in the discussion of photochemistry.

The most definite and indisputable evidence for the existence of free radicals is obtained from spectroscopy. Physicists are able to interpret band spectra without ambiguity on the basis of such units as OH, CN, BeCl, SiO, CH₂, C₂ and others. There is a whole host of radicals of this type which can explain quantitatively all the lines of a complex band spectrum and there is no other way to explain them. Moreover calculations based on quantum mechanics show that many of these free radicals, which violate all rules of the classical theories of valence, are stable and do not necessarily decompose at ordinary or even at moderately high temperatures. The difficulty in finding them is not that they are too unstable but rather that they are so very reactive that they combine immedi-

²³ Rice, Johnston, and Evering, *J. Am. Chem. Soc.*, **54**, 3529 (1932); and later publications.

²⁴ Frey, *Ind. Eng. Chem.*, **26**, 200 (1934).

²⁵ Sickman and Allen, *J. Am. Chem. Soc.*, **56**, 1251 (1934).

ately with almost anything with which they collide. The activation energy of reactions involving free radicals is very small.

The possible extent to which free radical chains may account for the thermal decomposition of organic molecules in the gas phase was first emphasized by Rice and Herzfeld.²⁶ They gave three examples showing how all the known facts in the decomposition of acetone, acetaldehyde and ethane could be explained by chain reactions involving free radicals. Their calculations showed that the first order character of the reaction could be maintained under proper conditions and they estimated reaction rates and temperature coefficients in agreement with the facts.

One of the simplest general schemes giving a first order reaction is as follows:

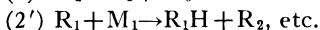
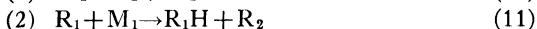

where the R's represent radicals and the M's represent molecules or radicals. The radical liberated in the first step (1) picks off a hydrogen atom from the original molecule, forming a hydrocarbon and a second radical (2), but this second radical decomposes giving a new molecule and regenerates the first radical (3) which is then ready to start the process all over again as in (1). Thus an indefinite chain is maintained. The chain is stopped, however, when the two radicals combine as in (4).



or when they strike the wall or react with some other material present possibly as an impurity.

The scheme may be illustrated more specifically with the decomposition of propane.

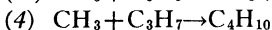
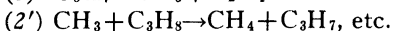
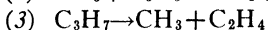
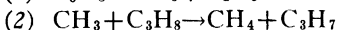
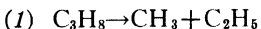

The C_2H_5 undergoes a similar series of reactions.

²⁶ Rice and Herzfeld, *J. Am. Chem. Soc.*, **56**, 286 (1934).

Returning to the general scheme it can be shown also that it is possible to obtain from it an over-all effect which results in a first order equation for the reaction rate. If a large supply of reactants is present, a steady state is reached in which

$$\frac{dc_{R_1}}{dt} = k_1c_{M_1} - k_2c_{R_1}c_{M_1} + k_3c_{R_2} - k_4c_{R_1}c_{R_2} = 0 \quad (15)$$

and

$$\frac{dc_{R_2}}{dt} = k_2c_{R_1}c_{M_1} - k_3c_{R_2} - k_4c_{R_1}c_{R_2} = 0. \quad (16)$$

By algebraic operations,²⁷ it can be shown that

$$c_{R_1} = \sqrt{\frac{k_1k_3}{2k_2k_4}}. \quad (24)$$

Substituting this value of c_{R_1} into equation (17)

$$c_{R_2} = c_{M_1} \sqrt{\frac{k_1k_2}{2k_3k_4}}. \quad (25)$$

The over-all rate of decomposition of M_1 is given by equation (26)

$$^{27} \text{ Adding (15) and (16)} \quad k_1c_{M_1} = 2k_4c_{R_1}c_{R_2} \quad (17)$$

$$\text{Then} \quad \frac{c_{R_2}}{c_{M_1}} = \frac{k_1}{2k_4c_{R_1}}. \quad (18)$$

$$\text{Dividing (15) by } c_{M_1} \quad k_1 - k_2c_{R_1} + k_3 \frac{c_{R_2}}{c_{M_1}} - k_4c_{R_1} \frac{c_{R_2}}{c_{M_1}} = 0. \quad (19)$$

$$\text{Dividing (16) by } c_{M_1} \quad k_2c_{R_1} - k_3 \frac{c_{R_2}}{c_{M_1}} - k_4c_{R_1} \frac{c_{R_2}}{c_{M_1}} = 0. \quad (20)$$

$$\text{Subtracting (20) from (19)} \quad k_1 - 2k_2c_{R_1} + 2k_3 \frac{c_{R_2}}{c_{M_1}} = 0. \quad (21)$$

$$\text{Substituting (18) into (21)} \quad k_1 - 2k_2c_{R_1} + \frac{k_1k_3}{k_4c_{R_1}} = 0. \quad (22)$$

$$\text{Multiplying (22) by } k_4c_{R_1}, \quad (k_1k_4)c_{R_1} - (2k_2k_4)c_{R_1}^2 + (k_3k_1) = 0. \quad (23)$$

$$\text{Solving (23) } c_{R_1} = \frac{k_1k_4 + \sqrt{k_1^2k_4^2 + 8k_1k_2k_3k_4}}{4k_2k_4} = \frac{k_1}{4k_2} + \sqrt{\left(\frac{1}{4} \frac{k_1}{k_2}\right)^2 + \frac{k_1k_3}{2k_2k_4}}.$$

$$\text{Assuming that } k_1 \text{ is very small, } c_{R_1} = \sqrt{\frac{k_1k_3}{2k_2k_4}}. \quad (24)$$

$$\begin{aligned} \frac{-dc_{M_1}}{dt} &= k_1c_{M_1} + k_2c_{R_1}c_{M_1} = k_1c_{M_1} \left(1 + \frac{k_2}{k_1} c_{R_1} \right) \\ &= k_1c_{M_1} \left(1 + \sqrt{\frac{k_2k_3}{2k_1k_4}} \right). \end{aligned} \quad (26)$$

If the primary step is slow compared to the rate of the over-all reaction equation (26) becomes approximately equal to the following

$$\frac{-dc_{M_1}}{dt} = k_1c_{M_1} \sqrt{\frac{k_2k_3}{2k_1k_4}} = kc_{M_1} \quad (27)$$

where k is a constant. This is the equation for a first order reaction.

The over-all rate of this reaction is determined by two factors—the rate of the primary reaction ($k_1c_{M_1}$) and the rate of the chain reaction ($k_2c_{R_1}c_{M_1}$). The chain can't start until the primary reaction starts but for each molecule reacting by the primary reaction there are many reacting by the chain mechanism. The ratio of the two gives the chain length. Thus,

$$\begin{aligned} \text{chain length} &= \frac{\text{rate by chain}}{\text{rate by primary}} = \frac{k_2c_{R_1}c_{M_1}}{k_1c_{M_1}} \\ &= \frac{k_2}{k_1} \sqrt{\frac{k_1k_3}{2k_2k_4}} = \sqrt{\frac{k_2k_3}{2k_1k_4}}. \end{aligned} \quad (28)$$

If one can estimate the values of the various k s it is possible to estimate the length of the chain. The Arrhenius equation $k = se^{-E/RT}$ is used (page 23) and in the present case the values of s for both first and second order cancel out so that from equation (28) it follows that the chain length is approximately equal to the following expression,

$$\text{chain length} \sim e^{(E_1+E_3-E_2-E_4)/2RT}. \quad (29)$$

Even rough estimates of the activation energies will give an indication of the length of the chain. In a similar manner it can be shown from equation (24) that the concentration of methyl radicals c_{R_1} is given approximately by the following expression

$$c_{R_1} = \sqrt{\frac{k_1k_3}{2k_2k_4}} = \frac{s_1}{s_2} \sqrt{\frac{k_1k_3}{2k_2k_4}} \sim 10^4 e^{(-E_1+E_3-E_2-E_4)/2RT} \quad (30)$$

where s_1 and s_2 refer to the constants in the Arrhenius equation for a second and a first order reaction, 10^{13} and 10^9 respectively.

In the actual working out of a complicated reaction by these free radical steps many approximations are necessary. At first sight these chains seem more complicated than the older mechanisms but as a matter of fact, although many steps are involved, each one is a clean-cut unimolecular or bimolecular reaction whose activation energy may be estimated and rate calculated. When the over-all reaction was neither first nor second order, and when it changed mysteriously with pressure, the older theories were powerless to express the facts. Division into more but simpler steps really facilitates the application of successful theories. Many approximations are involved in the quantitative calculations. Analogies are drawn upon, and limiting values are estimated. Rates much faster than the slow, rate-determining step are not included and if one constant is much less than another (one per cent for example) it is neglected. Activation energies are estimated from experimental data (on similar compounds if direct data are not available) or from quantum calculations (Chapter IX). Estimates of rates are made in a manner similar to those shown on pages 23 and 227. Triple collisions are rare and steps involving them can be neglected. Frequently a very complicated expression boils down to an easily usable formula by mere cancellation or algebraic simplification. Applications of some of these principles will be illustrated later but for more details the original articles should be consulted.

On the basis of the theory of free radical chains one can often predict not only reaction rates, chain lengths and orders of reaction, but nature of products and the influence of temperature and walls. In the experimental studies Rice adopts a simplifying procedure which, although somewhat unsatisfactory, is justified by its simplicity. The reaction is allowed to proceed only partially to completion—perhaps ten per cent. If it goes nearly to completion the decomposition products themselves will decompose and react so that the original reaction will be largely obscured.

CHAPTER IV

GAS PHASE REACTIONS

IN SPITE of the importance from a theoretical standpoint, very little progress was made prior to 1920 in the kinetics of gas phase reactions. Reactions in solution were much easier to study. Investigators of gas reactions had been more concerned with equilibrium measurements and with the analysis of the products than with the rate of the reactions, and there was always the obvious suspicion that the reaction was really occurring heterogeneously at the walls of the vessel and the products diffusing out into the gas space. The diffusion process, like the first order chemical reaction, depends on the concentration of material and follows equation (II-1). If the slow step being measured is the diffusion from the wall the reaction will appear to be first order, but the two can be distinguished by the temperature coefficient. The diffusion process is proportional to the absolute temperature and at room temperature a ten degree rise increases the diffusion rate about three per cent, but the rate of a chemical reaction is increased 200 or 300 per cent.

Few gas reactions are known which occur at room temperature but at high temperatures a great many are known. Practically every organic compound will decompose at moderately high temperatures and if it volatilizes first there may be a gas phase reaction. A large number of qualitative and quantitative measurements of this type of reaction have been made in organic chemistry but few exact rate measurements have been included. An excellent collection of this material is given by Hurd in his comprehensive book.¹ Further advances in chemical kinetics should lead to a better understanding of this field.

¹ Hurd, *Pyrolysis of Organic Compounds*, Chemical Catalog Co, New York (1929).

EXPERIMENTAL TECHNIQUE

The progress of a reaction can be followed by several different methods, divided principally into physical and chemical methods; and into static methods and flow methods.

The physical methods are usually best because they permit successive measurements of the whole reacting system without disturbing it. Chemical methods usually require the rapid stopping of the reaction or the removal of samples. In rapid reactions, particularly, this is a distinct objection. When there is a change in the number of molecules during a gas reaction the total pressure changes and this constitutes one of the simplest and one of the best means of measuring concentrations. Physical measurements, such as the absorption of light of a given wave length, are also useful in certain reactions. It is necessary however to supplement these tests and check their significance with direct chemical evidence. Pressure changes alone are not specific; it is therefore necessary to establish by chemical means that they are due to the reaction mechanism which is postulated. Ingenuity and considerable selection of reactions is necessary in finding ways of calculating the concentration of all the reactants and products from pressure measurements or from analysis for a single substance.

Best results are obtained by the static method, i.e., under conditions such that the reaction goes on in a single vessel and measurements are taken at suitable intervals of time; or several vessels may be filled with the reacting mixture and each one stopped at an appropriate time thus giving several points on a concentration-time curve. In the dynamic method gases are passed in a continuous stream through a furnace or other reaction vessel after which the products are removed and analyzed. The reaction time is calculated with some uncertainty from the rate of flow of gases and from the dimensions of the reaction chamber. Although a less satisfactory method it is nevertheless useful, particularly when large quantities of material are needed for analysis or when it is desired to change largely the ratios of surface to volume for investigation of the wall effect. In the study of heterogeneous reactions this method is especially important.

Many of the materials which give interesting gas phase reactions are difficult to study because they attack rubber, stop-cock grease and sometimes mercury. These three laboratory accessories

are necessary in the ordinary manipulation of gases and so, for most of the work described in these lectures, an all-glass technique has been substituted. It slows down the work greatly, and sometimes it introduces more trouble than it prevents, as, for example when the sealing of a tube decomposes the enclosed gas. In general, however, it gives more reliable results. Slight impurities, contamination with grease, sulfur from rubber, or oxygen or water from air may completely alter the conclusions of a whole research.

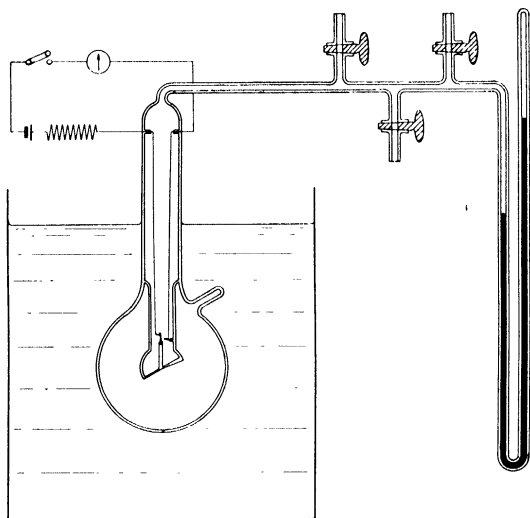

FIG. 10.—All-glass vessel for following the course of a reaction by measuring the pressure.

Corrosive gases like nitrogen pentoxide are completely sealed off in glass, and the changing pressures are measured through glass membranes² as shown in Fig. 10. The same type of reaction chamber is used also for organic substances completely immersed in a thermostated liquid of molten lead. The pressure in the vessel is counterbalanced with an external pressure of air which in turn is measured on a manometer. The point of balance of the measured air pressure is obtained by the closing of an electric circuit through a platinum wire anchored in the glass diaphragm. When the circuit

² Daniels, *J. Am. Chem. Soc.*, 50, 1115 (1928).

is closed the operator knows that the pressure in the reaction vessel is equal to the pressure read on the manometer—except for a fixed correction factor which is previously determined by filling the flask with air of known pressure and determining the pressure difference necessary to close the circuit.

These diaphragms have been used continuously in a great many of the researches to be described here. Their construction is apparent from Fig. 11. A thin bulb of pyrex glass is blown and a stout platinum wire, embedded in a small pyrex rod and suspended by a thin platinum wire (No. 36), is dropped into the bulb as shown in the second figure.

A glancing flame from a hot, quiet oxygen-gas flame flattens the bulb and anchors the wire contact. Some experience

is necessary in getting the diaphragm thick enough to withstand an atmosphere's pressure outward, and still sensitive enough to make or break contact for a pressure change of 0.1 mm. Best results are obtained when the diaphragm is thicker in one part than in another so as to give a sidewise movement. It is impossible and unnecessary to make these sensitive diaphragms so that they will withstand an atmosphere's pressure *inward*. The outer flask is always evacuated first.

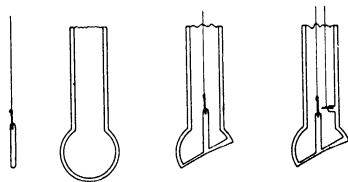

FIG. 11.—Construction of glass diaphragm for pressure measurements.

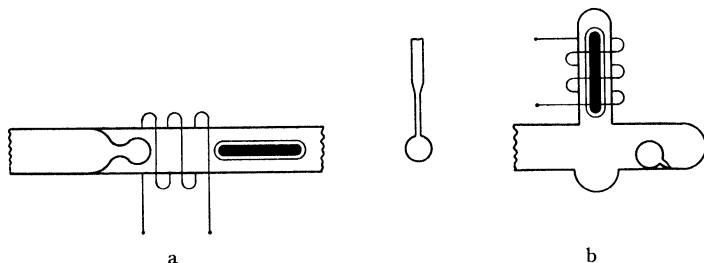

FIG. 12.—Magnetic hammer for introducing gas or weighed quantities of liquid into an all-glass system.

Into the side of the tube of the finished and tested diaphragm a second connection is made by fusing onto the inside wall a ball

of pyrex glass in which is embedded a stout platinum wire. It is lassoed and held tightly by a finer platinum wire and then it is bent so that it nearly touches the short platinum wire which is anchored to the diaphragm. A dry cell, a table galvanometer and a high resistance (radio grid-leak) complete the circuit. A vacuum pump, a stopcock, and a second stopcock fused to a capillary leak are used for adjusting the air pressure.

In Fig. 12(a) is shown a device for mixing gases in an all-glass system by breaking a thin bulb separating two adjoining compartments. An iron nail is enclosed with asbestos packing in a sealed glass tube which is sucked over with violence when a current of three to five amperes is passed through a solenoid containing several hundred feet of No. 28 copper wire. In the same way the magnetic hammer is made to break little bulblets containing a weighed quantity of liquid as shown in Fig. 12(b).

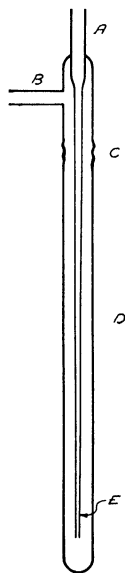

FIG. 13.—Pyrex and quartz valve for opening and closing vessels containing thermally-stable gases.

An all-glass substitute for a stopcock³ which will alternately admit a gas and then close off the connecting tube many times, is shown in Fig. 13. The inner capillary tube is of pyrex and the outer tube is of quartz, the two being connected by a quartz-to-pyrex graded seal which may be obtained at small cost from manufacturers of quartz apparatus. When a blast lamp is applied to the outer quartz tube the inner capillary is made to melt, and when the pressure inside the capillary is greater it will open; when it is less it will close. This glass valve is suitable, of course, only for thermally-stable gases.

THE DECOMPOSITION OF NITROGEN PENTOXIDE

The decomposition of nitrogen pentoxide was investigated in 1920 as a side issue involved in a study of the possibility of fixing nitrogen by the arc process. It was the first reaction to be extensively studied in connection with the theories of unimolecular reactions and it has retained a position of importance among gas phase reactions. It has since been checked by different investigators all over the world and its reproducibility is one of the satisfying things in chemical kinetics

³ Willard, *J. Am. Chem. Soc.*, **57**, 2328 (1935).

—quite different, for example, from certain chain reactions which are so sensitive to minor complications.

Nitrogen pentoxide can be made by dehydration of anhydrous nitric acid with phosphorus pentoxide and sublimation from the mixture at about 40° . Resublimation with ozone and more phosphorus pentoxide gives pure white crystals which rattle around in the reaction chamber after slight evacuation. Direct oxidation with ozone of nitrogen dioxide prepared by heating lead nitrate is a somewhat better way of making the material.

The purified nitrogen pentoxide is sealed off in apparatus like that of Fig. 10, submerged completely in a thermostat, and pressure readings are taken at frequent intervals over the whole course of the reaction.

Typical curves are shown in Fig. 14.

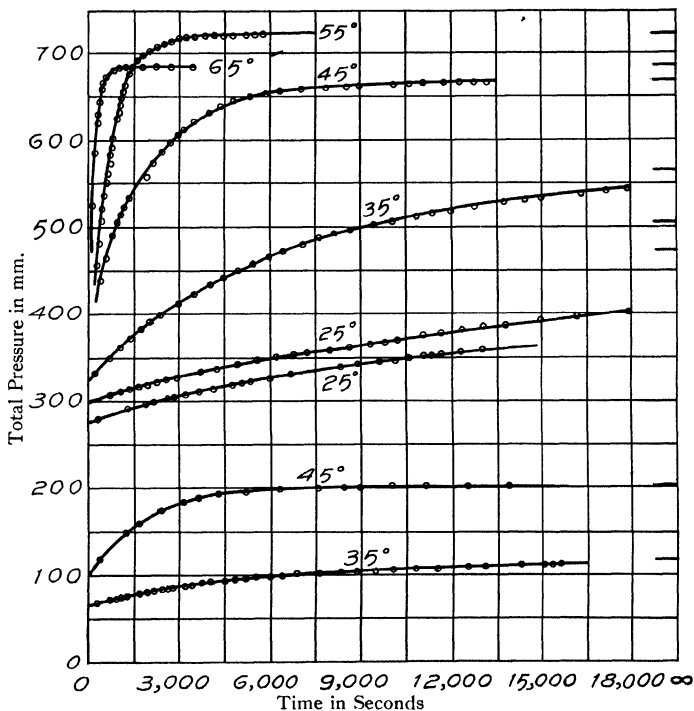

FIG. 14.—Pressure-time curves showing the decomposition of nitrogen pentoxide at various temperatures.

The concentration of nitrogen pentoxide at any time is determined from the total pressure, but the calculation is complicated by the fact that one of the decomposition products, NO_2 , undergoes association, and this equilibrium, $2\text{NO}_2 \rightleftharpoons \text{N}_2\text{O}_4$, shifts continuously as the reaction progresses and the products accumulate. It is convenient to use a graphical method of calculation.

The over-all reaction is



and
$$P_{\text{total}} = p_{\text{N}_2\text{O}_5} + p_{\text{N}_2\text{O}_4} + p_{\text{NO}_2} + p_{\text{O}_2}. \quad (2)$$

When the decomposition rate is slow the initial pressure can be obtained by extrapolating the pressure-time curve to zero time. At the higher temperatures where the reaction is rapid and temperature conditions in the early stages are doubtful, it is necessary to get the initial pressure indirectly from the final pressure. This stationary pressure is obtained when the reaction is completed. It is seen from equation (1) that the initial pressure, p_i , of pure N_2O_5 is twice the partial pressure, p_{O_2} , of the oxygen at completion, since two moles of undissociated N_2O_5 are required to give one mole of oxygen. Therefore, when α is the degree of dissociation of N_2O_4 into 2NO_2 ,

$$p_i = 2p_{\text{O}_2} \text{ (final),}$$

$$p_{\text{N}_2\text{O}_4} = 2(1 - \alpha)p_{\text{O}_2},$$

and

$$p_{\text{NO}_2} = 4\alpha p_{\text{O}_2}$$

and substituting into equation (2) for the final pressure p_f when the N_2O_5 is consumed.

$$P_{f\text{inal}} = 0 + 2(1 - \alpha)p_{\text{O}_2} + 4\alpha p_{\text{O}_2} + p_{\text{O}_2} = 3p_{\text{O}_2} + 2\alpha p_{\text{O}_2} = 3/2 p_i + \alpha p_i. \quad (3)$$

The degree of dissociation α of N_2O_4 is obtained from its dissociation constant K , and values of $P_{f\text{inal}}$ are plotted against various values of p_i so that the proper initial pressure can be picked off on a curve from any final pressure.

From a similar graph⁴ it is possible to calculate the partial pressure of nitrogen pentoxide, $p_{\text{N}_2\text{O}_5}$, at any time knowing the total pressure and the initial pressure. The pressure increase, $P_{\text{total}} - p_i$,

⁴ Details are given in *J. Am. Chem. Soc.*, **43**, 53 (1921).

is calculated for various amounts of nitrogen pentoxide decomposed, and the partial pressure of nitrogen pentoxide remaining at any time is obtained from the increase in pressure by interpolation on the curve.

Inasmuch as the reaction $N_2O_4 \rightleftharpoons 2NO_2$ is extremely rapid the over-all reaction follows the first order equation from start to finish.

A typical set of data is given in Table I, where the total pressure at definite times is given first. The values in the fourth column under p representing the amount of nitrogen pentoxide decomposed are obtained by graphical interpolation from the pressure rise $P - p_i$ as just explained. The concentration of undecomposed nitrogen pentoxide is given in the next to the last column and finally the constant is calculated by equation (3) on page 9.

Similar experiments were carried out at various temperatures and averages of the experimentally determined constants are recorded in Table II.

TABLE I
THE DECOMPOSITION OF NITROGEN PENTOXIDE AT 45°

Time seconds.	P mm.	$P - p_i$ mm.	p decomp. mm.	$p_{N_2O_5}$	k sec. ⁻¹ × 10 ⁴
0	(348.4)	(0)	0	(348.4)	
600	462	113.6	101.1	247	
1200	518.5	170.1	163.2	185	4.8
2400	585.2	236.8	243.0	105	4.7
3600	622.5	274.1	289.8	58	4.9
5400	649.1	300.7	324.0	24	4.9
7200	660.0	311.6	338.4	10	4.8
9600	665.7	317.3	345.6	3	5.2
	668.0		348.4	0	

These data were used in part in Table I and Fig. 3 of Chapter II for illustrating the calculation of a first order velocity constant.

TABLE II
SPECIFIC DECOMPOSITION RATES OF N_2O_5 AT VARIOUS TEMPERATURES

Temp.	0	25	35	45	55	65°
$k(\text{sec.}^{-1})$	7.9×10^{-7}	3.4×10^{-5}	1.3×10^{-4}	5.0×10^{-4}	1.5×10^{-3}	4.9×10^{-3}

Logarithmic graphs according to equation (II-2) for several temperatures are shown in Fig. 15. It is clear that the slopes which are a measure of k increase rapidly with the temperature.

The complete temperature effect is illustrated in Fig. 5 on page 19 where $\log k$ is plotted against $1/T$. The resulting straight line is in agreement with the Arrhenius relation (II-17).

The equation is

$$\log k = \frac{-24,700}{2.303RT} + \text{constant}. \quad (4)$$

Putting it into the exponential form and obtaining a weighted

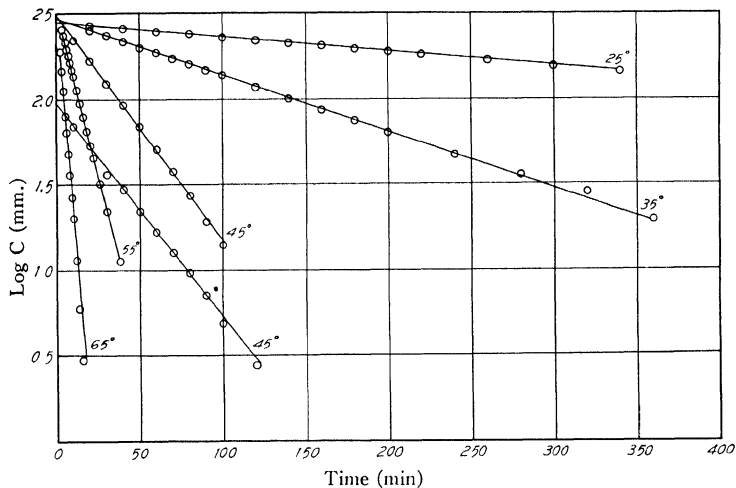

FIG. 15.—Logarithmic graphs showing the decomposition rate of nitrogen pentoxide at several temperatures.

average from these data and several subsequent ones by different authors, Kassel arrives at the formula:

$$k = 3.79 \times 10^{13} e^{-24,590/RT}. \quad (5)$$

This is a convenient form in which to record reaction velocity data, for it enables one to calculate the rate constant and hence the extent of reaction at any time and at any temperature; also the energy of activation (24,590) is prominently displayed.

This reaction lends itself nicely to an experimental demonstration of the influence of concentration on reaction velocity. When crystals of nitrogen pentoxide are left in the reaction chamber they maintain a constant partial pressure corresponding to the sub-

limination pressure of nitrogen pentoxide at the temperature of the thermostat. When a molecule of nitrogen pentoxide decomposes in the gas phase it is immediately replaced by another molecule from the crystals. The rate of decomposition, then, should not fall off with time as shown in Fig. 1, but the rate should be constant as long as crystals remain. Mathematically expressed, $-dc/dt = kc$, but since c is constant

$$\frac{-dc}{dt} = k' \quad (6)$$

where k' is a constant.

These expectations are realized in the data of Table III where t and p represent the time and pressure, Δp gives the increase in pressure, and $-\Delta c_0$ is the amount of N_2O_5 decomposed, expressed in millimeters of N_2O_5 , during the time Δt , which represents the time from the beginning of the experiment. The constant rate of decomposition is $-\Delta c_0/\Delta t$ and the constant k is obtained by dividing this number by the constant concentration c_0 .

It is to be noted that this is like the equation for a zero order reaction (II-12), but the rate is constant, not because it is independent of concentration but because the concentration is kept constant artificially. It was gratifying to find, as expected, that the quantity of crystals of nitrogen pentoxide in the vessel had no influence on the rate. This fact proves that the reaction being measured, is strictly a gas phase reaction and that there is no decomposition in the crystal itself and no catalysis by the crystal surface.

TABLE III
THE DECOMPOSITION OF NITROGEN PENTOXIDE IN THE PRESENCE
OF THE SOLID PHASE AT 25°

t sec.	p mm.	Δp mm.	$-\Delta c_0$ mm.	$\frac{-\Delta c_0}{\Delta t}$	k
0	414	0	—	—	—
1200	446	32	14.0	.011	0.000028
1800	464	50	23.5	.013	0.000031
2400	481	67	34.3	.014	0.000034
3000	496	82	40.4	.013	0.000033
3600	512	98	49.0	.013	0.000033

We have discussed the influence of temperature on the decomposition of nitrogen pentoxide and we next consider the influence

of pressure. Since the reaction is of the first order the fraction decomposing per second should be independent of the pressure, but it is possible that this independence may not be continued indefinitely to low pressures.

With this test in mind a flow-method was used to determine the rate of decomposition at low pressures.⁵ A stream of nitrogen at atmospheric pressure was slowly swept over crystals of nitrogen pentoxide at a given temperature. The mass of nitrogen containing a small amount of nitrogen pentoxide was then passed through a long tube which was kept at a constant temperature by pumping thermostated water through the jacket. After leaving the thermostated chamber it was passed through a capillary tube into a measured quantity of sodium hydroxide of known concentration. The solution was then divided into two parts, one of which was titrated with acid and the other with permanganate. In this way the total amount of nitrogen oxides was obtained from the neutralization of the sodium hydroxide, and the total amount of nitrogen dioxide was obtained by titration of the nitrites with potassium permanganate. An excess of permanganate was added, then a known amount of ferrous sulphate and finally a second titration was made with permanganate. In this way a fading end point is avoided. At very low partial pressures of nitrogen pentoxide the titration method was inapplicable, and a colorimetric method for nitrites and nitrates was used.

The time in which a given molecule remained in the tube was estimated by dividing the volume of the tube by the rate of gas flow as determined with a flowmeter. The ratio of nitrites to total acidity gave the ratio $\text{NO}_2/(\text{N}_2\text{O}_5 + \text{NO}_2)$ and hence a measure of the percentage decomposition. The specific decomposition rate k was then calculated for various temperatures and for different pressures. Within the limit of experimental accuracy the specific decomposition rate of nitrogen pentoxide was the same as that determined by the static method, already described, and furthermore, this same constant was maintained down to a few millimeters and even to tenths of millimeters.

It was easy to control the partial pressure of nitrogen pentoxide by changing the temperatures of the crystals. When the crystals are placed in carbon dioxide snow at -80° , the partial pressure amounts to only about one one-hundredth of a millimeter. In this

⁵ Hunt and Daniels, *J. Am. Chem. Soc.*, **47**, 1602 (1925).

way it was possible to measure the decomposition rate at very low partial pressures. The total pressure, mostly nitrogen, was still one atmosphere. The specific decomposition rate k decreased by about twenty-five per cent at these lowest pressures (0.01 mm. partial pressure of N_2O_5) but at that time (1923) we concluded that the twenty-five per cent deviation was not significant because the experimental error was rather large. In view of more recent work, this decrease is probably significant. One can safely say, however, that down to one-tenth of a millimeter and up to one thousand millimeters pressure of nitrogen pentoxide the velocity constant of nitrogen pentoxide is independent of pressure. This 10,000-fold variation covers a large range, and establishes the fact that the decomposition does not depend directly on collision frequency.

The question immediately arises as to how far this independence of collision will continue as the pressure of nitrogen pentoxide is indefinitely decreased. The matter is of great importance for checking theories of chemical kinetics and accordingly many other investigators undertook the study of the decomposition of nitrogen pentoxide at very low pressures.

Hirst and Rideal⁶ followed the decomposition at low pressures by freezing out the nitrogen oxides with liquid air and measuring the partial pressure of oxygen. Hirst⁷ covered the higher pressure ranges and obtained excellent checks on the earlier measurements of nitrogen pentoxide.

White and Tolman⁸ followed the decomposition colorimetrically by matching the brown color of nitrogen dioxide in the reaction chamber with nitrogen dioxide of known partial pressures. This reaction is uniquely favorable for the use of the colorimetric method because of all the gases present, the only one which is colored is nitrogen dioxide, and its brown color is very intense, a partial pressure of less than a millimeter giving a detectable color in a 100 cc. flask. White and Tolman checked closely the decomposition constants obtained in the first research. Rice⁹ became interested in catalysis by dust particles which he had shown to be a factor in the decomposition of hydrogen peroxide. He thought that they might also be a factor in the decomposition of nitrogen pentoxide. He prepared nitrogen pentoxide in several different ways

⁶ Hirst and Rideal, *Proc. Roy. Soc. London*, **A109**, 526 (1925).

⁷ Hirst, *J. Chem. Soc.*, **127**, 657 (1925).

⁸ White and Tolman, *J. Am. Chem. Soc.*, **47**, 1240 (1925).

⁹ F. O. Rice and Getz, *J. Phys. Chem.*, **31**, 1572 (1927).

designed to eliminate every trace of dust. Again he found the same decomposition rates. Hibben¹⁰ froze out the nitrogen oxides, used an electrical gauge for measuring low pressures of oxygen and reported that the normal rate constant of nitrogen pentoxide was maintained down to very low pressures, even to 0.001 mm. Loomis and Smith¹¹ examined this work critically and found that the freezing out of nitrogen oxides trapped some of the oxygen and led to doubtful results. Sprenger¹² found that the normal specific reaction rate was maintained down to quite low pressures, but that in the neighborhood of 0.01 mm. the reaction stopped. This surprising result was used by Bodenstein as an argument for a chain reaction in the decomposition of nitrogen pentoxide.

With all these conflicting results the problem became of still greater importance. Finally three different laboratories have apparently settled the matter in an exhaustive manner, and there is approximate agreement among them all. Ramsperger and Tolman¹³ found that the nitrogen pentoxide decomposition constant has the normal value reported in the first investigation down to 0.05 millimeter. From 0.05 mm. to 0.005 mm. the constant falls to about half of its high-pressure value. Adsorption by the walls becomes a matter of considerable importance at these pressures. They used a forty-five liter flask and a special glass diaphragm coated with metal in such a way that slight changes in pressure changed the capacity of the condenser in a vacuum tube circuit and gave a difference in the loud speaker which enabled them to balance a measured air pressure against the pressure of the nitrogen pentoxide system. Schumacher and Sprenger¹⁴ repeated Sprenger's experiment and failed to find the sudden stopping of the reaction. Their results agree essentially with those of Ramsperger and Tolman. Linhorst and Hodges¹⁵ carried out another exhaustive research on the decomposition of nitrogen pentoxide using the Coolidge fiber gauge which is an excellent means for measuring low pressures accurately. Their high pressure values checked with all the other work and they too found a falling off of the velocity constant at pressures below 0.05 mm. and down to

¹⁰ Hibben, *J. Am. Chem. Soc.*, **50**, 937 (1928).

¹¹ Loomis and Smith, *J. Am. Chem. Soc.*, **50**, 1864 (1928).

¹² Sprenger, *Z. physik. Chem.*, **136**, 49 (1928).

¹³ Ramsperger and Tolman, *J. Am. Chem. Soc.*, **46**, 6 (1930).

¹⁴ Schumacher and Sprenger, *Proc. Nat. Acad. Sci.*, **16**, 129 (1930).

¹⁵ Linhorst and Hodges, *J. Am. Chem. Soc.*, **56**, 836 (1934).

0.005 mm., which was the practical limit of their range. These data at low pressures are summarized graphically in Fig. 16 where $\frac{k}{k_{\infty}}$ gives the ratio of the velocity constant at a given pressure to the normal constant at higher pressures. Logarithms of the quantities are plotted in order to permit a wider range. In spite of the complications of adsorption, it now appears definite that the

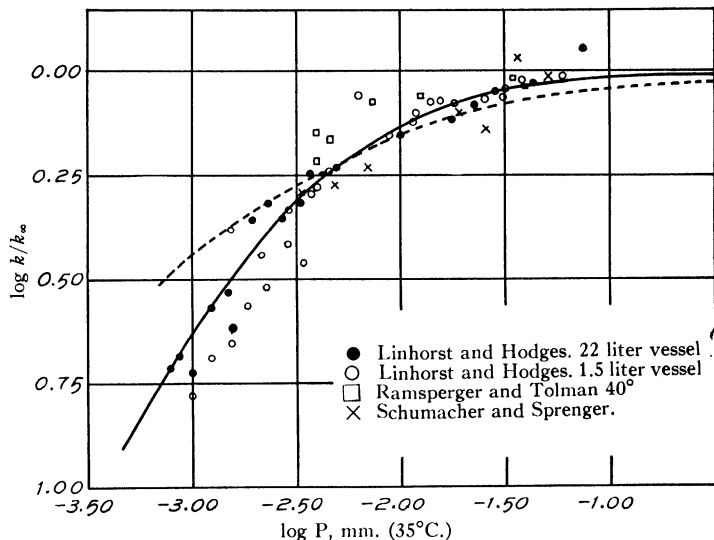

FIG. 16.—Influence of pressure on the specific reaction rate k for the decomposition of nitrogen pentoxide at low pressures.

specific reaction rate falls off to about half of its value in the region of 0.05 to 0.005 mm. It would be exceedingly interesting to obtain results at still lower pressures to determine if the value of k continues to decrease; but until some new technique is developed, the practical limit has apparently been reached.

In spite of the large amount of work which has been done on nitrogen pentoxide, it is planned to carry out a still more precise measurement of the decomposition rate in the gas phase. The constancy of the energy of activation at different temperatures is a matter of great theoretical importance. Although few gas reactions in chemical kinetics are more accurately known, the present meas-

urements are not of sufficiently high accuracy to enable one to decide whether or not E varies with temperature. Furthermore, the early measurements have been used to illustrate statistical methods for calculating velocity constants, and the most probable values have been calculated. It will be interesting to see whether or not the prediction of statistical methods are correct. Without question they are correct and applicable to most physical and chemical phenomena, but there may be difficulties in their application to chemical kinetics.

New measurements can be made with greater accuracy now because of three new developments. Better and more reliable glass diaphragms are available for measuring pressures. The graphical method for determining k can be more reliable than the method used before. Thirdly, the dissociation constant of nitrogen tetroxide has been redetermined with greater accuracy, a fact which should make possible more reliable calculations of the partial pressure of nitrogen pentoxide from the total pressure of all the gases.

There is something strange about this nitrogen pentoxide reaction. The reaction is the best example of a first-order gas phase reaction that we have; and yet, according to equation (1), two molecules of nitrogen pentoxide are involved. Why should this, then, not be a second order reaction? If it is a second order reaction we should expect the specific reaction rate to change markedly with pressure and depend on collision frequency. The best answer is given as follows:

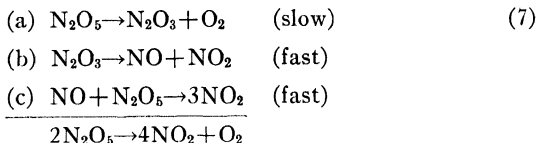

According to this scheme,¹⁶ which is now generally accepted, the decomposition is unimolecular, one molecule decomposing at a time to give N_2O_3 and O_2 (7a). The N_2O_3 then breaks up into NO_2 and NO , (7b), but the NO reacts very rapidly with N_2O_5 to give 3NO_2 , (7c). This last fact was determined by a direct test tube experiment. The rate-determining step, the slowest reaction in the series, is the first reaction and the second and third steps

¹⁶ Busse and Daniels, *J. Am. Chem. Soc.*, **49**, 1257 (1927).

are so fast that they are undetected. This is an excellent example of the fact so often met with in chemical kinetics that the actual mechanisms and the rate determining step do not coincide with the over-all, stoichiometrical reaction. Personally, I believe that the falling off of the rate constant at 0.05 mm. may have a simple *chemical* explanation. If so, the generally accepted theories of the elaborated collision hypothesis are not applicable at all. The bimolecular reaction between nitric oxide and nitrogen pentoxide (7c) has never been measured quantitatively. It is possible that at the lower pressures this reaction is no longer instantaneous, and if it should slow up at 0.05 mm. so that it is comparable in rate with the unimolecular decomposition of nitrogen pentoxide (7a), we would have a simple explanation for the falling-off with pressure of the velocity constant. According to this plausible suggestion, there is reason to expect that the rate constant would not decrease beyond *half* its normal value even at very low pressure. It is planned to carry out this investigation at the first opportunity. It should not be difficult, for the bimolecular reaction (7c) can be easily followed by colorimetric means.

The fact that nitrogen pentoxide maintains its normal specific decomposition rate down to pressures as low as 0.05 mm. is puzzling. Conceivably, it might be maintained to still lower pressures if the second step can be kept too fast to measure. According to Theories I and II of Rice and Ramsperger and Kassel discussed in Chapter III, and by comparison with other gas phase decompositions, a molecule as complex as nitrogen pentoxide with seven atoms should show a departure from the high pressure value of k at pressures of a few millimeters. Realizing the difficulty, Eyring and Van Valkenberg¹⁷ determined the molecular diameter of nitrogen pentoxide with an all-glass viscometer and found that it is not abnormal. Kassel¹⁸ believes that by stretching all the experimental constants the behavior of nitrogen pentoxide can just barely be explained by the elaborated collision hypothesis. Others believe that these theories simply can not be made to fit nitrogen pentoxide and the question arises as to whether it or the theories are at fault. Many gas phase reactions do seem to agree with them but the reactions are often complicated and it is possible that some of

¹⁷ Eyring and Van Valkenburgh, *J. Am. Chem. Soc.*, **52**, 2619 (1930).

¹⁸ Kassel, *J. Phys. Chem.*, **32**, 225 (1928); *Kinetics of Homogeneous Gas Reactions*, The Chemical Catalog Co. New York (1932), p. 132.

the accepted checks may find an alternative explanation in the effect of lowered pressure on a series of complicated reactions or a chain mechanism. Further experimental investigation and chemical analysis of these low-pressure reactions are much needed.

THE DECOMPOSITION OF ETHYL BROMIDE

The decomposition of nitrogen pentoxide is a reaction of inorganic chemistry and a search was made to find a typical organic reaction which would be as simple in its kinetic behavior as the nitrogen pentoxide. After many preliminary experiments ethyl bromide was chosen for extensive study. The work was begun before the elaborated collision hypothesis and the chain hypothesis had been advanced and in continuing this investigation up to the present time it has been interesting to feel the influence of current theories on the interpretation of experimental data.

Ethyl bromide decomposes at about 400° to give ethylene and hydrobromic acid. The reaction was studied in an all-glass apparatus¹⁹ as shown in Fig. 10. The advantages of this all-glass technique are evident. All parts of the vessel containing ethyl bromide are at a constant, high temperature. The column of air extending from the diaphragm to the manometer undergoes a considerable temperature gradient but this makes no difference in measuring the pressure of air. In many researches on chemical reactions in the gas phase the pressure of the gas has been measured through a capillary tube extending out of the furnace to a manometer. It is safe in some work to make corrections for this non-isothermal system, but it seemed safer in this work to exclude any chance of condensation or pressure change in a cold tube extending out of the flask.

The thermostat is an iron box about thirty centimeters square filled with molten lead. An iron blade keeps the lead stirred and a platinum resistance thermometer functions both as a thermometer and as a thermoregulator. The Wheatstone bridge, which contains the resistance thermometer as one arm, is adjusted for a given temperature, and the beam of light from the galvanometer strikes a zero reading on the scale. At this position is introduced a photoelectric cell connected with a radio tube and amplifier, which in turn actuates an electro-magnetic relay. When the temperature reaches the predetermined value, the beam of

¹⁹ Page 58.

lights hits the photoelectric cell, the relay is opened, and the extra heating coil is disconnected. Most of the heating coils operate continuously to keep the bath nearly, but not quite, up to the desired temperature. The thermostat cools down, the beam of light moves away from the photoelectric cell, the relay is closed, and the heating coil is put into operation as in any thermostat. Due to the time lag in the thermostat the beam of light swings past the photoelectric cell before the correct temperature is reached. Accordingly, it is necessary to introduce a special mechanical device so that the relay operates on alternate excitations from a beam of light. The thermostat has given years of service with fluctuations amounting at 400° to about 0.3 of a degree.

The diaphragm changes its zero point with temperature, but it is calibrated at the high temperature. A new diaphragm behaves erratically, and must be seasoned for an hour or two before making actual determinations. Tests were made with air to determine the extent of any time-lag. When the flask is plunged into the lead bath from room temperature the diaphragm settles down to a uniform value in about a minute and a half and thermal equilibrium with the gas is reached in about five minutes.

After the decomposition products of ethylene and hydrobromic acid remain in the flask for a considerable time a slight deposit of carbon or polymerized compound is formed which is visible to the eye. This film decreases the decomposition rate, and it was found necessary to clean the flasks before every experiment in order to get reproducible results. This cleaning was accomplished in two ways, either by heating to redness in an atmosphere of oxygen, or by using a mixture of fuming nitric acid and potassium chlorate. Results with the two methods were the same. Kistiakowsky²⁰ has reported that in similar decomposition experiments he obtains reproducible results by using an old flask *heavily coated* with the film. These differences, confirmed now for ethyl bromide, show that the wall exerts some influence on the course of the reaction.

Analysis of the products showed that ethylene and hydrobromic acid are practically the only gases remaining after the reaction is completed. The flask was opened under a starch iodide solution, but no test for free bromine could be obtained. In none of the work did the brown color of bromine develop even at high tem-

²⁰ Brearley, Kistiakowsky, and Stauffer, *J. Am. Chem. Soc.*, **58**, 48 (1936).

peratures. Even if the hydrobromic acid dissociated to hydrogen and bromine, no difficulty would be introduced in the pressure measurements because there is no pressure change when hydrobromic acid dissociates. Chemical analysis of the product showed

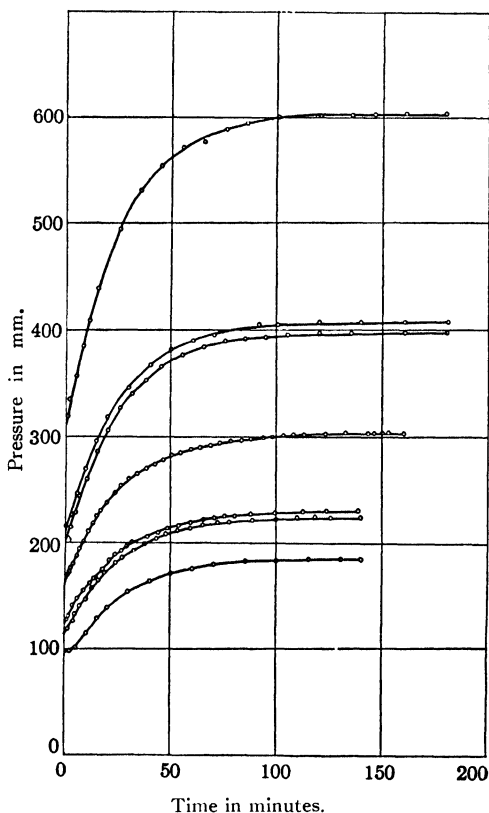
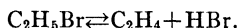

FIG. 17.—Pressure-time curves for the decomposition of ethyl bromide.

that half of the gas was absorbed by sodium hydroxide. It was hydrobromic acid. The residual gas was then analyzed by explosion with oxygen. The shrinkage was exactly equal to the shrinkage next obtained by the addition of sodium hydroxide. In other words, the final gas, after removal of hydrobromic acid, consisted

of a gas with twice as much hydrogen as carbon. These facts show that the reaction products are chiefly (at least ninety-five per cent) ethylene and hydrobromic acid formed by the reaction



It is evident that two molecules are produced from one and that the reaction can be followed quantitatively by the increase in pressure. There is a complication, however, in that hydrobromic acid would be expected to add to ethylene and reverse the reaction.

Typical pressure-time curves are given in Fig. 17.

The method of calculating the specific reaction rates k from these pressure-time curves calls for some consideration. If there were no reverse reaction and no complications the final pressure should be just twice the initial pressure. Actually it is always less and the difference between twice the initial pressure, $2p_i$, and the final pressure, p_f , gives a measure of the extent of the reverse reaction, provided that the reaction mixture has not stayed in the reaction chamber long enough (several hours) for the polymerization of ethylene and the formation of a film.

If the reverse reaction is ignored the difference at time t , between the final pressure and the pressure ($p_f - p_t$), should be a measure of the amount of ethyl bromide remaining undecomposed. The amount originally present would be proportional to ($p_f - p_i$). Moreover, the amount remaining at time t would be given equally well by ($2p_i - p_t$). In Fig. 18 graphs are given in which the log of the concentration of ethyl bromide is plotted against time, the concentration being calculated in these two different ways. The fact that the lines are straight shows that the reaction is essentially first order. The question arises as to which is the more reliable method of calculating the velocity constant from the slope; (1) in which the concentration is obtained from the formula ($p_f - p_t$); or (2) in which it is obtained from the formula ($2p_i - p_t$). The final pressure is too low on account of the reverse reaction but on the other hand the initial pressure is also difficult to determine because there is a period of uncertainty for five minutes due to thermal lag which makes extrapolation to the beginning time uncertain. The points for ($p_f - p_t$) seem to fit a straight line better for a longer time but it is subject to the uncertainty of the reverse action and some other check seems necessary.

The specific reaction rate constant k is obtained by multiplying the slope of the straight line by 2.303.

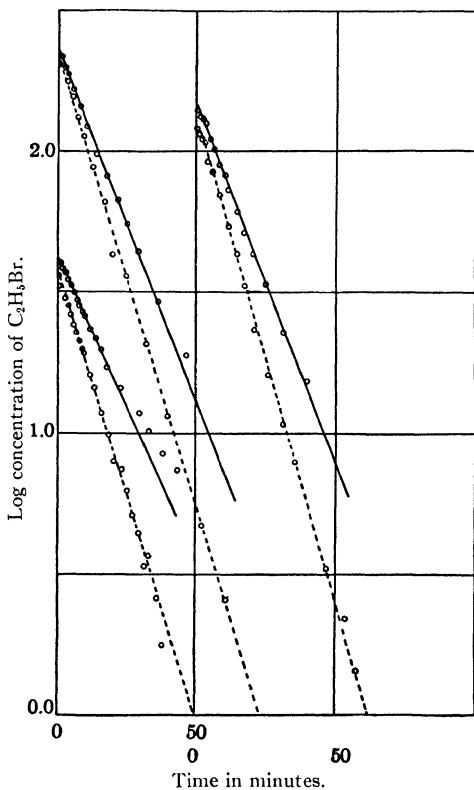
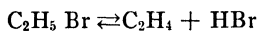

FIG. 18.—Logarithm of concentration of ethyl bromide plotted against time. Full lines, $\log (2p_i - p_t)$; broken lines, $\log (p_f - p_t)$.

The mathematical expression for the rate of change, allowing for the reverse reaction, is derived as follows;



$$\frac{dc_{\text{C}_2\text{H}_5\text{Br}}}{dt} = -k_1c_{\text{C}_2\text{H}_5\text{Br}} + k_2c_{\text{C}_2\text{H}_4}c_{\text{HBr}}$$

Letting

$$x = c_{C_2H_4} = c_{HBr}$$

$$\frac{dx}{dt} = k_1(a-x) - k_2x^2 = k_1(a-x) - \frac{k_1x^2}{K} \quad (8)$$

where x is the amount of material reacting, a is the initial amount, k_1 is the velocity constant for the decomposition of ethyl bromide, k_2 is the velocity constant for its formation from ethylene and hydrobromic acid and K is the equilibrium constant.

According to a third method (3) for calculating k , the slope of the original curves $\frac{dp}{dt}$ or $\frac{dx}{dt}$ is determined at several points and k_1 and k_2 are determined by least squares in the equation

$$\left(\frac{1}{a-x}\right) \frac{dx}{dt} = k_1 - k_2 \left(\frac{x^2}{a-x}\right). \quad (9)$$

According to a fourth method (4), k_1 is obtained by integrating equation (8) and setting $x=0$ when $t=0$ to give

$$k_1 = \frac{2.303}{t \sqrt{\frac{4a}{K} + 1}} \log \frac{\left(\frac{2x}{K} + 1 + \sqrt{\frac{4a}{K} + 1}\right) \left(-1 + \sqrt{\frac{4a}{K} + 1}\right)}{\left(\frac{-2x}{K} - 1 + \sqrt{\frac{4a}{K} + 1}\right) \left(1 + \sqrt{\frac{4a}{K} + 1}\right)}. \quad (10)$$

A fifth method is the least accurate of all but it is extremely simple and it is adequate for many purposes. It depends on the fact that if the time taken for three-fourths of the material to decompose is twice as long as the time taken for half of it to decompose the reaction is first order. Under these conditions the velocity constant k can be evaluated by simply dividing the period of half-life into 0.69 as previously explained (page 22).

A comparison of these four different methods of calculation is given in Table IV.

The method of integration (4) is accurate in theory but in practice it is rendered uncertain by the difficulty of estimating the equilibrium constant K . The method of slopes (3) should probably be the most accurate but it is difficult and time-taking to use. In advance one can not predict whether method (1) or (2) will be more accurate but since method (2), in which $\log(2p_i - p_i)$

is plotted against time, checks with method (3) it is accepted as being the best and it has been used in subsequent work. Over a hundred experiments at 395°, 405° and 420° gave good agreement and led to the general equation of

$$k = 3.85 \times 10^{14} e^{-54,8000/RT}.$$

At pressures below about 100 mm. it was found that k falls off in agreement with the prediction of the elaborated collision hypothesis.

TABLE IV
DIFFERENT METHODS OF CALCULATING k FOR THE DECOMPOSITION
OF ETHYL BROMIDE
 $k \times 10^4 \text{ sec}^{-1}$ at 395°

Methods→		1	2	3	4
p_i	p_f	$\log (p_f - p_i)$	$\log (2p_i - p_f)$	Slopes	Integration
162	303.3	6.75	5.70	5.82	4.3
83	153.2	6.18	5.29	5.33	4.0
52	95.8	5.08	4.73	4.68	4.2

esis. In experiments with an initial pressure of about 20 mm. when k is calculated with the first order formula a value of only about half the high pressure value is obtained.

Ethyl bromide contains eight atoms and applying the empirical rule, $(3 \times 8 - 6)$ for the degrees of freedom, n would be expected to have a value of 18. Testing the theories of Rice and Ramsperger, and Kassell, it is found that when n is given a value of 21 or 22 and a reasonable diameter is assumed, k begins to decrease at pressures around 100 mm. Moreover there is apparently a more rapid falling off of k with pressure at the higher temperature, a fact which fits better with Theory II of these authors²¹ and supports the view that the disruption of the molecule requires the localization of the energy of activation in a particular valence bond.

Another check on these theories is obtained by plotting $1/c$ or $\frac{1}{2p_i - p_f}$ against time at the low pressures. A straight line is obtained indicating that at the lower pressures the reaction is second order, again in agreement with predictions of the elaborated collision hypothesis. It must be remembered, however, that agreement with an hypothesis does not necessarily prove that the hypothesis is uniquely correct.

²¹ Ramsperger, *Chem. Rev.*, 10, 35 (1932).

There were a few facts which did not seem to agree with the hypothesis. A trace of oxygen, too small to be noticeable in the final pressures markedly accelerated the decomposition rate. At the low pressures where k was low the addition of foreign gases should bring k up to its normal, high-pressure value; but actually hydrogen, nitrogen and carbon dioxide were found to *decrease* the value of k . In some of the experiments there was an unexplained time-lag at the beginning of the experiment when the decomposition was abnormally slow. Semenov in commenting on this fact,²² suggested that probably chain reactions were involved in the decomposition.

In the meantime Rice and Herzfeld had shown that perfectly good first order constants can be obtained from a set of chain reactions. It seemed worth-while to reinvestigate the whole reaction in order to determine the extent to which chains are involved and to learn if possible more of the mechanism by which the decomposition actually occurs.²³ Conditions were changed as much as possible and experimental facts were collected to determine what set of reactions and intermediate steps would be in agreement with all the facts without violating any of the established principles of chemical kinetics. In searching for complicating intermediate steps, standard tests were applied including (a) the effect of temperature, (b) the effect of pressure, (c) the effect of added gases, (d) the effect of walls, (e) careful chemical analyses for small amounts of other products, and (f) close examination of the initial period of the reaction for time lags or other irregularities.

Because of the accelerating effect of oxygen it was necessary to take elaborate precautions. Mercury traps and cut-offs and magnetically operated hammers and pumps were used in an all-glass system. No stopcocks, cement, or rubber tubing were allowed. The apparatus was flamed, while being evacuated with a mercury diffusion pump protected with a liquid air trap. Foreign gases were rendered oxygen-free by circulating through pyrophoric iron prepared "*in situ*." The acetone fluorescence test²⁴ showed that the oxygen was effectively removed. The oxygen was removed from ethyl bromide and other liquids by extended evacuation while the material was frozen. The material was fused, frozen

²² Semenov, *Chemical Kinetics and Chain Reactions*, Oxford University Press (1935), p. 450.

²³ Fugassi and Daniels. *J. Am. Chem. Soc.* 60, 771 (1938).

²⁴ Page 150.

again and evacuated. This cycle of operations was continued several times until the oxygen discharge was no longer evident when the evacuated vessel was touched by a small Tesla coil.²⁵

One set of results is shown in Fig. 19 where it is clearly seen that the specific rate constant falls off rapidly at pressures below about 100 mms. in apparent agreement with present theories of unimolecular reactions. According to these theories the addition of inert foreign gases to the reacting gas should increase the rate constant and bring it up toward its normal, high-pressure value.

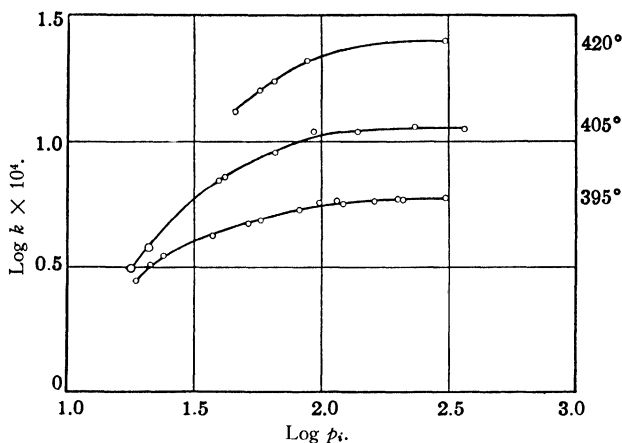

FIG. 19.—Effect of decreased pressure on the specific decomposition rate of ethyl bromide.

It was found, however, that although hydrogen and nitrogen in low concentration gave this increase, in larger amounts they produced a decrease. For example, the addition of half an atmosphere reduced the constant to about half its high pressure value. There is nothing in the collision theories to explain this phenomenon. Apparently the decomposition is more complicated than is evident at first sight. Bromine was found to accelerate the decomposition while mercury vapor, even as little as 2.5 mm., definitely retarded it. The quantities are too small to account for the observed changes in pressure by simple chemical reaction according to stoichiometrical proportions.

²⁵ Willard and Daniels, *J. Am. Chem. Soc.*, **57**, 2240 (1935).

Changing the ratio of surface to volume is helpful in determining whether or not a reaction is complicated by intermediate steps involving adsorption. If free radicals are involved it may be assumed that some of them will be adsorbed on the walls. On the other hand a wall effect does not necessarily prove the presence of free radicals. In studying the ethyl bromide decomposition the wall effect was increased in two ways—by packing the flasks with short lengths of glass tubing; and by using a flow method in which the gases at a definite pressure were streamed through a long, thermostated glass tube. In both cases the specific rate of decomposition was increased but it was never more than doubled. In the flow experiments the vapor pressure was maintained constant at the entrance to the chamber by controlling the temperature of the liquid. The products were removed and collected in a trap at the exit surrounded by liquid air. The flow method gives less accurate rate constants than the static method but it permits the use of a long narrow tube with a great increase in surface, it makes measurements possible over very short time intervals and, most important of all, it enables one to collect large amounts of material for analysis.

The analysis of the products called for supplementary data on the decreases in vapor pressure produced by low temperature baths. After removal of hydrobromic acid, ethylene and unsaturated compounds the residual gas was subjected in different cooling baths to the temperatures listed in Table V and the cor-

TABLE V
ANALYSIS OF GASES OTHER THAN ETHYLENE AND HYDROBROMIC ACID

Temperature Range °C	Pressure Decrease mm.	H ₂ mm.	C ₂ H ₆ mm.	C ₃ H ₈ mm.	C ₄ H ₁₀ mm.
-78 to -89	7.5	—	—	—	7.5
-89 to -110	17.9	—	—	12.9	5.0
-110 to -139	62.4	—	49.3	13.1	—
-139 to -172	15.0	—	15.0	—	—
-172 to -190	0.0	—	—	—	—
Below -190	76.6	76.6	—	—	—

responding pressures were determined. The readings were taken both on cooling and on warming. Two or three hours were necessary for complete equilibrium in the apparatus used.

Adding up all these pressures and expressing the partial pres-

tures in per cent of the total, the composition of the residual gas was hydrogen 42.7; ethane 35.9, propane 14.5, butane 5.8. Satisfactory checks on this composition were obtained by determining the contraction in volume on combustion and the amount of carbon dioxide produced. The complete analysis of the products in the static experiments gave about 50 per cent hydrobromic acid, 48.8 per cent ethylene, 0.5 per cent ethane, 0.15 per cent hydrogen and traces of propane and butane. In the flow experiments the analysis was 46.5 per cent ethylene, 3.0 per cent ethane, and 0.6 per cent hydrogen. The amounts of products other than ethylene and hydrobromic acid are small but they are larger when the gases come in more frequent contact with the walls. Such a result is to be expected in case ethyl radicals reach the walls.

Now the effect of added gases, the effect of increasing surface and the existence of ethane and hydrogen point to a decomposition which is more complicated than the simple unimolecular decomposition—splitting off hydrobromic acid and leaving ethylene. The production of free radicals of C_2H_5 would explain these facts and it is possible to account for the first order character of the reaction by means of a chain reaction involving ethyl radicals. The larger part of the evidence, however, seems to be against a chain reaction.

Primary steps in the decomposition might be:

- (I) $C_2H_5Br \rightarrow C_2H_4Br + H$
- (II) $C_2H_5Br \rightarrow CH_3 + CH_2Br$
- (III) $C_2H_5Br \rightarrow C_2H_4 + HBr$
- (IV) $C_2H_5Br \rightarrow C_2H_5 + Br$

The first reaction involves the breaking of a carbon-hydrogen bond. The energy of activation must be at least as great as the 92,000 calories which is the heat of this endothermic reaction. The experimental facts show that only about 55,000 calories is required for the decomposition of ethyl bromide. Accordingly, the splitting-off of a hydrogen atom according to (I) is not possible. Likewise the splitting-off of a free methyl radical is impossible, for the energy of activation of this reaction would have to be at least as great as the 77,000 calories required to break a carbon-carbon bond. Later revisions of this value of course, may show that reaction (II) is possible.

Reaction (III) is possible. The heat absorbed in breaking a carbon-bromine bond (58,000) and a carbon-hydrogen bond (92,000) is partially offset by the heat evolved in the formation of a hydrogen-bromine bond (85,000) and a carbon-carbon double bond instead of a carbon-carbon single bond (45,000). The net result is the absorption of 20,000 calories and the energy of activation must then be at least 20,000. Actual thermochemical measurements on heats of formation give 17,800 calories for the reaction. This is all that thermochemistry can tell us but quantum calculations (page 227) can go farther and give not only a minimum value, but a fairly accurate value for the energy of activation. In this case it can be calculated that the energy of activation for the addition of HBr to C_2H_4 is about 40,000 calories and subtracting this from 17,800, the endothermic heat of reaction gives a value of 57,800 for the activation energy of the decomposition of ethyl bromide. This is close to the experimentally observed value of 55,000.

Reaction (IV) is possible and in fact quite likely. The breaking of a carbon-bromine bond involves the absorption of 58,000 calories and this minimum is close enough to the 55,000 calories to be within the limit of uncertainty of the constants involved. This reaction can account for the experimental results and is in line with spectroscopic evidence that ethyl halides dissociate photochemically into the halogen atom and the free radical.

Many different chain mechanisms can be written but most of them can be ruled out because (a) they require too much energy, (b) they do not give the observed products, or (c) the products would be altered by the addition of hydrogen, contrary to the observed facts. Only one chain mechanism seems to survive these various tests, namely:

- (1) $C_2H_5Br \rightarrow C_2H_5 + Br$
- (2) $C_2H_5 + Br \rightarrow C_2H_5Br$
- (3) $Br + C_2H_5Br \rightarrow HBr + C_2H_4Br$
- (4) $C_2H_4Br \rightarrow C_2H_4 + Br$
- (3') $Br + C_2H_5Br \rightarrow HBr + C_2H_4Br$, etc.
- (5) $C_2H_5 + C_2H_5 (+ wall) \rightarrow (C_2H_4 + C_2H_6 + H_2 + C_3H_8, \text{ etc.})$

Reaction (2) is the reverse of (1). The chain is propagated by a continuing repetition of reactions, 3, 4, 3', etc., and it is broken

when Br or C_2H_4Br collides with the wall. Following the primary breakdown of C_2H_5Br into C_2H_5 and Br, these successive reactions produce a "steady state" thus giving an equilibrium concentration of bromine atoms. A set of differential equations can be set up, the approximate solution of which gives a decomposition rate proportional to the concentration of ethyl bromide. Thus the requirement of the first order reaction can be met by means of a chain mechanism and the effect of foreign gases and walls can be explained also.

There are, however, two objections to this chain reaction. In the first place step (4) seems unlikely because in general a free radical with a fairly large energy of activation for decomposition will react rather than decompose. In the second place it is difficult to account for an activation energy as large as the observed value of 54,800 calories. The energy of activation of step (1) giving a steady equilibrium concentration of bromine atoms is not involved in the set of differential equations which give the first order rate constant, and reactions (3), (3') and (5) involving free radicals are probably all less than 10,000 calories.

Another mechanism seems more plausible. It is quite similar, with the important exception that the chain propagation, through reactions (3) and (4), is dropped out and substituted by a single, non-chain step as follows:

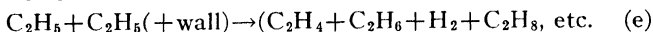
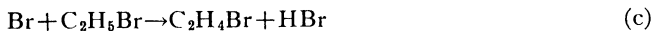

Reaction (d) is rapid in spite of the low concentrations of C_2H_5 and C_2H_4Br free radicals because the energy of activation for reactions involving these free radicals is very low—less than 10,000 calories. According to this hypothesis the first step (a) is the rate determining step and all the steps which follow are too fast to be measured. Changes in these steps, however, may make changes up to fifty per cent in the observed rate constant depending on pressure, added gas and surfaces. In general the observed measurements of rate constants were not changed by more than fifty per cent. Large changes might be possible if a chain mechanism is involved.

According to either of these hypotheses, involving free radicals, the increase in ethane and hydrogen with increase of surface is explained by an increase in reactions (e) or (5). The decrease in rate constant with addition of foreign gases can be explained as due to an increase in reaction (b) or (2). The accelerating effect of bromine is due to an increase in the number of bromine atoms, increasing reaction (c) or (3), and the retarding effect of mercury is due to the removal of bromine atoms.

The recombination of bromine atoms can not occur except on collision with a third body but reaction between the more complicated ethyl radicals might be expected without the aid of walls or triple collisions. In any reaction involving the production of free ethyl radicals one might expect to find butane, ethane, etc., but actually very little of these products is found. Apparently in this case radicals of this type are not likely to combine with each other.

The straight unimolecular decomposition into ethylene and hydrobromic acid



is not impossible. The slight amount of hydrogen, ethane and other gases might come from a secondary reaction of the ethylene formed by the decomposition of the ethyl bromide. The increase in decomposition rate with increased wall area might be due to adsorption of ethyl bromide and the increased energy supplied by the adsorption process.

Again the decomposition of the ethyl bromide might take place by the rupture into free radicals and the recombination to give the final products ethylene and hydrobromic acid



The sum of the two reactions (g) and (i) is equal to reaction (f) but the mechanism of the initial rupture is different. Moreover, this scheme of decomposition would permit some side reactions such as (c), (d) and (e), or (3), (4) and (5) and thus account for the various effects due to increased surface, oxygen, and other foreign gases.

This extended discussion of the decomposition of ethyl bromide has shown the difficulty of definitely assigning a single mechanism to a reaction. Perhaps still further experiments will enable

one to choose between these three or four possibilities. Very likely, however, decomposition is actually occurring simultaneously by two or more mechanisms.

LITERATURE

A few gas phase reactions which have been studied quantitatively from the standpoint of chemical kinetics are listed below. Experimental details, influence of different variables, and discussions of mechanisms may be found in the references. The results at different temperatures are summarized by the equation

$$k = se^{-E/RT} \text{ sec.}^{-1}.$$

where T is absolute temperature and t is centigrade temperature.

UNIMOLECULAR DECOMPOSITIONS

Inorganic compounds.

Nagasako and Volmer, *Z. physik Chem.*, **10B**, 414 (1930).

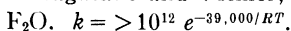

Hurd, *Ind. Eng. Chem.*, **26**, 50 (1934).

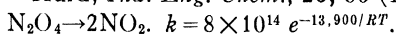

Richards and Reid, *J. Chem. Phys.*, **1**, 114 (1933).

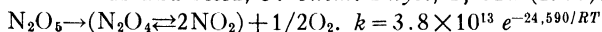

Page 60.

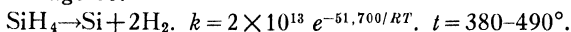

Hogness, Wilson and Johnson, *J. Am. Chem. Soc.*, **58**, 108 (1936).

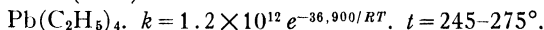

Leermakers, *J. Am. Chem. Soc.*, **55**, 4508 (1933).

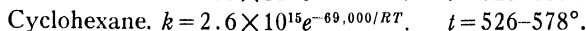
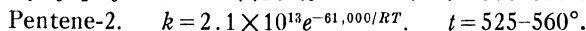
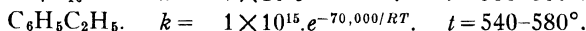
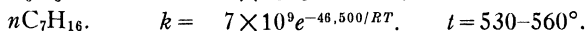
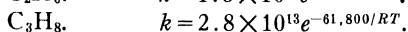
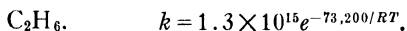
Hydrocarbons.

Pease and Morton, *J. Am. Chem. Soc.*, **55**, 3190 (1933).

Egloff and Parrish, *Chem. Rev.*, **19**, 145 (1936).

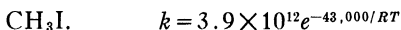
Organic halogen compounds.

Ogg, *J. Am. Chem. Soc.*, **56**, 526 (1934)

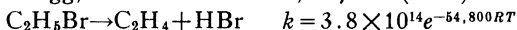

Page 72.

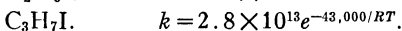
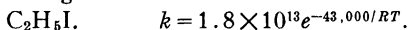

Ogg, *J. Am. Chem. Soc.*, **56**, 526 (1934).

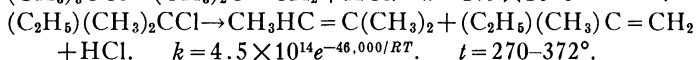
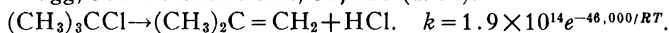

Brearely, Kistiakowsky and Stauffer, *J. Am. Chem. Soc.*, **58**, 43 (1936).

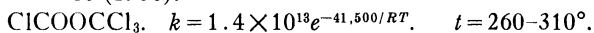

Ramsperger and Waddington, *J. Am. Chem. Soc.*, **55**, 214 (1933).

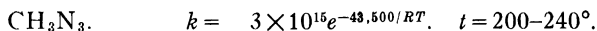
Organic nitrogen compounds.

Leermakers, *J. Am. Chem. Soc.*, **55**, 3098 (1933).

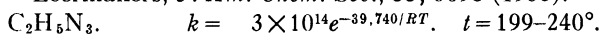

Leermakers, *J. Am. Chem. Soc.*, **55**, 2719 (1933).

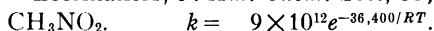

Stearie and Shaw, *Proc. Roy. Soc. London*, **A146**, 388 (1934).

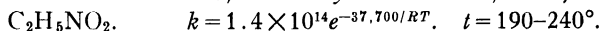

Stearie and Shaw, *J. Chem. Phys.*, **2**, 345 (1936).

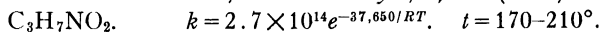

Stearie and Shaw, *J. Chem. Phys.*, **3**, 344 (1935).

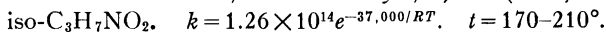

Stearie and Shaw, *Proc. Roy. Soc. London*, **A151**, 685 (1935).

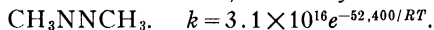

Ramsperger, *J. Am. Chem. Soc.*, **49**, 1495 (1927).

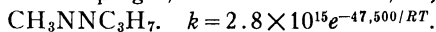

Ramsperger, *J. Am. Chem. Soc.*, **51**, 2134 (1928).

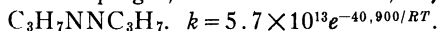

Ramsperger, *J. Am. Chem. Soc.*, **50**, 714 (1928).

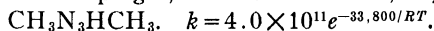

Ramsperger and Leermakers, *J. Am. Chem. Soc.*, **53**, 2061 (1933).

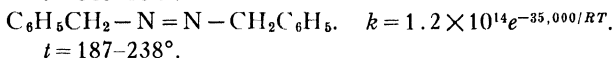
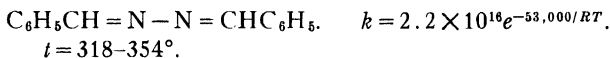

Williams and Lawrence, *Proc. Roy. Soc. London*, **A156**, 444, 455 (1936).

Organic oxygen compounds.

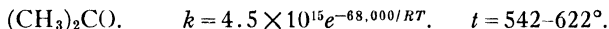

Winkler and Hinshelwood, *Proc. Roy. Soc. London*, **A149**, 340 (1935).

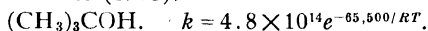

Schultz and Kistiakowsky, *J. Am. Chem. Soc.*, **56**, 395 (1934).



Coffin, *Can. J. Research*, **5**, 636 (1931); **6**, 417 (1932); **7**, 75 (1932); **9**, 603 (1933).

Isomerizations.



Chambers and Kistiakowsky, *J. Am. Chem. Soc.*, **56**, 399 (1936).

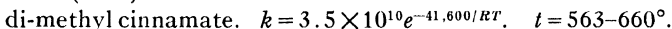

Kistiakowsky and Smith, *J. Am. Chem. Soc.*, **57**, 269 (1935).

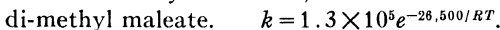

Nelles and Kistiakowsky, *J. Am. Chem. Soc.*, **54**, 2208 (1932).

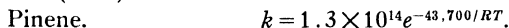

Thurber and Johnson, *J. Am. Chem. Soc.*, **52**, 786 (1930).



Kistiakowsky and Smith, *J. Am. Chem. Soc.*, **56**, 638 (1934).

BIMOLECULAR REACTIONS.

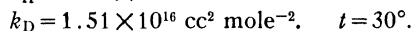
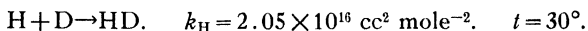

Amdur, *J. Am. Chem. Soc.*, **57**, 856 (1935).

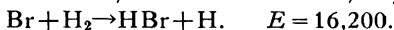

Bach, Bonhoeffer and Moelwyn-Hughes, *Z. physik. Chem.*, **27B**, 71 (1934).

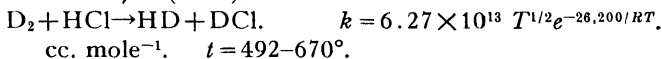

Gross and Steiner, *J. Chem. Phys.*, **4**, 165 (1936).

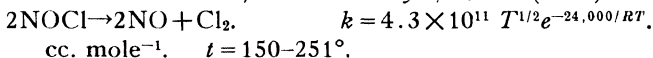

Waddington and Tolman, *J. Am. Chem. Soc.*, **57**, 689 (1936).

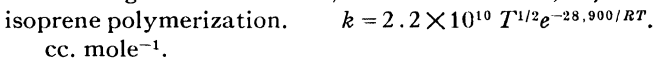

Vaughan, *J. Am. Chem. Soc.*, **55**, 4109 (1933).

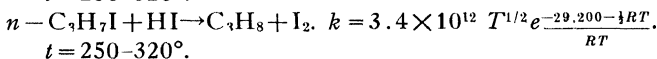
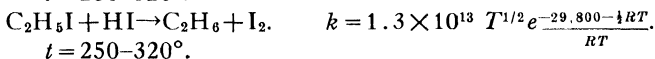
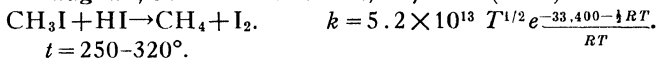

Ogg, *J. Am. Chem. Soc.*, **56**, 526 (1934).

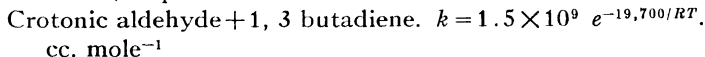
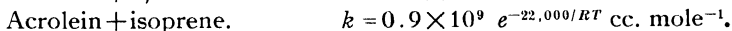
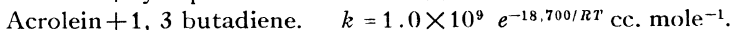
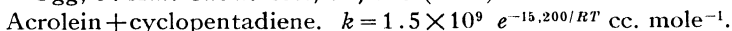

Kistiakowsky and Lacher, *J. Am. Chem. Soc.*, **58**, 123 (1936).

CHAPTER V

CHEMICAL KINETICS OF REACTIONS IN SOLUTION

A WEALTH of experimental material on reaction rates in solution is available, both in aqueous and non-aqueous solutions. The literature describes so many reactions that it is difficult to single out the significant ones. In our work we shall say very little regarding aqueous solutions because this field is a special subject of large magnitude, and we shall confine ourselves chiefly to a few non-aqueous reactions, comparing them when possible with the gas phase reaction and discussing particularly the effect of the solvent. Reactions in solution are of great practical importance. As a matter of fact, reactions in the gas phase are not very important from a practical standpoint, and the number of examples is not large. All biological reactions and a large proportion of the reactions of organic chemistry and analytical chemistry are reactions occurring in solution. Important as these reactions are, we know very little about their fundamental nature. The nature of gases has been understood for a good many years, and the mathematical treatment of the kinetic theory of gases has been outstandingly successful. With the advent of X-rays our knowledge of the crystalline state has advanced very rapidly, but we know practically nothing of the nature of the liquid state. But because of its pioneer character this field of study is intriguing.

The molecules of a liquid are held together partly by van der Waal's forces and in many cases there is an association or combination of molecules. Recent progress in the theory of the liquid state seems to indicate that there are statistical deviations in the distribution of molecules and that they are involved in the diffraction patterns produced when a beam of X-rays is passed through a liquid. A liquid seems to behave as if there were clusters of molecules distributed through it. Associated liquids, such as water, alcohol, ammonia, and other polar liquids, show abnormally high

surface tensions and heats of vaporization, and attempts have been made to apply the simple laws of chemical equilibrium to these association processes. Qualitatively these pictures may be satisfactory, but quantitatively they leave much to be desired.

Prediction of solubility and explanation of the behavior of different solvents has not yet been put on a satisfactory quantitative basis.¹ In many cases the solute combines with the solvent to form some kind of a chemical compound, and to this process is given the term solvation. Considerable progress has been made very recently in classifying and explaining different types of solvation. There is hope of putting this concept of solvation on a quantitative basis for kinetics through considerations of energy.

Calculations of collisions between molecules of a liquid have been made but the postulates on which they rest are not fully established. In fact it is not easy to define a collision between molecules of a liquid or between a solute molecule and a solvent molecule. In gases collision is pictured as a clean-cut process like the collision and rebound of two billiard balls, but in solution the solute molecule is always in contact with a solvent molecule and one might well consider a collision between them as a "continuing" or "sticky" collision. The frequency of collision and the mean free path are indefinite. We have no clear picture nor definition and it is not surprising that the mathematical formulas proposed are unsatisfactory. Collisions of one solute molecule with another solute molecule, however, seem to be capable of exact description, at least in some cases.

· COLLISION FREQUENCY

There is much in favor of the assumption that in the ideal case the molecules of a solute behave in an inert solvent as if they were gas molecules. This is the simplest and most useful assumption. It receives support from the well established principles of physical chemistry according to which osmotic pressure, vapor pressure, and related phenomena in dilute solutions are calculated by means of the simple gas laws.

Most important of all, there is direct experimental proof, in a few cases, that the solute molecules behave in an inert solvent as they would in the gas phase. Unfortunately the number of cases

¹ See however Hildebrand, *Solubility*, Reinhold Publishing Co., New York (1936).

where direct comparison of reaction rates can be made is very limited; and it seems rather arbitrary to exclude, on the basis of interaction with the solvent, several reactions where there is no agreement between gas phase and solution.

When there is no solvation and no electrostatic attraction it is probably safe to use the standard formula

$$z_{1,2} = \sigma_{1,2}^2 n_1 n_2 \sqrt{8\pi RT(1/M_1 + 1/M_2)} \quad (1)$$

for unlike molecules, where z is the number of collisions per second per cc., M_1 and M_2 are the molecular weights, $\sigma_{1,2}$ is the average diameter of the two different molecules and n_1 and n_2 are the numbers of molecules per cc. of effective volume (taking into account the volumes of the molecules themselves). Changing to the more often used units of moles per liter instead of molecules per cc. and inserting the collision formula into the fundamental Arrhenius equation we have for a bimolecular reaction in gas phase or uncomplicated solution.

$$k = z_{1,2} e^{-E/RT} = \frac{n_1 n_2}{1000} \sigma_{1,2}^2 \sqrt{8\pi RT(1/M_1 + 1/M_2)} e^{-E/RT}. \quad (2)$$

The molecular diameter is not known as well for solutes as for gases; but, fortunately, useful calculations of collision frequencies may be made even when the diameters are inaccurately known. The diameter of the gas molecule can often be used for the solute molecule. Fairly satisfactory results may be obtained with a formula involving the cube root of the molar volume, v , of the pure liquid or solid solute using the formula

$$\sigma = 1.33 \times 10^{-8} \sqrt[3]{v}. \quad (3)$$

An interesting classification of reactions in solution has been made by Moelwyn-Hughes² on the basis of equation (2). This author, who has published many researches on the theory of kinetics of reactions in solution, has examined many bimolecular reactions in solutions and calculated z by equation (2) and E by the standard method of plotting $\log k$ against $1/T$ from the experimental data at different temperatures. He then calculates k by equation (2) and compares it with the experimentally observed rate constant. If the two agree within a factor of ten or so, the reac-

² Moelwyn-Hughes, *Chem. Rev.*, **10**, 241 (1932); *Kinetics of Reactions in Solution*, Oxford University Press, Oxford (1933).

tion has a "normal" velocity. In general, reactions between a neutral molecule and a charged ion give "normal" velocities. An example of this type is the reaction in alcohol solution between an ethoxide ion from an alcoholate and an alkyl halide, such as

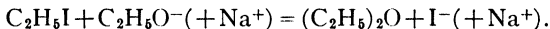

For this reaction E has a value of 20,740 and z a value of 2.14×10^{-11} . These constants reproduce closely the experimental values when put into the Arrhenius equation. Many such reactions will not go at all in the gas phase or in non-ionizing solvents. Apparently some type of intermediate complex involving an ion is a prerequisite to reaction in these cases.

Many reactions are "abnormally" slow on account of combination with the solvent, which may change greatly the true value of the activation energy. For example the reaction

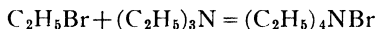

in acetone at 60° has a calculated specific reaction rate of 1×10^4 and observed value of 1.7×10^{-4} . Other reactions of this general type with velocities ranging from one ten-thousandth to one billionth of the calculated value may find their explanation in varying degrees of solvation and ionization.

COMPARISON BETWEEN REACTIONS IN GAS AND IN SOLUTION

It would be extremely valuable to compare a given reaction in the gas phase with the same reaction occurring in solution. The kinetic theory of gases is well developed, and a comparison of a given reaction in both systems would help to solve the problem of molecular collisions in liquids and throw light on the nature of solution. The general behavior is similar in that we find in both cases reactions classified as first and second order. We find chain reactions occurring in both systems, and most important of all we find that the Arrhenius equation, $k = se^{-E/RT}$, applies equally well to reactions in the gas phase and in solution. In gas reactions vacuum may be considered as the solvent and its properties then reduce to zero. If we can compare a given reaction in solution with the same reaction in the gas phase we have a means of evaluating one of the variables—the solvent.

Direct experimental comparison, however, is very difficult. In the first place the temperature range of solvents is limited, from 0° to 100° in the case of water. Most organic solvents are

similarly limited. Fused salts and metals offer opportunities for high temperature work, but few measurements of reaction rates have been made in such solvents. In this rather restricted temperature range only a few gas reactions are known which proceed with sufficiently rapid velocity for convenient measurement. Many gas reactions are complicated by wall effects. Chains are stopped or initiated at the walls and a catalytic effect of the walls themselves or of a material deposited on the walls may greatly affect the reaction rate. In solution, on the other hand, the reactions are usually complicated by solvation. In the gas phase the products of the reaction are immediately lost in the mass of molecules, whereas in solution the products may be kept close to their starting point by molecular collision.

It is an open question as to which is simpler for theoretical study—reactions in gas phase where wall effects can complicate the situation or reactions in solution where solvation may be an important factor.

There are very few cases where one can compare directly the same reaction taking place by the same mechanism in both gas phase and solution. If at all temperatures the reactions have equal velocities in the two phases the values of s and of E are the same, and it may be safely assumed that the reaction mechanisms are identical and the solvent has no effect. Undoubtedly the simplest comparison exists in the unimolecular decomposition of nitrogen pentoxide and in this reaction the solvent has little effect. The unimolecular racemization of pinene at 200° proceeds at the same rate in the gas phase, in liquid pinene and in a solution of petroleum.

Up to the present time there are three cases where a thermal, *bimolecular* reaction appears to be the same in gas phase and solution. The thermal decomposition of chlorine monoxide is complicated but the time required to decompose from twenty per cent to sixty per cent at 65° is the same in carbon tetrachloride solution as in the gas phase.³

The reaction

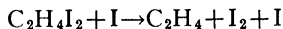

has been studied in solution⁴ and in the gas phase. Extrapolating

³ Moelwynn-Hughes and Hinshelwood, *Proc. Roy. Soc. London*, **A131**, 177 (1931).

⁴ Polissar, *J. Am. Chem. Soc.*, **52**, 956 (1930).

Arnold and Kistiakowsky, *J. Chem. Phys.*, **1**, 166 (1934).

the results in the gas phase to the temperature of the reaction in solution it is concluded that the reaction mechanism, the value of s and the value of E are essentially the same and that the solvent has little influence. The conversion of parahydrogen into ortho-hydrogen catalyzed by oxygen molecules has the same rate in the gas phase and in aqueous solution.⁵ The first of these reactions has an activation energy of 21,000 calories, the second 12,200, and the third has zero energy of activation. None of them constitutes an entirely satisfactory, clean cut example. New reactions permitting direct comparison of simple bimolecular reactions are greatly to be desired.

The reaction between oxalyl chloride and water⁶ offers a good illustration of the difficulties involved. The reaction

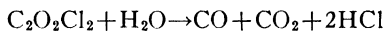

goes quantitatively, apparently without complicating side reactions. In the gas phase the pressure doubles and the experimentally determined final pressure agrees within a few tenths of a millimeter with the theoretical value. In carbon tetrachloride solution it is an excellent second order reaction but in the gas phase the reaction follows a fractional order and is undoubtedly a chain reaction. A solid is produced as an intermediate step and condenses temporarily on the vessel walls. In the gas phase the reaction is more exothermic than in solution and the conditions are more favorable for chain reactions. In spite of all these complications it can be stated that the specific decomposition rate in the gas phase is a thousand or more times as great as the corresponding rate in carbon tetrachloride solution. This great difference does not necessarily mean that the solvent affects the collisions between the oxalyl chloride and the water and slows down the reaction. More likely it means simply that the mechanism of reaction in the two phases is different. It is probable that the reaction in solution is the more normal and that the gas phase reaction is complicated by walls and chains.

Photochemical reactions offer a larger opportunity for direct comparison of the gas phase and solution. The limitations of temperature range do not apply so severely to photochemical reactions, for in both gas phase and solution there are a great many reactions which can be brought about by photochemical excitation

⁵ Farkas and Sachsse, *Z. physik. Chem.*, **B23**, 1 (1933).

⁶ Fugassi, *Ph.D. Thesis*, University of Wisconsin (1934).

at room temperatures where most liquid solvents are stable. These reactions will be discussed in some detail later. In general it may be said that there are a few reactions such as the photodecomposition of hydroiodic acid which give the same efficiency of decomposition in the gas and liquid phases. In other words the solvent has no effect. In the hydroiodic reaction and several others the absorption spectrum in the two cases is the same and there is every reason to believe that the primary photochemical process is the same.

In general, however, the photochemical reactions are less efficient in solution than in the gas phase on account of secondary reactions which follow the primary absorption of light. The solvent can deactivate an excited molecule in photochemical reactions such, for example, as the photolysis of nitrogen pentoxide or nitrogen dioxide. In these reactions an inert solvent such as carbon tetrachloride reduces the reaction to only one per cent of its value in the gas phase. Again the solvent may reduce the reaction by keeping the fragments of the photochemical reaction close together thereby increasing the chance of recombination and favoring the reverse reaction. In certain chain reactions such as the chlorine-sensitized photo-oxidation of tetrachloro-ethylene the yield is much less on account of the breaking of a chain reaction by the solvent.

✓ SOLVATION

Combination between solute and solvent is undoubtedly responsible for the effect of solvents in the majority of cases. This solvation may give an intermediate complex of high stability or low stability. If the complex is stable the reaction will go slowly; if unstable it will go rapidly. In other cases the solvent effect can sometimes be explained as due to a varying degree of electrolytic dissociation. Specific reactions will be given presently, illustrating these different factors.

There are several ways, however, in which a so-called solvent effect may be without any theoretical significance because it is due to secondary complications. For example, bromine dissolved in carbon tetrachloride may react with certain substances rather slowly as bromine molecules, but when it is dissolved in water it may react much more rapidly as hypobromous acid. There is no point in comparing the reaction rates in the two solvents, for the

reactions are utterly different. Moreover the extent to which carbon tetrachloride or other inert solvent contains dissolved water may determine the rate of reaction under these conditions. It is possible that the same type of complication may sometimes result from dissolved air. For example⁷ the rate of bromination of cinnamic acid depends on the amount of oxygen dissolved in solution and the order in which different solvents affect the rate of bromination may depend in part on the relative solubilities of atmospheric oxygen.

In certain other reactions, particularly the keto-enol transformations, dissolved alkali from the glass may be an important factor in changing the rate in different solvents. Again, the appearance of a heterogeneous phase may lead to erratic changes in velocity which are not significant. For example, in the reaction between oxalyl chloride and water, already referred to, it was found that chilling the carbon tetrachloride solution led to a great increase in rate. This unexpected behavior was traced to the precipitation of water droplets at the low temperature, and this colloidal water remained suspended for a long time after the solution was again heated. Some solvent effects can be attributed to the chain-stopping properties of the solvent or impurities which it contains.

When secondary complications are surely eliminated, it is worth while to examine the possibilities of solvation in comparing reaction rates in various solvents and in the gas phase. An important classification of different types of solvation has been made recently by Moelwyn-Hughes and Sherman⁸ emphasizing the different kinds of electrostatic attractions. Quantum mechanical calculations are satisfactory in explaining strictly homopolar bonds but electrostatic forces are important not only in electrolytic solutions but also in many reactions which are not considered to be ionic.

There are three sources of electrostatic attractions—ions, as in sodium chloride, permanent dipoles as in polar substances like water, and induced dipoles corresponding to van der Waals forces in neutral atoms and molecules. Now electrostatic interactions exist between these three different units giving rise to six different types of complex formation. When the solvent is involved as one

⁷ Bauer and Daniels, *J. Am. Chem. Soc.*, **56**, 2014 (1934); Sutherland, *Ph.D. Thesis*, University of Wisconsin (1936).

⁸ Moelwyn-Hughes and Sherman, *J. Chem. Soc.*, 101 (1936).

unit we have solvation. Examples are known of all these six types of attraction but it must be realized that the distinctions are not sharp and that there is overlapping of types. All these electrostatic attractions are affected by the dielectric constant of the medium, the bonds becoming weaker in solution than in the gas phase and still weaker in solutions of high dielectric constant. Even though the molecules, atoms or ions are held together by very weak forces and the complexes which are formed may be fleeting, they may nevertheless be of importance in determining the course and velocity of a chemical reaction.

Reactions between two ions of opposite charge, such as

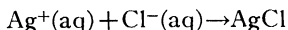

have not been studied kinetically, as yet, because they proceed too rapidly for practical measurement with present techniques. Ionic reactions which require the breaking of a homopolar bond or the occurrence of a triple collision may be slow. These cases will be discussed a little later. The electrostatic forces attracting oppositely charged ions are very great, amounting for example in the case of Na^+ and Cl^- to 197,000 calories. It is strange at first sight that forces as great as this can be so easily overcome by a solvent but sodium chloride, for example, dissolves in water with practically no heat effect. The reason, of course, lies in the solvation of the ions, the energy evolved being of the same order of magnitude as that required to separate the two ions.

In case the energies of solvation should exceed the energy of the crystal lattice the union of the two unsolvated ions would require the introduction of energy and such a reaction would be slow, because the energy requirement would have to be met from the fast moving molecules given by the Maxwell-Boltzmann distribution. The solvation of ions in polar solvents like water is an example of electrostatic attraction between an ion and a permanent dipole. It plays an important part in physical chemical processes, and although it has been the subject of many experimental researches there is much to be done in theoretical study. The solvation of ions may be definite as in $\text{Cu}(\text{NH}_3)_4^{++}$ or indefinite as in $\text{Na}^+ \cdot n\text{H}_2\text{O}$. It is carried over into the crystal state as in hydrated crystals like $\text{CuSO}_4 \cdot 5\text{H}_2\text{O}$. This ion-dipole attraction embraces in part the coordinate link emphasized by Sidgwick.⁹

⁹ Sidgwick, *Some Physical Properties of the Coordinate Link in Chemistry*, Cornell University Press, Ithaca, N. Y. (1933).

The coordinate links are intermediate in properties between the covalent (non-polar) bond and the electrovalent (polar) link. As a matter of fact the coordinate links are especially important in the chemical kinetics of solutions because they have energies of about the right order of magnitude to give reactions proceeding with measureable speed. Covalent links require so much energy that the reactions can not go with measurable velocity in the temperature range of ordinary liquid solvents and ionic reactions usually require so little energy for activation that they go too fast to be measured.

The consideration of electrostatic attraction appears to be particularly promising in reactions between two dipoles as pointed out by Moelwyn-Hughes and Sherman. It is this type of attraction that accounts for compounds such as $(\text{CH}_3)_2\text{CO} \cdot \text{CHCl}_3$ where the acetone and the chloroform each have dipole moments and form a stable complex which, in fact, can be isolated. The vapor pressure, viscosity and solubility relations show that the solution is far from ideal, and mixtures of the two give anomalous effects on certain reaction rates when used as a solvent. There are many examples of formation of complexes among these slightly polar organic compounds. Direct measurements of the heat of mixing can usually be made, and in many cases have been made. Indirect measurements can be made through estimations of the equilibrium constant at different temperatures. Frequently a plot of the freezing point against composition shows a maximum which is definite proof of the formation of a complex. The dependence of these complexes on the dielectric constant of the solution is shown by the following equation.

$$\epsilon = \frac{2\mu_A\mu_B}{Dr_0^3} \quad (4)$$

in which ϵ is the energy of two molecules held together in a head-on position and μ_A , μ_B , D , and r_0 are respectively the dipole moments of the substances A and B, the dielectric constant of the medium and the shortest distance separating the two molecules. When r_0 is expressed in Ångstrom units and μ in Debye units (10^{-18} electro static units) we have

$$\epsilon = \frac{28.9\mu_A\mu_B}{Dr_0^3} \text{ kilogram calories per mole.} \quad (5)$$

Moelwyn-Hughes and Sherman point out that in most cases of

interest in chemical kinetics one can assume that μ varies from 0.2 to 3, that r_0 varies from 1 to 4 and D varies with any solvent from 2 to 80. Then ϵ varies from about 200 to 15,000 calories per mole and can easily account for solvent effects of about the right order of magnitude. Many of the abnormally slow reactions referred to before, such as the reactions between amines and halides, can be explained on the basis of complex formation of this type. The energy of this formation is included in the observed energy of activation and since the value of E is increased by solvation the value of k is decreased. When proper corrections are made for the formation of an intermediate compound or complex the reactions are likely to become "normal" in their rates. Moreover the effect of dielectric constant and dipole moment are clearly predictable from equation (5). As the dielectric constant of the solvent becomes larger the energy of solvation becomes less and the reaction rate becomes more nearly "normal." Again with solvents of approximately the same dielectric constant the velocity increases with a decrease in the dipole moment.¹⁰

Solvation may result from weak electrostatic forces, such as that which exists between a dipole and an induced dipole, giving rise to the formation of hydrates of halogens ($\text{Cl}_2 \cdot \text{H}_2\text{O}$) or hydrocarbons ($\text{C}_4\text{H}_{10} \cdot \text{H}_2\text{O}$) but the energies involved are too small to have a very pronounced effect on the reaction rates.

THE DECOMPOSITION OF NITROGEN PENTOXIDE

The simplest reaction which has been studied directly in the gas phase and in solution is the decomposition of nitrogen pentoxide.¹¹ It is not a chain reaction and it is free from wall effects. The gas phase reaction seems to be free from complications and it has been checked in many laboratories. It is an excellent unimolecular reaction, the decomposition rate being exactly proportional to the concentration. This proportionality constant is nearly the same from 0.05 mm. to 1,000 mm. in the gas phase and up to an osmotic pressure of fifty atmospheres in solution, and the energy of activation is practically the same in the gas phase and in a group of chemically inactive solvents.

Solvent Effects. In the experimental measurements on solutions the purified nitrogen pentoxide in various solvents is sealed off in

¹⁰ Grimm, Ruf and Wolff, *Z. physik. Chem.*, **13B**, 301 (1931).

¹¹ Daniels and Johnston, *J. Am. Chem. Soc.*, **43**, 53 (1921).

Eyring and Daniels, *J. Am. Chem. Soc.*, **52**, 1472 (1929).

a small glass flask which in turn is sealed to a long glass tube, one millimeter in diameter, in the shape of a semicircle having a radius of about one meter. The flask is agitated back and forth with a pendulum motion at the rate of sixty to one-hundred oscillations per minute in such a way that the glass bends sufficiently to avoid breaking. A couple of glass beads in the flask serve to agitate the solution and prevent supersaturation of oxygen gas. To prevent the escape and later measurement of nitrogen dioxide and nitrogen pentoxide, a small section of glass wool saturated with concentrated sulphuric acid is inserted in the tube. Only oxygen is able to reach the measuring burette. A compensating burette is set at the side of the measuring burette and the confining liquid is drained out of the stopcock at the bottom until the two levels are equal, thus insuring constant pressure conditions. Nitrobenzene was found to be a good confining liquid because of its low vapor pressure.

The amount of nitrogen pentoxide remaining in solution is at all times proportional to the volume of oxygen that can be obtained in the subsequent decomposition—i.e., $v_{\infty} - v_t$ where v_t is the volume at any time t and v_{∞} is the final volume obtained when the reaction is complete. The logarithm of $(v_{\infty} - v_t)$, plotted against time gives an excellent straight line, and the slope of this line multiplied by 2.303 gives directly the specific decomposition constants. No correction of any kind is necessary in the calculations. The results at various temperatures with different solvents are summarized in Table I.

TABLE I
THE SPECIFIC DECOMPOSITION RATE OF NITROGEN PENTOXIDE IN
VARIOUS SOLVENTS

Solvent	Values of $k \times 10^4 \text{ sec.}^{-1}$			Energy of Activation calories
	15°	20°	25°	
Nitrogen tetroxide	0.159	0.344		25,000
Ethylidene chloride		0.322		24,900
Chloroform		0.274	0.554	24,600
Ethylene chloride		0.238	0.479	24,400
Carbon tetrachloride		0.235	0.469	24,200
Pentachloroethane		0.220	0.430	25,000
Bromine	0.114	0.215		24,000
Gas phase	0.079	0.165		24,700
Nitromethane	0.075			24,500
Nitric acid	(at 45° $k = 0.00002$)			28,300
	(at 45° in the gas phase $k = 0.00050$)			

In liquid nitrogen tetroxide the decomposition is about twice as rapid as in the gas phase where vacuum may be considered as the "solvent." In nitromethane the decomposition is slightly slower than in the gas phase. Other solvents, as widely different as liquid bromine and carbon tetrachloride, give values which are only slightly greater than those in the gas phase.

Saturated Solutions. This reaction offers a uniquely favorable opportunity for theoretical study because it is possible to measure the rate of decomposition of saturated as well as unsaturated solutions. When the crystalline nitrogen pentoxide is present in excess the concentration of unsolvated nitrogen pentoxide is fixed and equal to that in the gas phase. It is measured by the sublimation pressure of nitrogen pentoxide. In addition to these unsolvated molecules of nitrogen pentoxide there are other molecules of nitrogen pentoxide which may be considered as forming some kind of a loose complex with the solvent, probably by means of dipole or induced dipole attraction. It is an experimental fact that much more nitrogen pentoxide will enter a given volume if a suitable solvent is present than if only a vacuum exists.

In Fig. 20 the relation between solvated and unsolvated molecules is shown.

The oxygen evolved from such a saturated system containing excess crystals of nitrogen pentoxide may come from gaseous nitrogen pentoxide, from unsolvated nitrogen pentoxide, or from solvated nitrogen pentoxide. The amount of nitrogen pentoxide gas is made so small that the contribution of oxygen from this source is negligible. The sublimation pressure is very low compared to the osmotic pressures in solution, and the free space above the liquid is made negligibly small.

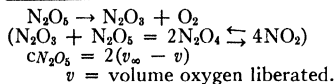
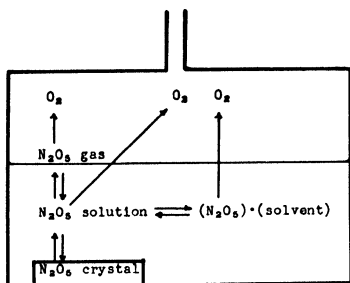

FIG. 20.—Diagrammatic representation of the decomposition of a saturated solution of nitrogen pentoxide.

If the unsolvated molecules are the only ones which decompose, the decomposition rates, $\frac{-dc}{dt}$ should

be the same in all solvents. If solvated and unsolvated molecules decompose at *equal* rates the specific decomposition rate calculated by the standard first order formula should be the same in all solvents. As soon as one molecule decomposes another one from the crystal goes into solution and takes its place. In this way the concentration is maintained constant, and the formula

$$k = \frac{-dc}{dt} \frac{1}{c} \text{ applies.}^{12}$$

The results are summarized in Table II. The column entitled c_s gives the concentration in moles per liter of the saturated solution. The column r gives the rate in moles per liter at which oxygen is evolved. In the last column, labeled k , this rate of oxygen evolution is divided by the concentration of nitrogen pentoxide to give the standard specific decomposition rate. It will be noted that the rates in different solvents given in the last and the next to the last column are not the same, and we conclude accordingly that the solvated molecules do decompose as well as the unsolvated, but in the liquid solvents investigated here they decompose at a different rate.

La Mer has suggested that these deductions are valid only in case the solubility of the activated nitrogen pentoxide molecules is the same as that of the normal nitrogen pentoxide molecules. No measurements are available for the solubility of the activated nitrogen pentoxide molecules, but according to La Mer¹³ the solubility would be different and one would not expect the velocity constants to be the same in the different solvents on account of this complication.

TABLE II
DECOMPOSITION OF NITROGEN PENTOXIDE IN SATURATED SOLUTIONS AT 15°

Solvent	c_s Moles per liter	r $\frac{-dc}{dt}$	k $\frac{-dc}{dt} \frac{1}{c}$
Vacuum (Gas phase)	0.0102	0.008×10^{-5}	0.79×10^{-5}
Nitromethane	4.38	5.92×10^{-5}	1.35×10^{-5}
Carbon tetrachloride	4.78	8.72×10^{-5}	1.83×10^{-5}
Nitrogen tetroxide	—	—	1.59×10^{-5}

The solvents discussed thus far have but slight influence on the decomposition but other solvents exert a marked influence.

¹² Page 12.

¹³ La Mer, *J. Chem. Phys.*, **1**, 289 (1933).

Of these, nitric acid is one of the most interesting. One-hundred per cent nitric acid was made by adding crystalline nitrogen pentoxide to white fuming nitric acid which contains about ninety-two per cent of nitric acid and eight per cent of water. The acid was analyzed and the calculated weight of nitrogen pentoxide added. This pure nitric acid is probably stable in the dark at ordinary temperatures but extra nitrogen pentoxide, dissolved in it, decomposes very slowly. The energy of activation was found to be 28,300 instead of the normal 24,700 and this extra energy of activation amounting to 3,600 calories makes an enormous difference in the temperature coefficient of decomposition rate. Saturation occurs at 25° at a concentration of about thirty-six per cent nitrogen pentoxide but the decomposition is slight, the total decomposition being about the same as that calculated for the gas phase saturated at 25°. At 45° the decomposition is considerably more rapid, for then the solvated molecules are also decomposing.

If some kind of a complex is formed between nitrogen pentoxide and pure nitric acid involving the evolution of 3,600 calories of heat, and if this 3,600 calories of energy must be supplied in addition to the 24,700 required to decompose pure nitrogen pentoxide, the experimental facts already described would be explained. Experiments are planned to determine the heat evolved when nitrogen pentoxide is added to pure nitric acid. The molecules of nitrogen pentoxide which are solvated with nitric acid apparently do not decompose at low temperatures with a measurable rate. This fact seems to be borne out also by the experimental findings that at 0° the decomposition rate of nitrogen pentoxide in a saturated solution of pure nitric acid is the same as in the gas phase.

Although the *specific* decomposition rate is much lower in nitric acid solution the decomposition still follows the first order law because the number of simple molecules which decompose is always proportional to the total concentration of nitrogen pentoxide at any time, and this is the criterion of a unimolecular reaction.

The nitric acid solution may be treated mathematically on the assumption that the slow rate is due to the existence of an equilibrium number of stable complex molecules. The energy of activation, 28,300 calories, is 3,600 calories greater than the energy of activation in the gas phase or in inert solvents as shown below, and the following reaction may be written

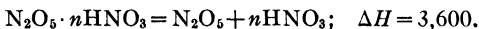

The equilibrium constants for this reaction may be written

$$K = \frac{c_{\text{HNO}_3}^n c_{\text{N}_2\text{O}_5}}{c_{\text{N}_2\text{O}_5 \cdot n\text{HNO}_3}} \quad (6)$$

and since $\Delta F = -RT \ln K$, and $\Delta F = \Delta H - T\Delta S$

$$\ln K = \frac{-\Delta H}{RT} + \frac{\Delta S}{R} \quad (7)$$

where F is free energy, H is heat content, S is entropy and T is absolute temperature. Putting this into the exponential form

$$\frac{c_{\text{HNO}_3}^n c_{\text{N}_2\text{O}_5}}{c_{\text{N}_2\text{O}_5 \cdot n\text{HNO}_3}} = e^{\Delta S/R - \Delta H/RT}. \quad (8)$$

The rate of decomposition is given by the expression

$$\frac{-dc_{\text{N}_2\text{O}_5}}{dt} = kc_{\text{N}_2\text{O}_5} = \frac{k c_{\text{N}_2\text{O}_5 \cdot n\text{HNO}_3}}{c_{\text{HNO}_3}^n} e^{(\Delta S/R) - (\Delta H/RT)} \quad (9)$$

The fraction of the nitrogen pentoxide molecules decomposing per second is k and by the Arrhenius equation

$$k = se^{-E/RT}$$

where s is a constant and E is the energy of activation. Then

$$\frac{-dc_{\text{N}_2\text{O}_5}}{dt} = \left(s \frac{c_{\text{N}_2\text{O}_5 \cdot n\text{HNO}_3}}{c_{\text{HNO}_3}^n} e^{\Delta S/R} \right) e^{-(E+\Delta H)/RT}. \quad (10)$$

In solutions containing a large excess of nitric acid solvent, the quantity in the parentheses is nearly proportional to $c_{\text{N}_2\text{O}_5}$, and since ΔS changes but slightly with temperature, the quantity is nearly independent of temperature. The value of $E+\Delta H$ may then be calculated with fair accuracy from the experimentally determined temperature coefficient of the reaction rate in the usual manner.

$E+\Delta H$ was found to be 28,300 and E for simple nitrogen pentoxide molecules has been found repeatedly to have the value 24,700. The heat of formation of the solvated molecules is then 3,600 calories.

The formation of a chemical compound with the added sub-

stance (solvation in the case of a solvent) may lead to an increase in reaction rate as well as to a decrease. If the compound is stable the reaction will be slower; if unstable it will be faster.

The effect of several foreign gases was determined¹⁴ by plotting the increasing pressure of nitrogen pentoxide against time, and introducing a definite amount of another gas when the reaction was partially completed. The pressure rose immediately, but when the ordinates of the upper curve were all lowered by a definite amount to connect with the lower curve, any discontinuity was readily detected.

Nitrogen, oxygen, hydrogen, and bromine are among some of the gases which produced no difference in the rate of decomposition—the curve being perfectly smooth throughout with no change in slope after adding the foreign gas. With ether vapor the case was quite different as shown in Fig. 21. Immediately a consider-

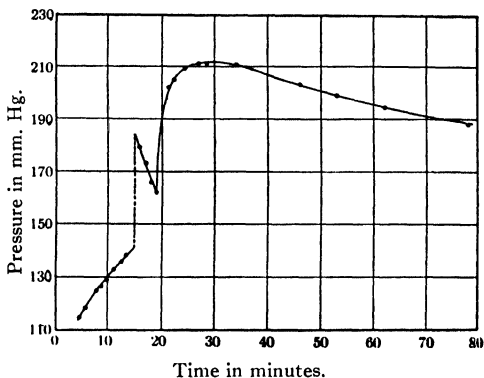

FIG. 21.—Decomposition nitrogen pentoxide in the presence of ether at 45°.

able decrease in pressure occurred indicating that some kind of combination had taken place and molecules were disappearing from the gas phase. Within ten minutes, however, a rapid increase in pressure occurred, approaching the conditions for an explosion. Secondary reactions occurred, as illustrated by the fact that after a maximum was reached the pressure continued to decrease. In the case of butyl ether and acetone the pressure decreased continuously and failed to show a later increase. Intermediate complexes

¹⁴ Busse and Daniels, *J. Am. Chem. Soc.*, **49**, 1257 (1927).

here must have been more stable than the intermediate formed with ethyl ether. It should be pointed out, however, that in later experiments when large amounts of acetone and of butyl ether were used, violent explosions occurred. Addition of molecules has been generally established in many organic reactions as a precursor to chemical reaction, and these experiments with nitrogen pentoxide seem to offer a definite illustration. The relative stability of an intermediate compound is frequently the deciding factor in catalysis and in chemical reaction in general.

THE DECOMPOSITION OF CHLOROACETATE ION

Trichloroacetic acid decomposes in certain solvents in the neighborhood of 100° to give chloroform and carbon dioxide. A much higher temperature is required for decomposition in the gas phase and then a different set of products is obtained. The reaction is interesting because it illustrates¹⁵ how in at least one case the solvent effect and a whole mass of complex data can be nicely interpreted.

Experimental measurements were carried out in several different solvents by two or three different methods. In some cases a shaking device was used and the rate of the reaction was followed by the evolution of carbon dioxide. In other cases the course of the reaction was followed by titrations using solutions which were sealed off in glass tubes immersed in thermostats and opened up under standardized sodium hydroxide or acid, as the case demanded. Many different tubes of the same solution were sealed off at once and each tube was used for a point on the time-concentration curve. The rate constant was determined from the slope of the line obtained by plotting the logarithm of the concentration against the time.

Trichloroacetic acid decomposes in water, alcohol and aniline and other basic solvents but it does not decompose in non-basic solvents such as benzene, carbon tetrachloride, sulfuric and acetic acid. Furthermore, the ethyl ester of trichloroacetic acid dissolves in alcohol but it does not decompose. It is known that this ester does not ionize in alcohol. Trichloroacetic acid, the sodium salt, the barium salt, and the anilinium salt all decompose in water at the same rate and all give beautiful first order constants throughout the whole course of the reaction. It is known that all these salts

¹⁵ Verhoek, *J. Am. Chem. Soc.*, **56**, 571 (1934).

are largely ionized in water. The constancy of the velocity constants and the energy of activation are illustrated in Table III.

TABLE III
DECOMPOSITION RATE OF SODIUM TRICHLOROACETATE IN WATER

Temp.	k (sec ⁻¹)	E (calories)
90°	3.23×10^{-4} 3.18 3.07 <hr/> 3.11	—
80°	7.71×10^{-5} 7.70 7.70 7.42 <hr/> 7.62	$E_{90^\circ-80^\circ}$ 36,180
70°	1.70×10^{-5} 1.72 <hr/> 1.71	$E_{80^\circ-70^\circ}$ 36,200
60°	3.53×10^{-6} 3.48 3.42 <hr/> 3.48	$E_{70^\circ-60^\circ}$ 36,180
50°	6.18×10^{-7} 6.18 <hr/> 6.18	$E_{60^\circ-50^\circ}$ 36,750

At 70° the specific decomposition rates for the barium salt and the anilinium salt are both 1.754×10^{-5} , practically the same as for the sodium salt.

In alcohol, the sodium salt gives a first order constant throughout the whole range, and the results are reproducible as before. The barium salt, however, decomposes more slowly and a first order constant is not obtainable. The anilinium salt dissolved in alcohol, gives an apparent first order constant toward the end of the reaction. An increase in ionic strength through the addition of electrolytes gives an increase in the decomposition rate.

In aniline, the anilinium salt decomposed faster towards the end of the reaction, and here also a concentration effect was noticed, the dilute solution giving a higher specific decomposition rate.

All these apparently discordant facts were neatly explained on the basis that it is the trichloroacetate ion which decomposes in a unimolecular fashion. We have been unable to discover any other hypothesis which accounts for all these different facts. The reaction is

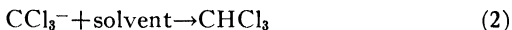
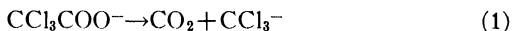

The CCl_3^- ion is the anion of the "acid", chloroform, and since it is an exceedingly weak acid the anion will immediately take a proton from the solvent (water, etc.). Step (2) is very rapid and step (1) is the slow, rate-determining step.

The solvent effect involves the degree of ionization, but it involves also a solvation effect as indicated in Table IV.

TABLE IV
ENERGY OF ACTIVATION IN DIFFERENT SOLVENTS

Solvent	Energy of Activation <i>E</i>
Water	36,050
Alcohol	31,250
Aniline	26,750

It will be noted that the energy of activation is greatest in water, next in alcohol, and least in aniline, and it is probable that water tends to solvate more than alcohol, and alcohol to solvate more than aniline. These actual differences in the energies of activation can be attributed to heats of solvation which must be added to the energy of activation before decomposition can occur. The products chloroform and carbon dioxide are not solvated. It will be remembered that the trichloroacetic acid itself is completely stable, as shown by the failure to decompose in such solvents as carbon tetrachloride and sulphuric acid. This stabilizing of the trichloroacetate ion by the proton may be considered as a special limiting case towards which the stabilization by solvation can approach.

One more line of evidence supports the view that solvation of the ions determines the stability of the intermediate product and thus determines the rate of reaction. When dissolved in alcohol the trichloroacetate decomposes more rapidly than in water, but in ninety-five per cent alcohol the decomposition is greater than in either water or alcohol. Possibly the addition of five per cent

of water increases the degree of ionization without greatly changing the solvating power of the solvent. According to this hypothesis an increase in the number of ions through the addition of water more than offsets the stabilizing effect of the solvation by water.

It is interesting to speculate on mechanisms. If the molecules split at the carbon-carbon bond, energy of activation of at least 70,000 calories would be required if no other disturbing factors occurred. We might expect this to be a minimum value for the energy of activation for the decomposition of trichloroacetic acid. If we remove the proton of the carboxyl group in the acid, thus giving an ion, the forces holding the atoms together are markedly affected, and it is now possible to break the carbon-carbon bond with much less expenditure of activation energy,—only 26,750 in the case with the solvent aniline. However, as solvent molecules become attached to this trichloroacetate ion, energy is evolved which in turn must be added to the energy of activation required for the decomposition of the ion.

IONIC REACTIONS

A thorough discussion of ionic reactions and theories of electrolytes is beyond the scope of these lectures. No discussion of chemical kinetics would be complete, however, without some reference to the success which has followed the application of theories of electrolytes, chiefly in the work of Brönsted and of Bjerrum.

The theory of Brönsted¹⁶ and Bjerrum has been instrumental in correlating many different experimental facts. The formation of a critical "complex," X, is assumed, which on decomposition gives the products according to the reaction

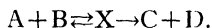

This is a generally accepted idea and recently it has been extended considerably in more accurate calculations of the absolute values of reaction rates. Brönsted and Bjerrum without any attempt to determine absolute values of X were able nevertheless to predict the effect of electrolytes and other factors on the reaction rate.

The equilibrium constant K for this critical complex is written accurately in terms of activities a or in terms of their equivalents, i. e., concentrations c multiplied by activity coefficients f .

¹⁶ Brönsted, *Chem. Rev.*, **5**, 231 (1928); La Mer, **10**, *Chem. Rev.* 179 (1932).

$$K = \frac{a_X}{a_B a_B} = \frac{c_X \cdot f_X}{c_A f_A \cdot c_B f_B} = \frac{c_X}{c_A c_B} \cdot \frac{f_X}{f_A f_B} \quad (12)$$

Then the velocity is given by the expression

$$-\frac{dc_A}{dt} = -\frac{dc_B}{dt} = k' c_X = k' \cdot K c_A c_B \frac{f_A f_B}{f_X} = k'' c_A c_B \frac{f_A f_B}{f_X} \quad (13)$$

where k' and k'' are constants. Also from experimental measurements $-dc_A/dt = k c_A c_B$. Then

$$k c_A c_B = k'' c_A c_B \cdot f_A f_B / f_X \text{ and} \\ k = k'' f_A f_B / f_X.$$

At infinite dilution all the activity coefficients become unity and k'' may be defined as k_∞ . The effect of various electrolytes on the specific rate k can be calculated, and the results are found to check with experimental facts.

According to the interionic attraction theory of Debye and Hückel

$$\ln f = -\alpha Z^2 \sqrt{\mu} \quad (14)$$

where Z is the charge of the ion, μ is the ionic strength and α is a constant which can be calculated from known physical constants such as ionic diameter and dielectric constant. At 25° for water $\alpha/2.303 = 0.505$. The rate of many slow ionic reactions is affected by the addition of electrolytes and when the difference between the logarithm of the rate constant at infinite dilution and at a definite concentration is plotted against the square root of the ionic strength a straight line is produced, according to equation (15).¹⁷

$$\log k - \log k_\infty = \log \frac{f_A f_B}{f_X} = Z_A Z_B \sqrt{\mu}. \quad (15)$$

The specific nature of the ions is immaterial, the only thing which

¹⁷ Equation (15) is derived as follows:

$$k = k_\infty f_A f_B / f_X \\ \log k - \log k_\infty = \log \frac{f_A f_B}{f_X} = \frac{1}{2.303} \ln \frac{f_A f_B}{f_X} = \frac{1}{2.303} [-\alpha Z_A^2 \sqrt{\mu} - \alpha Z_B^2 \sqrt{\mu} + \alpha Z_X^2 \sqrt{\mu}].$$

Since the complex X is composed of A+B

$$Z_X = Z_A + Z_B$$

$$\log \frac{f_A f_B}{f_X} = \frac{\alpha \sqrt{\mu}}{2.303} [-Z_A^2 - Z_B^2 + (Z_A^2 + 2Z_A Z_B + Z_B^2)] = 2 \frac{\alpha}{2.303} Z_A Z_B \sqrt{\mu} \cong Z_A Z_B \sqrt{\mu}$$

counts being the ionic strength of the solution (i.e., the concentration and valency of the ions). This effect is known as the primary salt effect. The addition of electrolytes accelerates reactions between ions of the same charge, but it retards reactions between ions of unlike charge.

The secondary salt effect is due to an entirely different phenomenon. It occurs with weak acids, for example, where the addition of the strongly dissociated salt represses the ionization of the weak acid. It can be much larger in magnitude than the primary salt effect. For example, 0.1 M potassium chloride added to 0.1 M hydrochloric acid produces a primary salt effect and increases the rate of inversion of cane sugar four per cent by changing the ionic strength and the activity coefficient of the critical complex. But 0.1 M potassium acetate added to 0.1 M acetic acid decreases the same reaction by forty per cent. This large secondary salt effect is due to the repression of ionization of the weak acid by the strongly dissociated salt.

In some reactions the number and charge of ions change during the course of a reaction and this changing ionic strength is a complication in understanding the reaction rate. The effect can be minimized by adding a large excess of foreign electrolyte giving such a large ionic strength that changes due to the reaction are comparatively insignificant.

In reactions where there is no change in the number of charges on the ions the ionic strength does not change and the reaction rates are somewhat simpler. A reaction of interest in this connection is the oxidation of the arsenite ion by the tellurate ion.¹⁸ The reaction was chosen because it goes with conveniently measurable velocity at the temperature of boiling water and the reaction can be followed easily by direct titration with iodine. More reactions of this type would undoubtedly be available for study at the higher temperatures if suitable analytical methods could be found. The reaction is

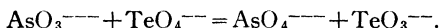

Typical experimental data are given in Table V where the last column gives an idea of the constancy of the second order constant which is obtained.

The energy of activation as determined from rate constants at several temperatures is 14,380 calories per mole.

¹⁸ Stroup and Meloche, *J. Am. Chem. Soc.*, **53**, 3331 (1926).

At higher temperatures the reverse reaction, the oxidation of tellurite ion by arsenate ion, becomes important. The reaction is one of the few where it has been possible by direct experiment to check the relation that $K = k_1/k_2$. In this case at 89.6° $k_1 = 9 \times 10^{-7}$ and $k_2 = 4 \times 10^{-10}$. Then $k_1/k_2 = 2 \times 10^3$. By equilibrium measurements, quite independent of the rate measurements, the equilibrium constant K was found to be 2.4×10^3 .

TABLE V
THE RATE OF OXIDATION OF ARSENITE BY TELLURATE ION AT 89.6°

Seconds	AsO ₃ ⁻⁻⁻ per cent transformed	TeO ₄ ⁻⁻ moles/liter	AsO ₃ ⁻⁻⁻ moles/liter	Moles trans- formed	k moles sec ⁻¹ liters ⁻¹ × 10 ⁶
7,920	60.0	0.05	0.0458	0.0275	1.0
14,400	71.5	.05	.0470	.0336	0.90
21,600	81.3	.05	.0458	.0402	0.87
43,200	91.2	.05	.0458	.0417	0.98
90,000	96.1	.05	.0458	.0440	0.82
129,500	98.3	.05	.0458	.0450	0.89

It will be observed that this reaction does not involve the transfer of electrons. Reactions in which the only change is the transfer of electrons are usually very rapid, except when triple collisions are required. The oxidation of the arsenite ion involves only the transfer of an oxygen atom from one ion to the other, both ions having the same charge. It is an example of the breaking of a coordinate covalent band, a process which, as Moelwyn-Hughes points out, usually leads to a "normal" reaction rate. The repulsion of the ions of like charge may be responsible also for giving a slower reaction.

An interesting relation has been pointed out by Shaffer.¹⁹ Among the reactions in which the only change is the transfer of electrons from one ion to another the bimolecular reactions are immeasurably fast, but the reactions which require triple or quadruple collisions for the stoichiometrical reaction are usually slow. For example the reaction

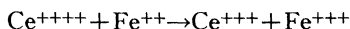

is too fast to measure, but the reaction

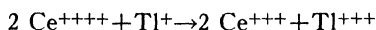

requires a triple collision for the transfer of the two electrons from

¹⁹ Shaffer, *J. Am. Chem. Soc.*, **55**, 2169 (1933).

a thalious ion to two ceric ions. The reaction is very slow, as are others of this general type. The case for the slow oxidation of thalious ion is further strengthened by the fact that manganese ions are excellent catalysts. Manganese ions can exist as Mn^{++} , Mn^{+++} and Mn^{++++} and transfer of the two electrons can be accomplished by a series of bimolecular collisions which occur much more frequently. In these investigations it is necessary to take special precautions for a high degree of purity and to take fully into account the influence of the ionic strength and acidity of the solutions. Further investigation seems to be important.

DECOMPOSITION OF AMMONIUM AMALGAM

In extending our study of chemical kinetics, we sought systems as far removed as possible from ordinary aqueous and organic solutions. The decomposition of ammonium amalgam

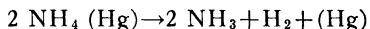

looked interesting because the solvent in this case is a metal, and although the reaction was recorded in the literature as a measurably slow reaction, no quantitative investigation had been made. The research was undertaken by Dr. Alden J. Deyrup.²⁰

Ammonium amalgam was prepared by electrolyzing a solution of ammonium hydroxide and ammonium acetate at a low temperature, -30° with a mercury cathode. The resulting solution of ammonium in mercury then decomposes when allowed to come to room temperature, and hydrogen and ammonia gas are slowly evolved, leaving eventually the pure mercury. The partially decomposed amalgam is larger in volume than the original mercury, and has a stiff consistency, something like that of butter. This stiffness is due to an emulsion of liquid ammonia and some gas bubbles dispersed through the mercury.

It was found impossible to measure the rate of decomposition by the evolution of gases because the release of these gas bubbles is very slow and erratic. The course of the reaction was followed by analyzing samples for the ammonium ion. Small amounts of the decomposing amalgam were forced through a capillary tube into a chilled solution of an iodate. The ammonium reacted with iodate ion to give iodide ion. The solution was then acidified with acetic acid and the iodine distilled out, collected and titrated with sodium thiosulfate. The method was checked with samples

²⁰ Deyrup, *J. Am. Chem. Soc.*, **56**, 2594 (1934).

of known ammonium content and found to be accurate. The course of the decomposition is shown in Fig. 22 where the concentration of ammonium amalgam is plotted against time at -20° . By drawing tangents to these several curves it was found that the data are all fitted by the equation

$$\frac{dx}{dt} = kx(a-x) \quad (16)$$

where x is the amount of ammonium amalgam decomposed or the amount of ammonia and hydrogen produced and $a-x$ is the

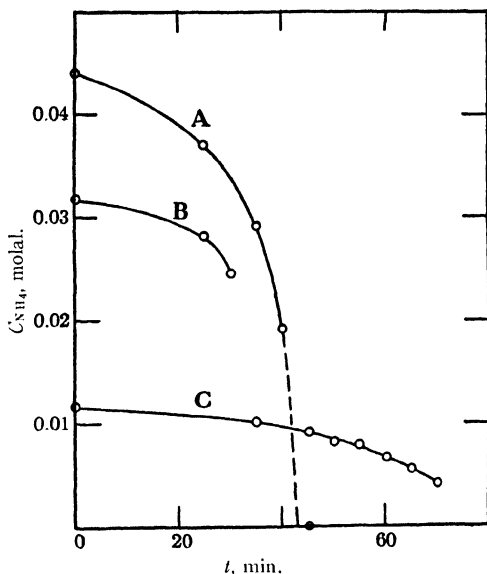

FIG. 22.—Decomposition of pure ammonium amalgams at -20° .

amount of ammonium remaining. Starting with initial concentrations a of 0.0438, 0.0316 and 0.0115 moles per 100 grams of mercury the values of k calculated by equation (16) were respectively 0.0095, 0.0105 and 0.0093. The success of this formula shows that the reaction is autocatalytic in nature and this conclusion was confirmed by an experiment in which the decomposed solution was added to undecomposed material thereby increasing the initial rate of decomposition.

The facts are readily explained on the theory that decomposition of the ammonium amalgam occurs very slowly as an homogeneous reaction at temperatures below zero and that a rapid, heterogeneous reaction takes place at the surface of little droplets of liquid ammonia which are dispersed throughout the mercury. The surface tension of the mercury is sufficient to cause liquefaction of the first ammonia which is liberated. The autocatalytic effect occurs when the reaction has had time to build up these droplets of liquid ammonia.

It was found that this heterogeneous reaction can be stopped by the addition of small amounts of lithium. It is likely that lithium with its higher electrode potential is able to prevent the self-ionization of liquid ammonia, and the heterogeneous reaction between ammonium in solution and liquid ammonia is inhibited. When this heterogeneous reaction is prevented, the decomposition follows a perfectly satisfactory second-order reaction, and the temperature must be raised up to the range from zero to 20° in order to obtain a measurable reaction rate. The reaction is satisfactorily explained on the assumption that ammonium dissociates in mercury giving ammonium ions and free electrons $\text{NH}_4 \rightarrow \text{NH}_4^+ + e^-$. The older view that the ammonium exists as a free radical, NH_4 , seems less likely. Such a radical would be unstable and it would not be expected to have such a long life. Ammonium ions, however, are more stable.

All the observed facts in this reaction can be explained on the assumption of ammonium ions and free electrons in the mercury solution. In a metal such as mercury there is probably a large number of free electrons, but the fact that the reaction is second order is thought to show that the reaction is



The requirement for two additional electrons does not change the order of reaction from a second order equation, and a quadruple collision is a common occurrence on account of the large excess of electrons. Although ammonium ions would tend to repel each other, the electrical atmosphere is changed by the large number of negative electrons. Good second order constants were obtained. By plotting the logarithms of the velocity constants against the reciprocal of the absolute temperature the energy of activation was found to be 22,400 calories.

CHAPTER VI

PHOTOCHEMISTRY

PHOTOCHEMISTRY is concerned with chemical reactions which are produced directly or indirectly by radiation. It is an interesting and rapidly developing field which contributes much to the theory of chemical kinetics. On the other hand, progress in photochemistry depends largely on advances in chemical kinetics. Photochemistry has been studied in a qualitative way for centuries but only within the past decade or so have the investigations been put on a strictly quantitative basis. Improvements in experimental technique, advances in our interpretation of spectra and the widespread application of the quantum theory have all contributed to the rapid development of this branch of science. We are concerned here with that part of photochemistry which aids in our understanding of chemical kinetics and again I shall limit the illustrations largely to researches from our own laboratory.

According to the quantum theory, radiation is emitted in bundles of energy, and according to the wave theory it is emitted in the form of electrodynamic waves in a hypothetical ether. The first theory is very satisfactory in photochemistry, atomic physics and spectroscopy, whereas the second theory is more useful in optics and phenomena involving refraction and interference. Obviously each picture is incomplete and both are concerned with one and the same thing. The apparent difference in viewpoint is gradually diminishing. Apparently the quantum theory expresses best the behavior of individual units or photons, but the statistical behavior of a large number of photons is readily described on the basis of the wave theory.

The quantum theory was originally proposed by Planck in 1900 to explain the emission spectrum of a heated enclosure or "black body." On the assumption that radiation was emitted discontinuously he was able to develop a semi-theoretical formula

which gave with remarkable exactness the relative intensity of emission at all the different wave lengths. Previously it had been impossible to use the same formula for the short waves and the long waves. It met with immediate success in related fields, in photo-electricity, specific heats of solids, and spectroscopy. A large number of empirical data had been accumulated in spectroscopy and the quantum theory rapidly brought them together and explained the isolated facts. It is doubtful that the quantum theory would have been accepted in photochemistry except for the prestige it had gained in these other fields, but now nearly all photochemists believe that it applies to the primary photochemical processes and that apparent discrepancies can be explained on the basis of secondary reactions and complications which follow the primary process.

PHOTOCHEMICAL PRINCIPLES

The most important and most obvious rule of photochemistry is that of von Grotthus according to which radiation must be absorbed in order to produce any chemical reaction. It is clear that if a photon passes unaffected through a mass of molecules no chemical action can be initiated. Energy must be introduced in some manner.

It was shown in Fig. 7 that in ordinary chemical reactions the required energy of activation comes from a few violent collisions between very rapidly moving molecules. The reactions are slow at low temperatures because there are only a few of these violent collisions. In photochemical reactions, however, the activation comes from an outside source and the number of collisions with these energy-rich photons is determined chiefly by the concentration of photons, i.e., by the intensity of the beam of light. The situation is shown in Fig. 23 where the sharp hump at the right of the Maxwell-Boltzman distribution curve represents the large amount of high-intensity energy which is brought into the reacting system by the light. The number of effective energy units is much greater than the number of molecules activated to this extent by molecular collision.

The second important generalization in photochemistry is the Einstein rule that one molecule and only one becomes excited for each quantum absorbed. It is a direct deduction from the quantum theory, but it must be admitted that there are few laws in science

which have been accepted so unreservedly on such flimsy experimental evidence. As more exact experimental measurements become available it is increasingly certain that a "one to one" relationship for chemical reaction is comparatively rare. But the law is not intended to apply to the over-all reaction—only to the primary photo-process. A molecule becomes excited by the absorption of one quantum of radiation and what happens to it afterward is a matter of the specific nature of the reaction and the environment.

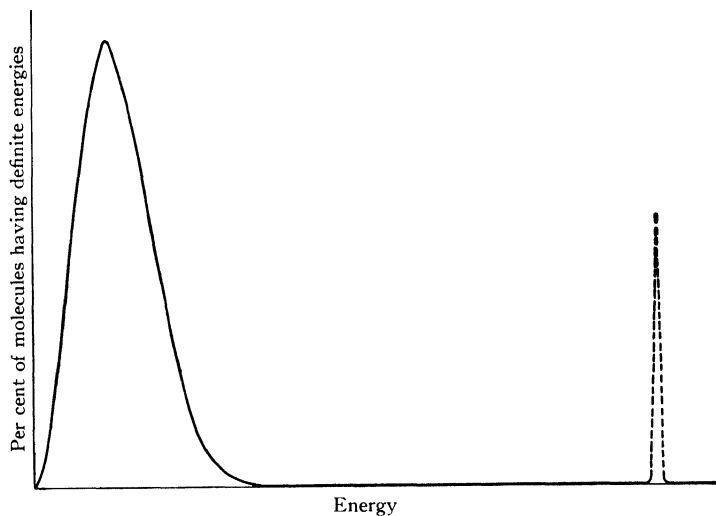

FIG. 23.—Illustration of the energy supplied from an outside source in photochemical reactions. The normal thermal energy supplied from collisions by the Maxwell-Boltzmann distribution is insufficient to produce the chemical reaction.

It does not follow at all that there must be chemical reaction—more often the energy is degraded as heat. Many things may happen when a molecule becomes excited by radiation. It may emit radiation of the same or different wave length, giving the phenomenon of fluorescence. It may have its kinetic or rotational or vibrational or electronic energy increased, or it may collide with other molecules and give to them increased kinetic or internal energy. It may dissociate into fragments or it may combine with other molecules giving new chemical products.

ABSORPTION OF RADIATION

When light of various wave lengths, i.e., photons of various energies, is passed into a group of molecules, some of the photons are absorbed and others pass through. Only in case the parts of the molecule can be rearranged in such a way as to take up the particular energy of the photon will the photon have a chance of being stopped. Even if the conditions are right there is still only a definite probability of absorption and the greater the number of molecules the greater is the chance of absorption. Electrons may be driven to higher energy levels or atoms may be displaced from their normal positions in the molecules, or the energy of rotation of the whole molecule may be increased. These various changes require different amounts of energy and they are subject to re-

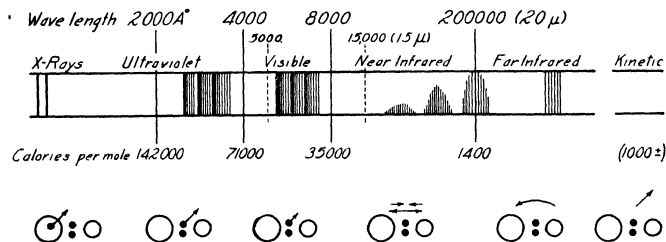

FIG. 24.—Energy and mechanism of different types of absorption throughout the spectrum.

strictions which are governed by the quantum theory. A mechanical picture of these operations is given in Fig. 24, where the large and small circles represent atoms held together by a pair of valence electrons designated by black dots. This may be taken as a diagrammatic representation of any simple molecule, such as HCl, or it may be regarded as a *part* of a molecule of greater complexity in which only one pair of atoms (one valence bond) in the molecule is concerned.

The visible spectrum extends approximately from 4,000 to 8,000 Å. The human eye is not sensitive to light of wave lengths much shorter or longer than these. The near infrared region extends from 8,000 up to perhaps 200,000 Å, and the far infrared region extends still further toward the long waves from meters to thousands of meters, which are familiar to anyone who turns a radio dial. On the shorter side of the visible spectrum, we have ultraviolet light

extending to 2,000 Å and below. Beyond that, at much shorter wave lengths around 1 Å and less, we have the X-rays.

In the far infrared, the absorption of radiation causes the molecules to rotate as indicated diagrammatically with a curved arrow in the lower part of Fig. 24. In the near infrared it causes the atoms within the molecules to oscillate as represented by the double arrow, or to bend. Photons of visible radiation are able to do a more drastic thing. They can reach in and displace a valence electron which is holding the atoms together as shown by the short arrow. The mechanism of absorption in the ultraviolet is quite similar, except that these valence electrons are displaced to positions of greater energy as indicated with the longer arrow. X-rays have sufficient energy to penetrate into the atom beyond the valence electrons and displace electrons within the atom near the nucleus as indicated by the arrow.

As seen from the diagram it takes less than about 1,400 calories per mole to increase the rotational energy of the molecule. It takes between 1,400 and 35,000 calories to increase the vibrational energies of the atoms within the molecules. Displacement of electrons such as is obtained in the visible region of the spectrum requires between 35,000 and 71,000 calories per mole, while displacement corresponding to the ultraviolet region requires still greater energies—up to 142,000 calories per mole at 2,000 Å. This wave length is in the region where quartz and water begin to become opaque and special apparatus is required for still shorter wave lengths.

It will be remembered that most chemical reactions which proceed with measurable velocities require from approximately 20,000 to 60,000 calories of energy. It is clear that visible radiation can supply this energy and that ultraviolet light has sufficient energy to produce almost any chemical reaction.

It is interesting to compare radiation energy with the kinetic energy of the moving molecules. The latter amounts to $3/2 RT$ or 900 calories per mole in the neighborhood of room temperature. At 200° the average kinetic energy is about 1,500 calories per mole. This is considerably less than the energy of oscillating atoms, but it is of the same order of magnitude as the energy of rotation of molecules.

The different types of absorption spectra can be combined together as is illustrated in Fig. 24, for the different kinds of absorption can operate simultaneously. There are only single lines

in the far infrared absorption spectrum because the energy there is sufficient to produce only molecular rotation. In the near infrared the energies are sufficient for both molecular rotation and atomic oscillation, consequently the oscillation lines have a series of rotational lines differing by only small amounts—1, 2, 3, etc. times the energy of rotation. This fact gives rise to bands, whose fine structure is revealed only with instruments of high dispersion. In the visible and ultraviolet spectra where greater energy is available we have all three absorptions superimposed—electron displacement, atomic displacement and molecular rotation. The result is a series of absorption bands and the expert spectroscopist is able to unravel the various systems and assign quantum numbers to each of the three modes of absorption.

A more complete tabulation of the wave lengths and energies in different parts of the spectrum is given in Table I.

TABLE I
ENERGY IN VARIOUS TYPES OF RADIATION

Description	Wave length Å	Wave number cm ⁻¹	Fre- quency sec ⁻¹	Ergs per quantum	Cals. per einstein	Elec- tron volts
Far Infrared	1,000,000	100	3×10^{12}	1.96×10^{-14}	284	0.01
Infrared	100,000	1,000	3×10^{13}	1.96×10^{-13}	2,845	0.12
Near Infrared	10,000	10,000	3×10^{14}	1.96×10^{-12}	28,450	1.23
Visible (red)	8,000	12,500	3.7×10^{14}	2.42×10^{-12}	35,500	1.54
Visible (red)	7,000	14,286	4.3×10^{14}	2.81×10^{-12}	40,600	1.76
Visible (orange)	6,000	16,667	5×10^{14}	3.27×10^{-12}	47,400	2.06
Visible (blue-green)	5,000	20,000	6×10^{14}	3.93×10^{-12}	57,000	2.47
Visible (violet)	4,000	25,000	7.5×10^{14}	4.91×10^{-12}	71,120	3.09
Ultraviolet	3,000	33,333	1×10^{15}	6.55×10^{-12}	94,840	4.11
Ultraviolet	2,000	50,000	1.5×10^{15}	9.82×10^{-12}	142,300	6.17
Ultraviolet	1,000	100,000	3×10^{15}	1.96×10^{-11}	284,500	12.3
X-rays	1	1×10^8	3×10^{18}	1.96×10^{-8}	2.84×10^8	12,340

The wave lengths of the different parts of the spectrum are expressed in Ångstroms (Å), one unit of which is equal to 10^{-8} cm. The wave number is widely used in spectroscopy because the calculations are simplified. It is defined as the reciprocal of the wave length, expressed in cms. The frequency of the radiation is required for any calculation of energies. It is obtained simply by dividing the wave length of light, expressed in cm, into the velocity of light, 3×10^{10} cm. sec.⁻¹. It is clear that the frequency of radiation is equal to the wave number multiplied by the velocity of

light. In the next two columns the energies are given in ergs per quantum and in calories per Einstein. In the last column these quantities are converted into electron volts as described in the next chapter.

The energies are calculated from the frequency by the fundamental relation of the quantum theory

$$\epsilon = h\nu$$

in which ϵ is the energy per photon in ergs, h is Planck's universal constant, 6.55×10^{-27} erg-seconds, and ν is the frequency of the radiation in vibrations per second. According to Einstein's relation in photochemistry one molecule is activated by the absorption of one photon of radiation. Multiplying the energy of one photon (the quantum) by the number of molecules in a gram molecule (6.06×10^{23}) gives the energy required to activate one mole. It is usually expressed in calories, according to the equation

$$E = N h \nu = 6.06 \times 10^{23} \times 6.55 \times 10^{-27} \times \nu / 4.185 \times 10^7.$$

The name einstein and symbol E are given to the number of photons corresponding to a mole just as the name faraday is given to the quantity of electrons corresponding to a gram equivalent (96,540 coulombs).

Energy relations may be calculated also from the nature of the absorption spectrum. For example if the spectrum contains fine lines which come closer and closer together and finally merge into a continuous spectrum one can calculate the energy of the dissociation from the wave length corresponding to this limiting wave length. Displacement of electrons or atoms within the molecule and rotations of the molecule are subject to definite restrictions according to the quantum theory and only certain units of energy can be absorbed. However, when a molecule is broken up into fragments, the translatory kinetic energy of these particles is not quantized and any amounts of energy can be absorbed, corresponding to any and all wave lengths between the definite lines of the absorption spectrum. Accordingly all photons in this region can be absorbed and the spectrum appears to be continuous. The shortest wave length in the discontinuous spectrum gives the energy of dissociation. Energies any greater than this give dissociation and additional kinetic energy. Energies of dissociation calculated in this way are sometimes greater than those determined directly in a calorimeter because in the photo-dissociation

the fragments themselves may contain some additional energy of excitation—due for example to displaced electrons or atoms. Usually the amount of this excitation energy of the fragments can be calculated from theoretical considerations and subtracted from the calculated energy of dissociation.

Again the energy of dissociation may sometimes be calculated from the wave length at which the sharp spectral lines become blurred, a phenomenon known as predissociation.

PHOTOCHEMICAL KINETICS

The secondary chemical reactions which follow the primary photo-process are highly specific and just as complicated as pure thermal reactions. It is the task of the kineticist to discover and record quantitatively and mathematically the various steps which follow the primary process to give the over-all, observed reaction rate. The most important aid in this work is the experimental determination of the quantum yield, i.e., the total number of molecules reacting for each photon absorbed or the number of moles per einstein. It is frequently designated by the symbol Φ .

If the quantum yield is practically unity the over-all reaction is equivalent to the primary one in which, by the Einstein relation, one molecule is activated for each photon absorbed. In such cases it may be safely assumed that secondary reactions are negligible. If the quantum yield is very large, then many molecules react for each photon absorbed and a chain reaction is involved. The magnitude of Φ gives an idea of the length of the chain. In some reactions the chains are very long—running up to a hundred thousand molecules reacting for each photon absorbed in the photocombination of hydrogen and chlorine. On the other hand if the quantum yield is less than unity some of the energy of excitation may be lost as heat or fluorescence, or the products may be recombining, or the efficiency of the reaction is being reduced in some other way.

Frequently the quantum yield changes with temperature, concentration, wave length of light and other factors in such a way that the investigator can draw conclusions regarding the mechanism of the reaction.

The primary photo process is not affected by the temperature of the reacting system. It is clear from Fig. 23 that the energy producing the chemical reaction comes from an outside source and depends to a negligible extent on the temperature of the reacting

system. The temperature of the radiating body rather than the reacting system is important for on it may depend the intensity of radiation. However, when secondary thermal reactions follow the primary photo activation, as is usually the case, the over-all reaction may be affected by a change in temperature.

As a matter of fact a large variety of temperature coefficients have been found among photochemical reactions. Many have large temperature effects, the rate doubling or trebling for a ten degree rise as in the case of most thermal reactions. In such reactions secondary thermal reactions must play an important part. In a few cases temperature has no effect on the quantum yield, showing that secondary thermal reactions are absent. In these cases Φ is usually close to unity. In the majority of cases the photochemical reaction increases ten or twenty per cent with a ten degree rise in temperature, showing some thermal complications.

Most chemical compounds absorb ultraviolet light (the simpler molecules sometimes requiring ultraviolet light of shorter wave length), and whenever light is absorbed, chemical reaction is likely to follow. Accordingly there are many examples of photochemical reaction, both in the gas phase and in solution. A comparison of the two is much simpler than in the case of the thermal reactions. It will be remembered that for thermal reactions direct comparison is difficult because reactions which occur with easily measurable rates at temperatures below the boiling point of the solvents rarely occur also in the gas phase. These restrictions do not apply to photochemical reactions, because ample energy for reactions can be introduced from an outside source into a solution at a low temperature.

Concentration effects are important in some photochemical reactions as they are in ordinary thermal reactions, but in other photochemical reactions they are unimportant. In reactions involving only the primary photo-process concentration should have no effect, provided that the concentration is sufficiently great so that all the light that enters the reaction chamber is absorbed. Each photon absorbed produces one activated molecule and the speed of this process depends not on the concentration of molecules but only on the concentration of photons, i.e., on the intensity of the beam of light. Such a reaction, whose rate is independent of concentration, is known as a zero order reaction. This type is fairly common among photochemical reactions. We have seen that in

the idéal case, where there are no secondary reactions following the primary photochemical step, the reaction is unaffected by concentration and temperature, and the quantum yield is unity.

If the primary process is followed by another reaction or if collisions with other molecules are necessary for the reaction, then the reaction rate will depend on concentration. If it depends only on the concentration of the absorbing material the reaction is of the first order, and if it depends on the square of the concentration it is of the second order. Examples of both are known but in photochemical reactions as in thermal reactions the over-all observed reactions frequently appear to follow neither the first nor the second order, usually on account of the existence of two or more reaction steps. Sometimes a second reaction is slow in getting started because time is necessary to accumulate some of the product of the first reaction. This situation leads to a time-lag or induction period. Again the second reaction may continue after the primary photo-reaction has stopped, giving rise to after-effects.

Changing the intensity of light sometimes yields information on the nature of the reaction. In a simple, primary reaction the quantum yield is the same irrespective of the intensity of light and the amount of reaction is directly proportional to the amount of light absorbed. Deviations from this proportionality often give clues as to the mechanism of the reaction. For example, if the molecules of absorbing material are broken up into two atoms and each one can act in a chemical reaction to give a new product, the square of the rate of the reaction is proportional to the light intensity. In other words if the reaction rate varies as the square root of the light intensity one can expect dissociation into two smaller reacting units, such as the breakdown of chlorine molecules into chlorine atoms.

Thermodynamical calculations are helpful in deciding between various secondary mechanisms taking place in photochemical reactions. A given intermediate product can exist in equilibrium with the reactants only if there is a decrease in free energy, but even then the rate of formation of the intermediate compound may be too slow to be an appreciable factor. Another basis for reaching a decision as to intermediate steps and the mechanism of the reaction rests on the quantum calculations of reaction rate. It will be shown in Chapter IX that many reactions which appear possible on paper may be definitely excluded on the basis of these theoretical calculations.

EXPERIMENTAL TECHNIQUE

Two important principles apply to careful experimental investigations in photochemistry—the radiation must be quantitatively measured and it must be essentially monochromatic. The first requirement makes possible a comparison of reaction rates and efficiencies, the second is more likely to insure that a single reaction is taking place. Both are necessary for calculating quantum yields. Unfortunately all the methods which are designed to produce monochromatic light automatically decrease the intensity of the available light. The feeble light which results is difficult to measure, but the greatest obstacle lies in measuring the small amount of chemical change produced by the light. This limitation has led to development along two lines: the development of microtechniques for measuring small chemical changes, and the development of more intense sources of radiation.

Light Sources. Among the different sources of light one distinguishes between those which give a continuous spectrum and those which give a discontinuous spectrum. Sunlight is continuous, giving all the different wave lengths of the spectrum in the range of the visible spectrum. It is used extensively for qualitative experiments but for quantitative measurements it is too uncertain and too variable in intensity. Tungsten filaments are often satisfactory unless a high intensity is desired in the blue end of the spectrum. Lamps with concentrated filaments such as are used for automobile head lights are particularly useful. They are operated on storage batteries when absolute constancy is required. In order to obtain intense radiation a lamp may be operated at a voltage considerably beyond its rated capacity. The lamp, of course, will be short lived but replacements are comparatively inexpensive. Carbon arcs and iron arcs are richer in ultra-violet and violet and are more intense, but they are difficult to control so as to give a constant intensity.

Light sources which give discontinuous spectra are suitable for exact photochemical investigations because it is easier to separate the different wave lengths into regions of monochromatic light. The mercury arc is the commonest source of radiation in photochemistry. It is obvious that a lamp which gives a few lines, as does the mercury arc, will provide a relatively high intensity at each of these wave lengths whereas an arc with many lines, such as the iron arc, will have its energy so widely distributed that any

one line will have but a comparatively low intensity. On the other hand the mercury lamp is not universally adaptable because it is often desirable to use monochromatic light at wave lengths which are not included in the mercury spectrum. The commercial mercury vapor lamp is not well suited for use with a spectrometer slit or small reaction cell when great intensity is needed, because the radiation is emitted over a large surface of the lamp. Capillary arcs give much more intense radiation for photochemical purposes because the energy is concentrated into a small space and because the lamps may be made so cheaply that that one can afford to run them at a tremendous overload, even if the life is short.

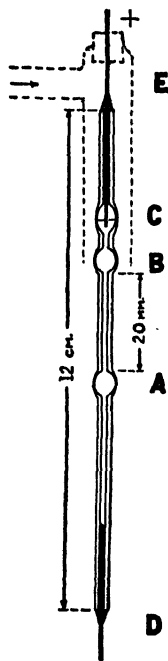

FIG. 25.—Capillary mercury-vapor lamp of quartz.

In Fig. 25 is shown the quartz-capillary, mercury-vapor lamp¹ which has been used in the photochemical investigations described here. Three bulbs are blown in a twelve centimeter length of quartz capillary tubing that has an inside diameter of one or two millimeters and a medium thick wall. The two lower bulbs, separated by about twenty millimeters serve to keep the arc between them and prevent its moving to the electrodes. Electrodes of ordinary iron wire or tungsten wire are mounted in the capillary lamp with deKhotinsky cement. In filling the lamp the lower electrode is cemented in at D and the quartz tube is then inverted and dipped into mercury at the bottom of a test tube. The tube is then evacuated with a water aspirator or oil pump and when it is disconnected the inrush of air forces the mercury up into the capillary. The lamp is removed, inverted and shaken

until the mercury extends just into the bulb C. The upper electrode is then inserted until it touches the mercury and it is then sealed in with deKhotinsky cement. The uppermost bulb, containing air, acts as an expansion bulb for the mercury which is driven out from the capillary between A and B when the arc strikes. Lead wires are clamped to the electrodes and the bare joints are covered over with deKhotinsky cement or sealing wax.

¹ Daniels and Heidt, *J. Am. Chem. Soc.*, **54**, 2381 (1932).

The lamp is mounted securely at its ends and connected to a source of direct current preferably 220 volts or 500 volts through suitable resistances and a switch. The switch is closed and a small Bunsen flame is played on the capillary between A and B. The mercury vaporizes and the arc strikes and is localized between the two bulbs. As soon as the lamp starts, water is turned on so that it flows down around the lamp in a large stream. The cold water keeps the cement intact and preserves the lamp. The energy is so intense that without water-cooling the quartz would be melted immediately. Hard water may be used provided that it passes over the lamp so rapidly that there is not time to heat up the water and deposit lime. The mounting of the lamp may be varied for different purposes. The lamp may be placed in front of a quartz window in a copper tank which is partially drained until the lamp is started. After starting, the tank is allowed to fill to an outlet near the top thus covering the lamp.

Ordinarily these lamps have a life of about ten or twenty hours when operating with a consumption of about a kilowatt of electrical energy but their expense is not great. They can be stopped and started many times. Tests show that this lamp is perhaps a hundred times more effective than a large commercial mercury vapor lamp for photochemical reactions involving the use of a small reaction cell or the illumination of a monochromator slit. Uranyl oxalate in solution contained in a circular cell surrounding the capillary lamp was decomposed at the rate of one-third of a mole per hour. The heat in the capillary is so intense and the temperature gradient so large that the inside quartz becomes white, due to a multitude of minor cracks. Eventually the cracks become large enough to break the lamp.

Lamps of this type are not entirely reliable and one can not be sure that every one will have the suitable characteristics. Small expansion volumes give high-pressure, high-resistance lamps. Practice is necessary in getting the bulbs of the correct size. A current of three amperes with a potential drop across the lamp of about 300 or 400 volts gives very good results. The time between the closing of the switch and the starting of the arc with the Bunsen flame is so short that high current-carrying resistances are not necessary. The deKhotinsky cement must be of just the right consistency and soft enough so that it does not crack away from the quartz surface when the cold water runs over it. Various forms of self-starters have been found satisfactory but unless the lamp

housing interferes, the use of a Bunsen flame is quite satisfactory for striking the arc.

A similar lamp was developed for solid elements in order to give intense light at wave lengths not included in the mercury spectrum. The situation is more difficult because the lamp cracks when the metal freezes. It is necessary then to use a new lamp for every experiment, but they are not expensive and they can be made to run for several hours. The most serious difficulty lies in the fact that these more basic metals attack the quartz at the very high temperatures forming a silicate coating which may be opaque to the ultraviolet light. The chemical combination of the metal with the silica is sufficient in a few hours to cause a considerable increase in the internal diameter.

Capillary lamps of this type have been successfully operated with lead, thallium, bismuth, cadmium, and zinc² and the intensity and distribution of light are comparable with those of the mercury lamp. Cadmium and zinc are particularly useful because they give narrow red lines which are not found in the mercury lamp. All the lamps have important lines in the ultraviolet. The lamps are similar to the one shown in Fig. 25 except that the bulb for expansion is not necessary. The upper part of the lamp is filled by sucking in the molten metal and allowing it to cool. The lower electrode is inserted afterward by turning down a small piece of the metal or casting a small rod which fits snugly into the capillary. Heavy copper wires are melted into the two electrodes and connected to the wire leads. The ends are cemented tightly to the capillary with deKhotinsky cement. The vapor pressure of these metals is so low that it is not convenient to start them with a Bunsen flame as in the case of the mercury lamps. They may be started with an intense spark from a high voltage transformer and condenser across a short gap between the two electrodes. In order to prevent damage to the direct current line by this high-voltage, high-frequency current superimposed on the lamp a system of large inductances is inserted in the power line, and to prevent short circuiting of the lamp through the starting circuit a second spark gap is included in this circuit. The lamps may be started also with a thin metal fuse.

The lamps are less stable than the mercury lamps and it was difficult at first to keep them from consuming too much power and

² Hoffman and Daniels, *J. Am. Chem. Soc.*, **54**, 4226 (1932).

burning out. When the external resistance is exactly equal to the internal resistance the lamp operates at maximum stability. This fact can be shown mathematically as well as experimentally. It is not always convenient to have the lamps operating under such a condition and a combination shunt and series resistance was developed. As soon as the arc strikes the voltage drops and the current through the lamp is read. A simple calculation then shows what the total current through the whole circuit should be in order to give maximum stability. The shunt and series resistance are immediately changed to give this calculated total current but they are adjusted simultaneously in such a way as not to change the voltage drop across the lamp nor the current which passes through it. It is not possible to operate these lamps on alternating current and the solid-element lamps require 140 volts D.C. or more. The

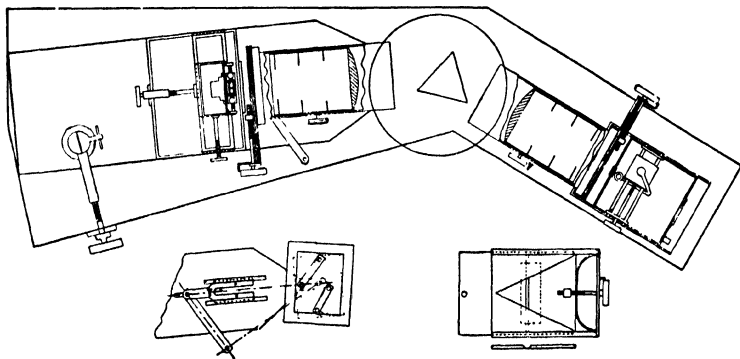

FIG. 26.—Large monochromator.

mercury lamps will operate on 110 volts D.C. but higher voltages are better for both lamps.

Monochromators. Light of a narrow range of frequencies can often be obtained with suitable filters.³ Monochromators however offer the best means for obtaining light of high purity. They are similar to spectrometers with large apertures and short-focus lenses. The large quartz monochromator shown in Fig. 26 has been used for most of the photochemical work reported here. It has a quartz prism fourteen centimeters high and quartz lenses fifteen centimeters in diameter. The table is so arranged that when

³ Daniels, Mathews and Williams, *Experimental Physical Chemistry*, McGraw-Hill Book Co., New York (1934), p. 432.

it is turned to bring in different wave lengths, the proper focus of the lenses is automatically maintained. No reflecting mirror is used. The light is rendered parallel by a convex lens at the exit slit and an intense beam of nearly parallel, nearly monochromatic light is passed through a reaction chamber in the thermostat and onto the thermopile. With this monochromator and the capillary quartz lamps it is possible to obtain 100,000 ergs of radiation per second at 3,130 Å with a purity of over ninety-eight per cent.

A much simpler monochromator for visible light can be constructed at low cost, using large glass lenses and a large, hollow glass prism fifteen centimeters high filled with ethyl cinnamate. A Wadsworth mounting with a mirror in line with the back of the prism, reflects the light in such a manner that it is in focus on the exit slit for all wave lengths. With this monochromator and the capillary mercury vapor lamp it is possible to obtain about 25,000 ergs per second at 4,360 Å and the separation of the 4,360 and 4,050 Å lines at the slit is about five millimeters. A slight movement of the spectrometer table to adjacent wave lengths reduces the intensity to less than one per cent of its value.⁴

Thermopiles. The intensity of radiation is best measured with a thermopile, which absorbs all radiations equally and transfers the energy into electrical energy which is measured easily and quantitatively with a galvanometer. In our investigations it has been found best to use a thermopile of large area, placed directly behind the reaction chamber so that all radiation passing through hits the thermopile and is measured. Narrow thermopiles, one or two millimeters in width, are more common but when used in photochemical investigations they must be moved into many different positions to obtain an average reading. A large-surface thermopile does its own integrating. A thermopile suitable for photochemical investigations is made from a single receiver of thin silver foil ten millimeters wide and fifty millimeters high with perhaps twenty-five copper-constantan thermocouples insulated with glyptal lacquer and stuck to the back with deKhotinsky cement.⁵ It is not necessary to have a galvanometer of extraordinary sensitivity because the sensitivity of the chemical test is usually considerably less than the sensitivity of the radiation test.

The calibration of the thermopile in absolute units is a very

⁴ Bauer, *Ph.D. Thesis*, University of Wisconsin (1934).

⁵ Daniels, Mathews and Williams, *Experimental Physical Chemistry*, McGraw-Hill Book Co. New York, (1934) p. 436.

simple matter, thanks to the carbon-filament standard lamps which may be obtained from the U. S. Bureau of Standards. Quartz windows are necessary for the thermopile calibration since glass absorbs a considerable proportion of the infrared radiation emitted by the lamp. They are necessary, too, for any work with ultra-violet light. The ratio of the galvanometer deflection in the photochemical experiment to the deflection with the standard radiation lamp gives the factor by which the readings in the photochemical experiment may be converted directly into ergs per second. Further details are given elsewhere.⁶

In certain determinations an actinometer may be substituted for the thermopile as a means of measuring the quantity of radiation. A solution of 0.05 M oxalic acid and 0.01 M uranyl sulfate is convenient, for it may be determined directly by titration with potassium permanganate. Each photon of light, absorbed between 2,500 and 4,500 Å, decomposes 0.6 molecule of oxalic acid in this solution. Maximum variations at different wave lengths amount to about 0.1. More complete details and exact data on this reaction are given by Leighton and Forbes.⁷ It is recommended that all suitable photochemical measurements be checked against this uranyl oxalate actinometer, preferably with the solution in the cell under conditions identical with those applying in the measurements.

Reaction Cells. Rectangular quartz cells, with polished surfaces at front and back, are recommended. The beam of light should pass through the cell and onto the thermopile without distortion or overlapping. It should fill as much of the cell as possible without touching the sides. Dead spaces require the use of more reacting material and the percentage change is smaller. A satisfactory quartz cell for gas reactions, provided with a diaphragm for measuring pressures, is shown in Fig. 27.⁸

In some experiments the course of the reaction may be determined by chemical analysis either of the whole material or of successive samples. In still other experiments the reaction may be followed by the absorption of light through the application of Beer's law. The thermopile-galvanometer readings may be used for measuring both the intensity of light and the quantity of absorbing material in the gas phase or in solution. According to

⁶ Reference 5. Page 437.

⁷ Leighton and Forbes, page 180; *J. Am. Chem. Soc.*, **52**, 3139 (1930).

⁸ Damon and Daniels, *J. Am. Chem. Soc.*, **55**, 2364 (1933).

Beer's law the intensity of transmitted light I at a given wave length is related to the intensity of the incident light I_0 by the formula

$$I = I_0 e^{-klc}$$

where k is a constant, characteristic of the absorbing material and the wave length of the light, l is the fixed length of the cell in cms., and c is the concentration, usually expressed in moles per liter. The relation is such that the logarithm of the transmission (in per cent of the incident light) gives a straight line when plotted against the concentration. An example is given later in Fig. 31 on

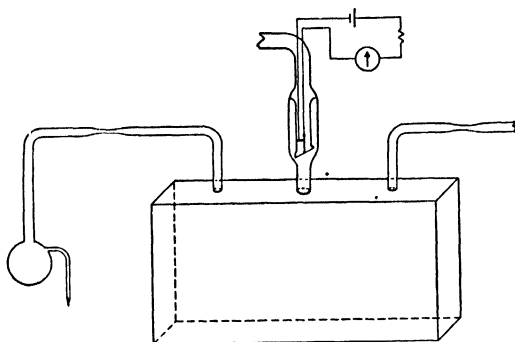

FIG. 27.—Rectangular cell of quartz for photochemical measurements.

page 158. If the line is not straight one may look for complicating circumstances such as dissociation of the material on dilution or the presence of more than one absorbing material.

The quantity of energy absorbed in effecting a photochemical reaction is determined by taking frequent thermopile-galvanometer readings while the beam of light is passing through the cell. With gas reactions, readings are taken when the cell is empty and when it is filled. With solutions, the cell is filled first with solvent and then with the solution. The difference gives the absorption due to the solute. A better procedure is to have two cells just alike side by side. The first is filled and the second one is either empty or filled with the solvent, and they are switched back and forth at regular intervals. These procedures require that the intensity of the lamp be constant between the readings. The capillary mercury lamps described previously are sufficiently constant for this pur-

pose, at least when operated on an isolated dynamo. This control with an empty cell is particularly important when the water of the thermostat is not perfectly clean. A trace of iron oxide from rusting cuts down greatly the blue and ultraviolet light. Thermostats for photochemical experiments should ordinarily be made of copper or brass and no iron should be placed in the thermostat water.

A small correction is necessary for the reflection losses at the interface between two substances of widely different refractive indices such as glass-air or quartz-air. The reflection from a quartz-liquid or glass-liquid interface is negligible. The quantitative relation involved is known as Fresnel's law.

$$\frac{I_r}{I_i} = \left(\frac{\mu - 1}{\mu + 1} \right)^2$$

where I_r is the intensity of the reflected light, I_i the incident light and μ the ratio of the refractive indices of the two media. For a quartz-air or air-quartz interface the reflected light amounts to about four per cent of the light incident at each interface when the light strikes the interface at right angles. When the light strikes at an angle the reflection losses are greater than are given by the preceding formula. In the procedure using the two cells this correction at the front is unnecessary because it is the same for the zero reading with the reference cell as it is with the reaction cell.

In exact work it is necessary to allow for absorption by the reacting system of some of the light which is reflected back from the windows at the rear of the cell and in the thermostat and thermopile, for this is not registered by the galvanometer. The correction is usually negligible or small.

Stirring is not necessary in gas reactions but it may be important in liquid systems. If the reaction rate changes with the intensity of light or the concentration of material it is clear that vigorous stirring is necessary to maintain uniform conditions, for the light is most intense at the front of the cell. A high intensity may produce a congestion of reaction products in the path of the light, particularly at the front, and, if the reaction is complex, it may be slowed down or accelerated by the accumulation.

QUANTUM YIELD

For qualitative photochemical investigations concerned only with the nature of the products the measurement of the quantum

yield is not necessary. However, if information regarding the velocity or mechanism of the reaction is desired the determination of the quantum yield is important. It is not sufficient to place the reacting system in the path of the light and measure the rate of chemical change, for, as the reaction proceeds the original material is consumed and the absorption of light decreases, unless the material is so concentrated as to give complete absorption.

The most fundamental quantity is the quantum yield Φ , the ratio of the number of molecules reacting to the number of photons actually absorbed. When this quantity is known, the extent of the photochemical reaction may be predicted from known values of the light intensity, the time of exposure and the absorption. Furthermore, important conclusions may be drawn from this quantum yield. If it is unity, the primary process is probably being measured, uncomplicated by secondary thermal reactions. If the quantum yield is nearly unity there are probably no major complications. If it is much greater than unity, a chain reaction is indicated. If the quantum yield is appreciably less than unity it is likely that (1) part of the absorbed energy is being converted into heat; (2) a second reaction is involved, either reversing the primary reaction or consuming energy in an independent, competing reaction; (3) some other absorbing material is present which prevents part of the energy from reaching the reacting material under consideration.

In calculating the quantum yield Φ , the number of moles reacting is determined by chemical or physical measurements, and multiplied by the Avogadro number 6.06×10^{23} to give the number of molecules reacting. The number of ergs absorbed is determined by multiplying the time in seconds by the thermopile-galvanometer readings and the conversion factor obtained from the calibration with the standard radiation lamp. Detailed examples are given later on pages 148 and 159.

The accuracy of the quantum yield measurements is limited by several factors. The error in absolute values may be up to five per cent but the relative accuracy and the reproducibility are probably good to one per cent. Usually the chemical analysis involves the greatest error.

Further consideration of photochemistry as a means of understanding chemical kinetics can be obtained best from the study of a few specific photochemical reactions.

THE PHOTOLYSIS OF NITROGEN OXIDES

N_2O_5 , N_2O_4 and NO_2 . In experiments on the thermal decomposition⁹ of nitrogen pentoxide it was found necessary to cover the reaction vessels with black paint to prevent decomposition by light. The photochemical reaction was studied further in connection with the radiation hypothesis which seemed important at that time. The first experiments were crude¹⁰ but they are worth describing in order to show how photochemical technique has improved during the past decade and a half. The reaction chambers with glass diaphragms were immersed in ice water and the course of the reaction was followed by means of pressure measurements. Filters of cupric chloride and calcium chloride were used in connection with direct sunlight and the radiation intensity was determined from the records of a weather observatory in a nearby building. It was found that pure nitrogen pentoxide is not decomposed by visible light, a fact which was predicted by the lack of color. Its decomposition product, nitrogen dioxide, however, acts as a strong photocatalyst. In its presence the photodecomposition of nitrogen pentoxide takes place rapidly with violet light somewhere between 4,000 and 4,600 Å. Light of 4,600 Å and longer wavelengths is absorbed but it does not cause decomposition. Quantum yields could not be determined with the equipment then available but a crude estimate was made that not more than forty-five photons were required for the decomposition of one molecule and probably the number was much less.

Four years later the problem was again attacked using an inefficient monochromator with a small glass prism. It was necessary to run a carbon arc continuously at a high current in order to produce a detectable decomposition giving a pressure change of two or three millimeters. The results were too uncertain for publication and the difficulties in getting sufficient monochromatic energy into the cell led to the development of the experimental techniques already described—the capillary arc, the large quartz monochromator, the large-area, self-integrating thermopile, and the rectangular quartz cell with the pressure diaphragm. The final results on the nitrogen oxides¹¹ give quantum yields which are probably accurate to a few hundredths of a unit, and the smooth-

⁹ Page 61.

¹⁰ Daniels and Johnston, *J. Am. Chem. Soc.*, **43**, 72 (1921).

¹¹ Holmes and Daniels, *J. Am. Chem. Soc.*, **56**, 630 (1934).

ness of the curves at different pressures indicates the reliability of the data.

The reaction cell was shown in Fig. 27. The bottom of the cell was covered with crystals of nitrogen pentoxide and the cell evacuated, sealed off and submerged in a thermostat under ice and water. The presence of the solid phase insured a partial pressure of 51.5 mm. of nitrogen pentoxide. This is the sublimation pressure at 0°. As soon as a molecule in the gas phase was decomposed, another molecule took its place. The pressure continued to rise as the light passed into the cell because each molecule of nitrogen pentoxide which decomposed produced two or three new molecules. After correcting for the shifting equilibrium between nitrogen tetroxide and nitrogen dioxide, as explained before,¹² the increase of pressure above 51.5 mm. permitted a calculation of the amount of nitrogen pentoxide decomposed. Another correction was necessary for the thermal decomposition at 0° amounting to about 0.00004 mm. per second. With bright light for short periods of time this thermal decomposition can be neglected, but for low intensities and long exposures it is too large to neglect.

Corrections for reflections at the interfaces were largely eliminated by taking the zero readings of the thermopile-galvanometer with an empty cell included in the path of the light. This cell's dimensions were the same as those of the reaction chamber. Some of the light which passed through the reaction cell was reflected back from the rear window and from the thermostat and thermo-

TABLE II
QUANTUM YIELDS WITH N₂O₅, NO₂, AND N₂O₄
WAVE LENGTH 3,660 Å, TEMP. 0°

Time min.	$I_{ir} \times 10^{-3}$ ergs/sec	$I_{ab.} \times 10^{-3}$ ergs/sec	$P - 51.5$ mm.	$P_{dec.}$ mm.	Φ	Fract. abs. by NO ₂
0	75.0	16.1	5.3	2.6	—	—
5	60.5	32.8	11.8	5.9	1.53	0.88
20	25.6	67.5	44.9	25.0	1.39	.75
35	11.3	80.6	83.7	48.4	1.15	.63
50	5.6	85.9	120.2	70.8	0.978	.56
65	3.0	88.6	153.0	91.3	.861	.51
80	1.7	89.6	184.5	111.3	.819	.48
95	1.1	89.9	214.3	129.9	.800	.45
110	0.7	90.4	242.4	147.5	.709	.43
125	.4	90.5	268.2	164.0	.665	.42
140	.3	90.8	292.3	179.3	.612	.41

pile windows. Part of it was absorbed by the reacting mixture and a correction was necessary, ranging up to a maximum of five per cent in cases where the transmission was high. With highly absorbing mixtures the correction was negligible.

The effect of radiation of 3,660 Å on the decomposition of nitrogen pentoxide, and dioxide is shown in Table II.

In the second column is shown the numbers of ergs I_{tr} , transmitted by the cell per second, at the times recorded in the first column. In the third column is shown the number of ergs absorbed per second after suitable, small corrections for reflection and re-absorption. The corresponding increase of pressure obtained by subtracting 51.5 mm. (the partial pressure of nitrogen pentoxide) from the total pressure P is shown in the fourth column. The amount of nitrogen pentoxide decomposed P_{dec} is shown in millimeters in the fifth column. In calculating these values a correction was made by the graphical method, already described, for the shifting of the N_2O_4 - NO_2 equilibrium. The number of molecules of nitrogen pentoxide decomposed was calculated from the volume of the cell, and the quantum yields Φ in the sixth column were obtained by dividing this number by the number of photons absorbed.

It is clear that the quantum yield decreases with time, as the pressure of the decomposition products is gradually built up. This decrease in quantum yield with accumulation of decomposition products is shown in Fig. 28.

Quantum Yields. In order to understand these data, it was necessary to obtain the absorption coefficients for the different gaseous substances: nitrogen dioxide, nitrogen tetroxide, and nitrogen pentoxide. The oxygen is transparent. The following formula

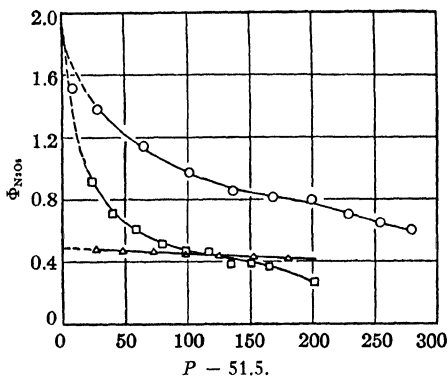

FIG. 28.—Quantum yields of $N_2O_5(+NO_2)$ at various decomposition pressures.

Δ—4,050 Å ○—3,660 Å □—3,130 Å

connects the absorption coefficients k of the different substances with the per cent absorption,

$$\ln \frac{I_0}{I} = k_{\text{NO}_2} p_{\text{NO}_2} l_{\text{NO}_2} + k_{\text{N}_2\text{O}_4} p_{\text{N}_2\text{O}_4} l_{\text{N}_2\text{O}_4} + k_{\text{N}_2\text{O}_4} p_{\text{N}_2\text{O}_4} l_{\text{N}_2\text{O}_4}$$

where I_0 = incident light, I = transmitted light, p = partial pressure and l = length of absorption cell.

Ordinarily it is a difficult thing to determine the absorption coefficients of several different absorbing substances when they are mixed together but in this case it can be done by appropriate changes in pressure and temperature. A mixture of the nitrogen dioxide and nitrogen tetroxide was introduced into the cell, the total pressure was measured and the partial pressure of each was calculated. The per cent absorption was then determined by dividing the thermopile-galvanometer deflections by the corresponding deflections obtained with an empty cell of the same dimensions. At temperatures above 45° and at pressures below thirty millimeters, the dissociation of N_2O_4 is practically complete and the absorption measurements involve only the nitrogen dioxide. In this way k_{NO_2} was obtained. Absorption measurements were again made with a mixture of nitrogen dioxide and nitrogen tetroxide at 0° and at a pressure of about one-hundred millimeters. Under these conditions a considerable portion of the light was absorbed by the nitrogen tetroxide. From the total absorption and the value of k_{NO_2} previously obtained, it was possible to calculate directly the absorption coefficient of N_2O_4 . In the same way absorption measurements were made on a mixture of all three gases of known partial pressures and having determined the absorption coefficients for NO_2

TABLE III
ABSORPTION COEFFICIENTS, $k = \frac{\ln I_0/I}{pl}$

Wave length	k_{NO_2}	$k_{\text{N}_2\text{O}_4}$	$k_{\text{N}_2\text{O}_4}$
4,360 Å	0.0192	0	0
4,050	.0216	0	0
3,660	.0187	0.00824	0
3,340	.013	.015	0
3,130	.00773	.0119	0
3,020	.0055	.0085	0
2,800	.00263	.0174	0.0029
2,650	.00136	.0243	.0063

and N_2O_4 , it was possible by difference to get the value of $k_{N_2O_5}$. This value was checked also by measurements of N_2O_5 alone, when the nitrogen tetroxide and dioxide were pumped out. All the absorption coefficients are given in Table III.

It is seen that N_2O_4 is transparent above 3,660 Å and that N_2O_5 is transparent at wave lengths longer than 2,800 Å.

The interpretation of Fig. 28 is now apparent. At 4,050 Å N_2O_4 and N_2O_5 do not absorb, and the molecules of nitrogen dioxide decomposed per photon absorbed is practically independent of the amount of decomposition products. But at the other two lines, 3,660 and 3,130 Å, nitrogen tetroxide absorbs light as well as nitrogen dioxide; however the light which it absorbs does not produce any permanent chemical change. In other words, the nitrogen tetroxide acts as an internal screen and reduces the amount of chemical reaction.

The situation is more clearly emphasized in Fig. 29 where the quantum yield is seen to be directly proportional to the per cent of light absorbed by the nitrogen dioxide. When there is no absorption by nitrogen dioxide there is no chemical action. It is seen that a straight line can be drawn fairly satisfactorily through these points and that it extrapolates to a value only slightly less than two when all the light is absorbed by the nitrogen dioxide. The small black circles represent the quantum yields as obtained from a mixture of nitrogen dioxide and nitrogen pentoxide. The nitrogen pentoxide acts as an acceptor for the nitric oxide produced by the photo-decomposition of nitrogen dioxide, preventing the reverse reaction and permitting an accurate measurement of the photochemical reaction. The larger circles represent less accurate meas-

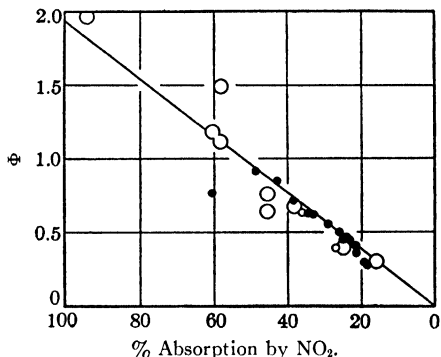

FIG. 29.—Quantum yield at 3,130 Å as a function of the light absorbed by nitrogen dioxide. The large circles represent less accurate measurements in the absence of nitrogen pentoxide.

urements made in the absence of nitrogen pentoxide by a method suggested by Norrish.¹³ In this method radiation at a constant intensity was passed into the reaction chamber and a steady equilibrium value was eventually obtained under conditions such that the rate of decomposition by light was exactly equal to the rate of recombination of the decomposition products—nitric oxide and oxygen. This rate is known from the kinetic measurements of Bodenstein and Lindner.¹⁴ The measurements of energy absorption combined with this rate of decomposition gave the quantum yields indicated by the large circles.

The quantum yields for the three different oxides of nitrogen are summarized in Table IV. Where they can be compared with the work of other investigators^{15,16} the agreement is good.

TABLE IV
QUANTUM YIELDS IN THE DECOMPOSITION OF NITROGEN OXIDES AT 0°

Wave length	N ₂ O ₅	N ₂ O ₄	NO ₂
4,360 Å	t	t	0
4,050	t	t	0.50
3,660	t	0	1.83
3,130	t	0	1.93
2,800	0.6	Small	(2)*
2,650	.6	0.4	(2)*

t, transparent.

* assumed.

At 3,130 and 3,660 Å nearly two molecules of NO₂ are decomposed for each photon absorbed by the nitrogen dioxide. At 4,360 Å there is no photochemical reaction, although the light is largely absorbed by the nitrogen dioxide in a many-lined spectrum. At 4,050 Å the quantum yield is 0.5. There is a difference in the nature of the absorption process in this particular region, chemical reaction occurring at the shorter wave lengths but not at the longer ones. At 4,050 Å the radiation is only partially effective and it would be interesting to study its efficiency at higher temperatures where the kinetic energy may be great enough to increase materially the yield.

The mechanism by which the nitrogen dioxide acts as a photo catalyst is as follows:

¹³ Norrish, *J. Chem. Soc.*, 1165 (1929).

¹⁴ Bodenstein, *Z. physik Chem.*, **100**, 87 (1922).

¹⁵ Dickinson and Baxter, *J. Am. Chem. Soc.*, **50**, 774 (1928).

Norrish, *J. Chem. Soc.*, 761 (1927); 1158, 1604, 1611 (1929).

¹⁶ Baxter and Dickinson, *J. Am. Chem. Soc.*, **50**, 774 (1928).

ated into nitrogen dioxide by the absorption of ultraviolet light but the re-combination of nitrogen dioxide to give nitrogen tetroxide is too rapid to be measured. W. A. Noyes, Jr.¹⁹ has suggested that the decomposition observed at the shortest ultraviolet may be due to the fact that the NO_2 molecules are thrown out with sufficient violence to behave as activated molecules and react with N_2O_5 .

Nitrogen pentoxide itself is transparent at the longer wave lengths, but it absorbs radiation at 2,800 and 2,650 Å and decomposes with a quantum efficiency of about 0.6. In this region Urey, Dawsey and Rice²⁰ found the absorption spectrum to be continuous, a fact which usually indicates dissociation of the molecule. The energy in radiation of this wave length is sufficient to decompose a single molecule into nitrogen tetroxide and atomic oxygen. If this reaction actually occurs it is sixty per cent efficient. If the decomposition requires two molecules of nitrogen pentoxide giving a molecule of oxygen, it is only thirty per cent efficient. The fact that the quantum yield is not exactly unity may be explained as inefficiency in the transfer of electronic excitation into localized energy of atomic vibration which precedes dissociation. The energy of excitation may be lost in competing transfers to unfruitful electronic states. In *polyatomic* molecules it is quite likely that the transfer of energy from electronic excitation to chemical dissociation should be rather inefficient. For N_2O_5 an alternative explanation may be suggested. If atomic oxygen is formed in the dissociation it can react directly, or through the formation of ozone, to oxidize nitrogen tetroxide to nitrogen pentoxide, thus reversing the reaction and reducing the apparent quantum yield.

The photolysis of nitrogen pentoxide and nitrogen dioxide offers an interesting example of "photo-autocatalysis." If visible light is allowed to pass through a cell containing pure nitrogen pentoxide, no reaction occurs because no light is absorbed. However, the nitrogen pentoxide decomposes thermally and after a time produces small amounts of nitrogen dioxide. This nitrogen dioxide then is able to absorb some of the photons passing through the cell and indirectly it decomposes nitrogen pentoxide as already indicated. This photoreaction rapidly produces more nitrogen dioxide and still more photons are absorbed. This accelerating reac-

¹⁹ Noyes, *Symposia on Quantitative Biology* III, Cold Spring Harbor, N.Y., (1935), p. 9.

²⁰ Urey, Dawsey and Rice, *J. Am. Chem. Soc.*, 51, 3190 (1929).

tion is typical of any autocatalytic process. Eventually nitrogen dioxide is produced in such quantities that practically all the light passing into the cell is absorbed, and then at a constant light intensity the reaction rate becomes constant if the supply of nitrogen pentoxide is maintained constant. If the supply is not maintained the reaction will slow down and stop.

Effect of Foreign Gases. Having developed an accurate method for determining the quantum yield in the photodecomposition of nitrogen dioxide it became of interest to determine the effect of foreign gases and of solvents in reducing the efficiency of the reaction. The quantum yields are recorded in Table V.

TABLE V
EFFECT OF FOREIGN GAS ON THE PHOTO-DECOMPOSITION OF NITROGEN DIOXIDE AT 0°

Foreign gas	Pressure of gas mm.	$\Phi_{\text{NO}_2}^{\text{N}_2\text{O}_5}$ * 4050Å	$\Phi_{\text{NO}_2}^{\text{N}_2\text{O}_5}$ 3660 Å	$\Phi_{\text{NO}_2}^{\text{N}_2\text{O}_5}$ 3130Å
None	0**	0.50	1.83	1.93
Helium	614	.51	1.66	1.72
Argon	699	.44	1.38	1.32
Nitrogen	574	.46	1.48	1.27
Nitrogen	595	.44	1.45	1.27
Oxygen	584	.45	1.40	1.38
Oxygen	619	.42	1.20	1.23
Hydrogen	532	.37	1.43	1.27
Carbon dioxide	120	.45	1.62	1.50
Carbon dioxide	326	.42	1.44	1.35
Carbon dioxide	431	.40	1.32	1.24
Carbon dioxide	652	.36	1.32	—
Carbon dioxide	683	.36	1.21	1.12
Nitrous oxide	567	.34	1.27	1.18
Nitrous oxide	679	.34	1.16	1.10

* The subscript for Φ designates the substance which absorbs the light; the superscript designates the substance which is measured chemically.

** The partial pressure of nitrogen pentoxide was maintained constant at 51.5 mm. in all the experiments.

The quantum yield is decreased by collisions with foreign gases. The nitrogen pentoxide is not a factor in the photochemical reaction—it merely makes the measurement of the decomposition more convenient and more accurate. Only by reducing the experimental errors to about three per cent can the influence of foreign gases be studied quantitatively. The reduction in the quantum yield depends on the number of collisions and on the complexity of the colliding molecule, ranging roughly from a ten per cent decrease

with helium to a forty per cent decrease with carbon dioxide or nitrous oxide when the pressure is nearly an atmosphere.

In Fig. 30 it is seen that the effect with carbon dioxide is nearly proportional to the pressure. The reduction in quantum yield is due to the removal by collision of the excess energy of the excited nitrogen dioxide molecules before they can collide with other molecules of nitrogen dioxide and effect a chemical reaction. The energy is removed in the form of extra energy given to the colliding molecules, and thus converted into heat.

One atmosphere of a polyatomic gas reduces the quantum yield by thirty to forty per cent whereas only a few millimeters of a

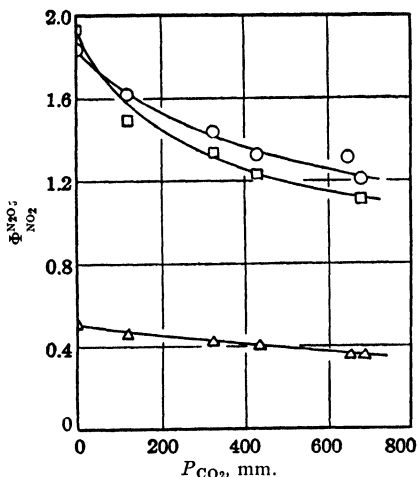

FIG. 30.—Effect of carbon dioxide in reducing the quantum yield $\phi_{NO_2}^{NO_2}$ (corrected for screening by nitrogen tetroxide): Δ —4,050, \circ —3,660, \square —3,130 Å.

foreign gas is required to quench completely the fluorescence of nitrogen dioxide.²¹ Apparently the electronic energy, which manifests itself as fluorescence, can be much more easily removed by collisions than can the energy of chemical activation which probably exists mostly as excitation of the vibrating atoms.

Deactivation by solvents may be considered as an extreme case of deactivation by a foreign gas. Several experiments were carried out in a carbon tetrachloride solution of nitrogen pentoxide and nitrogen dioxide. The decomposition was followed in two ways: by the evolution of oxygen gas from the solution, and by titration of the nitrite produced when the carbon tetrachloride solution is shaken with a dilute alkali solution. The gas evolution gave more accurate results. Great precautions were necessary to keep out every trace of moisture.

²¹ Norrish, *J. Chem. Soc.*, 1611 (1929); Baxter, *J. Am. Chem. Soc.*, 52, 3920 (1930).

The quantum yield Φ is small, amounting to only a few hundredths, but it is definite and reproducible.

The complete results are shown in Table VI.

TABLE VI
PHOTOLYSIS OF N_2O_5 AND NO_2 IN CARBON TETRACHLORIDE AT 0°

Wave length	Absorption, per cent	Time expos., min.	Quanta absorbed $\times 10^{-18}$	Total decomp. cc. O_2	Molecules decomp. $\times 10^{-18}$	Φ Quantum yield
4,050 Å	29	30	5.12	0.019	0.24	0.05
4,050	35	30	5.90	.016	.10	.02
3,660	76	25	25.3	.023	.44	.02
2,800	100	60	23.1	.040	.87	.04
2,650	100	65	19.6	.041	.87	.04
2,650	100	30	8.97	.022	.48	.05
2,650	100	30	8.74	.025	.63	.07

Liquid carbon tetrachloride, as would be expected, is considerably more effective in deactivating excited nitrogen dioxide than is an atmosphere of carbon dioxide. At 2,800 and at 2,650 Å most of the radiation is absorbed directly by nitrogen pentoxide and here also the solvent appears to deactivate the molecules effectively even though collision with a second molecule does not seem to be necessary for chemical decomposition.

THE PHOTOLYSIS OF ACETONE ✓

This reaction has been studied quantitatively in three different laboratories and all the results²² are in good agreement on the quantum yield and the most important factors, although some minor points such as the chemical analysis of the products are still unsettled. It is a simple reaction with a low quantum yield—considerably less than unity. It offers a good example of a reaction in which free radicals are produced. The chief reaction is

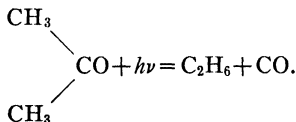

Experimental Procedure. The photochemical technique used in this investigation has been described. Practically monochromatic

²² Damon and Daniels, *J. Am. Chem. Soc.*, **55**, 2363 (1933).
Norrish, Crone and Saltmarsh, *J. Chem. Soc.*, 1456 (1934).
Noyes, Duncan and Manning, *J. Chem. Phys.*, **2**, 717 (1934).
Howe and Noyes, *J. Am. Chem. Soc.*, **58**, 1404 (1936).

light up to an intensity of 100,000 ergs per second was obtained from a capillary quartz, mercury-vapor lamp (Fig. 25) and the large quartz monochromator (Fig. 26). The lamp was operated at a heavy load—about one kilowatt. The beam of light from the exit slit of the monochromator, rendered parallel by a convex lens of quartz, was passed through the rectangular quartz cell (Fig. 27) ten centimeters long, and onto the large-area thermopile. An empty quartz cell, identical with the first, was used in getting the zero reading. Both the cell and the thermostat were immersed deep in a well-stirred water thermostat of copper provided with a quartz window. The thermostat was set at 56°, the boiling point of acetone. On account of the high temperature it is necessary to construct the thermopile with gylptol cement instead of deKohinsky cement, and to correct the calibration for this higher temperature. The pressure change was followed to 0.1 mm. by balancing a measured air pressure against the pressure in the cell through a flexible quartz diaphragm carrying a platinum point which closed an electrical circuit (Fig. 10). At the end of an experiment the gases were pumped out with a Toepler pump and analyzed.

The acetone was purified by crystallization with sodium iodide, thoroughly dried, and distilled into a small quartz bulb fused to the cell, after thorough heating and drying of the cell. After partial evaporation the acetone was distilled into the cell, and sealed off while cooled with solid carbon dioxide to prevent decomposition of the vapor.

In a typical experiment radiation at 3,130 Å was absorbed by the acetone vapor at the rate of 85,200 ergs per second (corrected for reflections) for a period of 23,000 seconds. The pressure of acetone was 760.0 before the radiation and 790.4 after it. Two molecules are produced for each molecule of acetone decomposed (neglecting minor products) and hence the total number decomposing can be easily calculated from the pressure increase Δp (30.4 mm. at 56.0°), the volume v (60.3 cc.) and the Avogadro number. Thus

$$\begin{aligned} \Delta p/760 \times 273/T \times v/22,400 \times N \\ = \frac{30.4}{760} \times \frac{273}{273+56} \times \frac{60.3}{22,400} \times 6.06 \times 10^{23} = 5.28 \times 10^{19}. \end{aligned}$$

The number of photons absorbed is then calculated from the radiation at 3,130 Å.

$$\frac{85,200}{6.55 \times 10^{-27} \times 3 \times 10^{10} / 3.13 \times 10^{-5}} \times 23,000 = 3.11 \times 10^{20}.$$

The molecules decomposing divided by the number of photons absorbed gives directly the quantum yield Φ . In this case it is

$$\frac{5.28 \times 10^{19}}{3.11 \times 10^{20}} = 0.17.$$

It was soon discovered that traces of moisture had a great effect on the photolysis, producing a decrease in pressure instead of an increase. These two effects were separated by reading the pressure at the higher temperatures as already described and again determining the pressure after cooling to 0°. The product responsible for the decrease in pressure—probably diacetone alcohol, dissolves in the condensed liquid acetone and the difference between the observed pressure at 0° and the vapor pressure of acetone at 0° is a measure of the permanent gases produced by the decomposition. The difference between this increase and the observed increase at 56.0° corrected to 0° permits a determination of the number of molecules of acetone condensed.

In the summary of several determinations given in Table VII the quantum yield Φ is calculated on the basis of the number of molecules decomposing plus the number condensing. Judging from the constancy of the results the quantum efficiency is the same for both reactions.

TABLE VII
THE QUANTUM EFFICIENCY IN THE DECOMPOSITION OF GASEOUS ACETONE
AT 3,130 Å AND 56°.

Total pressure in mm.	633.2	684.2	742.2	768.6	766.3	760.0	732.7	733.4
Intensity in ergs/sec.	35500	41000	64600	63600	44000	85200	66800	84000
Total time in seconds	50300	74800	27000	19800	25000	23000	16000	18600
ΔP in mm.	10.0	-1.8	31.4	12.5	169.	30.4	-1.9	-4.0
Molecules decomposed $\times 10^{-19}$	2.86	3.62	5.47	2.27	2.93	5.28	1.76	1.92
Molecules condensed $\times 10^{-19}$	1.11	3.95	3.00	0.1	none	none	2.08	2.63
Molecules /quantum	0.17	0.16	0.20	0.12	0.17	0.17	0.23	0.18

Average quantum yield $\Phi = 0.17 \pm 0.02$

Absorption Spectrum. The absorption spectrum of acetone extends from 2,200 to 3,300 Å and is typical of the carbonyl group. Ordinary examination indicated that it was continuous, but using a large prism spectrograph and special care Norrish, and Noyes were able to show²³ that the spectrum is discontinuous at wave lengths longer than 2,950 Å. The absorption follows Beer's law exactly, as shown by the fact that measurements obtained with the thermopile at ten different pressures gave an excellent straight line when the logarithm of the per cent transmission was plotted against the pressure. The absorption coefficient k , defined by the equation

$$I = I_0 e^{-kcl},$$

has a value of 6.63 ± 0.06 at 3,130 Å and 25.9 ± 0.4 at 2,650 Å. The length l is expressed in centimeters and the concentration c in moles per liter. These values are in good agreement with earlier values²⁴ obtained photographically.

A green fluorescence accompanies the passage of ultraviolet light into acetone vapor. It is so brilliant that one might expect that a considerable portion of the energy of absorbed radiation might be lost in this fluorescence. To test this point the large-area thermopile was placed at the side of a cell containing fluorescent acetone vapor but no energy whatever could be detected. It was shown that if as much as three per cent of the ultraviolet radiation was converted into fluorescent light it would have been easily measured by this experiment. It may be safely concluded, then, that the energy lost as fluorescence is less than three per cent, and perhaps much less. It is negligible in comparison with the energy which is consumed in chemical action, or lost as heat in the increased kinetic energy of the molecules. It is likely that other examples of fluorescence, which are usually less intense than the fluorescence of acetone, involve such small quantities of energy that they are not a factor in the kinetics of the reactions.

Foreign Gases. If any oxygen is present with the acetone vapor a blue fluorescence is obtained instead of the green. The oxygen is gradually consumed however and the blue color changes after a time to intense green. In fact it is possible at the critical time when the oxygen is just exhausted to see a distinct line of demarcation

²³ Norrish, Crone and Saltmarsh, *J. Chem. Soc.*, 1456 (1934).

Howe and Noyes, *J. Am. Chem. Soc.*, **58**, 1404 (1936).

²⁴ Porter and Iddings, *J. Am. Chem. Soc.*, **48**, 40 (1926).

between blue and green move slowly across the cell from the front window to the rear. This phenomenon has been made the basis of a sensitive analytical test for minute traces of oxygen.²⁵ The test can be made quantitative by measuring the time required for the appearance of the green color or the time required for its reappearance after the addition of a known amount of oxygen. The effect of traces of water has been described. In one experiment the introduction of 1×10^{17} molecules of water caused 2.3×10^{19} molecules of acetone vapor to undergo condensation rather than decomposition. There can be no stoichiometrical relation in this 230 to 1 relationship and if there was any chemical reaction the water would have been quickly removed and the tendency for a pressure decrease would have stopped. However, the rate of condensation was just as rapid at the end of the four hour experiment as at the beginning. The water then is not consumed, it acts merely as a catalyst. The most plausible reaction appears to be one in which diacetone alcohol is formed, thus

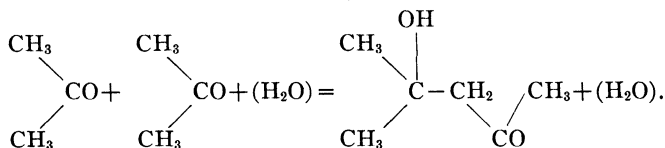

If water and oxygen are absent a molecule of acetone, which has become activated by the absorption of a photon, will decompose. If oxygen is present it will be oxidized in preference to decomposition. If water is present it will undergo reaction with a second acetone molecule in preference to decomposition. The quantum yield for decomposition, condensation and oxidation are the same.

Mechanism. The nature of the decomposition process can be studied best from a knowledge of the quantum yield and the factors which influence it, together with the analysis of the decomposition products. The low quantum yield of about 0.2 molecule per quantum indicates that the photolysis is comparatively inefficient. There is no other material present to absorb the radiation and in the absence of water and oxygen there are no competing side reactions. The molecule is so simple that there cannot be two different absorbing groups, only one of which is photochemically active. "Internal screens" are thus ruled out. The low yield must be due

²⁵ Damon, *Ind. Eng. Chem. Anal. Ed.*, **7**, 133 (1935).

Fugassi, *J. Am. Chem. Soc.*, **59**, 2092 (1937).

either to inefficiency in transferring the energy of electronic excitation into energy of atomic vibration preliminary to decomposition, or to a reverse reaction which appears to decrease the net rate of the reaction. Experiments showed that the quantum yield decreased at low pressures and increased at low intensities. The quantum yield increased to 0.3 at 2,650 Å but the intensity was less at this wave length and a correction for the difference brought the value down to about the same value as given in Table VII.

The analysis of the products gave roughly fifty per cent carbon monoxide, thirty per cent ethane, fifteen per cent methane and five per cent hydrogen. The condensed liquid was always colored straw yellow or brown probably due to further decomposition. These color tests are extremely sensitive and the amount of any colored products may be quite negligible. Norrish found about forty-seven per cent carbon monoxide, forty-four per cent ethane and nine per cent methane. His light intensity was presumably less and the methods of analysis were different. It is certain, however, that although most of the molecules decompose to give carbon monoxide, they do not give pure ethane as the remaining product. These experiments show that even with pure monochromatic light, a photochemical process is still complex and there may easily be more than one reaction going on simultaneously.

Norrish²⁶ thought that fluorescence could be obtained only in the region in which he found a discontinuous spectrum,—at wave lengths longer than 2,950 Å; but this observation is not in agreement with the findings in this laboratory²⁷ using very intense radiation. He concluded that the difference in quantum yield between the longer and the shorter ultraviolet was due to different mechanisms. It has been shown that the loss of energy by fluorescence is too small to account for any observed difference in quantum yield. Differences in intensity of light and pressure of the gases may complicate conclusions regarding the nature of the photolysis.

The low quantum yield tends to exclude chain reactions but it is possible that complex reactions of the products might act in such a way as to give a low apparent quantum yield in spite of a chain reaction. Leermakers²⁸ found that the quantum yield of acetaldehyde increases from less than unity at room temperature

²⁶ Norrish, Crone and Saltmarsh, *J. Chem. Soc.*, 1456 (1934).

²⁷ Howe and Noyes, also find fluorescence at 2,536 Å. *J. Am. Chem. Soc.*, **58**, 1404 (1936).

²⁸ Leermakers, *J. Am. Chem. Soc.*, **56**, 1537 (1934).

to about 300 at 300°, showing the presence of chain reactions at high temperatures, but there is no such increase at high temperatures in the case of acetone.²⁹ The quantum yield increased only from 0.2 to about 2 over a large temperature range of 250°. Accordingly in the photolysis of acetone one can feel safe in ignoring chain reactions which follow the primary photoprocess.

The mechanism by which acetone decomposes when exposed to ultraviolet light is important in kinetics. It would seem to be a rather simple reaction which should be typical of many other, more complicated reactions. Obviously the radiation is absorbed by the C=O group and the energy is transferred to break one or both of the C—C bonds, which hold the two methyl groups to the central carbon atom. Radiation of 3,130 Å corresponds to about 91,000 calories per mole, and radiation of 2650 Å to 107,500 calories. When a molecule absorbs a photon of this ultraviolet light it becomes activated by electronic displacement and it may then (1) decompose chemically, (2) emit fluorescent light, (3) transmit extra translational energy to the molecules with which it collides. The experimental facts show that under the conditions described here the chances are, respectively, about 17 in 100 for chemical reaction; less than 3 for fluorescence; and 80 for degradation as heat. As already shown, the low quantum yield cannot be attributed to fluorescence.

Of the various types of chemical decompositions the following are suggested

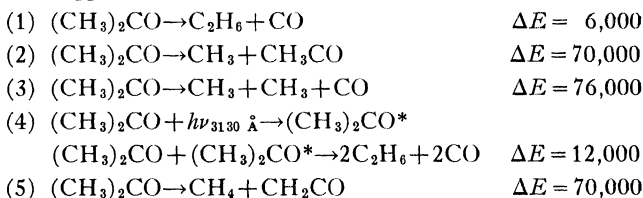

The methods of estimating the heats of reaction, ΔE , as given in the last column merit a little amplification. They show how estimates can be made with little effort. Reaction (1) involves the breaking of two C—C bonds 70,000 calories each, the formation of one C—C bond 70,000 (exothermic) and the formation of CO which is 64,000 calories more stable than the >CO group which is present in the ketone. In the language of quantum chem-

²⁹ Leermakers, *J. Am. Chem. Soc.*, **56**, 1899 (1934).

istry carbon in $>CO$ is in the triplet II state, whereas in CO it is in the singlet II state. The energy of formation of $>CO$ is estimated from spectroscopic data to be 166,000 calories and CO to be 230,000 calories. The total heat absorbed (ΔE) is 140,000 - (70,000 + 64,000) or 6,000 calories. The heat of reaction taken directly from heats of combustion of the three substances is 13,500 calories.

In reaction (2) the only change is the breaking of a carbon-carbon bond giving two free radicals and this involves the absorption of 70,000 calories.

In reaction (3) two carbon-carbon bonds are broken and at first sight one would expect this dissociation to absorb 140,000 calories but, as in equation (1), 64,000 calories is evolved in going from the $>CO$ radical to carbon monoxide. The sum total of energy absorbed then is 76,000 calories.

In reaction (4) the heat absorbed is twice that absorbed in equation (1) and amounts to only 12,000 calories. The quantum of energy introduced is equivalent to 91,000 calories per mole.

In reaction (5), as in equation (2), the only over-all effect is the breaking of a carbon-carbon bond giving an endothermic reaction of 70,000. One carbon-hydrogen bond is broken but another one is formed so that the two exactly offset each other.

It is evident that on the basis of thermochemistry all of these reactions are possible because 91,000 calories per mole is available from the ultraviolet light absorbed. All the reactions are endothermic and one can say only that the energies of activation will be at least as large as these values of ΔE , but they may be much larger.

Quantum calculations can make some selections in this case even though thermochemistry can not. The reverse of reaction (2) involves free radicals and the activation energy of free radicals is very low, 5,000 to 10,000 calories or less. The energy of activation for decomposition of acetone by reaction (2) then can not be much greater than 75,000 or at the most 80,000 calories and it can not be much less than 70,000.

The energy of activation, calculated from the influence of temperature on the rate of the thermal decomposition, is estimated as 68,500 calories.³⁰ If this value is correct there is ample energy available in the radiation to effect the same type of decomposition

³⁰ Hinshelwood and Hutchison, *Proc. Roy. Soc. London*, 111A, 245 (1926).

as occurs in a vessel of acetone gas heated to 500 or 600°. However, the greater energy available in the ultraviolet light may well cause the molecules to decompose in a different manner. There is considerable evidence that the first thermal decomposition of acetone gives methane and ketene.³¹

The presence of fluorescence, and the existence of discontinuity in the absorption spectrum above 2,950 Å suggests reaction (4) with activated molecules as a plausible mechanism.

The presence of methane in the decomposition products together with the fifty per cent of carbon monoxide indicates a reaction more complicated than (1) or (4) and favors reaction (2) or (5). Rice and Herzfeld³² have proposed a series of chain reactions for the thermal decomposition of acetone which would give both methane and ethane. The recombination of CH₃ and CH₃CO according to (2) might account for the low quantum yield.

The most likely mechanism for decomposition now appears to be this splitting-off of a free methyl radical. In fact the photolysis of acetone has come to be considered one of the best ways of introducing free radicals into a reaction chamber. Experiments with metallic mirrors³³ give evidence for the existence of free radicals in acetone through which ultraviolet light is passing. A direct test has been reported by West,³⁴ using the conversion of ortho-hydrogen to para-hydrogen. This conversion is not effected by acetone but it is effected by any group of atoms with an odd electron such as a free radical, or a hydrogen atom.

Norrish has suggested that the low quantum yield is probably due to the complexity of the molecule. Decomposition cannot occur if there is a wide distribution of energy among the various parts of a complex molecule for then there is not a sufficient quantity left at the one particular bond where chemical disruption must occur. The probability that a fraction of the whole amount sufficient for chemical decomposition will reach the proper bond at the proper instant depends largely on the complexity of the molecule and the amount of energy introduced. With acetone this probability appears to be about 0.2; with crotonic aldehyde the probability is zero, for Blacet and Roof³⁵ have shown that this substance does

³¹ Rice, Greenberg, Waters and Vollrath, *J. Am. Chem. Soc.*, **56**, 1760 (1934).

³² Rice and Herzfeld, *J. Am. Chem. Soc.*, **56**, 286 (1934).

³³ Pearson, *J. Chem. Soc.*, 1718, (1934).

³⁴ West, *J. Am. Chem. Soc.*, **57**, 1931 (1935).

³⁵ Blacet and Roof, *J. Am. Chem. Soc.*, **58**, 73 (1936).

not decompose at all in spite of its absorption of an ample amount of ultraviolet radiation. If a sufficient amount of energy does not reach the particular bond just as the atoms are near the further limit of their amplitudes in the inter-atomic vibrations the atoms cannot fly apart and the energy will flow into other parts of the molecule and eventually become degraded as heat. To be effective for chemical disruption the energy would have to remain localized in this bond until the next time in the vibration period at which the molecules are farthest apart—perhaps 10^{-13} second later. The chance that this energy will remain localized and give a quantum yield of unity becomes less as the molecule becomes more complex.

Experiments on the mixed ketones³⁶ provide another argument in favor of the direct splitting of ketones into free radicals when exposed to ultraviolet light. Methyl ethyl ketone was found to decompose into fifty per cent carbon monoxide and a mixture of equal parts of ethane, propane and butane according to the reaction

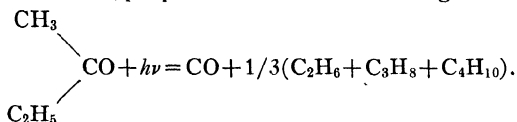

The C_3H_8 would be expected if the molecule was simply broken in two, the methyl and ethyl combining before the molecule became completely disrupted. The presence of the C_2H_6 and C_4H_{10} however indicates that the methyl and ethyl radicals must have separated and must have had an independent existence sufficiently long to find similar free radicals from other disrupted molecules.

It is well to remember that in some of these proposed mechanisms it is difficult to say just when an activated molecule or fragment of molecule has split up into free radicals. If the separated parts recombine before they can diffuse away or before they collide with other molecules, the regenerated, activated molecule should not be considered as involving free radicals.

The mechanism by which the ketones and aldehydes decompose and the part played by different free radicals has been the subject of considerable discussion, and the interpretation of some of the details has become a controversial matter. The views of several different investigators were expressed at a symposium held in the summer of 1935.³⁷

³⁶ Norrish and Appleyard, *J. Chem. Soc.*, 874 (1934).

³⁷ *Symposia on Quantitative Biology*, III, Cold Spring Harbor, N.Y., pages 1-55 (1935).

The theory of the photolysis of acetone has been discussed in a comprehensive manner by Howe and Noyes.³⁸ They have obtained new, exact experimental data in the short ultraviolet near 1,900 Å which they have correlated with the earlier work in the longer ultraviolet.

THE PHOTOBROMINATION OF CINNAMIC ACID

This reaction is chosen as an example of still a third class of photochemical reaction—one in which the quantum yield is considerably greater than unity. It is a typical chain reaction.

The addition of halogens to unsaturated organic compounds is a matter of considerable importance. In some cases the reaction goes so fast thermally that it is impossible to study the photochemical reaction—in others the addition at room temperature is negligibly slow in the absence of light. It is likely that in halogenation reactions the diffuse light of the ordinary laboratory often plays more of a rôle than is generally realized. The problem of the direct addition of halogens to the carbon-carbon double bond will be discussed in detail from a theoretical standpoint in Chapter IX.

The bromination of cinnamic acid dissolved in carbon tetrachloride or other inert solvent, offers a convenient system for study. The dibromocinnamic acid produced remains in the carbon tetrachloride solution. The thermal reaction is so slow that it can barely be measured at room temperature and it is entirely negligible in comparison with the photochemical reaction at ordinary intensities. The quantum yield is so large that considerable reaction occurs even if the intensity of light is much reduced by the monochromator or other device for confining the light to a narrow range of frequencies. Furthermore, the reaction is easily and accurately followed by titration with sodium thiosulfate. Potassium iodide is added and the iodine liberated is a measure of the remaining bromine.

The reaction has been studied by several investigators and the influence of concentration and other factors on the quantum yield have been made the subject of an extended study.³⁹

Experimental Results. The general procedure was similar to that already described. With the monochromator utilizing a large hollow, glass prism filled with ethyl cinnamate the quartz capillary lamp gave about 25,000 ergs per second of quite pure radiation

³⁸ Howe and Noyes, *J. Am. Chem. Soc.*, **58**, 1404 (1936).

³⁹ Bauer and Daniels, *J. Am. Chem. Soc.*, **56**, 2014 (1934).

from the violet lines of the mercury spectrum. A tall, narrow quartz cell was nearly filled with the purified and dried solution of bromine and cinnamic acid in carbon tetrachloride and placed in the thermostat water in front of the thermopile. A second cell, identical with the first, was filled with pure carbon tetrachloride

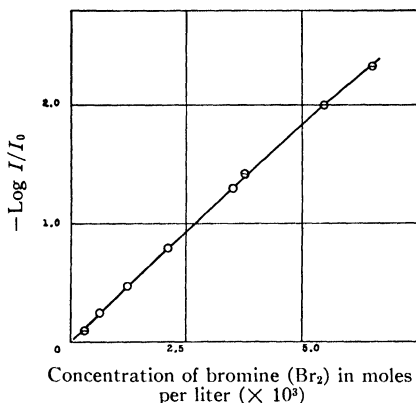

FIG. 31.—Straight line proving the applicability of Beer's law. Points, \ominus , indicate products of reaction are present.

and used for the zero readings. Corrections for reflection were negligible. After filling with the carbon tetrachloride solution the cell was closed with a ground glass cap. All operations of mixing, filling and mounting were carried out in feeble red light. The solution was effectively stirred with a quartz stirrer rotating in a mercury seal and extending only into the top of the solution above the path of the light which passed through

the cell. The reaction rate depends on the concentration of bromine and it was found that if the stirring was stopped for even a short time the reaction slowed down because the concentration of bromine in the actual path of the light was decreased abnormally. Cinnamic acid is transparent to visible light but bromine absorbs blue and violet light intensely and shows absorption nearly to the red. In the photochemical reactions the bromine is the active agent. The absorption follows Beer's law strictly as is shown in Fig. 31 where the negative logarithm of the fractional transmission of light at 4,360 Å, as determined from the thermopile readings, is plotted against the concentration of bromine. The value of k in the equation, $I = I_0 e^{-klc}$, is 448 ± 6 when l is expressed in centimeters and c in moles per liter. The points marked with a cross were determined with excess of the product, dibromocinnamic acid, present. It is evident that there are no complicating factors involved here.

The quantum yields were calculated in the standard manner as illustrated with the following example.

Intensity of light (4,360 Å) absorbed = 12,920 ergs per sec.

Time of exposure = 895 sec.

$$\begin{aligned} \text{Total quanta absorbed} &= \frac{12,920 \times 895}{6.55 \times 10^{-27} \times 3 \times 10^{10} / 4.36 \times 10^{-5}} \\ &= 2.57 \times 10^{18}. \end{aligned}$$

Moles of bromine reacting = 5.4×10^{-6}

Molecules of bromine reacting = $5.4 \times 10^{-6} \times 6.06 \times 10^{23} = 3.27 \times 10^{18}$

$$\text{Quantum yield, } \Phi = \frac{\text{molecules reacting}}{\text{quanta absorbed}} = \frac{3.27 \times 10^{18}}{2.57 \times 10^{18}} = 1.3.$$

A summary of the results at 30.6° is given in Table VIII.

TABLE VIII

QUANTUM YIELDS, Φ , FOR PHOTOBROMINATION OF CINNAMIC ACID
TEMPERATURE 30.6° WAVE LENGTH 4,358Å

c_{Br_2} moles $\times 10^3$ liter ⁻¹	Br ₂ reacting moles $\times 10^3$	I_0 ergs $\times 10^{-3}$ sec. ⁻¹	I_a ergs $\times 10^{-3}$ sec. ⁻¹	t sec.	Φ molecules quantum
7.30	0.0692	14.10	13.96	910	15.0
6.93	.0756	14.00	13.88	904	16.5
5.00	.0446	11.54	11.22	922	11.8
3.30	.0301	13.26	12.01	911	7.6
1.94	.0168	12.08	9.66	955	5.0
1.77	.0170	14.20	11.06	897	4.7
1.26	.0086	12.28	7.11	905	3.6
1.08	.0088	14.60	8.43	908	3.1

A separate filling was made for each experiment, the whole of the solution being titrated each time. Obviously the concentration of the bromine was changing continuously and the values in the first, third and fourth columns are average values. There was an excess of cinnamic acid, 0.0055 moles per liter or more, in all cases except the first.

The quantum yield Φ as given in the last column of Table VIII is plotted in the upper curve of Fig. 32 against the concentration of bromine expressed in millimoles per liter. It is a striking fact that the quantum yield, which is a measure of chain length, de-

creases with decreasing concentration of bromine. At infinite dilution one molecule of bromine reacts for each photon absorbed. In other words when the bromine molecules are widely separated from each other the chain reaction, which follows the primary photo process, can not continue. In this reaction then it is possible to separate the primary photochemical reaction from the secondary thermal reactions.

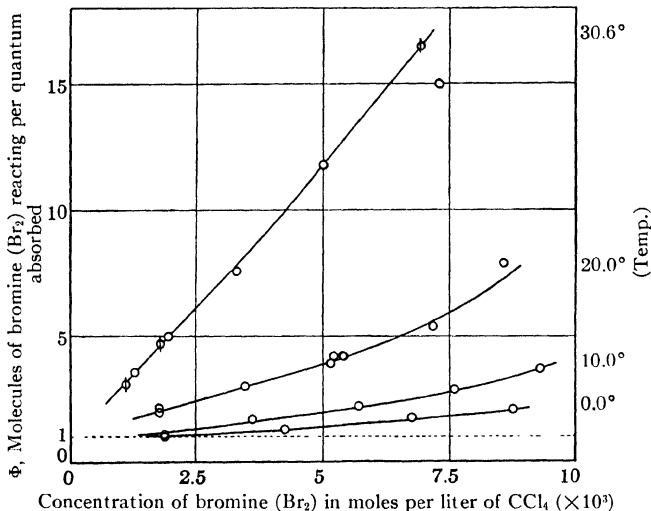

FIG. 32.—Influence of bromine concentration on quantum yield: initial concentration of cinnamic acid 0.0110 for points Φ for all other points, 0.0055.

Similar results were obtained at lower temperatures—at 20, 10 and 0°. The quantum yield is considerably smaller at lower temperatures but again the lines at all temperatures extrapolate to unity at infinite dilution. This is in striking agreement with theory—for when the primary photochemical process is stripped of its secondary thermal complications it should be independent of temperature.

Another proof of the separation of the photo and thermal reactions is given in Fig. 33. In ordinary thermal reactions a straight line is usually obtained when the logarithm of the velocity constant is plotted against the reciprocal of the absolute temperature. Plotting $\log \Phi$ against $1/T$ as in Fig. 33(a), it is seen that a straight

line is not obtained. However, if $\log (\Phi - 1)$ is plotted against $1/T$ straight lines are obtained as shown in Fig. 33(b). The quantum yield Φ includes the one molecule which reacts photochemically together with all the additional molecules which react thermally. Subtraction of this one molecule from the total Φ gives a measure of the thermal reaction and converts the $\log - 1/T$ line into a straight line. This thermal, secondary reaction has a large temperature coefficient whereas the primary photochemical reaction has none.

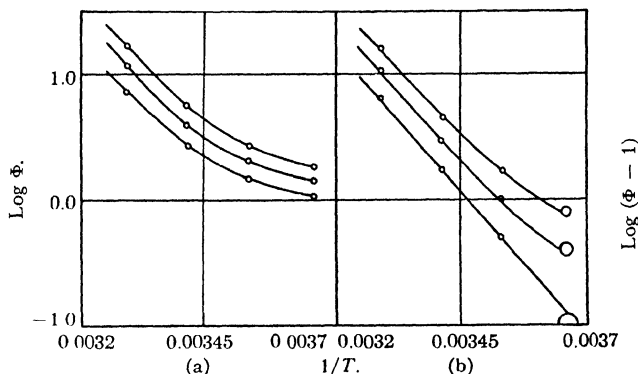
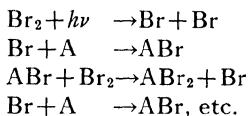

FIG. 33.—Influence of temperature on the photobromination of cinnamic acid.

Mechanism. The quantum yields show that except at great dilutions of bromine the photobromination certainly involves a chain reaction. Three different chains have been suggested.

According to an atom chain, in which the cinnamic acid is indicated by A,



The chain may be stopped by reactions

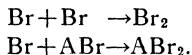

This type of chain involving bromine atoms and monobromo free radicals (with one bromine atom instead of two added to the

double bond) has been used to account for many reactions involving the halogens. It was applied to the photobromination of cinnamic acid by Berthoud and Beranek.⁴⁰

According to another hypothesis frequently suggested, the bromine atoms combine with bromine molecules to give triatomic bromine molecules which are rather unstable and after reaction they regenerate the bromine atoms, ready to repeat the cycle. This chain was applied to the photobromination of cinnamic acid by Purkayastha and Ghosh.⁴¹

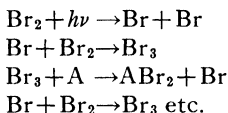

The atom chain of Berthoud and Beranek meets with two difficulties. The energy of activation required for a bromine atom to react with cinnamic acid, or for a free monobromo radical to react with a bromine molecule is so small that the temperature coefficient would be very small. The experiments, however, show that the thermal part of the reaction nearly triples for a ten degree rise. In the second place two atoms are produced by each photon and each of these atoms then leads to the addition of a molecule of bromine. When the long chains are eliminated by reducing the bromine concentration one might expect to find *two* molecules of bromine disappearing for each photon absorbed, instead of the *one* molecule actually found. Ogg⁴² has suggested however that this second objection can be met and that the atom mechanism can still give a quantum yield of one molecule per photon when the bromine concentration approaches zero because in the absence of bromine molecules the reaction



would predominate over the reaction

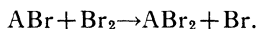

The triatomic bromine chain hypothesis seems unlikely from theoretical considerations. It is extremely difficult to decide by di-

⁴⁰ Berthoud and Beranek, *J. chim. phys.*, **24**, 213 (1927); *Helv. Chim. Acta*, **13**, 385 (1930).

⁴¹ Purkayastha and Ghosh, *Quart. J. Indian Chem. Soc.*, **2**, 261 (1926); **4**, 553 (1927).

⁴² Ogg, *J. Am. Chem. Soc.*, **58**, 607 (1936).

rect experiments between mechanisms which involve fleeting intermediates, like Br_3 , which have not been isolated nor detected by physical or chemical means. Quantum calculations described in Chapter IX can sometimes be used to great advantage in such cases. Sherman and Sun⁴³ showed that although Br_3 might be sufficiently stable to exist long enough to undergo many collisions it would nevertheless be less reactive toward a carbon-carbon double bond than the Br_2 . It seems to be a general principle that, other things being equal, the action involving the making and breaking of the least number of bonds has the least energy of activation, i.e., reacts the fastest. Since the addition of Br_2 to $>\text{C}=\text{C}<$ is faster than the addition of Br_3 the formation of an intermediate Br_3 does not seem to be a plausible explanation of the chain reaction. If this were the correct explanation the photochemical reaction should be slower than the dark reaction in which Br_2 is added to the double bond.

There is other evidence against the formation of atoms in the photobromination of cinnamic acid but it can not be regarded as conclusive. The absorption spectrum of gaseous bromine becomes continuous below 5,107 Å, indicating that below this limit there is dissociation into atoms while at longer wave lengths there is excitation of molecules but not dissociation. Experiments by Bauer showed that quantum yields at 5,460 and 5,790 Å were only slightly less than those at 4,360 Å where bromine atoms might be expected.

The conclusions regarding the absorption in the gas phase may not apply to bromine in carbon tetrachloride solution, but it is clear that there is no sharp difference in behavior in the different regions of the spectrum.

Also, the experiments on variation of light intensity seemed to argue against the importance of bromine atoms. Earlier workers had reported that the reaction rate varied with the square root of the light intensity—a fact which suggested the formation and reaction of bromine atoms. In this investigation, however, it was found that when precautions were taken to minimize concentration effects by working at low temperatures the rate was directly proportional to the light intensity, over the range studied. Secondary effects, however, might lead one to think that the reaction was not directly proportional to the light intensity. When the light is intense, the temperature high and the solution unstirred the bro-

⁴³ Sherman and Sun, *J. Am. Chem. Soc.*, **56**, 1096 (1934).

mine is depleted so rapidly that the concentration effect observed in Fig. 32 becomes a factor and the reaction velocity then does not increase at a rate proportional to the intensity of the light. It will increase at a lesser rate and under proper conditions it may happen to increase at a rate proportional to the square root of the intensity.

If these chemical chains involving Br or Br₃ were ruled out, one could consider an energy chain, in which the exothermic heat of reaction plus the energy of excitation is sufficient to produce the dibromide of cinnamic acid with a high energy content. The heat of bromination alone is estimated at 16,000 calories. These "hot molecules" of product then pass their energy over to more bromine atoms which then react to form additional dibromide, as follows,

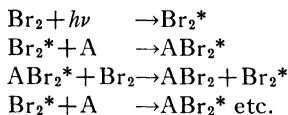

The asterisk indicates extra energy of excitation. This hypothesis of an energy chain demands that the transfer of energy from the excited molecules of product must be specific. The cinnamic acid dibromide must hold part of the energy of the radiation absorbed together with the heat of reaction until it collides with a bromine molecule. This specificity in the transfer of energy is not unusual; in fact it is quite common in experiments on the quenching of fluorescence. Since fluorescent materials are often found in solution it is possible to have excited molecules surrounded by solvent. Collision of excited dibromide molecules with solvent molecules of carbon tetrachloride are less effective in removing the energy but they do remove some as indicated by the fact that the chains are not of infinite length. In very dilute solution the chain is completely stopped, and on this hypothesis it is stopped because the many collisions with carbon tetrachloride have removed so much of the energy that there is not enough left for reaction when a bromine molecule is hit. The hypothesis of energy chains is not generally accepted now, perhaps because so many other reaction chains have proved to be chemical in nature rather than physical. In spite of their present unpopularity it may be necessary to consider energy chains in some reactions. They still find acceptance in the interpretation of certain explosive reactions.

The behavior of a photochemical chain reaction can sometimes be described rather simply in terms of the number of photons absorbed and the chain length. In the photobromination of cinnamic acid it is seen from Fig. 32 that the quantum yield Φ is nearly proportional to the concentration of bromine c_B in moles per liter. Then as an approximation

$$\Phi = 1 + M c_B$$

where M is a constant. If the number of chains, S , started per second is proportional to the light absorbed, $I_{\text{abs.}}$,

$$S = C I_{\text{abs.}} = C I_0 (1 - e^{-k l c_B})$$

where k and l are the constants in Beer's law and C is the number of chains started per photon absorbed, 1, 2, or 3 If Φ/C is the chain length, N the Avogadro number, V the volume of the solution in liters

$$\frac{-dc_B}{dt} = \Phi S / N V C.$$

Substituting the values of S and Φ

$$\frac{-dc_B}{dt} = \frac{I_0 (1 - e^{k l c_B}) (1 + M c_B)}{N V}.$$

In concentrated solutions where the absorption of light is nearly complete, $1 - e^{-k l c_B}$, reduces to 1, and integration for a given solution from zero time and the initial concentration c_B^0 gives

$$\frac{I_0 M}{N V} = k = \frac{2.303}{t} \log \frac{1 + M c_B^0}{1 + M c_B}.$$

Again, at the higher concentrations $1 + M c_B^0 / 1 + M c_B$ is practically equal to c_B^0 / c_B and the equation reduces to that for a first order reaction. In agreement with this equation it was found experimentally by direct application of Beer's law to the thermopile readings, that the photobromination of cinnamic acid at high concentrations and constant light intensity does follow a first order reaction. As is quite often the case, there is nothing of theoretical significance in the fact that the first order equation happens to apply.

Oxygen Effect. The reproducibility of the results seemed to argue against the presence of inhibitors, which are often capricious

in their behavior, but it was soon found⁴⁴ that the reaction is strongly inhibited by oxygen dissolved from the air. All investigators of this reaction have in fact been dealing with an oxygen-inhibited reaction. This oxygen effect was demonstrated most simply by filling one leg of an inverted U-tube with a carbon tetrachloride solution of cinnamic acid and the other with a carbon tetrachloride solution of bromine. The tube was evacuated with a water aspirator through a stopcock at the top. When the solutions were about half boiled away and the dissolved oxygen removed, the stopcock was closed, and the tube was tilted to mix the two solutions. The brown color of the bromine faded out entirely within a few minutes. When the oxygen is not boiled out in this way, many days are required for the bromine to disappear. The fading-out of the bromine was stopped immediately by opening the stop cock and admitting air.

These results are in agreement with the findings of Kharasch⁴⁵ that peroxides affect the addition of hydrobromic acid to the double bond, with those of Schultze⁴⁶ that the rate of bromination of cyclopentadiene is affected by oxygen, and with those of Dickinson and Leermakers⁴⁷ that oxygen inhibits the photochlorination of tetrachloroethylene. The removal of oxygen is necessary also in certain industrial processes⁴⁸ involving halogenations.

This effect of oxygen has been studied in considerable detail,⁴⁹ but it is not yet understood. Elaborate precautions were taken to remove all oxygen by repeatedly freezing, evacuating with a mercury vapor pump and thawing, until a small Tesla coil gave no indication of the oxygen discharge. Six or seven cycles of evacuations were necessary to remove the oxygen. The reaction was rapid in the absence of oxygen, particularly the photochemical reaction produced by the ordinary light of the laboratory. The mechanism of the inhibition is not yet clear. The formation of peroxide does not seem to be a very likely cause of the inhibition because evacuation at room temperature would hardly be sufficient to decompose or remove the peroxide. Additional experiments along this line would be desirable. In some way the oxygen seems to reduce the

⁴⁴ Bauer and Daniels, *J. Am. Chem. Soc.*, **56**, 2014 (1934).

⁴⁵ Kharasch and Mayo, *J. Am. Chem. Soc.*, **55**, 2468 (1933).

⁴⁶ Schultze, *J. Am. Chem. Soc.*, **56**, 1552 (1934).

⁴⁷ Dickinson and Leermakers, *J. Am. Chem. Soc.*, **54**, 3852 (1932).

⁴⁸ Deanesly, *J. Am. Chem. Soc.*, **56**, 2501 (1934).

⁴⁹ Willard and Daniels, *J. Am. Chem. Soc.*, **57**, 2240 (1935).

Sutherland, *Ph.D. Thesis*, University of Wisconsin, (1936).

length of the secondary chain reactions which follow the primary photochemical step. One can not be sure whether the thermal excitation (molecular collision) and photochemical excitation (collision with a photon) both give rise to the same mechanism but it is known that they are the same in many cases. Experiments on the bromination of cinnamic acid, crotonic acid and stilbene⁵⁰ in the dark proved that oxygen inhibits these brominations in the complete absence of light but the effect appears to be more pronounced when some light is involved.

THE PHOTOLYSIS OF BETA-CARYOPHYLLENE NITROSITE

The three examples of photochemical kinetics already discussed illustrate comparatively simple reactions; and yet their full interpretations are quite uncertain and controversial. Three additional examples of a more complicated nature will be discussed briefly.

β -Caryophyllene nitrosite is made from an extract of ginger and purified to give blue needle-like crystals.⁵¹ When dissolved it decomposes by absorption of light in a narrow band at 6,800 Å giving nitrogen gas and a colorless solution. It is decomposed also by heating to about 100°. Its exact structure is unknown.

Two facts are useful in understanding the reaction⁵²—the quantum yield for the nitrogen evolved and the quantum yield for the nitrosite decomposed. A thermostated micro gas buret was attached directly to the cell and the volume of nitrogen was measured to 0.001 cc. by weighing the displaced mercury. Nitrobenzene was used as the solvent on account of its low vapor pressure. A small monochromator was used either with a zinc or cadmium arc or with a tungsten lamp. The thermopile readings were used for determining both the number of quanta absorbed and the number of molecules reacting.

The absorption of light does not follow Beer's law exactly. The logarithm of the transmission is then plotted against solutions of different concentration and the unknown concentration is obtained from the thermopile reading by interpolation on this curve. Average absorptions over long time intervals cannot be used for accurate work under these conditions. A satisfactory method for calculating quantum yields from thermopile readings alone was

⁵⁰ Fortney, *M.S. Thesis*, University of Wisconsin (1936).

⁵¹ Kremers, *Pharm. Arch.* **2**, 273 (1899).

⁵² Hoffman, *J. Am. Chem. Soc.*, **56**, 1894 (1934).

developed which is not dependent on Beer's law. Readings were taken at frequent intervals during the several hours of exposure to the light. The measurements for one experiment are shown graphically in Fig. 34 where the energy absorbed is plotted along the horizontal axis—as calculated by summing up the product of the incident light intensity I_0 the average absorption A and the time increment in minutes. The data are given in galvanometer deflections but they are easily converted into quantum yields by applying a conversion factor. The concentrations are obtained from the ordinates.

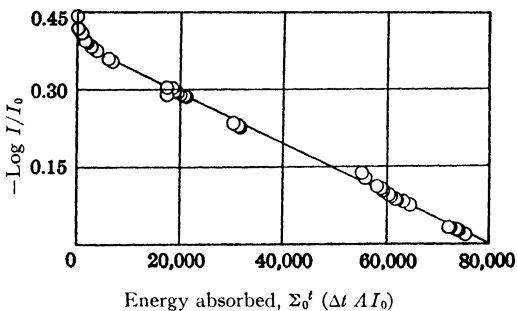
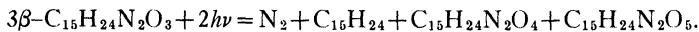

FIG. 34.—Quantum yield in the photolysis of beta-caryophyllene nitrosite.

Dissolved oxygen from the air was found to play an important part in this reaction as in many others, but its effect was eliminated by ignoring the first part of the reaction and starting the quantitative calculations after the oxygen had been consumed. It was found that 1.46 molecules of the nitrosite were decomposed and 0.46 molecule of nitrogen was produced (after correcting for fifteen per cent nitrogen trioxide) for each photon absorbed. The ratio of the two is one to three. The over-all reaction then appears to be an auto-oxidation as follows,



A termolecular collision involving two activated molecules and one normal molecule is very improbable and the following steps were offered as best describing the mechanism of the decomposition.

- (1) $\beta\text{-C}_{15}\text{H}_{24}\text{N}_2\text{O}_3 + h\nu \rightarrow \beta\text{-C}_{15}\text{H}_{24}\text{N}_2\text{O}_3^*$
- (2a) $\beta\text{-C}_{15}\text{H}_{24}\text{N}_2\text{O}_3^* \rightarrow \text{C}_{15}\text{H}_{24} + \text{N}_2\text{O}_3$
- (2b) $\beta\text{-C}_{15}\text{H}_{24}\text{N}_2\text{O}_3 \rightarrow \Delta\text{-C}_{15}\text{H}_{24}\text{N}_2\text{O}_3$
- (3) $2\Delta\text{-C}_{15}\text{H}_{24}\text{N}_2\text{O}_3 \rightarrow (\text{C}_{15}\text{H}_{24}\text{N}_2\text{O}_3)_2$
- (4) $(\text{C}_{15}\text{H}_{24}\text{N}_2\text{O}_3)_2 + \beta\text{-C}_{15}\text{H}_{24}\text{N}_2\text{O}_3 \rightarrow \text{N}_2 + \text{C}_{15}\text{H}_{24} + \text{C}_{15}\text{H}_{24}\text{N}_2\text{O}_4 + \text{C}_{15}\text{H}_{24}\text{N}_2\text{O}_5$

Since most nitrosites, and in fact liquid N_2O_3 , show the characteristic blue color with absorption at $6,800 \text{ \AA}$, the N_2O_3 group must absorb the energy. The asterisk * indicates an activated molecule. The N_2O_3 is then removed as in (2a) (giving rise to some free nitrogen oxides), or shifted as in (2b) forming an isomer designated here as the delta modification.⁵³ This step may involve the temporary removal of N_2O_3 , as in (2a), followed by rearrangement and combination. This isomerization permits the formation of the bimolecular compound as in (3). The final step (4) yields nitrogen, caryophyllene and the two nitrosates containing N_2O_4 and N_2O_5 . There is chemical evidence for the formation of the nitrosates.

These four steps are sufficient to explain all the observed facts and the author was not able to invent any other set of reactions which would be in agreement with all the experimental facts. Of course this four-step mechanism cannot be regarded as proved but it seems the most plausible at present and any other mechanism proposed on the basis of new chemical facts must satisfy the requirements of quantum yields given here.

THE FORMATION OF VITAMIN D

Vitamin D prevents rickets and its production by the action of ultraviolet light on the animal or its food is well known. The active substance which is changed over to vitamin D was traced to cholesterol and then to ergosterol. In the early days following the discovery of the effect of ultraviolet light in preventing rickets it was thought by some that the light itself exerted a direct and rather mysterious healing effect.

The effect is due merely to the photochemical production of a specific substance and before its chemical nature was established and before it was isolated, the direct application of photochemical

⁵³ The beta modification corresponds to an isomer defined by Deussen, *J. prakt. Chem.*, **114**, 75 (1926).

principles and experimental measurements permitted a prediction of the necessary dosage of pure vitamin.⁵⁴ Cholesterol was irradiated with a monochromator for varying lengths of time and the various samples were fed to rats which were kept on a rachitic diet. Using the standard silver nitrate line test for calcium deposition in the bones it was found that 230 ergs was the minimum amount of ultraviolet radiation necessary to prevent rickets in a rat. A little later using ergosterol instead of cholesterol and adopting a different standard for the animal test a value of 700 to 1,000 ergs was obtained.⁵⁵ Still later another thorough investigation making use of X-ray tests on the animals led to a value of 2,000 ergs as a minimum for healing.⁵⁶

All these results are in good agreement considering the difficulty of comparing different tests on animals. Converting the radiation energy to quanta and assuming that each absorbed quantum produced one molecule of vitamin D, the number of molecules of vitamin was easily calculated. Assuming next that the molecular weight of vitamin D is the same as that of ergosterol it was calculated that the 1,000 ergs corresponded to 8×10^{-8} gram of vitamin D. This is the dosage of vitamin D that theoretical photochemistry predicted would be necessary to prevent rickets in a rat if and when the pure vitamin should be isolated. Over a year after this prediction, Bourdillion and Webster⁵⁷ isolated pure vitamin D, and by direct weighing found that 5×10^{-8} gram was the minimum dosage. The agreement is excellent and the investigation illustrates the value of the application of chemical kinetics. More recent tests give for the pure vitamin D, calciferol, a potency of 40 million international units per gram, a value which is equivalent to 2.5×10^{-8} gram.

The chemical change which takes place in the irradiation of the complex sterols has been very well worked out, chiefly by Windaus.

Ergosterol is converted into vitamin D (calciferol) by cutting the second ring between two carbon atoms and forming a methylene group as follows:

⁵⁴ Fosbinder, Daniels and Steenbock, *J. Am. Chem. Soc.*, **50**, 923 (1928).

⁵⁵ Kon, Daniels and Steenbock, *J. Am. Chem. Soc.*, **50**, 2573 (1928).

⁵⁶ Marshall and Knudson, *J. Am. Chem. Soc.*, **52**, 2304 (1930).

⁵⁷ Bourdillion and Webster, *Proc. Roy. Soc.*, **104B**, 561 (1929).

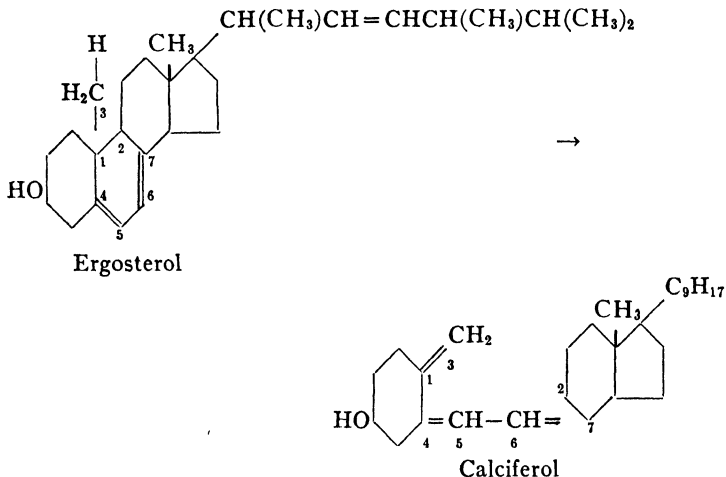

Ergosterol contains three double bonds and four rings whereas vitamin D contains four double bonds and three rings.

The fundamental change is

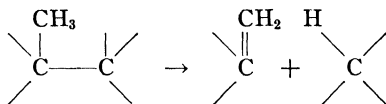

and the heat of the reaction is the difference between the heat absorbed in breaking the C-C bond (77,000) and the heat evolved in changing a single carbon-carbon bond into a double bond (45,000 cal.). The net effect is the absorption of 32,000 calories, neglecting effects of resonance and steric repulsion which in this case remain nearly unchanged. The energy of activation then must be at least as great as 32,000 calories and it may be much more. Thermochemistry can not give any more information. Quantum calculations as described in a later lecture would permit an estimate of the energy of activation. It is known that the ultraviolet light must be below about 3,000 Å in order to be effective. This radiation is equivalent to 95,000 calories per mole, and it is to be expected that the energy of activation must be of this order of magnitude.⁵⁸

⁵⁸ Calculated by Owen and Sherman, *J. Am. Chem. Soc.*, **59**, 763 (1937).

It is possible, however, that the energy of activation may be less than this, and that light of longer wave length would be effective if it could only be absorbed in the right place in the molecule. Perhaps there is no absorbing group to take up quanta of lesser energy or if present perhaps it is not situated in a part of the molecule from which it can transfer the energy effectively to the bond which must be broken in order to give vitamin D.

PHOTOSYNTHESIS BY CHLOROPHYLL

The most important reaction in the world is the oxidation of carbon and the next most important one is the reaction by which carbon compounds are produced in growing plants from carbon dioxide by sunlight in the presence of green chlorophyll.

The reaction is

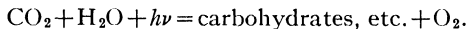

Considering the enormous investments which have been made in agricultural research it seems strange that this most fundamental reaction underlying all agriculture has received so little attention. Warburg's⁵⁹ classical determination of the quantum yield has been universally accepted for many years. It seemed desirable to determine directly the number of molecules of carbon dioxide consumed and the number of molecules of oxygen evolved for each photon absorbed, using the new developments in photochemical technique and extending the measurements over a wide range of experimental conditions. This reaction is unique among photochemical reactions. Only in short ultraviolet light would one expect the photons to be sufficiently powerful to cause the direct union of carbon dioxide and water. However, the living cell *does* use visible light, and the manner in which it is able to utilize these photons of lesser energy is a matter of great interest.

If the reaction is reversed and the carbohydrate is burnt to give carbon dioxide and water 112,000 calories of heat is evolved for each mole of carbon dioxide. Therefore, the union of carbon dioxide and water to give a carbohydrate and oxygen must absorb 112,000 calories. Since the energy of activation of an endothermic reaction must be at least as great as the heat absorbed,⁶⁰ it is evident that at least 112,000 calories per mole must be supplied—and perhaps much more than this. Ultraviolet radiation below 2,400 Å

⁵⁹ Warburg and Negelein, *Z. physik Chem.*, **106**, 191 (1923).

⁶⁰ Page 17.

is necessary to give radiation of this energy intensity.⁶¹ However, all life processes depend on the fact that visible light from the sun, which contains only 40,000 to 70,000 calories per mole, does produce this reaction in the presence of chlorophyll. Plants will grow well in red light of only 40,000 calories and in some way then the chlorophyll is able to absorb three or more of these photons and combine their energy to give energy intensity of 112,000 calories per mole. The chance of a quintuple collision between two molecules (H_2O and CO_2) and three photons is negligible. Other cases where low grade energy is converted into such high grade energy are unknown; this chlorophyll reaction is unique. To find the photochemical mechanism is an interesting challenge.

The measurement of the actual number of molecules reacting per photon absorbed seems to be the most important thing to determine. Warburg⁶² found a quantum yield of 0.25 to 0.35 molecule per quantum with green algae, using a differential manometer which measured the oxygen evolved. This value agrees with the maximum theoretical efficiency and it has been universally accepted. It has been the basis of many calculations and hypotheses. Four photons of red light of 35,000 calories each will give 140,000 calories, provided they can be added together, and this quantity is sufficient to supply the 112,000 calories which is a lower limit to the amount that may be required.

After an investigation of several years with the same type of algae and approximately the same intensity of monochromatic light as used by Warburg we are forced to conclude that the photosynthetic process is considerably less efficient than the 0.2 or 0.3 which is now accepted.⁶³ With the monochromator already described and with direct, microchemical analysis of the gas or by titration for oxygen we find a quantum yield of about 0.05 changing somewhat with the conditions. Under our conditions ten to twenty quanta instead of the classical four seem to be necessary to convert one molecule of carbon dioxide into plant material.

Many factors are involved in this complex reaction. Secondary thermal reactions follow the primary photo process and these are subject to temperature effects. At high intensities the reaction may be so rapid that diffusion of materials through the cell wall becomes a limiting factor and the quantum efficiency of the proc-

⁶¹ Table I, page 122.

⁶² Warburg and Negelein, *Z. physik. Chem.*, **102**, 236 (1922); **106**, 191 (1923).

⁶³ Manning, Stauffer, Duggar and Daniels, *J. Am. Chem. Soc.*, **60**, 266 (1938).

ess decreases. Significant measurements, then, should be made at lesser intensities, in the so-called Blackman region where the rate of photosynthesis is directly proportional to the light intensity—i.e., the quantum yield is independent of intensity. Other pigments in addition to chlorophyll are present and a correction for their absorption must be made. The correction is not large in the case of the algae.

Algae seem to offer better opportunities for study than land plants because of their simpler structure and intimate thermal contact with a large excess of water. The matter of respiration is troublesome, for, in the dark, the living cells consume oxygen and liberate carbon dioxide in direct opposition to the photosynthetic reaction. It has been assumed that respiration is the same in the light as in the dark, but this assumption is of doubtful validity. Further investigation of respiration is necessary.

A known mixture of nitrogen, oxygen and carbon dioxide was bubbled through a suspension of alga cells contained in a small illuminated quartz cell. The amount of oxygen and carbon dioxide in the exit gas was determined to 0.001 cc. The composition was determined while the cells were illuminated and again while they were in the dark and the difference was taken as a measure of the amount of photosynthesis. A large, calibrated thermopile at the rear of the cell gave a measurement of the transmitted light and the number of quanta absorbed was easily calculated. The quantum yields are not easily reproducible and they appear to depend on the illumination and previous history of the algae.

Several interesting hypotheses have been proposed to account for this important photosynthetic reaction which utilizes several photons of low-grade energy to effect a reaction requiring high-grade energy. Multiple collisions are ruled out on the basis of probability. Long-lived collectors of energy have been proposed, but they are very improbable. For example, since oxygen is known to quench the fluorescence of chlorophyll and since it can be put into a metastable state which holds its activation energy for comparatively long periods of time, it has been suggested that oxygen may be able to store up four or more quanta of energy in one molecule and release the full amount at once to effect the reaction. This hypothesis is unlikely because, although the metastable state is known in gases, it probably would not last as long in solution. Moreover, if one absorbed quantum put the molecule into this excited state later additions of energy would take it out again.

According to one of the best hypotheses there are several chemical reactions involved and each one involves the absorption of a quantum of radiation. The over-all reaction then is able to utilize several photons by absorbing one into each of its several intermediate steps. There is nothing wrong with this hypothesis but a very complicated mechanism is necessary to provide individual steps for the absorption of so many photons. Several different experimental facts are known and any complete hypothesis must explain most of these facts and conflict with none. They include, among other things, the quantum yield, the effect of light intensity, the effect of intermittent light, the behavior with poisons, the existence of fluorescence, the influence of temperature, and the known structure and chemical reactions of chlorophyll. Most of the partly plausible hypotheses involve various types of acceptors and a loose compound formed between carbon dioxide and chlorophyll. The existence of peroxides seems a rather likely intermediate step.

Burk⁶⁴ has proposed a detailed mechanism together with a statement of the facts which must be explained by a satisfactory hypothesis. Franck⁶⁵ has given valuable suggestions from the viewpoint of the physicist, based on four steps involving OH and H groups attached to the chlorophyll.

The requirement of four photons per molecule is assumed in this hypothesis and in most other hypotheses, but, as already stated, the energy requirements are much greater than four—probably about twenty. It is possible, of course, that the energy of these extra photons is consumed in some side reaction not involved in the main reaction.

However this new realization of the lesser efficiency of the photosynthetic process in living plants opens up new possibilities of explanation. Hypotheses need no longer be handicapped by this high efficiency requirement. It is now worth while to examine the possibility that in a very complex molecule of special structure many photons may be absorbed, and, in the resulting rearrangements, the energy equivalent of four photons may be delivered in one unit at a particular part of the molecule to produce the photosynthetic union of carbon dioxide and water.

Additional exact experimental facts are needed over a wide range of conditions before the true mechanism of plant photosyn-

⁶⁴ Burk and Lineweaver, *Nature*, **135**, 621 (1935).

⁶⁵ Franck, *Chem. Rev.*, **17**, 433 (1935).

thesis can be established, and, although the problem is necessarily very complicated, there is no reason to doubt its ultimate solution. In fact no theoretical reason is now known to prevent photosynthesis "in vitro," but no such case of photosynthesis has yet been established. Moreover, there is no *a priori* reason why it may not be possible to find a more efficient catalyst for the reaction than chlorophyll.

LITERATURE

A few additional examples of simple, quantitatively-studied photochemical reactions are listed below.

Φ = approximate quantum yield.

λ = wave length in Ångstrom units.

t = temperature in Centigrade degrees.

References are usually given only to the latest investigator. Experimental procedure, influence of various factors, and mechanisms are given in the references.

Acetaldehyde decomposition and polymerization.

$\lambda = 2537$ and 3130 ; $\Phi_{\text{decomp.}} = 1$ and 0.5 .

Polymerization accompanies reaction.

Leighton and Blacet, *J. Am. Chem. Soc.*, **55**, 1766 (1933).

$t = 310^\circ$; $\lambda = 3130$; $\Phi = 300$.

Leermakers, *J. Am. Chem. Soc.*, **56**, 1537 (1934).

Acetone decomposition, page 147.

Acetylene polymerization.

$\lambda = 2054 - 2033$; $\Phi = 7$.

Lind and Livingston, *J. Am. Chem. Soc.*, **54**, 94 (1932).

Mercury sensitized. $\lambda = 2536$; $\Phi = 6.5$ for C_2H_2 and 5 for C_2D_2 .

Jungers and Taylor, *J. Chem. Phys.*, **3**, 338 (1935).

Acraldehyde decomposition and polymerization.

$\lambda = 3135$ and 3665 ; $\Phi_{\text{decomp.}} = 0.15$ and 0.01 ; $\Phi_{\text{polym.}} = 2.3$ and 0.4 .

Thompson and Linnett, *J. Chem. Soc.*, 1452 (1935).

Ammonia decomposition $\text{NH}_3 = 1/2 \text{N}_2 + 3/2 \text{H}_2$.

$\lambda < 2000$. $t = 20$, $\Phi = 0.14$; $t = 400^\circ$, $\Phi = 0.6$.

Ogg, Leighton and Bergstrom, *J. Am. Chem. Soc.*, **56**, 318 (1934).

Farkas and Harteck, *Z. physik. Chem.*, **B25**, 257 (1934).

Kistiakowsky and Wiig, *J. Am. Chem. Soc.*, **54**, 1806 (1932).

Wig, *J. Am. Chem. Soc.* **57**, 1559 (1935).

Arsine decomposition.

$\lambda = 2537$. Mercury sensitized. $\Phi = 1$.

Simmons and Beckman, *J. Am. Chem. Soc.*, **58**, 454 (1936).

Anthracene polymerization. $2C_{14}H_{10} \rightleftharpoons (C_{14}H_{10})_2$

Solution in benzene. Reaction reverses in dark. $\Phi \approx 1$.

Weigert, *Naturwiss.*, **15**, 124 (1927).

Azomethane decomposition.

$\lambda = 2080 - 3660$; $t = 20 - 226^\circ$; $\Phi \approx 1$.

Forbes, Heidt and Sickman, *J. Am. Chem. Soc.*, **57**, 1935 (1935).

Acetylene dichloride, bromination of

Reaction is faster in gas phase than in solution. $\lambda = 4060 - 5460$;
 $\Phi \sim 100$.

Ghosh, Bhattacharyya and Bhattacharyya, *Z. physik. Chem.*,
B32, 145 (1936).

Bromination of cinnamic acid. Page 157.

Bromination of hydrogen. $Br_2 + H_2 = 2HBr$.

$t < 150$; $\Phi = 0$. $t > 150^\circ$; Φ is large depending on several factors
which have been quantitatively studied.

Bodenstein and Lütkemeyer, *Z. physik. Chem.*, **114**, 208 (1925).

Bromination of tetrachloroethylene. $Br_2 + C_2Cl_4 = C_2Br_2Cl_4$.

$\lambda = 4360$; $\Phi = 0.1$ to 24 depending on concentration of products
and presence of oxygen. Chains are involved both in forma-
tion and decomposition of $C_2Br_2Cl_4$.

Willard and Daniels, *J. Am. Chem. Soc.*, **57**, 2240 (1935).

Carrico and Dickinson, *J. Am. Chem. Soc.* **57**, 1343 (1935).

Chlorination of hydrogen. $Cl_2 + H_2 = 2HCl$.

$\lambda =$ visible and ultraviolet light. $\Phi \approx 100,000$.

Studied by many different workers. Many factors are involved.

Ritchie and Norrish, *Proc. Roy. Soc. London*, **140A**, 99
(1933).

Potts and Rollefson, *J. Am. Chem. Soc.*, **57**, 1027 (1935).

Chlorination of pentane.

$\lambda = 3650$; $\Phi = 192 \pm 14$. Oxygen removed.

Stewart and Wiedenbaum, *J. Am. Chem. Soc.*, **57**, 1702 (1935).

Chlorination of tetrachloroethylene.

$\lambda = 4358$; $\Phi = 300 - 500$ in gas phase and in solution.

Greatly affected by oxygen.

Dickinson and Carrico, *J. Am. Chem. Soc.*, **56**, 1473 (1934).

Chlorination of trichloro-bromomethane. $Cl_2 + 2CCl_3Br \rightarrow 2CCl_4$
 $+ Br_2$.

$$\lambda = 3660. \Phi_{\text{gas}} \sim 30$$

Vesper and Rollefson, *J. Am. Chem. Soc.*, **56**, 1455 (1934).

Chlorine dioxide decomposition.

$$\lambda = 3660 \text{ and } 4360; \Phi = 3.7 \text{ and } 3.1.$$

Spinks and Porter, *J. Am. Chem. Soc.*, **56**, 264 (1934).

Crotonaldehyde decomposition.

$$\lambda = 2399 - 3600; \Phi < 0.02.$$

Blacet and Roof, *J. Am. Chem. Soc.*, **58**, 73 (1936).

Diazomethane decomposition. $\text{CH}_2\text{N}_2 \rightarrow \text{CH}_2 + \text{N}_2$ (primary step).

$$\lambda = 3660 \text{ and } 4360; \Phi \sim 4.$$

Kirkbride and Norrish, *J. Chem. Soc.*, 119 (1933).

Ethyl iodide decomposition.

$$\lambda = 2026; \Phi_{\text{gas}} = 0.03 - 0.1; \Phi_{\text{liquid}} = 0.24.$$

West and Ginsburg, *J. Am. Chem. Soc.*, **56**, 2626 (1934).

$$\lambda = 2537 \text{ and } 3130; t = 5^\circ - 58^\circ; \Phi_{\text{liquid}} = 0.41 \text{ and } 0.31.$$

Norton, *J. Am. Chem. Soc.*, **56**, 2294 (1934).

Ethylene iodide decomposition.

$$\lambda = 3030 \text{ and } 3130; \Phi = 0.76. \text{ Secondary thermal reactions exist.}$$

De Right and Wiig, *J. Am. Chem. Soc.*, **57**, 2411 (1935).

Formaldehyde decomposition. $\text{HCHO} \rightarrow \text{H}_2 + \text{CO}$.

$$\lambda = 3660; \Phi = 0.7 \text{ to } 0.9.$$

Norrish and Kirkbride, *J. Chem. Soc.*, 1518 (1932).

Formic acid decomposition.

$$\lambda = 1900 - 2540; \Phi = 1.$$

Double molecules give $\text{CO}_2 + \text{H}_2$; single molecules give also CO and H_2O .

Gorin and Taylor, *J. Am. Chem. Soc.*, **56**, 2042 (1934).

Hydrogen azide decomposition. Sensitized by mercury.

Products are H_2 , N_2 , NH_3 , NH_4N_3 .

$$\lambda = 2537; \Phi = 2.86 \text{ for formation of } \text{NH}_3.$$

Meyers and Beckman, *J. Am. Chem. Soc.*, **57**, 89 (1935).

Hydrogen peroxide. $2\text{H}_2\text{O}_2 \rightarrow 2\text{H}_2\text{O} + \text{O}_2$.

$$\lambda = 3130; \Phi = 4 \text{ to } 100. \text{ Affected by } pH.$$

Under special conditions Φ approaches 1.

Allmand and Style, *J. Chem. Soc.*, 596 (1930).

Heidt, *J. Am. Chem. Soc.*, **54**, 2840 (1932).

Hydrogen iodide decomposition. $2\text{HI} \rightarrow \text{H}_2 + \text{I}_2$.

$$\lambda = 2070 - 2820; \Phi = 2. \text{ Gas, liquid or solution.}$$

One of the simplest photochemical reactions known.

B. Lewis, *J. Phys. Chem.*, **32**, 270 (1928).

Bodenstein and Lieneweg, *Z. physik. Chem.*, **119**, 123 (1926).

Warburg, and Rump, *Z. Physik*, **47**, 305 (1928).

Hydrogen sulfide. $\text{H}_2\text{S} = \text{H}_2 + \text{S}$

$\lambda = 2050$; $p = 250$ mm. $\Phi = 2$.

At higher pressures $\Phi = 3.8$.

Stein, *Trans. Faraday Soc.*, **29**, 581 (1933).

Iodine and Ferrous Ion. $2\text{Fe}^{++} + \text{I}_3^- = 2\text{Fe}^{+++} + 3\text{I}^-$.

$\lambda = 3660-5790$; $\Phi = 1$.

Kistiakowsky, *J. Am. Chem. Soc.*, **49**, 976 (1927).

Iodoform decomposition.

Benzene solution. $\lambda = 3130$ and 3650 ; $\Phi = 1$.

Φ increased in presence of oxygen.

Gibson and Iredale, *Trans. Faraday Soc.*, **32**, 571 (1936).

Ketene decomposition. $\text{CH}_2\text{CO} = (\text{C}_2\text{H}_4 + \text{CO})$.

$\lambda = 3130$; $\Phi = 1$. $\lambda = 3650$; $\Phi = 0.4$.

Ross and Kistiakowsky, *J. Am. Chem. Soc.*, **56**, 1112 (1934).

Lead tetramethyl decomposition. $\text{Pb}(\text{CH}_3)_4 = \text{Pb} + \text{hydrocarbons}$.

$= 2536$; $\Phi = 1.1$. In trimethyl pentane solution $\Phi = 0.39$.

Measurements were made with radioactive lead.

Methyl radicals were produced.

Leighton and Mortensen, *J. Am. Chem. Soc.*, **58**, 448 (1936).

Malachite green leucocyanide.

Alcoholic solution. $\lambda = 2480-3340$ gives colored product which is determined by colorimeter. $\Phi = 1.04-0.99$ depending on λ .

Sufficiently accurate to be used for precision actinometer and test of Einstein relation in the primary process.

Harris and Kamisky, *J. Am. Chem. Soc.*, **57**, 1154 (1935).

Methyl butyl ketone decomposition.

$\lambda = 2480-2770$; $\Phi_{\text{decomp.}} = 0.27$; $\Phi_{\text{polym.}} = 0.03$.

Bloch and Norrish, *J. Chem. Soc.*, 1638 (1935).

Monochloroacetic acid hydrolysis.

$\text{CH}_2\text{ClCOOH} + \text{H}_2\text{O} = \text{HOCH}_2\text{COOH} + \text{H}^+ + \text{Cl}^-$.

Aqueous solution. Affected by $p\text{H}$.

$\lambda = 2536$; $\Phi \sim 1$.

Rudberg, *Z. physik. Chem.*, **24**, 247 (1924).

Nitrogen oxides. NO_2 ; N_2O_4 ; N_2O_5 . Page 137.

Nitrate ion decomposition. $2\text{NO}_3^- = 2\text{NO}_2^- + \text{O}_2$

$p\text{H} = 10$, $\lambda = 2536$, $\Phi = 0.3$. $\lambda = 3130$, $\Phi = 0.01$. $p\text{H} = 6$, $\lambda = 2536$, $\Phi = 0.05$.

Villars, *J. Am. Chem. Soc.*, **49**, 326 (1927).

Nitroso isopropyl acetone decomposition.

$\lambda \sim 6850$; $\Phi \sim 1$.

Anderson, Crumpler and Hammick, *J. Chem. Soc.*, 1679 (1935).

Nitrosyl chloride decomposition. $\text{NOCl} = \text{NO} + 1/2 \text{Cl}_2$.

$\lambda = 3660-6300$; $\Phi = 2$.

Kistiakowsky, *J. Am. Chem. Soc.*, **52**, 102 (1930).

Ortho-nitrobenzaldehyde isomerization.

$\lambda = 3130-4360$; $\Phi = 0.5$. Solid and in acetone solution.

Leighton and Lucy, *J. Chem. Phys.*, **2**, 756 (1934).

$t = 90^\circ$; $\Phi = 0.75$.

Küchler and Patat, *Z. Elektrochem.*, **42**, 529 (1936).

Oxalic acid decomposition. $\text{H}_2\text{C}_2\text{O}_4 + (\text{UO}_2^{++}) \rightarrow \text{H}_2\text{O} + \text{CO} + \text{CO}_2 + (\text{UO}_2^{++})$.

Aqueous solution sensitized by uranyl ion.

$\lambda = 2550$; $\Phi = 0.60$. $\lambda = 3130$; $\Phi = 0.56$. $\lambda = 3660$; $\Phi = 0.49$.

$\lambda = 4350$; $\Phi = 0.58$.

This photochemical reaction has been measured with the greatest care and is used as a standard in actinometry.

Leighton and Forbes, *J. Am. Chem. Soc.*, **52**, 3139 (1930).

Oxalyl chloride decomposition. $(\text{COCl})_2 = \text{COCl}_2 + \text{CO}$.

$\lambda = 2537$; $\Phi = 0.8$. $\lambda = 3650$; $\Phi = 1.8$.

Krauskopf and Rollefson, *J. Am. Chem. Soc.*, **58**, 443 (1936).

Ozone formation. $3\text{O}_2 = 2\text{O}_3$.

$\lambda < 2000$; $\Phi = 1.3$ to 2.0 depending on pressure.

Warburg, *Z. Elektrochem.*, **27**, 133 (1921).

Ozone decomposition. $2\text{O}_3 = 3\text{O}_2$.

$\lambda = 2080-3130$; $\Phi > 4$.

Heidt, *J. Am. Chem. Soc.*, **57**, 1710 (1935).

$\lambda = 2300-2800$; $\Phi = 3.5$.

Schumacher and Beretta, *Z. physik. Chem.*, **17B**, 417 (1932).

Persulfate ion decomposition. $\text{S}_2\text{O}_8^{--} + \text{H}_2\text{O} = 2\text{SO}_4^{--} + 2\text{H}^+ + 1/2 \text{O}_2$.

$\lambda = 2536$ and 3020; $\Phi = 1$. Aqueous solution.

Crist, *J. Am. Chem. Soc.*, **54**, 3939 (1932).

Phosphine decomposition.

$\lambda < 2300$; $t = 25-300^\circ$; $\Phi \sim 5$.

Melville, *Proc. Roy. Soc. London*, **A139**, 541 (1933).

Stilbene transformation. (trans \rightarrow cis).

$\lambda = 1930-3130$; $\Phi = 0.36-1.0$. Hexane solution.

Smakula, *Z. physik. Chem.*, **B25**, 90 (1934).

CHAPTER VII

ELECTRICAL ACTIVATION

WE HAVE seen that molecules must be activated before they can react and that in thermal reactions they are activated by collisions with high-velocity molecules, while in photochemical reactions they are activated through displacement of the outer electrons produced by the absorption of light. Molecules in the gas phase may be activated also by electronic displacement caused by collisions with electrons or ions. This activation may be brought about directly by cathode rays, by electrical discharges of various types, or indirectly by alpha rays and X-rays, which seem to be effective chiefly through the secondary electrons and ions which they produce.

In view of the enormous amount of electrical energy which is potentially available, it seems strange that more attention has not been paid to fundamental work on the nature of chemical activation by electrons and ions. Such research might lead, ultimately, to applications of practical value.

Any of these agencies which produce chemical action through electronic or ionic bombardment provide energy of very high intensity, much greater than is available in ordinary thermal reactions or even in ultraviolet radiation. Drastic chemical changes are theoretically possible, but actually the high grade energy is dissipated into energy units of lower intensity so that the products of these reactions are usually quite like those of ordinary thermal or photochemical reactions. For example, X-rays of 1 Å have quanta corresponding to 200 million calories per mole but they produce chemical reaction chiefly through the large number of secondary electrons and ions which they leave in their path. These units produce ordinary chemical changes requiring energies from a few kilocalories up to 100,000 or more.

The relation between electron velocity and frequency of radiation in experiments involving the emission or absorption of light is given by the fundamental relation

$$V'e = h\nu$$

where V' is the voltage drop and e is the charge of the electron, both being expressed in the proper units. If V is given in ordinary (international) volts a conversion factor (300) is necessary. Expressing the light in terms of Ångstrom units, it can be shown that one international electron volt is equivalent to 12,336 Å and that the wave length corresponding to any voltage is obtained by dividing the voltage into 12,336. The electron volts corresponding to radiation of different wave lengths as calculated from this formula are given in the last column of Table I on page 122. Spectroscopists now often speak in terms of electron volts instead of Ångstrom units. An examination of this table shows that low voltages, from 0.5 to 5 volts, cover the whole range of energies of activation for ordinary chemical reactions. Voltages very much greater than these are available in any kind of electrical discharge, and in all X-rays.

ELECTRICAL DISCHARGES IN GASES

When a large difference in potential is applied to two insulated electrodes in a vessel containing gas at a few millimeters pressure, an electrical discharge may take place. A few ions, produced from traces of radioactive materials or from cosmic rays, are always present even before a potential is applied. When the electrodes become charged by connection to a high-voltage transformer, battery, or dynamo, the ions are attracted toward the electrode of opposite charge. As they travel across the chamber they acquire greater velocities and are soon able to produce more ions by colliding with other molecules in their paths. Electrons can ionize molecules after they reach velocities corresponding to the order of fifteen electron volts, while positive ions require around 300 electron-volts in order to produce ionization. These new ions in turn are drawn to the electrodes producing more ions as they go. The process is cumulative and if the voltage is high enough and the pressure right, a violent spark may jump between the electrodes. This process finds common illustration in the phenomenon of lightning. Many different forms of discharge can be produced—corona, brush, spark, arc, etc. depending on voltage, frequency, gas

pressure, and the shape of the electrodes. Points give a high potential gradient and tend to give streamers rather than the explosive spark. If a discharge is started or if the electrodes are touched and then separated, the electrodes may become so hot that they volatilize and the material of the arc itself (carbon or iron, for example) carries the current. These currents in the arc may be very large.

Under high vacuum there are not enough ions to carry the current and maintain a discharge, while at high pressures the mean free path is so short that the ions do not have time to develop kinetic energy sufficient to ionize the molecules with which they collide. Accordingly, there is a maximum current through the discharge chamber at pressures in the neighborhood of a few millimeters. Electrical discharges of this type with direct current from induction coils, high voltage dynamos, batteries, or from rectified alternating current, have a bright negative glow and a positive column which is sometimes striated. The emission of light is due to the recombination of electrons and ions which are produced in the discharge. The colors emitted depend on the gas present. Dark spaces are sometimes found between the electrodes where the electrons have not acquired sufficient energy to ionize other molecules.

Alternating current gives a more uniform type of discharge. By interposing dielectrics or by going to very high frequencies and applying high voltages a discharge can be operated at atmospheric pressures. The most common example of this type of discharge is found in the ordinary ozonizer. Two concentric glass tubes are provided with an outer and inner electrode of metal foil or conducting liquid and the air or oxygen is passed between the two.

The electrolysis of gases is much more complicated than the electrolysis of electrolytes in solution. In the latter case Faraday's law applies with exactness, one univalent ion reacting for each electron passing through the electrical circuit connected to the electrodes. The situation is simple because the only chemical reaction involved is that which takes place at the electrodes and all the electrons are measured by the ammeter in the circuit. In the electrolysis of gases, however, there is usually no simple relation between the current and the amount of chemical reaction because most of the reaction takes place out in the body of the discharge away from the electrodes. Many of the ions and electrons involved in the reaction recombine and never reach the electrodes. The

energy input in calories or in kilowatt hours is a more significant quantity in considering chemical yields than is the current which passes around the external circuit. The current measures only the number of ions which happen to reach the electrodes before being neutralized. There is then no Faraday's law for gases except under special cases, as, for example, at very low pressures, when the electrodes are close together. Moreover, there is no uniformity of ion charges and no relation to the valencies of the molecule. The gas ions may have one or two or more negative or positive charges due to the addition or loss of varying numbers of electrons.

The glow discharge or "silent" electric discharge was thought at one time to offer technical possibilities for the fixation of nitrogen. It was known that when air is passed through an electric arc nitric oxide is produced, which can then be oxidized and absorbed in water to give nitric acid. The yields are disappointingly low—perhaps one mole per kilowatt hour, because most of the energy is wasted as heat. The glow discharge did not give off much heat and formerly when the fixation of nitrogen was an important problem all possible methods were investigated. A high voltage, high frequency Tesla discharge in a large cylindrical vessel seemed to give large quantities of nitrogen pentoxide and nitric acid but when the chamber was lined with paper shields and converted into an air calorimeter it was found¹ that the ratio of chemical product to heat losses was no more favorable than that which is found in the ordinary arc process. In early studies of the arc method for making nitric oxide efficiencies were calculated on the basis of the heat of the reaction, but of course the energy required for activation may be much greater than the endothermic heat of reaction.

For the reaction $N_2 + O_2 = 2 NO$, $\Delta H = 43,200$ and $\Delta F = 41,700$. The change in free energy, ΔF , shows how much work would be required to bring about the reaction provided that no energy of activation were required. Since ΔH is 43,200 calories (endothermic reaction) it is known that the energy of activation must be at least as great as 43,200 and probably it is much greater. If it is necessary first to break an oxygen molecule into atoms, at least 117,000 calories is required for two moles of nitric oxide. One kilowatt-hour is equivalent to 860,000 calories and if one mole of nitric oxide is produced per kilowatt-hour there is only a 6.7 per cent efficiency based on the formation of oxygen atoms as a first

¹ Daniels, Keene and Manning, *Trans. Am. Electrochem. Soc.*, **44**, 245 (1923).

step. If it is necessary to produce both nitrogen atoms and oxygen atoms or if it is necessary to produce ions by the electric arc before nitric oxide can be formed, the theoretical requirement for energy is greater and the observed results correspond to a greater theoretical efficiency.

There is doubtless considerable recombination of the intermediate fragments to give back N_2 and O_2 . It is not surprising then to find the practical limiting efficiency so low that the arc process for fixing nitrogen has been largely displaced by the catalytic Haber process which does not need to draw so heavily on high energies for the first steps in the reaction. Earlier calculations of the efficiency of this process depended on a purely thermodynamic approach, namely heating the gases to $4,000^\circ$ or so and suddenly cooling them. This temperature is so high that the energy of activation is easily supplied, and all ordinary chemical reactions proceed instantly. The speed with which the hot products are cooled to a temperature of stability (below $1,000^\circ$ for nitric oxide) determines the amount of the chemical products obtained. There is considerable doubt though that the calculations of thermodynamics can be applied to an electric arc, an electrical discharge or a flame, because the temperature is not a definite thing. In defining and using the temperature of a gas in calculations, it is assumed that the molecules are moving with different velocities as given by the Maxwell-Boltzman distribution. This distribution does not apply in the arc, but it does apply in the chilled gases.

CHEMICAL REACTIONS IN ELECTRICAL DISCHARGES

The most common and the most important chemical use of the electrical discharge lies in the production of ozone. Ozone is an excellent oxidizing material and it leaves only oxygen as an end product. If it could be made more cheaply it would find wide industrial application. Attempts to increase the efficiency have not been very successful and about one mole of ozone per kilowatt-hour is not far from the present practical limit, although there seems to be no evidence that this is the theoretical limit.

The decomposition of ozone in the intense electrical discharge takes place more readily, at equal concentrations, than its formation and eventually an equilibrium between ozone and oxygen is reached. For highest efficiency per kilowatt hour the oxygen is passed rapidly through the ozonizer and the concentration is kept

low. For highest concentration the oxygen is passed through slowly and efficiency is sacrificed. When air is present oxides of nitrogen are produced together with the ozone.

Lind and Glockler² have examined thoroughly the effect of the electrical discharge on hydrocarbons. They are able to produce either substances of higher molecular weight or substances of lower molecular weight. Starting with hexane, for example, they obtain a liquid having some of the characteristics of a petroleum oil and at the same time they obtain lighter gases such as ethane. The results can be explained on the basis of the cluster ion hypothesis. According to this hypothesis the molecules are broken up into ions which may either recombine to give smaller molecules or combine with neutral molecules to form a larger charged unit or cluster. By subsequent neutralization of the charge on a cluster, large molecules can be formed. With the recent successes of the free radical hypothesis these experimental results should be examined to see if they can be explained also on the assumption that the molecules are split into free radicals which then react to give either larger or smaller molecules. There is plenty of energy present to break up the molecules into free radicals. It is certain, however, that there are a great many ions present and the attachments and recombinations of these ions can give any of the products which are found experimentally. Of course, both processes may be going on simultaneously.

A comprehensive study of the chemical effect of electrical discharges on inorganic gases has been carried out by Brewer.³ The experimental measurements were made in large tubes, at a pressure of a few millimeters. Current was supplied from a D.C. dynamo. The course of the reaction was followed by pressure changes and chemical analyses. In many cases the discharge chamber was immersed in liquid air to remove the products immediately, so as to decrease the possible number of reactions in the discharge. Exploring electrodes were used with an electrostatic voltmeter. The nature of the discharge, and the influence of walls were considered as factors. The number of ions was estimated directly from the known energy input and the ionization potentials

² Lind and Glockler, *J. Am. Chem. Soc.*, **50**, 1767 (1928); **51**, 2811, 3655 (1929); **53**, 3355 (1931).

³ Brewer and Westhaver, *J. Phys. Chem.*, **33**, 883 (1929).

Brewer and Kueck, *J. Phys. Chem.*, **38**, 889 (1934). A series of fourteen papers published in the *Journal of Physical Chemistry*.

of the gas, and indirectly from the length of certain parts of the electrical discharge and the correlation with ionization measurements of other investigations. The formation and decomposition of ozone, nitrogen oxides, ammonia and water were among the reactions studied.

In general the rate of chemical reaction in a uniform electrical discharge of this type is proportional to the current and independent of the initial gas pressure. The reaction seems to be initiated by the positive ions. The results were interpreted on the basis of the cluster ion theory. In the case of chain reactions such as are obtained in a mixture of hydrogen and oxygen, Brewer⁴ suggests a cluster ion chain. He assumes that an ion attaches to itself one or more neutral molecules and that this cluster is broken up by a collision with a "hot" molecule. The product (water) is liberated and the ion is released so that it can capture more molecules (of H₂ and O₂) and repeat the process. The hot molecules are freshly formed molecules of product which retain momentarily some of the exothermic heat of reaction. In other fields of research the combination of hydrogen and oxygen has been explained on the basis of chains propagated by OH radicals and H atoms and this type of chemical chain should be considered as a possible alternative hypothesis.

The connection between reactions occurring in the electrical discharge and the light emitted in the discharge is a matter of interest. Practically all electrical discharges through gases emit visible and ultraviolet light in large amounts. Spectroscopic analysis of this light as well as mass spectrographic analysis of the gas indicates the presence of fragments such as OH and various ions. Whether these fragments recorded in the spectrum play a fundamental or an incidental rôle in the main chemical reaction is difficult to decide and few generalizations for all reactions can be made. Harkins⁵ has made an exhaustive study of this field and he records convincing evidence for the existence of many different molecular fragments in the gaseous electrolysis of benzene and other complex organic compounds. It is clear that in a closed system the products will accumulate to such an extent that they may be carrying most of the current and giving out much of the light, particularly if the products have an ionization potential lower than

⁴ Brewer and Westhaver, *J. Phys. Chem.*, **34**, 2343 (1930).

⁵ Harkins, *J. Chem. Phys.*, **1**, 37 (1933).

that of the reactants. The purity of the initial substance is important, and it is particularly important to exclude oxygen and water. In many cases chemical reaction is partly due to the ultraviolet light which almost always accompanies the discharge. The extent to which the electrical reaction is photochemical in this sense changes with the pressure of the gas, the nature of the light and other factors.

A significant application of the electrical discharge in chemical kinetics has been carried out by Rodebush,⁶ in which he introduces atoms of hydrogen, oxygen or nitrogen and hydroxyl radicals into a reacting system to determine the effect of these intermediate products. The practical application of this principle to the Langmuir atomic hydrogen torch is well known. The recombination of hydrogen atoms is slow on account of the triple collisions required, and intense heat without oxidation is available at a distance from the discharge tube.

CHEMICAL EFFECTS OF ALPHA PARTICLES

The electrical discharge offers the most convenient and cheapest method for producing chemical reactions by electronic activation. It is difficult, however, to plan the experiments so as to obtain material of theoretical significance because so many different phenomena are simultaneously involved and the measurements of ionization and energy input for chemical action are indirect.

Lind has done the most significant and the most extensive work on the electronic activation of chemical reactions. Most of his work has been done with alpha particles and this subject is adequately summarized in his monograph.⁷ Alpha particles from radon offer a direct means of determining the relation between the number of molecules reacting and the number of ion-pairs formed.

The number of ions produced by an alpha particle may be determined for a given gas from physical measurements based on ionization currents. Alpha particles are shot into a chamber containing a gas between two charged electrodes connected through an electrometer. As the voltage is increased gradually, more of the ions are drawn over to the electrodes before they have a chance to recombine and the current through the electrometer is thus in-

⁶ Spealman and Rodebush, *J. Am. Chem. Soc.*, **57**, 1474 (1935).

⁷ Lind, "*The Chemical Effect of Alpha Particles and Electrons*," The Chemical Catalog Co., New York, (1928).

creased. For a considerable range of voltage the current is proportional to the voltage according to Ohm's law, but at still higher voltage the current becomes independent of voltage. Any further increase in voltage then does not increase the current because *all* of the ions are already being brought to the electrodes, i.e., there is no recombination of ions in the gas space. This maximum current is called saturation current, and it is a true measure of the number of ion-pairs formed in the gas space between the electrodes. Each electron discharged or taken up at the electrodes causes 1.59×10^{-19} coulomb to pass through the circuit and the number of electrons per second is obtained by dividing the current, expressed in amperes, by this quantity.

Intense ionization from a rather large supply of alpha particles is necessary to obtain sufficient chemical action for a quantitative test but under these conditions the voltage required to give saturation current is so great that ionization by collision would set in and an electrical discharge would be produced thus defeating the purpose of counting all the ions. It is necessary then to determine the number of ion pairs under weak ionization and to determine the chemical action under strong ionization. The number of alpha particles is easily determined, however, and there is no difficulty in calculating the number of ion pairs produced when the ionization is strong enough to give a measureable chemical change. The ratio of the number of molecules produced to the number of ion pairs—the so-called M/N ratio—is of particular significance. Lind and his coworkers have determined these ratios for many gas phase reactions and find that they usually fall in the range from unity to three or four and sometimes more. In several cases the ratio of molecules reacting to ion pairs is approximately the same as the ratio of molecules to quanta absorbed in the same reaction when produced by light instead of alpha particles. Moreover, when reaction chains are involved, as in the combination of hydrogen and chlorine, the chain length is the same whether initiated by photons or by ions.⁸

Lind bases his cluster-ion theory on these results with alpha particles. Each ion attaches one or more neutral molecules of the reacting substances and when the ions are neutralized all the molecules involved in the two clusters undergo chemical reaction. The M/N ratio gives a measure of the number of neutral molecules

⁸ Porter, Bardwell and Lind, *Jour. Am. Chem. Soc.*, **48**, 2603 (1926).

attached to the ions. For example, in the radiochemical oxidation of carbon monoxide the reaction is thought to be as follows:

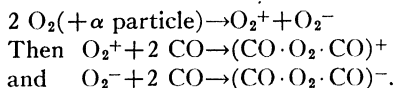

When these two cluster-ions combine



A ratio of 4 molecules of carbon dioxide to each ion pair is predicted on the basis of this theory. By direct experiment the M/N ratio is found to be 3.9 to 4.4. In other reactions, as in the polymerization of acetylene a cluster of twenty molecules is assumed in order to account for the experimentally determined M/N ratio. The cluster ion offers a satisfactory explanation of many radiochemical reactions but the size of the cluster is assigned rather arbitrarily, and there may be other ways of accounting for the experimental facts.

In view of the apparent success of the hypothesis of free radicals some of the radiochemical reactions, particularly those involving hydrocarbons and organic vapors, should be re-examined to determine whether the formation of free radicals plays an important rôle. Some experiments, like the ortho-para hydrogen conversion in which a thousand molecules react per ion pair,⁹ are explained on the basis of free radical (or atom) formation and cannot be explained on the basis of an ion cluster since the mean life of the ions is too short. The energy requirements for free radicals usually correspond to less than four or five volts. Nearly all molecules require more than five volts for ionization—up to fifteen to thirty volts and more. In these reactions there are about as many ions as molecules of new products and their presence would seem to imply a fundamental rather than an incidental connection. This fact can be explained as well on the combined ionization and free radical theory as on the cluster ion hypothesis. According to it¹⁰ some of the molecules are dissociated into free radicals without ionization and others are ionized to form charged products as observed in the mass spectrograph. The ions are subsequently neutralized to form free radicals and atoms which then react further.

⁹ Capron, *Ann. Soc. Sci. Bruxelles*, **55**, 222 (1935).

¹⁰ Eyring, Hirschfelder, and Taylor, *J. Chem. Phys.*, **4**, 479, 570 (1936).

CHEMICAL EFFECTS OF CATHODE RAYS

When electrons are driven through an evacuated tube under a high potential gradient they acquire such high velocities that they can penetrate very thin windows of metal foil or other material. It is possible then to introduce a beam of electrons directly into a chemical system, as one would introduce a beam of light in photochemical experiments. In this way the complicating factors of the electrodes and the inequalities of the electrical discharge can be eliminated. W. D. Coolidge¹¹ has developed an effective cathode-ray tube which provides a large beam of electrons and gives energies of 200 calories per minute and more. The cathode rays are like beta rays, and with a tube of this type it is possible to obtain a beam equivalent to the beta rays from over a gram of radium and its decomposition products.

The tube is a large X-ray tube with an electron-emitting filament heated by an insulated transformer. A potential of 150,000 to 300,000 volts D. C. is applied and the electrons are drawn over to the positively charged electrode which is in the form of a nickel window. The window, only 0.0012 cm. in thickness, is supported on a grid attached to a thin copper tube which is sealed into the glass tube. A high vacuum must be maintained by continuous evacuation with a mercury vapor pump. The electrons issue in a beam which is soon scattered by the air molecules but the electrons will penetrate up to forty or fifty centimeters in air or other gas.

The chemical effects of these cathode rays on oxygen, air, nitric oxide, and carbon dioxide were studied with reference to the number of molecules reacting per estimated number of ions.¹²

The voltage applied to the tube ranged from 185 to 200 kilovolts and the current across the electrodes in the tube ranged from 0.4 to 1.0 milliampere. The thermometer-calorimeter was a flat circular disk of thin copper, completely closed except for a protruding capillary tube of thin glass. It was filled with nitrobenzene and the heat absorbed from the cathode rays was calculated from the heat capacity and from the temperature rise as determined from the reading of the nitrobenzene meniscus in the capillary on a scale, determined by calibration at different temperatures. A large and unsatisfactory cooling correction was necessary. The calorimeter was removed and the reaction cell, 7.5 cm. in

¹¹ Coolidge, *J. Franklin Inst.*, **202**, 693-735 (1926).

¹² Busse and Daniels, *J. Am. Chem. Soc.*, **50**, 3271 (1928).

diameter and 22 cm. long, provided with a thin nickel or cellophane window, was put in its place. On the basis of energy input cathode rays are very inefficient in producing chemical reactions. Only a small part of the energy applied to the tube is recovered in the electron beam outside the tube, and although this is high-intensity energy theoretically capable of producing any chemical change whatever, it becomes largely dissipated as low grade energy. It is expended in producing secondary electrons and ions moving with lower velocities. Much of this energy in turn can be converted into increased kinetic energy of the molecules and degraded as heat.

The results are shown in Table I.

TABLE I

Reaction	Micromoles product per min.	Calories per min.	Calories per mole	Molecules per electron through tube
$O_2 \rightarrow O_3$	25	8.6	3.4×10^5	100
Air $\rightarrow O_3$	11	8.6	7.8×10^5	44
Air $\rightarrow NO$	4	8.6	22×10^5	14
$NO \rightarrow O_2$	57	8.6	1.5×10^5	230
$CO_2 \rightarrow CO$	2	37	180×10^5	3

It must be emphasized that the figures of the last column are not significant except as to relative values. Many of the electrons which pass through the cathode-ray tube are absorbed in the windows, or scattered by the air. An estimate of the ratio of the number of molecules reacting to the number of ion pairs produced in the reaction chamber is much more significant, and these ratios are about the same as the ratios obtained by Lind in his investigations on alpha particles. The estimates are made on the assumption that the number of ion pairs may be calculated roughly by dividing the total energy by the energy corresponding to the ionization potential. Taking the ionization potential of molecular oxygen as fifteen volts the input of 8.6 calories corresponds to a maximum of 1.5×10^{19} ion-pairs. In other words, approximately one molecule of ozone is produced for each ion pair produced by the high voltage cathode rays. This ratio is in close agreement with the findings of Lind with alpha particles. Of course this is a maximum value, and if the energy of the cathode rays is not completely utilized in producing fifteen volt molecular ions the quantity will be less than one molecule per ion pair. There is some evidence that only about

half the energy of high-voltage electrons is utilized in producing ions. The rest is utilized in producing excitation of the molecule without ionization.

The ionization potential of nitric oxide is nine volts, and the ratio of molecules reacting to ion-pairs produced by an energy input of 8.6 calories is 1.6. In Table I it is seen that for a given input of cathode rays the reaction is 2.3 times as great for nitric oxide as for oxygen. The very low yield with carbon dioxide is in perfect agreement with Lind's results with alpha particles.¹³ Apparently the CO₂ ions recombine without chemical rearrangement.

Cathode rays will produce vitamin D from ergosterol.¹⁴ This reaction has been studied in some detail and it is clear that the efficiency per electron is much less than the efficiency per photon of ultraviolet light.¹⁵ A great deal of ergosterol undergoes decomposition into other products. This situation is to be expected, for the formation of vitamin D from ergosterol is a highly specific reaction,¹⁶ involving the rupture of a ring and the production of an additional double bond. It is known that the photochemical operation can be effected with practically no loss, nearly one molecule reacting for each photon absorbed. The decompositions, however, need follow no specific route and when a high-voltage electron strikes a molecule many other reactions, in addition to the conversion into vitamin D, are competing for the energy. Furthermore, on account of their large energy, the high speed electrons have lost much of the precision as a kinetic tool that characterizes selectively absorbed light quanta of smaller energy.

The output of the cathode ray tube measured calorimetrically was 200 calories per minute. Calculations based on this output and on the 77,000 volts at which the electrons emerge from the nickel window, show that approximately 4.5×10^{17} electrons were emitted in 400 seconds. From a knowledge of the number of molecules of ergosterol originally present and the number of vitamin D molecules present at maximum potency it was estimated that 0.2 molecule of vitamin D was produced and 80 molecules of ergosterol were decomposed for each electron striking the ergosterol.

In this investigation it was found that the thickness and nature of the solid film were important. Obviously there should be no va-

¹³ Reference 7, page 155.

¹⁴ Knudson and Coolidge, *Proc. Soc. Exp. Biol. and Med.* **24**, 366 (1927).

¹⁵ Hoffman and Daniels, *J. Biol. Chem.*, **115**, 119 (1936)

¹⁶ Page 171.

cant spaces in the area exposed to the cathode rays. If the layer is too thin, some of the electrons will be stopped by the supporting dish without producing their full quota of chemical action. Again, if the film is too thick the potency of the product will be abnormally low on account of the excess of unchanged ergosterol which is too far below the surface layer to be reached by the electrons. The most homogeneous and reproducible films were produced by sublimation. The ergosterol was heated in a vacuum desiccator and quickly condensed on a cold metal surface just above. Twenty-four milligrams of material was used for a single exposure to the cathode rays and the product was then assayed for its vitamin D content in Steenbock units.

Several different exposures were made with 0.7 milliamperes passing through the tube at a peak voltage of about 180,000 volts, using mechanically-rectified alternating current. The results are given in Table II.

TABLE II
ACTIVATION OF ERGOSTEROL WITH CATHODE RAYS

Time	Total units. Expt.	Units per mg. Expt.	Units per mg. Calc.
0	0	0	0
5	4.8	0.2	1
10	4.8	0.2	2
30	4.8	0.2	5
100	168	7	12
400	480	20	20
1,000	408	17	16
2,000	240	10	10

Two things are to be noticed: there is a time lag at the beginning of the experiment, and there is a maximum yield of vitamin D which occurs under the conditions of these experiments after about 400 seconds. This anomalous behavior at the beginning is in line with other observations such, for example, as the increase in absorption of ultraviolet light which suggests the formation of an intermediate or decomposition product having an absorption spectrum similar to ergosterol but with a greater absorption coefficient. There appear to be two maxima or steady states at which the rate of decomposition of vitamin D is equal to the rate of formation.

The following set of reactions accounts for most of the results

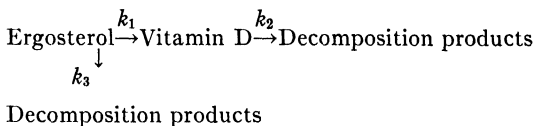

This representation embraces the possibility of intermediate steps between ergosterol and vitamin D since k_1 refers to the slowest step and k_3 can apply to any of these intermediate products. If y is the amount of vitamin D present at any time and c_0 is the maximum possible content, it can be shown that

$$y = c_0 k_1 / (k_2 - k_1 - k_3) (e^{-(k_1+k_3)t} - e^{-k_2 t}).$$

Successive approximations gave the following constants

$$k_1 = 0.0000174 \text{ sec}^{-1}; k_2 = 0.0005 \text{ sec}^{-1}; k_3 = 0.007 \text{ sec}^{-1}.$$

With these values, the net potencies of vitamin D were calculated for different times as shown in the last column of Table II. Except for the anomalous behavior at the beginning where still other steps must be involved, the calculated values are in close agreement with the experimentally observed values. These kinetic studies then show that under the condition of these experiments with cathode rays, ergosterol is decomposed directly without necessarily going through the vitamin D stage. Moreover, the probability of destruction k_3 of ergosterol is 400 times as great as the probability of its conversion k_1 into vitamin D; and the probability of destruction k_2 of vitamin D is thirty times as great as the probability of its formation k_1 .

CHEMICAL EFFECTS OF X-RAYS

Quantitative work on the chemical effects of X-rays is limited because it is difficult to get enough energy into the reacting system to give measurable chemical changes. Calculating on the basis of the number of molecules reacting per photon absorbed, one might expect very large yields because each photon absorbed by a suitable system produces a great many molecules of product. Perhaps a thousand or more molecules react for each photon even in cases as the decomposition of potassium nitrate, where chain reactions are unlikely. In spite of this apparently large quantum yield the total amount of product is small because each quantum carries such an enormous amount of energy. Even the long wave length X-rays at 1 Å contain 200 million calories per mole, or 1.2×10^{-10}

erg per photon. Obviously the number of such large sized quanta must be very small, especially in view of the fact that the total energy in an X-ray beam is extremely low.

The intensity of a beam of X-rays may be determined by measuring the number of ions produced per cubic centimeter per second with an electrometer and ionization chamber under conditions which give saturation current. If the beam is sufficiently intense its energy can be determined also with a thermopile consisting of a lead block in which are imbedded a large number of thermocouple junctions. Comparative measurements may be made with actinometers such as the mercuric oxalate actinometer in which a long chemical chain greatly magnifies the effect to be measured.

Chemical studies of X-rays are handicapped not only by the small amounts of energy available from ordinary X-ray tubes but also by the low absorption of the X-rays. The rays are so penetrating that a reaction chamber of ordinary dimensions absorbs only a small fraction of the emitted rays, and if a very long chamber is used the micro analysis of the products becomes difficult. This handicap of low absorption is particularly true, of course, for gases. The soft X-rays, from 1 to 3 Å, called Grenz rays, are less penetrating but they are even more difficult to produce in large quantity. The most desirable conditions would be met if the chemical analysis could be made so very sensitive that the course of the reaction could be followed chemically, while the number of ions produced is measured directly using saturation current. Such a procedure calls for a sensitivity of chemical measurement beyond that which is now practical.

When the X-ray photon is absorbed by a molecule an inner electron is expelled with great velocity and many ions are produced which in turn initiate chemical reactions. The chemical effects of X-rays then are like the ionization reactions of high velocity electrons or an electrical discharge and are less like photochemical reactions.

The oxidation of metallic ions in aqueous solutions by X-rays has been studied extensively.¹⁷ In these and other reactions it is necessary to remove dissolved air and other impurities from the water in order to study the primary reaction. Fricke¹⁸ found that even after chemical purification and passage of the water vapor

¹⁷ Fricke and Hart, *J. Chem. Phys.*, **3**, 60, 365, 594 (1935).

¹⁸ Fricke, *J. Chem. Phys.*, **3**, 364 (1935).

through a quartz tube heated to 800°, detectable quantities of organic material still remained and gave off carbon dioxide and hydrogen on radiation. He was able to obtain water sufficiently pure for these investigations only by preliminary treatment with X-rays until the organic material was destroyed.

Where chain reactions have been studied they are found to be the same whether started by X-rays or by ordinary light. Günther¹⁹ measured the amount of hydrochloric acid formed from hydrogen and chlorine under the influence of X-rays, and then in the same reaction chamber he determined the amount of reaction produced by a measured quantity of visible light. The latter measurements determined the length of the chemical chain and from the total chemical reaction he was able to calculate the number of chains started by the X-rays. Combining these data with experiments on ionization, he concluded that each ion produced by X-rays starts a chain, just as does each photon of visible light, or each ion produced by alpha particles.

The study of the effects of X-rays on biological systems has been particularly fruitful.²⁰ X-rays can penetrate deep into a cell or into an organism without serious effects if the exposures are not too long. In this way they can bring about chemical reactions in places which could not be reached in any other way. The mutations produced by radiating fruit-flies or plants and animals, the suppression of cancer growth, the cure of certain skin diseases are all examples of secondary effects which deserve intensive study in chemical kinetics.

The question arises as to how far cosmic rays and natural ionization due to traces of radioactive material are factors in chemical reactions and biological processes and in organic evolution. Cosmic rays alone produce a little more than one ion pair per cubic centimeter per second at the surface of the earth in most localities, and radioactive potassium or traces of radioactive gases in the atmosphere usually give a still larger number of ions. Since at least 10¹⁷ molecules of material are required for the most sensitive chemical tests it is unlikely that these ions can play a detectable rôle in chemistry. It is conceivable, however, that long chain reactions are occasionally started by such ions. The influence on the growth

¹⁹ Götzky and Günther, *Z. physik Chem.* **B26**, 373 (1926).

²⁰ Duggar, *Biological Effects of Radiation*, McGraw-Hill Book Co., New York (1936). Chapters XXXVIII-LII.

of an organism by physical or chemical changes in the chromosomes has been fully established and such a phenomenon may be considered as an extreme example of a "chain" reaction which magnifies enormously the primary reaction. Present estimates indicate that the number of mutations, on which biological evolution is based, are far too numerous to be accounted for on the basis of cosmic rays, but certainly some of the mutations and other effects are due to these primary reactions of chemical kinetics induced by ions from cosmic rays or radioactive material. Moreover it is quite possible that cosmic radiation might have been much more intense in earlier times. In this connection there is an interesting suggestion²¹ that the slight but measurable electrical conductance of non polar liquids like hexane is due to the ionization produced in them by cosmic rays.

CHEMICAL EFFECTS OF LOW VOLTAGE ELECTRONS

The theoretical relation, $Ve = h\nu$, has been abundantly checked in measurements of spectroscopy and physics but its direct application to complex molecules in chemical reactions has not been established. Bombardment of mercury atoms or other simple atoms at low pressures by electrons under controlled voltages causes the emission of monochromatic light at the wave lengths predicted by this formula. Moreover, the ionization potential, at which the electron is completely separated from its atom, corresponds directly to the wave length at which the discrete lines of the spectrum merge into a continuous spectrum. This continuous spectrum is due to the fact that the kinetic energy of the expelled electron and ion is not quantized. The close agreement between the ionization potential and the lowest frequency of continuous absorption, where ionization first starts, constitutes another proof of the relation $Ve = h\nu$.

Only a few attempts have been made to determine whether or not the voltage at which bombarding electrons cause chemical action corresponds to the wave length at which ultraviolet light is chemically effective, and the results are not conclusive. The experiments are difficult, because any apparatus which is capable of producing a beam of "monochromatic" electrons at these low voltages can give but very little electron current, so little that chemical analysis of the products requires exacting micro-methods.

²¹ Adamczewski, *Nature*, **137**, 994 (1936).

A micro ampere will give $1 \times 10^{-6} / 1.59 \times 10^{-19}$ or 6×10^{12} electrons per second. The most sensitive chemical tests require a micromole or 6×10^{17} molecules for analysis. Assuming that one low voltage electron causes one molecule to react it is evident that a bombardment of electrons under these conditions would have to continue for 100,000 seconds or 1.16 days with a micro ampere of "monochromatic" electrons. Obviously, for practical results greater electron currents are necessary and the purity of "monochromatic" electrons must be sacrificed for increased currents, i.e., the range of voltages must be widened.

One of the earliest attempts to establish the chemical effects of low voltage electrons was the bombardment of a photographic plate. The development of the plate magnifies greatly the effects initiated by the electron bombardment and the plate can be set in a chamber evacuated to a very low pressure so that the electrons can reach the plate undeviated by collisions with gas molecules. The plate is affected by visible light and according to the relation $Ve = h\nu$, it should be affected by electrons at two or three volts if the electron produces the same change as does the light. It was found, however, that the voltage must be increased to over twenty volts before any effect is produced on the plate. At these higher voltages light is produced by collision with the gas molecules still remaining in the vessel and the light is no doubt the cause of the action on the plate.²² These experiments, then, are not conclusive regarding this quantum relation because the gelatin surrounding the silver halide grains may prevent direct contact of the low voltage electron with the active parts of the photographic plate. When the voltage is high enough to produce light which can pass through the gelatin film there is action but it is not known whether or not the lower voltages would have an effect in the absence of this protecting film.

A similar situation exists in the killing of bacteria. Ultraviolet light below 3,000 Å kills bacteria but the corresponding four volt electrons do not. Possibly they might if they could penetrate the cell walls of the bacteria. Twenty-five volt electrons will kill bacteria²³ but here again the killing action may very likely be due to the ultraviolet light which is produced by electronic collisions with the residual gas molecules.

²² Burroughs, *Rev. Sci. Instruments*, **2**, 321 (1931).

²³ Wells, *Bul. Basic Sci. Research*, **3**, 5 (1931).

Glockler²⁴ has reported that low voltage electrons from three to twenty volts do produce chemical action in agreement with this theory, when acting on oxygen. Metastable oxygen molecules, or electronically excited molecules or ions are produced depending on the voltage and they are removed on a mercury surface.

Two other investigations of the chemical decomposition of solids by electron bombardment and by ultraviolet light are worthy of attention. The decomposition of potassium chlorate²⁵ requires twenty-two volt electrons and the decomposition of sodium azide²⁶ requires voltages of 15.8 and greater, although in both cases the decomposition is easily effected by ultraviolet light corresponding to less than five volts. Even in these cases there is a chance that the action is that of the electrons on gas molecules (nitrogen in the case of sodium azide) adsorbed on the surfaces and one can not be sure that electrons, having energy such that $Ve = h\nu$, fail to react. Most of the energy of the electrons is utilized in producing ions and this process requires more energy than the excitation by photons. However, more experiments are needed to test this relationship. A rich source of electrons of very limited voltage range, a simple, uncomplicated reaction, and an extremely sensitive method of analysis are needed. The efficiency of these low-voltage electrons (in molecules reacting per electron) will probably turn out to be quite low in complicated molecules—considerably lower than the efficiency with ultraviolet light. The absorption of light is quite specific, and the energy is supplied in a definite part of the molecule. However, an electron can probably be stopped by any part of the molecule and the transfer of energy from some parts to the part necessary for chemical action may be attended with much spreading and degradation of the energy.

²⁴ Glockler and Wilson, *J. Am. Chem. Soc.*, **54**, 4544 (1932).

²⁵ Meiler and Noyes, *J. Am. Chem. Soc.*, **52**, 527 (1930).

²⁶ Müller and Brous, *J. Chem. Phys.*, **1**, 482 (1933).

CHAPTER VIII

INFRARED SPECTROSCOPY

AS POINTED out in an earlier chapter the near infrared spectrum is connected with displacements of the atoms within the molecule. Remarkable advances have been made within the last few years in correlating these spectra with the structure of the molecule. In many of the simple molecules it is now possible to state just what types of vibration are occurring in the molecule and which of the various vibrations produces a given infrared frequency. Our interest in this work from the viewpoint of chemical kinetics is still on the frontier fringe and is based largely on the hope that we can learn something of the manner in which a complex molecule will break up from the manner in which the atoms are vibrating in the normal molecule. This hope has not often been realized as yet. In the meantime determinations of the fundamental frequencies of the spectrum, corresponding to fundamental modes of vibration, are necessary for calculating energies of activation as described in the following chapter. These fundamental frequencies are finding extensive application in the calculation of specific heats, free energies and equilibrium constants.

The far infrared spectrum, connected with the rotation of molecules, is not important for the present discussion. These low energy rotations are usually combined with the higher-energy displacements of atoms to give bands in the near infrared which show fine structure under high dispersion. It is the frequency of maximum absorption in these bands, corresponding to the fundamental frequency of atomic displacements, that is interesting in kinetics. These frequencies in turn may be combined with the much higher frequencies of electron displacements and a complete analysis of band spectra in the visible or ultraviolet spectrum provides another means for their determination. The direct measurement of the infrared absorption spectrum or the Raman spectrum,

however, offers the most direct way of evaluating these fundamental frequencies.

EXPERIMENTAL TECHNIQUE

Absorption spectra out to about 1.3μ can be determined directly with a spectrograph if specially sensitized plates are used. For longer wave lengths a thermopile is necessary. Glass can be used out to 2μ , quartz to 4μ , fluorite to 10μ , sodium chloride to 15μ , and potassium chloride to 23μ . Most of the interesting fundamental frequencies fall beyond 3μ and out at least to the limit of the transmission of rock salt.

The infrared spectrometer for this range is commonly made with a rock salt prism and rock salt windows. The light from a Nernst glower is focused onto the slit with a concave mirror which like all other mirrors in the apparatus is silvered on the front surface. The Wadsworth mounting is usually used in which the light is reflected from a plane mirror after passing through the prism so that when the spectrometer is set for minimum deviation on one wave length it will be in adjustment for all wave lengths. The instrument is adjusted with yellow light from the sodium arc or flame and the rotation of the spectrometer table in degrees permits a direct calculation of the wave length emerging from the rear slit. In this calculation it is necessary to know the index of refraction of rock salt at all the different wave lengths.¹ In order to obtain even fair resolution with a prism spectrometer it is necessary to use very narrow slit widths, and this of course requires a thermopile and galvanometer of very great sensitivity. A Paschen galvanometer of high sensitivity was used in the work described here. Galvanometers of lesser sensitivity and greater stability can be used with amplification in such a way that the first galvanometer focuses a beam of light onto a very thin thermocouple which in turn is connected to a second galvanometer. The deflection of the latter is proportional to the movement of the beam of light across the thermopile which in turn is proportional to the deflection of the first galvanometer. There is a practical limit to galvanometer sensitivity, for at currents less than about 10^{-10} ampere the Brownian movement of electrons in the circuit is great enough to give random fluctuations.

Fundamental infrared frequencies may be obtained also from

¹ A convenient table is given by Cross, *Rev. Scien. Instr.*, **4**, 197 (1933).

Raman spectra by measuring the shift in frequency of the scattered radiation. Intense, filtered light from a mercury vapor lamp is passed into the material under investigation and the scattered light is measured with a spectrograph. Some of the photons transfer energy to the molecules which they strike and the scattered light then has a frequency which differs from the frequency of the incident light by an amount equal to the fundamental infrared frequencies. On the spectrogram will be found weaker lines slightly displaced from the exciting line and the differences in frequencies give at once the fundamental infrared frequencies. They can be measured with precision. The Raman spectra of an enormous number of organic and inorganic compounds have been measured within the last few years.²

The Raman spectra are quicker and easier to determine than the infrared absorption spectra because ordinary optical equipment can be used, but frequently they are more difficult to interpret. The quantum restrictions in the two phenomena, particularly for symmetrical molecules, are not always the same, because the Raman spectrum involves an intermediate excited state of the molecule. For this reason, it is desirable to have the data of both Raman and infrared absorption spectra in order to determine completely the rotational and rotational-vibrational energy levels in the molecule. The Raman spectrum can be obtained in some solutions where direct absorption measurements are impossible because the solvent is opaque in the infrared. Aqueous solutions offer a good example of such a case.

Measurements of the intensity of infrared absorption offer opportunities for analysis which have not yet come into general use. Colorimetric analysis with visible light finds wide application for colored substances. In the infrared all molecules, except the simplest diatomic molecules like O₂, show absorption and with proper precautions and reservations the galvanometer deflections can be used to determine the amount of absorbing material in the path of the light. They could well be used to follow the course of a chemical reaction, as for example in the decomposition of nitrogen pentoxide. It is necessary to reduce scattered light to a minimum so that the infrared radiation from the rear slit is practically monochromatic. Then if Beer's law applies the calculation is simple, but if it does not apply a graphical method may be used in which

² Hibben, *Chem. Rev.*, **13**, 345 (1933); **18**, 1 (1936).

galvanometer deflections are plotted against concentrations in several different samples.

Such a method of analysis was used first by Warburg and Leithauser³ in the analysis of ozone and nitrogen oxides from an electrical discharge. Recently the method was applied with marked success by Wulf and Liddell⁴ to the analysis of fairly complicated organic compounds containing OH, NH or NH₂ groups. There is always a question about the effect of foreign molecules on such a test. Obviously if an additional substance, or additional substances, which absorb in the same region of the spectrum are present the analysis is spoiled. Even though the extra material is transparent at the measured wave length there has been some fear that it would prevent accurate analysis by infrared absorption. It had been shown that transparent gases in some cases increase the infrared absorption of other gases.⁵

A more recent investigation⁶ shows that complex molecules, or simple molecules at high pressures, or molecules in the liquid phase or in solution do follow Beer's law provided there is but one thing absorbing radiation at the given wave length. Simple molecules such as nitrous oxide and carbon monoxide at pressures below atmospheric pressure show increased absorption when a transparent substance is added. These simpler molecules show fine structure and the addition of the same or another gas broadens the fine-structure lines and increases the absorption of a beam of light in such a way as to invalidate the applicability of Beers' law. After this fine structure is blurred out further addition of transparent material has no further effect and Beers' law applies to increases in concentration of the absorbing material. It was found that the effectiveness of different kinds of molecules in increasing the absorption of the absorbing gas was proportional to the collision frequency as determined from viscosity measurements.

ETHYL BROMIDE

In studying the connections between chemical kinetics and infrared vibration frequencies the ethyl halides were chosen because the kinetics of the decomposition of ethyl bromide had been the object of such an extended investigation.⁷ In attempting to

³ Warburg and Leithauser, *Ann. d. Physik*, **28**, 315 (1909).

⁴ Wulf and Liddell, *J. Am. Chem. Soc.*, **57**, 1464 (1935).

⁵ E. v. Bahr, *Verh. d. D. Phys. Ges.*, **15**, 673 and 710 (1913).

⁶ Cross and Daniels, *J. Chem. Phys.*, **2**, 6 (1934).

⁷ Page 72.

assign definite bonds or atomic pairs to a given band in the absorption spectrum it was reasoned that by changing the halogens from chloride to bromide and to iodide, those bands which shifted the most must be the ones which most intimately involve the movements of the halogen atom. In assigning other bands to specific bonds the wealth of infrared and Raman data on other compounds was also taken into consideration.

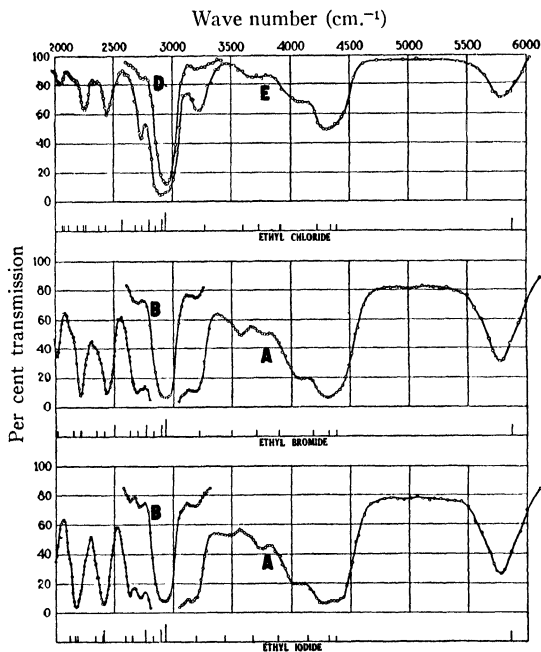

FIG. 35.—Infrared absorption spectra of the ethyl halides from 2,000 to 6,000 cm.^{-1}

Ethyl bromide is complex enough so that when the investigation was started there seemed to be no immediate chance of quantitative, mathematical interpretation. Rapid strides had been made in complete interpretation of the infrared spectrum of simple diatomic and triatomic molecules, but unfortunately it is usually the more complicated molecules that are important in chemistry. On account of their importance a qualitative interpre-

tation seemed worth-while, and with the rapid development occurring in infrared spectroscopy it seemed possible that before many years a more quantitative analysis might be possible.

Absorption Spectrum. The results of the investigation⁸ are shown graphically in Figs. 35 and 36.

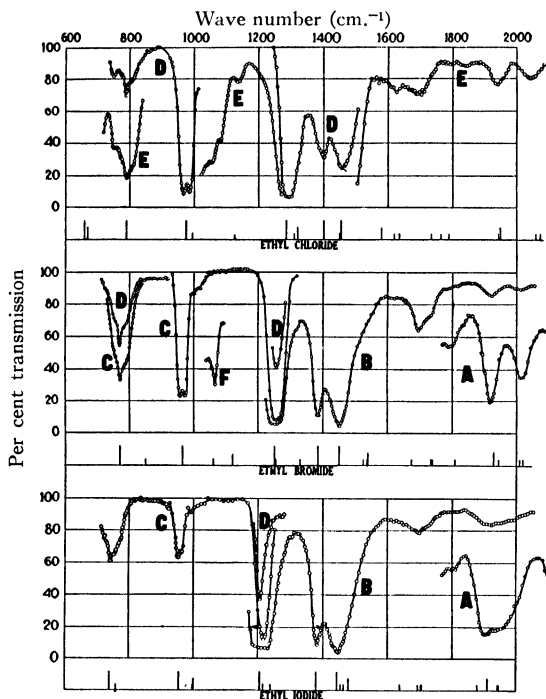

FIG. 36.—Infrared absorption spectra of the ethyl halides from 600 to 2,000 cm.^{-1}

All measurements were taken directly from galvanometer deflections of the transmitted light using for each setting of the spectrometer four similar cells mounted on a sliding track,—one empty, one filled with ethyl bromide and one filled with ethyl iodide. In this way the direct comparison between the bromide and iodide was rendered free from errors of the spectrometer. All

⁸ Cross and Daniels, *J. Chem. Phys.*, **1**, 48 (1933).

the cells were made with polished rock salt windows. Glyptol cement proved to be excellent material for attaching the windows. Curves A were obtained with 1.5 mm. of liquid, curves B with 0.05 mm. of liquid, curves C with the gases in a cell 16 cm. long at pressures corresponding to the vapor pressures at 25°, and curves D at undetermined reduced pressures. In curve E the radiation passed through 16 cm. of ethyl chloride at one atmosphere pressure and in curve F it passed through 0.5 mm. of liquid ethyl bromide.

The intensities of absorption at the different bands is indicated roughly by the per cent transmission plotted as ordinates in Figs. 35 and 36. The intense absorption in certain bands, even for very small quantities of absorbing material, leads to the conclusion that these bands are fundamentals, involving displacements of the atoms only to the first excited quantum state. The displacements to higher quantum states and the combination between two sets of quantum states are less probable; and, consequently, the harmonics and the combination frequencies show less intense absorption.

In the region investigated there are six intense absorption bands for each compound corresponding to fundamental frequencies. Two additional fundamentals of lower frequency, fully established from Raman spectra, give a total of eight experimentally observed fundamentals out of a possible eighteen if the system is non-degenerate.

The harmonics and combinations of these fundamentals which play the most important part in the determination of the whole spectrum may be assumed to be of the types $2 F_i$ and $F_i + F_j$. The values of the wave numbers of the fundamentals and the combinations of these types for each of the three compounds studied are given in Table I. The values for the fundamentals are arbitrarily averaged values chosen from those obtained in the present investigation by absorption measurements and those given by Raman data.

In Figs. 35 and 36 these calculated positions are indicated below each spectrum by 3-unit lines for fundamentals, by shorter 2-unit lines for first harmonics and by lines of 1-unit length for combinations. It will be observed that a region of intense absorption in the experimental curve is indicated by the grouping of a number of calculated values, and that regions of high transmission are accompanied by a scarcity of calculated values. In fact the whole complex

spectrum, experimentally determined, can be reconstructed with fair accuracy from these fundamentals and their first harmonics

TABLE I
CALCULATED WAVE NUMBERS OF ABSORPTION BANDS

	Ethyl chloride	Ethyl bromide	Ethyl iodide
F_1	2940	2935	2930
F_2	1455	1450	1445
F_3	1400	1385	1380
F_4	1285	1250	1205
F_5	975	965	955
F_6	790	770	740
F_7	660	560	500
F_8	335	290	260
$2F_1$	5880	5870	5860
$2F_2$	2910	2900	2890
$2F_3$	2800	2770	2760
$2F_4$	2570	2500	2410
$2F_5$	1950	1930	1910
$2F_6$	1580	1540	1480
$2F_7$	1320	1120	1000
$2F_8$	670	580	520
$F_1 + F_2$	4395	4385	4375
$F_1 + F_3$	4340	4320	4310
$F_1 + F_4$	4225	4185	4135
$F_1 + F_5$	3915	3900	3885
$F_1 + F_6$	3730	3705	3670
$F_1 + F_7$	3600	3495	3430
$F_1 + F_8$	3275	3225	3190
$F_2 + F_3$	2855	2835	2825
$F_2 + F_4$	2740	2700	2650
$F_2 + F_5$	2430	2415	2400
$F_2 + F_6$	2245	2220	2185
$F_2 + F_7$	2115	2010	1945
$F_2 + F_8$	1790	1740	1705
$F_3 + F_4$	2685	2635	2585
$F_3 + F_5$	2375	2350	2335
$F_3 + F_6$	2190	2155	2120
$F_3 + F_7$	2060	1945	1880
$F_3 + F_8$	1735	1675	1640
$F_4 + F_5$	2260	2215	2160
$F_4 + F_6$	2075	2020	1945
$F_4 + F_7$	1945	1810	1705
$F_4 + F_8$	1620	1540	1465
$F_5 + F_6$	1765	1735	1695
$F_5 + F_7$	1635	1525	1455
$F_5 + F_8$	1310	1255	1215
$F_6 + F_7$	1450	1330	1240
$F_6 + F_8$	1125	1060	1000
$F_7 + F_8$	995	850	760

and combinations. The agreement cannot be exact because it is impossible to include all the factors involved. It is known, for

example, that harmonics are not exact multiples of the fundamentals but that there are small correction terms.

Another cause for difference in calculated and observed spectra may be found in the fact that certain of the listed combinations may be very strong while others may be immeasurably weak, but it is not as yet possible to predict which are strong and which are weak.

The calculated positions do not represent all the possible absorption bands. There may be second or even higher harmonics, combinations of harmonics with fundamentals, etc., which are sufficiently strong to be factors in the observed spectra. Also there may be combinations of the type $F_1 - F_2$, which are fairly strong. This will be particularly true when F_1 is a low frequency fundamental, since a large fraction of these may be excited at room temperature.

Still another cause for the difference between the calculated and observed absorptions is the existence of weaker fundamentals.

Molecular Models. After selecting the most important fundamental frequencies from which the infrared spectrum is built, it becomes of interest to attribute to each a definite bond or type of vibration. Although such relations are quite speculative, there is now sufficient evidence to establish some of them with a fair degree of confidence.

In general, at least two different types of vibration seem to be well established;⁹ one a stretching or valence vibration in which two atoms move back and forth essentially along a line joining their centers, and another, a bending or deformation vibration in which two atoms swing back and forth laterally with respect to a third atom or group of atoms.

It is a striking fact that the fundamental nature of the vibrations between atoms is affected only slightly by vibrations located in other parts of the molecule. Double bonds and other structural features do exert considerable influence, but they are not involved in the present discussion of the ethyl halides. A given vibration is affected only to a slight or negligible degree by a substitution of atoms in a part of the molecule removed from the immediate vibration. When, however, atoms of different weight are substituted in

⁹ The work previous to 1931 is summarized by Kohlrausch, *Der Smekal-Raman Effekt*, Julius Springer, Berlin, 1931; Andrews, *J. Chem. Education*, **8**, 1133, (1931).

positions adjacent to the vibrating atoms the effect is more marked; and, if one of the atoms directly involved in the vibration is substituted, the change in frequency may be large. This fact has been used in choosing the types of vibration from the shifting of frequency caused by the chloride, bromide, iodide substitutions.

The fundamental frequencies expressed in wave-numbers have been given in Table I and are arbitrarily referred to as F_1 , F_2 , F_3 , etc., starting with the highest frequency. The types of vibration which are believed to correspond to each of these fundamentals are pictured graphically in Fig. 37. Obviously these models represent simplified approximations and they are not to be taken literally.

Comments can be made here on only a few of these suggested modes of vibrations. The fundamental frequency F_1 coming at 2,940, 2,935, and 2,930 cm^{-1} for the ethyl chloride, bromide and iodide, respectively, (3.40, 3.41, and 3.42 μ) has long been assigned to the carbon-hydrogen bond. Coblentz¹⁰ in his classical examination of over a hundred organic compounds observed this intense band at about 3.4 μ in every case where there was a simple linkage between carbon and hydrogen.

In reality this band includes also weaker harmonic and combination bands as, for example, the first harmonic of F_2 at 2,900 and a combination of F_2 and F_3 . This overlapping of different bands constitutes one of the greatest difficulties in interpreting infrared spectra. The chances of overlapping become less as the frequencies become less. For example, none of the combinations and harmonics of F_1 can fall in regions below 2,935 and these regions then involve one less variable. On the other hand by going to high enough harmonics or combinations any of the lower frequencies can come into the region of 2,935 cm^{-1} . The intensity, however, becomes rapidly less as one goes to the higher harmonics.

As shown in Fig. 37 this F_1 frequency is attributed to a stretching vibration of the carbon and hydrogen atoms, toward and away from each other. This is perhaps the most common linkage in organic compounds and when, as is frequently the case, there are several such groups in a single molecule the band becomes particularly prominent. It is not intimately influenced by the halogen atom and accordingly there is but a slight shift in F_1 in going from chloride to bromide to iodide. This frequency is not often of direct

¹⁰ Coblentz, *Investigations of Infrared Spectra*, Carnegie Inst. Pubs. Washington, 35 (1905).

importance in kinetics because so much energy is required to break the bond (a minimum of 92,000 calories per mole) that other bonds break first when the molecule is heated.

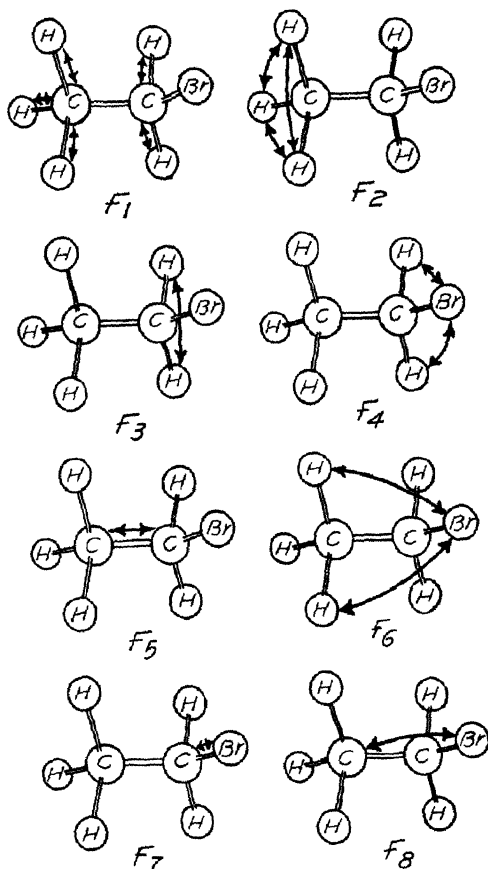

FIG. 37.—Molecular model and suggested vibrations of ethyl bromide.

The frequency F_2 falling at 1,455, 1,450, 1,445 cm^{-1} or 6.87, 6.90, and 6.92 μ occurs only when a CH_2 group is present. For example, in CHCl_3 , F_1 is present but F_2 is missing. It is only slightly affected

by a change of the halogen atom and it is attributed to two hydrogen atoms swinging laterally at the side of a carbon atom.

The frequency F_5 , also, is only slightly affected by a change of the halogen. It is found in ethyl compounds but not in methyl compounds and it occurs in ethane where there is no halogen. It is assigned to a stretching vibration of the two carbon atoms along a line joining their centers as shown in Fig. 37. This frequency is found in nearly all ethyl compounds except ethyl alcohol and in this case the OH and C_2H_5 groups have so nearly the same weights that an interaction is set up which tends to produce types of vibration in which the local features give way to features involving the whole molecule.

The frequency F_6 at 790, 770, and 740 cm^{-1} changes so markedly with substitution of the different halogens that the halogen atom must be directly involved. This frequency is not found in methyl halides. It may be due to a bending vibration which involves the halogen atom and a hydrogen atom on the second carbon atom.

The large change in F_7 at 655, 560 and 500 cm^{-1} with change of halogen points to a direct involvement of the halogen atom and the low frequency suggests that it is the heavy halogen atoms and carbon atom which are moving. It lies beyond the range of the rock salt prism (17.8 μ in ethyl bromide) and the data are taken from Raman spectra. It has been suggested by several investigators¹¹ that this frequency is due to a stretching vibration of the carbon and halogen atoms.

The lowest frequency at 335, 290 and 260 cm^{-1} corresponding to 29.9, 34.5 and 38.5 μ also had to be taken from Raman data alone since it is beyond the range of infrared spectrometers. The low frequency indicates that both atoms involved are heavy and the bending vibration of the halogen and the adjacent carbon atom was assigned to this frequency as shown in Fig. 37.

Quantitative Calculations. These attempts to connect physical and chemical properties with models are helpful to chemists and, in the hands of organic chemists, molecular models have led to marvelous advances, but physicists are inclined to object to them because they are inadequate in more quantitative fields. We were rather pleased with the assignment of definite bands in the spectrum of ethyl bromide to corresponding bonds in the molecule and

¹¹ Harkins and Bowers, *Phys. Rev.*, **38**, 1845 (1931).

so we enlisted the interest of Professor J. H. Van Vleck in attacking the problem more quantitatively from the viewpoint of modern physics. His thorough calculations¹² show that the general conclusions based on the qualitative model just described are essentially sound as a first approximation. He concludes that, "it is apparent from the normal modes of vibration of the systems studied that the designation of a type of motion involving only a part of the molecule to account for certain frequencies is justified under certain conditions of dissymmetry. This may in a large measure be responsible for the well-established fact that certain chemical bonds are accompanied by frequencies which vary but little from a mean value as drastic changes are made in other parts of the molecule. However, as was suggested by Cross and Daniels, the presence of certain types of symmetry, such as the approximate mass symmetry of ethyl alcohol, may cause an interaction of the different types of motion in such a way as to largely obliterate the characteristic features of the separate types of motion."

In arriving at these conclusions Cross and Van Vleck considered the ethyl halide as a three body problem with the units CH_3 , CH_2 , and the halogen, giving the three types of motion represented by F_5 , F_7 , and F_8 , in Fig. 37. It was assumed that the hydrogen atoms by virtue of their small mass and the strong forces holding them to the carbon atoms, do not produce any first order deviations in these vibrations under consideration. The potential of the unsymmetrical three-body system was calculated by describing the system in terms of the two distances from the central group, CH_2 , to each of the two other groups and the angle at which these two lines meet at the central group. Taking known values of the distances between atoms and the tetrahedral angle the equations were solved to give the vibration frequencies and the normal modes of vibration. They show that the C-C stretching vibration changes only slightly with a change of the halogen atom but that the carbon-halogen stretching vibration and the halogen bending show large changes in frequency. The calculated modes of vibration are utterly different in the case of the symmetrically-weighted ethyl alcohol, a fact which shows that bonds cannot be associated with bands in the case of symmetrical molecules. The spectrum under these special conditions is a function only of the whole molecule. In all cases there is close agreement between the

¹² Cross and Van Vleck, *J. Chem. Phys.*, **1**, 350 (1933).

calculated frequencies and the observed frequencies and, with the proper reservations, the simple mechanical model and the assignment of bands to specific bonds is justified.

ACETIC ACID

The mechanism by which acetic acid molecules combine to give double molecules has been the object of much speculation. Many cases of polymerization of organic substances are known; but most of them lead to large units of indefinite molecular weights, such for example as are found in the polymerization of formalde-

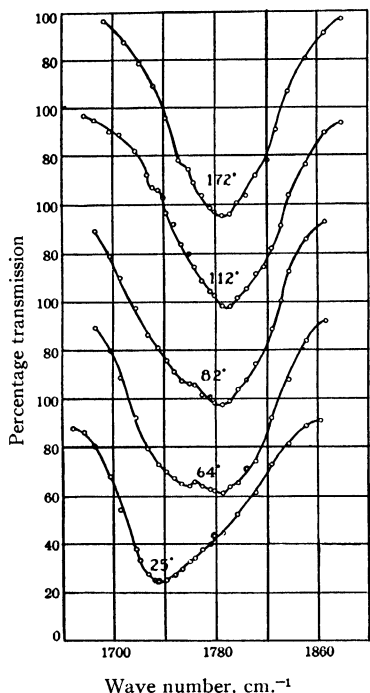

FIG. 38.—The shift with temperature of the infrared absorption spectrum of the carbonyl group in acetic acid.

hyde or isoprene or alcohols. The carboxylic acids, however, are rather unique in giving molecular weights which are exactly twice the sum of the atomic weights. Density measurements and freezing point depressions show that these dimers exist in the gas phase or in non-polar solvents and are broken up into monomers at temperatures around 175°.

Some have thought that the dipole moments of the molecule are responsible for the association but there seems to be little evidence that other substances of similar dipole moments give units in which the molecules are exactly doubled. The esters do not give double molecular weights. The presence of the hydrogen in the carboxyl group seems to be a requirement for the formation of dimers of this type. In fact the apparent abnormalities in several different types of compounds containing hydrogen has led to the inven-

tion of the term "hydrogen bond."

The manner in which these dimers break up into monomers offers an interesting problem in kinetics which can be studied by means of the infrared absorption spectrum. Acetic acid vapor at 19 mm. was examined¹³ from 1μ to 10μ in an eight centimeter cell at 25° and at 172° . Several bands appear in this region and five fundamental frequencies were found corresponding to five fundamental modes of vibration.

On heating to 172° where the dissociation into simple molecules is practically complete there is little change in the position of three of the bands but in two of the bands there is a definite shift. The band at $1,789\text{ cm.}^{-1}$ is known to be associated with the C=O group in aldehydes, ketones, esters, acids, and related compounds. As shown in Fig. 38 it undergoes a marked shift to smaller frequencies when it occurs in the dimers or double molecules.

This large shift is certainly connected with the association or polymerization process. At 172° practically all the molecules exist as single molecules and at 25° they all exist as dimers. At intermediate temperatures where density measurements have proved that both forms exist in chemical equilibrium, there should be evidence of the existence of both bands. The doublet character of the graphs for 64° and 82° shows that both these bands are present and confirms the basic assumptions.

The formation of the dimer can be explained best on the basis of the formation of a monoplanar molecule with an eight-membered ring. Two molecules of acetic acid may be represented as follows.

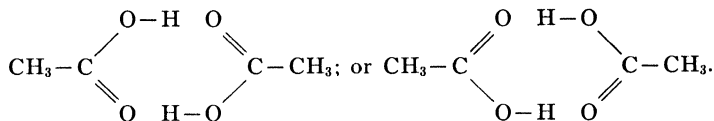

The electrons which constitute the bonds can move back and forth between these different positions so rapidly that a time average over even a millionth of a second or so will result in the following structure,

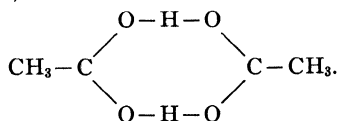

¹³ Gillette and Daniels, *J. Am. Chem. Soc.*, **58**, 1139 (1936).

This arrangement has been proposed before to account for the fact that hydrogen sometimes apparently must be thought of as having the properties usually associated with a divalent element. There are several cases in which hydrogen seems to behave in this way and a considerable literature on the "hydrogen bond" has appeared.^{14,15}

This oscillation of electrons between different bonds is known as resonance and molecules which contain such oscillating systems always have more energy of formation and are more stable. The benzene ring is an excellent example. This time-average ring in the case of the acetic dimers offers one possible explanation for the so-called hydrogen bond. From this point of view, the two molecules associate to form a ring structure because by so doing resonance can be brought into play and the energy of the system is decreased—i.e., a greater amount of energy must be applied in order to decompose or change the molecule.

The infrared absorption spectrum of associated acetic acid can be explained on the basis of this ring structure. The C-H and C-C vibrations will not be changed by the formation of the ring and all the vibrations in the ring will be similar because the hydrogen atoms are so light compared to carbon and oxygen atoms. However, this new dimer is symmetrical, and, as already pointed out, the individuality of a particular mode of vibration may be lost when the molecule becomes symmetrical. The nature of the vibration of the carbonyl group must be altered by making it part of an eight-membered ring and the change is reflected in the shift of the corresponding absorption band. The so-called hydrogen bonds then provide an opportunity for resonating electrons and the formation of more stable molecules, while the infrared bands shift not on account of the hydrogen but because the molecule tends to become symmetrical and another molecule is brought near.

THEORETICAL CONSIDERATIONS

Great progress has been made in understanding infrared spectra and in the contributions which they make to molecular structure but we shall have to confine ourselves to those fields which may have a possible bearing on chemical reactivity.

¹⁴ Latimer and Rodebush, *J. Am. Chem. Soc.*, **42**, 1419 (1920).

Sidgwick, *Chem. Soc. Ann. Rep.*, **30**, 115 (1934); **31**, 34 (1935).

¹⁵ Liddell and Wulf, *J. Am. Chem. Soc.*, **57**, 1464 (1935).

The various mechanical models and particularly the mechanically-agitated models of Andrews¹⁶ have been successful in reproducing the fundamental frequencies of the Raman spectra when the amplitudes are small—(perhaps ten per cent) and the oscillations are harmonic. This fact indicates that models and classical mechanics do give an approximately correct representation of the vibrational structure and behavior of the molecules. However, these small amplitudes may be connected with chemical reactivity only in an indirect manner. The calculations are based on hypothetical bonds which are perfectly elastic but in calculating heats of dissociation one has to assume that the forces holding the atoms together are not perfectly elastic and that there is a definite anharmonic factor which increases to have important influence at the higher harmonics—i.e., higher quantum states. Obviously it is the large amplitudes that are of interest in chemical reactions. As the energy increases, the amplitude increases to such a point that the restoring force which causes the harmonic oscillation is no longer operative and the atoms fly apart. Although it has been shown that the fundamental frequencies of given types of vibration of low amplitude are relatively independent of the nature of the rest of the molecules (except in symmetrical molecules) it is by no means certain that the energy of a given vibration type is independent of the degree of excitation of the other types of vibration present in the molecule when the amplitude is large and the motion is anharmonic.

The reason for the chemical inactivity of infrared radiation is apparent. Although chemical rupture of a molecule is brought about by the proper type of vibration excitation to extremely large amplitudes, the fundamental frequencies of infrared absorption and Raman spectra involve atomic displacements only to the first quantum states; and first harmonics involve displacements to the second quantum state. The first displacement of the carbon-hydrogen bond corresponds to 3.4μ , and nearly all other bands of general chemical interest would give fundamental vibrations at wave-lengths greater than this. These displacements fall far short of giving sufficient amplitude of vibration to bring about the chemical dissociation already described.

Speaking specifically of ethyl bromide, the energy of activation calculated from the temperature coefficient of the thermal dis-

¹⁶ Kettering, Shutts and Andrews, *Phys. Rev.*, **36**, 531 (1930).

sociation rate is 54,800 calories per mole. This energy of activation corresponds to a wave number of $19,300\text{ cm}^{-1}$ (in the green part of the visible spectrum) whereas the wave number of the fundamental frequency F_6 is only 770. In other words, it would take at least the 25th harmonic (perhaps the 30th or 40th with due allowance for an anharmonic factor) to provide sufficient energy to disrupt the molecule of ethyl bromide, assuming a similar mechanism of disruption for both the thermal and the photochemical dissociations. But, the first harmonics are much less intense than the fundamental, and the second harmonics are still much weaker.¹⁷ The absorption of any of the higher harmonics in the region of the 25th harmonic would be utterly negligible. For example, Ellis¹⁸ found it necessary to use a tube of liquid chloroform 4.5 meters long in order to detect even the sixth harmonic of the carbon-hydrogen fundamental.

In other words, no matter how great the radiation density, the fundamental frequencies cannot decompose the molecules because the energy of the quantum is not large enough; and a harmonic having sufficiently high frequency to give decomposition is not absorbed. Consequently it is unlikely that a molecule can be disrupted by radiation which acts only in causing the atoms to oscillate. The critical vibration of large amplitude (high-quantum states) leading to chemical dissociation must be effected in other ways—by violent collisions from thermal agitation or by electronic displacement from light absorption or by bombardment with electrons.

There is considerable support for the hypothesis that a molecule decomposes unimolecularly when a sufficient amount of energy becomes localized in a particular bond or mode of vibration.¹⁹ Knowing these various types of vibration as in the ethyl bromide molecule one is tempted to speculate as to which are the most likely ones to be involved in the chemical reaction. For example, if ethyl bromide decomposes to give a free ethyl radical and a bromine atom as the first step the action must occur by increasing the amplitude of vibration of the fundamental frequency F_7 to the point of rupture. On the other hand if the molecule disrupts into ethylene and hydrobromic acid in a single internal operation the fundamental frequency F_6 or F_8 must be involved. These latter

¹⁷ Pages 205 and 208.

¹⁸ Ellis, *Phys. Rev.*, **32**, 906 (1928).

¹⁹ Page 243.

frequencies involve bending vibrations which bring the bromine and hydrogen atoms closer together, and with sufficient amplitude, the close approach might well lead to a rearrangement of the forces within the molecule and result in the simultaneous, one-step formation of hydrobromic acid and ethylene. Of course there is nothing to prevent these two operations from going on at the same time—rupture into free radicals in one molecule and internal rearrangement in another molecule. Both processes require about the same amount of energy, approximately 55,000 calories.

It is going too far in simplification of the complicated mechanism of chemical reaction to suggest that, when the requisite amount of energy becomes localized in the bond which is to be broken (the C-Br bond for example), the atoms will separate but they can not do so in less time than half the time taken for a natural vibration period. Nevertheless the picture seems plausible as a first approximation and the numerical value of the time is of the right order of magnitude in many cases. For example, the number of half-vibrations per second for the C-Br stretching bond F_7 is 3×10^{12} ; and for the Br-H bending bond F_8 it is 5×10^{12} . The corresponding value of s in the equation $k = se^{-E/RT}$ as determined experimentally from the temperature coefficient of the reaction rate is 3×10^{14} . Accurate determinations of E are difficult, particularly at the higher temperatures and a small error in E makes a large error in s . It is possible that a more careful redetermination of E may bring s down more nearly to 5×10^{12} , but even if it did there is still much uncertainty in this simplified view of the mechanism. The experimental data now available would not permit an accurate enough determination of s to distinguish between F_7 and F_8 .

The direct significance of these fundamental frequencies in chemical reactions is speculative; the determinations of these values has more practical importance along two other lines. They are used together with other constants for calculating activation energies as shown in the next chapter, and they are used to determine the presence or absence of intermediate complexes or loose chemical compounds in solution. Combination of solute with the solvent can be determined by slight displacement of the low frequencies as revealed from infrared or Raman spectra and these facts will be of ultimate value in predicting reaction rates in solution.

CHAPTER IX

THEORETICAL CALCULATION OF ACTIVATION ENERGIES

THE PRACTICAL importance of the Arrhenius equation $k = se^{-E/RT}$ has been stressed in previous lectures. The quantities s and E depend only slightly on temperature, and within a factor of ten or so s can often be estimated as 10^{13} for unimolecular reactions; and 10^9 for bimolecular reactions, when concentrations are expressed in moles per liter. An estimation of E , then, permits a prediction of reaction rates at different temperatures.

Because the temperature variation of s is to be compared with the strong exponential variation of $e^{-E/RT}$ it is difficult to separate from experimental data the temperature dependence of s and E . For this reason it is a convenient working rule to assume that s is a constant. The activation energy E is then given by the slope of the line obtained by plotting $2.303 R \log k$ against $1/T$, as shown in Fig. 5. In most cases little error will be introduced by this simplification.

Many reactions follow neither the first order nor the second order equation but the evidence more and more seems to support the view that most reactions are fundamentally unimolecular or bimolecular and that the complex reactions which follow neither first order nor second order equations consist really of two or more simple reactions of the uni- or bimolecular type. Eventually, perhaps, these intermediate steps can be independently determined.

The important thing in predicting reaction rates is to determine the activation energy E of the reaction—or, in the case of composite reactions, to determine the activation energy of the slowest reaction step. Because the equation is of the exponential type, s need not be known very accurately and the quantity of limiting accuracy is E . It is the purpose of these next lectures to show how E can be estimated and how these estimates are useful

in chemistry. Most of the progress in this field is due to Eyring, whose imagination and courage in tackling difficult problems has led to rapid advances.¹

Chemical reaction usually involves the tearing apart of atoms in molecules and the formation of new molecules. Energy is absorbed in breaking old bonds and energy is evolved in forming new ones. When atoms leave one molecule to join another one they pass through a stage in which their distances to the two molecules are of the same order of magnitude, and the system can adjust in either way to give reactants or products. In this "activated state" the system has potential energy corresponding to the top of the activation hill of Fig. 4. The activation is produced when the two molecules collide violently bringing the electrons of the two molecules close together. The chemical change of partners could also be effected by first disrupting the molecules into atoms and driving them out to "infinite" distances before they recombine to form new molecules; but this procedure calls for a greater expenditure of energy. It is the object of these calculations to find how the atoms can rearrange to give the products with the least expenditure of energy. This minimum energy is the energy of activation.

Calculations are made on the basis of the internal energy of the system as a function of the positions of all the atoms, taking into account the mutual interactions between all the particles. Geometrical considerations are necessary for including all the interactions. The calculations involve the solution of the Schrödinger wave equations. These equations are very difficult to solve when the system involves many particles. Fortunately, there are a few simplifications which can be made. For example, the electrons are so light and move so rapidly with respect to the nuclei that it is a good approximation to calculate² the energy of the electrons, considering the nuclei as held fixed. This electronic energy then plays the role of the potential energy for the motion of the atoms. Once this electronic energy has been determined for all of the possible nuclear configurations, it is a simple matter to find the energetically easiest path of the reaction in going from the initial to the final molecular configuration. The activation energy is the maxi-

¹ Eyring and Polanyi, *Z. physik. Chem.*, **B12**, 279 (1931); Eyring, *J. Am. Chem. Soc.*, **53**, 2537 (1931); Eyring, *Chem. Rev.*, **10**, 103 (1932).

² Pelzer and Wigner, *Z. physik. Chem.*, **B15**, 445 (1932); Born and Oppenheimer, *Ann. Phys.*, **84**, 457 (1927).

mum height along this path. The determination of activation energies is thus reduced to the computation of electronic energy.

The problem would seem still hopeless if it were not for our chemical intuition which leads us to believe that only a very few atoms can play an important rôle in any chemical reaction. This viewpoint is substantiated by the fact that bond energies are additive in many normal molecules and thus there is real significance in resolving the electrons into chemical bonds. One of the important problems in quantum mechanics at the present time is the formulation of some sort of satisfactory approximation to the Schrödinger equation which preserves the chemical identity of localized electron bonds. London³ developed such an approximation but his derivation has been shown subsequently to contain unwarranted assumptions⁴ for atomic configurations in the neighborhood of the activated state. Eyring¹ used the London formula as the basis of an interpolation scheme for obtaining the energy for a complicated molecular system from a knowledge of the energy of simple diatomic molecules. His formula is rigorous when some of the atoms are far apart, is consistent with most of the quantum mechanical tenets, and agrees with many of the facts which chemists have proven in the laboratory. Its further justification depends on its ability to predict activation energies. Up to the present time, this semi-empirical scheme has been singularly successful and therefore is worthy of careful scrutiny. Unfortunately this method does not lend itself readily to the ionic or heteropolar linkages.

The fundamental problem in all these calculations may be stated very simply: "How can the atoms leave the reactants and form the products with the least possible expenditure of energy and how large is this minimum energy of activation?" The fundamental quantum mechanical calculations involve the relation between the interatomic distances and the energy of the system. From this relation the reaction rate can be calculated with the help of statistical mechanics.

ENERGY AND INTERATOMIC DISTANCE

An important concept in theoretical chemistry is illustrated in the potential energy curves of Fig. 39. The energy of two atoms

³ London, *Z. Phys.*, **46**, 455 (1928).

⁴ Coolidge and James, *J. Chem. Phys.*, **2**, 811 (1934); Hirschfelder, Eyring, and Rosen, *J. Chem. Phys.*, **4**, 121 (1936).

varies with the distance separating them. There is a definite equilibrium distance between the atoms for maximum stability⁵—when stretched to greater distances the atoms attract each other, and when forced together they repel. By plotting the potential energy of the system against the interatomic distance, curves with minima are always obtained for stable molecules. Two specific illustrations are given—one for the diatomic bromine molecule and one for the carbon-carbon pair in organic compounds. They will both be used later in quantitative calculations.

As the atoms of a given system get farther and farther apart the energy of attraction is lessened and as the distance approaches infinity the energy content approaches asymptotically a definite value. This energy of the system, when the atoms are at an infinite distance apart, is arbitrarily taken as zero. The difference between this energy and the energy at the minimum is the energy required to completely disrupt the stable molecule into normal atoms—i.e., the heat of dissociation (except for the zero point energy).

The significance of this type of curve in chemical problems and in photochemistry was stressed by Franck.⁶ The curve is also of great importance in calculating specific heats and thermodynamic quantities. We are interested in it here because it is essential in the semi-empirical calculation of activation energies.

The shape of the curve between the minimum point and the horizontal level is a matter of importance. It can be calculated from a full knowledge of quantum numbers and infrared vibration frequencies. The latter, however, are difficult to sift out from a complex spectrum and it is sometimes easier to build up the curve from the constants obtained from a complete analysis of the band spectrum. Except in the simplest cases, such as in diatomic molecules, these methods of calculation are as yet too difficult. The empirical equation of Morse⁷ has been of great value in constructing these energy functions known as "Morse curves." Where it is possible to check them with direct data the agreement is good except where r is very large and then the data are comparatively unimportant for these calculations. It is convenient to use them in the semi-empirical calculation of activation energies. The equation from which all these Morse curves are calculated is

⁵ This discussion is not intended to cover van der Waals' forces.

⁶ Franck, *Z. Physik*, **31**, 411 (1925).

⁷ Morse, *Phys. Rev.*, **34**, 57 (1929).

$$E = D'(e^{-2a(r-r_0)} - 2e^{-a(r-r_0)}). \quad (1)$$

where E is energy, D' is a modified heat of dissociation, a is constant, r is the interatomic distance and r_0 is the normal distance. It is an empirical equation of such a nature that it gives a stable, minimum energy for one interatomic distance, and it gives zero energy when the atoms are separated by infinite distance, and large energies when they are close together. The calculation of E at various distances is comparatively simple. Three quantities are necessary. First, the interatomic distance r_0 in the stable molecule is obtained from X-ray data or measurements of infrared absorp-

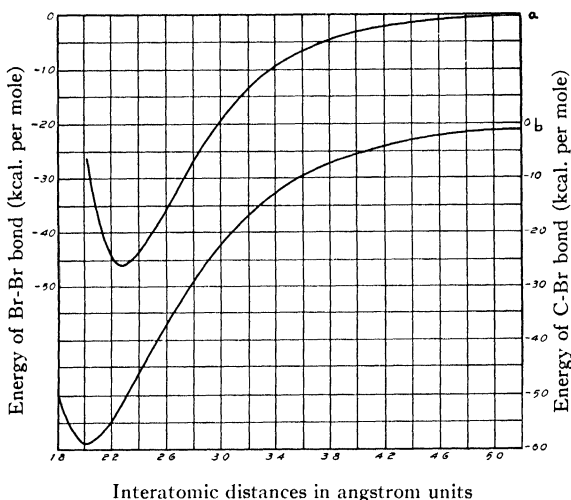

FIG. 39.—Morse curves. (a) for Br-Br; (b) for C-Br.

tion of electron diffraction or crystal structure. Secondly, the fundamental vibration frequency of the atoms in the molecule ω_0 is obtained from infrared absorption spectra, from Raman spectra or from the complete analysis of band spectra. Thirdly, the energy D of complete dissociation into atoms is obtained from thermochemical measurements or from band spectroscopy.

The operation of equation (1) will be illustrated in some detail by calculating the Morse curve for bromine shown in Fig. 39 (a). For bromine, r_0 is 2.28 Å; D is 45.23 kcal.; and ω_0 is 323.86 cm.^{-1} .

The minimum potential energy D' used in the formula is greater than D , the ordinary heat of dissociation, by a small quantity called the "zero point energy" which is equal to $h\omega_0/2$. This zero point energy is the least amount of vibrational energy which the molecule can have. Here the atoms are undergoing vibration but they are still in the lowest, unexcited state. Then

$$D' = D + h\omega_0/2 = D + \frac{1}{2} \frac{\omega_0}{352} \quad (2)$$

The factor 352 is a useful conversion factor which absorbs Planck's constant h and gives energies directly in kilogram calories, when frequencies ω are expressed in wave-numbers (reciprocals of wave lengths expressed in cms.).

$$\text{For bromine } D' = D + \frac{1}{2} \cdot \frac{323.86}{352} = 45.23 + 0.46 = 45.69 \text{ kilocalories.}$$

The constant a for the diatomic bromine molecule is 1.98. It is defined as follows

$$a = 0.1227\omega_0 \sqrt{\frac{\mu}{D'}} \quad (3)$$

where 0.1227 is a general constant and μ is the reduced mass of the pair of atoms—i.e., $\mu = \frac{M_1 M_2}{M_1 + M_2}$ where M_1 and M_2 are the two atomic weights. In Br_2 the reduced mass is simply $79.92/2$ and

$$a = 0.1227 \times 323.86 \sqrt{\frac{79.92/2}{45.69}} = 1.98. \quad (4)$$

Table I is calculated by putting these values for a , r_0 and D' into equation (1). Figure 39 (a) is plotted directly from the first and last columns.

In Table II are given the three fundamental constants for a number of atom pairs which are of interest in chemical kinetics. From these constants Morse curves can be constructed as just shown for bromine, and these, in turn, are necessary for the calculation of activation energies of chemical reactions.

TABLE I
 CALCULATIONS OF THE MORSE CURVE FOR BROMINE
 Applying equation (1) where, $D' = 45.69$, $a = 1.98$ and $r_0 = 2.28$.

r	$r - r_0$	$\frac{E}{D'}$ *	E
1.61	-0.47	1.286	58.7
2.05	-0.23	0.658	30.1
2.28	0.0	-1.000	-45.69
2.40	0.12	-0.958	-43.75
2.51	0.23	-0.864	-39.5
2.63	0.35	-0.751	-34.3
2.75	0.47	-0.638	-29.2
2.86	0.58	-0.532	-24.3
2.98	0.70	-0.439	-20.1
3.21	0.93	-0.292	-13.35
3.44	1.16	-0.190	-8.67
3.79	1.51	-0.0999	-4.57
4.14	1.86	-0.0496	-2.27
4.49	2.21	-0.0250	-1.14
5.07	2.79	-0.00796	-0.36
5.77	3.49	-0.00200	-0.091

* By equation (1), $\frac{E}{D'} = (e^{-2 \times 1.98(r-r_0)} - 2e^{-1.98(r-r_0)})$.

TABLE II
 FUNDAMENTAL CONSTANTS FOR CALCULATING MORSE CURVES WHICH GIVE THE
 ENERGY OF ATOM PAIRS AS A FUNCTION OF THE DISTANCE SEPARATING THEM

Atom Pair	r_0 Normal interatomic distance. (Å)	ω_0 Fundamental vibration frequency. (cm. ⁻¹)	D Energy of dissociation. (kilogram calories)
C-C	1.54	990	77
C=C	1.38	1600	122
C≡C	1.21	1960	200
C-H	1.12	2930	92
C-I	2.10	497	44
C-Br	2.06	560	58
C-Cl	1.85	660	79
H-H	0.74	4375	102
H-I	1.62	2233	66
H-Br	1.42	2603	85
H-Cl	1.28	2840	100
(H-Cl) ⁺	1.31	2680	84
I-I	2.66	213	35
Br-Br	2.28	323	45
Cl-Cl	1.85	660	79
I-Cl	2.31	384	50
Li-H	1.6	1406	57
N-H	1.06	3270	96

TABLE II—Continued

Atom Pair	r_0 Normal interatomic distance. (Å)	ω_0 Fundamental vibration frequency. (cm. ⁻¹)	D Energy of dissociation. (kilogram calories)
N—N	1.40	1094	33
NO	1.15	1906	140
N—O	1.36	1191	38
N=O	1.22	1892	168
CN	1.47	1040	66
C=N	1.32	1303	132
O ₂	1.20	1580	117
O—O	1.32	1304	34
OH	0.97	3660	113
C—O	1.43	1030	82
C=O	1.28	1720	188
C≡O	1.15	2160	230

THE SEMI-EMPIRICAL METHOD.
THE BROMINATION OF ETHYLENE

These quantum calculations of activation energies will be illustrated in some detail with a simple case that has been the object of investigation in our laboratory, namely the addition of bromine to the double bond in unsaturated organic compounds. Referring to Fig. 40 as a topographical map it is seen that the two bromine atoms in the form of a bromine molecule are at the bottom of the map and that they approach the two carbon atoms by moving "northward." The stable position of bromine in the final product is given by the circular lines drawn with a radius of 2.06 Å in these curved valleys. X-ray and other experimental facts show that this is the normal distance between carbon and bromine atoms in the product. Anywhere along this radius the bromine atoms will be in a position of maximum stability with reference to the carbon atoms.

The figure really represents a three dimensional map with distance between carbon and bromine, r_{C-Br} , plotted north and south, distance between bromine and bromine, r_{Br-Br} , plotted east and west and energy of the system plotted at right angles to the plane. Contour lines of definite energies are projected down onto the plane of the map. The two atoms of bromine are just alike, as are also the two atoms of carbon. Accordingly it is sufficient to trace the course of only one bromine and one carbon atom. An

enlarged map of the region near the activation "pass" is given at the left.

The bromine atoms move north along the bottom of deep valleys of energy contours (only one is shown on the map). The cross

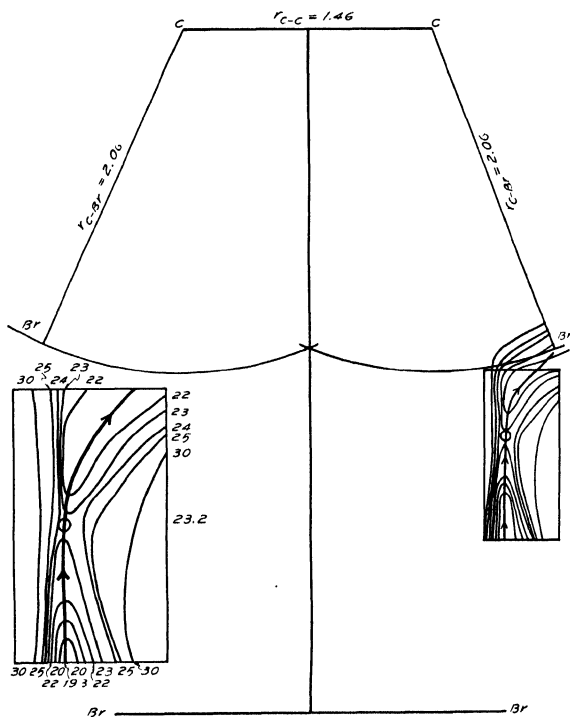

FIG. 40.—Energy contour-map of system for the addition of a bromine molecule to the carbon-carbon double bond. The north and south axis refers to the distance between Br-Br and C-C. The east-west axis refers to the distance between bromine atoms. Contour lines are projections of energy plotted at right angles to the plane.

section of the valleys is given by the Morse curve for Br-Br shown in Fig. 39 (a). These valleys are represented as running north and south but they could just as well run at an angle or they could be curved. The minimum energy of the change is being sought and the straight-line approach to the reacting atoms is the

route of least energy expenditure, and accordingly all other possible approaches can be neglected. There is another energy valley with its lowest points along the arc of the circle around the carbon atom. A cross-section of this valley is given by the Morse curve for the C-Br bond shown in Fig. 39 (b). Now if the bromine atom moves from its original valley running north and south into the valley which curves around the carbon atom it will do so with the least possible energy. In other words in going over the mountain separating the two valleys it will do so by the lowest possible mountain pass. One way of getting from the first valley to the second consists in climbing completely out of the valley onto a level plateau corresponding to the flat part of the Morse curve of Fig. 39 (a). But there should be an easier way of getting over into the second valley. When the bromine molecule comes close to the pair of carbon atoms, calculations by perturbation theory of all the energies at all different positions along the north-south and east-west axes show that a lower pass exists.

If the bromine atoms change valleys by going over the high plateau the energy of activation for the process is equal at least to the energy required to break the Br-Br bond, i.e., the heat of dissociation into atoms. Although energy will be liberated when the bromine atoms attach themselves to the carbon atoms and form C-Br bonds there is no simple way by which this energy can be utilized to lessen the height to which the atoms must go. The energy of activation corresponds to the difference in energy between the floor of the valley of the original compound and the energy pass over which the atom must go. The difference in energy level between the two valley floors corresponds to the heat of reaction and it tells nothing of the height of the mountain pass separating the two. The situation is really a three dimensional visualization of the concepts discussed on page 17.

The impelling force in these excursions of atoms up the valley sides is molecular collision. Collisions impart energy to the bromine molecules and to the molecule containing the two carbon atoms and permit them to rise to the top of the pass. In most cases the collisions are not violent enough to carry them to the top of the pass and they fall back to the valley floors. Even when a bromine atom gets to the top of the pass it can fall either way and become part of either a stable C-Br compound or a stable Br-Br molecule. At this particular position at the top of the pass

the bromine atom belongs as much to the Br-Br valley as to the C-Br valley and the C-C-Br-Br system exists as an activated complex.

The numerical calculation of the energy of activation, equivalent to the height of the mountain pass, will be considered next. For this purpose it is helpful to use Fig. 41 in which all the various forces of attraction between all the atoms are indicated. Only the binding electrons are involved in the calculation—one for each atom. The problem being solved here is a four electron problem. The Roman letters refer to coulombic or electrostatic binding and Greek letters to exchange binding. The former is assumed to be fourteen per cent and the latter eighty-six per cent of the total. This seems to give the best results when the zero point energy of the activated complex is neglected. For example, the energy J of one C-Br homopolar bond (a pair of electrons) is given by the relation

$$\begin{aligned} J_{ac} = J_{bd} &= \text{coulombic energy} + \text{exchange energy} \\ &= 0.14(A + \alpha) + 0.86(A + \alpha) \end{aligned} \quad (5)$$

where A and α are defined as shown in Fig. 41.

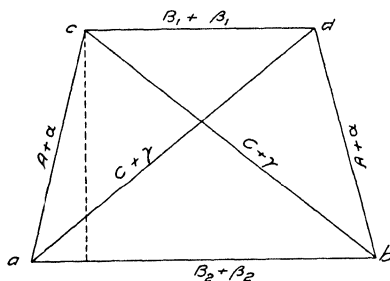

FIG. 41.—Diagram for calculating potential energies for the addition of a bromine molecule to a carbon-carbon double bond. Roman letters refer to coulombic or electrostatic exchange. Greek letters refer to attraction or exchange energy calculated on the basis of the semi-empirical method.

The angles of the polygon are not significant since the lines are drawn at random except that ab , and cd are parallel and symmetrical with respect to a center line. Any other arrangement would lead to greater energies. For the same reason a , b , c , and d all lie in a plane. The two attractions—electrostatic and exchange—between all possible arrangements of atoms taken two at a time are then calculated for various distances of Br-Br and C-Br. The two independent variables are r_1 and r_2 where r_1 is defined as

the distance separating the Br-Br and C-C pairs and r_2 is defined as

half the distance separating the two bromine atoms. Then the other distances can be calculated. For example by taking hypotenuses of right triangles, where $r_{ab} = 2r_2$ and $r_{cd} = 1.46$,

$$r_{ac} = \sqrt{r_1^2 + (1/2r_{ab} - 1/2r_{cd})^2}. \quad (6)$$

In the present problem the carbon-carbon pair starts out as a double bond having a normal interatomic distance of 1.38 Å and after bromination it exists as a single bond having a normal distance of 1.54 Å. The differences are not great and they will have little effect on the calculations of energies. Accordingly the average of the two, namely 1.46 Å, is taken throughout the calculations.

Then
$$r_{ac} = \sqrt{r_1^2 + (r_2 - 0.73)^2} \quad (7)$$

and
$$r_{ad} = r_{bc} = \sqrt{r_1^2 + (r_2 + 0.73)^2}. \quad (8)$$

Now in the general case the total potential energy J is given by the expression

$$J = Q + K = \text{coulombic energy} + \text{exchange energy}. \quad (9)$$

$$\begin{aligned} J &= (A + A + B_1 + B_2 + C + C) \\ &+ \sqrt{1/2(\alpha_1 + \alpha_2 - \beta_1 - \beta_2)^2 + (\alpha_1 + \alpha_2 - \gamma_1 - \gamma_2)^2 + (\beta_1 + \beta_2 - \gamma_1 - \gamma_2)^2} \\ &= 0.14(2(A + \alpha) + (B_1 + \beta_1) + (B_2 + \beta_2) + 2(C + \gamma)) \\ &+ \frac{0.86}{\sqrt{2}} \sqrt{[2(A + \alpha) - (B_1 + \beta_1) - (B_2 + \beta_2)]^2} \\ &+ \sqrt{[2(A + \alpha) - 2(C + \gamma)]^2 + [B_1 + \beta_1 + B_2 + \beta_2 - 2(C + \gamma)]^2}. \quad (10) \end{aligned}$$

With this formula one can build up the energy contour map of Fig. 41. As the two molecules C-C and Br-Br approach each other along the north-south line, which is the line of least energy, r_1 varies, and the potential energy changes. The energy of the system changes also as r_2 (half the distance between the bromine atoms in Br-Br) is changed along the east-west line.

A definite value is given to r_2 , and r_1 is varied over a range of values. Then by simple trigonometry all the possible straight line distances between atoms are calculated as already shown. There are six of these, four joining the four atoms in the polygon, and the two diagonals. The cd distance, 1.46, is taken as the average before and after bromination and so this value remains fixed. The

TABLE II
ILLUSTRATION OF THE CALCULATION OF ACTIVATION ENERGIES.

$$\begin{array}{c} \diagup \\ \text{C}=\text{C} \\ \diagdown \end{array} + \text{Br}-\text{Br} \rightarrow \begin{array}{c} \diagup \\ \text{C}-\text{C} \\ \diagdown \end{array} \begin{array}{c} \text{Br} \\ | \\ \text{Br} \end{array}$$

r_2	r_1	r_{ab}	r_{ac}	r_{ad}	$A+\alpha$	$B_2+\beta_2$	$C+\gamma$	Σ	$-K$	$-Q$	$-J$	E
1.04	3.0	2.08	3.02	3.49	21.7	33.8	11.2	8325	55.4	22.5	77.9	28.3
1.04	2.8	2.08	2.82	3.31	28.3	33.8	14.4	6588	49.3	25.3	74.6	31.6
1.04	2.6	2.08	2.62	3.14	36.2	33.8	18.4	5133	43.6	28.6	72.2	34.0
1.04	2.4	2.08	2.42	2.97	45.4	33.8	23.2	4346	40.2	32.5	72.7	33.5
1.14	3.0	2.28	3.03	3.54	21.4	45.7	10.5	11900	67.2	23.9	91.1	15.1
1.14	2.8	2.28	2.83	3.37	28.0	45.7	13.3	9850	60.3	26.6	86.9	19.3
1.14	2.6	2.28	2.63	3.20	35.3	45.7	17.0	7931	54.2	29.7	83.9	22.3
1.14	2.4	2.28	2.44	3.04	44.6	45.7	21.1	6675	49.7	33.3	83.0	23.2
1.14	2.2	2.28	2.24	2.89	53.3	45.7	25.8	6061	47.5	37.1	84.6	21.6
1.25	3.0	2.50	3.05	3.59	20.8	39.8	9.6	10666	62.8	22.6	85.4	20.8
1.25	2.8	2.50	2.85	3.43	27.2	39.8	12.2	8890	57.5	25.1	82.6	23.6
1.25	2.6	2.50	2.65	3.27	34.9	39.8	15.3	7426	52.5	28.2	80.7	25.5
1.25	2.4	2.50	2.46	3.11	43.6	39.8	19.2	6460	49.0	31.7	80.7	25.5
1.25	2.2	2.50	2.26	2.96	52.3	39.8	23.2	6360	48.5	35.2	83.7	22.5
1.25	2.0	2.50	2.06	2.81	58.1	39.8	28.7	5578	45.5	38.4	83.9	22.3
1.35	3.0	2.70	3.06	3.65	20.5	31.3	8.8	8760	57.0	21.1	78.1	28.1
1.35	2.8	2.70	2.87	3.49	26.5	31.3	11.2	7366	52.3	23.5	75.8	30.4
1.35	2.6	2.70	2.68	3.33	33.7	31.3	14.0	6306	48.3	26.3	74.6	31.6
1.35	2.4	2.70	2.48	3.17	42.7	31.3	17.7	5786	46.3	29.9	76.2	30.0

distance ac is equal to the distance bd since the system is symmetrical; and the distance ad is equal to the distance bc . The three distances ab , ac and ad are sufficient to define the system portrayed in Fig. 41 and these are easily obtained for any values of r_1 and r_2 corresponding to any position of the bromine atoms on the map given in Fig. 40.

The complete operation of filling in the terms of equation (10) is illustrated in Table II.

In the next to the last column the potential energy J of the system is given for various places on the map shown in Fig. 40. Values of J can be calculated in the same way for any position of the atoms but for the problems of chemical kinetics we are interested only in the lowest pass between the two valleys and most of the map is unnecessary. With a little experience one learns how to select only the important calculations in the neighborhood of the pass. In the example given here the many contour lines are given merely for more complete visualization of the method.

In the calculations summarized in this table

$$\Sigma = [2(A + \alpha) - (B_1 + \beta_1) - (B_2 + \beta_2)]^2 \\ + [2(A + \alpha) - 2(C + \gamma)]^2 + [B_1 + \beta_1 + B_2 + \beta_2 - 2(C + \gamma)]^2$$

$$K = \frac{.86}{\sqrt{2}} \sqrt{\Sigma}$$

$$Q = 0.14 [2(A + \alpha) + (B_1 + \beta_1) + (B_2 + \beta_2) + 2(C + \gamma)]$$

$$J = Q + K$$

$$E = (D_{\text{Br-Br}} + D_{\text{C-C}}) - J = 106.2 - J$$

$$r_{cd} = 1.46 = \text{constant} \quad B_1 + \beta_1 = 61.0 = \text{constant}$$

$$r_1 = \text{distance between Br-Br and C-C}$$

$$r_2 = 1/2 \text{ distance between bromine atoms}$$

$$r_{ac} = \sqrt{r_1^2 + (1/2r_{ab} - 1/2r_{cd})^2} = \sqrt{r_1^2 + (r_2 - 0.73)^2}$$

$$r_{bc} = \sqrt{r_1^2 + (r_2 + 0.73)^2}$$

Most of the terms in equation (10) and Table I will be understood except for the combination of attractions and repulsion between atoms that goes to make up Σ . This term arises from the Pauli exclusion principle, the Schrödinger equation and the Slater

wave function. The solution comes from perturbation theory with the help of determinants. The details cannot be given here.⁸

The values of J give the potential energy of the four atom system referred to the four atoms completely separated in space as zero energy. But we are interested in the energy referred to the stable C=C and Br-Br compounds as zero (corresponding to the valley floors rather than to the high plateaus). Accordingly it is necessary to subtract these values of J from the total energy D required to break both the C-C bond and the Br-Br bond. It requires 45.2 kilocalories to separate the two bromine atoms and 61 kilocalories to separate the carbon atoms from an average position. Then D has a value of 106.2 kilocalories. The $(106.2 - J)$ gives the energy E which is required to separate Br-Br and C=C sufficiently to give the activated state. The energy E is then plotted and represented in Fig. 40 by contours. The value of E at the lowest pass between the two valleys is defined as the energy of activation.

In making the contour map of Fig. 40 the values of E in the last column are plotted against values of r_1 and r_2 . Lines are then drawn at constant values of E (20, 21, 22, 23, etc., kilocalories) and from them the lowest pass between the valleys is ascertained. It comes at the point where $r_1 = 1.14$ and $r_2 = 2.40$ and it has a value of 23,200 calories. This is the energy of activation E which when put into the Arrhenius equation will give an approximate estimate of the specific rate constant k .

CHEMICAL APPLICATIONS

It has been emphasized that these calculations of activation energies are only approximate, commonly involving an error of 3,000 calories or more. Frequently the data for the constants D , r_0 and ω_0 are not known with accuracy and the assumption of the fourteen per cent coulombic energy and the plotting of the empirical Morse curves are subject to considerable uncertainty. In some cases the calculations are quite tedious but frequently some type of symmetry greatly reduces the labor of computations and after some experience one finds it sufficient to select for computation only a limited number of points in the neighborhood of the

⁸ Dushman, Elements of the Quantum Theory, *J. Chem. Education*, **12**, 217 (1935) to **13**, 385 (1936).

Pauling and Wilson, *Introduction to Quantum Mechanics with Applications to Chemistry*, McGraw-Hill Book Co., New York (1935).

activated state. In spite of the approximate nature of the results and the labor of computation, these estimates of activation energies have been of considerable help to chemical kinetics. Even though they are⁹ without sufficient theoretical foundation the results which they have accomplished seem to establish them as useful.

These calculations are particularly valuable in calculating *relative* rates of reactions or comparing similar reactions. In such cases some errors in the calculations may be the same in all the reactions and accordingly they cancel out. Again they are very helpful in ruling out of consideration reactions that are too slow or too fast to be measured. Just an estimate of the order of magnitude of the reaction rate may often be sufficient. In deciding between different mechanisms and hypothetical intermediate steps this method of calculation is invaluable for it is often the only possible means of attack. The short-lived compounds of a fleeting intermediate step usually can not be isolated nor measured by any physical or chemical means.

The use of these methods of calculations can be shown best with a few specific reactions.

According to one theory of the photobromination of cinnamic acid an intermediate compound Br_3 is involved as one link in the propagation of a chain.¹⁰ Semi-empirical calculations show¹¹ that Br_3 can exist although its life is very short. However, it is clearly shown that Br_3 would add to a double bond more slowly than Br_2 ; thus there is nothing to be gained by postulating Br_3 in a chain mechanism. It can be shown in general, that the energy of activation is least when one breaks and forms the minimum number of bonds.

The kinetics of halogenation has been the object of special study. Calculations showed that the addition of iodine to a double bond should proceed nearly as rapidly as the addition of bromine. It is known that under ordinary conditions, iodine will not add to unsaturated compounds, but that in many cases bromine will.

Since the laboratory facts do not check the calculations, the addition of halogens may involve a more complicated reaction, which is different in the case of iodine than in the case of bromine. Here then is an interesting hypothesis to stimulate further experi-

⁹ Coolidge and James, *J. Chem. Phys.*, **2**, 811 (1934).

¹⁰ Page 162.

¹¹ Sherman and Sun, *J. Am. Chem. Soc.*, **56**, 1096 (1934).

mental work. Perhaps a chain reaction is possible for bromine but not for iodine; perhaps there is a reverse reaction which takes the iodine out again; perhaps dissolved oxygen or moisture or daylight affect the velocity of the addition of bromine more than iodine. If one or more of these factors proves to be important we will have learned more about the actual mechanism of the reaction. The problem is still being investigated but up to the present time it has not been solved.

A complete analysis has just been made¹² showing all the reactions which can take place between ethylene and the halogen molecules and their products. The various possibilities are summarized in the diagram which follows:

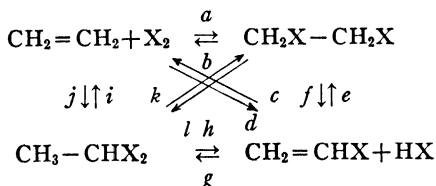

Twelve different reactions, *a-l* are considered and the energies of activation have been calculated for each. Uni- and bimolecular as well as chain mechanisms have been considered for each reaction. Only the three reactions *a*, *c* and *j* will be reviewed here.

The activation energy for the bimolecular reaction

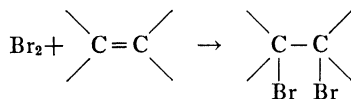

has been calculated in detail on page 234 and shown to have a value of 23,200 calories for Br_2 .

The same reaction can proceed, however, by an atom chain reaction as follows:

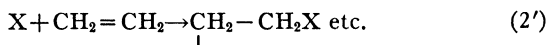
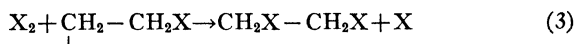
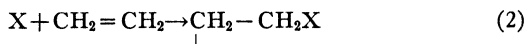

¹² Sherman, Sutherland, and Quimby, *J. Chem. Phys.*, **4**, 732 (1936).

The halogen atom consumed in (2) is regenerated in (3) and so the chain is continued. It can be shown¹³ that for this mechanism the over-all activation energy is equal to the activation energy of reaction (2) plus half the heat of dissociation D of the halogen molecule as given by reaction (1) and amounts in this case to 22,600 calories. Thus it appears that an atom-catalyzed chain is about as probable as a bimolecular addition of bromine to ethylene.

Table IV summarizes the data for the three halogens reacting according to the four different reactions to give the symmetrical dihalide (a), the unsymmetrical dihalide (j), and the substitution reaction to give the halogen acid and the vinyl halide (c), and the decomposition of the dihalide (b).

TABLE IV

Reaction	E Bimolecular	E Atom Chain
a		
Cl	25.2	28.3
Br	23.2	22.6
I	22.4	20.5
b		
Cl	80.4	57.0
Br	50.2	37.7
I	30.0	28.1
c		
Cl	45.0	43.4
Br	47.0	46.0
I	54.0	51.2
j		
Cl		50.0
Br		50.0
I		50.0

It can be concluded from these calculations that the addition of halogen to a double bond to form the symmetrical dihalide (a) is much easier than the substitution reaction (c). The former requires activation energies of the order of 25,000 calories while the latter requires energies of the order of 50,000 calories. The reaction rate (a) is approximately the same, as already discussed for all the halogens, chlorine, bromine, and iodine. It is evident that the activation energies are approximately the same for the atom-catalyzed chain reaction and for the bimolecular reaction. Ap-

¹³ Reference 12, page 733.

parently in all these reactions it may be expected that the products will be formed by two independent mechanisms operating simultaneously. The case was found to be different for the decomposition of the ethylene halides by reaction (b). Only for iodine can this reaction proceed equally well by the atom catalyzed chain mechanism or by the bimolecular reaction. For chlorine the reaction proceeds entirely by the atom chain because the energy of activation is only about 57,000 whereas 80,400 calories is required for the bimolecular mechanism. The reaction with bromine is intermediate, slight preference being given for the atom chain although both mechanisms are probable.

An example of the use of these methods in deciding between different mechanisms can be taken from the recent literature.¹⁴

In an experimental study of the action of hydrogen on iodine chloride at 220° the following reactions were suggested:¹⁵

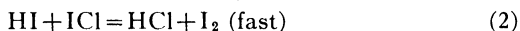
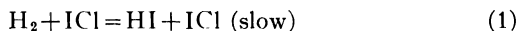

Calculations similar to those just given showed that the activation energies of (1) was 39 kcal. as compared with an experimental value of 33.9 kcal. The agreement is fair, about all that can be expected at present for absolute values. But reaction (2) is calculated by the same methods to have an activation energy of 41 cal. The reaction as written then can not be fast in comparison with reaction (1). However, reaction (2) may be written as an atom-catalyzed chain, thus

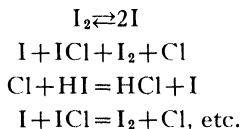

having an over-all activation energy of 34.2 kcal. This mechanism for reaction (2) is then much more likely and it will be fast in comparison with reaction (1)—130 times as fast. The reactions proposed by the authors then are quite plausible if one assumes that reaction (2) is complex. Although the prediction of absolute rates is not very accurate the calculation of relative rates seems satisfactory. Uncertainties such as the heats of dissociation of the atom

¹⁴ Sherman and Li, *J. Am. Chem. Soc.*, **58**, 690 (1936).

¹⁵ Bonner, Gore and Yost, *J. Am. Chem. Soc.*, **57**, 2723 (1936).

pairs would be the same in both cases and any inaccuracy would tend to cancel out.

Still another application of these calculations is concerned with resonance energy. When the structure of a molecule is such that electrons can be placed equally well in two or more bonds they will oscillate rapidly from one to the other. Such a molecule is said to possess resonance and by virtue of this resonance energy it becomes more stable. It must be emphasized that in these discussions the electrons move but the atoms remain stationary, as distinguished from tautomerism in which the atoms exchange positions. Systems of conjugated double bonds, including the benzene ring, give good examples of the importance of this resonance energy. An example was given on page 215. A further example in kinetics¹⁶ explains quantitatively why bromine adds more slowly to the carbon double bond when a carboxyl group is substituted for a hydrogen on a carbon atom adjacent to a double bond.

THE STATISTICAL MECHANICAL METHOD

The theoretical calculation of reaction rates has received new impetus from the mathematical treatment of the "activated complex" or the "transition state" through which the reacting molecules must pass in order to react. The present formulation is an outgrowth of the work of Pelzer and Wigner¹⁷ who made the first purely statistical calculation of the rate of a chemical reaction, i.e., the ortho-para hydrogen conversion. Eyring developed the complete statistical mechanical formulation of absolute reaction rates.¹⁸ It is closely related to the Brönsted theory¹⁹ of reactions in solution, to the concepts of entropy of activation long stressed by Rodebush²⁰ and to the entropy and temperature effect on the energy of activation suggested by LaMer.²¹

Eyring's treatment has been particularly successful in calculating reaction rates because it makes use of the Maxwell-Boltzmann distribution of velocities in determining the rate of decomposition of the group of atoms which constitutes the so-called activated complex. Only a suggestion of the methods can be given

¹⁶ Sun, *J. Chinese Chem. Soc.*, **4**, 1 (1936).

¹⁷ Pelzer and Wigner, *Loc. cit.*

¹⁸ Eyring, *J. Chem. Phys.*, **3**, 107 (1935); *Chem. Rev.*, **17**, 65 (1935).

¹⁹ Page 110.

²⁰ Rodebush, *J. Am. Chem. Soc.*, **45**, 606 (1923); *J. Chem. Phys.*, **1**, 440 (1933); **4**, 744 (1936).

²¹ LaMer, *J. Chem. Phys.*, **1**, 289 (1933).

here and the original articles must be referred to for details. However, it may be stated that the theory has already justified itself by explaining the behavior of termolecular reactions with their negative temperature coefficients,²² and by showing that the Arrhenius theory, which assumes an energy of activation independent of temperature, is but a special case of the general theory. It holds promise for correlating satisfactorily the reactions in gas phase and solution but of particular importance is the fact that in the expression

$$k = se^{-E/RT}$$

it is now possible to calculate s by statistical mechanics and to calculate E empirically as on page 227 and thus estimate reaction rates entirely from a few fundamental constants. The calculation is possible even for complicated molecules, the development being similar to that in the calculation of equilibrium constants from statistical mechanics and the data of spectroscopy. The theoretical calculation of E , however, is limited at present to rather simple molecules.

It is convenient to think of the reactions as following a scheme such as the following



This is the same as Brönsted's theory which was designed particularly for solutions. The concentration of the activated complex can be expressed in terms of the reactants and the equilibrium constant K . Also the heat of the reaction, ΔH , to give the activated complex, can be calculated approximately from the quantum theory or from the Arrhenius theory. Since $\Delta F = -RT \ln K$ and $\Delta F = \Delta H - T\Delta S$, and since K can, in some cases, be calculated from known, fundamental constants, the entropy term remains the only unknown. Rodebush has long pointed out that the unknown quantity s in the formula $k = se^{-E/RT}$ is related to an entropy term. As a first approximation it has been related to a collision frequency in bimolecular reactions and to a vibration frequency in unimolecular reactions. Combining the two thermodynamic equations²³

$$K = e^{\Delta S/R} e^{-\Delta H/RT}.$$

²² Gershinowitz and Eyring, *J. Am. Chem. Soc.*, **57**, 985 (1935).

²³ Page 105.

Rodebush points out that at low frequencies where $h\nu \ll k'T$, k' being the gas constant per molecule,

$$k = \nu e^{-E/RT}$$

which is an equation first emphasized by Dushman;²⁴ and at higher frequencies $s = k'T/h$ and is of the order of 10^{13} , a value which is found in many unimolecular reactions. The Eyring theory has shown that this is approximately correct in many cases. The factor which is neglected is of the order of unity if there are the same number of degrees of rotational freedom in the activated complex as in the initial molecule and if the reaction does not involve abrupt changes in the electronic states. In many cases the larger values of s may be due to the large experimental errors involved in the difficult task of evaluating E over a limited temperature range.

LaMer has emphasized that E probably changes with temperature, but present experimental methods are not often accurate enough to distinguish the difference. An entropy of activation must exist if E depends on temperature and the activated molecules and the normal, reacting molecules have different specific heats. Ionic reactions particularly are apt to involve large specific heats which may change in reaction. The entropy of activation may arise in part from specific steric factors.

According to Eyring's approach the activated complex is just like any other molecule except that it has in addition to the three translational degrees of freedom a fourth along which it approaches the energy barrier, crosses it and flies apart. One internal degree of freedom is left out and replaced by the extra translational degree of freedom. The molecule of the activated complex is stable in all other vibrations. The general equation is

$$k = pKv = \frac{pf^*}{f} \frac{k'T}{h} e^{-E/RT} = p \frac{k'T}{h} e^{\frac{\Delta S}{R} - \frac{\Delta H}{RT}}$$

K = the equilibrium constant for the molecules of reactants and the molecules of the activated complex. It involves the number of activated molecules per unit length in the direction on the energy map along which the molecules decompose.

²⁴ Dushman, *J. Am. Chem. Soc.*, **43**, 397 (1921).

v = the average velocity with which the activated complex molecules (regarded as points) cross the top of the energy hill. This is merely the number of molecules calculated from the Maxwell-Boltzmann distribution law as applied to the activated molecules.

p = the probability that an activated complex molecule once over the top of the energy hill will continue without turning back. For most cases p may be considered as nearly unity.

k' = the gas constant per molecule; and the other symbols have their usual significance.

f represents partition functions of statistical mechanics by means of which the equilibrium constant can be calculated from fundamental constants such as moments of inertia and quantum numbers—when these constants are known. f^* represents the partition function for the activated complex for all the degrees of freedom except the one along which the molecules are decomposing.

It is clear that the equilibrium constants for these activated complexes, which may have a life of only about 10^{-13} second, can not be determined by direct experimental means. Sometimes important conclusions may be drawn without even attempting to calculate this equilibrium constant—making the necessary estimates from considerations of entropy, or comparing different reactions in such a way that this term cancels out. Again in using activities instead of concentrations one can arbitrarily specify standard states for reactions in different phases in such a way as to simplify the calculations.

For unimolecular reactions

$$A \rightleftharpoons (A^*) \rightarrow B + C$$

$$k = \frac{m^*}{m} \frac{\sigma}{\sigma^*} \frac{X^* Y^* Z^*}{XYZ} \frac{k' T}{h} e^{-E/RT}$$

where m is mass, and X , Y and Z are the moments of inertia. The symmetry number σ is the number of ways in which the molecule can be rotated so as to interchange the positions of like atoms. The asterisk indicates that the symbols refer to the activated complex.

The first three ratios in the expression at the right are nearly unity and

$$\frac{k'}{h} = \frac{8.316 \times 10^7}{6.06 \times 10^{23} \times 6.55 \times 10^{-27}} = 2.09 \times 10^{12}.$$

Then

$$k \sim 2.09 \times 10^{10} T e^{-E/RT}$$

and at $T = 300^\circ$

$$k \sim 6.3 \times 10^{12} \cdot e^{-E/RT} \text{ sec}^{-1}.$$

This value agrees with the general expression for many unimolecular reactions.²⁵

For bimolecular reactions



and the degrees of freedom are such that a similar expression often reduces to

$$k \sim \frac{5.8}{T} \times 10^{11} e^{-E/RT}$$

and at $T = 300^\circ$

$$k \sim 1.9 \times 10^9 \cdot e^{-E/RT} \text{ liters moles}^{-1} \text{ sec}^{-1}.$$

This value again is in close agreement with the general expression for many bimolecular reactions.²⁵

²⁵ Page 23.

CHAPTER X

ISOTOPIC TRACERS

THE USE of isotopes to mark atoms and trace them through significant chemical reactions and biological processes is one of the most important developments in chemical kinetics during the past few years.

There is nothing new in principle about the use of isotopes as an aid to chemistry. For twenty years the radioactive elements have been used as indicators to study adsorption, solubility, volatility, distribution, and other phenomena of physical chemistry. Distribution of heavy radioactive atoms in plants has been studied through the relative amount of ionization found in the different parts. The ionization theory was supported by dissolving radioactive lead chloride in an aqueous solution of ordinary lead nitrate and then crystallizing out the lead chloride. The radioactive lead was found to be equally distributed between the two salts. In aqueous solution the two different kinds of lead are free to exchange anions, as predicted from the electrolytic dissociation theory. With un-ionized compounds of lead it was found that exchange does not take place.

These heavy elements, which are naturally radioactive, are less interesting in chemical kinetics than the light elements which are involved in the majority of chemical reactions. The use of light elements has been made possible through the production of artificial radioactivity and through the finding of practical means of concentrating isotopes to such an extent that their concentrations can be determined by means of density measurements. Extraordinary refinements in these measurements have been a necessary part of these developments.

Radioactive elements are produced artificially by bombardment with neutrons and with protons or deuterons, driven at high voltages. The neutrons are produced by treatment of beryl-

lium with alpha rays from radon or other radioactive elements. The protons or deuterons are produced from hydrogen or deuterium at low pressures and driven at potentials of the order of a million volts against the target which is to be rendered radioactive. These high voltages are obtained either by electrostatic means with a friction belt, or by whirling the ions many times around in a circular channel using synchronized, alternating, magnetic fields. Radioactive phosphorus and radioactive iodine prepared by neutron bombardment are among the important substances which have already been used successfully as tracers. Such small quantities are available that extremely sensitive Geiger counters are necessary for measuring the very feeble ionizations produced in these tracer experiments.

The production of practically pure deuterium oxide by electrolysis, first in the laboratory and then as a by-product on an industrial scale has led to many tracer experiments of importance in chemical kinetics. In one of the first experiments of this type a weighed quantity of sugar¹ was dissolved in a weighed quantity of heavy water, the water was then driven off, and the density of the water was determined before and after the addition of the sugar. These measurements showed that half the hydrogen atoms in the sugar had interchanged with the water and half had not. It was concluded that those hydrogen atoms attached to carbon atoms did not interchange but that those attached to oxygen atoms ionized and interchanged quickly with the hydrogen ions of the water to give a complete, random distribution between the sugar and the water.

ISOTOPIC CARBON

Of all the elements which might be used in tracer experiments, carbon is the most interesting on account of its importance in organic chemistry and in biology. The fact that it is one of the lightest elements makes the concentration of its heavier isotope a possibility. The available radioactive isotope of carbon has a period of half-life of twenty minutes, a time which is inconveniently short for many investigations in kinetics. Tracer experiments, at least in biology and in most chemical reactions, will have to be carried out by concentrating the heavier isotope which has an atomic weight of 13.

¹ Bonhoeffer and Brown, *Z. physik. Chem.*, **B23**, 171 (1933).

Existence. The existence of C^{13} was first proved by King and Birge² in 1929 with a remarkable spectrogram of carbon vapor obtained by heating carbon up to 2,500°C in an evacuated furnace. A banded spectrum was observed with its head at 4,737.0 Å. This is the so-called Swan band which is prominent in all emission spectra of carbon flames and which is due to the radical C_2 . Just at the side of this band King and Birge found a much weaker band identical in pattern but with its head at 4,744.5 Å. They interpreted the band properly as being due to the diatomic carbon molecule $C^{12}-C^{13}$.

Later in 1931 Jenkins and Ornstein³ measured the approximate concentration of C^{13} by comparing the photographic density of the $C^{12}-C^{13}$ band with that of the $C^{12}-C^{12}$ band. Using a glass prism spectrograph and the Swan band from a Meker burner, they concluded that C^{13} comprises approximately one per cent of ordinary carbon. In 1934 Aston⁴ reported from mass-spectrographic measurements that C^{13} comprises 0.7 per cent of ordinary carbon. Previously it had been supposed that the concentration of C^{13} in ordinary carbon was only about one part in 200 because the atomic weight of carbon was accepted as 12.005. Birge and Jenkins⁵ critically reviewed the evidence for the atomic weight of carbon as obtained from physical measurements and decided that the accepted value was subject to considerable error. In 1936 Baxter and Hale⁶ redetermined the atomic weight of carbon by finding the ratio of carbon to hydrogen in hydrocarbons of very high carbon content and found it to be not far from 12.01. The chemical, physical, spectrographic, and mass-spectrographic evidence are all in substantial agreement now and it is established that C^{13} occurs in ordinary carbon to the extent of about one part in 100.⁷

Deuterium occurs in ordinary hydrogen only to the extent of one part in 6,400 and the heavier isotope of carbon is relatively much more common than the heavier isotope of hydrogen. Unfortunately however, it is far more difficult to concentrate than hydrogen.

Separation. Three different methods may be used in changing

² King and Birge, *Astrophysical Journal*, **72**, 24 (1930).

³ Jenkins and Ornstein, *Proc. Amsterdam Acad.*, **35**, 1212 (1932).

⁴ Aston, *Proc. Roy. Soc.*, **A149**, 400 (1935).

⁵ Birge and Jenkins, *J. Chem. Phys.*, **2**, 167 (1934).

⁶ Baxter and Hale, *J. Am. Chem. Soc.*, **58**, 510 (1936).

⁷ A discussion of the exact value of the abundance ratio, the packing fraction and the atomic weight is given by Baxter and Hale, reference 6, page 515.

the ratio of isotopes: diffusion methods which depend on the difference in density, equilibrium methods which depend on the distribution of the element between different compounds under equilibrium conditions, and kinetic methods which depend on the relative rates of competing reactions. Each of these methods has been used successfully.

The diffusion method depends on the fact that the velocity of a molecule is inversely proportional to the square root of its molecular weight. Slight separations were made years ago in the case of hydrochloric acid and of mercury but the results were disappointing on account of the very small yields. The isotopes of neon with atomic weights of 20 and 22 have been separated rather successfully by diffusion. Hydrogen and deuterium also have been separated by diffusion.

In attempting to separate the isotopes of carbon, acetylene with molecular weights of 26 and 28, or methane with molecular weights of 16 and 17 seem to offer the best possibilities. The lighter the carbon-containing gas the greater is the chance of separation, for the efficiency of separation depends on the ratio of the square roots of the densities. These gases are complicated by the presence of isotopes of hydrogen and there are four chances in 6,400 that a methane molecule will have a molecular weight of 17 on account of the presence of deuterium, but there is one chance in a hundred that it will have this greater weight on account of the C^{13} isotope. Colloidal carbon would not be a suitable substance in which to try to effect an isotopic separation because each colloid particle would contain millions of carbon atoms and the statistical average would be reached in every particle—so that all would be alike.

Separation by diffusion of carbon vapor offers a possible opportunity.

It has been found possible to concentrate the heavy isotope in most of the lighter elements by diffusion at low pressures using many mercury diffusion pumps in series.⁸ Very recently⁹ the heavy isotope of carbon has been enriched seven fold by circulating twenty-five liters of methane gas for twelve hours at eight millimeters pressure through a battery of thirty-five mercury vapor diffusion pumps, but the yield in the experiment reported was only 1.6 cc. at atmospheric pressure. For tracer experiments in kinetics one needs large quantities with which to work.

⁸ Hertz, *Z. Physik*, **79**, 108 (1932).

⁹ Wooldridge and Jenkins, *Phys. Rev.*, **49**, 404 (1936).

The distribution method has been developed by Urey. Calculating from theoretical grounds and using the data of band spectroscopy, Urey and Greiff¹⁰ showed that the equilibrium constants involving exchange of isotopes between different compounds differ slightly from unity. Such a process in which equilibrium is repeatedly established and the products removed each time may eventually produce an appreciable separation of the isotopes. Attempts were made to increase the C¹³ content of the bicarbonate ion through the reaction

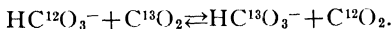

A solution of sodium bicarbonate flowed slowly down a long, packed tower while a stream of carbon dioxide bubbled up through it. The carbon dioxide was generated by the bicarbonate solution from the bottom of the tower falling into stirred sulfuric acid in a large gas-tight bottle. In this way the carbon dioxide should enrich the incoming bicarbonate ion in C¹³ and the outgoing carbon dioxide should become continuously richer in it. These experiments were unsuccessful, but soon afterward Urey¹¹ in similar experiments obtained an enrichment, giving 1.36 per cent of C¹³ by the clever expedient of using the blood-enzyme, carbonase, which greatly accelerates the establishment of the equilibrium between carbon dioxide and carbonate ion. The ratio of isotopes was measured with the mass spectrograph.

The kinetic method has been the object of an extended research in our laboratory starting in 1934 and although definite results are still to be achieved a discussion of the methods serves to illustrate several important points in chemical kinetics.

Calculation for Separation. The velocity of a simple chemical reaction is given by the expression

$$k = se^{-E/RT} \quad (1)$$

and, assuming that s is the same, the ratio of velocities of the two similar reactions is given by

$$\frac{k}{k'} = \frac{se^{-E/RT}}{se^{-E'/RT}} = e^{-(E-E')/RT}. \quad (2)$$

This formula applies directly to the calculation of the relative rates of reaction in the competition of two isotopes in a given re-

¹⁰ Urey and Greiff, *J. Am. Chem. Soc.*, **57**, 321 (1935).

¹¹ Urey, Aten and Keston, *J. Chem. Phys.*, **4**, 622 (1936).

action. It is evident that absolute values of s and E are not needed to determine how much faster one isotope will react than the other. The prediction of the rate-ratios for the breaking of the carbon-carbon bond $C^{12}\text{-}C^{12}$ and $C^{13}\text{-}C^{12}$ is illustrated in the following calculations which depend simply on the ratios of the fundamental vibration frequencies ν which in turn are calculated from the atomic weights.

The ratio of the fundamental vibration frequencies for $C^{12}\text{-}C^{12}$ and $C^{13}\text{-}C^{12}$ is calculated by ordinary mechanics from the reduced mass which is defined by the formula,

$$\frac{1}{\mu} = \frac{1}{M_1} + \frac{1}{M_2}; \quad \text{or} \quad \mu = \frac{M_1 M_2}{M_1 + M_2} \quad (3)$$

where M_1 and M_2 are the weights of the two atoms making up the bond.

For the carbon-carbon bond

$$\mu_{C^{12}\text{-}C^{12}} = \frac{12 \times 12}{12 + 12} = \frac{144}{24}; \quad \text{and} \quad \mu_{C^{13}\text{-}C^{12}} = \frac{13 \times 12}{13 + 12} = \frac{156}{25}.$$

The frequency of vibration ν is related to the reduced mass μ and the force K holding the two atoms together, by the formula

$$\nu = \frac{1}{2\pi} \sqrt{\frac{K}{\mu}}. \quad (4)$$

This formula can be applied only to cases of perfectly elastic bonds which result in the harmonic motion of the vibrating atoms. This restriction introduces no complication in the present calculation because, although the motion becomes anharmonic at higher energy levels just before the bond breaks, the difference in isotope behavior applies only to the zero point energy, or energy level in the normal unexcited molecule. It is assumed that the highest energy level for the activated state just preceding disruption is the same for both C^{12} and C^{13} , and some of the unknown and troublesome factors cancel out when one is interested only in a ratio.

Then

$$\frac{\nu_{C^{12}\text{-}C^{12}}}{\nu_{C^{13}\text{-}C^{12}}} = \frac{\frac{1}{2\pi} \sqrt{\frac{K}{\mu_{C^{12}\text{-}C^{12}}}}}{\frac{1}{2\pi} \sqrt{\frac{K}{\mu_{C^{13}\text{-}C^{12}}}}} = \sqrt{\frac{\mu_{C^{13}\text{-}C^{12}}}{\mu_{C^{12}\text{-}C^{12}}}} = \sqrt{\frac{156/25}{144/24}} = 1.02. \quad (5)$$

The fundamental frequency ν of the carbon-carbon bond $C^{12}-C^{12}$ is known from infrared absorption data and from Raman spectra to be $2.97 \times 10^{13} \text{ sec}^{-1}$ equivalent to 990 cm^{-1} in wave numbers.¹² The frequency of the $C^{13}-C^{12}$ bond must then be 2.91×10^{13} . The zero point energy¹³ is defined as one half the product of the fundamental vibrational frequency and Planck's constant h . Then, the difference in zero point energy is

$$\begin{aligned} 1/2h(\nu_{C^{12}-C^{12}} - \nu_{C^{13}-C^{12}}) &= 1/2(6.55 \times 10^{-27}) \times \\ (2.97 \times 10^{13} - 2.91 \times 10^{13}) &= 1.96 \times 10^{-15} \end{aligned} \quad (6)$$

erg per molecule, and

$$1.96 \times 10^{-15} \times 6.06 \times 10^{23} / 4.183 \times 10^7 = 29 \text{ calories per mole.} \quad (7)$$

This calculation shows that in a mole of substance the $C^{13}-C^{12}$ bond will always lie at an energy level approximately thirty calories lower than the $C^{12}-C^{12}$ bond, and any reaction which involves the breaking of the carbon-hydrogen bond will require thirty calories more for the heavy carbon than for the light carbon. Applying this calculated difference to kinetics and substituting into equation (1) at 27° ,

$$\frac{k_{C^{12}-C^{12}}}{k_{C^{13}-C^{12}}} = e^{-(E_{C^{12}-C^{12}} - E_{C^{13}-C^{12}}) / RT} = e^{30/600} = e^{0.05} = 1.05. \quad (8)$$

At room temperature, then the specific reaction rate for breaking the carbon-carbon bond is 1.05 times as large for light carbon as it is for heavy carbon. In other words when the concentrations of the two are equal the light carbon reacts 1.05 times as fast.

Similar calculations show that the breaking of the carbon-hydrogen bond is less favorable than breaking the carbon-carbon bond for separating the carbon isotopes. At 27° the carbon-hydrogen ratio is

$$\frac{k_{C^{12}-H^1}}{k_{C^{13}-H^1}} = 1.003. \quad (9)$$

Other bonds with heavier atoms such as the C-Cl or C-Br bond give values comparable with the C-C bond.

The quantitative treatment for relative rates at different con-

¹² Page 212 and 226.

¹³ Page 225.

centrations follows immediately from the ratio of the specific rates just calculated. Starting with the mass law, according to which the rate of a reaction is proportional to the concentration, and using these specific reaction rates, the following formula is obtained after integration

$$\log \frac{N_0}{N} = \alpha \log \frac{V}{V_0} \quad (10)$$

In this formula V represents the final quantity (or volume) of material after the reaction has destroyed part of the original quantity V_0 . It is applicable only for small increases in N . The amount of the reactants in the initial material is N_0 and the amount in the final material is N , while α is a coefficient derived from the ratio of the two specific rate constants by the subtraction of unity. Applied to the particular problem of concentrating the carbon isotopes, N_0 represents the amount of C^{13} in ordinary carbon and is taken as one per cent and N is the amount after the concentration process. When the concentration is effected by removing material through the rupture of the carbon-carbon bond, α has the value 1.05–1.00 or 0.05 as already explained. Assuming as a special case that ninety-nine per cent of the material is destroyed by breaking the carbon-carbon bond,

$$\log \frac{0.01}{N} = 0.05 \log \frac{1}{100} \quad (11)$$

and N is found to be 0.0126. In other words if a quantity of organic material is reduced to 1/100 of its original quantity by breaking the carbon-carbon bond at room temperature the C^{13} content will increase from one per cent to 1.26 per cent.

In Table I are presented the concentrations of C^{13} to be expected by the destruction of various amounts at several different temperatures through the rupture of the C-C bond, starting with one per cent of C^{13} . The table shows that separation is favored by large reductions in volume, and by low temperatures for then the exponential terms are larger and the ratio of rates greater. Temperatures of -30°C . (243°A) are considerably more favorable than room temperature, but even at the very high temperatures some separation is still possible. It is clear, however, that these methods will never offer a practical method for producing high concentrations of C^{13} , as is possible in concentrating deuterium. In compar-

ing the concentration of heavy carbon and heavy hydrogen it should be pointed out that although the rates of reaction at equal concentration are 5 to 1 for hydrogen and only 1.05 to 1 for carbon (C-C bond) there is an advantage for carbon in that the initial concentration is one to 100 while in hydrogen it is one to 6,400. When the deuterium is brought up to one part in 100 the further concentration is very effective.

TABLE I
ENRICHMENT OF ISOTOPIC CARBON

$$\frac{k_{C^{13}-C^{12}}}{k_{C^{12}-C^{12}}} = e^{30/2T}$$

<i>T</i>	200°	243°	300°	400°	500°	600°	1000°A
$\frac{V}{V_0} = 0.01$	1.50	1.34	1.26	1.19	1.15	1.12	1.07 per cent
$\frac{V}{V_0} = 0.0001$	2.00	1.82	1.56	1.41	1.32	1.26	1.15 per cent
$\frac{V}{V_0} = 0.000001$	2.82	2.42	2.00	1.68	1.51	1.41	1.23 per cent

Table I shows that it should be possible to obtain a concentration of C¹³ sufficiently high for use in tracer experiments provided that a very sensitive method is made available for determining the isotopic ratio.

Analysis. There are five important methods for measuring the ratios of isotopes, making use respectively of—the spectrograph, the mass spectrograph, density measurements, atomic weight measurements and refractive index measurements. Any of these methods must be pushed to the present limits of accuracy or beyond in order to meet the requirements for tracer experiments. If, for example, an increase in concentration of C¹³ is effected from 1 per cent to 1.1 per cent and an accuracy of five per cent in the increase is required the determination must be accurate to one part in 20,000.

Tate,¹⁴ using a mass spectrograph, found the concentration of C¹³ in acetylene to be one part in 100. Urey¹⁵ reported C¹³ concentrations to 0.01 per cent or one part in 10,000. Although the best

¹⁴ Tate, Smith and Vaughan, *Phys. Rev.*, **48**, 525 (1935).

¹⁵ Urey, Aten and Keston, *J. Chem. Phys.*, **4**, 622 (1936).

mass spectrographs are probably capable of giving the required accuracy none was available for this work. Moreover, there is some uncertainty in any excitation method; for the ratio of ionized, isotopic molecules may not be exactly the same as the ratio of normal isotopic molecules when the highest order of accuracy is involved.

The analysis by band spectroscopy offered possibilities which were explored. Jenkins and Ornstein¹⁶ determined the concentration of C¹³ in a Meker burner to be 0.95 ± 0.10 per cent of the total carbon. This ten per cent sensitivity is nowhere near adequate for the present problem, and different excitations of the two isotopes might affect the results. Quantitative analyses through density measurements or a photographic plate are not capable of the greatest accuracy. Again it would not be possible to operate a Meker burner with small samples of material. Attempts were made to utilize the Swan bands emitted in the electrical discharge with small amounts of carbon dioxide, and of carbon monoxide; but overlapping of bands caused the method to fail. The banded structure at 2,200 Å and below 2,000 Å looked somewhat promising, but even if the spectrum were fully analyzed and the C¹³ bands separated there is still the complication of the oxygen isotopes which are also present. Absorption bands in carbon vapor would be more satisfactory, as in the case of the original discovery of King and Birge, provided a furnace could be obtained which was not constructed of carbon and which could be heated to 2,500°C. The method of the electrical discharge emission spectrum was used successfully by Wooldridge and Jenkins¹⁷ with one-half millimeter of methane and ten millimeters of argon but the measurements were not accurate enough for the purpose described here.

The density, or atomic weight methods then seemed to be better suited to the solution of this problem.

Ordinary carbon contains about one per cent of C¹³ and the difference in weight of C¹² and C¹³ is one unit. The atomic weight of ordinary carbon is about 12.01. If the ratio of C¹³ increases from 1 per cent to 1.1 per cent the atomic weight increases from 12.010 to 12.011, an increase of one part in 12,000. With carbon dioxide, which is the most convenient and most easily purified compound of carbon the molecular weight increases from 44.010 to 44.011, an increase of a little over twenty parts per million. An accuracy of

¹⁶ Jenkins and Ornstein, *Proc. Amsterdam Acad. Sci.*, **35**, 3 (1932).

¹⁷ Wooldridge and Jenkins, *Phys. Rev.*, **49**, 404 (1936).

one part per million would then be necessary if the change is to be measured with an accuracy of five per cent. If the concentration is increased from 1 per cent to 1.26 per cent, by breaking a carbon-carbon bond at room temperature until ninety-nine per cent of the material is destroyed, an accuracy of two and a half parts per million is required for an error of only five per cent.

Chemical analyses and even atomic weight determinations are nowhere near adequate for the purpose and differential density measurements seemed to offer the only hope of success. Density measurements moreover are preferred on account of rapidity of determination, simplicity of calculations, and freedom from molecular excitation.

Gas Density Balance. Several methods for measuring densities suggest themselves but they are eliminated by setting an arbitrary standard of accuracy of two parts per million. Such measurements of course are meaningless unless the material is chemically pure to two parts per million. Most organic substances can not be purified to a degree approaching this standard. Precision methods for determining the density of water to one part in a million and more have been developed on account of the interest in deuterium, but water is easier to purify than most organic substances. Gases seemed to offer wider opportunities than liquids on account of the much smaller amount of material required.

Carbon dioxide was selected for many reasons as the best gas to use for the density determinations. It is chemically inert, even at high temperatures; it has a low boiling point by means of which it can be separated from water and most ordinary organic material; it can be purified readily with liquid air and dry ice; it can be purified, precipitated and stored easily as barium carbonate; and any organic material can be easily converted into carbon dioxide for testing. These and many other advantages far outweigh the disadvantage that the per cent of carbon in the carbon dioxide is comparatively low.

A balance suitable for measuring the density of carbon dioxide and other gases is described by Edwards.¹⁸ Although excellent for ordinary work it can not attain the accuracy required here. A more sensitive gas density balance has been described by Cady¹⁹ in which a balloon is suspended from an ordinary high sensitivity

¹⁸ Edwards, *Ind. Eng. Chem.*, **9**, 790 (1917).

¹⁹ Meeting of the American Chemical Society, New York, April, 1935.

analytical balance and weighed in the vapor. Stock²⁰ has developed another, more compact, high-sensitivity balance. Neither of these instruments is capable of giving accuracy even to one part in 100,000. To reach such accuracy the instrument must be thermostated and stopcocks must be eliminated on account of contamination from air, water and other impurities. To meet a requirement of one part in 100,000 the pressure and temperature must also be accurate to one part in 100,000, namely to 0.007 mm. of mercury and 0.003°. These requirements force one to use a differential method but such a method is entirely satisfactory for the purpose of determining a change in the density of carbon dioxide by concentration of the heavier isotope of carbon. The general requirements suggest at once that a large balloon be floated in a glass vessel and viewed with a microscope, while the pressure is read by an oil manometer connected to a second glass vessel of the same size. The whole apparatus must be set in a thermostat and suitable arrangements made for filling with purified samples of carbon dioxide.

Free-floating balloons of thin glass and rubber were first tried. The glass was too heavy; the rubber too permeable. Balloons suspended from springs were too insensitive, and balloons suspended from balance beams were too mobile. A gas density balance operated by the pull of a large solenoid or an enclosed magnet was used but, although extremely sensitive, it was discarded because it involved an unnecessary and somewhat erratic variable.

The gas density balance after two years of development consists of a quartz balloon of 100 cc. capacity mounted on a quartz beam with a small, heavy, counterpoise and balanced on carborundum points²¹ attached with fused silver chloride. The balance is enclosed in an all-glass vessel and completely immersed in a water thermostat. Differences in pressure between the carbon dioxide surrounding the balance and that in the standard reservoir of the same volume (400 cc.) are read on an oil manometer with a traveling microscope comparator. The pointer of the balance is read with a microscope and scale. The balance has such a slow period, twenty-five seconds, that it is completely damped. The sensitivity is altered by adding or removing small drops of silver chloride to a vertical rod thereby raising or lowering the center of gravity.

²⁰ Stock and Ritter, *Z. physik. chem.*, **119**, 333 (1926).

²¹ The use of carborundum points for a microbalance is due to McBain and Tanner, *Proc. Roy. Soc.*, **125A**, 579 (1929).

Many hours of adjustment are necessary to obtain the maximum sensitivity without instability.

The oil manometer is read to 0.01 mm. on the vernier and estimated to 0.001 mm. A difference of 0.01 mm. of oil, having a density of 0.8, corresponds at atmospheric pressure (745 mm.) to one part in $100 \times 745 \times 13.5 / 0.8 = 1,200,000$. The pressure difference, then, can be easily read to better than one part in a million and, when the balance is in best adjustment, a pressure change of this magnitude produces a detectable change in the position of the pointer as viewed on a microscope scale. No trouble was experienced in obtaining a quick reading on the oil manometer. Hundreds of determinations showed that it is possible to obtain a sensitivity of about two parts per million, but great precautions and many changes were necessary, particularly with reference to mechanical vibrations. Although the goal set for the sensitivity of the balance has been met,²² the instrument up to the present time has not been entirely satisfactory on account of changes in the zero point due to wandering of the carborundum points on the quartz plate.²³

The necessary degree of purification of carbon dioxide was accomplished by precipitation as barium carbonate, acidification, purification from traces of sulfur compounds, passage through a trap surrounded by dry ice, and condensation in a trap surrounded by liquid air. Evaporation, condensation and evaporation were repeated before the gas was swept into the density balance. In these operations mercury valves, subjected to freezing and thawing, were used in place of stopcocks. A density determination was considered reliable only in case it was preceded and followed by measurements on a secondary standard from a commercial tank. Passage of the purified carbon dioxide through platinized asbestos at red heat with an excess of air served to remove the last traces of sulfur compounds and organic impurities.

Concentration. In this investigation attempts have been made along several different lines to increase the concentration of the heavier isotope of carbon by chemical kinetics, and to search for materials which might already contain a slight alteration from the normal concentration of one per cent.

One of the most promising sources is the residue left after electrolyzing away a large amount of acetic acid. This material gives

²² Meeting of the American Chemical Society, Kansas City, April 1936.

²³ This difficulty has been met recently by substituting quartz fibers suspensions for the carborundum points.

methane and carbon dioxide when electrolyzed and it is difficult to see how these changes can occur without breaking a carbon-carbon bond. The reaction proceeds at room temperature and according to the calculations previously given a detectable enrichment should be effected.

The last residues from laboratory fermentations of sugar and of grains, and the last residue of a commercial alcoholic fermentation have been obtained. Other samples include the last one per cent of the neutralization of 100 pounds of sodium carbonate; a similar product from sodium bicarbonate; sodium bicarbonate solution equilibrated with carbon dioxide regenerated in an automatic process; the last residue of a large commercial reservoir of liquid carbon dioxide; dry ice from different sources, from the burning of coke, from the heating of limestone and from fermentation; different fractions from the heating and cracking of petroleum; and organic chemicals from various sources.

Naturally-occurring products are being examined also for different isotopic ratios of carbon. Water from various sources are known to vary in density up to ten parts per million. These differences are due chiefly to the different ratios of oxygen isotopes, and in part to the different deuterium ratios.

Among the samples of carbon dioxide from natural sources are limestone from various localities, and from ages up to 500 million years; marble; fresh water and ocean shells; carbon dioxide from the air; hard and soft coal; natural gas; wood and various biological products.

It is hoped that one or more of the 150 samples now awaiting analysis will lead to the discovery of a source of material large enough and rich enough in C^{13} to be used in extensive tracer experiments on carbon.

LITERATURE

A few examples of the use of isotopes in the interpretation of chemical kinetics are given in the following list.

Photolysis of Ammonia. The low quantum yield ($\Phi=0.2$) in the photodecomposition of ammonia was thought to be due to the reverse reaction

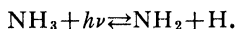

The addition of deuterium atoms (produced by mercury vapor atoms excited with ultraviolet light of 2537 Å) to the reaction

vessel gave NH_2D , NHD_2 and ND_3 as determined from the absorption spectrum of the mixture. These deuterium products were not formed in the absence of light. The results establish the fact that the reaction is reversible and that this reversibility accounts for the low quantum yield.

Taylor and Jungers, *J. Chem. Phys.*, **2**, 452 (1934).

Ionization of Sucrose. The COH group ionizes to give H^+ but the CH group does not. Page 245.

Ionization of Acetylene. Acetylene is known to possess acidic properties and when it is shaken with heavy water the density of the latter becomes less in alkaline solution indicating an exchange between the hydrogen of the acetylene and the deuterium ions of the water. The exchange does not take place with measurable velocity in acid solutions where the dissociation of the weak acetylene acid is repressed.

Reyerson, *J. Am. Chem. Soc.*, **57**, 779 (1935).

Enolization of Acetone. Hydrogen from water is transferred to the CH of the acetone

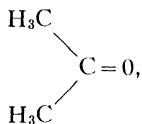

through the medium of the fleeting enol form,

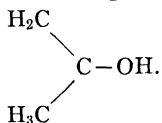

This fact was established with the help of density measurements on heavy water before and after the addition of a definite quantity of acetone.

Halford, Anderson and Bates, *J. Am. Chem. Soc.*, **56**, 491 (1934).

Schwarz and Steiner, *Z. physik. Chem.*, **B 25**, 153 (1934).

Klar, *Z. phys. Chem.*, **26**, 335 (1934).

Acid and Base Catalysis. Opportunities are now available for checking some of the theories of acids and bases which involve both the manner of readjustment within the molecule and the function of the catalyst. An acid dissociates according to the Brönsted theory to give a proton and a base. The rate of a given change will be faster for a proton than for a deuteron but there will be little differ-

ence in reactions which involve, as the rate determining step, the addition of a larger molecule or ion which contains the proton or deuteron. A good example is given in the pseudo-acid nitroethane, in which a hydrogen attached to the carbon atom can migrate to the oxygen atom. The NOH group is thus produced and ionization follows. The relative rates with H and D are significant in studying the kinetics of the reaction, as follows

	<i>Relative Rate</i>
(a) $\text{CH}_3\text{CH}_2\text{NO}_2 + \text{OH}^- \rightarrow \text{CH}_3\text{CHNO}_2^- + \text{H}_2\text{O}$	39
(b) $\text{CH}_3\text{CH}_2\text{NO}_2 + \text{OD}^- \rightarrow \text{CH}_3\text{CHNO}_2^- + \text{HDO}$	60
(c) $\text{CH}_3\text{CHDNO}_2 + \text{OD}^- \rightarrow \text{CH}_3\text{CDNO}_2^- + \text{HDO}$	36
(d) $\text{CH}_3\text{CH}_2\text{NO}_2 + \text{OD}^- \rightarrow \text{CH}_3\text{CDNO}_2^- + \text{D}_2\text{O}$	6

It can be concluded therefore that the proton transfer (b) is at least ten times as fast as the deuteron transfer (d) and that the rate of $\text{H} + \text{OD}^-$ according to (b) is fifty per cent faster than the rate of $\text{H} + \text{OH}^-$ according to (a).

Wynne-Jones, *Chem. Rev.* **17**, 115 (1935).

Hydrogen Exchange with Benzene. It has been known that hydrogen can add to a double bond under suitable conditions but until experiments with deuterium were available it had not been realized that it can exchange with some of the hydrogen atoms already present. At comparatively low temperatures in the presence of catalysts of the type which favor addition of hydrogen the following reaction occurs.

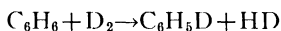

Similar results were obtained with ethylene but not with ethane. Apparently the catalyst tends to produce deuterium atoms and to open up the double bond so that a deuterium atom can attach to one of the carbon atoms. Either exchange or addition may follow.

Horiuti and Polanyi, *Trans. Faraday Soc.*, **30**, 1164 (1934).

Fat Metabolism. Linseed oil was hydrogenated with deuterium and fed to mice. In this way the fat was tagged, and it was found that in the metabolism it is not oxidized directly. The fat eaten by the mouse is first taken up and stored in the fatty tissues of the animal.

Schoenheimer and Rittenberg, *Science*, **82**, 156 (1935).

Water Metabolism. The time during which a given quantity of

water remains in the body has been determined by using water, tagged by means of its deuterium content.

Johnston, *The Ohio Journal of Science*, **35**, 383 (1935).

Phosphorus Metabolism. Phosphorus atoms have been tagged by rendering them radioactive through bombardment with neutrons from a mixture of radium and beryllium. They were fed to a colony of rats and at definite intervals some of the rats were killed and the weak radioactivity of the bone ash was determined with a sensitive Geiger counter. The period of half life of the radioactive phosphorus is about two weeks. A given atom of phosphorus was found to remain in the bones on an average for only about a month, thus demonstrating that bones in a living animal exist in a dynamic equilibrium with their surrounding.

Chiewitz and Hevesy, *Nature*, **136**, 754 (1935).

Hydrolysis of Amyl Acetate Studied with Heavy Oxygen. The hydrolysis might go by initially removing either the C_5H_{11} group or the OC_5H_{11} group. The latter mechanism was favored but it has now been proved with the aid of the heavy isotopes of oxygen as an isotopic tracer. The two reactions may be written as (a) or (b).

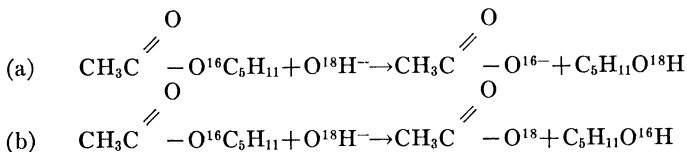

When water containing 0.3 per cent of H_2O^{18} was used in the reaction the resulting amyl alcohol contained only the O^{16} and none of the O^{18} , as determined by careful density measurements. This fact shows that reaction (b) alone takes place; that the C_5H_{11} group does not become detached but that the hydroxyl ion reacts with the OC_5H_{11} group. It follows also that the amyl alcohol does not ionize into $C_5H_{11}^+$ and OH^- for if it did there would be some interchange with the H_2O^{18} .

Polanyi and Szabo, *Trans. Faraday Soc.*, **30**, 508 (1934).

Bromine Exchange Between Bromine and Bromide Ion. A solution of sodium bromide, 20 grams in 200 cc. of water, was bombarded for twenty-four hours with neutrons from 100 millicuries of radon and 200 milligrams of beryllium. Two radioactive forms of bromine are produced but one is of short life and the second one

has a half life of about six hours. It was followed by measurements with a Geiger counter.

The solution was divided into two parts, one of which was mixed with bromine. Both solutions were evaporated to dryness and the radioactivity of the dry sodium bromide was then determined. The treatment with bromine reduced the radioactivity 2.5 times showing that the following reaction is largely involved.

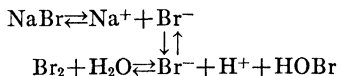

Grosse and Agruss, *J. Am. Chem. Soc.*, **57**, 591 (1935).

Exchange Reactions of Iodine. Iodine dissolved in ethyl iodide does not exchange with the iodine of the ethyl iodide at room temperature, but there is an exchange between radioactive iodide ion and ethyl iodide as shown by experiments with sodium iodide and ethyl iodide dissolved in alcohol.

Hull, Shiflett and Lind, *J. Am. Chem. Soc.* **58**, 535 (1936).

Aliphatic Substitution and the Walden Inversion. The rate of substitution of radioactive iodine into *sec*-octyl iodide in acetone was found to be the same as the rate of racemization of *d-sec*-octyl iodide by sodium iodide. The radioactive iodine was produced by bombardment with neutrons from 150 millicuries of radon mixed with beryllium and embedded in paraffin.

This experiment constitutes a direct confirmation of the causal connection between substitution and optical inversion. Similar experiments were carried out with radioactive bromide and α -phenyl ethyl bromide.

Hughes, Juliusburger, Masterman, Topley and Weiss, *J. Chem. Soc.*, 1525 (1935); 1173 (1936).

Production of Organic Compounds Containing Radio Elements. An experimental procedure is described for producing radio elements with neutrons and incorporating them into organic compounds.

Glückauf and Fay, *J. Chem. Soc.*, 390 (1936).

Exchange Between Ions of Manganese. Metallic manganese was bombarded for forty-five minutes with a 4 micro-ampere beam of 5.8 million volt deuterons and the radioactive layer was dissolved. A special device was used with a Geiger counter for determining the amount of manganese, tagged by means of its radio-

activity. By its means a new interpretation was established for the rapid reaction between permanganate, oxalic acid and manganous ions.

No exchange of manganese atoms occurs in the following pairs.

- (a) permanganate ion—manganous ion.
- (b) permanganate ion—manganic oxalate ion.
- (c) permanganate ion—solid manganese dioxide.
- (d) manganous ion—solid manganese dioxide.

A rapid exchange takes place between manganous ion and manganic oxalate ion.

These facts enable one to choose between different hypotheses for the reaction.

Polissar, *J. Am. Chem. Soc.*, **58**, 1372 (1936).

INDEX OF NAMES

INDEX OF NAMES

- Adamczewski, I., 198
 Allen, A. O., 51
 Andrews, D. H., 209, 217
 Appleyard, M. E. S., 156
 Arnold, L. B., 94
 Aston, F. W., 246
 Aten, A. H. W., 248, 252

Bahr, E. V., 204
 Bardwell, D. C., 47, 189
 Bauer, W. H., 97, 132, 157, 163, 166
 Baxter, G. P., 246
 Baxter, W. P., 142, 146
 Beranek, J., 162
 Berthoud, A., 162
 Birge, R. T., 246, 286
 Blacet, F. E., 155
 Bodenstein, M., 46, 142
 Bonhoeffer, K. F., 245
 Bonner, W. D., 238
 Born, M., 221
 Bourdillion, R. B., 170
 Bowers, H. E., 212
 Brearley, D., 73
 Brewer, A. K., 186, 187
 Brønsted, J. N., 110
 Brous, G. C., 200
 Brown, G. W., 245
 Burk, D., 175
 Burroughs, R. E., 199
 Busse, W. F., 70, 106, 191

Cady, H. P., 254
 Capron, P. C., 190
 Coblentz, W. W., 210
 Coolidge, A. S., 222, 235
 Coolidge, W. D., 191, 193
 Crone, H. G., 147, 150, 162
 Cross, P. C., 202, 204, 206, 213

Damon, G. H., 133, 147, 151
 Dawsey, L. H., 144
 Deanesly, R. M., 166
 Debye, P., 111
 Deussen, E., 169
 Deyrup, A. J., 114
 Dickinson, R. G., 142, 166
 Duggar, B. M., 173, 197
 Duncan, A. B. F., 147

 Dushman, S., 234, 241

Edwards, J. D., 254
 Einstein, A., 118, 123
 Ellis, J. W., 218
 Evering, B. L., 51
 Eyring, H., 5, 71, 100, 190, 221, 222, 239, 240

Farkas, L., 95
 Fazel, C. S., 143
 Forbes, G. S., 133
 Fortney, G. L., 167
 Fosbinder, R. J., 170
 Fowler, R. H., 38
 Franck, J., 175, 223
 Frey, F. E., 51
 Fricke, H., 196
 Fugassi, J. P., 79, 95, 151

Gershinowitz, H., 240
 Getz, D., 67
 Ghosh, J. C., 162
 Gillette, R. H., 215
 Glockler, G., 186, 200
 Gombert, M., 50
 Gore, W. L., 238
 Götzky, S., 197
 Greiff, L. J., 248
 Greenberg, J., 155
 Grimm, H. G., 100
 Günther, P., 197

Hale, A. H., 246
 Harkins, W. D., 187, 212
 Hart, E. J., 196
 Heidt, L. J., 128
 Hertz, G., 247
 Herzfeld, K. F., 52, 155
 Hibben, J. H., 62, 203
 Hinshelwood, C. N., 38, 91, 94, 154
 Hirschfelder, J. O., 190, 222
 Hirst, H. L., 67
 Hodges, J. H., 68
 Hofeditz, W., 50
 Hoffman, R. M., 130, 167, 193
 Holmes, H. H., 137
 Howe, J. P., 147, 150, 152, 157
 Hüchel, E., 111
 Hunt, J. K., 66

- Hurd, C. D., 56
 Hutchison, W. K., 154
 Iddings, C., 150
 James, H. M., 222, 235
 Jenkins, F. A., 246, 247, 253
 Johnston, E. H., 34, 100, 137
 Johnston, W. R., 51
 Karrer, S., 143
 Kassel, L. S., 20, 38, 43, 64, 71
 Keene, P., 184
 Keston, A. S., 248, 252
 Kettering, C. F., 217
 Kharasch, M. S., 166
 King, A. S., 246
 Kistiakowsky, G. B., 73, 94
 Knudson, A., 170, 193
 Kohlrausch, K. W. F., 209
 Kon, S. K., 170
 Kremers, E., 167
 Kueck, P. D., 186
 LaMer, V. K., 103, 110, 239, 241
 Latimer, W. M., 216
 Leermakers, J. A., 152, 153, 166
 Leighton, W. G., 133
 Leithäuser, G., 204
 Lewis, B., 47
 Lewis, W. C. Mc., 31
 Li, N., 238
 Liddell, U., 204, 216
 Lindemann, F. A., 37
 Lineweaver, H., 175
 Lind, S. C., 47, 186, 188, 189, 192
 Linhorst, E. F., 68
 London, F., 222
 Loomis, A. G., 68
 Manning, W. M., 147, 173
 Manning, P. D. V., 184
 Marshall, A. L., 170
 Mathews, J. H., 131, 132
 Mayo, F. R., 166
 McBain, J. W., 255
 Meiler, J. G., 200
 Meloche, V. W., 112
 Moelwyn-Hughes, E. A., 92, 94, 97, 99
 Morse, P. M., 223
 Müller, R. H., 200
 Negelein, E., 172, 173
 Nernst, W., 46
 Norrish, R. G. W., 142, 143, 146, 147,
 150, 152, 156
 Noyes, W. A., Jr., 144, 147, 150, 200
 Ogg, R. A., 162
 Oppenheimer, R., 221
 Ornstein, L. S., 246, 253
 Owen, J. R., 171
 Paneth, F. A., 50
 Pauling, L., 234
 Pearson, T. G., 155
 Pelzer, H., 221, 239
 Perrin, J., 31
 Polanyi, M., 47, 221
 Polissar, M. J., 94
 Porter, C. W., 150, 189
 Porter, F., 47
 Purkayastha, R. M., 162
 Quimby, O. T., 236
 Ramsperger, H. C., 38, 43, 68, 78
 Reed, L. J., 15
 Rice, F. O., 36, 49, 51, 52, 55, 67, 144,
 155
 Rice, O. K., 38, 43
 Rideal, E. K., 38, 67
 Ritter, G., 255
 Rodebush, W. H., 37, 188, 216, 239, 241
 Roof, J. G., 155
 Rosen, N., 222
 Roseveare, W. E., 15
 Ruf, H., 100
 Sachsse, H., 95
 Saltmarsh, O. D., 147, 150, 152
 Schultze, G. R., 166
 Schumacher, H. J., 68
 Semenov, N., 49, 79
 Shaffer, P. A., 113
 Sherman, A., 5, 97, 99, 163, 171, 236,
 238
 Shutts, L. W., 217
 Sickman, D. V., 51
 Sidgwick, N. V., 98, 216
 Slichter, C. S., 3
 Smith, D. F., 68
 Smith, P. T., 252
 Spealman, M. L., 188
 Sprenger, G., 68
 Stauffer, C. H., 73
 Stauffer, J. F., 173
 Steenbock, H., 170
 Stock, A., 255
 Stroup, P. T., 112
 Sun, C. E., 163, 236, 239
 Sutherland, R. O., 166, 236
 Tanner, H. G., 255
 Tate, J. T., 252
 Taylor, H. A., 34
 Taylor, H. S., 24, 50, 190
 Theriault, E. J., 15
 Tolman, R. C., 19, 36, 67, 68
 Trautz, M., 31
 Ure, W., 36
 Urey, H. C., 36, 144, 248, 252

Van Valkenburgh, G. A., 71
Van Vleck, J. H., 213
Vaughan, A. L., 252
Verhoek, F. H., 107
Vollrath, R. E., 155

Warburg, O., 172, 173
Warburg, E., 204
Washburne, R. N., 36
Waters, C. E., 155
Webster, T. A., 170
Wells, D. A., 199
West, W., 155

Westhaver, J. W., 186, 187
White, E. C., 67
Wigner, E., 221, 239
Willard, J., 166
Williams, J. W., 131, 132
Wilson, E. B., 234
Wilson, J. L., 200
Wolff, H., 100
Wooldridge, D. E., 247, 253
Wulf, O. R., 204, 216

Yost, D. M., 238

INDEX OF SUBJECTS

INDEX OF SUBJECTS

- Absorption coefficients of nitrogen oxides, 140
Absorption of radiation, 120
Absorption spectrum, 150
Acetaldehyde, photolysis, 152
Acetic acid, infra red absorption, 214
Acid and base catalysis, 258
Actinometer, 133
Activation energy, 17, 18, 234
Activation energies, calculation of, 220, 232
Activated complex, rate calculation of, 239
Aliphatic substitution and the Walden inversion, 261
Ammonium amalgam, decomposition of, 114
Amyl acetate hydrolysis, 260
Analysis by infrared absorption, 204
Arrhenius equation, 18
Arsenite—tellurate reaction, 112
Association of acetic acid, 214
- Beers' law, 158
Beers' law in infrared, 204
Bimolecular reactions, 13, 243
Bromination of ethylene, calculations of, 227
Bromine—bromide ion exchange, 260
- C¹³ analysis, 252
 concentration, 256
 existence, 246
 separation, 246
 calculation for separation, 248
Carbon dioxide, quantum yield, 146
Capillary lamps, 128, 130
Chain length, 54
 reactions, 44
 theories, photobromination of cinnamic acid, 162
Cell, photochemical, 134
Chemical effects of alpha particles, 188
 effects of cathode rays, 191
 effects of electrons, 198
 effects of X-rays, 195, 197
 equilibrium, 15
 inactivity of infrared radiation, 217
 kinetics, principles of, 8
 reactions in electrical discharges, 185
 significance of activation energies, 234
Cluster ion theory, 189
Collision frequency, 91
 hypothesis, 37
Complicated reactions, 27
Consecutive reactions, 27
Cosmic rays, 197
Coulombic energy, 230
Critical increment, 20
- Decomposition of chloroacetate ion, 107
 nitrogen pentoxide, 60
Decomposition of potassium chlorate, 200
Degree of freedom, 42
Distribution of energy, 25
 of velocities, 26
- Einstein's relation, 118, 123
Electrical activation, 181
 discharges in gases, 182
 discharges in hydrocarbons, 186
Electrolysis of gases, 183
Electron velocity and frequency, 182
Electrostatic attractions, 97
Energy countour map, 228
Enolization of acetone, 258
Ethyl bromide, 210
 calculation of k, 78
 calculation of spectrum, 212
 chain mechanism, 83
 decomposition of, 72
 decomposition at low pressures, 80
 infrared spectrum of, 204, 206
 molecular models, 209
 primary steps, 82
Ethylene—halogen reactions, 236
Exchange energy, 230
Explosions, 48
- Fat metabolism, 259
First order rate constant in chain reactions, 54
 rate constant, effect of pressure on, 41
 reaction, 8

- Foreign gas effect on photolysis of acetone, 150
of nitrogen dioxide, 145
- Free radicals, 49
radical chains, 52
hypothesis of, 190
- Fundamental frequencies, 210
- Gas density balance, 254
phase reactions, 56
reactions, experimental technique, 57
- Glass diaphragm, 59
- Graphical representation Arrhenius equation, 23
- Heat of reaction, 17
- Hydrogen—iodine chloride reaction, 238
exchange in benzene, 259
- Infra red absorption, chemical significance of, 218
spectra, experimental technique, 202
spectrometer, 202
spectroscopy, 201
- Interatomic distance and energy, 222
- Interionic attraction theory, 111
- Ionic reactions, 110
- Ionic reactions, slow, 113
- Ionization of acetylene, 258
of sucrose, 258
- Isotopic carbon, 245
- Isotopic exchange in manganese ions, 261
- Isotopic exchange reactions of iodine, 261
- Isotopic tracers, 244
tracers, literature, 257
- Killing of bacteria, 199
- Kinetic theory of gases, 24
- Light emitted in electrical discharges, 187
sources, 127
- Mechanism of absorption, 120
acetone photolysis, 151
- Mercury lamp, 128
- Methyl ethyl ketone photolysis, 156
- M/N ratio, 189
- Monochromator, 131
- Morse curves, 224, 226
- Nitric acid, 184
- Nitrogen dioxide photolysis, 137
- Nitrogen tetroxide photolysis, 137
- Nitrogen pentoxide, 9, 10, 19, 34, 63, 65
at low pressures, 68
effect of foreign gases, 106
in nitric acid, 104
photolysis, 137
quantum yield with carbon dioxide, 146
saturated solutions, 102
solvent effects, 100
in solution, 100
- Order of reaction, 8
- Oxidation by X-rays, 196
- Oxygen effect in photobromination, 165
- Ozone, 185
- Phosphorus metabolism, 260
- Photobromination of cinnamic acid, 157, 235
- Photochemical kinetics, 124
principles, 118
reactions, literature, 176
- Photochemistry, 117
experimental technique, 127
- Photographic plate, action of electrons on, 199
- Photolysis of acetone, 147
beta-caryophyllene nitrosite, 167
nitrogen oxides, 137
nitrogen pentoxide in solution, 147
- Photosynthesis by chlorophyll, 172
- Potassium chlorate, decomposition by electrons, 200
- Quantum theory, 117
yield, 135
- Quantum yield in acetone, 149
bromination of cinnamic acid, 159
nitrogen oxides, 139, 142
nitrogen dioxide, 138
nitrogen tetroxide, 138
nitrogen pentoxide, 138
nitrosite, 168
- Quartz valve, 60
- Radiation energy, 122
hypothesis, 31
- Radio elements, production of, 261
- Raman spectra, 203
- Reactions in gas and solution, 93
solution, 90
- Reduced mass, 249
- Resonance, 216, 239
- Second order reaction, 12
- Semi-empirical method, 227
- Silent electric discharge, 184
- Sodium azide, decomposition by electrons, 200
- Solid phase, 65
- Solvation, 96
- Solvent effect, 96
- Specific reaction rate, 14

- Statistical mechanical calculation of rates, 239
- Temperature effects in photochemical reactions, 125
- Third order reaction, 12
- Thermopiles, 132
- Unimolecular decompositions, literature, 86
reactions, 13, 31, 243
theories of, 31
- Velocity constants, 14, 22
- Vitamin D by cathode rays, 193
ultraviolet light, 169
- Water metabolism, 259
- X-rays, biological systems, 197
X-rays and chemical effects, 195
- Zero order reaction, 13, 125
point energy, 250
- Φ , 124, 176
 λ , 176

THE GEORGE FISHER BAKER
NON-RESIDENT LECTURESHIP IN CHEMISTRY
AT CORNELL UNIVERSITY

1. *Physico-Chemical Metamorphosis and some Problems in Piezo-Chemistry*, by Ernst Cohen, Professor of Physical and Inorganic Chemistry, University of Utrecht, Pp. 190, octavo, cloth, 58 figures. \$2.50.
2. *Radio-Elements as Indicators, and Other Selected Topics in Inorganic Chemistry*, by Fritz Paneth, Professor of Inorganic Chemistry, University of Berlin. Pp. 164, octavo, cloth, 27 figures. \$2.50.
3. *Muscular Movement in Man: The Factors Governing Speed and Recovery from Fatigue*, by A. V. Hill, Foulerton Research Professor of the Royal Society of London. Pp. 104, octavo, cloth, 32 figures. \$2.50.
4. *Salts, Acids and Bases: Electrolytes: Stereochemistry*, by Paul Walden, Professor of Chemistry, University of Rostock, Germany. Pp. 397, octavo, cloth, 26 figures, \$3.00.
5. *Some Applications of Organic Chemistry to Biology and Medicine*, by George Barger, Professor of Chemistry in its Relations to Medicine, University of Edinburgh. Pp. 186, octavo, 5 figures. \$2.50.
6. *The Chemistry of the Monosaccharides and of the Polysaccharides*, by Hans Pringsheim, Professor of Chemistry, University of Berlin. Pp. 413, octavo, cloth, 8 figures. \$3.00.
7. *Spatial Arrangement of Atomic Systems and Optical Activity: Results and Problems of Precise Measurements at High Temperatures: Constitution and Structure of Ultramarine*, by F. M. Jaeger, Professor of Physical and Inorganic Chemistry, University of Groningen, Holland. Pp. 450, octavo, cloth, 137 figures. \$2.25.
8. *The Wave Mechanics of Free Electrons*, by G. P. Thomson, Professor of Natural Philosophy, University of Aberdeen. Pp. 172, octavo, cloth, 53 figures. \$2.50.
9. *Radio-Elements and Isotopes: Chemical Forces and Optical Properties of Substances*, by Kasimir Fajans, Professor of Physical Chemistry, University of Munich. Pp. 125, octavo, cloth, 34 figures. \$2.50.
10. *Chemical Analysis by X-Rays and Its Applications*, by Georg von Hevesy, Professor of Physical Chemistry, University of Freiburg in Baden. Pp. 333, octavo, cloth, 101 figures. \$3.00.
11. *Some Physical Properties of the Covalent Link in Chemistry*, by N. V. Sidgwick, Fellow and Tutor in Chemistry, Lincoln College, Oxford. Pp. 250, octavo, cloth, 7 figures. \$2.00.
12. *Researches on the Hydrides of Boron and Silicon*, by Alfred Stock, Director of the Chemical Institute, Technische Hochschule, Karlsruhe, Germany. Pp. 250, octavo, cloth, 36 figures. \$2.00.
13. *The Chemistry of Solids*, by C. H. Desch, Professor of Metallurgy, University of Sheffield. Pp. 230, octavo, cloth, 55 figures. \$2.50.
14. *Applied Radiochemistry*, by Otto Hahn, Director of the Kaiser Wilhelm Institut für Chemie, Berlin-Dahlem. Pp. 278, octavo, cloth, 69 figures. \$2.50.
15. *Atomic Structure of Minerals*, by W. L. Bragg, Langworthy Professor of Physics in the Victoria University of Manchester. Pp. 293, octavo, cloth, 144 figures. \$3.75.
16. *Selected Topics in Colloid Chemistry*, by Ross Aiken Gortner, Professor of Agricultural Biochemistry in the University of Minnesota. Pp. 169, octavo, cloth, 35 figures. \$2.50.
17. *Chemical Kinetics*, by Farrington Daniels, Professor of Chemistry in the University of Wisconsin. Pp. 273, octavo, cloth, 41 figures. \$3.25.

