

BIVALVIA FROM THE
ENGLISH LOWER OXFORD CLAY
(MIDDLE JURASSIC)

K. L. DUFF

PALAEONTOGRAPHICAL
SOCIETY

December 1978

BIVALVIA FROM THE
ENGLISH LOWER OXFORD CLAY
(MIDDLE JURASSIC)

K. L. DUFF

Pages 1–137: Plates 1–13

Publication No. 553, issued as part of
Volume 132 for 1978

Recommended reference to this publication:

DUFF, K. L. 1978. *Bivalvia* from the English Lower Oxford Clay (Middle Jurassic).
Palaeontogr. Soc. [Monogr.], 137 pp., 13 pls.

ABSTRACT

The bivalve fauna of the Lower Oxford Clay (Callovian, Middle Jurassic) is described, and an outline of the palaeoautecology of each genus is given. The fauna comprises 46 species (6 new), assigned to 30 genera, and two species considered *incertae sedis*. The genus *Mesosaccella* is transferred from the Nuculanidae to the Malletiidae. In addition, detailed stratigraphic descriptions and measured sections are given for the four main exposures of the Lower Oxford Clay in England.

Bivalves de la Lower Oxford Clay d'Angleterre (Jurassique Moyen)

RÉSUMÉ

La faune de Bivalves de la Lower Oxford Clay (Callovien, Jurassique moyen) comprend 46 espèces (dont 6 nouvelles) attribuées à 30 genres. Un aperçu de la paléoauteologie de chaque genre est donné. Une description stratigraphique détaillée avec des sections mesurées pour les quatre principaux affleurements de la Lower Oxford Clay d'Angleterre complètent l'ensemble.

Muscheln aus dem englischen Unteroxford-Ton (Mittlerer Jura)

ZUSAMMENFASSUNG

Die Muschelfauna des Unteroxford-Tons (Callov, Mittlerer Jura) enthält 46 Arten (6 neu), die 30 Gattungen zugewiesen werden. Für jede Gattung wird eine Übersicht über die Paläoautökologie gegeben. Für die vier hauptsächlichsten Aufschlüsse des Unteroxford-Tons in England werden detaillierte stratigraphische Beschreibungen und gemessene Profile beigelegt.

Двустворки из Нижней Оксфордской Глины (средняя юра) Англии.

РЕЗЮМЕ

Описание двустворок Нижней Оксфордской Глины (келловей, средняя юра) включает 46 видов (6 новых), отнесенных к 30 родам. Для каждого рода кратко даются палеоэкологические особенности. В работу включены детальное стратиграфическое описание изученных разрезов по четырем основным обнажениям Нижней Оксфордской Глины в Англии.

Made and printed in Great Britain

Adlard & Son Ltd., Bartholomew Press, Dorking

BIVALVIA FROM THE ENGLISH LOWER OXFORD CLAY (MIDDLE JURASSIC)

CONTENTS

	Page
INTRODUCTION AND ACKNOWLEDGEMENTS	2
PREVIOUS RESEARCH	4
STRATIGRAPHY AND LOCALITIES	6
FACIES ANALYSIS OF THE LOWER OXFORD CLAY ..	10
PRESERVATION	12
CONVENTIONS AND TECHNIQUES	13
BIVALVE AUTECOLOGY	15
SYSTEMATIC DESCRIPTIONS	19
Order Nuculoida	
Nuculidae	19
Mallettiidae	27
Order Solemyoida	
Solemyidae	30
Order Arcoida	
Parallelodontidae	33
Order Mytiloida	
Mytilidae	40
Pinnidae	43
Order Pterioida	
Pteriidae	45
Inoceramidae	48
Posidoniidae	51
Oxytomidae	53
Entoliidae	61
Pectinidae	65
Plicatulidae	75
Gryphaeidae	76
Order Trigonioida	
Trigoniidae	85
Order Veneroida	
Lucinidae	90
Astartidae	93
Cardiidae	101
Arcticidae	104
Order Myoida	
Corbulidae	111
Order Pholadomyoida	
Pleuromyidae	114
Thraciidae	117
Incertae sedis	120
REFERENCES	121
INDEX	131

INTRODUCTION AND ACKNOWLEDGEMENTS

The bivalve faunas of much of the British Middle and Upper Jurassic are well known, due to the monographs of Morris & Lycett (1853–55) and Lycett (1863) on Great Oolite bivalves, Lycett (1872–79) on Trigoniidae, Blake (1905–07) on the Cornbrash fauna, and Arkell (1929–37) on the bivalves of the Corallian Beds. However the Oxford Clay has very poorly documented bivalve faunas, in spite of the abundance of molluscan remains. In the course of studies on the palaeoecology of the Lower Oxford Clay (Middle Callovian) of England, the need for systematic accounts of its faunas became apparent. Accordingly, large collections have been made from the British Oxford Clay; these, and collections housed in the major museums, make up the material described here.

Fossils are abundant throughout the Lower Oxford Clay. Molluscs dominate the fauna, which is discussed in general terms in the section on previous work. Preservation is variable, but usually very good, the shell often being preserved unchanged; the abundance of well-preserved specimens allows variation studies to be made.

There is some overlap with the faunas of both the Great Oolite beneath, and the Corallian Beds above; as monographs exist for the bivalves of both those formations, the species in question are treated in brief. In the few cases where Bathonian species persist into the Oxford Clay, it has been necessary to redescribe and discuss them as there has been no adequate study of British Bathonian bivalves. This causes the present work to overlap with those of Morris & Lycett (1853–55) and Lycett (1863; 1872–79).

There is greater overlap with the bivalve fauna of the Corallian Beds (Arkell 1929–37). In order to bring the species in question (about 10) in line with the others considered here, and in view of his sometimes scant descriptions, the diagnosis and description are given in detail, while the discussions complement those of Arkell, except on points of contention, which are considered more fully. In synonymies of species described by Arkell, only the first and subsequent important British records are given here, together with records post-dating Arkell's work. The synonymies of species not discussed by Arkell are given in full, the British figured and cited specimens having been examined where available. In the case of foreign species and records, the type specimens, or photographs of them, have been examined where possible.

Most of the work for this monograph was undertaken during the tenure of a Natural Environment Research Council Studentship in the Department of Geology, Leicester University. I am especially grateful to my supervisor, Dr J. D. Hudson, for offering invaluable suggestions on many aspects of the work. I am grateful to the late Professor P. C. Sylvester-Bradley for the use of departmental facilities, and for stimulating discussion, particularly of the oysters.

I thank the London Brick Company and their Chief Geologist Mr J. L. Horrell for allowing me unrestricted access to their pits throughout the period of my research.

I thank the curators of the following institutions from whom I have borrowed specimens (abbreviated prefixes of specimen numbers given in brackets): British Museum (Natural History) (BM); Bristol City Museum (BCM); Leicester City Museum (CML); Institute of Geological Sciences, London (GSM); Laboratoire Paléontologique du Musée National d'Histoire Naturelle, Paris (MHNP); Oxford University Museum (OUM); Roemer Museum, Hildesheim (RMH); Sedgwick Museum, Cambridge (SM); Bristol University (UB); Leicester University (UL); Yorkshire Museum, York (YM).

I am grateful for discussion and correspondence with: Dr R. M. Sykes, Dr J. H. Callomon, Mr C. P. Palmer and Mr R. V. Melville; Dr S. R. A. Kelly kindly provided translations from the Russian. I acknowledge a grant from the Bulman fund made available by the Council of the Palaeontographical Society for help with preparation of the text-figures.

Sincere thanks to my wife for typing the manuscript and for help with preparation of the plates.

TABLE 1. The Zones of the Callovian and Lower Oxfordian. After Callomon (1968), with modifications by Duff (in press).

STAGE		ZONE	SUBZONE	DIVISION	
OXFORDIAN	LOWER	Cardioceras cordatum	C. cordatum	UPPER OXFORD CLAY	
			C. costicardia		
			C. bukowskii		
		Quenstedtoceras mariae	C. praecordatum		
			C. scarburgense		
CALLOVIAN	UPPER	Quenstedtoceras lamberti	Q. lamberti	MIDDLE OXFORD CLAY	
			Q. henrici		
		Peltoceras athleta	K. (Kosmoceras) spinosum		
			K. (Lobokosmokeras) proniae		
			K. (L.) phaënum		
	MIDDLE	Erymnoceras coronatum	K. (Zugokosmokeras) grossouvrei	LOWER OXFORD CLAY	
			K. (Z.) obductum		
		Kosmoceras jason	K. (Gulielmites) jason		
			K. (G.) medea		
	LOWER	Sigaloceras calloviense	S. (Catasigaloceras) enodatum		KELLAWAYS ROCK
			S. calloviense		
			Proplanulites koenigi		
Macrocephalites macrocephalus		M. (Kamptokephalites) kamptus	KELLAWAYS CLAY		
		M. (M.) macrocephalus	UPPER CORNBASH		









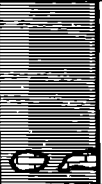

PREVIOUS RESEARCH

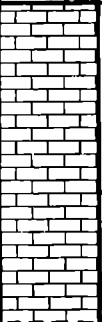
Early workers on the fauna and stratigraphy of the British Jurassic figured many fossils from the Oxford Clay (Phillips 1829, J. Sowerby 1812–23 and J. de C. Sowerby 1823–29). The status of the Oxford Clay within the Jurassic, and its local stratigraphy, were discussed at length by Woodward (1895), Brinkmann (1929), Arkell (1933a) and Callomon (1955, 1968); these works, together with those of Buckman (1913), Morley Davies (1916) and Neaverson (1925), attempted to fit the Oxford Clay into the standard system of Jurassic zones. The zonal sequence for the Callovian used here (Table 1), is that ratified by the International Geological Congress at their Luxembourg colloquium of 1962 (Callomon 1964, p. 288), with new subzones for the *athleta* Zone as introduced by Duff (*in* Torrens, *in* press).

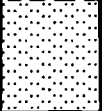
In addition to the rich bivalve fauna of the Lower Oxford Clay, there is an abundant invertebrate fauna (listed by Duff 1975, p. 446), most of which was described in the nineteenth century. The most common associates of the bivalves are ammonites, mainly belonging to the Kosmoceratidae (Buckman 1909–30; Brinkmann 1929a; Callomon 1955; Tintant 1963), although Hecticoceratidae (Pratt 1841; Zeiss 1956), Pachyceratidae (Morris 1850), and some Perisphinctidae transitional to *Peltoceras* (Pratt 1841; Mangold 1970) become locally abundant in the *coronatum* Zone. Callomon (1968) gave a summary of these ammonite faunas. Other occurrences of ammonites within the Oxford Clay were described by Pratt (1841), Leckenby (1859) and Arkell (1939a). Belemnites are also abundant: *Cylindroteuthis puzosiana* (d'Orbigny) is common throughout, *Belemnopsis sulcata* (Miller) is restricted to the transition beds at the base of the Lower Oxford Clay, and *Belemnoteuthis antiqua* Pearce is common in the bituminous shales of the *jason* Zone. The belemnite fauna was illustrated by Owen (1844), Pearce (1847), Mantell (1848, 1850) and Phillips (1865–70).

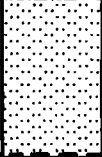
Gastropods occur throughout, but are not a diverse element of the fauna. Only five species have been recognized: most frequent are *Dicroloma bispinosum* (Phillips), *D. trifidum* (Phillips) and '*Procerithium*' *damone* (Lycett), although *Spinigera spinosa* d'Orbigny and *Pleurotomaria reticulata* (J. Sowerby) also occur. The gastropod fauna of the British Callovian is in need of revision, the last work of any consequence being that of Hudleston (1884–85). Scaphopods (*Prodentalium calvertense* Palmer) are abundant in bed 6 (Callomon 1968) at Calvert, and occur sporadically elsewhere. Lists and descriptions of mollusca other than cephalopods were given in Morris (1850), Leckenby (1859), Arkell (1939a), Walker (1972) and Palmer (1975). The crustacean fauna was described by McCoy (1849), Carter (1886) and Woods (1924–31); elements of it are most common in the bituminous shales of the *jason* and *coronatum* Zones, where a malacostracan, *Mecochirus pearcei* McCoy, is locally very abundant and generally well preserved (Förster 1971). The calcified shells of the polychaet worm, *Genicularia vertebralis* (J. de C. Sowerby), are common constituents of the *coronatum* Zone fauna, particularly in the calcareous clays. In the *jason* Zone, and parts of the *coronatum* Zone, occasional poorly-calcified serpulid worms, occur. Inarticulate brachiopods (*Lingula craneae* Davidson) are a fairly common component of the *jason* Zone fauna at all the pits, and are especially abundant in the deposit-feeder bituminous shales and the blocky claystone. Crushed rhynchonellids have been found in the silts and silty clays at Norman Cross and Bletchley. The final constituent of the invertebrate fauna is an ophiuroid which occurs rarely in the deposit-feeder bituminous shales, and may belong to '*Ophioderma*' *weymouthense* Lycett.

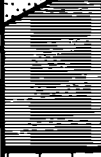
The Oxford Clay is famous for the profusion of well-preserved vertebrate remains which it contains, especially in its lower parts. The abundant reptile fauna includes ichthyosaurs, plesiosaurs, pliosaurs and crocodiles, which have been described by Andrews (1910; 1913), Appleby (1956; 1967), Tarlo (1960) and Persson (1963). More recent general reviews of the Oxford Clay reptile fauna have been published by Leeds (1956) and Delair (1958–60; 1966). In the well-laminated bituminous shales of the Lower Oxford Clay, it is not unusual to find complete articulated skeletons of representatives of all the reptile groups listed above, although disarticulated bones are more common in the shell beds. There is also a diverse fauna of fish, represented by

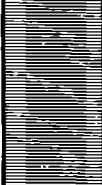
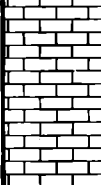
Northeast Yorkshire		ZONE	Central & Southern England		STAGE
Oxford Clay		Mariae		Upper Oxford Clay	Lower Oxfordian
Hackness Rock		Lamberti		Middle Oxford Clay	Upper Callovian
		Athleta			
hiatus					
Langdale Beds		Coronatum		Lower Oxford Clay	Middle Callovian
hiatus		Jason			
Kellaways Rock		Calloviense		Kellaways Rock	Lower Callovian
Shales of the Cornbrash		Macrocephalus		Kellaways Clay	
Upper Cornbrash					Upper Cornbrash
Upper Deltaic Series		Discus		Lower Cornbrash	Upper Bathonian

TEXT-FIG. 1. A comparison of the basal part of the Upper Jurassic of northeast Yorkshire with that of central and southern England. After Wright (1968). Not to scale. Key as for Text-fig. 3.

disarticulated bones and occasional complete skeletons. Work on the Oxford Clay fish faunas was documented by Woodward (1889–1901).

STRATIGRAPHY AND LOCALITIES

The Lower Oxford Clay occupies the whole of the Middle Callovian, and parts of the Upper and Lower Callovian substages, and rests on the silty Kellaways Rock. The basal junction usually occurs at the base of the *enodatum* Subzone, although the change from silt to clay is gradual, and in some places is not completed until the top of the *medea* Subzone. The top of the Lower Oxford Clay is not clearly marked palaeontologically, and is placed about one-third of the way up the *athleta* Zone where the bituminous shales of the Lower Oxford Clay, with abundant crushed aragonitic fossils, are overlain by blue or grey-green, plastic, apparently unstratified clays of the Middle Oxford Clay containing fewer crushed fossils; this change also heralds the appearance of pyritized ammonites.

This subdivision of the Oxford Clay only applies to the areas of England south of the Humber, as north of the Market Weighton region most of the Middle Callovian is cut out by an unconformity at the base of the *grossouvrei* Subzone (Wright 1968, p. 366), and that part remaining is developed in a more marginal facies of sandstones and limestones (Text-fig. 1). In Yorkshire, the *grossouvrei* Subzone is up to 20 m thick (Wright *op. cit.*, p. 368), and is represented by the Langdale Beds which are massive or flaggy, fine and medium-grained sandstones in which bivalves are not common. The overlying Hackness Rock (up to 2.4 m thick) belongs to the *athleta* and *lamberti* zones, and consists of poorly sorted sandy limestones and calcareous sandstones, becoming a chamosite oolite towards the top. Wright (*op. cit.*, p. 385) showed that there was another period of erosion at the base of the Hackness Rock, with rocks of Lower *athleta* Zone age being absent. Thus the only rocks of Middle Callovian age proved in Yorkshire are the Langdale Beds.

Damon (1860, 1888), Judd (1875) and Roberts (1889, 1892) divided the Oxford Clay into beds on the basis of preservation and fossil types, but it was not until the classic work of Brinkmann (1929), on the Lower and Middle Oxford Clay of Peterborough, that detailed bed-by-bed sections were recorded. Woodward (1895) and Arkell (1933a) summarized the early records of Oxford Clay exposures, but these are now of little more than historical interest. Detailed descriptions of the Lower Oxford Clay of the Midlands were given by Callomon (1955; 1968), and of parts of the Middle and Upper Oxford Clay of Buckinghamshire and Wiltshire by Arkell (1939a, 1941).

Geographical extent and thickness of the Oxford Clay

The Oxford Clay crops out in a wide belt extending from the Dorset coast at Weymouth across southern and eastern England to the Humber (Text-fig. 2). There it disappears in the area of Market Weighton, to reappear from beneath the Chalk cover farther north, before swinging around *the Vale of Pickering to meet the Yorkshire coast in the region of Scarborough. The clay facies is only to be found in its full development south of Market Weighton, as in the northern part of the Yorkshire outcrop, the clay facies does not begin until the mariae Zone, and much of the Middle Callovian is absent. Maximum thickness (up to 200 m) is in the Wiltshire region (Callomon 1968, p. 264); 130–170 m of Oxford Clay are seen at Weymouth (Arkell 1947, p. 25), 150 m in Berkshire (Falcon & Kent 1960, p. 14) and 85 m in Cambridgeshire (Callomon *op. cit.*, p. 264). The northward thinning is due in part to decrease in the amount of sediment deposited, and in part to subsequent erosion, there being particularly well-marked erosion surfaces at the base of the Amptill Clay (Upper Oxfordian) and Lower Greensand (Aptian). The Lower Oxford Clay has a fairly constant thickness of 16–25 m in the Midlands (Callomon 1968, p. 265), and 20 m in Dorset (Smith *in* Torrens 1969, p. A42). Data for the regions north of Cambridgeshire are not available, although it seems likely that there is overall thinning of all divisions of the Oxford Clay towards Market Weighton, in view of the reduced subsidence along the Market Weighton axis throughout the Jurassic.*

Exposures in the Lower Oxford Clay

At present, exposures of the Lower Oxford Clay are very limited, the only permanent natural section being at East Fleet near Charlestown, Weymouth (SY 6478) where bituminous shales of the *jason*, *coronatum* and *athleta* Zones are intermittently exposed in the low degraded cliffs and on the foreshore. The nature of the exposures is such that detailed stratigraphic data are unobtainable, although it is possible to find the zonal ammonites. Better sections are available in the disused brickpit owned by the Dorset Brick & Tile Co. at Crook Hill, Chickerell (SY 644797), where Smith (*in* Torrens 1969, p. A41) has described a detailed succession of beds belonging to the *jason* to *athleta* Zones. Lower zones (*koenigi* to *medea* Subzones) used to be visible in the adjacent Putton Lane brickyard (SY 649798) (Arkell 1947, p. 27). The only other permanent exposures are in the series of brickpits, mostly owned by the London Brick Company, between Calvert (Buckinghamshire) and Peterborough (Cambridgeshire). These pits have been described in detail by Callomon

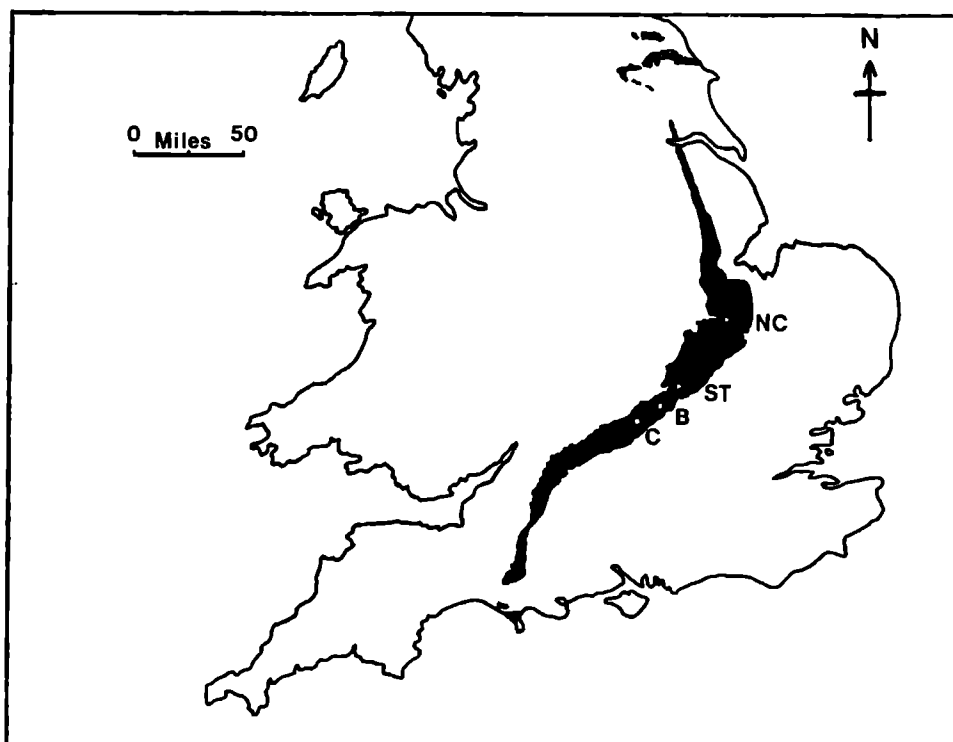

TEXT-FIG. 2. The outcrop of the Oxford Clay in England, and the location of the main sections studied. **B** = Bletchley; **C** = Calvert; **NC** = Norman Cross; **ST** = Stewartby.

(1968), and his sections have provided the basis for detailed collecting; some slight modifications to his stratigraphic scheme have been made and the revised sections are shown in Text-fig. 3, where they are compared with their equivalents in Yorkshire.

Descriptions of the four major pits examined

The successions at these pits are shown in Text-fig. 3; lithologies are described in the section on facies analysis below. Full details of the stratigraphy at each pit are deposited with the British Library at Boston Spa, as Supplementary Publication No. SUP 90027 (35 pages).¹ At all the pits except Calvert, the lowest beds exposed are the transition beds from the Kellaways Beds to the

¹ Copies can be obtained from the British Library (Lending Division), Boston Spa, Wetherby, West Yorkshire, U.K., on quoting the Supplementary Publication Number.

Oxford Clay, which are followed by a clear section up into the *athleta* Zone. At Calvert, however, the pit is worked down to a tough pyritic shell-bed within the *jason* Subzone, and the transition beds below are not seen.

In the placement of the subzonal and zonal boundaries, the work of Callomon (1968) has largely been used, especially within the thick shale sequences at Stewartby, Bletchley and Calvert. Text-fig. 3 shows the variation in thickness between Calvert and Norman Cross, and reveals a

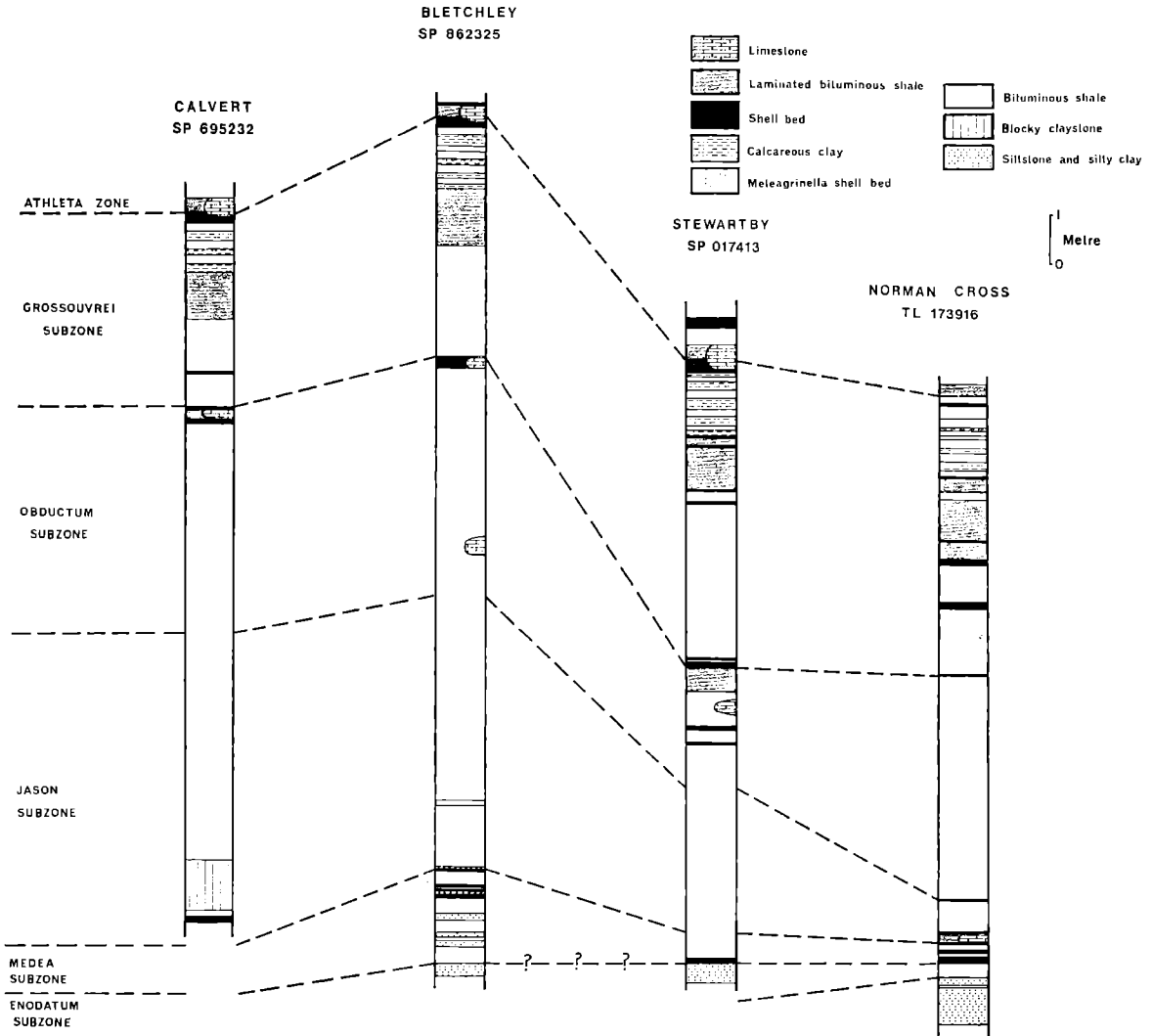

TEXT-FIG. 3. Lithological sections measured at the four main pits examined.

general thickening of the subzones southwards from Peterborough. This is most marked in the *enodatium* and *medea* subzones, which are condensed at Norman Cross and thicken rapidly southwards, reaching their greatest thicknesses in the Bletchley area. The *obductum* and *grossouvrei* subzones generally have a more constant thickness over the whole of the East Midlands, indicating that conditions had become stable over a more widespread area by that time. This view is supported by the succession seen in the *grossouvrei* Subzone at all four pits, where *Grammatodon*-rich bituminous shales are followed by foraminifera-rich bituminous shales and then an alteration of calcareous clays and *Meleagrinnella* shell-beds, the subzone being capped by the *comptoni* Bed of Callomon

(1968, p. 272). No such close correlation of sequences is possible within the *calloviense* or *jason* zones, partly because of the variation in thickness, and partly because the *jason* Zone is usually represented only by bituminous shale.

(i) Norman Cross, Peterborough (TL 172916). The sequence here is more condensed than at any of the other pits. The presence of a large drainage sump in the floor of the pit has allowed examination of the transition beds and the uppermost part of the Kellaways Rock.

The lowest 1.00 m exposed consists of massive yellow-green micro cross-laminated siltstones, becoming more clayey towards the top, with occasional partings of green shaly clay; this is placed within the Kellaways Rock. The fauna is dominated by *Cylindroteuthis* and gryphaeate oysters, with local lenses rich in *Nicaniella* (*Trautscholdia*), *Meleagrinnella* and *Grammatodon concinnus*. The *enodatum* and *medea* subzones are only 0.63 m thick, and consist of an alternation of *Gryphaea* shell-beds, rich in gryphaeate oysters and belemnites, and green, fissile shaly clays with *Bositra*, *Meleagrinnella* and *Grammatodon concinnus*. These transition beds are allocated to the Oxford Clay; the top of the Kellaways Rock is placed at the top of the *calloviense* Subzone, where the cross-laminated silts disappear.

At the base of the *jason* Subzone are two shell-beds, separated by a thin papery bituminous shale containing occasional septarian concretions; the concretions often contain uncrushed aragonitic ammonites infilled by sparry calcite. The shell-bed above the paper shale has a rich fauna of *G. concinnus*, *Nicaniella* (*Trautscholdia*) and *Protocardia*, and an ammonite plaster at its base. The rest of the *jason* Subzone, and the whole of the *obductum* Subzone, with the exception of a thin nuculacean shell-bed at their junction, consists of a thick sequence of deposit-feeder bituminous shales, with occasional *Meleagrinnella* plasters, especially towards the top.

The base of the *grossourei* Subzone coincides with the appearance of *Grammatodon minimus*, a situation which prevails throughout the East Midlands, and is also seen in Dorset. The 'normal' *grossourei* Subzone succession, as detailed above (and shown in Text-fig. 3), is developed at Norman Cross, except that the calcareous clay facies are sometimes replaced by deposit-feeder bituminous shales. The topmost bed of the *grossourei* Subzone here, as everywhere in the East Midlands except Stewartby is the *comptoni* Bed. It consists of a nuculacean shell-bed containing abundant ammonites transitional between Perisphinctidae and *Peltoceras*, and is overlain by the deposit-feeder bituminous shales of the *acutistriatum* Band, marking the base of the *athleta* Zone; there is no concretionary limestone development at this level at Norman Cross.

(ii) Stewartby, Bedford (SP 017412). In the Bedford area, the silty Kellaways Rock continues to the top of the *enodatum* Subzone, where it is overlain by the pyritic 'basal shell-bed'. This consists of two shell-beds separated by 2 cm of green clay containing *Bositra* and comminuted shells. The upper shell-bed consists of an ammonite plaster resting on a *Grammatodon* shell-bed with a diverse bivalve fauna, and also containing occasional reptile bones and fish teeth; the lower *Gryphaea* shell-bed contains also belemnites and ammonites.

The *medea*, *jason* and lower part of the *obductum* subzones are developed in the deposit-feeder bituminous shale facies, the fauna being dominated by *Palaeonucula*, *Mesosaccella*, *Procerithium* and 'pendent' epifaunal suspension-feeders. The upper part of the *obductum* Subzone differs from elsewhere; instead of bituminous shale, 0.75 m of foraminifera-rich bituminous shale is developed, followed by a pyritic shell-bed immediately beneath a thick *Meleagrinnella* shell-bed. Isolated nodules occur towards the top of the *Meleagrinnella* shell-bed, but they are notably less clearly septarian than at other pits, and contain fewer uncrushed fossils.

The *obductum-grossourei* subzonal boundary was not identified here by Callomon (1968, p. 281); similarly the author's collections have not located the exact level at which *K. (Zugokosmokeras) grossourei* replaces *K. (Z.) obductum*. Other species, however, may be of use in placing the boundary. The appearance of *K. (Spinikosmokeras) pollux* and species of *Hecticoceras* for instance are features usually associated with the start of the *grossourei* Subzone, and as shown at the other three pits, the appearance of *G. minimus* is possibly as useful. At Stewartby, the appearance of *G. minimus*, *K. (S.) pollux* and *Hecticoceras* is almost synchronous and the base of the *grossourei* Subzone is, therefore, placed at the well-developed pyritic shell-bed containing the first abundant *G. minimus*. The *grossourei* Subzone shows the same development as at the other East Midlands pits, except at the top, where the *comptoni* Bed lies above the so called *acutistriatum* Band limestone, the two being separated by 0.35 m of deposit-feeder bituminous shales. The lack of *K. (S.) acutistriatum* in this concretionary limestone, the species only being found above the *comptoni* Bed, indicates that the term *acutistriatum* Band should not be applied to the concretionary limestone at Stewartby; the base of the *athleta* Zone is some 0.40 m above the concretionary limestone.

(iii) Bletchley (SP 862325). Here, the transition beds between the Kellaways Beds and the Oxford Clay reach almost to the top of the *medea* Subzone, and consist of thin alternations of silts and silty clays, *Gryphaea* shell-beds and bituminous shales. The shell-beds have a gryphaeate oyster-belemnite-ammonite association, whilst the bituminous shales are of the deposit-feeder facies.

The *jason* Subzone has a thin pyritic *Gryphaea* shell-bed at its base. It is overlain by a very thin *Meleagrinnella* shell-bed, which passes up into a thick sequence of deposit-feeder bituminous shales which persist for the remainder of the *jason* Subzone and virtually the whole of the *obductum* Subzone, except for a nuculacean shell-bed at the top. Septarian concretions occur randomly throughout 1 m near the middle of the *obductum* Subzone; some of the concretions have a pyritic coating, and fine pyrite linings to the calcite veins. Occasional earthy limestone concretions occur within the shell-bed at the top of the *obductum* Subzone.

probably referable to *K. (G.) jason* (Reinecke). The restricted occurrence of these body chambers is due either to exceptional preservation in the claystone facies, perhaps aided by greater resistance to flattening, or these deposits may be absent at the other pits due to a non-sequence.

Calcareous clays. At the four pits examined, the upper part of the *grossouvrei* Subzone consists of an alternation of *Meleagrinnella* shell-beds and calcareous clays, in beds about 0.20 m thick. The calcareous clays are light grey or grey-green, rather plastic, apparently unlaminate, and have a soluble fraction as high as 40%, the equivalent figure for the bituminous shales being 10–20%. Faunally, deposit-feeding Nuculacea (*Mesosaccella*, *Palaeonucula*) persist, but are joined by a new fauna of infaunal and benthonic epifaunal suspension-feeders such as *Discomiltha*, *Isocyprina*, *Myophorella*, *Entolium* and *Gryphaea*, and the annelid *Genicularia*. Particularly characteristic of this biofacies is the abundance of small specimens of *Entolium* sp. A.

PRESERVATION

Several different modes of preservation are present in the Lower Oxford Clay, and these play an important role in determining how much detail may be seen in any particular shell. Most of the bivalves are preserved in their original shell mineralogy, which is dominantly aragonite, except for the mainly calcitic Pectinacea and Ostreacea. The original shell material may be crushed or uncrushed, often depending upon its degree of inflation, and whether it is an isolated valve or articulated. Articulated shells are much more frequently crushed than isolated valves, probably because they were buried without having the space between the valves completely filled with clay. It is difficult to extract aragonitic valves in an unbroken state, and it is usually therefore only possible to examine one valve surface. However, examination of many specimens allows a complete picture of the morphology to be built up, especially when the species sometimes occurs as pyritized casts, as in the Nuculoida. The aragonite usually shows no obvious signs of dissolution, although it is never as strong as the aragonite of Recent shells, suggesting that there must have been some chemical change; shell micro-structure is preserved. Calcite shells appear to be more resilient, and are usually preserved uncrushed, whether isolated or articulated. It is often possible to extract calcitic shells from the rock, so both surfaces may be examined. Again, preservation is so good that shell micro-structure may be seen.

Many shells, both aragonitic and calcitic, have variably developed overgrowths of pyrite, particularly in the more bituminous horizons. The pyrite is usually patchily developed in shells found in the massive shaly clays, and in these beds, seems to be concentrated on the aragonitic shells such as *Thracia*, *Pinna* and *Palaeonucula*. Hudson & Palframan (1969, p. 404) described a similar situation in the Middle and Upper Oxford Clay of Woodham, Bucks., on bivalves preserved as clay moulds. They attributed the pyrite formation to local sulphate reduction by bacteria acting on the organic matrix of the dissolving shell, and this is possibly the case in the Lower Oxford Clay, although the aragonite remains.

The shell-beds developed in the *jason* and *coronatum* zones often contain shells and valves which have been completely replaced by pyrite, as do the transition beds in which *Palaeonucula*, *Mesosaccella*, *Myophorella*, *Discomiltha*, *Grammatodon*, *Nicaniella* (*Trautscholdia*), *Neocrassina* (*Pressastarte*) and *Isocyprina* are affected. Most of the pyrite is stable and from these pyrite-replaced valves details of dentition and the shell interior may frequently be obtained. No shell microstructure is visible in these pyritized moulds.

In a final preservation type the original calcite or aragonite shell has been wholly or partially covered with a layer of secondary calcite. The calcite is not easily removed, and often will not part from the original shell, making observations of surface detail impossible. This type of preservation is dominant in the *Meleagrinnella* shell-beds at the top of the *grossouvrei* Subzone, but occurs throughout the Lower Oxford Clay. It is seen most frequently on Pteriacea and Pectinacea, although *Palaeonucula* and *Mesosaccella* are also particularly susceptible.

Unlike the situation described by Hudson & Palframan (*op. cit.*), these preservation types are not controlled by shell mineralogy, as several different preservation types are known in most species. This suggests that in the more bituminous Lower Oxford Clay, it was physico-chemical factors, rather than the original shell composition, which governed preservation. Because of the range of preservation types found in many species, it is sometimes possible to get more detailed information. For example, details of the cardinal regions are best displayed on pyritized shells, but in order to examine the shell micro-structure, original shell material must be used. It is possible to see colour banding in some aragonitic specimens of *Palaeonucula*, although it is uncertain whether this represents original shell marking.

CONVENTIONS AND TECHNIQUES

Terminology

The morphological terms used in this work are broadly those listed and defined by Cox (1969, p. N102–N109) and Stenzel (1971, p. N1028–N1034), although the usage of some terms, such as escutcheon and corselet, have been amended in the taxonomic discussions.

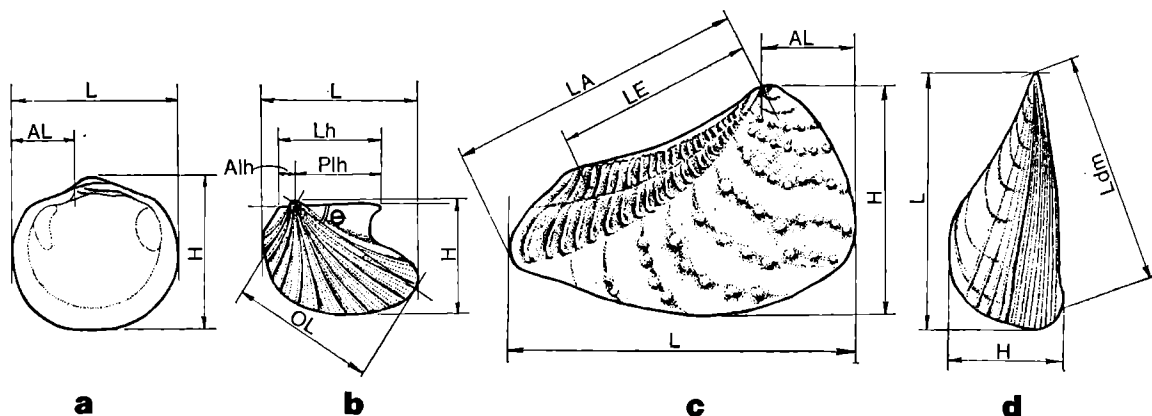

TEXT-FIG. 4. Schematic view of representatives of each of the four major bivalve forms present in the Lower Oxford Clay, showing the measurements used in the descriptions of the species. **a.** Nuculacea, Nuculanacea, Solemyacea, Astartacea, Cardiacacea, Arcticacea, Lucinacea, Myacea, Pholadomyacea, Pandoracea. **b.** Arcacea, Mytilacea, Pteriacea, Pectinacea. **c.** Trigoniacea. **d.** Pinnacea.

Measurements (Text-fig. 4) were made using a pair of vernier calipers, giving measurements correct to 0.1 mm, although in crushed specimens, and in some specimens which proved impossible to isolate from the matrix, the accuracy is to the nearest mm. Angular measurements were made with a simple contact goniometer constructed from a clear plastic protractor.

Length (L) was measured parallel to the long axis of the ligament in most heterodonts (Text-fig. 4a) and the Trigoniacea (Text-fig. 4c). This axis is nearly parallel to the line joining the centres of the adductor muscle scars, thus enabling measurements to be made on specimens with a poorly defined ligament. In superfamilies possessing a long, straight hinge-line (Text-fig. 4b), length was measured parallel to the hinge-line, at the widest point of the shell.

Height (H) was always measured as the maximum dimension perpendicular to the length, passing through the umbones and the ventral margin.

Likewise, *inflation* (I) was always measured perpendicular to length and height, and is the distance between the plane of the commissure and the point on the shell exterior perpendicularly farthest away from this plane. Measurements given in the tables are for the combined inflation of both valves, except in the Pteriacea and Pectinacea, where the inequivalve shell has different inflation of opposing valves. The inflation of each valve is listed in these superfamilies.

Anterior length (AL) is the distance from the points of the umbones to the anterior margin of the shell, measured parallel to length (Text-fig. 4a–4c).

In the Arcacea, Pteriacea, Pectinacea and Mytilacea (Text-fig. 4b) it is possible to measure the *length of the straight hinge-line* (Lh), which can be further subdivided into the portions *anterior* (ALh) and *posterior* (PLh) to the umbones. In the Nuculoida, hinge-line lengths are measured directly along their long axes, regardless of the axis of shell length.

In the four superfamilies mentioned above (Text-fig. 4b), it is also possible to measure the *degree of obliquity* of the shell in two ways: the *oblique length* (OL) is measured from the umbones to the posteroventral angle, while the *angle* θ is the angle between the hinge-line and the oblique length. In some Arcacea the posterodorsal angle is also measured.

In the Trigoniacea (Text-fig. 4c) the presence of the posterior area introduces more terms which may be used to define shell form. The *escutcheon length* (LE) is measured from the umbones to the point where the escutcheon carina meets the margin, while the *length of the area* (LA) is measured from the umbones to the posteroventral angle. Both these measurements are taken as straight lines, and do not follow the contours of the shell. The *escutcheon width* (EW) is measured across both valves, perpendicular to the plane of the commissure. The *number of tubercle rows* is represented by the letters TR.

In the Pinnacea (Text-fig. 4d) *length* is measured from the umbones, which are placed anteriorly, to the point where the median carina meets the posterior margin; *height* is measured perpendicular to this, near the posterior extremity. The *length of the dorsal margin* (LDM) is measured in a straight line from the umbones to the posterodorsal angle. In many specimens the posterior is incomplete, making precise measurement impossible.

Where the terms length and height are applied to features such as muscle scars, the features are measured parallel to the major shell dimensions. In the tables of measurements length is recorded in mm, and the other measurements are recorded as percentages of it, in order to facilitate comparisons between species, and give a clear idea of the variation of each measured character. Measurement percentages are given in the taxonomic descriptions, and details of all measured specimens have been deposited with the British Library at Boston Spa, Wetherby, West Yorkshire, U.K. as Supplementary Publication No. SUP 90033 (99 pages).

In the descriptions, the terms small, medium and large are defined by the following size ranges: small, up to 10.0 mm long; medium, 10.1 to 30.0 mm; large 30.1 mm and over. The criterion of adulthood in all species is the crowding of growth-lines towards the ventral margin.

Variation

Study of the large collections made by the author has revealed a high degree of variability in Middle Callovian bivalves, both in form and ornamentation. Variation is usually continuous, however, and there are no reasons for separating variants at any horizon. The measurements of all specimens, and the statistics derived from them, have been deposited with the British Library as Supplementary Publication No. SUP 90033 (99 pages) [see footnote, p. 7]. Basic statistics used in the species descriptions are:

- N = number of observations made.
- \bar{x} = arithmetic mean of the observations.
- Max = maximum observed value of each group of observations.
- Min = minimum observed value of each group of observations.
- OR = observed range of the observations.

In addition to the numerical data, scatter diagrams and regression lines have been plotted for certain species to show a contrast between different populations. The slopes and positions of the regression lines were obtained by using a Hewlett-Packard Model 10 programmable calculator, and plotted on arithmetic scales; the results are discussed at the relevant points in the text.

Preparation

In view of the usually soft matrix most specimens were prepared with a mounted needle. However, in some of the limestone bands and pyritized shell-beds it was necessary to use a 'Burgess' vibro-engraver, or even a Desoutter VP2 compressed-air drill, to remove harder matrix. The friability of many species made it essential to harden the shell material to prevent breakage, and for this purpose, a solution of Vinamul 6525 dissolved in toluene proved the most useful, although it sometimes gave a slight gloss to the surface, making photography more difficult.

Serial sections were made of *Rollierella minima* to show details of the dentition. To produce these sections, the specimen was mounted in 'Cristablik' and the resulting block secured to a metal plate with Lakeside 70 adhesive. Serial sections were then taken at regular intervals by grinding down the block on a Speedlap rotary grinder, and making an acetate peel of the resulting surface.

Casts were made of external moulds, using a mixture of ICI Silcoset 105 and carbon black. The resulting casts were then an ideal colour for coating with ammonium chloride for photographic purposes. The fine-grained nature of the shales and clays produces highly detailed casts.

The photographs were taken by the author with a Leica camera and bellows, the specimens having been coated with ammonium chloride; many specimens were first darkened with a thin solution of Barlow's opaque before whitening.

BIVALVE AUTECOLOGY

Although the palaeoecology of the Lower Oxford Clay has been considered elsewhere (Duff 1975), consideration of the autecology of the bivalves adds substantially to our understanding of them. There are many difficulties involved in attempting to deduce the modes of life of fossil species, especially in groups which have left no living relatives; even where the habits of Recent species are known, there are often problems of interpretation. However, by utilising the observation made by Stanley (1968, p. 217), that all living representatives of any given superfamily fall within one, or rarely two feeding groups, coupled with an analysis of the functional morphology of each genus, it is possible to deduce the feeding habits and what ecological niche any genus occupied. Previous workers, such as Yonge (1939, 1946, 1949, 1953) and Allen (1958) concentrated on the functional adaptations of particular taxonomic groupings, but Stanley (1970) produced a general study of relationships between the form of the bivalve shell and the mode of life of the animal which lived within it; his conclusions have been used as a basis for many of the interpretations of life habits suggested here. One of his most important observations was that some structural adaptations occur in more than one taxonomic group, indicating that there has been parallel evolution.

Most ecological groupings have been based on mode of life, substrate type or feeding groups. Hudson & Palframan (1969) used mode of life and feeding groups in their study on the palaeoecology of the Middle to Upper Oxford Clay of Woodham. Rhoads *et al.* (1972) emphasized the importance of feeding groups in palaeoecological analysis, and suggested that the distribution of suspension- and deposit-feeding bivalves is controlled in part by the sediment grain-size and texture, by the degree of bottom turbidity and by the availability of food resources. This suggests that feeding groups are the most useful means of splitting bivalves into ecological groups, as data gleaned from substrate type is also used. Mode of life observations may be used to further subdivide the feeding groups.

On this basis, three major bivalve feeding groups may be recognized in most Recent and fossil assemblages, including the Lower Oxford Clay. The suspension-feeders are divided by mode of life into epifaunal and infaunal types, while all deposit-feeders are infaunal. Below, each major feeding group is considered in general terms and individual genera are then discussed. The data are summarized in Table 2.

Epifaunal suspension-feeders. Bivalves of this type lived on or above the sediment surface, and most were attached by a byssus at some stage in their life history, although there is some doubt as to

whether all genera were attached to objects on the sea floor. They fed by filtering suspended food particles out of the water which was drawn over the ctenidia by ciliary currents. The recognition of epifaunal suspension-feeders in the Oxford Clay is relatively easy, as most possess a byssal notch; most belong to the Pectinacea.

- Modiolus* A nestling mytilid (Stanley 1972, p. 171), the byssus emerging through the anterior ventral region; there appears to be no byssal gape in the Oxford Clay forms.
- Parainoceramus* An equivalve pteriacean lacking an obvious byssal apparatus, and having hinge teeth in addition to the multiple ligament pits. Kauffman (1967, p. 104) believed that *Inoceramus* (*Mytiloides*) *labiatus* (Schlotheim), an Upper Cretaceous species similar in morphology to *P. subtilis*, lay weakly attached or free on the substrate, and was most abundant in middle shelf clays. A similar mode of life seems probable for *P. subtilis*, although there is a tendency for the species to occur in clusters, and Sykes (pers. comm. 1973), has noted inoceramid plasters associated with wood bands in the Oxford Clay of Scotland. Stanley (1972, p. 189) on the other hand, compared *I. (Mytiloides) labiatus* with mytilids, and suggested that it was semi-infaunal and byssally attached. In view of the clustering of the specimens found in the Lower Oxford Clay, this interpretation seems unlikely.
- Pteroperna* A subequivalve pteriacean with a long pointed posterior auricle, but no apparent byssal notch. Recent species of *Pteria*, a genus rather similar in form, often live byssally attached to alcyonarian sea whips (Stanley 1972, p. 189), the posterior auricle serving as a means of keeping the inhalent and exhalent currents separate. A similar mode of life is here assumed for *Pteroperna*, although preservation does not allow the recognition of a byssal notch; it is also unlikely that the attachment substrate was an alcyonarian.
- Pinna* Yonge (1953) has shown that Recent pinnids live vertically embedded in the sediment, anterior end downwards, with much of the shell protruding above the sediment surface. A similar life style is invoked for the Jurassic species, some specimens of *P. mitis* from the Oxford Clay of Woodham being found upright in presumed life position (Hudson & Palframan, 1969).
- Bositra* *B. buchii* (see Jefferies & Minton, 1965; this monograph) is thought to have been nektoplanktonic, but possibly may have been attached to floating weed, or other organic material. It is also possible that the organic material was rooted to the sea floor. The term pendent is here used for this mode of life.
- Oxytoma* & *Meleagrinella* Inequivalve pectinaceans with a deep byssal notch, but no ctenolium, although some specimens have weak nodes on the external surface of the right anterior auricle. There is a marked tendency for specimens of both genera to occur in clusters. In view of the very soft nature of the Oxford Clay substrate, it is unlikely that pectinaceans could have survived lying directly on the sea floor, so a pendent mode of life is postulated.
- Entolium* A thin-shelled subequivalve pectinid, sometimes byssally attached in its juvenile stages, but rapidly losing the byssus and byssal notch. The large umbonal angle (about 100°), the thinness of the shell, and the lack of a byssus in the adult state, suggest a free-living form capable of swimming.
- Entolium* sp. A. A small entoliid with a byssal notch, but no ctenolium, only becoming abundant in the calcareous clays at the top of the *grossourei* Subzone. The small size and persistence of the byssal notch indicate a functional byssus. Probably this species was byssally attached to organic material, either floating or near the bottom.
- Camptonectes* Strongly byssate in all life stages, with a well-developed ctenolium; attached closely to the substrate through life (Speden, 1967, p. 17).
- Chlamys* Both *C. (Chlamys)* and *C. (Radulopecten)* are inequivalve pectinids with byssal notches, the Middle Callovian forms (with the exception of *C. (R.) scarburgensis*) being of small size. This species may have been free-swimming in the adult stage, but it is probable that all the other species were byssally attached throughout life to objects on the sea floor.
- Plicatula* A cemented inequivalve pectinacean, attached to the substrate by the right valve throughout life (Yonge 1973).
- Gryphaea* A free-living oyster, cemented to the substrate in its juvenile stages, but lying free at the sediment surface for most of its life, convex left valve downwards, lid-like right valve horizontal. Sessile after spat settlement.
- Nanogyra* A cemented oyster, usually fixed to the substrate by the left valve throughout life. In a few cases, the attachment may be lost, the shell then lying free on the sediment.

Infaunal suspension-feeders. Stanley (1968, p. 217) recognized the existence of three groups of infaunal suspension-feeding bivalves, all of which are represented in the Oxford Clay. Infaunal

non-siphonate suspension-feeders are mostly active burrowers (Trigoniacea, Astartacea, some Carditacea and Arcacea), which move about at or near the sediment-water interface, and draw in water currents through the sediment. Infaunal siphonate suspension-feeders have shown the greatest evolutionary radiation, this life habit being known in fifteen superfamilies; they burrow to varying depths, draw in water currents through their inhalent siphons, and may be active or more or less sedentary. Stanley (*op. cit.*, p. 220) pointed out that the great adaptive radiation of infaunal siphon feeders in the Mesozoic was due to the development of mantle fusion, allowing the formation of separate inhalent and exhalent siphons. The third group – infaunal mucus-tube feeders – are represented by the Lucinacea (and also possibly *Thracia*); they draw water into the mantle cavity through a long anterior mucus-lined tube constructed by the foot (Allen 1958).

Infaunal non-siphonate suspension feeders

Grammatodon Although Stanley (1970) listed several criteria for distinguishing infaunal from epifaunal arctids, and stated that free-burrowing forms do not appear until the Cretaceous, the functional morphology of the Middle Callovian species does not support this view. All three Lower Oxford Clay species lack a byssal sinus, possess an entire margin, and have the maximum region of inflation placed near the dorsal margin, which together with the broadly truncate flattened posterior region, are features indicative of burrowers. In contrast, the L/H ratio of all three species is greater than 1.35, which according to Stanley suggests that they were epifaunal. The weight of evidence seems to point towards a shallow burrowing infaunal mode of life, the posterior region placed at or near the sediment surface, although there is a possibility that the Middle Callovian species were semi-infaunal nestlers, with a very weak byssal apparatus.

Myophorella The only living representative of the Trigoniacea, *Neotrigonia margaritacea* (Lamarck), is a very active shallow burrower, with a large byssal apparatus functional only in juveniles (Gould 1969, p. 1129). *Myophorella* has many features, such as a thick shell, strong ornamentation and divaricate ribbing (at least on the irregularly-ribbed forms), which suggest a similar shallowly-buried rapid-burrowing mode of life. Stanley (1970, p. 75) noted that many short, robust shallow burrowers (such as cardiids) have a flattened posterior margin which lies at or just beneath the sediment surface, and it seems probable that the posterior area of trigoniids fulfils a similar function.

Neocrassina
(*Pressastarte*) A small suborbicular astartid of low inflation, the shell form suggesting that it was a rapid burrower which used a large angle of rotation in burrowing. Most Recent astartids live just beneath the sediment surface, posterior end uppermost, and move slowly through the sediment; this mode of life is assumed for *N. ungulata* and *N. calvertensis*.

Nicaniella
(*Trautscholdia*) A small inflated astartid, with a suborbicular outline and strong concentric ribs. The high inflation, strong ribbing pattern and thick shell are all features which slow down the burrowing rate, and the denticulate ventral margin suggests that it is a shallow burrower. A similar mode of life to *Neocrassina* is postulated.

Infaunal siphonate suspension-feeders

Solemya Stanley (1970, p. 120) showed that Recent *Solemya* maintain a deep open U-tube burrow, resting at its deepest point, and drawing in a water current anteriorly; the suspended food material is then filtered on the gills. Stanley also noted the existence of a deep vertical extension to the burrow, and suggested that it may supply nutrients such as bacteria. As in Recent species, *S. woodwardiana* has a very thin shell, which gives a low whole-animal density, a feature which allows Recent species to make rapid swimming movements; in view of the similarity between Recent and fossil species of *Solemya*, it is probable that *S. woodwardiana* was also capable of swimming movements when necessary, although for most of the time it presumably functioned as a deep-burrowing siphonate suspension-feeder.

Protocardia A small cardiacan with a radially ribbed flattened posterior area, and high inflation. Stanley (1968, p. 216) classed all members of the Cardiacae as infaunal siphon feeders, although pallial sinuses are rarely seen in marine forms. It is most likely that *Protocardia* lived with its posterior region lying more or less at the sediment-water interface, the radial ribbing perhaps helping to camouflage the shell when covered with a thin veneer of sediment.

Rollierella A suborbicular, globose arcticacean, with very fine cancellate ornament, indicative of a slow burrower, as also are the ventral marginal denticulations. As with Recent Arcticaceae, it is believed that *Rollierella* lived just below the sediment surface, its very short siphons only just protruding from the shell, there being no pallial sinus present.

- Anisocardia* Closely related to *Rollierella*, with a similar mode of life. However, it is less inflated and more rostrate, suggesting that it was a more rapid and slightly deeper burrower.
- Isocyprina* A suborbicular, compressed arcticacean with a smooth, polished external shell surface. The nature of the shell suggests that it was a rapid burrower, whilst the heterodont dentition and small pallial sinus suggests that it burrowed to a shallow depth.
- Corbulomima* Yonge (1946) has shown that certain Recent corbulids are shallow-burrowing siphonate suspension-feeders, some of which plant byssal threads and become sedentary; the siphons lie more or less flush with the sediment surface. *C. macneillii* and *C. obscura* have rather truncate posterior margins, suggesting that they lived more shallowly than the more rostrate *C. mosae*, in which siphon development was presumably greater.
- Pleuromya* Although very similar in form to Recent species of *Mya*, *P. alduini* and *P. uniformis* lack commissure gapes anteriorly and posteriorly, suggesting that the valves were either permanently open, or the siphons could be completely retracted into the shell although the large size of the pallial sinus suggests that they could not be fully retracted. All other features, such as the desmodont dentition, thin largely unornamented shell and large pallial sinus, are features typical of deep-burrowing siphon feeders. If the siphons were too large to be fully retracted, *Pleuromya* must have been virtually sessile after the attainment of the adult state. The more elongate and cylindrical form of *P. uniformis* suggests that it may have been a deeper and more effective burrower than *P. alduini*.

Infaunal mucus-tube feeders

- Discomiltha* A typical lucinoid with an elongate anterior adductor muscle scar and a strong posterior sulcus. The lucinoid mode of life seems to have continued more or less unchanged since the Palaeozoic,

TABLE 2. Life habits of Lower Oxford Clay bivalves. **A.** Maximum shell length (mm). **1.** Swimming; **2.** Free-living or cemented; **3.** Byssally attached; **4.** 'Pendent'; **5.** Non-siphonate; **6.** Short siphons; **7.** Long siphons; **8.** Mucus-tube feeders; **9.** Byssally attached; **10.** Mobile.

GENERA AND FEEDING GROUPS	A	EPIFAUNAL				INFAUNAL						TAXONOMIC POSITION	
		1	2	3	4	5	6	7	8	9	10		
DEPOSIT-FEEDERS													SUPERFAMILY
<i>Palaconucula</i>	18											10	NUCULACEA
<i>Mesosaccella</i>	18											10	NUCULANACEA
SUSPENSION-FEEDERS													
<i>Solemya</i>	38							7					SOLEMYACEA
<i>Grammatodon</i>	28					5						10	ARCACEA
<i>Modiolus</i>	70			3									MYTILACEA
<i>Pinna</i>	82			3									PINNACEA
<i>Pteroperna</i>	15				4								PTERIACEA
<i>Parainoceramus</i>	73				4								PTERIACEA
<i>Bositra</i>	15				4								PECTINACEA
<i>Oxytoma</i>	40				4								PECTINACEA
<i>Meleagrinnella</i>	34				4								PECTINACEA
<i>Entolium</i>	31		1										PECTINACEA
<i>Camptonectes</i>	58				3								PECTINACEA
<i>Chlamys</i>	10				3								PECTINACEA
<i>Radulopecten</i>	76				3								PECTINACEA
<i>Plicatula</i>	27			2									PECTINACEA
<i>Gryphaca</i>	80			2									OSTREACEA
<i>Nanogyra</i>	11			2									OSTREACEA
<i>Myophorella</i>	88					5						10	TRIGONIACEA
<i>Discomiltha</i>	47							7	8				LUCINACEA
<i>Neocrassina</i>	21					5						10	ASTARTACEA
<i>Nicaniella</i>	13					5						10	ASTARTACEA
<i>Protocardia</i>	30							6				10	CARDIACEA
<i>Anisocardia</i>	25							6				10	ARCTICACEA
<i>Isocyprina</i>	20							6				10	ARCTICACEA
<i>Rollierella</i>	24							6				10	ARCTICACEA
<i>Corbulomima</i>	7							6			9		MYACEA
<i>Pleuromya</i>	71								7				PHOLADOMYACEA
<i>Thracia</i>	65								7	8			PANDORACEA

the animal living deep below the sediment surface with an anterior inhalent and a posterior exhalent mucus-lined tube reaching to the surface; strong water currents are produced by the cilia of the elongate anterior adductor muscle scar and the gills. Once settled, lucinoids seem to be more or less sedentary.

Thracia

A deep burrowing suspension-feeder showing all the typical features seen in *Pleuromya*, although the more triangular shape of *Thracia* suggests that it was less deeply buried. Yonge (1937, p. 338) showed that *Thracia* was notable for the production of mucus-lined tubes through which the inhalent and exhalent currents flow; this apparently enables the siphons to be free of the danger of predation, and allows the animal to burrow slightly deeper, as the siphons need not be permanently extended so far.

Deposit-feeders. Bivalves which belong to this feeding group collect and digest organic material which has settled to the sea-floor, and has either been incorporated within the sediment, or forms a thin veneer on the sediment surface. This deposited material is collected in two ways by infaunal bivalves; the Nuculoida feed on material within the sediment, collecting it by means of labial palps while the Tellinacea feed on the thin veneer of organic matter at the sediment surface, using slender siphons by which they suck the organic material into the mantle cavity. In the Oxford Clay only the Nuculoida are represented.

Palaeonucula

A short triangular-shelled form, very similar in outline to Recent species of *Nucula*, the modes of life of which have been described by Yonge (1939). All nuculids live just beneath the sediment surface, moving slowly about in search of food, which is collected by the ventrally-emergent palp proboscides. No siphons are present, and the weak inhalent current is drawn directly through the sediment.

Mesosaccella

An elongate cylindrical malletiid, with a clearly developed pallial sinus and a wholly external ligament. *Mesosaccella* closely resembles Recent species of *Yoldia*, a nuculanid whose life habits were noted by Yonge (1939); it is likely that it occupied a similar niche, buried anterior downwards with the siphons reaching to the surface, collecting organic material from within the sediment by means of the palp proboscides.

SYSTEMATIC DESCRIPTIONS

The classification of the bivalves used here is essentially that of Newell (1969, N205). Only in the case of *Mesosaccella* Chavan, which has been transferred from the Nuculanidae to the Malletiidae on the basis of the absence of an internal ligament, has any change been made. Most generic diagnoses and synonymies are also based on Newell (*op. cit.*); where emendation of either has been necessary this is noted in the relevant generic discussion.

Class BIVALVIA Linnaeus, 1758

Subclass PALAEOTAXODONTA Korobkov, 1954

Order NUCULOIDA Dall, 1889

Superfamily NUCULACEA Gray, 1824

Family NUCULIDAE Gray, 1824

Genus NUCULOMA Cossmann, 1907

Type species. By monotypy; *Nucula castor* d'Orbigny 1850, p. 339, no. 178; figured Cottreau 1925, p. 21, pl. 39, figs. 23, 24; Callovian, Montsec (Meuse), France.

Diagnosis. Medium-sized genus (up to 26.0 mm L), subtrigonal to subtrapezoidal in outline, well-inflated; umbones very strongly opisthogyrate, usually markedly enrolled, often nearly terminal; posterodorsal area usually deeply impressed, cordate in outline; anterodorsal margin evenly arched and convex, ventral margin evenly convex, often straightening posteriorly and becoming sinuate; anterior margin bluntly rounded; anterior row of teeth evenly arched, much larger than the posterior row of 4-6 teeth, placed more or less vertically above each other; ornament of fine interdigitate concentric striae, or fine regular concentric striae without interdigitation.

Remarks. *Nuculoma* is an easily recognized Jurassic genus characterized by its strongly opisthogyrate, enrolled umbones, and its distinctive ornament pattern. Although the umbones are terminal, or nearly so, in the type-species, in species such as *N. pollux* (d'Orbigny) the umbones are

more centrally placed (AL \bar{x} 66.5%). However, it is very difficult to compare published measurements of nuculids, as shell orientation is not constant. Most authors measured length parallel to the direction of the anterodorsal margin, thus ensuring that the posterodorsal margin is nearly vertical, and the umbones almost terminal. The present author measures nuculids as other di-myarian bivalves; length is measured parallel to a line drawn through the adductor muscle scars which are placed at the distal ends of the hinge line. The measurement of length is made therefore between the posteroventral and anteroventral angles. This reduces AL% and increases H% of many species, notably those placed in *Nuculoma*.

Interdigitate ornamentation is apparently absent in the type-species (Cossmann 1907; Cottreau 1925) and some Indian Upper Jurassic species described by Cox (1940, p. 23, p. 24), but present in *N. pollux* (d'Orbigny) and *N. chassyannum* (d'Orbigny). When present it is usually on a microscopic scale, and is easily overlooked. Forms with interdigitate ornament may prove distinct from forms with regular concentric ornament, but as yet there is no reason to separate them.

1. *Nuculoma pollux* (d'Orbigny, 1850) Pl. 1, figs. 1a-1c; Text-fig. 5

1850 *Nucula pollux* sp. nov., d'Orbigny, p. 339, no. 179.

1901 *Nucula pollux* d'Orbigny; Raspail, p. 194, pl. 12, fig. 13.

1925 *Nucula pollux* d'Orbigny; Cottreau, p. 22, pl. 39, figs. 25-27.

1975 *Nuculoma pollux* (Raspail ex d'Orbigny); Duff, p. 446.

Holotype. MHNP 3347A; figured Cottreau 1925, pl. 39, figs. 25-27; Oxford Clay, of Villers-sur-Mer, France.

Measurements

	L	H	I	AL
N	7	7	6	3
\bar{x}	15.1 mm	79.1%	58.7%	66.5%
Max	18.9	83.7	64.1	70.2
Min	9.9	70.9	55.6	63.6
OR	9.0	12.8	8.5	6.6

Description. Medium-sized, equivalve, inequilateral, umbones posterior to median, markedly opisthogyrate, rounded, slightly enrolled, salient *c.* 2 mm above the hinge line. Outline trigonal, height *c.* 80% of length. Anterodorsal, posterodorsal and ventral margins of subequal length, variably curved; anterodorsal margin straight to gently convex, posterodorsal margin markedly concave, ventral margin short, evenly convex, with no posterior sinuosities; posteroventral angle sharp, prominent, but not produced, about a right angle; anteroventral angle more rounded, and less prominent than the posteroventral angle. Outline of posterodorsal margin broken by prominent, evenly convex escutcheon pout (Text-fig. 5), which protrudes above about half the length of posterodorsal margin. Shell globose, inflation always less than anterior length. Ornament of interdigitate concentric striae on body of shell, with no apparent growth halts; dorsal areas with faint growth striae, not interdigitate.

Corselet large, excavate, cordate, occupying whole of posterodorsal region, bounded by sharp umbonal carinae running to posteroventral angles; escutcheon smaller, prominent, cordate, two arcuate elevated ridges running from umbones to posterior end of hinge line, protruding above posterodorsal margin as the escutcheon pout; inner part of escutcheon excavate; corselet and escutcheon ornamented by fine growth striae. Lunule elongate, lanceolate, extending from umbones to anteroventral angle, bounded by rounded carinae; lunule biconcave in outline, a slight rise occurring along commissure and dividing lunule into two separated excavate areas; ornamented by faint growth striae. Ligament internal.

Remarks. This easily recognized species may be distinguished from the similarly-shaped *Palaeonucula triangularis* sp. nov. by its much more concave posterodorsal margin, more enrolled umbones, lower inflation and interdigitate ornament. The two species have many close similarities but because of differences in ornament pattern and twisting of the umbones, are placed in

different genera. *N. pollux* is less inflated, has much more median umbones than the type-species *N. castor*, and may thus be separated from other European Upper Jurassic species of *Nuculoma*, such as *N. chassyantum* (d'Orbigny). The clear development of a differentiated lunule is an unusual feature in nuculids, but is well seen in *N. pollux*, although it is not as prominent as the corselet. *N. pollux* has previously been recorded only from France (d'Orbigny 1850; Raspail 1901; Cottreau 1925), and seems to be rare. Two specimens from the Oxford Clay of Wiltshire (YM KD1974/1), whose exact horizon and locality are unknown, belong to this species and are those described above.

Range and occurrence. Oxford Clay of Wiltshire; Middle to Upper Oxford Clay (*athleta-mariae* zones) of Villers-sur-Mer, France.

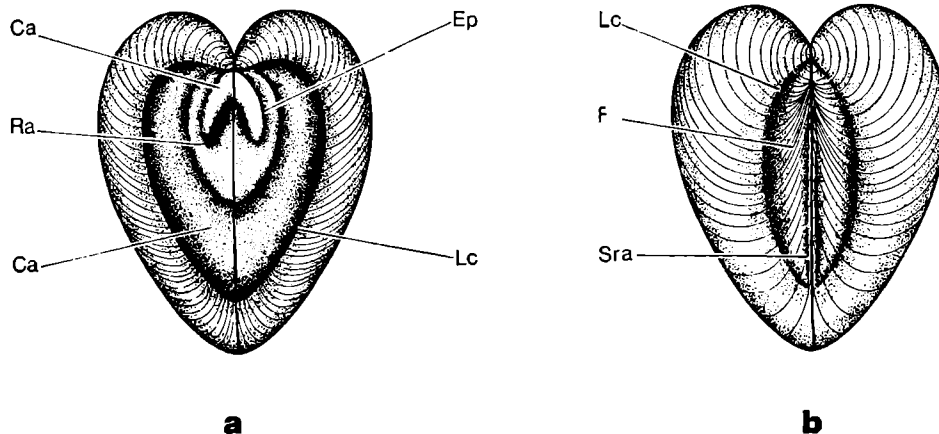

TEXT-FIG. 5. Views of the posterior (a) and anterior (b) regions of a specimen of *Nuculoma pollux* (d'Orbigny) from the Oxford Clay of Wiltshire (YM 896), $\times 4$. The form of the escutcheon region, with its elevated pout, is seen in a. **Ca** = concave area; **Ep** = escutcheon pout; **F** = fine striae; **Lc** = lateral carina; **Ra** = raised area; **Sra** = slightly raised area.

2. *Nuculoma kathrynae* sp. nov. Pl. 1, figs. 2-5

1975 *Nuculoma* sp. nov.; Duff, p. 446.

Holotype. GSM 114030; Pl. 1, fig. 2; Oxford Clay (horizon unknown) of Lydlinch, Wiltshire.

Paratypes. GSM 114031-9; same horizon and locality as holotype.

Measurements

	L	H	I	AL
N	6	6	5	6
\bar{x}	9.8 mm	81.0%	70.9%	81.1%
Max	10.8	84.7	74.4	85.7
Min	8.5	76.5	61.9	76.5
OR	2.3	7.8	12.5	9.2

Description. Small species, equivalve, inequilateral, elongate-subtrigonal in outline with anterodorsal and ventral margins of subequal lengths, about twice the length of the posterodorsal margin; anterodorsal margin usually gently convex, but occasionally straight or slightly concave, anteroventral angle prominent, rounded, produced; posterodorsal margin evenly concave, its outline usually broken by well-developed escutcheon pout, which occupies about half the length of posterodorsal margin; posteroventral angle sharply rounded, produced, about a right angle; ventral margin gently and evenly convex, sometimes straightening posteriorly and becoming subparallel to anterodorsal margin. Inflation high, giving shell a globular appearance. Umbones prominent, inflated, rounded, strongly opisthogyrate, enrolled, placed close to posterior extremity of shell, salient about 1 mm above hinge line. Ornament of interdigitate concentric striae, except on dorsal areas, where there are only faint growth lines.

Corselet broad, cordate, lightly impressed, occupying whole of posterodorsal region to posteroventral angle, bounding umbonal carina rounded and not prominent. Escutcheon small, cordate, prominent, reaching about halfway to posteroventral angle, the two arcuate ridges broad and clearly elevated as the escutcheon pout. Lunule not differentiated, lacking bounding carinae and distinctive ornament pattern. Ligament internal.

Hinge line 72.9% length of dorsal margins (only measurable on one specimen), anterior part twice as long as dorsal part (48.6% to 24.3%), the two parts set at an angle of about 110°; anterior tooth row gently convex with 15 small chevron-shaped taxodont teeth, the angles of the chevrons pointing towards the umbones, and the teeth increasing in size distally; posterior row straight with 8 small, similarly-shaped teeth, more closely spaced than those in the anterior row; chondrophore tooth not visible, but preservation in the umbonal region poor. Resilifer placed on short, narrow, anteroventrally directed chondrophore, which only protrudes very slightly into shell cavity.

Musculature largely obscured, adductor muscle scars suborbicular, subequal, normally placed, anterior scar slightly larger than posterior; no other muscle scars visible. Pallial line entire.

Remarks. *N. kathrynae* is superficially similar to *N. castor*, but lacks its more enrolled, nearly terminal, umbones which cause reduction of the posterior tooth row, so that, in *N. castor* (see Couffon 1919, pl. 5, fig. 14g; Schenck 1934, pl. 4, fig. 5c), there are only about four small peg-like teeth. In contrast, *N. kathrynae* has a longer posterior part of the hinge plate, with 8 teeth, and better developed escutcheon and escutcheon pout. The specimens of *N. castor* figured by Schenck and Couffon appear to lack a clearly differentiated escutcheon, presumably due to reduction of the posterior tooth row.

Range and occurrence. 10 specimens from the Oxford Clay (horizon unknown) of Lydlinch (Wiltshire).

Genus **PALAEONUCULA** Quenstedt, 1930

Type species. Original designation; Quenstedt 1930, p. 110, pl. 2, fig. 9; *Nucula hammeri* Defrance, 1825, p. 217; Upper Lias of France.

Diagnosis. Medium-sized genus (up to *c.* 35 mm L), elongate, subtrapezoidal to subtrigonal in outline, well inflated; umbones slightly opisthogyrate, sometimes gently enrolled, posteriorly placed, occasionally terminal; posterodorsal area often deeply impressed, cordate in outline; anterodorsal margin usually slightly arched, ventral margin gently convex, often sinuate posteriorly; anterior margin bluntly rounded; anterior row of teeth often gently arched, posterior row shorter, its length dependent upon how near the posterior the umbones are placed; ornament consisting of irregularly spaced concentric growth lines of variable strength, no radial sculpture; valve margins not denticulate.

Remarks. Quenstedt's original diagnosis (1930, p. 112) has been emended by Schenck (1934, p. 36) and Cox (1940, p. 11), as it was not strictly applicable to the type-species. Schenck recognized a 'chondrophore tooth', adjoining the posterior margin of the chondrophore in several specimens of *N. hammeri*, the type species; Quenstedt believed a chondrophore tooth to be absent, but this conclusion was based on examination of an incomplete specimen.

The relationships between the Jurassic nuculid genera *Palaeonucula* and *Nuculoma*, and the Cretaceous–Recent genus *Nucula s.l.*, have been a source of great confusion in the past, mostly due to imprecise understanding of the respective type species. Quenstedt (1930) believed the three genera to be distinct, as did Schenck (1934), although he considered *Palaeonucula* a subgenus of the Palaeozoic genus *Nuculopsis* Girty. As noted by Cox (1940, p. 12), *Nuculopsis* has a more primitive type of chondrophore than *Palaeonucula*, the chondrophore being wider and shorter, and not projecting into the shell cavity; accordingly, Cox placed *Palaeonucula* as a subgenus of *Nucula*, and accepted *Nuculoma* as a genus. Later Cox (1965, p. 125), placed *Palaeonucula* as a subgenus of *Nuculoma*, an opinion based on the shell structure studies of Van de Poel (1955). At present, the name *Nucula s.l.* is restricted to forms with radial ribbing on the shell exterior (Keen, 1969, p. N231), and thus it must be considered distinct from *Palaeonucula* and *Nuculoma*. Study of the type species of the two Jurassic genera reveals several important differences, enabling a clear distinction

to be made between them. The diagnostic features of *Nuculoma* are discussed above, the main differences between it and *Palaeonucula* being the more opisthogyrate, strongly enrolled umbones which overhang the posterior margin, and the fine concentric ribbing, occasionally interdigitate, all over the shell in the former genus.

1. ***Palaeonucula triangularis*** sp. nov. Pl. 1, figs. 6–13, 17, 23; Text-fig. 6

1975 *Palaeonucula* sp. nov.; Duff, pp. 446 *et seq.*

Holotype. BM LL27713; Pl. 1, fig. 8; Lower Oxford Clay, Bed 7 (Callomon 1968), *coronatum* Zone, *obductum* Subzone of Stewartby, Bedfordshire.

Paratypes. BM LL27714–21; same locality and horizon as holotype.

Measurements

	L	H	I	AL
N	158	158	158	158
\bar{x}	14.7 mm	79.6%	66.9%	70.1%
Max	18.4	88.1	82.0	80.0
Min	10.7	73.0	56.1	55.8
OR	7.7	14.9	25.9	24.2

Description. Medium-sized species, trigonal to subtrigonal in outline, anterior and ventral margins of approximately equal length; anterior margin straight to gently convex, outline of body of shell obscuring hinge line (as seen laterally) for most of its length; anterior extremity of the hinge not elevated above the anterior margin; posterior margin straight to gently concave, body of shell obscuring hinge line for all its length, except where the escutcheon pout protrudes above the margin for a short way; posteroventral angle about a right angle, often produced, thus emphasizing the concavity of posterior margin, and sinuosity of posteroventral margin; ventral margin evenly convex, often straightening posteriorly, and often becoming very slightly sinuate in forms with a produced posteroventral angle; anteroventral angle acute, rounded, passing evenly between ventral and anterior margins. Umbones prominent, opisthogyrate, placed posterior of median, salient up to 2 mm above hinge line, not enrolled. Well inflated, inflation tending to increase throughout ontogeny. Ornament consisting solely of irregularly spaced concentric growth lines over whole shell surface, including dorsal regions; no interdigitate ornament, but on some very well preserved specimens, there are very faint traces of radial striae in places.

Posterodorsal region of shell generally rather flattened, corselet and escutcheon well-developed, lunuliform; corselet large, broad, cordate, occupying the whole of the posterodorsal region of shell, bounded by ridges running from the umbones to posteroventral angle; corselet flattened to excavate in outline, ornamented by concentric growth lines which continue onto body of shell. Escutcheon shorter and narrower, cordate, placed within corselet, extending about two-thirds way to posteroventral angle; its outer margin a rounded ridge extending in an arc from umbones to commissure, usually protruding above outline of posterodorsal margin as an escutcheon pout; inside marginal ridge escutcheon slopes gently to commissural margin. Lunule absent.

Hinge line about two-thirds of the length of the dorsal margin (Lh 61.8–72.6%, \bar{x} 67.8% [Lh as percentage of Ldm]), anterior part straight to very gently convex, posterior part gently convex, with known maxima of 16 anterior teeth and 10 posterior teeth. Dentition taxodont, teeth chevron-shaped, points of chevrons directed towards the umbo, projecting about 1 mm above commissure; teeth becoming more widely spaced distally, largest tooth occurring about 3 teeth from the distal end of each tooth row; proximal teeth of anterior row continue above chondrophore as very small peg-like teeth which prove impossible to count. A strong chondrophore tooth occurs at anterior of posterior tooth row of left valve, forming posterior margin of chondrophore, the next three or four teeth of posterior row being narrower and blade-like; chondrophore tooth matched by a socket in right valve. Resilifer located on a short, excavate chondrophore directed antero-ventrally from umbo and projecting a little way into shell cavity.

Muscle insertion areas weakly impressed, best seen on steinkerns. Adductor scars subequal, ovate, placed close to dorsal margin, immediately beneath distal ends of the hinge lines, and marked by prominent growth lines. Posterior adductor scar slightly more ovate than anterior, with a faint buttress dorsally and anterodorsally; anterior adductor scar buttressed dorsally and posterodorsally. Pedal muscles unequal, sited near commissure; anterior scar L-shaped, slightly longer than posterior scar, long arm of the L running parallel to commissure from posterior end of anterior adductor scar, about one-third of the way to umbones; short arm perpendicular to it, about one-third length of long arm, parallel to posterior margin of anterior adductor scar; posterior scar about two-thirds length of anterior scar, straight, subparallel to commissure, running anterodorsally from dorsal margin of posterior adductor scar about halfway to umbones; both pedal scars with fine growth lines. Visceral muscle impressions occupy a marked channel on steinkerns, running anteroventrally from anterior side of umbones, fading at the level of the dorsal margins of adductor scars; two or three suborbicular discrete muscle scars may sometimes be seen at ventral end of groove (Text-fig. 6). Pallial line simple. Valve margins not crenulate.

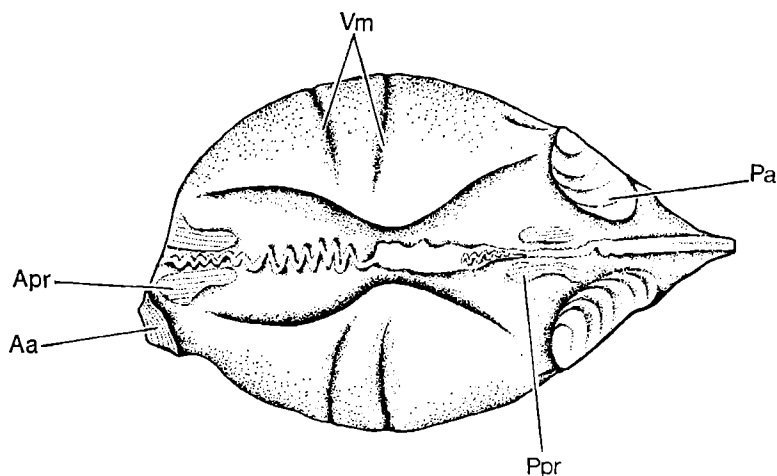

TEXT-FIG. 6. Dorsal view of an internal mould of *Palaeonucula triangularis* sp. nov., from the Lower Oxford Clay (*obductum* Subzone, *coronatum* Zone) of Stewartby, Beds. (LU 68611), $\times 5$. **Aa** = anterior adductor scar; **Apr** = anterior pedal retractor scar; **Pa** = posterior adductor scar; **Ppr** = posterior pedal retractor scar; **Vm** = visceral muscle scars.

Remarks. The large collections of pyritized whole shells from the pyritic shell-beds of the Lower Oxford Clay reveal polymorphic variation in *P. triangularis*.

Variation is continuous, and no reasons for subdivision have been found; the 'norm' of the population is a shell of trigonal outline, relatively short ($H = 82\%$) and well-inflated ($I = 72\%$), with a short, smoothly-curved ventral margin. Elongation varies considerably ($H 73.0-88.1\%$, $\bar{x} 79.6\%$), the ventral margin becoming more gently curved as length increases; elongation is often coupled with increasing concavity of the posterior margin, and slight sinuosities which appear at the posterior end of the ventral margin. Inflation does not vary systematically with any shell parameter except perhaps overall size (measured as L), small shells tending to have a lower I percentage. The development of the escutcheon pout is an inconsistent feature, which cannot be directly correlated with any other major shell parameter, although it seems to be related to the degree of convexity of the posterior row of teeth; the more arched the teeth, the more pronounced is the pout. The degree of excavation of the corselet is apparently unrelated to the strength of the escutcheon pout.

The terms escutcheon and corselet are used as defined by Carter (1967, p. 261), and although they have not traditionally been used in the description of nuculids, the author feels that they may be usefully employed in the description of the posterodorsal area in this family. The escutcheon is defined as representing the track on the outer surface of the valve of the posterodorsal edge of the hinge during shell growth; the corselet is a further differentiated area posterior to the umbones, outside the escutcheon; its structural significance is unknown.

From limestone steinkerns from septarian concretions in the Lower Oxford Clay, especially at Stewartby, careful removal of the inner nacreous layer reveals well-preserved adductor and pedal muscle scars, and a faint channel representing the visceral muscle attachment area (Text-fig. 6). The pedal musculature of Jurassic nuculids is not well documented, and these specimens are valuable in that the pedal musculature of *Palaeonucula* is described for the first time. Terminology for the musculature is taken from Speden (1970, p. 30), who described the muscle scars of two Cretaceous species of *Nucula* s.s.; these differ from *Palaeonucula* in the shape of the pedal scars and the shape and position of the visceral muscle scars, thus showing that the musculature is of some taxonomic importance in this family.

There are many available specific names for Callovian and Oxfordian nuculids, but none of them is applicable to the species described here. In general outline, *P. triangularis* is close to *Nuculoma pollux* (d'Orbigny), but *N. pollux* is less inflated ($I \bar{x} 58.7\%$), and has the interdigitate concentric ribbing which places it in *Nuculoma*. The specimen figured by Makowski (1952, p. 5, pl. 5, figs. 2, 2a) as *Nucula calliope* d'Orbigny is probably also referable to *N. pollux*, although it is a little more inflated than the holotype. In general outline, Makowski's specimen is similar to *P. triangularis*, but again has interdigitate ornament. The specimen of *Nucula calliope* d'Orbigny, figured by Couffon (1919, p. 79, pl. 5, fig. 13, 13a–13i) appears to belong to *Palaeonucula*, lacking regular concentric ornament, but the posterior margin is less concave and the escutcheon pout less pronounced than in *P. triangularis*.

Range and occurrence. Abundant throughout the Lower Oxford Clay, *jason* to *athleta* zones of central and southern England (Calvert, Bletchley, Stewartby, Norman Cross and Crook Hill); *jason* Zone, M4 Road Cutting, Dodford Farm, Christian Malford, Wilts. (OUM J28238); *calloviense* Zone, *enodatum* Subzone of Stewartby, Bletchley and Peterborough; four specimens (GSM Bx7515) from the Oxford Clay of the Geological Survey borehole at Upwood (Hunts.); one specimen from the Oxford Clay of Christian Malford, Wilts. (GSM 114119).

2. *Palaeonucula calliope* (d'Orbigny, 1850) Pl. 1, figs. 14–16, 18–21

- ?1829 *Nucula* (cast); Phillips, pl. 5, fig. 4.
 1850 *Nucula calliope* sp. nov., d'Orbigny, p. 339, no. 177.
 1856 *Nucula pectinata* Zieten; Quenstedt, p. 505, pl. 67, fig. 24.
 1860 *Nucula ornata* Quenstedt; Damon, pl. 2, figs. 6–8 (*non* Quenstedt).
 1875 *Nucula cottaldi* sp. nov., de Loriol *in* de Loriol & Pellat, p. 295, pl. 17, figs. 11–15.
non 1883 *Nucula calliope* d'Orbigny; Lahusen, p. 86, pl. 2, figs. 21a, b, 22a, b.
 1897 *Nucula cottaldi* de Loriol; de Loriol, p. 113, pl. 14, figs. 15, 15a, b, 16, 17, 17a, b, 18.
 1901 *Nucula calliope* d'Orbigny; Raspail, p. 194, pl. 11, fig. 16.
non 1904 *Nucula calliope* d'Orbigny; Borissiak, p. 36, pl. 2, fig. 2.
non 1907 *Nucula cottaldi* de Loriol; Cossmann, p. 9, pl. 3, figs. 10, 11.
non 1915 *Nucula calliope* d'Orbigny; Krenkel, p. 306, pl. 26, figs. 19–22 [figs. 19–21 = *Nucula chassyannum* d'Orbigny, fig. 22 = *Nucula inconstans* Roeder].
non 1919 *Nucula calliope* d'Orbigny; Couffon, p. 79, pl. 5, figs. 13, 13a–13i.
 1925 *Nucula calliope* d'Orbigny; Cottreau, p. 21, pl. 39, figs. 21, 22.
 1952 *Nucula ornati* Quenstedt; Makowski, p. 5, pl. 5, figs. 1, 1a (*non* Quenstedt).
non 1952 *Nucula calliope* d'Orbigny; Makowski, p. 5, pl. 5, figs. 2, 2a.
 1975 *Palaeonucula cottaldi* (de Loriol); Duff, p. 446.

Holotype. MHNP 3346; figured Cottreau 1925, p. 21, pl. 39, figs. 21, 22; Oxford Clay of Villers-sur-Mer, France.

Measurements

	L	H	I	AL
N	9	9	7	8
\bar{x}	16.4 mm	75.0%	67.3%	79.1%
Max	19.0	81.8	74.8	84.4
Min	14.4	67.4	61.8	73.3
OR	4.6	14.4	13.0	11.1

Description. Medium-sized species, equivalve, inequilateral, subrectangular to subelliptical in outline, whole shell elongated posterodorsally. Posterior margin short, gently concave or straight, depending on inflation of umbones; posteroventral angle sharply rounded, *c.* 120°, not produced posteriorly; outline of anterodorsal margin concave, anterior end of hinge line appearing above outline of body of shell in its anterior half; hinge line straight. Outline of anterior part of umbonal region continued to anteroventral angle as a rounded carina, marking off a broad, lanceolate, obliquely sloping anterodorsal area; anterior margin short, oblique, truncate, straight to very gently concave or convex, forming an angle of *c.* 145° with hinge line; anteroventral angle slightly produced, evenly rounded, about a right angle; ventral margin evenly convex, not straightening anteriorly, and without sinuosities. Umbones prominent, rounded, opisthogyrate, not enrolled, placed close to posterior margin. Well inflated, maximum near centre of shell. Ornament of irregularly spaced concentric growth lines, often coarsened into prominent growth halts near ventral margin; growth lines continue uninterrupted over dorsal areas; no radial elements or interdigitate pattern.

Posterodorsal region of shell slightly excavate, corselet and escutcheon poorly developed, cordate; corselet small, suboval, not deeply impressed, gently concave in outline; its margins marked by a rounded carina running from umbones to posteroventral angle, but not as clearly marked as in *P. triangularis*. Escutcheon small, cordate, very weakly developed, only a very faint arcuate ridge developed; escutcheon pout very small, not protruding above outline of posterior margin. Anterodorsal area of shell differentiated into two lanceolate areas, the inner extends from umbones to anterodorsal angle, its margins marked by faint carinae sometimes ornamented by darkened patches of shell slightly elongated along growth lines; its floor flat. The outer area extends from umbones to posteroventral angle, lies outside the inner area, and is limited by the umbonal carina running to posteroventral angle; it slopes obliquely downwards from the umbonal carina to the bounding carina of inner area. Both areas have concentric growth lines continuous onto body of shell. Ligament internal.

Hinge line occupying nearly the whole of the dorsal margin, from anterodorsal angle nearly to posterodorsal angle; anterior tooth row straight to very gently convex, maximum of 20 teeth; posterior row gently convex, hinge line broken in the only available specimen, at least 6 teeth. Dentition taxodont, teeth chevron-shaped, details as in *P. triangularis*. Chondrophore and resilifer not seen because of breakage of the only available shell.

Muscle insertions deeply impressed. Adductor scars subequal, anterior slightly larger, placed immediately beneath distal ends of hinge line, ornamented by prominent growth lines. Posterior scar more ovate than the anterior, which tends to be slightly subtrigonal, a weak buttress developed dorsally; anterior scar more strongly buttressed dorsally and posteriorly. Anterior pedal muscle scar triangular, about 1 mm long, long axis of triangle directed towards umbones, subparallel and very close to commissure, located immediately anterior to anterior adductor scar; posterior scar elongate, as in *P. triangularis* about 1.5 mm long, located about midway between posterior adductor and umbo, close to commissure, its long axis subparallel to the commissure and directed umbonally; both scars with fine growth lines. Visceral muscle scars faint, two elongate muscle scars placed in line, running directly ventrally from anterior side of umbo, fading at about level of dorsal margin of adductor scars; just anterior to these scars, a faint groove on steinkerns runs towards anteroventral angle, fading at about the same level as visceral scars. Pallial line simple. Valve margins not crenulate.

Remarks. The description is based on well preserved material from Lukow, Poland, kindly donated to the author by Dr A. Radwanski, together with reference to the descriptions and figures of de Loriol (1897) and Cottreau (1925). Variation is not as great as in *P. triangularis*, degree of elongation being the most variable feature, whereas inflation and anterior length are more constant. D'Orbigny's (1850, p. 339) original diagnosis was very brief—'Espèce voisine du *N. Caecilia*, mais plus renflée, plus courte dans son ensemble, tronquée sur la région anale'—and from the diagnosis alone, recognition is difficult, several authors (see synonymy) having misidentified the species before Cottreau figured the type. The first recognizable description of the species was that of de Loriol (1875, in de Loriol & Pellat), who ignored d'Orbigny's name, and introduced the name *Nucula cottaldi*; his figures show it to be indistinguishable from d'Orbigny's species. *Nucula ornati* Quenstedt (1856, p. 505, pl. 67, figs. 22, 23) has been confused with *N. calliope* by authors such as Damon (1860) and Makowski (1952), but Quenstedt's figure is clearly of a different species, being more elongate and having the umbones more centrally placed; it is probably conspecific with *N. caecilia* d'Orbigny. The steinkern figured by Phillips (1829, pl. 5, fig. 4) as *Nucula* (cast), from the *mariae* Zone Oxford Clay of Scarborough, is preserved in the Yorkshire Museum (YM Tsp 880), together with several topotypes. It is possible that this represents the earliest figure of the species as the specimens agree well with the continental specimens. Phillip's figure is reversed.

The musculature is more deeply impressed than in *P. triangularis*, a feature probably related to the greater thickness of the shell in *P. calliope*. Placement of the muscles is similar to that seen in *P. triangularis*, but there are marked differences in the pedal muscle scars, the anterior scar being triangular rather than L-shaped, and smaller than the posterior scar. The visceral muscle scars are more disjunct in *P. calliope*, most likely due to increased shell thickness.

Range and occurrence. *mariae* Zone, Oxford Clay, Scarborough (YM Tsp 880) and Warboys, Cambs. (GSM Dr 2829); *cordatum* Zone Oxford Clay, Warboys, Cambs. (GSM Dr 2508, Dr 2526, Dr 2538); Oxford Clay, Osmington, Dorset (GSM Y2049); Callovian of France (d'Orbigny 1850; Cottreau 1925); *lamberti* to *athleta* zones, Lukow, Poland (Makowski 1952), and Germany (Quenstedt 1856); Oxfordian of Switzerland (de Loriol 1897).

Superfamily NUCULANACEA Adams & Adams, 1858

Family MALLETHIDAE Adams & Adams, 1858

Genus **MESOSACCELLA** Chavan, 1946

Type species. Original designation; Chavan 1946, p. 197; *Nucula foersteri* Müller, 1847, p. 17, pl. 2, fig. 1; Upper Cretaceous of Germany.

Diagnosis. Elongate-oval in outline, inflated, antero- and posterodorsal margins straight, and at an obtuse angle, the posterodorsal margin about $1\frac{1}{2}$ to 2 times the length of anterodorsal margin; posterodorsal angle sharply rounded, about a right angle, the posterior margin truncate to gently convex, posteroventral angle more evenly rounded; no resilifer, ligament external, amphidetic, nymphs elongate and very small; slight depression beneath umbo between anterior and posterior rows of teeth, which are straight, not gently concave, as in the similarly-shaped *Saturnia*; ornament of irregular concentric growth lines; pallial sinus small.

Remarks. Puri (1969, p. N235) placed *Mesosaccella* in the Nuculanidae, although as Chavan (1946, p. 197) originally observed 'Le ligament reste donc externe, en marge du bord immédiatement derrière le crochet, ce qui exclut l'attribution aux vraies *Nuculana* et notamment au sous-genre *Saccella*'. The lack of a resilifer, the ligament being wholly external, indicates that *Mesosaccella* belongs to the Malletiidae, whose range is extended down into the Callovian, the genus being known previously only from the Campanian and Maestrichtian (Upper Cretaceous).

Cox (1937, p. 192) referred *M. morrisoni* to the genus *Palaeoneilo* Hall, a genus originally described from the Devonian of the United States, on the basis of similarities in outline and dentition. However, *Palaeoneilo*, although believed by some authors to extend into the Mesozoic, is primarily a Palaeozoic genus, characterized by a faint radial posterior sulcus, and with the end teeth of the posterior series tending to pass above the anterior series in the area beneath the umbo. This means

that there can be no development of a slight depression beneath the umbo, a feature typical of *Mesosaccella*. Examination of well-preserved specimens of *M. morrisi* reveals the presence of this fossette, thus invalidating their placement in *Palaeoneilo*; *M. morrisi* also lacks the posterior radial groove, and is much more elongate and equilateral than *Palaeoneilo*. Cox (1937, p. 193; 1940, p. 6) also maintained that in *Palaeoneilo* (including *P. morrisi*), the pallial line was entire, with no sinus, and in 1940 placed *Palaeoneilo* in the Ctenodontidae, a family characterized by the lack of a pallial sinus. Specimens of *M. morrisi* from the English Midlands show the presence of a clearly developed pallial sinus, and so Cox's conclusions about the Jurassic species he assigned to *Palaeoneilo* must be amended. The status of *Palaeoneilo* has been considered, and a series of probable topotypes of the type-species figured, by McAlester (1968, p. 41, pl. 15, figs. 1-15).

Mesosaccella morrisi (Deshayes, 1853) Pl. 1, figs. 22, 24-33; Text-fig. 7

?1828 *Nucula nuda* sp. nov., Young & Bird (Bean MS), p. 230.

?1829 *Nucula nuda* Young & Bird; Phillips, pl. 5, fig. 5.

1850 *Nucula (Leda) Phillipsii* sp. nov., Morris, p. 318, pl. 30, figs. 1, 1a (non *Nucula phillipsii* McCoy, 1845 [Carboniferous species]).

1853 *Leda morrisii* nom. nov., Deshayes, p. 282 (nom. nov. pro *Nucula phillipsii* Morris non McCoy, 1845).

?1904 *Palaeoneilo choroschowensis* sp. nov., Borissiak, p. 32, pl. 2, figs. 11a, 11b.

1937 *Palaeoneilo phillipsii* (Morris); Cox, p. 192, pl. 15, figs. 1-3.

1940 *Palaeoneilo morrisii* (Deshayes); Cox, p. 6.

Neotype. Here designated; BM L67154; figured Cox 1937, pl. 15, fig. 1; Pl. 1, fig. 24; Oxford Clay of Christian Malford, Wiltshire (topotype). The holotype of *Nucula (Leda) Phillipsii* is not preserved with the rest of his types in BM, and is considered lost.

Measurements

	L	H	I	AL	Umbonal angle
N	125	124	35	122	111
\bar{x}	11.4 mm	60.4%	51.1%	41.5%	141.2°
Max	17.6	73.8	56.8	52.3	160
Min	4.8	48.8	41.4	34.5	131
OR	12.8	25.0	15.4	17.8	29

Description. Medium-sized species, equivalve, inequilateral to subequilateral, subovate in outline, posterior elongate to a varying extent. Smaller specimens (up to c. 10 mm L) tend to be subequilateral, with submedian umbones and relatively high H, while large specimens are much more elongate, with posterior becoming lengthened, umbones more anteriorly placed, and height decreasing relative to L. Inflation relatively high, always greater than anterior length in any particular shell. Umbones small, pointed, placed between submedian and about 34.5% of the length behind anterior margin, orthogyrate, rounded, moderately prominent, but only slightly salient (c. 1 mm) from hinge margin. Dorsal margin an obtuse angle about the slightly salient umbones, anterodorsal margin short, very slightly concave in juveniles, straight to slightly convex in larger specimens; anterodorsal angle evenly rounded, not produced; posterodorsal margin elongate, straight to slightly concave in all specimens; posterodorsal angle sharply rounded, even in juvenile forms, passing via slightly obtuse angle into rounded truncate posterior margin; posterior part of shell not rostrate, but evenly produced; ventral margin evenly convex to elongate, convexity often dependent upon length, median part of the ventral margin often tending to become straight in large forms, although not invariably; anteroventral angle not demarcated, anterior margin passing evenly into ventral margin, and being sharply rounded; posteroventral angle variably developed, usually an evenly rounded angle of c. 90°, but often not clearly developed, ventral and posterior margins being continuously curved. Ornament of faint concentric growth lines, sometimes locally coarsened to form growth rugae; no radial or regular concentric ribbing developed. Shell margin entire, with no gapes.

Dorsal areas clearly differentiated; small ovate depression (up to *c.* 1.5 mm long) immediately in front of umbones, and lanceolate, slightly impressed area (up to *c.* 2.0 mm long), located immediately posterior to umbones, which represents the attachment site for external amphidetic ligament. A longer (up to *c.* 6.5 mm long) shallower, lanceolate depression delimited laterally by a sharp break of slope, lies immediately posterior to umbones, and reaches almost to posteroventral angle; this probably represents a primitive escutcheon.

Hinge teeth arranged in two straight rows, set at an angle of *c.* 141° to each other, each terminating just either side of the umbo, leaving a gap occupied by a very faint depression immediately beneath the umbo; this depression probably foreshadows a resilifer, but is not well enough developed to be a functional attachment site for an internal ligament. Teeth normally developed, taxodont, chevron-shaped, points directed towards umbo, interlocking well with teeth of opposite valve, increasing in size distally, the posterior row *c.* 30% longer than the anterior, a specimen 10.3 mm long possessing 21 posterior and 16 anterior teeth. Anterior adductor muscle scar small, subovate (*c.* 1 mm long in a specimen 14.7 mm long), placed immediately ventral of anterior end of hinge plate; posterior adductor muscle scar small (1.5 mm long in specimen mentioned above),

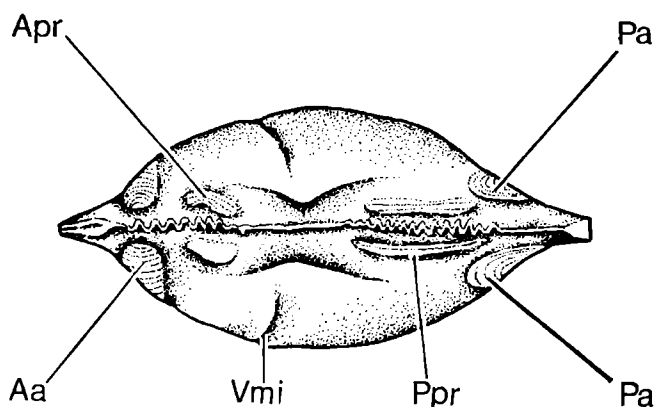

TEXT-FIG. 7. Dorsal view of an internal mould of *Mesosaccella morrissi* (Deshayes), from the Lower Oxford Clay (*obductum* Subzone, *coronatum* Zone) of Stewartby, Beds. (LU 68623), $\times 6$. **Aa** = anterior adductor scar; **Apr** = anterior pedal retractor scar; **Pa** = posterior adductor scar; **Ppr** = posterior pedal retractor scar; **Vmi** = visceral mass integument scar.

subrectangular, less deeply impressed than anterior scar, placed immediately ventral of posterior end of hinge plate, about 4 teeth from posterior extremity. Posterior pedal retractor muscle scars very narrow and elongate, deeply impressed, placed parallel to posterodorsal margin, immediately ventral of hinge plate, reaching from above posterior adductor scar almost to umbones (Text-fig. 7). Anterior pedal retractor scars narrow and short, placed parallel to anterodorsal margin, immediately ventral of hinge plate, located *c.* $\frac{1}{3}$ of the distance between anterior adductor scar and umbo. In many specimens a narrow elongate scar runs anteroventrally from the anterior point of the umbo towards the pallial line, dying out just above and anterior to anterior adductor scar (Text-fig. 7); this scar is perhaps analogous with the visceral mass integument scar found in species of *Solemya*, or could represent the intestinal scar (Stoll 1939, p. 351).

Remarks. The earliest reference to this species is that of Morris (1850), although Phillips (1829, pl. 5, fig. 5) had earlier figured the closely-related *Nucula nuda* Young & Bird, from the Oxford Clay of Scarborough. Phillip's figured specimen (YM Tsp 188) is a poorly-preserved steinkern, demonstrating none of the diagnostic features of *M. morrissi*; no dentition or muscle scars are visible, and the only similarities with *M. morrissi* are ones of general shape. *N. nuda* is perhaps conspecific with *M. morrissi*, but in view of the poor preservation of the type-material of the former species,

and the lack of better preserved topotypes, it is not possible to unite them. No certain specimens of *M. morrisi* have yet been found above the *athleta* Zone.

Leda alpina d'Orbigny (1850, p. 336, no. 136) from the Callovian of Castellane (France), figured by Cottreau (1925, pl. 38, fig. 3), is clearly close to *M. morrisi*, but the posterodorsal margin seems much too concave for this species, and the posterior margin too elongate and pointed. *Palaeoneilo choroschowensis* (Borissiak 1904, p. 31, pl. 2, figs. 11, 11a) from the Volgian of the Moscow region, is morphologically close to English specimens of *M. morrisi*, but clearly represents only one point in a continuous morphological series which Borissiak divided into five species (*op. cit.*, pl. 2, figs. 4, 7–11). Judged from Borissiak's figures the population of Russian bivalves differs from that of *M. morrisi* in being more equilateral and less elongate; it therefore seems unlikely that the two are conspecific.

Nucula symmetrica Borissiak (Makowski, 1952, p. 6, pl. 5, figs. 3, 3a) from the Callovian of Lukow, Poland, lacks a pallial sinus, and clearly cannot be assigned either to *Mesosaccella*, or to *Malletia*, which it resembles in general outline.

The closely-related Liassic species '*Palaeoneilo galatea*' (d'Orbigny) figured by Cox (1936, p. 465; 1937, p. 191), and placed in *Mesosaccella* by Palmer (1973, p. 252), is similar in form to *M. morrisi*, but is shorter anteriorly (\bar{x} 34.5%), has a greater umbonal angle (\bar{x} 150.8°) and is less inflated. There are also differences in ornament, *M. galatea* being decorated with very fine, regularly-spaced, incised concentric striae, slightly oblique to the growth-lines.

Pyritized specimens from Stewartby, and other well-preserved specimens from that locality and from Kempston, Bedfordshire (GSM 75695–703), show the dorsal regions very clearly, allowing the recognition of small external ligament sutures on either side of the umbones. Thus Chavan's (1946, p. 197) statement that the ligament in *Mesosaccella* is posterior needs emendation. Speden (1970, p. 42) described similar ligament sutures in the Upper Cretaceous *Malletia evansi*.

Range and occurrence. Lower Oxford Clay of England, very abundant in the *jason* to *athleta* zones at all exposures; ?*mariae* Zone Upper Oxford Clay of Scarborough, Yorkshire; ?Callovian of France (d'Orbigny, 1850).

Subclass CRYPTODONTA Neumayr, 1884

Order SOLEMYOIDA Dall, 1889

Superfamily SOLEMYACEA Adams & Adams, 1857

Family SOLEMYIDAE Adams & Adams, 1857

Genus **SOLEMYA** Lamarck, 1818

(Synonym: *Stephanopus* Scacchi, 1833)

Type species. Subsequent designation; Children 1823, p. 27; *Solemya mediterranea* Lamarck, 1818, p. 488 (= *Tellina togata* Poli, 1795, p. 42); Recent, Mediterranean, C. Atlantic, N. Pacific.

Diagnosis. Elongate-oval in form, compressed, umbones placed near posterior margin, and level with hinge margin; valves with narrow anterior and posterior gapes; ligament opisthodontic to slightly amphidetic, located between dorsal shell margin and large internal chondrophore; anterior adductor scar large, with a continuation ascending obliquely posteriorly from posteroventral corner of adductor, towards dorsal margin, where it broadens out, marking the visceral mass attachment area; pallial line obscure, but entire; ornament consisting of irregularly arranged radial ribs.

Remarks. *Solemya* has been divided into several subgenera on the basis of internal shell features, such as the relative positions of the ligament and chondrophore, making determination of fossil forms very difficult. *S. woodwardiana* Leckenby has an internal ridge running from below the umbones (Text-fig. 8) obliquely towards the posteroventral margin, which suggests that it is not a *Solemya* s.s., but in the absence of better preserved material, it is not possible to make a subgeneric assignation.

Roemer (1839, p. 43) stated that in *S. vultzii* (Upper Lias, Germany) 'Jede Schale hat einen breiten, zusammengedrückten, sehr schrägen, das halb äusserliche, halb innerliche Band aufreht-

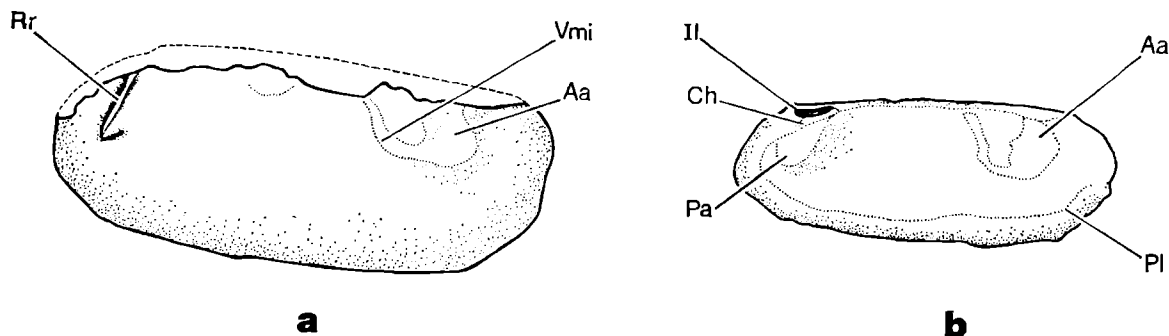

TEXT-FIG. 8. The interior of two left valves of *Solemya* s.l., comparing the musculature of fossil and Recent species. a. *Solemya woodwardiana* (Leckenby) from the Lower Oxford Clay (*obductum* Subzone, *coronatum* Zone) of Calvert, Bucks., $\times 4.5$. b. *Solemya* (*Solemya*) *togata* (Poli), Recent, $\times 1.5$ (figure after Cox 1969a, Fig. B1, 3). **Aa** = anterior adductor scar; **Ch** = chondrophore; **Il** = internal ligament; **Pa** = posterior adductor scar; **Pl** = pallial line; **Rr** = radial rib; **Vmi** = visceral mass integument scar.

menden Zahn.' This suggests the presence of a chondrophore, as *Solemya* is edentulous, which necessitates placement within *Solemya* s.l., rather than *Acharax* or *Adulomya*.

Solemya woodwardiana Leckenby, 1859 Pl. 1, figs. 34–44; Text-figs. 8a, 9

1859 *Solemya woodwardiana* sp. nov., Leckenby, p. 14, pl. 3, fig. 7.

Holotype. SM J6008; figured Leckenby 1859, pl. 3, fig. 7; Pl. 1, fig. 37; 'Kelloway Rock' of Scarborough, Yorkshire.

Paratypes. SM J12568–70; same horizon and locality as holotype.

Measurements

	L	H	AL
N	19	19	19
\bar{x}	19.5 mm	45.6%	78.5%
Max	38.0	50.0	84.6
Min	11.0	39.1	72.7
OR	27.0	10.9	11.9

Description. Medium to large-sized species, equivalve, inequilateral, elongate-elliptical in outline with umbones situated close to posterior margin; dorsal and ventral margins subparallel, anterior and posterior margins almost semicircular in smaller forms, becoming more pointed in larger forms; inflation low; umbones not prominent, but apparently opisthogyrate; hinge edentulous, ligament not visible; lunule and escutcheon apparently absent; shell thin and fragile, ornamented by riblets radiating from the umbonal area, more marked at anterior and posterior extremities, especially in large forms, and by faint concentric growth lines, with relict colour banding of brown and buff in some specimens. Adductor scars unequal (Text-fig. 8), anterior scar larger, with a visceral mass integument scar running from posteroventral corner obliquely towards dorsal margin; posterior scar small and obscure, anterior margin marked by a radial ridge on shell interior, running obliquely posteroventrally from umbonal area. Ventral margin cracked radially in some examples.

Remarks. *S. woodwardiana* occurs as three distinct geographical morphotypes in Great Britain. In the Lower Oxford Clay of the Midlands, the species occurs as a small, finely striated form up to 17 mm long, whilst in the *athleta* Zone shales of Brora, Sutherland, a larger, more coarsely ribbed form, up to 38 mm long, is found. The types from the 'Kelloway Rock' (in fact the Hackness Rock) of Scarborough, are intermediate in both size and ornament, with a maximum observed length of 25 mm, and the beginnings of coarse radial riblets over the posterior parts of the valves. The early growth lines of the Scottish specimens reproduce the shell form of the smaller morpho-

types from Yorkshire and the Midlands, and in addition, the early stages are smooth or finely striated, exactly as in the English forms. The bulk of the evidence, therefore, is in favour of uniting these three geographically separated populations in a single variable species, the variability most probably being environmentally controlled. Length/height and length/anterior length regression lines (Text-fig. 9) show the close correlation between the three populations.

The radial ridge which delimits the anterior margin of the posterior adductor scar (Text-fig. 8), originates beneath the chondrophore in Recent species of '*Solemya*', and is usually confined to forms with a chondrophore, suggesting that in *S. woodwardiana* a chondrophore is present, although it has not been seen. A specimen from the Lower Oxford Clay of Wiltshire (LU 69932) shows a depression on the inner surface of the dorsal margin which may mark the position of the chondrophore.

The cracking seen at the ventral extremities of the shell in some specimens of *S. woodwardiana* from Brora may parallel the condition seen in Recent *Solemya* (*Solemyarina*), where the ventral

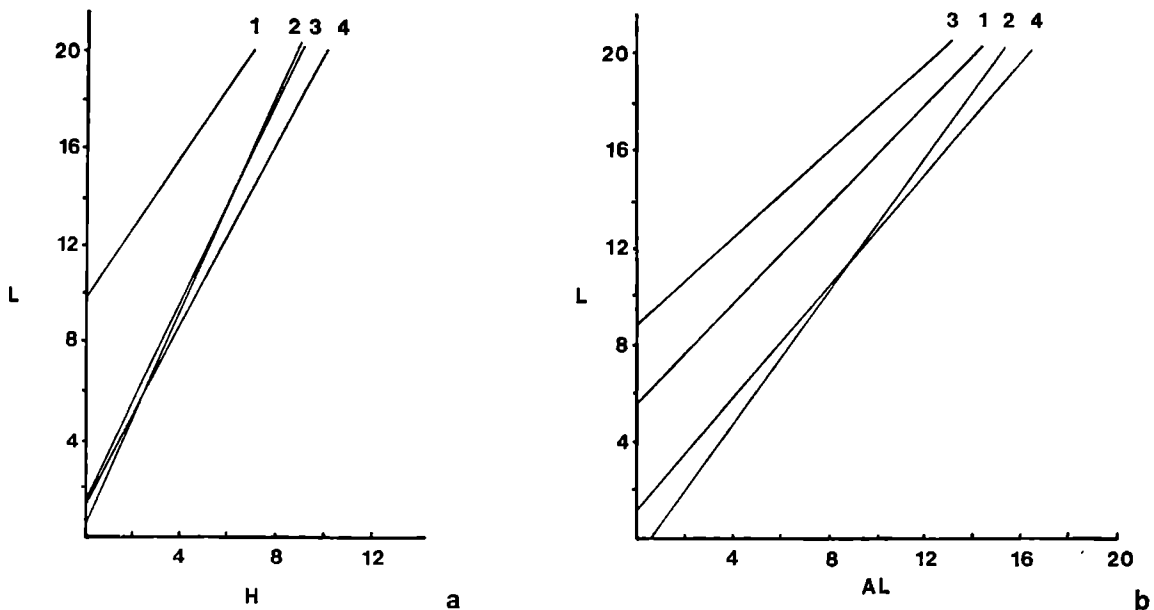

TEXT-FIG. 9. Regression lines showing relative growth rates in *Solemya woodwardiana* (Leckenby). a. Length/Height regressions for populations from the Hackness Rock (1), the Brora Oxford Clay (3), and the English Lower Oxford Clay (4); Line 2 shows the overall plot for all three populations. b. Length/Anterior Length regression for the same populations, numbered in the same way. Scales in mm.

margins of the shell are frequently seen to break along wide radial fissures (Cox 1969a, p. 242, fig. 2a). This is associated with radial lines of weakness in the periostracum, which extends beyond the shell margins in the Solemyidae.

S. vultzii Roemer (1839, p. 43, pl. 19, fig. 20), from the Lower Toarcian Posidonienschiefer of Germany, is closely related, but appears to be slightly more elongate (AL \bar{x} 71.7%; H \bar{x} 37.7%) than the British forms, and is probably distinct. Roemer mentioned (*op. cit.*) that the umbones were closer to the anterior [*sic*] margin than shown in his plate, and so the AL value should be greater than that measured from his plate. However, the lack of comparative material from the type area, and the uncertainty about the location of the type material, make specific comparison difficult.

Range and occurrence. Common in the Lower Oxford Clay of the English Midlands (*jason* and *grossouvrei* subzones at Calvert; *grossouvrei* Subzone at Bletchley; *obductum* and *grossouvrei* subzones at Stewartby; *jason* and *grossouvrei* subzones at Norman Cross), where the small, finely-ribbed form

is found; the same form also occurs in the *grossourei* Subzone at Crook Hill brickpit, Weymouth. The intermediate form is found in the Hackness Rock (*athleta* to *lamberti* zones) of Scarborough, Yorkshire, and the large, coarsely-ribbed form in the Brora Brickclay Member (*athleta* Zone) of Brora, Sutherland.

Subclass PTERIOMORPHIA Beurlen, 1944
 Order ARCOIDA Stoliczka, 1871
 Superfamily ARCAGEA Lamarck, 1809
 Family PARALLELODONTIDAE Dall, 1898
 Subfamily GRAMMATODONTINAE Branson, 1942
 Genus **GRAMMATODON** Meek & Hayden, 1861
 (Synonym: *Pseudomacrodon* Stoll, 1934)

Type species. Original designation; Meek & Hayden 1861, p. 419; *Arca (Cucullaea) inornata* Meek & Hayden, 1858, p. 51; from the Lower Jurassic of the Black Hills, Dakota, U.S.A.

Diagnosis. Subrectangular to ovate in form, height greater than 50% length, umbones placed c. 30–35% behind the anterior margin; valve flanks smooth or costellate; valve margins closed; inner margin of hinge plate straight or slightly curved, with several nearly parallel and horizontal posterior pseudolaterals, and a series of small oblique cardinals, mainly anterior, converging to a point below the umbones.

Subgenus **GRAMMATODON** s.s.

Diagnosis. Umbonal carina well developed, marking off a distinctly ornamented posterior area with closely spaced radial striae; coarsening of radial riblets on the anterior extremity often present.

Remarks. The generic status of *Grammatodon* was discussed by Arkell (1930a), who considered it (together with *Beushausenia*) a subgenus of *Parallelodon*, a view which cannot be considered valid, as *Grammatodon* has priority (Branson 1942, p. 248). Thus Branson united *Grammatodon*, *Parallelodon* and *Cosmetodon* (*nom. nov.*, *pro Beushausenia* Cossman), as subgenera of *Grammatodon*. Cox (1940) was followed by Dickins (1963) and Newell (1969) in separating *Parallelodon* and *Grammatodon*, a decision based mainly on external dissimilarities, *Parallelodon* being more elongate, often posteriorly alate and having a well-marked byssal sinus; *Parallelodon* also has fewer posterior pseudolaterals and anterior cardinals.

1. **Grammatodon (Grammatodon) minimus** (Leckenby, 1859) Pl. 2, figs. 1–6, 8–10;
 Text-fig. 10

- 1859 *Cucullaea minima* sp. nov., Leckenby, p. 13, pl. 3, fig. 5.
 1881 *Macrodon pictum* nom. nov., Milaschewitsch, p. 145 (nom. nov., *pro Cucullaea cancellata* Rouillier, 1846).
 ?1883 *Macrodon pictum* Milaschewitsch; Lahusen, p. 80, pl. 2, figs. 13a, b.
 1905 *Macrodon pictum* Milaschewitsch; Borissiak, p. 15, pl. 2, figs. 16a–c, 17a–c.
 1905 *Macrodon pictum* Milaschewitsch var. *a* nov., Borissiak, p. 18, pl. 2, figs. 18a–d.
 1905 *Macrodon pictum* Milaschewitsch var. *b* nov., Borissiak, p. 18, pl. 2, figs. 19a–c.
 1905 *Macrodon pictum* Milaschewitsch var. *c* nov., Borissiak, p. 19, pl. 3, figs. 2a, b.
 1905 *Macrodon pictum* Milaschewitsch var. *d* nov., Borissiak, p. 19, pl. 3, figs. 1a–c.
 ?1905 *Macrodon* cf. *pictum* Milaschewitsch; Borissiak, p. 17, pl. 3, figs. 6a, b.
 ?1911 *Cucullaea* sp.; Boden, p. 65, pl. 7, figs. 7, 7a.
 1915 *Macrodon pictum* Milaschewitsch; Krenkel, p. 309, pl. 26, figs. 9–10.
 1919 *Arca (Nemodon) goldfussi* (Roemer); Couffon, p. 68, pl. 5, figs. 1–1c.
 1923 *Cucullaea couffoni* nom. nov., Cossmann, p. 12, pl. 6, figs. 5–7 (*pro Arca (Nemodon) goldfussi* Couffon non Roemer).
 1930a *Parallelodon (Grammatodon) schourovskii* (Rouillier); Arkell, p. 340, pl. 15, figs. 7–7b (*non* Rouillier).
 1930a *Parallelodon (Grammatodon) pictum* (Milaschewitsch); Arkell, p. 341, pl. 15, figs. 8–8b.
 ?1934 *Pseudomacrodon pictum* (Milaschewitsch); Stoll, p. 9, pl. 1, fig. 12.

Holotype. SM J6007; Pl. 2, fig. 1; 'Kelloway Rock' of Scarborough, Yorkshire. *Paratype.* SM J12359 from the same locality and horizon as the holotype.

Measurements

	L	H	I	AL	Lh	Posterodorsal angle
N	47	47	27	47	46	46
\bar{x}	10.3 mm	72.6%	55.1%	41.4%	73.4%	110.9°
Max	14.5	84.3	76.1	50.5	82.1	118
Min	6.0	62.4	36.5	31.0	66.4	99
OR	8.5	21.9	39.6	19.5	15.7	19

Description. Medium-sized species, subrectangular to subquadrate in outline, inequilateral, equivalve, with extremely variable form; umbones situated in front half of shell, prominent, variably inflated and slightly prosogyrate, salient up to 3 mm above hinge margin, not contiguous; ligament area variable, but usually occurring as an elongate diamond, up to 3 mm wide in very inflated specimens; area stretches almost entire length of hinge margin, and has chevron-shaped grooves radiating from beneath umbones; dorsal margin straight to slightly concave, consisting mainly of hinge line, often having anterodorsal angle protruding above general level of dorsal margin; anterior margin very strongly convex, its most anterior point lying in front of anterodorsal angle, curving evenly into gently convex to straight ventral margin; form of ventral margin

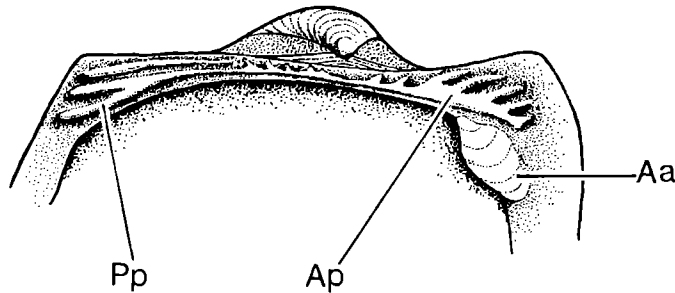

TEXT-FIG. 10. Internal view of the hinge of the left valve of a specimen of *Grammatodon (Grammatodon) minimus* (Leckenby), from the Lower Oxford Clay (*grossouvrei* Subzone, *coronatum* Zone) of Stewartby, Beds. (LU 68627), showing the relationship of the oblique anterior pseudolateral teeth to the subhorizontal posterior pseudolaterals, $\times 6$. **Aa** = anterior adductor scar; **Ap** = anterior pseudolaterals; **Pp** = posterior pseudolaterals.

depends on shell length, being evenly curved with anterior margin in short forms, and becoming straight, but not parallel to hinge margin, in more elongate forms; in elongate forms, ventral margin oblique to hinge margin, and if extended, would meet hinge margin at *c.* $1\frac{1}{2}$ times shell length behind the posterodorsal angle; posterior margin obliquely truncate and very slightly convex, meeting ventral margin at prominent, but rounded, posteroventral angle; posterodorsal angle variable, tending to be greater in more elongate forms; umbonal carina present, more inflated forms having more rounded carinae, low inflation forms having more angular carinae; sculpture distinctive, with concentric riblets dominant over rather faint radial striae, which become slightly stronger anteriorly and posteriorly, giving a very finely cancellate pattern over whole of shell; there is no marked coarsening of the radial striae on the anterior or posterior extremities; margin entire, and not crenulated; adductor scars suborbicular, subequal, not raised on buttresses, and placed close to hinge plate; pallial line entire; dentition of typical *Grammatodon* type, with 3–5 horizontal posterior pseudolaterals, and 5–7 oblique anterior cardinals converging to a point beneath umbones (Text-fig. 10); dorsal and ventral margins of all teeth very finely crenulate.

Remarks. *Grammatodon minimus* is a very distinctive species, whose main diagnostic features are the subquadrate form and the overall fine cancellate ornament pattern. The holotype is a well-

preserved left valve which shows the ornament particularly well; on the same slab is a paratype (un-numbered) showing more closely-packed concentric riblets, and also allowing examination of the ligament area. Both specimens agree closely with the abundant material from the Lower Oxford Clay.

G. minimus is identical to the species from the Oxfordian of Russia whose variation has been discussed at length by Borissiak (1905, p. 49), and which was placed by him in *Macrodon pictum* Milaschewitsch. Borissiak recognized five varieties of this species, based on slight differences in outline, inflation, and position of the umbones. Exactly the same range of variation may be seen in the British material, collected mainly at Calvert and Stewartby, where the great abundance of the species allows detailed variation studies to be made. Whereas Borissiak found that two of his varieties (*var. c* and *var. d*) were apparently restricted to deposits of 'Sequanian' (Upper Oxfordian) age, specimens fitting with all his varieties may be found together in the same bed in Britain, indicating that at least here variation is continuous, and not stratigraphically controlled. Arkell (1930a, pl. 15, figs. 7-8) reproduced two of Borissiak's figures (1905, pl. 2, figs. 17 and 16 respectively), but mistakenly placed them in two distinct species, *Parallelodon (Grammatodon) schourovskii* (Rouillier) and *P. (G.) pictum* (Milaschewitsch); Borissiak had identified both these specimens as *Macrodon pictum*, and it is clear that this is their true position. *Grammatodon schourovskii* (Rouillier & Vossynski 1847) is from the Volgian (S. R. A. Kelly, 1977, pers. comm.).

In the Lower Oxford Clay of the English Midlands, *G. minimus* appears abruptly at the base of the *grossouvrei* Subzone (*coronatum* Zone), invariably in great numbers. Study of the plates and the measurement statistics reveals the range of variation of the species, the most variable features being inflation and anterior length. Of these, inflation is the more variable, very tumid and very flat specimens occurring side by side. The degree of inflation also has a profound effect on the width and shape of the ligament area, with wider, rather triangular areas occurring in very tumid specimens, whilst specimens of low inflation usually have areas of lanceolate form. It is also noticeable that it is only the very inflated forms ($I > 60\%$) which show the development of an obliquely elongate ventral margin, more subquadrate forms usually being considerably less inflated. Examination of the very inflated forms reveals that it is only in the late stages of growth that high inflation and obliquity develop, the latest-formed parts of the shell being very steep-sided, together with the relatively rapid expansion of the anterior parts of the shell. The most obvious difference between the specimens described by Borissiak and the British forms is one of maximum size; the largest British specimen known is 14.5 mm long, whilst the maximum size of Borissiak's specimens is 23 mm.

A good deal of variation in the strength of the fine radial striae occurs in *G. minimus*, there being a gradation from forms where the flanks of the shell are almost devoid of radial elements to forms in which radial striae are much more obvious, and a clear cancellate pattern is developed. There is no apparent correlation between strength of radial striae and any other shell parameter, cancellate development occurring in each morphotype to varying degrees. All specimens share, however, the lack of conspicuous radial riblets on the anterior extremities, although there is slight coarsening of the striae anteriorly and posteriorly. This is in direct contrast to most other Jurassic species of *Grammatodon*, including *G. concinnus* and *G. hersilius*, which usually have up to 6 prominent anterior radial riblets. The same is true of the posterior area, which in other species of *Grammatodon* is usually ornamented with 12-15 coarsened radial striae, whilst in *G. minimus*, although there is slight coarsening of the radial striae on the posterior area, they are still very fine. Borissiak's description and figures suggest that Russian forms of the species have more prominent radial sculpture over the whole shell, although a good deal of variation may be seen from his figures. The specimen figured by Lahusen (1883, p. 80, pl. 2, figs. 13a, 13b) as *Macrodon pictum* appears also to be decorated with rather prominent radial striae, which are coarsened over the anterior and posterior areas, and there is some doubt as to whether or not his identification is correct.

Stoll (1934, p. 9) erected the new genus *Pseudomacrodon*, with *Macrodon pictum* Milaschewitsch as the type-species, on the premise that the dentition is not that of *Macrodon* (now known as

Parallelodon) or *Cucullaea*, although it is closer to the former. *Pseudomacrodon* is synonymous with *Grammatodon*.

Range and occurrence. Abundant in the Lower Oxford Clay (*grossouvrei* Subzone) of central and southern England (found at Weymouth, Calvert, Bletchley, Stewartby and Norman Cross); rare in the *jason* and *obductum* subzones at these localities; Hackness Rock (*athleta* to *lamberti* zones) of Scarborough, Yorkshire; Callovian of Maine-et-Loire and Deux-Sèvres, France (Couffon 1919; Cossmann 1923); Middle Callovian of Pommerania (Stoll 1934); 'Middle to Upper Kelloway, Jason-Ornaten horizon' (*jason* to *coronatum* zones) and 'Lamberti-Schichten' (*lamberti* Zone) of Popilani, Russia (Krenkel 1915); *cordatum* Zone of Russia (Lahusen 1883; Boden 1911), 'Oxfordien und Séquanien' of Central Russia (Borissiak 1905).

2. **Grammatodon (Grammatodon) concinnus** (Phillips, 1829) Pl. 2, figs. 7, 11-17, 19;
Text-fig. 11

- 1829 *Cucullaea concinna* sp. nov., Phillips, pl. 5, figs. 9, 31 (?).
1850 *Arca gnoma* sp. nov., d'Orbigny, p. 339, no. 186.
non 1853 *Cucullaea concinna* Phillips; Morris & Lycett, p. 50, pl. 5, fig. 7 [= *Grammatodon bathonicus* Cox & Arkell, 1948].
?1856 *Cucullaea concinna* Phillips; Quenstedt, p. 504, pl. 67, figs. 15, 16.
non 1882 *Cucullaea* cf. *concinna* Phillips; Roeder, p. 64, pl. 1, figs. 5a-c.
1883 *Cucullaea concinna* Phillips; Lahusen, p. 86, pl. 2, fig. 17.
1897 *Arca (Macrodon) concinna* (Phillips); de Loriol, p. 109, pl. 14, figs. 5-11.
?1899 *Arca (Macrodon) concinna* (Phillips); de Loriol, p. 150, pl. 10, figs. 6, 6a, 7, 7a.
1901 *Arca gnoma* d'Orbigny; Raspail, p. 194, pl. 11, fig. 10.
non 1919 *Arca (Nemodon) gnoma* d'Orbigny; Couffon, p. 68, pl. 5, figs. 2-2c, 3-3b.
non 1919 *Arca (Beushausenia) concinna* (Phillips); Couffon, p. 71, pl. 5, figs. 6-6c.
1923 *Parallelodon gnoma* (d'Orbigny); Cossmann, p. 14, pl. 6, figs. 8-12.
1925 *Arca gnoma* d'Orbigny (*partim*); Cottreau, p. 23, pl. 40, figs. 8, 9 (non figs. 10, 11).
1930a *Parallelodon (Grammatodon) concinnum* (Phillips); Arkell, p. 341, pl. 15, figs. 2-4.
?1972 *Grammatodon concinnus* (Phillips); Walker, p. 118.

Holotype. YM 941; figured Phillips 1829, pl. 5, fig. 9; Pl. 2, fig. 7; Oxford Clay (*mariae* Zone), near Scarborough, Yorkshire.

Measurements

	(2 valves)					Posterodorsal
	L	H	AL	I	Lh	angle
N	37	37	37	12	35	36
\bar{x}	17.3 mm	62.1%	39.0%	56.0%	83.2%	106°
Max	24.0	73.5	45.7	64.8	96.8	126
Min	14.0	52.2	32.6	40.0	69.4	92
OR	10.0	21.3	13.1	24.8	27.4	34

Description. Equivalve, inequilateral, umbones placed anterior of median; large-sized shells, obliquely subrectangular in outline, with long straight hinge line occupying nearly whole length of shell; umbones small, prosogyrate, distinctly salient to hinge line (up to 3 mm) and not contiguous (up to 3 mm separation observed); straight dorsal margin truncated anteriorly by sharp antero-dorsal angle, approximating a right angle; anterior and ventral margins evenly and convexly curved, meeting oblique posterior margin at ventral end of umbonal carina and forming acute posteroventral angle; posterodorsal angle obtuse. Sharply defined umbonal carina runs from posterior side of umbones more or less directly to posteroventral angle, marking off radially striated posterior area (12-15 striae); flanks of shell often ornamented by fine radial striae, giving a finely cancellate pattern where they cross growth lines; 3-5 coarse, widely-spaced radial riblets diverge from anterior side of umbones, separated by intercalatory fine radial striae. Inflation moderate. Ligament duplivincular, cardinal area broad, widening with age, well-defined and ornamented with chevron-shaped grooves radiating from beneath umbones.

Dentition taxodont, teeth radiating upwards from a point immediately beneath umbones,

anterior series short and oblique, posterior series flex over and run subparallel to hinge margin. Margins entire, not crenulated. Musculature not seen.

Remarks. Etheridge (1875, p. 326), claimed that the holotype of *Grammatodon concinnus* was in the Bean collection, although the specimen in the Yorkshire Museum labelled as the holotype bears a label referring it to the Reed collection. There is thus some doubt as to the authenticity of the supposed holotype, although the specimen bears a label in Phillips' handwriting, and agrees with the original figure. The balance of evidence seems to suggest that Etheridge's record was in error. Phillips' paratype from the 'Kelloway Rock' (1829, pl. 5, fig. 31), an indeterminate steinkern, is not in the Phillips' collection at York, and is considered lost.

G. concinnus is a very variable species, as may be seen from populations from Yorkshire and the English Midlands. The holotype, and all topotypes seen, are steinkerns, making relationships with shelled specimens difficult to establish. However, the external form measurements, and the ornament of the Yorkshire specimens agree well with those from the Lower Oxford Clay of central and southern England, and populations from the two areas are united here. The most notable difference between the two populations is in the size of the posterodorsal angle, the Yorkshire specimens usually having a slightly greater angle (110–120°) than the central England ones (92–126°). Other measurements are more or less equally variable, with overlap between populations from the two regions. Within the Midlands population, strength of cancellate ornamentation on the flanks of the shell is the most variable feature, some specimens having virtually no radial striae, whilst others have a strongly cancellate pattern. In all specimens, however, the anterior and posterior radial riblets and striae remain clearly defined. The presence of the anterior and posterior riblets and striae on the Yorkshire steinkerns suggest that they are in fact composite internal and external moulds, but no evidence of radial striae on the flanks is apparent.

The specimens figured by Morris & Lycett (1853) as *Cucullaea concinna*, from the Great Oolite (Bathonian) of Gloucestershire, differ from the Oxford Clay species in being more subrectangular in outline, and having distinct regular concentric ornament. This species was renamed *Grammatodon bathonicus* by Cox & Arkell (1948). Walker's (1972) figure of *G. concinnus* from the Kelloways Rock of South Cave (Yorkshire) shows a specimen with subparallel anterior and posterior tooth rows, which is not the normal situation for this species.

Range and occurrence. Kelloways Rock to Lower Oxford Clay (*calloviense* to *jason* zones) of central and southern England; Kelloways Rock of Yorkshire; Oxford Clay (*mariae* Zone) of Yorkshire; Callovian to Oxfordian of France, Germany, Switzerland and Poland.

3. **Grammatodon (Grammatodon) hersilius** (d'Orbigny, 1850) Pl. 2, figs. 18, 20, 24;
Text-fig. 11

- 1850 *Arca hersilia* sp. nov., d'Orbigny, p. 368, no. 343.
 ?1888 *Arca quenstedtii* nom. nov., Lycett in Damon, pl. 2, fig. 9 (nom. nov. pro *Arca aemula* Quenstedt, non Phillips).
 1901 *Arca (Macrodon) montaneyensis* sp. nov., de Loriol, p. 83, pl. 5, figs. 12–14.
 1919 *Arca (Beushausenia) concinna* (Phillips); Couffon, p. 71, pl. 5, figs. 6–6c (non Phillips).
 1927 *Arca hersilia* d'Orbigny; Cottreau, p. 59, pl. 47, figs. 12, 13.
 1930a *Parallelodon (Grammatodon) montaneyensis* (de Loriol); Arkell, p. 341, pl. 15, fig. 6.
 1975 *Grammatodon (Grammatodon) montaneyensis* (de Loriol); Duff, p. 446.

Holotype. MHNP 3711; Figured Cottreau 1927, pl. 47, figs. 12–13; Oxfordian of Neuvizy, France.

Measurements

	(2 valves)					
	L	H	I	AL	Lh	Posterodorsal angle
N	5	5	4	5	5	5
\bar{x}	23.8 mm	63.0%	58.0%	38.5%	85.8%	108.8°
Max	28.0	66.7	62.8	42.9	91.1	116
Min	20.0	58.8	55.0	35.3	80.0	99
OR	8.0	7.9	7.8	8.6	11.1	17

Description. Large equivalve, inequilateral species, with umbones situated anterior of median; outline subrectangular, with most of length being occupied by long straight hinge line which meets oblique posterior margin at obtuse posterodorsal angle; posteroventral angle well-marked, about a right angle, located at the point where umbonal carina reaches ventral margin; anterodorsal angle about a right angle, anterior margin curving evenly into straight to slightly convex ventral margin, itself subparallel to dorsal margin. Umbones inflated, prosogyrate, anterior of median, salient up to *c.* 3 mm above hinge line, not contiguous. Umbonal carina delimits posterior area, which bears 6–8 radial riblets and faint intercalatories; anterior parts of valves have 4–6 coarse radial riblets, diverging from beneath umbones; flanks of shell covered by regular radial striae, occasionally becoming obsolete, which continue onto anterior and posterior areas as intercalatories; concentric growth lines of variable strength, occasionally showing marked growth halts.

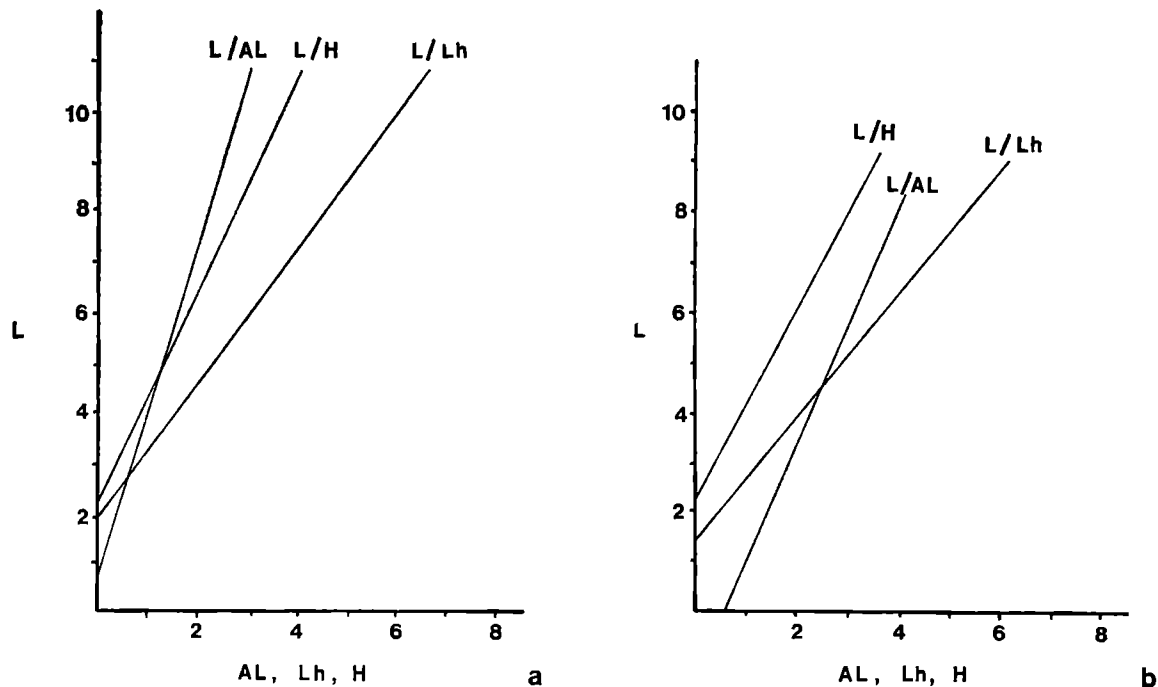

TEXT-FIG. 11. Comparison of the regression lines for various relative growth rates in *Grammatodon (Grammatodon) concinnus* (Phillips) and *Grammatodon (Grammatodon) hersilius* (d'Orbigny). a. The regressions for Length/Height, Length/Anterior Length and Length/Hinge-length for *G. (G.) concinnus*. b. The same parameters for *G. (G.) hersilius*. Note the close similarity between regressions for the same pairs of characters in each of the species. Scales in mm.

Inflation about equal to that of *G. concinnus*, giving a rather tumid shell, with maximum inflation slightly ventral of hinge line. Ligament duplivincular, cardinal area broad (widening with growth), ornamented by chevron-shaped grooves radiating from beneath umbones.

Dentition taxodont, with short oblique anterior cardinal teeth and long posterior pseudolaterals subparallel to hinge margin; point of origin of teeth is below umbones, and teeth radiate upwards. Margins entire, not denticulate. Musculature not seen.

Remarks. The similarities in general form between this species and *G. concinnus* are apparent from comparison of the measurements and the regression lines (Text-fig. 11), although *G. hersilius* is slightly more rectangular. The main differences are that in *G. hersilius* the posteroventral angle is not the most ventral part of the shell, there is a greater tendency for the ventral margin to be parallel to the hinge line, and the radial striae are much more regular on the valve flanks. The differences between the two species are not great, but none of the British specimens of *G. concinnus*

approach the subrectangular outline of *G. hersilius*. However, a specimen assigned to *G. concinnus*, from the Kellaways Rock of Sutton Benger, Wiltshire (GSM Zr1699), occurs in association with two specimens of *G. hersilius* (GSM Zr1698, 1700), and it is possible that *G. hersilius* is merely an extreme variant of *G. concinnus*. The difference in riblet and striae density on the anterior and posterior areas remain, however, and until further specimens become available, the two species are considered to be separate.

Arca subtetragona Morris (1850, p. 318, pl. 30, figs. 5–5b), from the Kellaways Rock of Wiltshire, resembles *G. hersilius* in its strongly rectangular outline, but is not as elongate, and lacks the radial striae on the flanks of the shell. The specimen figured by Morris is lost, and no comparable specimens are preserved in any of the major museums, so the status of this species must remain uncertain.

Arca quenstedtii Lycett in Damon (1888), from the Oxford Clay of Weymouth closely resembles *A. subtetragona*, differing only in the possession of regular radial striae on the flanks of the shell. In this respect, the similarities between *A. quenstedtii* and *G. hersilius* are very close, but again, Lycett's figured specimen is lost, and the status of the species must remain in doubt.

Range and occurrence. Kellaways Rock (*calloviense* Zone) of Wiltshire; ?Lower Oxford Clay (*jason* Zone) of central England (Stewartby). Oxfordian of France and Switzerland.

4. **Grammatodon (Grammatodon) clathratus** (Leckenby, 1859) Pl. 2, figs. 21–23, 25–27

1859 *Cucullaea clathrata* sp. nov., Leckenby, p. 13, pl. 3, fig. 4.

1863 *Cucullaea clathrata* Leckenby; Lycett, p. 44, pl. 39, figs. 4, 4a.

1867 *Cucullaea clathrata* Leckenby; Laube, p. 34, pl. 2, fig. 11.

1905 *Cucullaea* cf. *clathrata* Leckenby; Borissiak, p. 56, pl. 3, figs. 15, 15a.

1948 *Cucullaea clathrata* Leckenby; Cox & Arkell, p. 2 (pars).

Holotype. SM J6005; Pl. 2, fig. 22; Hackness Rock (*athleta* to *lamberti* zones) of Castle Hill, Scarborough, Yorkshire.

Measurements

	L	H	I	AL	Lh	Posterodorsal angle
N	9	9	9	8	7	8
\bar{x}	33.3 mm	60.9%	48.6%	35.4%	72.0%	135.5°
Max	50.7	66.7	56.8	40.2	76.6	140
Min	23.5	53.9	40.0	27.5	68.4	126
OR	27.2	12.8	16.8	12.7	8.2	14

Description. Equivalve, inequilateral species, of large size and subtrapezoidal outline, umbones placed 27.5–40.2% of shell length behind anterior margin; umbones inflated, prominent, prosogyrate, salient up to *c.* 4 mm above hinge line, not contiguous. Hinge line straight, relatively short, meeting obliquely truncate posterior margin at an angle of *c.* 135°; anterior margin evenly curved meeting dorsal margin at an angle of between 100–120°, passing smoothly into ventral margin, itself subparallel to hinge line; posteroventral angle acute, marking the point at which rounded umbonal carina reaches ventral margin. Ornament of fine radial riblets over anterior and median parts of valves, becoming wider and flatter over posterior regions; fine concentric growth lines produce a cancellate pattern where they cross costellae. Ligament duplivincular, cardinal area diamond-shaped and clearly-defined, ornamented with chevron-shaped grooves diverging from beneath umbones. Inflation moderate.

Dentition taxodont, with pseudolaterals being subparallel to hinge line at both ends, with fine crenulations running vertically up their dorsal and ventral faces. Margin entire, with no denticulations. Adductor muscle scars subequal, posterior scar slightly larger, not raised on a myophoric buttress; scars ovate, placed beneath anterior and posterior ends of hinge line; pallial line entire.

Remarks. The variability of *G. clathratus* may be seen from the measurements and illustrations. It agrees in this respect with Arkell's (1929, p. 42) description of the similar '*Cucullaea contracta* Phillips from the Corallian Beds. The dentition and musculature of '*C. contracta*' are not known, so its generic position is uncertain. These two are, however, distinct species differing in form and ornamentation,

with *G. clathratus* being more elongate ('*C.*' *contracta* $H \bar{x} 72.7\%$), less inflated ('*C.*' *contracta* $I \bar{x} 65.2\%$), and lacking the coarsened radial ornament on the anterior flank. The specimens of *G. clathratus* from the Lower Oxford Clay of Stewartby and Chippenham are less inflated than the Yorkshire Cornbrash and Hackness Rock specimens, but are very similar in all other respects.

The pyritized valves from Stewartby show the dentition and ligament areas to be rather abnormal for *Grammatodon*. Both anterior and posterior pseudolaterals are horizontal, with no evidence of either central vertical teeth, or oblique anterior pseudolaterals. In this they are very similar to the condition seen in the Cucullacidae, although the pseudolaterals are shorter and more massive in that family. However, the other typically cucullacid features, such as a prominent series of central subvertical teeth, a prominent posterior myophoric buttress, and a subquadrate outline, are notably lacking in *G. clathratus*.

Previous authors have referred this species to *Cucullaea* on the basis of its external form and ornament. The ornament pattern differs from that of a 'typical' *Grammatodon* in that it lacks the strengthened anterior and posterior radial striae and in this respect, agrees well with *G. minimus*. The good preservation also shows the finely crenulated sides of the pseudolaterals.

Many British and Continental species of *Cucullaea* closely resembling *G. clathratus* have been described, although it is doubtful whether they are in fact true cucullaeids. *Arca harpax* d'Orbigny (1850) was shown by Cottreau (1928, p. 57, pl. 47, figs. 4-6) to be superficially close to *G. clathratus*, and have similar *Cucullaea*-like dentition. However, Arkell (1935, p. vii) referred *A. harpax* and *A. halie* d'Orbigny (1850) to *Cucullaea contracta* Phillips, because of overlap in the variation ranges of the three forms, all of which are Oxfordian. The French Oxfordian specimens agree with the English specimens of '*C.*' *contracta* in being more elongated and less inflated than *G. clathratus*. *Cucullaea cancellata* Phillips (1829, pl. 9, fig. 24), from the Scarborough Limestone (Bajocian) of Yorkshire is also closely related, but study of topotypes in the Yorkshire Museum reveals that the radial ornament is virtually obsolete, the posterior margin is more truncate than oblique, and elongation is considerably less.

Cox & Arkell (1948, p. 2), using Lycett's (1863) figures, referred *Cucullaea corallina* Damon (pl. 39, fig. 3) and *Grammatodon clathratus* Leckenby (p. 39, fig. 4), together with *C. corallina* Lycett in Damon of Laube (1867), to *C. clathrata*. The originals of Lycett's figures, SM J5670 and J5669 respectively, appear to represent two distinct species, vindicating Lycett's identifications. In addition to SM J5670, from the Cornbrash of Yorkshire, there are four specimens of *C. corallina* from the Yorkshire 'Kelloway Rock' (SM J12360-12363), all of which are clearly distinct from *G. clathratus*. These agree well with Arkell's (1929, p. 42) conception of *C. contracta* Phillips (of which *C. corallina* Lycett in Damon is a junior synonym) in form and ornamentation. In the absence of specimens transitional between *G. clathratus* and '*C.*' *contracta*, it seems best to extend the range of '*C.*' *contracta* down to the Cornbrash, so as to include the Yorkshire Cornbrash and 'Kelloway Rock' forms. *C. corallina* Laube (1867, p. 34, pl. 2, fig. 11) fits into the extended range of this species and is considered to be synonymous with it.

Range and occurrence. Cornbrash, Scarborough; Lower Oxford Clay (*medea* Subzone, *jason* Zone) of Stewartby; Hackness Rock (*athelta* to *lamberti* zones), Scarborough; Oxford Clay (horizon unknown), Chippenham, Wiltshire.

Order *MYTILOIDA* Ferussac, 1822

Superfamily MYTILACEA Rafinesque, 1815

Family MYTILIDAE Rafinesque, 1815

Subfamily MODIOLINAE Keen, 1958

Genus **MODIOLUS** Lamarck, 1799

(nom. conserv. pro *Volsella* Scopoli, 1777 [ICZN Opinion 325, 1955])

(Synonyms: *Modiola* Lamarck, 1801; *Perna* Adams & Adams, 1858;

Eumodiolus Ihering, 1900; *Nudiola* Monterosato, 1917)

Type species. By absolute tautonymy; *Mytilus modiolus* Linnaeus 1758, p. 706; Recent, European seas.

Diagnosis. Shell more or less trapeziform in outline, usually transversely elongate, with angle of obliquity usually less than 45°; inflation variable; anterior margin usually convex, protruding in front of umbones, which are never terminal; anteroventral region expanded, usually marked off from body of shell by a rounded ridge running from umbones to posteroventral margin; hinge line smooth, lacking teeth; ligament external, long; shell smooth, or with concentric ornament.

Subgenus **MODIOLUS** s.s.

Diagnosis. Shell transversely elongate, well-inflated, umbonal region frequently prominent and inflated; diagonal bounding ridge of anteroventral area well-defined; shell smooth, sometimes with weak concentric plications; periostracum hirsute in Recent specimens.

Remarks. The ICZN ruling of 1955 (Opinion 325) suppressed *Volsella* Scopoli, 1777, and validated *Modiolus* Lamarck, 1799. Lamarck's (1801, p. 113) subsequent emendation of the name to *Modiola* was technically unjustified, giving *Modiola* the status of a junior subjective synonym.

Modiolus is a very long-ranging genus (Devonian to Recent), in which several subgenera have been distinguished, all (except *Gibbomodiola* Sacco, Oligocene to Recent) of Recent age. The fossil species of *Modiolus* do not readily lend themselves to subgeneric classification, and most are left in *Modiolus* s.s. (see Cox 1940, p. 63). The status of *Modiolus*, and its relationship with *Mytilus* and other Mytilidae, is discussed by Cox (1937, p. 339).

Modiolus (Modiolus) bipartitus J. Sowerby, 1818 Pl. 2, figs. 28–33

- 1818 *Modiola bipartita* sp. nov., J. Sowerby, p. 17, pl. 210, fig. 4 (*non* fig. 3).
 1829 *Modiola bipartita* J. Sowerby; Phillips, pl. 4, fig. 30.
 1860 *Modiola bipartita* J. Sowerby; Damon, pl. 2, fig. 12.
 1860 *Modiola cuneata* J. Sowerby; Damon, pl. 2, fig. 13 (*non* J. Sowerby).
 1871 *Modiola bipartita* J. Sowerby; Phillips, pl. 13, fig. 25.
 1897 *Modiola tulipaea* Lamarck; de Loriol, p. 118, pl. 15, figs. 1–3.
 ?1901 *Modiola villersensis* (Oppel); Raspail, p. 193, pl. 12, fig. 10.
 1911 *Modiola aequiplicata* Strombeck; Boden, p. 68, pl. 7, figs. 13, 13a only.
 1915 *Modiola tulipaea* Lamarck; Cossmann, p. 10, pl. 5, fig. 10.
 1928 *Modiola bipartita* J. Sowerby; Douglas & Arkell, p. 174, pl. 12, figs. 8, 9.
 1929 *Modiola bipartita* J. Sowerby; Arkell, p. 55, pl. 2, figs. 1–4.
 1932 *Modiola holesa* d'Orbigny; Corroy, p. 197, pl. 27, fig. 14 (*non* d'Orbigny).
 ?1934 *Modiola aequiplicata* Strombeck; Stoll, p. 23, pl. 2, fig. 29.
 1940 *Modiola* cf. *bipartitus* J. Sowerby; Cox, p. 67, pl. 5, figs. 11, 12.
 1948 *Modiolus bipartitus* J. Sowerby; Cox & Arkell, p. 4.
 1952 *Modiola aequiplicata* Strombeck; Makowski, p. 18, pl. 1, fig. 15.

Lectotype. Designated Arkell 1929, p. 56; BM 43231; figured J. Sowerby 1818, p. 17, pl. 210, fig. 4; Pl. 2, fig. 28; Oxford Clay of Osmington, Dorset.

Measurements

	L	H	I	Lh
N	29	29	25	26
\bar{x}	50.1 mm	77.6%	45.8%	45.4%
Max	70.0	100.2	54.5	58.0
Min	36.5	66.0	39.0	35.7
OR	33.5	34.2	15.5	22.3

Description. Large species, equivalve, markedly inequilateral and oblique, umbones subterminal; elongate elliptical to subtrapezoidal in outline, very variable in relative proportions of length and height. Hinge line long, about half the length of shell, straight or gently convex, reaching anteriorly to umbones; anterior margin short, obliquely truncate, convex, anteroventral angle varying from a sharply-rounded right angle to a continuous smooth curve, passing into gently

convex anteroventral margin; ventral margin becomes gently concave in the region where the umbonal sulcus reaches it, then straightens out posteriorly and becomes convex again, passing evenly into sharply convex, semicircular, posteroventral angle; posterior margin meeting hinge line at a variably rounded angle of *c.* 150°, the margin itself being obliquely elongate and gently convex, often subparallel to posteroventral margin, passing smoothly into posteroventral angle. Umbones small, pointed, subterminal, prosogyrate, their tips tightly enrolled, salient up to *c.* 5 mm above hinge margin. A rounded ridge runs from apex of umbones in a more or less straight line to anterior side of posteroventral angle, dividing inflated body of shell from small, trigonal, anteroventral region of shell; a prominent rounded depression runs along anteroventral side of umbonal ridge; anteroventral region bulges prominently anteriorly, and attains its maximum inflation near anterior margin; maximum inflation of body of shell occurs in median region, not along umbonal ridge. Ornament consists of irregularly spaced concentric growth lines, locally coarsened and elevated as growth rugae; no imbricate ornament.

Ligament elongate, external, opisthodontic, parivincular, nymphs long, parallel to hinge line. Hinge teeth absent. Musculature and pallial line not visible.

Remarks. The synonymy of this very common Upper Jurassic species has been discussed by Arkell (1929, p. 56) and Cox (1940, p. 68), and little need be added. Arkell showed that the holotype of *Modiola tulipaea* Lamarck (refigured by de Loriol 1897, pl. 15, figs. 1–3) agrees perfectly with the lectotype of *Modiolus bipartitus*, thus simplifying the Continental usage considerably. The holotype of *Mytilus halesus* d'Orbigny, from the Callovian of Pas-de-Jeux, figured by Cottreau (1925, pl. 40, figs. 21–22), is a poorly preserved specimen which seems close to *M. bipartitus*, but more topotype material needs to be examined before definite conclusions can be drawn. The specimen figured by Corroy (1932) as *Modiola holesa* (d'Orbigny), from the Lower Callovian of the Paris basin, agrees perfectly with topotypes of *M. bipartitus*, as does the specimen figured by Makowski (1952) from the Middle Callovian of Lukow as *Modiola aequiplicata* Strombeck. The latter species was considered by Cox (1935, p. 162; 1940, p. 66; 1965, p. 36) to be synonymous with *Modiolus imbricatus* J. Sowerby (1818, p. 21, pl. 212, figs. 1, 3), a species usually recorded from the Bathonian to Callovian of Britain. Since *M. aequiplicata* generally has been recorded from the Oxfordian and Kimmeridgian, Cox extended the range of *M. imbricatus* accordingly. *M. imbricatus* seems to be restricted to the Bajocian to Callovian in Britain, and differs from *M. bipartitus* in its style of ornament (it has fine concentric threads, with pronounced growth lamellae, imbricated at irregular intervals) and in its overall form. *M. imbricatus* is usually less elongately oblique than *M. bipartitus*, with a less well-developed anteroventral bulge, the umbonal ridge being arcuate, usually fading before it reaches the ventral margin; the point of maximum inflation is located on the umbonal ridge, in contrast to the situation in *M. bipartitus*.

The holotype of *Mytilus consobrinus* d'Orbigny, figured by Cottreau (1928), also agrees well with topotypes of *M. bipartitus*. Arkell (1929, p. 56) cleared up the confusion over the provenance and identity of the type-specimen of *M. bipartitus*, designating the original of Sowerby's plate 210, fig. 4, as lectotype. Most Continental authors seem to have been led into error by Sowerby's sparse notes on this species.

A species of *Modiolus* occurs rarely in the Lower Oxford Clay of the Midlands, but is invariably crushed flat and considerably distorted, and as yet no specimens identifiable at the specific level have been found. It is likely that these specimens belong to *M. bipartitus*, as identifiable examples of the species occur in the *calloviense* Zone at Stewartby and the *athleta* Zone at Woodham, and the crushed Lower Oxford Clay specimens show no features by which they may be distinguished from that species.

Range and occurrence. Cornbrash to Corallian Beds of Great Britain, especially common in the Cornbrash, Upper Oxford Clay and Corallian Beds, but also found in the Kellaways Rock, Lower, and Middle Oxford Clay; *enodatum* and *grossouvrei* subzones at Stewartby, *medea* Subzone at Bletchley, *obductum* and *grossouvrei* subzones at Calvert, and *athleta* Zone at Woodham. Callovian to Oxfordian of Europe and India (Arkell 1929; Cox 1940).

Superfamily PINNACEA Leach, 1819

Family PINNIDAE Leach, 1819

Genus PINNA Linnaeus, 1758

(Synonyms: *Chimaeroderma* Poli, 1795; *Pinnarius* Duméril, 1806; *Pinnula* Rafinesque, 1815; *Pinnites* von Schlotheim, 1820; *Pennaria* Mörch, 1853 [non Oken, 1815])

Type species. Subsequent designation; Children 1823, p. 34; *Pinna rudis* Linnaeus, 1758, figured Lamarck, 1819, p. 60, pl. 2, fig. 80; Recent, West Indies.

Diagnosis. Equivalve, wedge-shaped, umbones terminal; valves with median carina, at least in juvenile stages; ribbing predominantly radial, but sometimes with growth undulations on the ventral region.

Subgenus PINNA s.s.

(Synonyms; *Chimaera* Poli, 1795 (non Linnaeus, 1758); *Sulcatopinna* Hyatt, 1892; *Quantulopinna* Iredale, 1939; *Subitopinna* Iredale, 1939)

Diagnosis. Wedge-shaped; ventral margin straight to concave in outline; median carina well-defined; sculpture of radial ribs or rows of scales.

1. **Pinna (Pinna) mitis** Phillips, 1829 Pl. 3, figs. 6–11, 13, 15; Text-fig. 12b

1829 *Pinna mitis* sp. nov., Phillips, pl. 5, fig. 7.

1850 *Pinna rugosoradiata* sp. nov., d'Orbigny, p. 340, no. 190.

1883 *Pinna mitis* Phillips; Lahusen, p. 86, pl. 2, fig. 12.

1907 *Pinna rugosoradiata* d'Orbigny; Cossmann & Thierry, p. 51, pl. 3, fig. 1.

1925 *Pinna rugosoradiata* d'Orbigny; Cottreau, p. 24, pl. 40, figs. 14–16.

1933 *Pinna mitis* Phillips; Arkell, p. 222, pl. 26, fig. 7.

?1934 *Pinna mitis* Phillips; Stoll, p. 19, pl. 2, fig. 9.

?1940 *Pinna cf. mitis* Phillips; Cox, p. 132, pl. 10, fig. 11.

1952 *Pinna mitis* Phillips; Makowski, p. 16, pl. 1, fig. 14.

Holotype. YM 219; Pl. 3, fig. 11; Oxford Clay (*mariae* Zone) of Scarborough, Yorkshire.

Measurements

	L	H	No. of Dorsal ribs	No. of Ventral ribs
N	21	12	18	18
\bar{x}	48.2 mm	44.2%	14.7	9.2
Max	82.4	50.9	22	14
Min	25.0	35.1	14	6
OR	57.4	15.8	8	8

Description. Large *Pinna*, with low inflation and rapidly diverging dorsal and ventral margins; maximum height less than half length. Umbones terminal, pointed, but often rather eroded. Dorsal margin straight to very slightly convex, ventral margin markedly concave for up to 40 mm from umbones, then becoming straight or slightly convex, curving evenly into rounded truncate posterior margin; posterodorsal angle about 110°, clear and well-marked. Median carina weak and not clearly visible, apparently because of low inflation; region dorsal to carina bears 13–22 fine, densely packed radial riblets, with more intercalatories coming in posteriorly; riblets being crossed by faint concentric growth lines, giving a fine reticulate pattern visible at a magnification of about 10 times; ventral region with 6–14 fine radial riblets, increasing in number posteriorly, occupying only the half of the region nearer the carina, crossed by concentric growth welts strongest at ventral margin and rarely reaching median carina. No internal features visible on any of the specimens examined, as the shell is thin and fragile.

Remarks. There has been a good deal of confusion in faunal lists about the name to be given to the Oxford Clay *Pinna*. Arkell (1933, p. 222) clarified the position by figuring the holotype of *P. mitis* and comparing it with *P. lanceolata* J. Sowerby, from the Corallian Beds. It is clear that the two species are distinct, *P. lanceolata* tending to expand gently away from the umbones, while *P. mitis* widens rapidly to give a fan-shaped shell; *P. mitis* is also much smaller, has a concave ventral

margin (Text-fig. 12), lacks puckerings on the posterior part of the shell, and has much finer ornament. However, specimens from the Oxford Clay of Wiltshire (Christian Malford, Chippenham and Wootton Bassett), preserved in the major museums, all appear to belong to a form with widely-spaced ribs of *lanceolata*-type. They occur in rocks from top *coronatum* to low *athleta* zones, where one would expect to find *P. mitis*, as that species occurs stratigraphically above and below this in other parts of England. Although these Wiltshire specimens are mostly fragmentary, their general shape appears to fit better the *mitis*-form, as the dorsal margin is straight, not concave, and there is no suggestion of the curved form so typical of *lanceolata*. It is possible that these specimens belong to a coarsely-ribbed variant of *P. mitis*, or may represent a new species. However, not enough specimens are preserved to allow a decision to be made, and at this stage I keep them in *P. mitis*. It should be

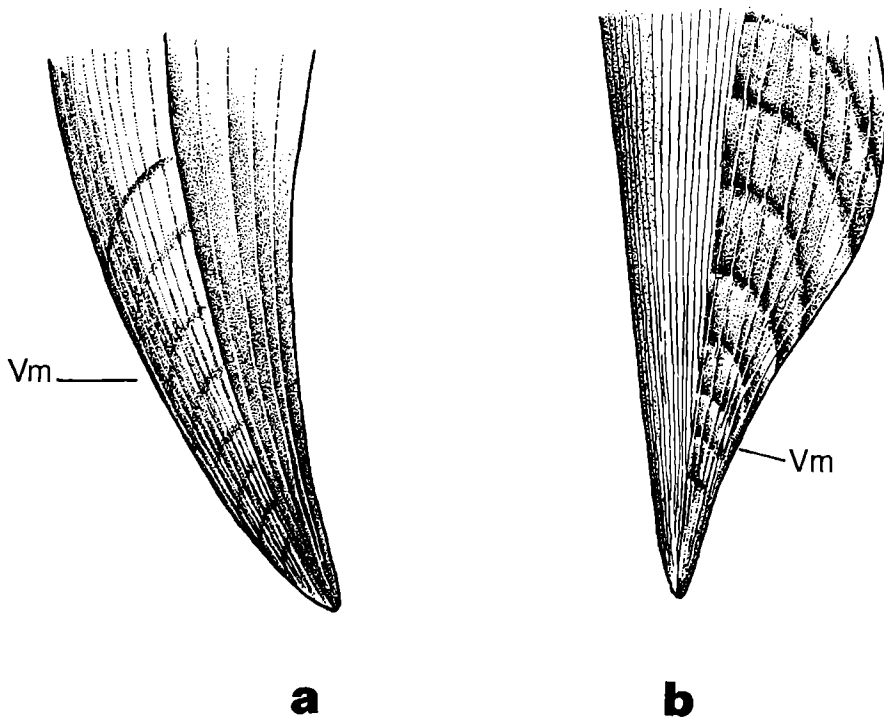

TEXT-FIG. 12. A comparison of the outline and ornamentation of *Pinna (Pinna) lanceolata* and *P. (P.) mitis*. a. The outline of a specimen of *P. (P.) lanceolata* J. Sowerby from the Lower Calcareous Grit (Oxfordian) of Scarborough, Yorkshire, seen from the right side, showing the convex ventral margin (**Vm**), and low rib density. b. The outline of a specimen of *P. (P.) mitis* Phillips, from the Lower Oxford Clay of Peterborough seen from the left side, showing the concavo-convex ventral margin (**Vm**), and the much higher rib density. Both $\times 1.5$.

noted, however, that they closely resemble some of the small forms of *P. lanceolata* from the Malton Oolite (Oxfordian) figured by Arkell (1933, pl. 29, figs. 1, 2) in possessing few, rather strong, wire-like ribs, and no intercalatories. See also remarks under *P. lanceolata* below.

P. cf. mitis Cox, from the Callovian to Divesian of Cutch, India, is probably identical, but appears to have rather weak concentric growth welts on the ventral parts of the valves, unlike the British specimens. Intercalation of ribs as growth proceeds is well seen in this specimen.

Range and occurrence. Abundant in *jason* to *coronatum* zones of the Lower Oxford Clay of the English Midlands, occurring at all the pits; *athleta* to *mariae* zones (Middle to Upper Oxford Clay) of Woodham, Bucks.; *mariae* Zone Oxford Clay of Scarborough, Yorkshire; *cordatum* Zone Oxford Clay of Warboys, Cambs.; *coronatum* to *athleta* Zone Oxford Clay of Wiltshire; Kellaways Rock of Wiltshire. Callovian of France, Germany, Poland, European Russia, and probably India.

2. **Pinna (Pinna) lanceolata** J. Sowerby, 1821 Pl. 3, figs. 14, 16, 19, 20; Text-fig. 12a1821 *Pinna lanceolata* sp. nov., J. Sowerby, p. 145, pl. 281.1822 *Pinna capricornus* sp. nov., Young & Bird, p. 240, pl. 9, fig. 5.1829 *Pinna lanceolata* J. Sowerby; Phillips, pl. 4, fig. 33.1933 *Pinna lanceolata* J. Sowerby; Arkell, p. 219, pl. 28, fig. 5; pl. 29, figs. 1-3; pl. 55, fig. 3.

Neotype. Designated by Arkell 1933, p. 222, pl. 28, fig. 5; SM J511; Lower Calcareous Grit (Oxfordian), Olivers Mount, Scarborough, Yorkshire.

Diagnosis. Very large, long (over 220 mm occasionally), narrow *Pinna* with dorsal and ventral margins diverging regularly, not unevenly as in *P. mitis*. Dorsal margin gently concave, ventral margin gently convex. Valves with median carina well-marked, and inflation much greater than in *P. mitis*. Dorsal part of valve with 8-10 sharp wire-like radial ribs, fading posteriorly, ventral part with 3-5 radial ribs, on part of valve nearest median carina; subconcentric growth welts on ventral margin. Posterior part of valves marked by coarse concentric growth puckers, along growth lines.

Measurements

	L	H	I	No. of dorsal ribs	No. of ventral ribs
N	7	7	6	7	5
\bar{x}	90.1 mm	34.6%	17.1%	7.3	4.2
Max	170.0	38.9	26.5	8	5
Min	37.6	24.3	11.0	6	3
OR	132.4	14.6	15.5	2	2

Remarks. This well-known Corallian Beds species has been well described by Arkell (1933, p. 219), and needs no further description; the differences between it and *P. mitis* are considered above, and shown in Text-fig. 12. The range of *P. lanceolata* is extended downwards by two specimens from the *mariae* Zone Oxford Clay of Scarborough (SM J26725, J26726). These specimens raise questions about the genetic relationships with the smaller *P. mitis*, but morphological criteria demand their separation. It is tempting to suggest that *P. lanceolata* represents the adult stage, and *P. mitis* the juvenile, of a single species, but this is unlikely on two grounds. First, there is always a difference in lateral outline of the two species (Text-fig. 12), *P. mitis* being more wedge-shaped, and as there is no shell resorption in bivalves, it is necessary to assume that these shape differences are original. Second, the density and strength of the ribs differ markedly, *P. mitis* having more and finer ribs than even the very early stages of *P. lanceolata*. In addition, the two forms are only very rarely found together, the Yorkshire occurrence being the only known case.

Range and occurrence. Oxford Clay (*mariae* Zone) of Scarborough, Yorkshire; abundant in the Corallian Beds (Arkell 1933) in many parts of Britain. SM J28813 from the Kellaways Rock of South Cave, Yorkshire may belong to this species.

Order *PTERIOIDA* Newell, 1965Suborder *PTERIINA* Newell, 1965Superfamily *PTERIACEA* Gray, 1847Family *PTERIIDAE* Gray, 1847Genus **PTEROPERNA** Morris & Lycett, 1853

(ex Lycett 1850, p. 413, 420, nom. nud.)

Type species. Original designation; Morris & Lycett 1853, p. 17; *Gervillia costatula* Eudes-Deslongchamps, 1824, p. 131, pl. 5, figs. 3-5; Bathonian of Europe.

Diagnosis. Subequivalve (left valve more convex than the right valve), inequilateral, oblique, bialate, with long pointed posterior auricle and short, rounded or pointed, anterior auricle; hinge line long, straight, thickened and transversely crenulated anteriorly, with one (LV) or two (RV) elongate posterior lateral teeth, subparallel to hinge margin; resilifer wide, flattened, triangular, running posteroventrally from beneath points of umbones; externally, posterior auricle

bears up to four elongate grooves, subparallel to hinge margin, lowest of which corresponds to lateral teeth; ornament dominantly concentric, but radial ribs present on the early growth stages of some species.

Remarks. The name *Pteroperna* was introduced by Lycett (1850) for a species (*P. gibbosa* Lycett, nom. nud.) from the Inferior Oolite (Bajocian) of Gloucestershire, but no figures were published, and it was not until three years later that the name was validated (with a different type-species) by Morris & Lycett.

Cox (1940, p. 88) pointed out that the ligamental area of this genus is external and obtusely triangular, not "internal and nearly parallel with the external margin", as stated by Morris & Lycett (1853, p. 17). The external grooves subparallel to the hinge margin are of use in distinguishing *Pteroperna* from *Pteria* and most bakevelliids, although similar grooves may sometimes be seen in certain species of *Bakevella* s.s. These grooves are of considerable use in specimens where it is not possible to see the interior of the hinge, and where only external features may be used in generic placement. Morris & Lycett (1853) also claim that a small anterior adductor muscle scar is present, but the existence of this scar is doubtful (Cox 1940).

Pteroperna? pygmaea (Dunker, 1837) Pl. 3, figs. 1–5; Text-figs. 13, 14

- 1837 *Avicula pygmaea* sp. nov., Dunker, in Koch & Dunker, p. 37, pl. 3, figs. 6a–6d.
 non 1853 *Pteroperna pygmaea* (Dunker); Morris & Lycett, p. 19, pl. 2, figs. 11, 11a [= *Pteroperna costatula* (Eudes-Deslongchamps)].
 ?1882 *Avicula pygmaea* Dunker; Roeder, p. 59, pl. 3, figs. 1a, 1b.
 1915 *Pteroperna pygmaea* (Dunker) (*partim*); Krenkel, p. 290, pl. 25, fig. 43; non pl. 26, figs. 1, 2.
 non 1934 *Pteroperna pygmaea* (Dunker) var. *baltica* nov., Stoll, p. 16, pl. 2, figs. 3, 4.
 non 1972 *Gervillia pygmaea* (Dunker); Walker, p. 121, pl. 8, fig. 18.

Lectotype. Here designated; the specimen figured in Dunker 1837, pl. 3, figs. 6a, 6b, as *Avicula pygmaea* sp. nov.; Oxfordian of Hannover, Germany; present location of this specimen unknown.

Measurements. (Text-fig. 13).

	L	Lh	ALh	PLh	OL	H	θ
N	11	11	9	9	11	11	9
\bar{x}	11.5mm	86.8%	27.4%	59.5%	88.7%	63.0%	32.9°
Max	15.3	93.8	32.3	68.8	100.0	73.0	38
Min	5.1	80.7	20.8	50.5	78.6	57.3	30
OR	10.2	13.1	11.5	18.3	21.4	15.7	8

Description. Medium-sized species, subequivalve, left valve slightly more inflated than right valve, inequilateral, oblique, pteriiform. Hinge margin long, straight, anterior part about half length of posterior part; anterodorsal angle sharp, acute, passing into sinuate anterior margin; anterior margin of auricle convex, becoming concave near where the faint bounding sulcus reaches margin, then convex again, passing smoothly into evenly convex ventral margin; posterior margin emarginate and deeply concave dorsally, becoming gently convex ventrally, and passing into ventral margin via sharply rounded, acute, posteroventral angle; shell markedly oblique, angle between hinge line and oblique length *c.* 33°; oblique length usually slightly greater than length of hinge margin. Umbones small, rounded, slightly prosogyrate, placed about a quarter of shell length behind anterior margin, those of left valve salient *c.* 0.5 mm to hinge line, those of right valve hardly salient. Posterior auricle longer and narrower than anterior auricle, with sharp-topped ridge running from umbones to posterior emargination, presumably marking position of posterolateral tooth; another ridge, slightly less elevated, runs along posterior part of hinge margin of posterior auricle; posterior auricle marked off from body of shell by wide sulcus running to dorsal side of posteroventral angle. Anterior auricle shorter, deeper, with faint ridge along hinge margin, marked off from body of shell by a very faint depression running subperpendicularly from hinge margin. Ornament of faint concentric lines, regularly spaced on body of

shell, *c.* 0.5 mm apart, more closely packed on posterior auricle; at dorsal extremities of anterior auricle lines bifurcate and become more elevated; on body of shell concentric lines are fine grooves.

Ligament area external, oblique, flattened, small resilifer placed immediately below umbo, and running posteroventrally from it. Hinge margin anterior to umbones obliquely flattened, and has *c.* 12 very fine, rather faint, vertical teeth. Just anterior to umbo, on ventral edge of hinge margin of left valve, is a rounded peg-like apophysis, with a central depression on the upper surface; immediately anterodorsal of apophysis is a slightly smaller triangular-shaped socket (Text-fig. 14). Posteriorly, long, narrow posterior lateral tooth runs from umbo about two-thirds to posterior end of hinge line, immediately ventral of ligamental area. Musculature and pallial line unknown. Inner ostracum of nacreous aragonite, outer ostracum of prismatic calcite.

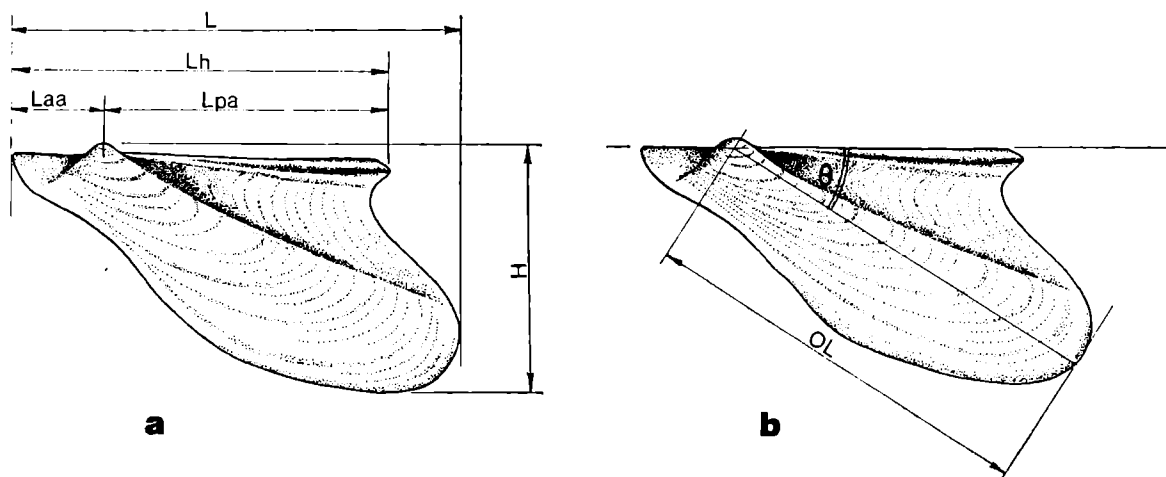

TEXT-FIG. 13. External view of the left valve of *Pteroperna? pygmaea* (Dunker), showing the measurements used in the description of this species. **H** = height; **L** = length; **Laa** = length of the anterior auricle; **Lh** = length of the hingeline; **Lpa** = length of the posterior auricle; **OL** = oblique length; θ = angle of obliquity.

Remarks. Well-preserved specimens of *P? pygmaea* from the Oxford Clay of Christian Malford (Wiltshire), are the basis of the above description. In size, shape and ornament, they agree closely with the specimens described and figured by Dunker from the Oxfordian of the Hannover area, and there can be little doubt of their identity. In BCM Cb4777, it has been possible to remove the shell from the clay steinkern and examine the hinge (Text-fig. 14), thus proving that the specimens concerned are pteriids rather than bakevelliids, as they lack multiple ligament pits. In most respects, the hinge of *P? pygmaea* agrees with that of the type species (*P. costatula*), but differs in possessing a peg-like divided tooth just anterior to the umbo of the left valve, and in the much weaker development of the series of short anterior teeth. *P? pygmaea* is closer to *Pteria* than *Pteroperna*, in the presence of the toothlike processes below the umbo and the single posterior lamina. It appears to represent a transitional stage between *Pteria* and *Pteroperna*, having dentition typical of *Pteria*, and external grooves on the posterior auricle typical of *Pteroperna*. Further material would help in clarification of the generic relationships, as unfortunately, the shell is so fragile that examination of the hinge almost invariably results in the destruction of the specimen. Thus, it is not possible to place this species with certainty, but as a concession to historical usage, it is left, for the moment, in *Pteroperna?*

Few authors have correctly interpreted *P. pygmaea*. Morris & Lycett (1853) figured two specimens from the Bathonian of Minchinhampton under this name, but these have the characteristic sharply-differentiated, finger-like anterior wing, and frequent radial ribbing on the early growth

stages of *P. costatula* (Deslongchamps). *Avicula pygmaea* Roeder (1882) is closely related to Dunker's species, but is much too large (H 45 mm) and has rather a short hinge (Lh 71.9%); identity with *P. pygmaea* is doubtful. Krenkel (1915, pl. 26, figs. 1, 2) appears to have caused much of the subsequent confusion by figuring a *Gervillella*, which clearly shows the serial ligament pits, under the name *P. pygmaea*. On the previous plate (pl. 25, fig. 43) he figured a correctly identified *P?* *pygmaea*, but this figure has not been placed in the synonymy lists given by Cox (1940, p. 90) or Walker (1972, p. 121). Stoll (1934, pl. 2, figs. 3, 4) figured two specimens of *P. pygmaea* var. *baltica* nov. which are specifically distinct from *P?* *pygmaea*, being much larger (L 35 mm), with very narrow, elongate posterior auricles, and a virtually obsolete anterior auricle. *Gervillia pygmaea* Walker (1972, pl. 8, fig. 18) is far too oblique (θ 21°), has too short a hinge line (Lh 67.0%) and not great enough height (H 35.2%) for *P. pygmaea*. Walker accepted Krenkel's figure (pl. 26,

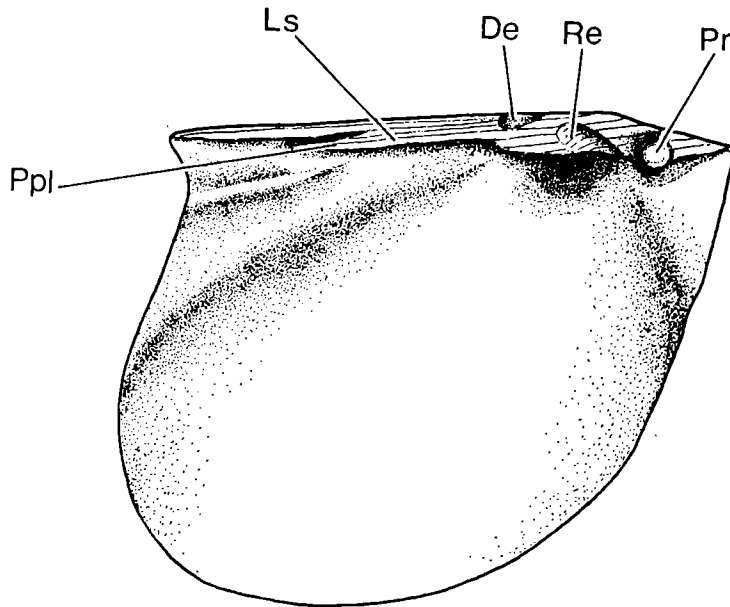

TEXT-FIG. 14. Internal view of the left valve of a specimen of *Pteroperma?* *pygmaea* (Dunker) from the Lower Oxford Clay of Wiltshire (BCM Cb 4777), showing details of the cardinal area, $\times 6$. **De** = slight depression; **Ls** = fine longitudinal striae; **Ppl** = posterior pseudolateral tooth; **Pr** = rounded protuberance; **Re** = resilifer pit.

figs. 1–2) showing the serial ligament pits as belonging to *P. pygmaea*, and on this basis placed his species in *Gervillia*.

Other similar species are *P?* *blakei* Cox (1940, p. 89, pl. 6, fig. 8) from the *athleta* Zone of Cutch (India), in which the anterior auricle is far more elongate, narrow and pointed than in *P. pygmaea*; *Avicula obliqua* Buvignier (1852, p. 27, pl. 16, figs. 38–40) from the Kimmeridgian of France, is similar in form to *P?* *blakei*. *Avicula polyodon* Buvignier (in Sauvage & Buvignier 1842, p. 533, pl. 4, figs. 1–2) from the Oxfordian of France, is much closer to *P. costatula* than *P. pygmaea*.

Range and occurrence. Rare in the Lower Oxford Clay (*enodatum* Subzone to *athleta* Zone) of the Midlands, and in the *coronatum* to *athleta* Zone Oxford Clay of Christian Malford, Wilts. Oxfordian of the Hannover area, Germany, and Middle Callovian of Lithuania (Krenkel 1915).

Family INOCERAMIDAE Giebel, 1852

Genus **PARAINOCERAMUS** Cox, 1964

Type species. Original designation; Cox 1964, p. 47; *Parainoceramus bulkurensis* Voronetz 1936, p. 34, pl. 1, figs. 2, 8, 10; Upper Triassic (Carnian) of Russia.

Diagnosis. Medium to large-sized genus (up to at least 80 mm high), equivalve, moderately inflated, rectangular to trapeziform in outline, with hinge line of variable length; posteriorly subalate, wing not clearly differentiated from body of shell; umbones protruding only slightly above hinge margin, subterminal, prosogyrate; anterior face of shell flattened, more or less impressed; ligament area flat, with variable number of pits; short anterior and elongate posterior teeth present in some species, at least in early growth stages; surface smooth, or with weak concentric plication; shell structure of normal inoceramid type.

Remarks. *Parainoceramus* was introduced by Voronetz (1936) to contain the Triassic to Jurassic equivalve inoceramids with an impressed flattened anterior region, and small, only very slightly salient umbones; it is the only inoceramid genus to have hinge teeth, although they are not always present. However, since Voronetz failed to assign a type species to the genus, the name cannot be considered valid (ICZN Article 13b). Cox (1964) validated the genus when designating a type species, and so must be considered to be the author of *Parainoceramus*.

Parainoceramus subtilis (Lahusen, 1883) Pl. 3, figs. 12, 17, 18, 21, 22; Pl. 4, figs. 1, 2, 12; Text-figs. 15, 16.

1883 *Perna subtilis* sp. nov., Lahusen, p. 86, pl. 2, figs. 10, 11.

?1904 *Mytilus nikitiniensis* sp. nov., Ilovaisky, p. 253, pl. 8, fig. 9.

Lectotype. Here designated; the specimen figured by Lahusen 1883, pl. 2, fig. 10; *coronatum* Zone Oxford Clay of Tschulkowo, Russia. Present location of the specimen unknown.

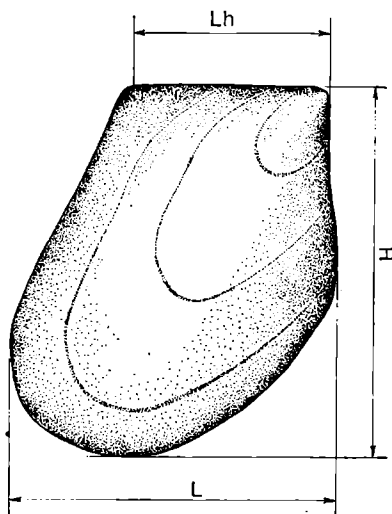

TEXT-FIG. 15. External view of the right valve of a specimen of *Parainoceramus subtilis* (Lahusen), showing the measurements used in the description. **H** = height, measured perpendicular to **Lh**; **L** = length, measured parallel to **Lh**; **Lh** = length of the straight part of the hinge-line.

Measurements. (Text-fig. 15)

	L	H	Lh
N	25	25	25
\bar{x}	20.9 mm	124.3%	53.0%
Max	72.5	143.0	67.2
Min	3.3	110.3	40.9
OR	69.2	32.7	26.3

Description. Large species, equivalve, inequilateral, subrectangular to subovate in outline, of low inflation. Hinge margin straight, about half length of shell, posterodorsal angle rounded, obtuse, sometimes clearly marked, in other specimens not well-angulated; posterior margin

straight to evenly and fully convex, passing into evenly curved ventral margin without angulation; anterior margin evenly convex, occasionally almost straight in the half nearest umbones, forming an obtuse angle with hinge margin, passing smoothly into ventral margin. Umbones small, rounded, only very slightly salient to hinge margin, gently prosogyrate, not enrolled, often subterminal. Anterior area flattened more or less at right angles to commissure; no anterior auricle. Posterior part of shell subalate, slightly compressed, but not clearly separated from body of shell. No differentiated dorsal areas. Ornament of faint concentric growth lines, with variable development of irregular or regular concentric ridges, sometimes restricted to umbonal regions and fading distally, but usually persisting to ventral margin; spacing and elevation of ridges varies within individual specimens. Outer ostracum of prismatic calcite, inner ostracum of nacreous aragonite; inner layer well developed. Commissure planar, lacking gapes.

Ligament area narrow, elongate, flattened, with five widely spaced, convex-sided ligament pits, interspaces between them at least as wide as the pits themselves, except immediately beneath

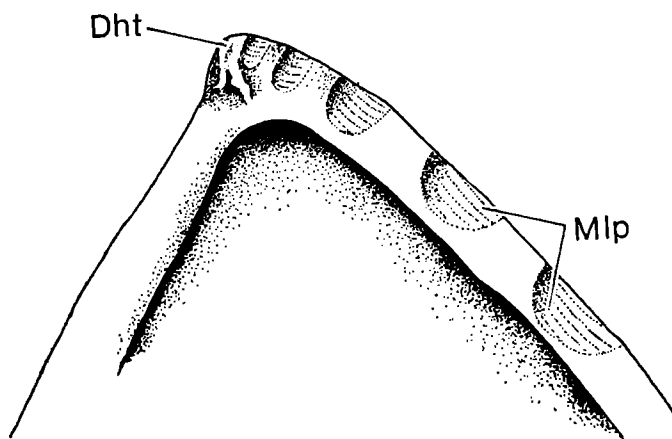

TEXT-FIG. 16. Internal view of the right valve of *Parainoceramus subtilis* (Lahusen), from the Lower Oxford Clay (*obductum* Subzone, *coronatum* Zone) of Stewartby, Beds. (LU 69942), showing the two small divergent hinge teeth (**Dht**), placed immediately beneath the umbones, and the multiple ligament pits (**Mlp**) along the postero-dorsal margin, $\times 6$.

umbones, where pits are more crowded; ventral margins of pits convex, but protrude only very slightly into shell cavity. Immediately beneath umbo of right valve, two small Λ -shaped teeth mark anterior extremity of hinge line, anterior tooth being narrow, bladelike and elevated, posterior tooth wider, lower and more peg-like; between them a small socket divided horizontally into two, the lower part being about twice the size of upper part (Text-fig. 16). Musculature and pallial line not visible.

Remarks. This toothed species of *Parainoceramus* has two small mytiliform teeth beneath the umbo of the right valve; the short anterior teeth which occur frequently in the genus are also well seen (Text-fig. 16). Poor preservation prevents the elongate posterior teeth from being recognized. *P. subtilis* has fewer and more widely spaced ligament pits than other species.

Perna lamellosa Lahusen (1883, p. 91, pl. 2, fig. 9) seems related to *P. subtilis*, but is much higher and narrower, with rather prominent umbones forming an acute angle between the anterodorsal and posterodorsal margins.

Mytilus nikitiniensis Ilovaisky, from the *cordatum* Zone of the Moscow region, closely resembles *P. subtilis*, and is undoubtedly an inoceramid rather than a mytilid. Ilovaisky's figure shows a specimen with a slightly more acute umbonal angle than is seen in *P. subtilis*, but agrees well in all other respects, and is probably synonymous.

Inoceramus inoceramoides (Hudleston), from the British Corallian Beds (Arkell 1933, p. 217, pl. 28, figs. 1–1a), is clearly different, being markedly sub-orbicular with prominent umbones, the antero- and posterodorsal margins being concave in outline. *I. nitiscens* Arkell (1933, p. 218, pl. 28, figs. 2–3), also from the Corallian Beds, differs in having regularly spaced, distant, concentric lines over the whole shell, and in its much more equilateral outline, with prominent submedian umbones, and a concave anterior margin.

Range and occurrence. Common in the Lower Oxford Clay (*enodatum* Subzone to *athleta* Zone) of the English Midlands, occurring at all the major pits, and at Chickerell (Dorset) and Chippenham (Wilts.). Also *coronatum* Zone and *?cordatum* Zone (Ilovaisky 1904) of Russia.

Superfamily PECTINACEA Rafinesque, 1815

Family POSIDONIIDAE Frech, 1909

Genus **BOSITRA** de Gregorio, 1886

Type species. Subsequent designation; Cox 1964, p. 47; *Posidonia ornati* Quenstedt 1856, p. 501, pl. 67, fig. 27 [a subjective synonym of *P. buchii* Roemer, 1836]; from Braunjura ζ of Gammels-haufen, Germany.

Diagnosis. Ovate to subquadrate shells with regular concentric undulations; auricles absent or poorly developed in adults; ligament alivincular.

Remarks. The name *Bositra* is here used for the posidoniids which occur abundantly in the Toarcian to Oxfordian rocks of Europe. The genus was revived by Cox (1964, p. 47), who designated Quenstedt's subsequent (1856) figure of *Posidonia ornati*, rather than Quenstedt's original (1851) figure of the same species, as the type species; Cox (1969d, p. N343) is incorrect in stating that the type species was fixed by original designation. Although de Gregorio (1886, p. 11) did not specifically designate a type species, he stated that "Je suis de l'opinion que beaucoup des espèces de *Posidonomya* connues, parmi lesquelles la *ornati*, doivent être insérées dans ce sous-genre" Furthermore, of the three specimens he figured, only one belongs to the Posidoniidae, his *Posidonomya (Bositra) ornati* Quenstedt (pl. 4, fig. 24); his other figures are of an indeterminate bivalve (pl. 4, fig. 22), and of a specimen probably referable to the Astartidae (pl. 4, fig. 23). Hence Cox's choice of the type species is vindicated.

The status of *Bositra*, and in particular its relationship with *Steinmannia* and *Posidonia*, has been a matter of confusion in the past, and further work is needed to clarify the position. However, there are major differences between them, sufficient to separate each genus. Jefferies & Minton (1965, p. 157, text-fig. 1; and pl. 19, fig. 9) described and figured *Bositra buchii* (Roemer) from the Lower Oxford Clay of Elstow, Bedfordshire, and demonstrated that the alivincular external ligament is of pteriid, rather than arcid, type, with no chevrons for the attachment of external ligaments. This is in marked contrast to the Carboniferous type species of *Posidonia*, *P. becheri* Bronn. *Bositra buchii* cannot therefore belong in *Posidonia*. *Steinmannia* (type-species *Posidonia bronni* Voltz in Zieten) has external similarities to *Bositra*, but it has multiple ligament pits, which place it in the Inoceramidae in spite of the possibility that *Steinmannia* also has a rudimentary alivincular ligament of a type similar to *Bositra*. It appears that many of the Jurassic posidoniids might be referred to *Bositra* rather than *Posidonia* if details of the ligament, which require unusually good preservation to be seen, were known. It is therefore suggested that the genus *Bositra* should be used only where the alivincular ligament can be clearly seen.

The superfamilial relationships of *Bositra* are somewhat obscure, as noted by Jefferies & Minton (1965, p. 157), and it is not clear whether the genus belongs in the Pteriacea or the Pectinacea. However, many Pectinacea have an alivincular ligament (Newell 1969, p. N332), and the external form of *Bositra* is clearly that of a posidoniid. For the present it is placed in the Pectinacea.

The identity of the type species, *Posidonia ornati* Quenstedt, with the earlier described *P. buchii* Roemer (1836), to which Jefferies & Minton referred the Lower Oxford Clay species, has been demonstrated by several authors, including Guillaume (1928), Jefferies & Minton (1965) and Cox (1965, 1969).

Bositra buchii (Roemer, 1836) Pl. 4, figs. 3-6, 8, 10, 14.

- 1836 *Posidonia buchii* sp. nov., Roemer, p. 81, pl. 4, fig. 8.
 1851 *Posidonia ornati* sp. nov., Quenstedt, p. 517, pl. 42, fig. 16.
 1852 *Posidonomya alpina* sp. nov., Gras, p. 11, 48, pl. 1, fig. 1.
 1856 *Posidonia ornati* Quenstedt; Quenstedt, p. 501, 551, pl. 67, fig. 27; pl. 72, fig. 29.
 1856 *Posidonia parkinsoni* sp. nov., Quenstedt, p. 501, pl. 67, fig. 28.
 1883 *Posidonomya ornati* (Quenstedt); Lahusen, p. 86, pl. 2, fig. 8.
 1928 *Posidonomya alpina* Gras; Guillaume, p. 22, pl. 10, figs. 4-13.
 1934 *Posidonomya alpina* Gras; Stoll, p. 19, pl. 2, fig. 14.
 1940 *Posidonia ornati* Quenstedt; Cox, p. 103, pl. 7, figs. 10, 11.
 1964 ?*Bositra buchii* (Roemer); Cox, p. 47.
 1965 *Bositra buchii* (Roemer); Jefferies & Minton, p. 156, pl. 19, figs. 1-4, 6-9.
 1965 *Bositra buchii* (Roemer); Cox, p. 50, pl. 6, fig. 1.

Holotype. The original of Roemer's pl. 4, fig. 8, from the Walker-Erde (Fullers Earth, Bathonian) of Geerzen, Germany, is not present in the Roemer Collection at the Roemer Museum, Hildesheim, West Germany, and must be considered lost.

Measurements.

	L	H	Lh	AL
N	50	50	50	50
\bar{x}	7.7 mm	83.9%	48.8%	35.1%
Max	15.0	97.7	62.1	45.0
Min	2.4	67.7	40.0	22.4
OR	12.6	30.0	22.1	22.6

Description. Medium-sized species, equivalve, inequilateral, suborbicular. Umbones prosogyrate, placed anteriorly, only slightly salient to hinge line; maximum shell height located posterior of umbones, giving slightly oblique appearance. Dorsal margin straight, rest of shell margin a continuous sweeping curve. Ornament of strong concentric folds affecting whole thickness of shell; crests of folds are rounded, and separated by angular furrows; the spacing of the folds varies within a population, but is usually fairly constant within a single specimen. Wide anterior and posterior gapes. Shell very thin, with prismatic calcite outer layer and nacreous inner layer. Cardinal area thicker-shelled than rest of shell, consisting of central triangular resilifer (approximately 45% length of hinge line) bordered anteriorly and posteriorly by external ligament attachment areas, each approximately 27% length of hinge line.

Remarks. Cox (1964, p. 47) was the first author to suggest that *Posidonia buchii* might belong to the genus *Bositra*, although he noted that more detailed work on the hinge structure was necessary before such a placement could be verified. Subsequently the work of Jefferies & Minton (1965) supported this view.

The taxonomy and mode of life of this long-ranging species was also considered by Jefferies & Minton, who concluded that *Posidonia buchii*, *P. ornati* and *Posidonomya alpina* were synonymous. Comparison of the original figures of *P. ornati* and *Posidonomya alpina* leaves no doubt that these two are conspecific, but the relationship between them and *P. buchii* is more controversial. Roemer's figure of *P. buchii* shows a rather smooth-shelled elongate form, with the umbones situated close to the anterior margin, and a rather rounded posterior. Elongate forms of the other species do occur, however, and the most likely conclusion is that Roemer's figure is of a specimen rather more elongate than usual. The fact that Roemer (p. 81) stated that *P. buchii* is thin-shelled, has a straight hinge line, and is shown in his plate in the characteristic valves-open position, leaves little doubt that it represents the same species as that described by Quenstedt and Gras. '*Posidonia radiata* Goldfuss, from the Posidonienschiefer (Upper Lias) of Germany, differs in being rather smaller and more oblique.

The thinness of the shell makes study of the hinge area very difficult, as the shell is so fragile. No specimens showing details of the cardinal area have been found by the author, so evidence of

the nature of this area, and of anterior and posterior gapes has been taken from Jefferies & Minton.

The ecology of this species has been considered at length by Jefferies & Minton (1965). They concluded that it was a very widespread species with pelagic facies relationships, occurring abundantly where there was a rich benthos or none, and independently of lithofacies. Because of these unusual facies relations, some authors suggested that posidoniids were pseudoplanktonic (attached to floating seaweed), whilst others favoured a free-swimming pelagic habit. Jefferies & Minton attempted to show that because *B. buchii* had wide anterior and posterior gapes, had valves with a wide angle of opening in life, and a thin shell, that the mantle was probably fringed by prominent tentacles, and that the animal was nektoplanktonic, with a free swimming pelagic habit.

There are problems concerning this interpretation, such as the apparent lack of large attachment scars presumably required for the well-developed adductor muscles to perform valve-clapping. On the other hand, adults are non-auriculate and equivalve, and the existence of a functional byssus seems unlikely. The commonest mode of occurrence of *B. buchii*, especially in the Lower Oxford Clay, is as articulated shells, with the valves spread wide open, and Jefferies & Minton point out that this would be most likely to occur if the living shell was able to gape very widely; wide-gaping potential would be expected to be greatest in a valve-clapping swimmer.

A benthonic mode of life is precluded for the reasons stated by Jefferies & Minton, and because of the small likelihood of such a small suspension-feeder being able to live on a seafloor of very soft unstable mud. On balance, however although there are no structural features which suggest byssal attachment, it seems necessary to invoke a byssally attached mode of life (probably by only a very few byssal threads since there is no byssal notch and a functional ctenolium was not needed) to floating or rooted organic matter. No nektoplanktonic bivalves are known at the present time, and it seems an unlikely mode of life for a bivalve, especially one without well-developed muscle scars. Attachment to organic material would also explain the clustering of individuals which occurs so commonly in the Lower Oxford Clay.

Range and occurrence. Toarcian to Oxfordian, almost cosmopolitan; recorded from Europe, Russia, East Africa, Madagascar, South America and India. In Britain, it is found in the Fullers Earth (Bathonian) and Oxford Clay, and is apparently commonest in lithologies with a sparse benthonic fauna. It is abundant in the *jason* and *coronatum* zones, and ranges up into the *mariae* Zone.

Family OXYTOMIDAE Ichikawa, 1958

Genus **OXYTOMA** Meek, 1864

Type species. Original designation; Meek 1864, p. 39; *Avicula muensteri* Bronn 1830, p. 164; figured Goldfuss 1836, p. 131, pl. 118, figs. 2a-2h; Braunjura δ of Thurnau (Oberfranken), Germany.

Diagnosis. Suborbicular and acline to ovate, or broadly lunate and prosocline, inequivalve; left valve convex in section, variably inflated, right valve smaller, flat or feebly convex; bialate, posterior auricles of both valves produced and sharply pointed, with a variably developed sinus below them; left anterior auricle small, blunt, right anterior auricle short and prominent; byssal notch deep, acute, usually with ctenolium, angular projection of shell margin extending on inner side of notch; ligamental area subparallel to commissure in left valve, subperpendicular to commissure in right valve; edentulous.

Subgenus **OXYTOMA** s.s.

Diagnosis. Medium sized shell; left valve with ribs and riblets developed to three orders of strength, although only primaries and secondaries are present in some specimens; primaries well separated, interspaces much wider than ribs; right valve smooth, or with weak radial threads; adductor scar placed posteriorly.

Remarks. Bronn (1829, p. 76; 1830, p. 164) used the name *Avicula muensteri* but both records

are nomina nuda; the species was not figured until 1836, by Goldfuss (p. 131, pl. 118, figs. 2a–2h). Since then, it has often been accepted that it is synonymous with *A. inequivalvis* J. Sowerby (1819), e.g. by Cox (1940, p. 92). However, Ichikawa (1958, pl. 24, figs. 1–7) figured the types and some other material of *A. muensteri* Goldfuss, and showed them to be equivalve, and thus not conspecific with the markedly inequivalve *A. inequivalvis*.

Meleagrinnella is closely related to *Oxytoma*, but may readily be distinguished by the greater inflation of its left valve, the finer ornament pattern, the smaller posterior auricle (and the lack of a left anterior auricle), and the presence of a tooth-like protuberance on the ventral margin of the cardinal plate.

Oxytoma (Oxytoma) inequivalve (J. Sowerby, 1819) Pl. 4, figs. 7, 9, 11, 13, 15–19, 21–23; Text fig. 17.

- 1819 *Avicula inequivalvis* sp. nov., J. Sowerby, p. 78, pl. 244, figs. 2, 3.
 1851 *Monotis inequivalvis* (J. Sowerby); Quenstedt, p. 518, pl. 42, figs. 18, 19.
 1855 *Avicula muensteri* Bronn; Morris & Lycett, p. 129, pl. 14, fig. 6 (*non* Bronn).
 ?1863 *Avicula subcostata* Roemer; Lycett, p. 36, pl. 40, fig. 24 (*non* Roemer).
 1882 *Avicula (Oxytoma) muensteri* Bronn; Roeder, p. 58, pl. 1, figs. 10a, 10b (*non* Bronn).
 1883 *Avicula inaequivalvis* J. Sowerby; Lahusen, p. 91, pl. 2, fig. 5.
 1904 *Avicula muensteri* Bronn; Ilovaisky, p. 252, pl. 8, figs. 18, 19 (*non* Bronn).
 1907 *Avicula (Oxytoma) inaequivalvis* J. Sowerby; Cossmann & Thierry, p. 49, pl. 3, figs. 5–7.
 1909 *Oxytoma inaequivalvis* (J. Sowerby) var., *borealis* nov., Borissiak, p. 19, pl. 1, figs. 3–8.
 1909 *Oxytoma inaequivalvis* (J. Sowerby); Borissiak, p. 19, pl. 1, fig. 10.
 ?1909 *Oxytoma cf. interlaevigata* (Quenstedt); Borissiak, p. 21, pl. 1, fig. 9.
 1915 *Oxytoma inaequivalvis* (J. Sowerby) var. *borealis* Borissiak; Krenkel, p. 289, pl. 25, figs. 25–31.
 1915 *Pteria phillipsi* nom. nov., Rollier, p. 400 (*pro Avicula inequivalvis* J. Sowerby, 1819, pl. 244, fig. 2).
 1919 *Avicula (Oxytoma) inaequivalvis* (J. Sowerby); Couffon, p. 62, pl. 4, figs. 7–7c.
 1924 *Oxytoma inaequivalvis* (J. Sowerby); Gillet, p. 450.
 1933 *Oxytoma inaequivalvis* (J. Sowerby); Arkell, p. 194, pl. 24, fig. 9.
 1935 *Oxytoma inequivalve* (J. Sowerby); Cox, p. 165, pl. 15, fig. 11, 12.
 1940 *Oxytoma inequivalve* (J. Sowerby); Cox, p. 98, pl. 6, figs. 9–12.
 1948 *Oxytoma inequivalve* (J. Sowerby); Cox & Arkell, p. 7.
 1958 *Oxytoma (Oxytoma)* sp.; Ichikawa, p. 161, pl. 24, fig. 8.
 1965 *Oxytoma inequivalvis* (J. Sowerby); Cox, p. 47, pl. 5, fig. 7.

Lectotype. Designated by Arkell 1933, p. 194; BM 43259a; J. Sowerby 1819, pl. 244, fig. 2 (left); Pl. 4, fig. 16; Middle Lias of Dursley, Gloucestershire.

Measurements.

Left valve

	L	H	I	AL	OL	Lh	θ
N	30	30	13	23	19	14	5
\bar{x}	23.1 mm	89.0%	25.0%	27.1%	101.0%	71.6%	31.2°
Max	39.8	108.9	33.8	33.7	126.6	91.2	40
Min	11.4	72.6	18.8	20.0	86.7	50.4	27
OR	28.4	36.3	15.0	13.7	39.9	40.8	13

Right valve

	L	H	I	AL	OL	Lh	θ
N	19	19	17	16	6	12	
\bar{x}	14.0 mm	90.3%	15.2%	32.6%	94.7%	79.2%	
Max	19.6	99.4	17.4	38.2	111.6	100.0	
Min	7.4	63.5	10.7	25.7	67.6	46.8	
OR	12.2	35.9	6.7	12.5	44.0	53.2	

Description. Large species, suborbicular to obliquely subovate in outline, prosocline; inequilateral, umbones slightly prosogyrate, rounded, salient *c.* 2 mm above hinge margin, placed within anterior third of shell; strongly bialate, inequivalve, left valve about twice size of right valve.

Left valve obliquely subovate to suborbicular in outline, inflated, with umbones placed near anterior margin; oblique length variable, about equal to overall shell length. Hinge line long, straight, most of its length placed posterior of the umbones, forming dorsal margin of strongly developed posterior auricle; posterior auricle elongate, flattened, pointed, with deep subauricular sinus; posterior auricle well differentiated from body of shell by deep auricular sulcus; posterior margin of body of shell gently concave to straight, passing via smoothly rounded posteroventral angle into evenly and gently convex ventral and anterior margins, which form a long sweeping curve; at its dorsal extremity, anterior margin straightens, and sometimes reflects back a little to meet small, vestigial anterior auricle; anterior auricle small, not clearly differentiated from body of shell, bluntly terminated at anterior end. Ornament very variable, consisting of arrangements of primary, secondary and tertiary radial riblets, primaries usually strong and wire-like, extending to umbo, secondaries becoming intercalated between primaries *c.* 15–20 mm from umbo, and tertiaries appearing between these; in some forms only primaries and very faint tertiaries occur,

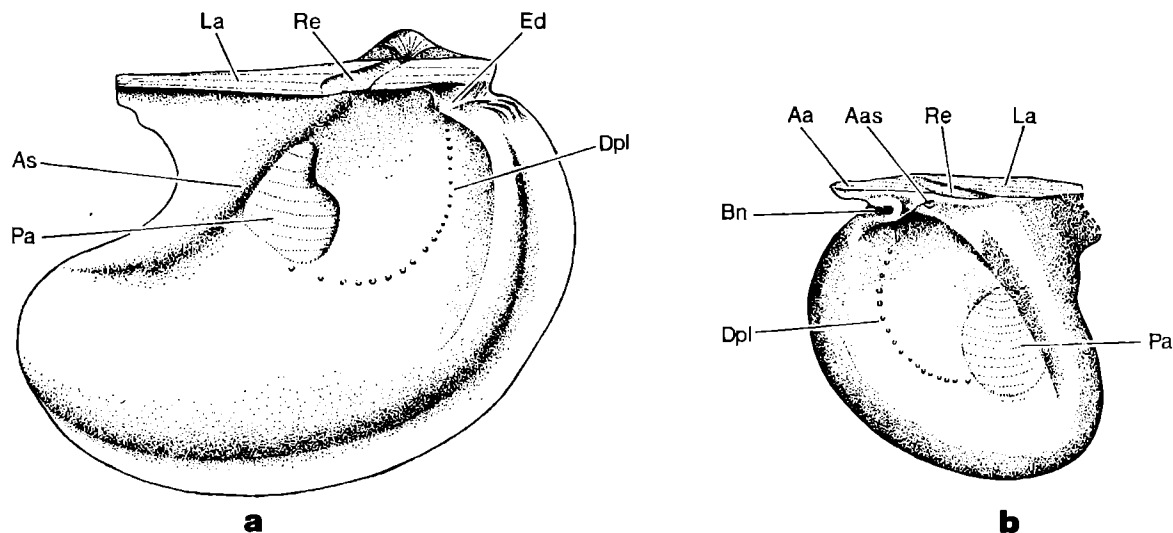

TEXT-FIG. 17. a. Internal view of a left valve of *Oxytoma* (*Oxytoma*) *inequivalve* (J. Sowerby), from the Middle Oxford Clay of Woodham, Bucks. (LU 52673), showing details of the musculature and the cardinal area. Note the elongate depression (**Ed**) anteroventral of the umbo for articulation with the pointed anterior auricle of the right valve, $\times 3.5$. b. Internal view of a right valve from the same horizon and locality (LU 52675). Note the small anterior adductor scar (**Aas**) beneath the resilifer, $\times 2.5$. **Aa** = anterior auricle; **As** = auricular sulcus; **Bn** = byssal notch; **Dpl** = disjunct pallial line; **La** = ligament area; **Pa** = posterior adductor scar; **Re** = resilifer.

whilst others show primaries and secondaries, and sometimes tertiaries. Primaries carry onto anterior, but not onto posterior auricle, although faint radial threads are sometimes visible on the latter. On body of shell, riblets are crossed by scalloped concentric growth lines, not always well-developed.

Right valve smaller, suborbicular to subovate, thin, more or less flat, with umbones placed about a third of shell length behind anterior margin; umbones small, slightly prosogyrate, pointed, not salient to hinge line. Hinge line long, but fragile and easily broken; in well-preserved specimens from the Lower Oxford Clay, maximum shell length is along the hinge line, but in shells of average preservation, where the hinge line has been broken, maximum length is usually across the body of the shell. Posterior auricle large, flattened, very elongate, shaply pointed, with less well-developed subauricular sinus than in left valve; anterior auricle small, pointed, with deep byssal notch beneath, whole auricle well-differentiated from body of shell by strong auricular sulcus; no auricular sulcus separates posterior auricle from shell body. Posterior margin of shell straight to

evenly convex, passing smoothly into semicircular sweeping curve of ventral and anterior margins. Ornament of faint radial striae, becoming slightly stronger ventrally, but without secondaries and tertiaries; these striae do not continue onto the auricles; concentric growth lines hardly visible, but there are occasional well-marked growth halts.

Ligamental area of left valve (Text-fig. 17) subparallel to commissure, resilifer forming narrow triangular area running posteroventrally from immediately beneath umbo, reaching almost to auricular sulcus. There is a shallow elongate depression parallel to and immediately beneath the anterior end of the hinge margin, which receives the anterior part of the hinge of opposite valve. Interior of posterior auricle flattened, dropping sharply into shell cavity along line of auricular sulcus. Posterior adductor muscle scar large, elliptical, with concave side placed dorsally, its posterior margin reaching to auricular sulcus, its anterior margin reaching halfway to mid-axis; scar slightly closer to cardinal plate than ventral margin. Curving anterodorsally from anteroventral margin of posterior adductor scar is a disjunct pallial line (Text-fig. 17a) consisting of *c.* 25 tiny pallial muscle scars, running beneath cardinal plate where anterior articulation for right valve is situated; anterior adductor scar not seen.

Ligamental area of right valve (Text-fig. 17b) flattened subperpendicular to commissure, resilifer a narrow triangular depression running posteroventrally from immediately beneath umbo to the area of posterior auricle. Deeply incised byssal notch lies beneath anterior auricle, running obliquely into shell interior; ctenolium appears to be absent. Posterior adductor muscle scar suborbicular, placed slightly nearer ventral margin than cardinal plate, its posterior margin meeting edge of posterior auricle, its anterior margin reaching to below approximate midpoint of resilifer. Running anterodorsally from ventral margin of adductor scar is a disjunct pallial line consisting of *c.* 18–20 tiny pallial muscle scars; anterior adductor muscle scar very small, suborbicular, on the lower margin of the cardinal plate, *c.* 1.5 mm posterior of inner end of byssal notch.

Remarks. The status and variation of this species was discussed at length by Arkell (1933, p. 192) and Cox (1940, p. 98), who came to different conclusions. Arkell believed that the Middle Lias form (*Avicula inequivalvis* var. α J. Sowerby) differed from the Kellaways Rock form (*A. inequivalvis* var. β J. Sowerby) in the nature of the ribbing, and were therefore two distinct species. Cox, however, felt that variation of Jurassic *Oxytoma* of the *inequivalve* group was so great that there was a single, variable, long-ranging species.

The lectotype, and several other Sowerby collection specimens (e.g. BM 66351), show a wide variation in the ribbing style of the Middle Lias forms, with many specimens having well-developed secondary ribs in addition to the strong primaries and tertiaries. This agrees with the range of variation seen in specimens from the Lias, Cornbrash, Kellaways Rock, Oxford Clay and Corallian Beds, and the author follows Cox in accepting the morphological unity of the *inequivalve* group throughout the Jurassic.

Variation in the Oxford Clay specimens is very marked, but the species can be clearly distinguished from the Oxfordian *Oxytoma expansum* (Phillips) on the basis of the relative sizes of the valves. The left valve of *O. inequivalve* is about twice the size of the associated right valve; in *O. expansum*, the valves are of approximately equal size. Articulated bivalved specimens of *O. inequivalve* from the Kellaways Rock of Kellaways clearly demonstrate that the inequivalve nature of the shells is an original feature. In *O. expansum* the ribbing is much coarser, with a more irregular division into primaries, secondaries and tertiaries, and the inflation of the shell (\bar{x} 18%) is a little lower. In fact, it is often difficult to separate the two species in the absence of associated left and right valves, because of the amount of variety in ornament patterns, and the relative similarity of inflation values. Because no articulated specimens of *O. expansum* have been found below the Corallian Beds, the lower end of its range is not known with certainty, although Arkell (1933, p. 195) and Cox & Arkell (1948, p. 7) have recorded the species from the Cornbrash, Kellaways Rock and Hackness Rock. These records cannot be verified until articulated or associated valves are found at these horizons.

An unusual feature of *O. inequivalve* is its apparent lack of a ctenolium, even on the well-preserved right valves from the *lamberti* Zone Oxford Clay of Woodham, Buckinghamshire. It is uncertain whether this is an unusual feature of specimens from this horizon, or whether it is true of the species as a whole, other specimens not being well enough preserved to show the feature. It seems strange that a ctenolium should be absent in a species with such a well-developed byssal notch, unless there were so few byssal threads that a ctenolium had become unnecessary.

The approximately 35 specimens from the Kellaways Clay of Putton Lane brickpit, Chickerell, Dorset, cited by Arkell (1933, p. 194; e.g. SM J47646; OUM J8612, J13127) are mostly left valves showing very strong, wire-like primary ribs, separated by wide interspaces which bear very faint tertiaries in some specimens. By virtue of the ribbing style, the wire-like nature of the ribs, and the slightly greater inflation, Arkell separated these specimens from both *O. inequivalve* and *O. expansum*. However, the specimens agree well in ribbing style with many specimens from the Lower Oxford Clay, which themselves grade into forms indistinguishable from specimens of *O. inequivalve* from the type locality. There are, however, four specimens with very strongly divergent primary ribs of a style not seen elsewhere. Regarded as a population, these specimens represent one of the more extreme local races which sporadically occurred.

The synonymy of this species is relatively simple as regards the British specimens, but complex with regard to foreign ones, in view of the many races occurring at different levels in different areas. For this reason, only the British references, and the most important Continental ones are recorded here. The few British specimens which have been referred to *O. muensteri* Bronn (Morris & Lycett, 1855, p. 129, pl. 14, fig. 6) are inequivalve examples, and cannot be considered to belong to Bronn's species. Examination of Morris & Lycett's figured specimen (SM J4109) from the Inferior Oolite of Yorkshire, reveals that it clearly belongs to *O. inequivalve*, as do the specimens figured by Roeder (1882, p. 58, pl. 1, figs. 10a-10b) from the Zweischalerbank (Oxfordian) of Oberlurg, Germany, which extend the range of the species up into the Oxfordian.

Arkell (1939, p. 137) thought that the species of *Oxytoma* which occurs in the Lamberti Limestone (*lamberti* Zone) and basal *mariae* Zone at Woodham was distinct from both *O. inequivalve* and *O. expansum*, and referred it to *O. interlaevigatum* (Quenstedt) on the basis of the figure of that species given by Borissiak (1909, p. 21, pl. 1, fig. 9). Examination of a population from Woodham reveals that this material properly belongs to *O. inequivalve*.

Range and occurrence. Lias to Kimmeridgian of Europe, widespread. In Britain, it occurs in the Lias, Inferior Oolite, Great Oolite, Fullers Earth, Kellaways Rock, Oxford Clay and Kimmeridge Clay (Cox & Arkell 1948, p. 7). It is abundant in the Kellaways Rock (*calloviense* Zone) of southern England, and throughout the Lower Oxford Clay, occurring most commonly in the bituminous shale facies. It is more restricted in the Middle Oxford Clay, but is abundant in the upper part of the *lamberti* Zone at Woodham (Lamberti Limestone), and is rare in the Upper Oxford Clay. It occurs throughout the Kellaways Rock and Hackness Rock of Yorkshire.

Genus **MELEAGRINELLA** Whitfield, 1885

(Synonyms: *Clathrolima* Cossman, 1908; *Echinotis* Marwick, 1935)

Type species. Subsequent designation; Cox 1941, p. 134; *Avicula curta* Hall 1852, p. 412, pl. 2, fig. 1; Upper Jurassic of the United States.

Diagnosis. Small to medium-sized shells, suborbicular in outline; left valve strongly convex, right valve much smaller, flat or feebly convex; both usually with small pointed posterior auricles, right valve with small anterior auricle, and a deep, narrow, subauricular notch; left valve lacking anterior auricle; ligament area almost in plane of valve margins in left valve, perpendicular to it in the right valve; resilifer broadly trigonal, with tooth-like protuberance anterior to it in the left valve; left valve with narrow squamose radial riblets, right valve smooth or with weak radial riblets.

Remarks. As Cox (1941, p. 133) has shown, *Meleagrinnella* is the earliest valid name for the group of small Pectinacea which includes *Avicula echinata* Smith. This name was overlooked by Cossman

(1908, p. 296) and Marwick (1935, p. 301), who introduced the names *Clathrolima* and *Echinotis* for the same group. *Avicula curta* Hall, the type-species, from the Sundance Formation (Oxfordian) of South Dakota, U.S.A. (e.g. BM L58878), shows many close similarities to the British Callovian species *Meleagrinnella braamburiensis* (Phillips).

Meleagrinnella braamburiensis (Phillips, 1829). Pl. 4, figs. 20, 24, 26–28, 31, 32; Pl. 5, figs. 1, 2, 6, 11; Text-figs. 18, 19.

- 1827 *Avicula braamburiensis* sp. nov., J. de C. Sowerby in Murchison, p. 323 (nom. nud.).
 1829 *Avicula braamburiensis* sp. nov., Phillips, pl. 6, fig. 6.
 non 1855 *Avicula braamburiensis* Phillips; Morris & Lycett, p. 129, pl. 15, figs. 6, 7 [= *Meleagrinnella lycetti* (Rollier)].
 1883 *Pseudomonotis subechinata* sp. nov., Lahusen, p. 85, pl. 2, figs. 6, 7.
 non 1894 *Avicula braamburiensis* Phillips; Woodward, p. 44, fig. 13. = [*Meleagrinnella lycetti* (Rollier)].
 1909 *Pseudomonotis subechinata* Lahusen; Borissiak, p. 24, pl. 2, figs. 14–21.
 1915 *Pseudomonotis subechinata* Lahusen; Krenkel, p. 290, pl. 26, figs. 13–15.
 1932 *Pseudomonotis braamburiensis* (Phillips); Douglas & Arkell, p. 163, pl. 12, figs. 5, 6.
 1934 *Pseudomonotis ornati* (Quenstedt); Stoll, p. 17, pl. 2, fig. 5 (non Quenstedt).
 1934 *Pseudomonotis substriata* (Munster); Stoll, p. 18, pl. 2, fig. 6.
 1972 *Meleagrinnella braamburiensis* (Phillips); Walker, p. 122, pl. 7, fig. 5.

Neotype. Designated by Arkell in Douglas & Arkell, 1932, p. 168, pl. 12, fig. 6; YM 902; Pl. 4, fig. 20; Hackness Rock of Scarborough, Yorkshire.

Measurements.

Left valve

	L	H	I	AL	Lh
N	59	58	14	8	4
\bar{x}	19.6 mm	103.4%	33.0%	45.5%	46.9%
Max	33.7	122.2	44.6	46.5	51.8
Min	8.0	91.7	20.8	42.2	38.2
OR	25.7	30.5	23.8	4.3	13.6

Right valve

	L	H	I	AL	Lh
N	21	21	5	5	1
\bar{x}	15.2 mm	93.5%	23.2%	49.8%	48.6%
Max	26.5	100.7	29.7	51.9	48.6
Min	7.0	83.4	18.4	44.3	48.6
OR	19.5	17.3	11.3	7.6	0

Description. Large species, suborbicular to subquadrangular in outline, inequilateral, inequivalve, left valve about twice the size of right valve; left valve subquadrangular in outline, up to 33.7 mm long, usually slightly higher than long, with a short, prominent, pointed posterior auricle, with straight dorsal margin and oblique posterior margin, giving a slight concavity in posterior shell margin; no left anterior auricle; anterior part of dorsal margin short, straight, passing into evenly convex anterior margin via a rounded angle; anterior margin curved continuously with ventral margin; posterior margin oblique, nearly straight to gently convex, never as rounded as anterior margin; posteroventral angle rounded, not prominent; umbones slightly anterior, inflated, rounded, orthogyrate, salient *c.* 2 mm above hinge margin; inflation variable, usually low; left valve with 35–55 fine primary radial riblets, separated by interspaces about three times the width of ribs, and extending onto posterior auricle, often with secondary riblets intercalated ventrally; riblets variably or not squamose; squamae occur at junctions of radial riblets and concentric growth lines. Hinge line straight, about half length of shell, two-thirds of it being anterior to umbones; resilifer subrectangular in outline, deep, located below and posterior to umbones, more or less in plane of commissure, extending almost halfway to posterior end of hinge

margin. Immediately anterior of resilifer is a prominent, rounded, tooth-like protuberance which projects ventrally into shell cavity (Text-fig. 18a). On anterodorsal extremities of shell, directly adjacent to anterior of hinge line, are several obliquely directed corrugations, which may represent byssal grooves. Posterior adductor muscle scar placed halfway between cardinal plate and ventral margin, elliptical, its concave side ventrally, its anterior extremity just posterior of mid-axis of shell; posterior extremity almost reaching posterior margin; anterior adductor not visible. Pallial line not seen.

Right valve suborbicular in outline, inequilateral, bialate; posterior auricle broad, flattened, pointed, not clearly differentiated from body of shell; anterior auricle very small, pointed, marked off from body of shell by deep auricular sulcus, with well-developed byssal notch beneath it. Hinge line straight, about half length of shell, almost all posterior to umbones; anterior, ventral

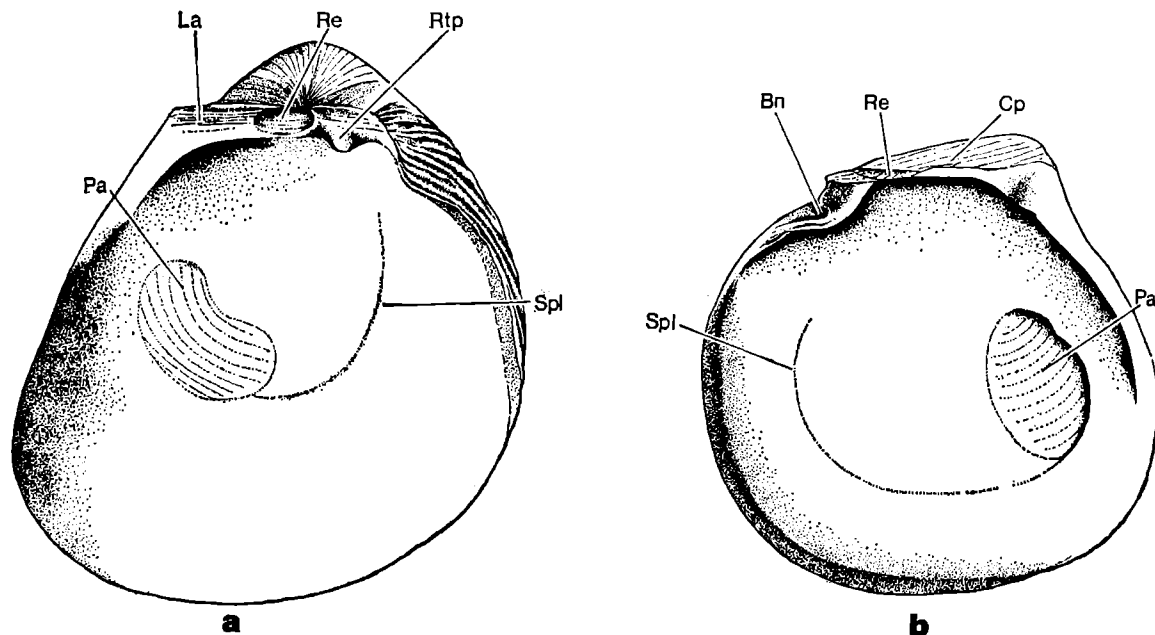

TEXT-FIG. 18. a. Internal view of a left valve of *Meleagrinnella braamburiensis* (Phillips) from the Oxford Clay of Wiltshire (GSM Y2088), showing details of the cardinal area and musculature. Note the prominent rounded tooth-like protuberance (**Rtp**) anterior of the resilifer, $\times 4$. b. Internal view of a right valve from the same horizon and locality (GSM Y2090). Note the narrow resilifer placed on the broad cardinal platform (**Cp**) with a deep byssal notch (**Bn**) beneath the broken right anterior auricle, $\times 4$. **La** = ligament area; **Pa** = posterior adductor scar; **Re** = resilifer; **Spl** = simple pallial line.

and posterior margins continuously curved, dorsal part of posterior margin sometimes gently reflexed, sweeping into obliquely truncate posterior margin of posterior auricle. Umbones submedian, small, pointed, orthogyrate, hardly salient to hinge margin. Inflation low, but valves always convex in section; 35–50 fainter primary radial riblets, with some intercalated secondaries, becoming more prominent as shell increases in size; in larger examples ($L > 20$ mm), weak squamae sometimes seen, but more often, only a faint reticulate pattern is visible; in most smaller specimens, concentric growth-lines dominate radial elements; when present, radial ribs continue onto posterior auricle. Resilifer small, triangular, located immediately posterior of umbo, and placed almost perpendicular to plane of commissure, on a flat cardinal platform (Text-fig. 18b). Byssal notch deep and narrow, placed directly beneath anterior auricle, ctenolium apparently absent. Posterior adductor muscle scar large, orbicular, its centre about two-thirds of shell height below hinge margin, its anterior edge just posterior to mid-axis of shell, and reaching almost to posterior margin of valve; anterior scar not visible, pallial line simple.

Remarks. The name *Avicula braamburiensis* was first used by J. de. C. Sowerby in 1827, for specimens from Brora, Sutherland, but as this was a nomen nudum, whilst Phillips' (1829) description was accompanied by a figure, Phillips' specimen must be taken as the type. It is now known that both Sowerby's and Phillips' records refer to specimens from approximately the same horizon (*athleta* to *lamberti* zones) and that they belong to the same species.

Arkell (*in* Douglas & Arkell 1932, p. 163) described and figured topotypes of this species, placing them in *Pseudomonotis*. The material he used in his study consisted solely of steinkerns, and details of the ornament pattern could not be made out. He stated (p. 164) that *P. braamburiensis* has "the left valve ornamented with 25–30 fine, thread-like ribs, which are faintly knotted at long intervals where crossed by some of the more prominent of the indistinct growth-lines". However, not all the ribs on the shell of this species are strongly enough impressed to show on a steinkern, and Arkell's diagnosis of the number of ribs is too low.

Variation within a population of *M. braamburiensis* is great, and even greater between populations from different horizons. This variation is reflected mainly in the degree of inflation, and the style of ornamentation (Text-fig. 19). At most horizons within the Callovian where *M. braamburiensis* is common, the dominant form is one of small to medium size, with low inflation and an

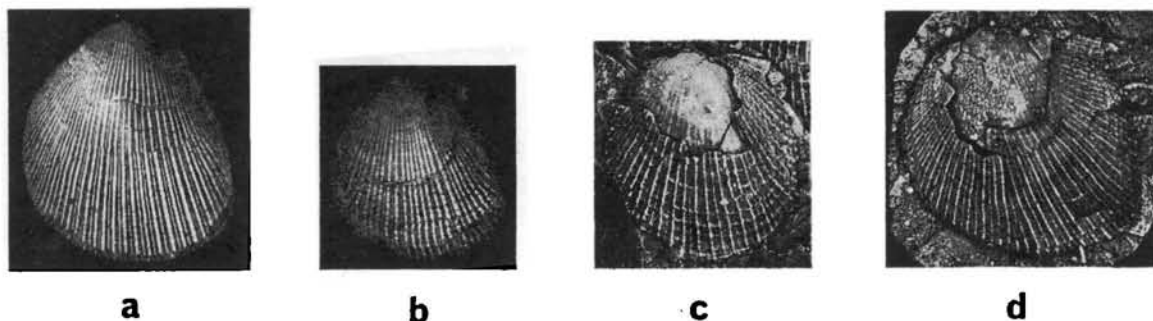

TEXT-FIG. 19. Variation in ornament in *Meleagrinnella braamburiensis* (Phillips). **a.** Simple radial primaries with intercalated secondaries. **b.** Simple radial primaries with intercalated secondaries and some faint concentric elements, especially well-developed at the anterior and posterior. **c.** Radial primaries and secondaries, together with strong concentric growth lines, strongly spinose on the posterior flanks. **d.** Radial primaries and secondaries, with concentric growth lines strengthened, and becoming spinose on the posterior flanks.

ornament pattern of strong radial riblets, with traces of squamosity. At a few horizons, such as locally within the *grossourei* Subzone at Stewartby, the dominant form is of medium size, low inflation, and strongly squamose, agreeing perfectly with the specimens figured by Borissiak (1909, p. 24, pl. 2, figs. 14–21) as *Pseudomonotis subechinata* Lahusen. In association with this strongly squamose form are more "normal" forms with much fainter squamae, suggesting that variation is continuous. In all forms there is a strong tendency for the young specimens to be very much more inflated than the older ones, and so at any one horizon it is possible to find three apparently different morphotypes, which grade into one another when a large enough population is studied; for this reason it seems unwise to introduce further confusion by splitting the species.

Most of the Lower Oxford Clay specimens are too fragile to allow examination of the hinge area, but four specimens from the Oxford Clay (horizon unknown) of Cock Hill, Trowbridge, Wilts. (GSM Y2087–Y2090), are thicker-shelled than the specimens from the Midlands, and show the cardinal area clearly. The most obvious feature is the tooth-like protuberance anterior to the umbo of the left valve, which apparently fits into a corresponding socket in the right valve, acting as a safeguard against excessive lateral movement of the valves. There is usually a slight depression anterior to the protuberance, which accommodates the small right anterior auricle. The arrangement of the ligament is such that the resilifers of the left and right valves are set at right angles to one another, their ventral margins more or less touching.

There are marked differences between *M. braamburiensis* and its close stratigraphical relatives *M. echinata* (Smith) from the Cornbrash, and *M. ovalis* (Phillips) from the Corallian Beds. *M. echinata* may be distinguished by its smaller size (L up to 20 mm), its greater inflation, its fewer number (up to 40) of wire-like, more widely spaced ribs on the left valve (the ribs being densely squamose, especially on the anterior and posterior extremities), the more elongate and pointed posterior auricle of both valves, and the ornament of the right valve, which is only very slightly smaller than the left valve, and has an ornament pattern of up to 16 low, faint, very divergent radial riblets with no squamae. Cox (1940, p. 95) believed on the basis of specimens of *Pseudomonotis echinata* from the Bathonian of Cutch (India), that the form present in the English Lower Cornbrash, and identified as *P. echinata*, was merely a fairly well-defined race of a long-ranging species, which showed much greater variability in other parts of the world. However, the British Bathonian and Callovian species of *Meleagrinea* are clearly separable, and the author believes that it is more useful to retain them as two species, rather than unite them.

M. ovalis is more difficult to separate from *M. braamburiensis*, but, nevertheless, several features serve to distinguish them: in *M. ovalis*, the posterior auricle is much smaller and less well-developed, the hinge line of the left valve is rather longer (Lh \bar{x} 61.9%), the ribbing style consists of densely-packed fine radial riblets on both valves (the difference between this style and the ribbing on the right valve of *M. braamburiensis* being particularly well marked) and the growth squamae are not clearly developed in *M. ovalis*, although the concentric elements of ornamentation are much stronger than in *M. braamburiensis*.

The specimens collected from boreholes in the Kellaways Rock and Lower Oxford Clay of the Kent coalfield, mentioned by Lamplugh & Kitchin (1911) and Lamplugh, Kitchin & Pringle (1923) as *Pseudomonotis* sp. nov. are preserved in the Geological Survey Museum. Lamplugh & Kitchin (1911) stated that this species was characterized by its "relatively greater height than length, its strongly inflated left valve and its low obliquity" and that it had "fine radial ribs, showing no asperities, with irregularly intercalated secondary ribs". The specimens are all referable to *M. braamburiensis*, showing a range of variation compatible with that seen elsewhere. The inflation is not any greater than in topotypes of *M. braamburiensis*; there is also a greater range of obliquity than Lamplugh & Kitchin admitted, and most of the specimens are steinkerns with remnants of imperfectly preserved shell material.

Range and occurrence. Common in the Kellaways Beds (Lower Callovian) of the Kent coalfield and Wiltshire. Abundant throughout the Lower Oxford Clay of England (*calloviense* to *athleta* zones), and in the Hackness Rock of Yorkshire (*athleta* to *lamberti* zones); Kellaways Rock of Yorkshire, the Shales of the Cornbrash, Yorkshire (Wright 1968), and the Clynelish Quarry Sandstone of Brora, Sutherland. Callovian of Germany and Russia.

Family ENTOLIIDAE Korobkov, 1960

Genus **ENTOLIUM** Meek, 1865

Type species. Original designation; Meek 1865, p. 478; *Pecten demissus* Phillips, "as illustrated by Quenstedt, 1858, p. 353, pl. 48, figs. 6, 7", i.e. *Entolium demissum* Meek, 1865 under Art. 70b of the Code [non Phillips; = *Pecten disciforme* Schübler in Zieten 1833, p. 69, pl. 53, fig. 2]; from the Aalenian of Germany.

Diagnosis. Byssal notch usually absent in all stages of development; margins closed laterally; incised ligamental area usually present and extending parallel to the hinge line of either side of the resilifer; cardinal crura variably developed, auricular crura present; inner layer of foliated calcite, outer layer radially fibrous.

Subgenus **ENTOLIUM** s.s.

(Synonyms: *Protamusium* Verrill, 1897)

Diagnosis. Shell exterior smooth; auricles of left valve projecting above hinge line, usually as angular wings.

Remarks. Hertlein (1969, p. N346) believed that Quenstedt's figure (1858, pl. 48, figs. 6, 7) of

E. demissum (Phillips 1829, pl. 6, fig. 5) from the Aalenian was referable to *E. disciforme* (Schübler in Zieten, 1833, p. 69, pl. 53, fig. 2). Other authors, including Cox (1952, p. 34) united these two species in a long-ranging one, to which Phillips' name was applied. Meek (1865, p. 478) based the nominal type-species on the specimen figured by Quenstedt, and its name is therefore *Entolium demissum* Meek, 1865 (under Art. 70b of ICZN).

There is some doubt as to the identity of the valves in *Entolium*, as the adductor muscle scars have not been seen. Traditionally the valve with the elevated dorsal wings has been thought of as the right valve. Newell (1969, p. N347) suspected, by analogy with *Pernopecten* Winchell from the Upper Palaeozoic, that it is the left valve which has elevated dorsal auricles, and the evidence furnished by *Entolium* sp. A described here, supports that view.

Speden (1967, p. 15) has discussed the status of *Entolium*, and its relationships with *Syncyclonema* Meek, a genus often placed in the synonymy of *Entolium*, which it predates. Much of the confusion was caused by the brief original diagnosis and inadequate figures of *Syncyclonema* (Meek 1864, p. 31; figured in Hall & Meek 1856, p. 31, pl. 1, figs. 4a–4c as *Pecten rigida* sp. nov. [non J. Sowerby, 1818]). However, Speden has redescribed the type-species, designated and figured a lectotype, and shown *Syncyclonema* to be valid, and distinct from *Entolium* on the basis of external and internal shell morphology. *Syncyclonema* has a *Chlamys*-like shape, with a deep byssal notch, strong cardinal crura, and no auricular crura.

1. **Entolium (Entolium) corneolum** (Young & Bird, 1828) Pl. 4, figs. 25, 29, 30; Pl. 5, figs. 3–5; Text-fig. 20

- 1828 *Pecten corneolus* sp. nov., Young & Bird, p. 234, pl. 9, fig. 5.
 ?1829 *Pecten* sp.; Phillips, pl. 5, fig. 11.
 1829 *Pecten demissus* sp. nov., Phillips, pl. 6, fig. 5.
 ?1833 *Pecten phillipsii* nom. nov.; Voltz in Thurmann, p. 32 (*pro Pecten* sp. Phillips 1829).
 1836 *Pecten demissus* Phillips; Goldfuss, p. 74, pl. 99, fig. 2.
 non 1836 *Pecten cingulatus* nom. nov.; Goldfuss, p. 74, pl. 99, figs. 3a, 3b [*pro Pecten* sp. Phillips, 1829]. [non Phillips.]
 1855 *Pecten demissus* Phillips; Morris & Lycett, p. 127, pl. 14, fig. 7.
 non 1858 *Pecten demissus* Phillips; Quenstedt, p. 353, pl. 48, figs. 6, 7 (= *Entolium disciforme* Schübler).
 1858 *Pecten demissus* Phillips; Quenstedt, p. 553, pl. 72, fig. 27.
 1859 *Pecten demissus* Phillips; Leckenby, p. 8.
 1860 *Pecten demissus* Phillips; Damon, pl. 9, fig. 3.
 1930 *Entolium demissum* (Phillips); Arkell, p. 91, pl. 7, fig. 4; pl. 9, fig. 8.
 1932 *Entolium demissum* (Phillips); Spath, p. 112, pl. 26, fig. 2.
 1932 *Entolium rhypheum* (d'Orbigny); Douglas & Arkell, p. 157.
 1934 *Pecten (Entolium) demissus* Phillips; Stoll, p. 22, pl. 2, fig. 21.
 1935 *Entolium demissum* (Phillips); Arkell, p. x, pl. 53, fig. 3.
 1935 *Pecten corneolus* Young & Bird; Arkell, p. xi.
 1948 *Entolium corneolum* (Young & Bird); Cox & Arkell, p. 15.
 1965 *Entolium corneolum* (Young & Bird); Cox, p. 51.
 1967 *Entolium demissum* (Phillips); Speden, p. 15, pl. 3, fig. 3.

Neotype. Designated herein; OUM J8151; figured Arkell, 1930, pl. 7, fig. 4; Osmington Oolite (Oxfordian) of Malton, Yorkshire.

Measurements.

	H	L	Umbonal angle
N	15	15	7
\bar{x}	29.7 mm	88.5%	100.7°
Max	72.0	95.3	110.0
Min	11.1	80.2	95.0
OR	60.9	15.1	15.0

Description. Valves, excluding auricles, equilateral, equivalve, suborbicular to subovate, up to 72 mm high; auricles small, subequal, those of left valve projecting above level of hinge line, most

marked at distal extremities, meeting anterodorsal and posterodorsal margins close to umbo, at an obtuse angle. Length variable, but always less than height, giving subovate outline, which becomes almost suborbicular in some forms with a relatively large length/height ratio; shell outline independent of size. Umbones small, median, pointed, orthogyrate, not salient to dorsal margin. Anterodorsal margin straight to very gently concave, byssal notch absent; posterodorsal margin gently concave, diverging at an umbonal angle of *c.* 100°; anterior, posterior and ventral margins forming a continuous sweeping curve, of nearly semicircular outline; anterodorsal and posterodorsal angles rounded, placed about one-third of shell height below umbones. Auricular sulcus well developed, auricles clearly marked off from body of shell. Both valves with regular closely-packed, concentric growth lines, occasionally slightly elevated into very faint concentric riblets, and sometimes showing marked growth halts; in well-preserved material very faint radial striae cover entire body of shell, giving a fine cancellate pattern on a submacroscopic level; some small specimens from the Inverbrora Shale Member (*medea* Subzone) of Brora show faint radial growth crumples on shell exterior, superimposed on fine concentric growth lines. Shell thin, often shiny and smooth, with a foliated calcitic inner layer, and a radially fibrous calcitic outer layer. Margin entire, closed.

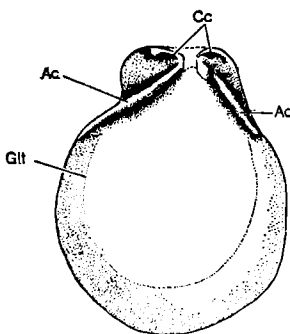

TEXT-FIG. 20. Internal view of a left valve of *Entolium* (*Entolium*) *corneolum* (Young & Bird), from the Oxford Clay of Brora, Sutherland, in the author's collection, showing the crura on the cardinal plate, $\times 2$. **Ac** = auricular crura; **Cc** = cardinal crura; **Glt** = growthline trace.

Ligament placed in small triangular resilifer, but rarely seen due to fragility of shell; incised ligamental area parallel to dorsal margin not visible for the same reason. Cardinal crura faint, narrow, one on either side of ligament on each valve, placed very close to dorsal margin, more clearly defined distally. Auricular crura clearly developed, reflecting in part the well-defined exterior auricular sulcus, becoming more elevated above auricles as they are traced distally, and usually swelling out into a small tubercle at distal extremity (Text-fig. 20). Byssal notch absent in all stages of development, ctenolium absent. Adductor muscle scar and pallial line not visible.

Remarks. The synonymy given above refers to the most important British references to the species, and lists occurrences not recorded by Arkell (1930, p. 91).

The variability of the species may be well seen in populations collected from horizons such as the Hackness Rock and within the Corallian Beds, where narrow subovate specimens occur together with much wider suborbicular forms. Arkell (1930, p. 93; 1935, p. xi) originally claimed to be able to distinguish between Middle and Upper Jurassic specimens of *Entolium*, and referred the Bathonian forms to *E. rhyphum* (d'Orbigny), on the basis of their more orbicular outline and larger umbonal angle. However, he later (*in* Cox & Arkell 1948, p. 15) amended this view, and agreed that the forms were indistinguishable on the basis of the great range of variation at all horizons. The author agrees with the view that *E. corneolum* is a very variable, long-ranging species.

The specimen of *Pecten* sp. figured by Phillips (1829, pl. 5, fig. 11) from the Yorkshire Oxford Clay may be referable to *E. corneolum*, but the original is lost, and no topotypes have been seen. The subequal nature of the auricles, the apparent lack of a byssal notch, and the general outline suggest that it is an *Entolium*. The dorsal margins seem a little too concave though this could be due to poor preservation or bad drawing; in the lack of comparable specimens, no definite conclusions can be drawn. Voltz in Thurmann (1833, p. 32) proposed the name *Pecten phillipsii* nom. nov. for Phillip's figure. Goldfuss (1836, p. 74, pl. 99, figs. 3a, 3b) compounded the confusion by introducing the name *Pecten cingulatus* nom. nov. for the same specimen (ignoring the prior name of Voltz), figuring a specimen clearly different from that of Phillips in that it had a pair of sharp-topped radial laminae on the inner shell surface, passing almost to the ventral margin. *E. cingulatum* (Goldfuss) has recently been figured by Cox (1965, p. 52, pl. 6, fig. 5). The identity of *Pecten vitreus* Roemer and *P. solidus* Roemer with *E. corneolum* were noted by Arkell (1930, p. 93).

The small specimens of *E. corneolum* from the Inverbrora Shale Member of Brora show the inner surface of the valves, enabling examination of the cardinal plate and auricular areas to be made for the first time. Speden (1967, p. 15) noted the hinge structure of some other species of *Entolium*.

E. corneolum belongs to the group of species which lacks internal laminae, the generic significance of which is still uncertain. The lack of internal laminae immediately distinguishes *E. corneolum* from species such as *E. proteus* (d'Orbigny), *E. renevieri* (Oppel), *E. cingulatum* (Goldfuss), and *E. partitum* (J. de C. Sowerby), all of which have them. *E. disciforme* (Schübler in Zieten), from the Bajocian, is lower and more orbicular, usually with length exceeding height.

Range and occurrence. Most levels from the Inferior Oolite to the Kimmeridge Clay (Cox & Arkell 1948, p. 15). In the English Lower Oxford Clay, in the *jason* Subzone of Calvert, the *enodatum*, *medea* and *jason* subzones of Norman Cross, the *calloviense* Subzone of Stewartby, and the *medea* and *jason* subzones of Bletchley. Common in the Hackness Rock (*athleta* to *lamberti* zones) of Scarborough, the *calloviense* and *jason* zones of Brora, and the Oxford Clay of the Kent coalfield; the *athleta* to *lamberti* zones (Middle Oxford Clay) of Woodham, Buckinghamshire, and Kellaways Rock of Wiltshire. Equivalent levels in the Callovian to Oxfordian of France, Germany, Switzerland, Poland, Russia, Greenland and India.

2. *Entolium* sp. A Pl. 5, figs. 7–10, 12, 13, 17; Text-fig. 21

1975 "*Entolium*" sp. nov., Duff, pp. 446 *et seq.*

Description. Medium-sized species, inequilateral, height greater than length, giving subovate or suborbicular outline in forms with low and high L value respectively. Left valve not seen. Dorsal margin straight to gently concave, often with auricles elevated slightly above level of hinge line; auricles subequal, but anterior larger than, and meets anterior margin farther away from dorsal margin than posterior auricle; well-developed byssal notch present beneath right anterior auricle, giving anterior margin a concavo-convex outline (Text-fig. 21); ctenolium absent; posterior margins slightly concave to evenly convex, posterior margin curved continuously with ventral margin in forms where posterior margin is convex; anterior angle variably rounded, not angular, passing smoothly into arcuate ventral margin. Ornament not visible, but shell exterior probably smooth (see Remarks); the translucent shell, viewed from the inside, shows faint regular concentric markings, which may be faintly represented on external surface; auricles smooth.

Auricular crura well-developed, that of anterior auricle stronger and wider than posterior, this swelling out distally into an elevated tubercle. Cardinal crura faint, narrow, placed very close to hinge margin, formed of inner shell layer only; anterior crus much more prominent than posterior, both becoming better-developed distally (Text-fig. 21); resilifer not seen, but by extrapolation from the height of the cardinal plate, probably small; no ligament band seen. Adductor muscle scar not visible. Margin entire.

Measurements.

	H	L	Umbonal angle
N	15	15	11
\bar{x}	7.3 mm	87.3%	100.9°
Max	12.3	93.8	105
Min	4.3	80.2	93
OR	8.0	13.6	12

Remarks. The taxonomic position of this species is uncertain but it is assigned to *Entolium* on the basis of external shape, and on the configuration of the anterior auricle and the byssal notch in the right valve. Interpretation is rendered difficult because the shells are characteristically preserved with a coating of secondary calcite on the external surface. No ornamentation can be seen, but as this method of preservation reproduces the shell ornament in other species it can be assumed that the external surface is smooth.

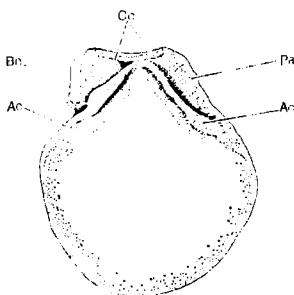

TEXT-FIG. 21. Internal view of a right valve of *Entolium* sp. A., showing details of the cardinal plate, $\times 5$. Note the small but distinct byssal notch (**Bn**), and the clearly-developed cardinal and auricular crura. **Ac** = auricular crus; **Cc** = cardinal crura; **Pa** = posterior auricle.

Some species of *Entolium*, in particular those belonging to *E. (Cteniopleurium)*, are thought to have a byssal notch in juvenile stages (Hertlein 1969, p. N347), but this is rare in the genus. The possession by *Entolium* sp. A of a byssal notch in the adult stage is therefore even rarer, although a related form, *E. hehlii* (d'Orbigny) from the Lias, also has one (A. Johnson 1977, pers. comm.).

Range and occurrence. The species is stratigraphically localized, occurring abundantly in the *grossouvrei* Subzone of southern England, and is commonest in the calcareous clay facies, although it also occurs in the *Grammatodon* and *Meleagrinnella* shell-beds. One specimen has been recorded from the *medea* Subzone (*jason* Zone) of Norman Cross, Peterborough.

Family PECTINIDAE Rafinesque, 1815

Genus **CAMPTONECTES** Agassiz in Meek, 1865

Type species. Subsequent designation; Stoliczka 1871, p. 425; *Pecten lens* J. Sowerby 1818, p. 3, pl. 205, figs. 2, 3 (= *Chamites auritus* Schlotheim 1813, p. 103); Corallian Beds of the Oxford district.

Diagnosis. Inequivalve, left valve more inflated than right; large byssal notch developed beneath right anterior auricle; ornament of fine curved divaricate striae, a punctate pattern being produced by their intersection with fine concentric growth lines.

Subgenus **CAMPTONECTES** s.s.

Diagnosis. As *Camptonectes* s.l., but with very fine concentric growth lines, never elevated into ribs; radial elements consisting of fine divaricate striae, never strengthened into radial ribs.

Remarks. *Camptonectes* is one of the best known genera of British Jurassic Pectinacea, but there has been some controversy over the authorship of the genus, the name first being used by Meek (1865, p. 39). In his diagnosis of *Camptonectes*, Meek clearly indicated that the concept of the genus was due to Agassiz (MS), and thus under ICZN rules, the name should be credited to Agassiz. The status of *Camptonectes* has been discussed by Speden (1967, p. 17).

Camptonectes (Camptonectes) auritus (Schlotheim, 1813) Pl. 5, figs. 22, 25; Text-fig. 22

- 1676 *Pectinites* Plot; p. 104, pl. 4, fig. 11.
 1813 *Chamites auritus* sp. nov., Schlotheim, p. 103 [reference to Lister 1678, pl. 9, fig. 51].
 1818 *Pecten lens* sp. nov., J. Sowerby, p. 3, pl. 205, figs. 2, 3.
 1818 *Pecten arcuatus* sp. nov., J. Sowerby, p. 3, pl. 205, figs. 5, 7.
 1822 *Pecten maltonensis* sp. nov., Young & Bird, p. 235, pl. 9, fig. 1.
 1828 *Pecten maltonensis* Young & Bird; Young & Bird, p. 233, pl. 9, fig. 1.
 ?1828 *Pecten lens* J. Sowerby; Young & Bird, p. 234, pl. 9, fig. 18.
 1845 *Pecten lens* J. Sowerby; d'Orbigny, p. 476, pl. 42, figs. 1, 2.
 non 1846 *Pecten lens* J. Sowerby; Rouillier, pl. C, fig. 13.
 non 1853 *Pecten lens* J. Sowerby; Morris & Lycett, p. 11, pl. 2, fig. 1 (= *Pecten laminatus* J. Sowerby, Bathonian).
 non 1853 *Pecten arcuatus* J. Sowerby; Morris & Lycett, p. 11, pl. 1, fig. 18 (= *Pecten rigida* J. Sowerby, Bathonian).
 1871 *Pecten lens* J. Sowerby; Phillips, pl. 13, fig. 24.
 1901 *Pecten lens* J. Sowerby; Raspail, p. 193, pl. 12, fig. 14.
 1930 *Camptonectes lens* (J. Sowerby); Arkell, p. 94, pl. 7, fig. 1; pl. 9, figs. 4-7.
 1935 *Camptonectes lens* (J. Sowerby); Arkell, p. xii.
 1936 *Camptonectes lens* (J. Sowerby); Dechaseaux, p. 30, pl. 4, figs. 9, 9a, 11, 14.
 1948 *Camptonectes auritus* (Schlotheim); Cox & Arkell, p. 14.
 1952 *Camptonectes auritus* (Schlotheim); Cox, p. 23, pl. 2, fig. 6.
 1967 *Camptonectes auritus* (Schlotheim); Speden, p. 17, pl. 4, figs. 1, 3, 6.
 1972 *Camptonectes auritus* (Schlotheim); Walker, p. 123, pl. 7, fig. 10.

Neotype. Designated herein; BM L80525; figured J. Sowerby, 1818, pl. 205, fig. 2, as *Pecten lens* sp. nov.; Pl. 5, fig. 25; Shell-cum-Pebble Bed (Oxfordian) of Headington, Oxfordshire.

Measurements.

	H	L	Umbonal angle
N	8	8	7
\bar{x}	39.5 mm	94.6%	107.0°
Max	58.0	98.5	110
Min	28.0	86.8	104
OR	30.0	11.7	6

Description. Large species, inequivalve, planoconvex, right valve almost flat, left valve convex. Inequilateral, auricles small, unequal, anterior auricles larger than posterior; anterior auricle of right valve larger than that of left, with large byssal sinus beneath it. Outline suborbicular to subovate, height always slightly greater than length; umbonal angle 104-110°, widest in suborbicular forms. Anterior auricle of right valve elongate, dorsal margin straight to very gently concave, anterior margin truncate, becoming more convexly rounded ventrally, passing into concavely rounded byssal fasciole, and meeting anterodorsal margin of body of shell at about a right angle; all four auricular sulci deeply impressed; right anterior auricle also with a well-developed ridge from umbo to posteroventral tip of main part of auricle, forming dorsal edge of byssal fasciole; right posterior auricle with straight dorsal margin, shorter than that of the anterior auricle, its posterior margin obliquely truncate, becoming gently concave ventrally, meeting posterodorsal margin of body of shell at an obtuse angle; anterior auricle of left valve not as elongate as that of right, its dorsal margin straight, anterior margin obliquely truncate to gently convex, meeting body of shell at a very obtuse angle; left posterior auricle short, its dorsal margin gently convex, posterior margin obliquely truncate, meeting body of shell at a very obtuse angle. Auricles of left valve with tightly packed fine vertical growth lines, particularly well seen on

anterior auricle; right posterior auricle with punctate diagonal radial striae, anterior auricle with fine concentric growth lines.

Main body of shell suborbicular; umbones small, submesial, orthogyrate, not elevated above dorsal margin, rounded. Valves of similar outline, but unequally inflated, right valve almost planar, left valve markedly convex. Anterodorsal margin evenly concave, anterior auricle meeting it at about its midpoint; anterior angle sharply rounded, passing evenly into semicircular ventral margin; posterodorsal margin gently convex, posterior angle more rounded than anterior, passing smoothly into ventral margin. Ornament of both valves similar, consisting of closely packed, fine, divaricate striae, densely punctate, markedly divergent at anterior and posterior extremities; fine concentric growth lines interact with divaricate striae to produce a finely reticulate pattern upon which punctae are superimposed.

Inner surface of hinge margin with fine vertical ridges and grooves, particularly well developed anterior of resilifer, for articular restraint. Resilifer not seen, but probably small because of low

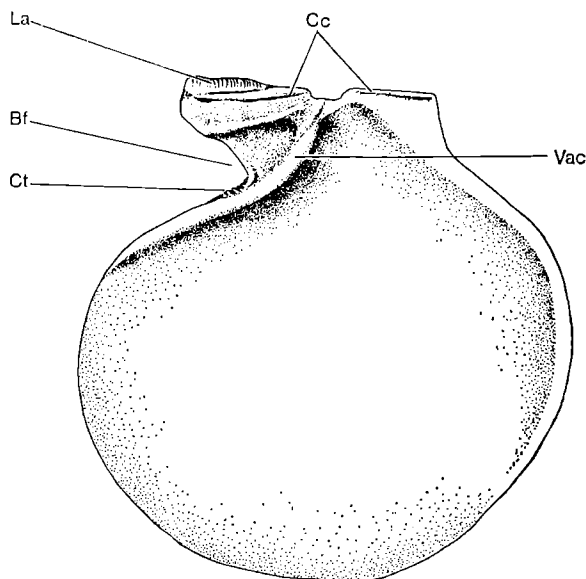

TEXT-FIG. 22. Internal view of a right valve of *Camptonectes* (*Camptonectes*) *auritus* (Schlotheim), from the Corallian Beds (Oxfordian) of England (BM LL2445), showing details of the cardinal plate. The specimen was figured by Speden (1967, pl. 4, figs. 1, 3, 6); $\times 1.5$. **Bf** = byssal fasciole; **Cc** = cardinal crura; **Ct** = ctenolium; **La** = ligament area; **Vac** = vestigial auricular crus.

height of hinge plate in umbonal region. One cardinal crus on each valve, anterior and posterior to resilifer, placed very close to hinge margin and parallel to it, crura becoming more strongly developed distally. Auricular crura absent (Text-fig. 22). A strong ridge runs from the area of resilifer to posteroventral extremity of main part of right anterior auricle, marking dorsal edge of byssal fasciole; a second ridge runs from resilifer to the part of the right anterior auricle above byssal notch, which may represent a vestigial auricular crus, although crura are absent on posterior auricle of the right valve and on both auricles of left valve. Ctenolium well-developed, placed along anterodorsal margin of right valve, immediately anterior to byssal notch. Pallial line and musculature unknown.

Remarks. The provenance of J. Sowerby's two syntypes of *Pecten lens*, said to be "the forest marble near Oxford", has been shown by Arkell (1930, p. 95) actually to be the Corallian Beds (Berkshire Oolite "Series") of Headington, Oxford. Arkell has also shown that several species of *Camptonectes* may be distinguished in the Middle and Upper Jurassic of Europe, and that there is no

justification for uniting all Middle and Upper Jurassic species in *Camptonectes lens*, as was done by Staesche (1926). Arkell also noted that much of the confusion over the species of *Camptonectes* was caused by using Sowerby's names without consulting the type specimens. The common Callovian to Kimmeridgian species *C. auritus* may easily be distinguished from the Bajocian to Bathonian *C. laminatus* (J. Sowerby); the latter is narrower and more subovate ($L \bar{x} 85\%$, umbonal angle $\bar{x} 90^\circ$), has a tendency for the ornament of the left valve to coarsen in larger specimens (the divaricate threads almost becoming riblets), and has different ornament patterns on the auricles. In *C. laminatus*, the left anterior auricle and the right posterior auricle both have about 10 conspicuous raised vertical lamellae.

Several entries omitted by Arkell have been placed in the synonymy here. *Pecten malltonensis* Young & Bird is clearly conspecific, their figure showing a well-preserved right valve, and it is probable that their figure of *P. lens* (1828, pl. 9, fig. 18) represents a poorly-preserved left valve, although there seems to be a lack of divaricate ornament. Couffon's (1919) figure of *P. lens* shows a poorly-preserved steinkern of similar shape to *Camptonectes*, but lacking all external ornament.

Arkell (1930, p. 96) recorded *C. auritus* from the Forest Marble of Chippenham (GSM 49043); the specimen is rather narrower than is usual for that species and it is better placed in *C. laminatus*.

Range and occurrence. Upper Cornbrash, Kellaways Rock, Hackness Rock, Corallian Beds and Kimmeridge Clay of Britain; rare in Inverbrora Shale Member (Callovian) of Brora, Sutherland. Lower Oxford Clay of the English Midlands, in the *enodatum* Subzone at Stewartby, and *medea* Subzone at Bletchley. Widespread in Callovian to Kimmeridgian of Europe (Arkell 1930, p. 94).

Genus **CHLAMYS** Röding, 1798

Type species. Subsequent designation; Herrmannsen 1847, p. 231; *Pecten islandicus* Müller 1776, p. 248; Recent, circumboreal.

Diagnosis. Suborbicular, often slightly higher than long, commonly somewhat oblique; both valves convex, left valve usually more so, but in some species of almost equal convexity; auricles clearly delimited, usually large, with large byssal notch beneath right anterior auricle; ctenolium usually present; sculpture of radial (usually stronger) and concentric elements, with scale-like spines often developed at their junctions, especially on the left valve; in the adult stages, intercalatory ribs are often present in the interspaces; margin scalloped; cardinal crura variable in number and size.

Subgenus **CHLAMYS** s.s.

(Synonyms: *Actinochlamys* Roberto, 1898; *Myochlamys* Von Ihering, 1907; *Chlamydina* Cossman, 1907; *Zygochlamys* Von Ihering, 1907; *Belchlamys* Iredale, 1929; *Mimachlamys* Iredale, 1929; *Scaeo-chlamys* Iredale, 1929; *Talochlamys* Iredale, 1929; *Veprichlamys* Iredale, 1929)

Diagnosis. Usually higher than long, with anterior auricles longer than posterior auricles; sculpture of numerous, generally grooved or striated and spinose, radial ribs; inner margin commonly with rounded, grooved, weak riblets; cardinal crura weak or nearly obsolete.

Remarks. *Chlamys* s.s. is readily distinguished from other Jurassic subgenera, such as *Radulopecten*, by virtue of its much greater rib density, which gives a strong, finely reticulate pattern on both valves. The ornament is similar to that seen in *Camptonectes* (*Camptochlamys*), where strong concentric lamellae interact with radial riblets to give a slightly coarser reticulate pattern. *Camptochlamys* may also be distinguished by the presence of faint *Camptonectes*-type ornament on the auricles and adjacent areas, and by its larger byssal notch and fasciole.

In *Chlamys* s.s., the strength of the concentric lamellae is rather variable; most Recent species, including the type species *C. islandica*, having only very faint concentric ornament, usually developed as spinose protuberances on the radial riblets. In contrast, most Jurassic species, such as *C. bedfordensis* sp. nov., *C. splendens* (Dollfuss), *C. nattheimensis* de Loriol and *C. qualicosta* (Étallon) have stronger concentric lamellae, often forming conspicuous features which give rise to a marked reticulate ornament pattern.

Chlamys (Chlamys) bedfordensis sp. nov. Pl. 5, figs. 14–16, 18, 21; Text-fig. 231975 *Chlamys (Chlamys)* sp. nov.; Duff, pp. 446 *et seq.**Holotype*. BM LL27724; Pl. 5, fig. 16; *grossouvrei* Subzone, *coronatum* Zone, Middle Callovian, of Calvert, Buckinghamshire.*Paratypes*. (BM LL27725–28) from the *obductum* Subzone, *coronatum* Zone, of Stewartby, Bedfordshire.*Measurements.*

Right valve

	L	H	Lh	AL	Umbonal angle
N	3	3	1	2	3
\bar{x}	6.8 mm	100.7%	60.6%	53.2%	111°
Max	9.7	101.1	60.6	53.2	113
Min	9.4	100.0	60.6	53.2	109
OR	0.3	1.1	0	0	4

Left valve

N	2	2	1	2	2
\bar{x}	7.3 mm	102.8%	71.4%	44.6%	107.5°
Max	7.7	103.0	71.4	46.8	108
Min	6.6	102.6	71.4	42.4	107
OR	1.1	0.4	0	4.4	1

Description. Small species, suborbicular in outline, subequilateral, bialate, subequivalve, right valve slightly more inflated than left. Hinge line straight, about two-thirds of overall length of shell, auricles of left valve subequal, those of right valve unequal, right anterior auricle higher and longer than posterior. Anterodorsal margin of right valve gently concave, marking position of deeply excavate auricular sulcus; posterodorsal margin very gently concave where it abuts against the excavate auricular sulcus, then gently convex; no perceptible angle between posterodorsal margin and semicircular outline of ventral margin; anterodorsal angle rounded and obtuse. Right anterior auricle marked off from body of shell by deeply excavate auricular sulcus; as there is no well-marked byssal fasciole, it is close to body of shell; outer surface of auricle gently arched, anterior end curving gently down to anterodorsal margin. Posterior auricle of the right valve shorter and more trigonal but clearly marked off from body of shell by deep auricular sulcus; its posterior margin forms an obtuse angle of *c.* 115° with hinge line, and is gently concave in outline, meeting posterodorsal margin not far below hinge line.

Antero- and posterodorsal margins of left valve very gently concave; subequal, trigonal auricles marked off from body of shell by deep auricular sulci; at anterior and posterior extremities of valve, margins become more convex, and pass evenly into semicircular shaped ventral margin, with no clearly differentiated angles. In both valves, umbones placed in a submedian position.

Both valves have densely-packed fine radial riblets, the right valve about 70, and left valve about 40 at ventral margins. Faint intercalatory riblets appear in some interspaces towards ventral margin in both valves; these are crossed by regularly-spaced fine concentric lamellae, which are present over whole of body of shell, and give rise to a microscopically reticulate pattern. Both concentric lamellae and radial riblets persist onto auricles, where lamellae are strengthened relative to those on body of shell; lamellae very narrow and wire-like, and usually finer than radial riblets.

A pair of small, weak cardinal crura is present on the cardinal plate of each valve, each crus being short, low and placed subparallel to hinge margin, fading distally (Text-fig. 23). Resilifer not seen. Auricular crura absent, but there is a slight ridge along the line of auricular sulcus of right anterior auricle, cut near byssal sinus by narrow, deeply excavate, transverse byssal notch,

which runs subparallel to hinge margin. Ctenolium not visible. Ventral margin of shell finely scalloped where radial riblets reach it. Inner shell layer of nacreous aragonite, outer layer of crossed-lamellar calcite.

Remarks. This species is distinguished by its small size, high rib density and suborbicular outline. *Pecten mantocheensis* Étallon, a small, densely ribbed species from the Portlandian of France, is rather similar to *C. bedfordensis*, but differs in being higher and more trigonal. *Chlamys subtextoria* (Münster), from the Upper Jurassic of Germany, has similar ornamentation to *C. bedfordensis* and is small, but the density of ribbing is much less, only 33 ribs being present, and it is rather higher and more trigonal.

Range and occurrence. Rare in the *coronatum* Zone of Calvert, Stewartby and Norman Cross.

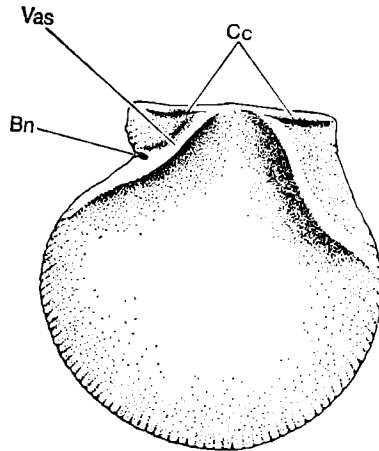

TEXT-FIG. 23. Internal view of a right valve of *Chlamys (Chlamys) bedfordensis* sp. nov., from the Lower Oxford Clay (*grossouvrei* Subzone, *coronatum* Zone) of Peterborough (BM LL27727), showing detail of the cardinal plate. Note the well-developed cardinal crura (**Cc**), and the vestigial auricular crus (**Vas**); central part of the hinge plate broken, $\times 4$. **Bn** = byssal notch.

Subgenus **RADULOPECTEN** Rollier, 1911

Type species. Original designation; Rollier 1911, p. 158; *Pecten hemicostatus* Morris & Lycett 1853, p. 10, pl. 1, fig. 16; Great Oolite (Bathonian) of Minchinhampton, Gloucestershire.

Diagnosis. Right valve usually more inflated than left. Ornamentation variable, typically 5–6 pairs of twinned ribs on right valve, but in many species this is faint or obsolete, in which case there are 11–12 prominent radial ribs; left valve with 5–6 radial ribs in forms with twinned ribs on right valve, and 10–11 in forms without; right valve also with faint regular concentric growth lines, left valve with prominent, regular, wire-like concentric lamellae.

Remarks. Cox's (1952) emended interpretation of the nature of ribbing in *Radulopecten* has been followed here, so that the subgenus includes all of the Jurassic species placed by Staesche (1926) in the "Group of *Aequipecten fibrosus* Sowerby". Thus forms with poorly developed paired ribs on the right valve, such as *C. (R.) fibrosus* and some specimens of *C. (R.) scarburgensis* and *C. (R.) drewtonensis* may be included, together with the more 'typical' members of the subgenus, such as *C. (R.) hemicostatus*. In essence, *Radulopecten* now includes most of the Jurassic species referred to *Chlamys*.

1. ***Chlamys (Radulopecten) scarburgensis*** (Young & Bird, 1822). Pl. 5, figs. 19, 20, 23, 24, 26, 27; Pl. 6, figs. 1, 5, 6

1822 *Pecten scarburgensis* sp. nov., Young & Bird, p. 234, pl. 9, fig. 10.

1828 *Pecten scarburgensis* Young & Bird; Young & Bird, p. 235, pl. 9, fig. 13.

1829 *Pecten fibrosus* J. Sowerby; Phillips, pl. 6, fig. 3 (*non* J. Sowerby).

1845 *Pecten discrepans* nom. nov., Brown, p. 157, pl. 65, fig. 17 (nom. nov. *pro Pecten fibrosus* Phillips *non* J. Sowerby).

- ?1860 *Pecten fibrosus* J. Sowerby; Damon, pl. 3, figs. 1, 1a (*non* J. Sowerby).
 1883 *Pecten fibrosus* J. Sowerby; Lahusen, p. 23, pl. 2, fig. 3 (*non* J. Sowerby).
 1901 *Pecten fibrosus* J. Sowerby; Raspail, p. 193, pl. 12, fig. 9 (*non* J. Sowerby).
 1924 *Pecten fibrosus* J. Sowerby; Cossmann, p. 28, pl. 4, figs. 19–21 (*non* J. Sowerby).
 1932 *Chlamys fibrosa* (J. Sowerby); Corroy, p. 188, pl. 27, figs. 15, 16 (*non* J. Sowerby).
 1934 *Pecten (Aequipecten) fibrosus* J. Sowerby var. *duplicostatus* nov. (*partim*), Stoll, p. 21, pl. 2, fig. 16 only (*non* figs. 17, 18; = *Chlamys (Radulopecten) fibrosa*).
 1935 *Chlamys scarburgensis* (Young & Bird); Arkell, p. xiii.
 1936 *Aequipecten fibrosus* (J. Sowerby); Dechaseaux, p. 47, pl. 6, figs. 15, 18, 18a, 19; pl. 7, fig. 1 (*non* J. Sowerby).
 1948 *Chlamys (Radulopecten) scarburgensis* (Young & Bird); Cox & Arkell, p. 13.

Neotype. Designated herein; SM J12398; Pl. 5, fig. 27; Hackness Rock of Scarborough, Yorkshire.

Measurements.

	L	H	I	Umbonal angle	Ribs
N	12	12	5	10	12
\bar{x}	27.1 mm	108.0%	30.5%	97.2°	9.7
Max	41.5	116.3	34.3	108	11
Min	10.4	99.4	28.3	83	9
OR	31.1	16.9	6.0	25	2

Description. Large species, inequivalve, right valve slightly more inflated than left, inequilateral. Umbonal angle very variable, height slightly greater than length, inflation low. Suborbicular in outline, with prominent, subequal auricles; right valve anterior auricle slightly larger than posterior and has distinct byssal notch beneath it, ornamented by fine sinuous concentric growth lines, with no radial elements; the posterior auricle of the right valve ornamented by fine vertical striae, hinge margin having *c.* 8 coarse tuberculations acting as hinge teeth; left valve auricles subequal, not known in detail; auricular sulci well-developed; right valve with 9–11 coarse radial ribs, usually round-topped, but occasionally flattened and paired, ribs being equal in width or narrower than intervening sulci; ribs markedly divergent, sulci widening towards ventral margin; radial ribs and sulci crossed by fine concentric striae, numbering *c.* 55 to the centimetre; in some specimens, anteriormost and posteriormost ribs have weakened radial elements, and are marked more clearly by a line of squamae which represent coarsened concentric striae; ornament of left valve similar to that of right, ribs being round-topped, of approximately equal strength, numbering 9–11, and again markedly divergent; sulci wider than ribs, often as much as twice as wide; ribs and sulci of left valve crossed by coarse, wire-like concentric costellae, numbering *c.* 17 to the centimetre, the spacing remaining constant throughout growth. Ventral margin scalloped.

Remarks. *C. (R.) scarburgensis* (Young & Bird, 1822) was overlooked for over a century before Arkell (1935, p. xiii) recognized it as a valid species. This was at least in part due to the similarity between this species and the close relative *C. (R.) fibrosa* (J. Sowerby), which ranges from the Kellaways Rock to the Upper Oxfordian. There are, however, marked differences between the two with *C. (R.) scarburgensis* having fewer, more divergent ribs, of equal prominence in each valve, these ribs being narrower than in *C. (R.) fibrosa*; it also lacks the radial striae which occur in the sulci of *C. (R.) fibrosa*. The neotype is the largest specimen known (L 41.5 mm), although Young & Bird (1822, p. 234) in their original diagnosis stated that "some specimens are three inches long", and it is from this measurement that the maximum size (L 76 mm) is inferred.

Phillips (1829, pl. 6, fig. 3) figured a topotype of *C. (R.) scarburgensis*, which he identified as *P. fibrosus* J. Sowerby, but there can be little doubt from his plate that his specimen, now lost, did not belong to Sowerby's species. Brown (1845, p. 157) realized that Phillips had misidentified his specimen, and renamed it *Pecten discrepans* nom. nov., overlooking Young & Bird's prior name. Several continental authors (see synonymy) followed Phillips in misidentifying Sowerby's species, and referred specimens of *C. (R.) scarburgensis* to *C. (R.) fibrosa*. Stoll (1934, p. 21, pl. 2,

figs. 16–20) described *Pecten (Aequipecten) fibrosus* J. Sowerby, together with two new varieties of the species, from erratic boulders of Upper Jurassic age in north-west Germany. Study of large collections of *C. (R.) fibrosa* and *C. (R.) scarburgensis* shows the variability in form of the two species, and from this it is clear that all of Stoll's figures, except her plate 2, figure 16, belong to *C. (R.) fibrosa*. The latter specimen agrees well in size and ribbing style with topotypes of *C. (R.) scarburgensis*. Dechaseaux (1936, p. 47) also confused the two species, placing all her specimens in *Aequipecten fibrosus*, but it is clear from her plates (pl. 6, figs. 15–20; pl. 7, figs. 1–3) that more than two species are represented: her pl. 6, figs. 17, 17a, 20 are clearly different from both *C. (R.) fibrosa* and *C. (R.) scarburgensis*, as are her pl. 7, figs. 2, 3. Much work on her specimens is needed before they can be correctly interpreted, but it seems likely that her pl. 6, figs. 15, 18, 18a, 19 and pl. 7, fig. 1 may represent *C. (R.) scarburgensis*. *C. (R.) drewtonensis* Neale differs in that the left valve is slightly more inflated than the right, and in the possession of a very prominent anterior auricle on the right valve. The anterior auricle is ornamented by 9 fine radial striae in its proximal 6·5 mm.

Range and occurrence. In Britain, the Upper Cornbrash of Scarborough, the Kellaways Rock of Kellaways, Wiltshire, the Hackness Rock of Scarborough, and the "Oxford Clay of Brill, Buckinghamshire" (GSM 42985). One fragmentary specimen from the *endodatum* Subzone of Stewartby; more abundant in the Middle to Upper Oxford Clay of Oxfordshire and at Woodham (many specimens in OUM). Callovian of Germany (Stoll 1934), France (Raspail 1901; Cossmann 1924) and Russia (Lahusen 1883); Oxfordian of France (Dechaseaux 1936).

2. *Chlamys (Radulopecten) fibrosa* (J. Sowerby, 1816) Pl. 6, figs. 2, 7–9; Text-fig. 24

- 1816 *Pecten fibrosus* sp. nov., J. Sowerby, p. 84, pl. 136, figs. 1, 2.
 1822 *Pecten fibrosus* J. Sowerby; Young & Bird, p. 233, pl. 9, fig. 12.
 1822 *Pecten sulcatus* sp. nov., Young & Bird, p. 233, pl. 9, fig. 3 (*non Pecten sulcatus* Bosc).
 non 1829 *Pecten fibrosus* J. Sowerby; Phillips, pl. 6, fig. 3.
 1860 *Pecten vagans* J. de C. Sowerby; Damon, pl. 9, fig. 4 (*non Pecten vagans* J. de C. Sowerby 1826, Bathonian species).
 non 1860 *Pecten fibrosus* J. Sowerby; Damon, pl. 3, figs. 1, 1a (= *Chlamys (Radulopecten) scarburgensis*).
 non 1882 *Pecten fibrosus* J. Sowerby; Roeder, p. 50, pl. 1, figs. 11a, 11b.
 non 1901 *Pecten fibrosus* J. Sowerby; Raspail, p. 193, pl. 12, fig. 9. (= *Chlamys (Radulopecten) scarburgensis*)
 non 1919 *Chlamys fibrosus* (J. Sowerby); Couffon, p. 119, pl. 3, figs. 17, 17a, 18.
 non 1924 *Pecten fibrosus* J. Sowerby; Cossmann, p. 28, pl. 4, figs. 19–21. (= *Chlamys (Radulopecten) scarburgensis*).
 1926 *Aequipecten fibrosus* (J. Sowerby); Arkell, p. 546, pl. 34, figs. 2–5.
 1927 *Chlamys (Aequipecten) fibrosus* (J. Sowerby); Arkell, p. 165, pl. 2, figs. 6a, b.
 1931 *Chlamys (Aequipecten) fibrosa* (J. Sowerby); Arkell, p. 112, pl. 11, figs. 6–12.
 1934 *Pecten (Aequipecten) fibrosus* (J. Sowerby); Stoll, p. 21, pl. 2, fig. 19.
 1934 *Pecten (Aequipecten) fibrosus* (J. Sowerby) var. *duplicostatus* nov., Stoll, p. 21, pl. 2, figs. 17, 18.
 1934 *Pecten (Aequipecten) tenuicostatus* nom. nov.; Stoll, p. 22, pl. 2, fig. 20 (*pro Pecten fibrosus* Goldfuss, *non* J. Sowerby).
 1936 *Aequipecten fibrosus* (J. Sowerby); Dechaseaux, p. 47, pl. 6, figs. 16, 16a.
 non 1936 *Aequipecten fibrosus* (J. Sowerby); Dechaseaux, p. 47, pl. 6, figs. 15, 17, 17a, 18, 18a, 19, 20; pl. 7, figs. 1–3 (*non* J. Sowerby).
 1952 *Chlamys (Radulopecten) fibrosa* (J. Sowerby) var.; Chavan, p. 36, pl. 2, fig. 14.

Lectotype. Designated Arkell 1931, p. 114; BM 43305; J. Sowerby 1816, p. 84, pl. 136, fig. 2 (right hand figure); Pl. 6, fig. 9; Corallian Beds of Oxfordshire.

Measurements.

	L	H	Umbonal angle	Ribs
N	11	11	11	9
\bar{x}	25·8 mm	110·2%	97·2°	12·3
Max	34·2	113·9	104	16
Min	12·3	104·5	89	11
OR	21·9	9·4	15	5

Description. Large species, up to 35 mm long, inequilateral, subequivalve, left and right valves with very marked differences in ornamentation. Umbonal angle very variable, appearing to increase during growth; height slightly greater than length. Auricles subequal, right anterior auricle with byssal sinus beneath it; right anterior auricle with sinuous raised comarginal striae, the striae on posterior auricle comarginal and vertical; left valve auricles subequal, both with slightly coarse, vertical, raised comarginal striae; no radial elements present on any of the auricles; right valve with 11–14 wide, flat-topped radial ribs, always considerably wider than intervening sulci, and widening ventrally; in large specimens wide primary ribs tend to become paired at their ventral margins; ribs and sulci crossed by regular fine concentric striae, numbering *c.* 70 per cm, which pass onto auricles as comarginal striae; ornament of left valve more prominent, with 11–14 narrower, higher, round-topped radial ribs, which are narrower than the sulci; as in the right valves of large specimens, there is a tendency for intercalation of secondary ribs in the sulci towards the ventral margin; both ribs and sulci crossed by coarse, wire-like concentric striae, numbering *c.* 15 to the cm, and passing onto auricles as comarginal striae; faint radial striae are present in sulci of both left and right valves. Ventral margin scalloped.

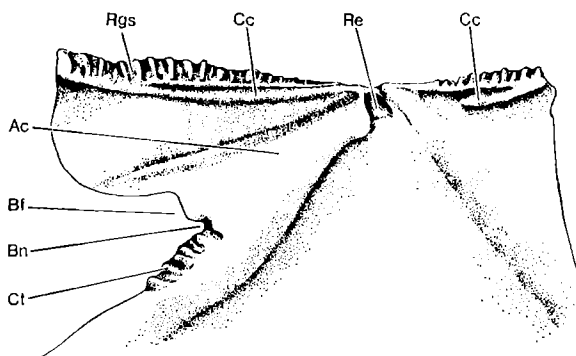

TEXT-FIG. 24. Internal view of a right valve of *Chlamys (Radulopecten) fibrosa* (J. Sowerby) from the Oxford Clay of Chippenham, Wiltshire (GSM 113408), showing details of the cardinal plate, $\times 3$. **Ac** = auricular crus; **Bf** = byssal fasciole; **Bn** = byssal notch; **Cc** = cardinal crus; **Ct** = ctenolium; **Re** = resilifer; **Rgs** = ridge and groove system to aid articulation, and to prevent lateral shearing of the hinge-plates.

Remarks. The synonymy and range of variation of this species has been fully discussed by Arkell (1931, p. 112), and little need be added here. The few Oxford Clay specimens known, from Stewartby, Norman Cross and "Chippenham", are medium-sized specimens which show clearly the wide flat-topped ribs on the right valve, 11–16 in number, and the comarginal striae passing over the auricles. GSM 113408, from the "Oxford Clay of Chippenham", is unusual in that there appear to be about 16 radial ribs on the right valve, but as it is only possible to gain an internal view of the valve, style of ornament and rib pattern cannot be examined, and this specimen is assigned to *C. (R.) fibrosa* tentatively. However, the ctenolium and the vertical ridge and groove system along the hinge margin, are very well seen, and it is clear that there was a functional byssus in the adult. A pair of cardinal crura, radiating from the apex of the resilifer and running subparallel to the hinge margin, are also well seen (Text-fig. 24). Another unusual feature of this specimen is the size and extent of the anterior auricle, which seems rather large for *C. (R.) fibrosa*.

Stoll's (1934, p. 21) division of *C. (R.) fibrosa* into three is, as noted by Arkell (1935, p. xiii), unacceptable, as all her figured specimens fit the variation seen within Sowerby's species. Chavan's (1952, p. 36) *C. (R.) fibrosa* var. also belongs to the range of variation of this species. Only one of

Dechaseaux's (1936, p. 47, pl. 6, figs. 16–16a) specimens may be referred to *C. (R.) fibrosa*, the others belonging to *C. (R.) scarburgensis* and to two other species.

C. (R.) drewtonensis Neale, from the *calloviense* Zone Kellaways Rock of South Cave, Humberside, is undoubtedly closely related, but differs in the nature of the ornament on the anterior auricle, possesses radial striae on the proximal part of the right anterior auricle, and it has wider, flatter, more prominent ribs on the right valve.

Range and occurrence. Abundant at many levels between the Kellaways Rock and the Corallian Beds (Arkell 1931, p. 112), and sparingly in the *medea* and *grossouvrei* subzones at Stewartby, and in the *medea* and *jason* subzones at Norman Cross; ? "Oxford Clay of Chippenham" (GSM 113408) and Kellaways Rock of the Snowdown borehole, Kent (GSM K1342). Middle to Upper Oxford Clay of Oxfordshire, and Hackness Rock of Scarborough. Callovian and Oxfordian of France, Germany, Switzerland and Russia.

3. *Chlamys (Radulopecten) drewtonensis* Neale, 1956 Pl. 6, figs. 3, 4

1956 *Chlamys (Radulopecten) drewtonensis* sp. nov., Neale, p. 371, pl. 28, figs. 1–5.

1972 *Chlamys (Radulopecten) drewtonensis* Neale; Walker, p. 122.

Holotype. BM L88737; Pl. 6, fig. 3; Kellaways Rock (*calloviense* Zone) of South Cave, Humberside.

Diagnosis. Large species, with left valve slightly more inflated than right; umbonal angle about 100°, height slightly greater than length; right anterior auricle very produced, with sinuous comarginal striae, and 9 radial striae on the proximal 6.5 mm; ribs of right valve wide and flat-topped, 11 in number, posterior three or four becoming paired by the development of a median sulcus along each primary rib; right valve with fine concentric growth lines, *c.* 40 per cm, which become accentuated on anterior and posterior extremities; left valve with 11 narrower, round-topped ribs which are not as wide as the sulci, there also being a tendency towards development of secondary radial ribs in posterior three sulci, corresponding with pairing of ribs in right valve; concentric growth lines stronger than on right valve, but not as wire-like as in *C. (R.) fibrosa* and *C. (R.) scarburgensis*; auricles with fine comarginal striae.

Measurements.

	L	H	Umbonal angle	Ribs
N		2	2	2
\bar{x}	36.5 mm	109.7%	100°	11
Max	37.5	111.3	100	11
Min	35.5	108.0	100	11
OR	2.0	3.3	0	0

Description. Neale's (1956, p. 371) description is not repeated here, being replaced by an extended diagnosis. Walker (1972, p. 123) noted that the posterior auricle of the left valve, not seen by Neale, is ornamented by vertical lamellae, the spaces between them widening away from the umbo.

Remarks. *C. (R.) drewtonensis* is apparently restricted to the *calloviense* Zone in Humberside. The ribs are wide and flat-topped, as in *C. (R.) fibrosa*, but no examples of the latter species with such marked pairing of the ribs have been seen. The density of concentric striae on the right valve is also less than in *C. (R.) fibrosa*. The most obvious differences, however, are the presence of radial striae on the anterior auricle of *C. (R.) drewtonensis*, a feature not seen in the other species, and the weaker concentric ornament on the left valve of *C. (R.) drewtonensis*. It is possible that the discovery of more material will show that this species should be united with either *C. (R.) fibrosa* or *C. (R.) scarburgensis*, but with the present sparse material it is best left as a separate species.

Range and occurrence. Kellaways Rock (*calloviense* Zone, *endodatum* Subzone) of Kettlethorpe Main Quarry, and South Cave Station Quarry, Humberside.

Family **PLICATULIDAE** Watson, 1930
Genus **PLICATULA** Lamarck, 1801

Type species. Subsequent designation; Schmidt, 1818; *Spondylus plicatus* Linnaeus 1758, p. 511; Recent, Java.

Diagnosis. Small to medium-sized genus, subequivalve, right valve usually more convex than left; attachment area small to moderately large; cardinal area small, resilifer acutely triangular; crura straight, narrow, prominent, narrowly divergent, crenulated, those in the right valve adjacent to resilifer; adductor scar in a relatively posterior position.

Subgenus **PLICATULA** s.s.

(Synonyms: *Harpax* Parkinson, 1811; *Plicatulopecten* Neumann, 1907)

Diagnosis. Auricles absent or very poorly defined; most species with radial ornament, which may range from fine costellae to broad costae, and with imbricating growth lamellae; short spines present in many forms.

Remarks. Yonge (1973) showed the teeth and ligament structure of *Plicatula* to be radically different to those of *Spondylus* and other Pectinacea. He suggested that the evolution of the four Pectinacean families began in the Palaeozoic, with modifications of the organs of the mantle cavity, all four families having the same original set of structures. In the Propeamussiidae and Pectinidae, it was the organs of the mantle cavity which evolved, whilst in the Plicatulidae and Spondylidae, the ligament became adapted, the organs of the mantle cavity remaining almost unchanged. However, the great differences between the ligament and hinge of Plicatulidae and Spondylidae led Yonge (p. 205) to suggest that perhaps the Plicatulidae should be elevated to the status of a new superfamily.

Plicatula (Plicatula) cf. **fistulosa** Morris & Lycett, 1853 Pl. 6, figs. 10, 13–15

1853 *Plicatula fistulosa* sp. nov., Morris & Lycett, p. 15, pl. 2, fig. 5.

1907 *Plicatula fistulosa* Morris & Lycett; Cossmann, p. 273, pl. 1, figs. 1, 2.

1923 *Plicatula fistulosa* Morris & Lycett; Lissajous, p. 150, pl. 29, figs. 10–18.

1948 *Plicatula fistulosa* Morris & Lycett; Cox & Arkell, p. 15.

Holotype. GSM 9166; Pl. 6; fig. 12; Great Oolite (Bathonian), of Minchinhampton, Gloucestershire.

Measurements.

L \bar{x}	H \bar{x}	AL \bar{x}	I \bar{x} (both valves)
29.9 mm	112.8%	56.0%	31.3%

Description. Large species (up to 31.8 mm long), irregularly subovate in outline, inequivalve, left valve flatter than right; inequilateral, posterior region slightly produced, no differentiated auricles. Umbonal region rounded, passing smoothly into evenly and continuously-rounded anterior and ventral margins; posterior margin rounded, slightly produced, posterodorsal margin slightly convex, umbones situated just posterior of median. Inflation low. Margins closed.

Right valve slightly convex, with a suboval attachment area, 11.5 mm high by 8.2 mm long, in umbonal region; remainder of the external surface covered by irregular rows of sharply tubiform spines, with a central hollow core; spines roughly arranged in radial rows, *c.* 15 in number, *c.* six spines per row. Left valve very slightly convex, bearing a xenomorphic attachment area in the umbonal region; as in the right valve, much of the rest of the valve is covered with hollow tubiform spines, of slightly larger size than those on opposite valve, which are best developed along ventral margin; radial arrangement of spines less well marked than on right valve, and there are fewer spines.

Remarks. Damon (1860, pl. 9, fig. 7) described *Plicatula weymouthiana* from the *Trigonia clavellata* Beds (Oxfordian) of Weymouth, and many other specimens have since been collected from various levels within the Corallian Beds. However, the spines of the Oxford Clay species are

rather more delicate than those of *P. weymouthiana*, and are not so well aligned along radial elevations. It seems probable that the Callovian species is more closely related to *P. fistulosa* Morris & Lycett, a much more finely-ribbed species of similar shape; in view of the rarity of specimens in the Callovian, and the known variability of plicatulids, it is not possible to assign it to *P. fistulosa* with certainty (cf. Pl. 6, figs. 11, 12).

Range and occurrence. Lower Oxford Clay, *medea* Subzone (*jason* Zone) of Norman Cross, and *obductum* Subzone (*coronatum* Zone) of Bletchley. Range of *P. fistulosa* is Inferior Oolite to Great Oolite (Bajocian to Bathonian).

Suborder *OSTREINA* Férussac, 1822

Superfamily *OSTREACEA* Rafinesque, 1815

Family *GRYPHAEIDAE* Vyalov, 1936

Subfamily *GRYPHAEINAE* Vyalov, 1936

Genus **GRYPHAEA** Lamarck, 1801

(Synonyms: *Liogryphaea* Fischer, 1886; *Rygepha* Vyalov, 1946)

non *Gryphaea* Fischer, 1886 (= *Crassostrea* Sacco, 1897)

Type species. Subsequent designation; ICZN Opinion 338, p. 127, 1955; *Gryphaea arcuata* Lamarck 1801, p. 398; from the Lower Lias of France.

Diagnosis. Shell medium to large in size (up to 160 mm L), very inequivalve, left valve strongly convex and enrolled, right valve slightly concave, flat or slightly convex; shape very variable, ranging from high narrow forms, through suborbicular forms to triangulate forms, with or without the development of bilobation; left valve with posterior radial sulcus, weak or strong, forming anterior margin of posterior flange, which is of varying size and prominence; the deeper the sulcus, the more prominent the flange; umbones slightly opisthogyrate to orthogyrate; left valve with concentric growth squamae or undulations, occasionally smooth, with or without radial elements; umbo of left valve often strongly coiled, although frequently terminated by an attachment area; right valve with concentric growth squamae or undulations, with or without radial striae; adductor scar slightly posterior to midline, placed nearer hinge than ventral margin; dorsal margin always convex, ventral margin usually slightly elevated; quenstedt muscle insertions close to hinge plate and posterior to midline; umbonal cavity below hinge plate small, and almost entirely filled by shell material; resilifer excavate, varying from one to five times the length of each bourrelet; resilifer of right valve terminates dorsal margin of valve at a right angle to body of shell, and projects ventrally into shell cavity, where it is supported by a buttress; commissural shelf well developed, but lacking chomata.

Subgenus **BILOBISSA** Stenzel, 1971

Type species. Original designation; Stenzel 1971, p. N1099; *Gryphaea bilobata* J. de C. Sowerby 1835, p. 244 (= *G. dilatata* var. β J. Sowerby 1816, 113, pl. 149, fig. 2); from the Inferior Oolite (Bajocian) of England.

Diagnosis. Medium-sized subgenus (up to about 90 mm L), left valve with strongly developed posterior radial sulcus, and very well-marked and pronounced posterior flange; radial elements present only as faint striae on right valve; attachment area often large.

Remarks. The generic synonymy demonstrates the past confusion over the taxonomic position of *Gryphaea*, and it was not until the ICZN ruling of 1955 (Opinion 338) that the identity and type species of the genus were clarified. *Gryphaea* is now restricted to species of Triassic to Jurassic age, with a variably developed posterior sulcus. A full taxonomic revision of the Gryphaeidae has recently been produced by Stenzel (1971, p. N1097).

Stenzel (1971) erected *Bilobissa* for the strongly bilobate *Gryphaea* from Middle to Upper Jurassic with a well-developed posterior flange. Arkell (1934a, p. 64) had previously separated this subgenus, but gave it a name (*Bilobata*) which purposefully did not satisfy Article 11f of the ICZN Code. The provenance and horizon of the type species, *Gryphaea (Bilobissa) bilobata*, has been a source of much confusion since J. de C. Sowerby (1835, p. 244) introduced the specific

name for the unlocalized specimen figured by Sowerby (1816, p. 113, pl. 149, fig. 2) as *G. dilatata* var. β , and stated that it came from the "Kellaways Rock". Study of the holotype of *G. bilobata*, (BM 43349) led Richardson (1923 MS) to the conclusion that it came from the Inferior Oolite. C. P. Palmer (1973, pers. comm.) has examined the matrices of the holotype and of specimens from the Inferior Oolite and Kellaways Rock, and shown that the holotype of *G. bilobata* has a whitish oolitic matrix adhering to the right valve, exactly as in other specimens from the Inferior Oolite. Until the work of Stenzel (1971), the horizon of *G. bilobata* had always been taken as Kellaways Rock, and the name applied to Lower and Middle Callovian *Gryphaea* in general. I consider these forms specifically distinct; however, raising of Hallam & Gould's subspecific name *calloviense* (*recte calloviensis*) to specific rank is not possible since it is a junior homonym of *Ostrea* (*Gryphaea*) *calloviensis* which Rollier (1917, p. 582) had proposed for the specimen figured by J. Sowerby (1816, p. 113, pl. 149, fig. 2) as *G. dilatata* var. β (wrongly quoted as var. α by Rollier) and wrongly believed by him to be of Callovian age. I consider, therefore, that Rollier's proposed name is a junior objective synonym of *Gryphaea bilobata* and a senior homonym of *Gryphaea bilobata calloviense* Hallam & Gould, 1975.

Consequently, for this Callovian species I propose the name *dilobotes* (nom. nud. Sylvester-Bradley 1959, p. 2, fig. 3).

1. ***Gryphaea* (*Bilobissa*) *dilobotes* nom. nov.** Pl. 6, figs. 16–20; Pl. 7, figs. 1–9; Pl. 8, figs. 1, 4; Text-fig. 25

- ?1829 *Gryphaea dilatata* var. β . J. Sowerby; Phillips, pl. 6, fig. 1.
 1892 *Gryphaea bilobata* J. de C. Sowerby; Fox-Strangways, p. 279, pl. 14, fig. f.
 1892 *Gryphaea dilatata* J. Sowerby; Fox-Strangways, p. 293, pl. 15, fig. a.
 1895 *Gryphaea bilobata* J. de C. Sowerby; Woodward, p. 11, fig. 8.
 1898 *Gryphaea bilobata* J. de C. Sowerby; Strahan, p. 17, fig. 31.
 1904 *Gryphaea bilobata* J. de C. Sowerby; Fox-Strangways, p. 29, fig. 3f.
 1915 *Gryphaea dilatata* J. Sowerby; Krenkel, p. 300, pl. 25, figs. 36–39.
 ?1919 *Gryphaea* (*Lyogryphaea*) *bullata* J. Sowerby; Couffon, p. 52, pl. 3, figs. 14–14b.
 1932 *Gryphaea bilobata* J. de C. Sowerby; Arkell, p. 172.
 1934a *Gryphaea bilobata* J. de C. Sowerby; Arkell, p. 58, 60.
 1934a *Ostrea* (*Bilobata*) *gryphaea* nov. [non Linnaean]; Arkell, p. 64.
 1947 *Gryphaea bilobata* J. de C. Sowerby; Arkell, p. 27.
 1947a *Ostrea* (*Gryphaea*) *bilobata* (J. de C. Sowerby); Arkell, p. 68.
 1952 *Gryphaea bilobata* J. de C. Sowerby; Cox, p. 81, pl. 8, figs. 1, 2, 4.
 1955 *Gryphaea bilobata* J. de C. Sowerby; Callomon, p. 221.
 1959 *Gryphaea dilobotes* MS [nom. nud]; Sylvester-Bradley, p. 2, fig. 3.
 1968 *Gryphaea bilobata* auctt.; Callomon, p. 270.
 1970 *Gryphaea bilobata* J. de C. Sowerby; Cope & Cox, p. 122.
 1971 *Gryphaea* aff. *bilobata* J. de C. Sowerby; Callomon in Callomon & Cope, p. 168.
 1972 *Gryphaea bilobata* J. de C. Sowerby; Walker, p. 124.
 1975 *Gryphaea bilobata calloviense* subsp. nov., Hallam & Gould, p. 514, pl. 19, figs. 10c, d [*non* Rollier, 1917 = *G. bilobata*].
 1975 *Gryphaea* (*Bilobissa*) sp. nov.; Duff, pp. 446 *et seq.*

Holotype. OUM J29254; figured Hallam & Gould 1975, pl. 19, figs. 10c, d; Lower Callovian, Kettlethorpe, Yorkshire.

Measurements (Text-fig. 25)

Left valve												
	L	H	I	AL	L.lig	H.lig	Lab	Lpb	HMS	Hi	θ	α
N	66	66	66	63	27	40	25	25	34	63	65	56
\bar{x}	44.2 mm	114.7%	57.6%	46.0%	12.9%	12.2%	6.1%	5.9%	64.5%	101.8%	97.7°	27.7°
Max	80.0	144.8	87.9	57.4	17.8	22.1	9.1	10.3	102.1	138.3	128	42
Min	13.1	89.3	28.7	28.6	8.3	6.3	2.1	3.4	45.2	76.8	66	11
OR	66.9	55.5	59.2	28.8	9.5	15.8	7.0	6.9	56.9	61.5	62	31

Right valve

	L	H	I	AL	L.lig	H.lig	Lab	Lpb	HMS	Hi	θ	α
N	20	20	16	18	6	15	6	5	17	19	19	8
\bar{x}	38.6 mm	107.9%	27.1%	49.6%	11.9%	13.6%	6.4%	5.4%	68.4%	107.8%	92.7°	28.1°
Max	73.4	130.2	35.7	59.2	15.9	20.0	7.7	6.9	100.0	130.2	110	34
Min	14.5	84.0	15.0	33.1	10.0	6.2	5.7	4.5	54.6	84.0	70	24
OR	58.9	46.2	20.7	26.1	5.9	13.8	2.0	2.4	45.4	46.2	40	10

Description. Large species, up to *c.* 80 mm in length, of very variable form, outline subtrigonal to subovate, often with well-developed posterior flange. Very inequivalve, left valve strongly inflated and highly convex, right valve flat or slightly concave. Umbones prominent, rounded, slightly opisthogyrate and not tightly coiled, extremity often truncated by a large attachment area, xenomorphic on right valve. Anterior margin slightly concave to slightly convex, curving

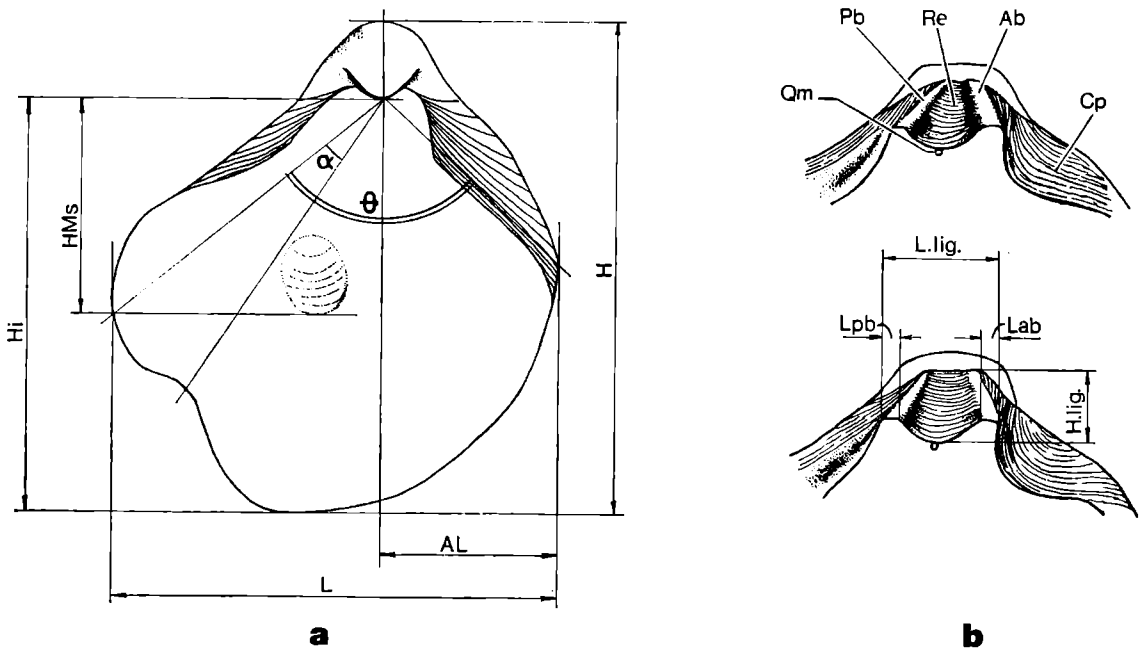

TEXT-FIG. 25. a. Schematic internal view of a left valve of *Gryphaea (Bilobissa) dilobotes* from the Lower Oxford Clay, showing the measurements used in the description of gryphaeate oysters. Details of shell ornament omitted for clarity, $\times 0.7$. b. Schematic views of the ligament area of a left valve of *G. (B.) dilobotes*, showing the characters measured, $\times 1$. **Ab** = anterior bourrelet; **AL** = anterior length; **Cp** = commissural platform; **H** = height; **Hi** = internal height, measured from the tip of the umbo to the ventral margin; **H.lig.** = height of the ligament; **HMS** = height of the base of the muscle scar beneath the hinge axis; **Lab** = length of the anterior bourrelet; **Lpb** = length of the posterior bourrelet; **L.Lig.** = overall length of the ligament (resilifer + bourrelets); **Pb** = posterior bourrelet; **Qm** = quenstedt muscle scar; **Re** = resilifer; α = the angle between the lines radiating from the tip of the resilifer to the posterior margin and the branchitellum; θ = the angle between the lines radiating from the tip of the resilifer to the anterior and posterior margins.

smoothly into evenly-rounded ventral margin; posterior margin usually produced into well-developed posterior flange, delimited anteriorly by deeply excavate posterior radial sulcus, angle α varying between 11–42° in left valve, and 24–34° in right valve; posterior radial sulcus tends to parallel the posterior margin, never reaches ventral margin, usually terminating about two-thirds way to it; this places posterior flange high on shoulders of valve, quite distinct from body of shell, usually as a clearly triangular feature; posterior margin deeply concave where posterior radial sulcus reaches margin; posterior flange often not well-developed in young forms

(up to 35 mm L), these tending to be high and subtrigonal in outline. Surface of left valve covered by coarse concentric growth squamae, with faint radial elements sometimes visible in the juvenile stages; right valve ornamented similarly, but radial elements tend to be stronger.

Adductor muscle scar placed slightly closer to dorsal than ventral margin, or subequidistant, and just posterior to mid-axis; shape variable, but usually more or less orbicular to subquadrate in left valve, suborbicular to subovate in right. Quenstedt muscle scar small, situated close to hinge axis, posterior to mid-axis, usually more or less below posterior bourrelet in both valves. Resilifer up to 5 times length of each bourrelet, covered by fine parallel growth lines which cross onto the bourrelets which are not well differentiated from the resilifer (Text-fig. 25b). In right valve, resilifer projects ventrally into shell cavity, forming a small ligamentary buttress, whole ligament area being perpendicular to plane of valve. Commissural platform (the areas postero-dorsal and anterodorsal of ligament, where growth squamae of valve margins form a flattened area outside the mantle-covered area) present on dorsal half of left valve, but not strongly developed. Proximal gill wheel (Stenzel 1971, P. N1033) faint, stretching from vicinity of quenstedt muscle scar to branchitellum. Umbonal cavity shallow. Hinge edentulous.

Remarks. In the population of *G. (B.) dilobotes* from the basal shell bed (*medea* Subzone) at Stewartby, there are abundant individuals with very large attachment areas which greatly affect the overall shape of the shells. In their juvenile stages the left valves take the form of a negative mould of the substrate to which they were attached, with the right valve assuming a xenomorphic positive mould of the substrate. Stenzel (1971, p. N1021) discussed the nature and mechanics of xenomorphism in oysters. As the oysters grew and became too large and heavy to remain in their original post-larval settlement position, they toppled over onto their left valves and then developed in the manner usual for *Gryphaea*, resting free, half-buried in the sediment, with the right valve uppermost in a more or less horizontal position (Stenzel 1971, p. N1072). By the time that the shells were large and heavy enough to overbalance, they were also strong enough to withstand the attacks of most predators, and so the attached, encrusting life-habit was no longer necessary.

This gives a population of two distinct morphotypes: the juveniles, of flattened shape with the whole or most of the left valve directly attached to the substrate, and the gryph-shaped "adults", with large residual attachment areas. The size at which the onset of the gryph-shape occurred is variable, apparently depending on the size of the shell fragment being used as a substrate, but most individuals appear to have assumed independence of the post-larval settlement site by the time they were 10 mm high.

The spat appear not to have been specific in their choice of settlement site, as they are found attached to ammonites, belemnites, bivalves, indeterminate shell material, fragments of wood, and occasionally to other oysters. The commonest attachment-site recognized is an ammonite shell or fragment, but this is probably due to ammonites being more abundant and easily recognized as fragments. Attachment to the ammonites *Kosmoceras (Gulielmiceras)* spp., *Kosmoceras* spp. s.l., the belemnite *Cylindroteuthis* and the bivalves *Meleagrinella*, *Oxytoma* and *Gryphaea (Bilobissa)* has been observed.

The adoption of this fixed juvenile mode of life has led to peculiarities in the hinge area in many young individuals, the commonest being the blurring of the distinction between the resilifer and bourrelets, and an overall lengthening of the ligamental area. As growth proceeded and the gryph-shape acquired the ligament area develops normally.

The probable explanation for this dimorphic population is that the individuals were reacting to environmental stresses, the high number of examples with large attachment areas being due to the greater number of potential post-larval settlement sites. The fact that the substrate, being much richer in shells and shell fragments, was likely to have been harder and more coherent than the silty sands of the Kellaways Beds or the mud of the Oxford Clay, may also have meant that it was necessary to remain attached to a stable area for a longer part of post-larval development, not only for stability, but also for protection from predators capable of breaking smaller shells.

Bottom turbulence may also have been greater, necessitating the growth of a thicker shell before the free-living stage could be assumed.

Similarly-shaped ecomorphs may be collected from the clay facies throughout the Lower Oxford Clay, and may be interpreted as being ecologically equivalent to the forms in the transition beds at the base of the Oxford Clay. In the clay facies, however, the dominant form is rather small and flat, and often encrusts other shells or fragments of wood. Characteristically, the left valves (which are much less common than right valves) have a large xenomorphic attachment area, occupying up to 50% of the external surface of the valve, the remainder of the valve being gently cup-shaped; the larger size of the attachment area prevented the acquisition of the true gryph-shape with enrolled umbones. In form many of these left valves agree closely with similar valves found in the shell beds. As in the transition beds forms, the right valves are generally flat or gently concave in outline, sometimes with faint radial striae, and often bear a large positive xenomorphic mould of the substrate. In a few rare cases a truly gryph-shaped individual developed, showing the strong posterior sulcus and relatively loose coiling of *G. (B.) dilobotes*, but these are exceptional. The dominant form of oyster in the bulk of the Lower Oxford Clay is a flattened, non-gryphaeate form of *G. (B.) dilobotes*, truly gryphaeate oysters not reappearing in the English Oxford Clay until the Middle *athleta* Zone (Upper Callovian), with the appearance of *G. (B.) lituola* Lamarck.

Phillips (1829, pl. 6, fig. 1) applied J. Sowerby's name to a form found in the 'Kellaway Rock' (= Hackness Rock?) of Hackness, Yorkshire. The specimen, claimed to be in the Yorkshire Museum, seems to be lost, and so it is not possible to tell whether this belongs to *G. (B.) dilobotes* or *G. (B.) lituola*. The horizon (*athleta* Zone, if Hackness Rock is correct) suggests the latter. If this is so, the likelihood is that the figure represents a bilobate form of that species close to *G. (B.) dilobotes*. Arkell (1932, p. 160) placed Phillips' specimen in *G. dilatata*, but the horizon is too low, and the form far too bilobate.

Lissajous (1912), Couffon (1919) and Cossmann (1924) separated the Callovian species of *Gryphaea* from *G. dilatata*, but overlooked the name *bilobata*, and referred it instead to *G. bullata* J. Sowerby, a non-lobate species from the Kimmeridge Clay. Krenkel (1915, pl. 25, figs. 36, 38) figured two right valves with good xenomorphic attachment areas.

The characters measured in *G. (B.) dilobotes* and the other species of *Gryphaea* are shown in Text-fig. 25 and are largely self-explanatory, although they differ from the parameters used by Hallam (1968) and Hallam & Gould (1975). As in all other bivalves, length is measured parallel to the hinge axis, and most other orientations are related to this basic parameter. *Hi* is measured from the tip of the umbo (the apex of the resilifer) to the ventral margin, and gives a measure of how much of the umbo is dorsal to the hinge line. *HMS*, measured from the hinge line to the ventral margin of the adductor scar, gives the location of the adductor scar, and is easily measured, as the ventral margin of the scar is raised above the general shell surface. Angle θ , measured from the tip of the resilifer to the most anterior and posterior points of the shell gives a measure of elongation, and angle α , measured from the resilifer tip to the posterior margin and the posterior radial sulcus, gives a measure of the development of the posterior flange. Lengths of the bourrelets and resilifer are taken parallel to the hinge margins, and height of the resilifer perpendicular to it. Study of the measurements table above shows the great variability of all the main characters, the most variable ones being height, inflation and development of the posterior flange; but apart from a tendency for young forms to be higher and have weaker flanges, systematic variation is not obvious.

Three species of *Gryphaea* (*Bilobissa*) may be recognized in the British Oxford Clay, *G. (B.) dilobotes* in the Kellaways Beds and lowermost Oxford Clay, *G. (B.) lituola* in the Middle Oxford Clay, and *G. (B.) dilatata* in the Upper Oxford Clay. Their status has been confused, and it was not until 1932 that Arkell clarified the differences between *G. (B.) lituola* and *G. (B.) dilatata*, with a passing reference to *G. (B.) bilobata*. All three species are extremely variable in all their characters, but it is nevertheless possible to distinguish specimens of each, although distinction

is more suitably carried out on large populations. The differences may be considered under several headings:

(a) *Size*. *G. (B.) dilatata* attains a very large size (up to 198 mm H), gerontic specimens becoming very high, and with great extension of the ligament. Both *G. (B.) lituola* and *G. (B.) dilobotes* attain an approximately equal length (*c.* 80 mm), but *G. (B.) lituola* tends to be slightly higher (H up to 150%).

(b) *Shape*. All three species have a posterior flange, which affects the gross shell outline to varying degrees, being most marked in *G. (B.) dilobotes* and least in *G. (B.) dilatata*. Disregarding gerontic specimens, *G. (B.) dilatata* may be distinguished by its low height (90–106%) from *G. (B.) dilobotes* (89–145%, \bar{x} 115%) and *G. (B.) lituola* (102–128%, \bar{x} 116%), and also by its low inflation, 20–50%, compared with 28–88% (\bar{x} 58%) in *G. (B.) dilobotes* and 54–77% (\bar{x} 66%) in *G. (B.) lituola*. As is obvious, *G. (B.) dilobotes* and *G. (B.) lituola* cannot easily be separated using these criteria. In overall shape, *G. (B.) dilatata* tends to be wide and flat, with the posterior flange usually only weakly developed, and the umbones not strongly incurved, often forming about a right angle to the plane of the commissure. The low degree of inflation and low prominence of the umbones may be seen from the fact that *Hi* is only slightly less than height. *G. (B.) dilobotes* and *G. (B.) lituola* are similar in shape, being subtrigonal in outline and well inflated, but the umbones of *G. (B.) lituola* tend to be more incurved than those of *G. (B.) dilobotes*, even when terminated by a large attachment area. The shell of *G. (B.) lituola* is also thicker, and the commissural platform better developed and more extensive, with consequent elongation of the ligament area perpendicular to the hinge axis.

(c) *Posterior flange*. The position and degree of development of this feature is the most useful in separating the three species. As the sequence *dilobotes* – *lituola* – *dilatata* is traced stratigraphically upwards, the posterior flange moves posteroventrally and widens, so that in typical forms of *G. (B.) dilobotes*, the flange is placed high on the posterior margin and forms a well-differentiated, relatively small, triangular feature; the posterior radial sulcus rarely reaches more than two-thirds of the way to the ventral margin. *G. (B.) lituola* is characteristically not as markedly bilobate (although strongly bilobed individuals do occur), the posterior radial sulcus reaching almost to the ventral margin, and marking off a poorly-differentiated posterior flange which is not well-separated from the body of the shell, but is still roughly triangular in form. Finally, in *G. (B.) dilatata*, the posterior radial sulcus usually extends all the way to the ventral margin, the posterior flange is not well differentiated from the body of the shell, and tends to be subrectangular or subovate in outline.

(d) *Ligament*. In the loosely coiled *G. (B.) dilobotes*, the ligament area on the left valve tends to be low and poorly developed, even in very large ($L > 80$ mm) specimens. The tighter coiling seen in *G. (B.) lituola* necessitates continuous growth of the ligament area in a direction perpendicular to the hinge axis, giving a very high ligament, even in small specimens. The same is true of *G. (B.) dilatata*, although the reason seems to be slightly different; after the attainment of "adult" stage (at a height of about 115 mm) growth proceeds mainly by accretion of shell at the ventral margin, and so in order to maintain equilibrium in the substrate, and allow the valves to open, the ligament attachments must also move ventrally, and so a very high, often parallel-sided ligament area is formed. Elongation of the ligament is more marked in *G. (B.) dilatata* than in *G. (B.) lituola*, and is accompanied by the development of a very wide commissural platform.

The problem of homoeomorphy in oysters is relevant here, as although it is simple to separate the three species above when large populations are examined, the occurrence of some specimens of *G. (B.) lituola* which are markedly bilobate may lead to difficulties in the interpretation of small samples. The recognition of these three distinct species with certainty requires populations of at least 10 specimens to make allowances for intra-specific variation.

Range and occurrence. Abundant in the the Kellaways Beds (*calloviense* Zone) and basal Oxford Clay (*medea* Subzone, *jason* Zone of England. Equivalent levels (sometimes ranging a little higher when the lithology is favourable) in France, Germany and Poland.

2. *Gryphaea (Bilobissa) lituola* Lamarck, 1819. Pl. 8, figs. 2–3, 5–7. Pl. 9, fig. 11819 *Gryphaea lituola* sp. nov., Lamarck, p. 199.1822 *Gryphaea dilatata* J. Sowerby; Young & Bird, p. 239, pl. 10, fig. 4.1860 *Gryphaea dilatata* J. Sowerby; Damon, pl. 3, fig. 7.1910 *Gryphaea lituola* Lamarck; Cossmann, no. 201.1932 *Gryphaea lituola* Lamarck; Arkell, p. 170, pl. 19, figs. 2, 3.1975 *Gryphaea dilatata lituola* subsp. nov. [*sic!*], Hallam & Gould, p. 515, pl. 19, figs. 10e–f.

Holotype. Lamarck collection, MHNP R 50383; figured Cossmann, 1910, No. 201; from the Middle Oxford Clay of France.

Measurements.

Left valve												
	L	H	I	AL	L.lig	H.lig	Lab	Lpb	HMS	Hi	θ	α
N	13	13	13	10	2	4	2	2	4	13	13	13
\bar{x}	69.9 mm	116.3%	66.3%	49.4%	12.8%	21.7%	7.1%	7.6%	53.2%	93.3%	102.7°	27.7°
Max	75.7	128.4	77.3	56.4	15.2	26.5	7.7	8.6	58.1	100.2	118	46
Min	43.5	102.9	54.4	42.6	10.4	14.7	6.5	6.5	45.3	87.1	88	20
OR	32.2	25.5	22.9	13.8	4.8	11.8	1.2	2.1	12.8	13.1	30	26
	L.lig (all) N4 \bar{x} 28.5 Max 31.2 Min 26.7 OR 4.5											
	L.add.scar N4 \bar{x} 17.9 Max 21.5 Min 14.7 OR 6.8											
	H.add.scar N4 \bar{x} 19.8 Max 24.2 Min 16.1 OR 8.1											
Right valve												
N	2	2	—	2	1	2	1	1	2	2	2	—
\bar{x}	51.1 mm	101.5%	—	46.9%	16.3%	18.3%	8.4%	8.2%	57.1%	101.5%	95.5°	—
Max	52.2	107.3	—	47.5	16.3	21.5	8.4	8.2	63.0	107.3	98	—
Min	49.9	95.6	—	46.3	16.3	15.0	8.4	8.2	51.1	95.6	93	—
OR	2.3	11.7	—	1.2	0	6.5	0	0	11.9	11.7	5	—
	L.lig (all) N2 \bar{x} 30.6 Max 32.5 Min 28.7 OR 3.8											
	L.add.scar N2 \bar{x} 17.2 Max 17.6 Min 16.8 OR 0.8											
	H.add.scar N2 \bar{x} 15.8 Max 17.6 Min 14.0 OR 3.6											

Description. Large species (up to 115 mm high), of rather variable form, subtrigonal to subovate in outline, rarely markedly rostrate, with variably developed posterior radial sulcus and flange; posterior radial sulcus reaching about 80–90% of the way to the ventral margin. Height always greater than length, often very much so, giving high, subtrigonal shells which are slightly wider than in *G. (B.) dilobotes*. Very inequivalve, left valve strongly convex, often markedly incurved in umbonal region; right valve flat or slightly concave, suborbicular to subovate in outline, seldom very bilobate. Umbones prominent, rounded, inflated, slightly opisthogyrate, often strongly incurved and generally terminated by an attachment area of variable size, reflected xenomorphically on right valve. Anterior margin slightly concave to slightly convex, depending on prominence of umbones, curving smoothly into evenly-rounded ventral margin with no angulation; posterior margin variably produced into a posterior flange, usually weakly developed, not clearly separated from body of shell by generally faint posterior radial sulcus; posterior radial sulcus and flange best developed in wider specimens, which tend also to be less incurved. Surface of left valve with irregular concentric growth squamae, not as coarse as in *G. (B.) dilatata*, with radial elements rare; right valve ornament similar, but radial striae are better developed, especially in umbonal region.

Adductor muscle scar posterior to mid-axis, placed subcentrally between dorsal and ventral margins, or slightly closer to ventral margin, suborbicular to subovate in outline, its ventral margin often slightly elevated above inner surface of shell, with subconcentric growth lines. Quenstedt muscle scar rarely seen, very small, located immediately beneath posterior bourrelet in left valve, as it is in right valve, but not obscured by it. Commissural shelf narrow, developed only in dorsal regions, more strongly developed on posterior side; commissural platform well developed, becoming flattened in very large specimens, but usually sloping towards shell interior. Ligament area of left valve tending to become elongated perpendicular to hinge axis, due to

greater incurving of umbones, with distinction between resilifer and bourrelets becoming faint, often assuming a slight twist posteriorly; ornamented by concentric growth-lines. Ligament area of right valve flattened, clearly triangular in outline, with little differentiation of resilifer and bourrelets; ventral margin produced into shell interior as a ligamentary buttress; sometimes with slight posterior twist.

Remarks. This Middle Oxford Clay species often has been referred to *G. dilatata* but there can be no doubt that it is specifically distinct from both that species and *G. (B.) dilobotes*. Arkell (1932, p. 170) clarified the nomenclatural position, and resurrected the name *lituola* for these Middle Oxford Clay forms. He also placed a specimen figured by Damon (1860, pl. 3, fig. 7) as "*G. dilatata*" in the synonymy of both *G. dilatata* and *G. lituola*. Damon's figure shows a relatively high, narrow form, viewed from the right, which could represent a narrow form of *G. (B.) dilatata* or a "normal" form of *G. (B.) lituola*. In the absence of the specimen, which has not been traced, no definite conclusion may be made. The main distinction is that *G. (B.) lituola* is narrower and more inflated than *G. (B.) dilatata*, with the posterior radial sulcus reaching only 80–90% of the way to the ventral margin.

G. dilatata of Young & Bird (1822, p. 239, pl. 10, fig. 4) is recorded from the "hard sandstone at the foot of Scarborough castle", presumably a reference to the Kellaways or Hackness Rock, and so is likely to be a specimen of either *G. (B.) dilobotes* or *G. (B.) lituola*. Their figure is of a faintly sulcate form resembling *G. (B.) lituola*, but in the absence of the specimen, its identity is uncertain.

As with *G. (B.) dilobotes*, there is a good deal of variation in *G. (B.) lituola*, some forms closely resembling "typical" forms of the former species, but when the population as a whole is considered, the Upper Callovian species is clearly distinct from *G. (B.) dilobotes* on account of its less strongly flanged nature, the flange extending farther towards the ventral margin, greater degree of incurvature and narrower outline. A characteristic of *G. (B.) lituola*, and often also *G. (B.) dilatata*, is the occurrence of an epifauna of serpulids, foraminifera, bryozoa and oysters, attached to the exterior and occasionally the inner surfaces of the valves. It is probable that at least some of these epizoic elements, notably the foraminifera and bryozoa, lived at the same time as the oysters. In view of the lack of these epizoic elements on specimens from the more organic-rich shales and clays of the Lower Oxford Clay and Kellaways Beds, it is likely that their distribution is related to environment rather than to host specificity.

Range and occurrence. Middle Oxford Clay, *athleta* to *lamberti* zones of England; from Woodham, Stewartby and Wolvercote (Oxford). Argile de Dives, Calvados (France) from rocks of similar age. ? Hackness Rock and Corallian Beds (Arkell 1932, p. 171).

Subfamily EXOGRINAE Vyalov, 1936

Genus **NANOGYRA** Beurlen, 1958

(Synonym: *Palaeogyra* Mirkamalov, 1963)

Type species. Original designation; Beurlen 1958, p. 206; *Gryphaea nana* J. Sowerby, 1822 p. 114, pl. 383; Kimmeridge Clay of Oxfordshire.

Diagnosis. Small, inequivalve, very variable in shape and form; left valve globular to moderately convex, suborbicular or subtrigonal in outline, or elliptical to ovate; all specimens spirally twisted to variable degree. Left valve unequally bilobate in some specimens, due to spiral groove which reaches valve margin dorsal of branchitellum. Right valve flat, gently concave or gently convex, suborbicular to subovate in outline, comma-shaped, auriform or lingulate at branchitellum; left valve with fine radial ribs or rough concentric growth squamae, often with growth halts; right valve with few marginal growth squamae, except along anterior margin, which has many crowded upturned growth squamae. Spiral umbones of left valve coil tightly over ligament area, largely obscuring it; ligamental area variably spiralled, anterior and posterior bourrelets of approximately equal length, the posterior wider than anterior.

Remarks. Beurlen (1958) separated the Jurassic and Cretaceous Exogyrinae into *Nanogyra* and

Exogyra, believing the former to be the most primitive member of the Exogyrinae, and transitional between *Liostrea* and *Exogyra*. The spiral groove on the left valve of some specimens of *Nanogyra* was thought to be homologous to that of *Gryphaea*, suggesting that the Exogyrinae had their origins in the Gryphacinae. *Nanogyra* may be distinguished from *Exogyra* by its small size, low degree of spirality of the left valve, lack of commissural shelf covered with vermiculate chomata, and equality of size of the bourrelets. The overall taxonomic position of *Nanogyra* and other members of the Exogyrinae was discussed by Stenzel (1971, p. N1115) and Pugaczewska (1971, p. 220).

Nanogyra nana (J. Sowerby, 1822) Pl. 9, figs. 2-5

1822 *Gryphaea nana* sp. nov., J. Sowerby, p. 114, pl. 383.

1829 *Gryphaea mima* sp. nov., Phillips, pl. 4, fig. 6.

1853 *Exogyra auriformis* (Goldfuss); Morris & Lycett, p. 5, pl. 1, fig. 7 (*non* Goldfuss).

1932 *Exogyra nana* (J. Sowerby); Arkell, p. 175, pl. 17, figs. 2-21; pl. 18, figs. 3-11; pl. 19, figs. 4, 4a. (Full description of British material).

1948 *Exogyra nana* (J. Sowerby); Cox & Arkell, p. 20.

1952 *Exogyra nana* (J. Sowerby); Cox, p. 92, pl. 10, figs. 2-4.

1965 *Exogyra nana* (J. Sowerby); Cox, p. 73, pl. 11, figs. 5, 6a, 6b.

1971 *Nanogyra nana* (J. Sowerby); Pugaczewska, p. 281, pl. 1, figs. 3-5, 7; pl. 2, figs. 1-4; pl. 24, figs. 1-6; pl. 25, figs. 1-7; pl. 26, figs. 1-6; pl. 27, figs. 1-6.

Lectotype. Designated Arkell 1932, p. 180; J. Sowerby 1822, pl. 383 (left figure); BM 43340c. Kimmeridge Clay of Shotover Hill, near Oxford.

Measurements.

L	11.2 mm	HMS	11.9 mm
H	18.7	L. lig.	1.3
I	2.5	H. lig.	0.9
AL	11.2		

Description. A single right valve with elliptical outline, tapering ventrally, height considerably greater than length; dorsal margin evenly and convexly curved into approximately semicircular shape, passing smoothly into straight to very gently convex anterior margin; ventral margin sharply rounded, narrower than dorsal margin, without posteroventral or anteroventral angles; anterior margin straight to gently sinuate; umbones small, very strongly opisthogyrate, terminal on posterior margin. Shell flattened, very thin, the anterior margin thickened, with a series of steeply-stepped growth squamae sweeping round from umbo to its middle part; posterior margin thin, tapered. External ornament of faint subconcentric growth squamae, with no marked growth halts. No xenomorphic imprint of attachment area seen.

Ligament area very short, height slightly less than length, anterior and posterior bourrelets very short, approximately equal in length; ligament area with concentric growth lines; umbonal tip overhanging apex of ligament area. Adductor muscle scar slightly crescentic, concave towards dorsal margin, placed much nearer hinge than ventral margin, its ventral margin slightly elevated above body of shell interior; muscle scar located about halfway between anterior and posterior margins. Slight commissural shelf along anterior margin. Quenstedt muscle scar not visible.

Remarks. This specimen agrees exactly with the abundant specimens from the Corallian Beds and Kimmeridge Clay of Britain. Its occurrence in a *Grammatodon* shell-bed suggests that, during a pause in sedimentation, spat was able to settle in an area outside its usual habitat, although a new population did not develop.

Pugaczewska (1971, p. 281) described the variation in over 500 individuals. Cox's (1952, 1965) records of *N. nana* from India and East Africa show how geographically widespread this species must have been, as it is also known from all over Europe and parts of Russia (Pugaczewska 1971, p. 285).

Range and occurrence. Bathonian to Portlandian of Great Britain, most of western Europe and parts of Russia, India, Asia and Africa. The specimen recorded here is from the *grossourei* Subzone (Middle Callovian) of Calvert.

Subclass PALAEOHETERODONTA Newell, 1965

Order TRIGONIOIDA Dall, 1889

Superfamily TRIGONIACEA Lamarck, 1819

Family TRIGONIIDAE Lamarck, 1819

Genus **MYOPHORELLA** Bayle, 1878

Type species. Subsequent designation; Crickmay 1932, p. 458; *Myophorella nodulosa* Bayle 1878, pl. 120, figs. 1, 2, 6 (= *Trigonia nodulosa* Lamarck 1801, p. 117); Oxfordian of France.

Diagnosis. Trigonally ovate to oblong in outline, strongly inequilateral, anterior margin fully and evenly curved, posterior margin rostrate to a varying extent; posterior area clearly separated from body of shell, with different ornament pattern; marginal carina obtuse, not separated from ornamented part of valve by a smooth band; escutcheon shallow; area divided by variably developed median carina, ornamented usually by concentric striae; flanks of shell bearing rows of tubercles or tuberculate costae, usually oblique, but occasionally subconcentric.

Subgenus **MYOPHORELLA** s.s.

(Synonyms: *Haidaia* Crickmay, 1930; *Scaphotrigonia* Crickmay, 1930;

Clavotrigonia Lebküchner, 1933; *Clavitrighonia* Leanza, 1942;

Promyophorella Kobayashi & Tamura, 1955)

Diagnosis. Area transversely ridged or smooth, never with radial ornament; escutcheon smooth; costae on flanks may be uninterrupted throughout growth in some species, or discontinuous and broken up anteriorly in later growth stages in others.

Remarks. Crickmay (1932) designated Bayle's figure of *Myophorella nodulosa* as representing the type species of *Myophorella*, believing that it was not the same as *Trigonia nodulosa* Lamarck. Favre (1876), in refiguring Lamarck's holotype, showed it to belong to the same species as that figured by Bayle in his plate 120, figs. 1, 2, 6. There has been a good deal of confusion concerning the type species of several genera of trigoniids; for some time, *T. nodulosa* was accepted as the type of *Trigonia* s.s., until an ICZN ruling (Opinion 327) confirmed *Venus sulcata* Hermann as the type of that genus. Cox (1952) gave a clear summary of the problem of trigoniid nomenclature.

1. **Myophorella (Myophorella) irregularis** (Seebach, 1864) Pl. 9, figs. 13–17; Pl. 10, figs. 1, 3, 4, 6; Text-fig. 26

1860 *Trigonia clavellata* J. Sowerby; Damon, pl. 2, fig. 3 (non J. Sowerby).

1864 *Trigonia irregularis* nom. nov., Seebach, p. 117 (*pro Trigonia clavellata* Damon non J. Sowerby).

1872 *Trigonia irregularis* Seebach; Lycett, p. 39, pl. 5, figs. 1a, 1b, 2; pl. 7, fig. 6.

non 1877 *Trigonia irregularis* Seebach; Lycett, p. 39, pl. 39, fig. 3.

1879 *Trigonia irregularis* Seebach; Mansell-Pleydell, p. 117, pl. 2, fig. 3.

Neotype. Designated herein; GSM 11423; figured Lycett 1872, pl. 5, figs. 1a, 1b; Oxford Clay of Weymouth, Dorset.

Measurements. (Text-fig. 26)

	L	H	I	AL	LE	LA	EW	Number of tubercle rows
N	30	30	30	29	28	29	30	29
\bar{x}	61.1 mm	71.1%	41.5%	23.6%	55.1%	85.9%	20.1%	12.9
Max	88.0	78.9	52.5	33.9	61.5	95.8	25.4	16
Min	26.5	64.7	33.8	17.4	46.4	81.4	15.0	9
OR	61.5	14.2	18.7	16.5	15.1	14.4	10.4	7

Description. Large species, elongate-oval to subtrapezoidal in outline, rostrate, well inflated, equivalve, inequilateral; umbones situated within anterior third of shell, prominent, small, pointed, opisthogyrate, contiguous, only slightly salient to hinge margin. Anterior margin gently convex, anteroventral angle varying from a sharply rounded right angle to an even curve; ventral margin evenly and gently convex, often sinuate posteriorly; posteroventral angle sharp,

about a right angle, posterior margin biconvex, median carina forming an obtuse angle of $c. 135^\circ$ where it meets posterior margin; posterodorsal angle sharp, obtuse, $c. 125^\circ$, marking posterior limit of gently to markedly concave posterodorsal margin; central part of the escutcheon, along dorsal margin, usually protrudes slightly above outline of posterodorsal margin to form a slight convexity in the outline. On extreme anterior part of valves, perpendicular to plane of commissure, is a narrow smooth band, up to $c. 5$ mm wide, separating anterior ends of tubercle rows from commissure; a more prominent smooth band, up to 10 mm wide, extends from umbones to posteroventral angle, anterior to marginal carina, separating posterior ends of tubercle rows from marginal carina. Flanks of shell have 9–16 rows of clavellate tubercles, varying in regularity, with young forms (up to $c. 55$ mm L) often showing no irregularity in tubercle arrangement, and having only subconcentric tubercle rows, meeting marginal carina at $c. 90^\circ$; larger specimens often show great irregularity of tubercle arrangement, tubercle rows being sinuous or indistinct, with intercalatory half-rows in anterior region; some large specimens show a more regular arrangement

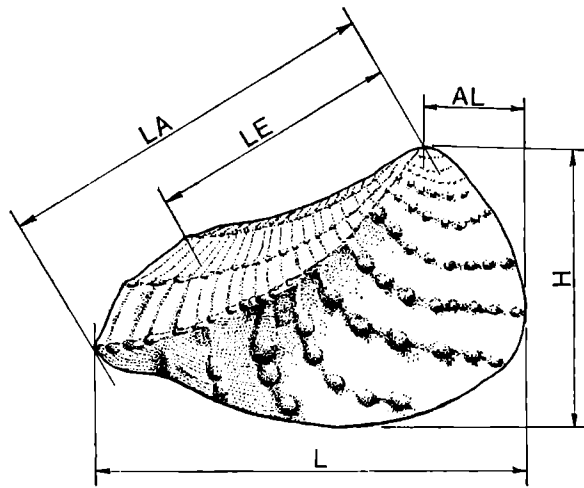

TEXT-FIG. 26. External view of a right valve of *Myophorella* (*Myophorella*) *irregularis* (Seebach), from the Oxford Clay of Weymouth, Dorset (YM 906), showing the measurements used in the description of trigoniids. **AL** = anterior length; **H** = height; **L** = length; **LA** = length of the area; **LE** = length of the escutcheon.

of tubercle rows, similar to that in younger specimens. Tubercles themselves increase in size with age, usually $c. 8$ – 9 per row; they also tend to rise straight from the flanks of the shell, and are not usually placed on distinct, elevated tubercle rows. Marginal carina strong, concave in outline, ridge-like, topped at regular intervals by varices elongated along growth lines; median carina and escutcheon carina similarly ornamented, varices being strongest on escutcheon carina; there is very little tendency for the varices to get weaker posteroventrally; median sulcus shallow; area usually flat, oblique, with strong concentric ribs in the 10 mm nearest umbones, these ribs then fading rapidly, leaving remainder of area covered in irregularly-spaced concentric growth lines, giving a slightly imbricate appearance; these growth lines continue onto flanks of shell, and affect even tubercles. Escutcheon elongate, lanceolate, wide, deeply biconcave to almost flat, but always with median part, along the commissure, elevated; proximally is a prominent, lanceolate external ligament, with strong nymphs.

Dentition normal for Trigoniacea, dental formula

$$\begin{array}{ccc} 5a & 3a & 3b \\ \hline 4a & 2 & 4b \end{array}$$

with 2 large, bifid, 4b and 5a short, lamellar, and 3a, 3b, and 4a long and ridge-like, all cardinal teeth bearing clearly-marked vertical crenulations. Adductor muscle scars subequal, posterior scar subovate and slightly larger than subelliptical anterior scar, posterior scar more deeply impressed, especially along its anterior margin; posterior scar placed posteroventrally of end of hinge plate, separated from it by small, suborbicular posterior pedal retractor scar; anterior adductor scars placed immediately anterodorsal to anterior end of 3a, and below end of 4a (Text-fig. 27).

Three short ridges on inner surface of rostrum mark positions of escutcheon, median and marginal carinae on exterior, and serve to divide rostrum into two areas, probably corresponding to siphon positions. Pallial line entire.

Remarks. The exact horizon of the type specimen, and the numerous specimens labelled "Oxford Clay, Weymouth" is unknown; no examples have been collected in the area for nearly a century due to obliteration of the exposures, notably those at Radipole Backwater. As all the

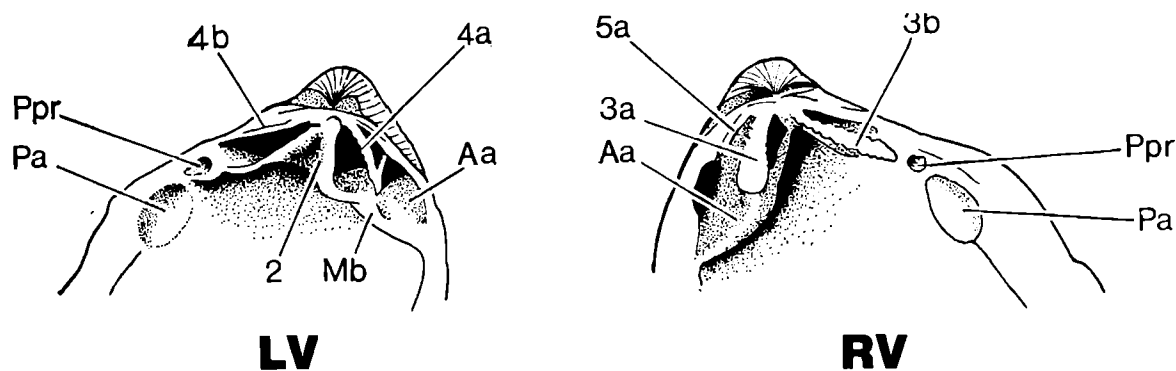

TEXT-FIG. 27. Internal views of the left and right valves of *Myophorella*, showing details of the musculature and the cardinal plate. After Cox (1952, p. 47), $\times 1$. **Aa** = anterior adductor scar; **Mb** = myophoric buttress (fused with 3a in the right valve); **Pa** = posterior adductor scar; **Ppr** = posterior pedal retractor scar.

zones of the Oxford Clay above the *lamberti* Zone which are still well exposed in the cliffs of Weymouth Bay and the Fleet Backwater do not yield any specimens of *M. irregularis*, it seems probable that the specimens came from the Callovian Oxford Clay. Furthermore, the 1 in. Geological Survey Map (Sheet 342) shows that most of Radipole Backwater is situated on the lower part of the Oxford Clay. The *athleta*, *coronatum* and part of the *jason* zones are exposed in the brickyard at Crook Hill, Chickerell, and again have not yielded any specimens of *M. irregularis*. The only record of this species from this area in recent times is that of Arkell (1947, p. 27) from the Kellaways Beds (*koenigi* subzone) of Putton Lane Brickyard, Chickerell, and this is a juvenile (SM J47645). Hence it is still not possible to locate the horizon from which the numerous topotypes of *M. irregularis* came, although the weight of evidence suggests the lower parts of the Oxford Clay, or the Kellaways Beds.

The records of *M. irregularis* given by Cox (in Cunnington, 1925, p. 197) and Arkell (1932a, p. 45) refer to specimens found in the beach of the West Fleet shore, about 1 mile west of Langton Herring, Dorset, supposedly with other fossils of Callovian age. However, Arkell later (1940, p. 44) showed that the fauna was in fact of Fuller's Earth (Bathonian) age, and that the trigoniids belonged to *M. scarburgensis* (Lycett).

March (1911, p. 9) studied the development of ornament of some clavellate Upper Jurassic trigoniids and concluded that in *M. irregularis* it was ecologically controlled, and that the species should be considered a variety of *M. clavellata*. In view of the many obvious morphological distinctions between these two species, and their clearly separated stratigraphic levels, this opinion is not accepted here.

The specimen figured by Lycett (1877) from the Kimmeridge Clay of Wootton Bassett bears superficial resemblance to *M. irregularis*, but the tubercle rows are too regular and there are too many tubercles per row for it to belong here. No specimens of *M. irregularis* have been seen from the Kimmeridge Clay.

M. irregularis, like other trigoniids, is notable for the variation which may be found within a population; this variation is most obvious in the ornament pattern, but may also be noted in the shape of the shells. Most adult shells (over *c.* 55 mm L) show the distinctive posterior rostrum, with the variably reflexed posteroventral margin, but in younger specimens, this feature is not generally as well seen. This lack of a prominent rostrum makes it difficult to identify juvenile specimens of *M. irregularis*, the only distinction being that the ribbing on juveniles of this species tends to be a little more regular than in species such as *M. scarburgensis*.

The major change in ornament seems to take place at about the same time as the rostrum develops (L 55 mm), when there is a change from regular subconcentric rows of tubercles to irregular rows with sinuous outlines and intercalatory half-rows. Infrequently, specimens of large size are found with simple tubercle rows, although many specimens show only a slight sinuosity near the anterior margin. At the other extreme are forms such as that figured by Damon (1860, pl. 2, fig. 3), where the tubercles have attained a very large size, and the subconcentric basic pattern has been almost totally obliterated.

In the description above, the teeth have been numbered, in accordance with the Bernard convention, on the assumption that all the teeth are cardinals. However, Ohdner (1918) suggested that the teeth of Trigoniacea may in fact represent both cardinals and laterals, and introduced a modified system of notation, whereby the dental formula would be

$$\begin{array}{ccc} 3a & 1 & 3b + PI \\ \hline 2a & 2b & PII \end{array}$$

As yet, there is no conclusive evidence either way, and Cox (1969b, p. N471) refrained from using dental formulae for Trigoniacea for this reason. Both formulae have been given here; the former is the one which has been used more frequently in the past. Newell & Boyd (1975) suggested that in order to avoid confusion caused by differing views of the homologies of teeth, it would be better to use a modified Steinmann notation, and advocated using capital letters to indicate major dental elements, and lower case letters to indicate minor but persistent elements. A small "n" would represent the ligament nymph. Thus Newell & Boyd's hinge formula would be:

	Posterior	Anterior
Right valve	n o 1 0 1 0	
Left valve	n i 0 0 1	

M. irregularis may be easily distinguished from its close stratigraphical neighbours *M. scarburgensis* (Lycett) and *M. caytonensis* sp. nov. on the basis of its rostrate form and the way in which the tubercles rise straight from the flanks of the shell. There are apparently no certain records of it from the European continent, although *Trigonia* aff. *irregularis* has been recorded from the Callovian (Wohlegemuth 1883) and Oxfordian (Klüpfel 1919) of France, without having been figured.

Range and occurrence. The type material comes from the "Oxford Clay of Weymouth", (probably Callovian); Kellaways Beds (*koenigi* Subzone) of Putton Lane brickpit, Chickerell, Weymouth (SM J47645); Oxford Clay, horizon unknown, of Loudon, Wiltshire (Hudleston Collection, GSM Y2078-2080); Oxford Clay, horizon unknown, of Trowbridge, Wiltshire (GSM Y2014); Oxford Clay, horizon unknown, of Chippenham, Wiltshire (GSM Y2027). Lower Oxford Clay, *jason* Zone, *medea* Subzone, Stewartby, Bedfordshire; *coronatum* Zone, *obductum* Subzone, Marston Moretaine, Beds., and *coronatum* Zone, *grossouvrei* Subzone, Calvert, Buckinghamshire.

2. **Myophorella (Myophorella) caytonensis** sp. nov. Pl. 10, figs. 2, 10; Pl. 11, figs. 1, 81872 *Trigonia rupellensis* d'Orbigny; Lycett, p. 28, pl. 8, fig. 4 (*non* d'Orbigny).1877 *Trigonia rupellensis* d'Orbigny; Lycett, p. 199, pl. 36, figs. 1-4 (*non* d'Orbigny).*non* 1915 *Trigonia rupellensis* d'Orbigny; Krenkel, p. 312, pl. 27, fig. 16 (*non* d'Orbigny).*non* 1929 *Trigonia rupellensis* d'Orbigny; Cottreau, p. 85, pl. 54, fig. 1.?1934 *Trigonia clavellata* J. Sowerby; Stoll, p. 10, pl. 1, fig. 18 (*non* J. Sowerby).1972 *Myophorella rupellensis* (d'Orbigny): Walker, p. 124, pl. 8, fig. 20 (*non* d'Orbigny).

Holotype. SM J11377; figured Lycett 1872, p. 28, pl. 8, fig. 4; Kellaways Rock of Cayton Bay, Scarborough, Yorkshire.

Measurements.

	L	H	I	AL	LE	LA	EW	TR
N	18	18	17	18	16	17	14	17
\bar{x}	64.5 mm	79.6%	46.4%	31.2%	59.2%	87.2%	18.4%	13.9 ribs
Max	88.0	86.4	66.7	45.2	75.5	96.7	23.3	17
Min	29.5	70.0	36.5	19.2	51.0	79.2	9.1	10
OR	58.5	10.4	30.2	26.0	24.5	17.5	14.2	7

Description. Large species, equivalve, inequilateral, umbones usually placed within anterior third of shell; subtrigonal to elongate oval in outline, not rostrate. Umbones prominent, small, pointed, contiguous, opisthogyrate, salient *c.* 2 mm above hinge margin. Inflation variable. Posterodorsal margin straight to gently concave, markedly concave anteriorly, where umbones protrude above it, and sometimes with a small convexity where the central part of the escutcheon stands out along the commissure; posterodorsal angle obtusely rounded, *c.* 150°, passing into gently convex and oblique posterior margin; posteroventral angle rounded, obtuse, *c.* 120°, passing into evenly convex ventral margin; no posterior sinuosity in ventral margin; anterior margin very gently convex, meeting ventral margin either in an evenly rounded curve, or rounded angle of *c.* 90°. Marginal carina long, concave in outline, taking the form of an elongate ridge with occasional well-marked subconcentric varices on some specimens; median carina faint, with very poorly-developed varices, median sulcus obscure; escutcheon carina strong, ridge-like, with well-developed tubercular varices. Area long, flat to gently convex in section, sometimes becoming slightly concave in proximal regions, oblique to flanks of shell at an angle of *c.* 135°. Escutcheon elongate, narrow, lanceolate, biconcave in section, rising to high point along commissure, greatest elevation being just posterior to the end of ligament nymphs; ligament up to 15 mm long, narrow, lanceolate, opisthodontic, nymphs strong; both area and escutcheon with concentric growth lines, often coarsened on the area to give an imbricate appearance; the proximal 10 mm of the area with strong concentric ribs, fading distally.

Flanks of shell with 10-17 rows of rounded clavellate tubercles *c.* 12 in number, rows tending to be raised on ribs, rather than rising straight from the flanks of the shell; approximately the first 6 tubercle rows simple and subconcentric in form, the rest sinuate and very irregular, often falcate, anterior part of each row relatively straight, then swinging posteroventrally before it curves back towards marginal carina; posterior part of each tubercle row abruptly reflected towards marginal carina, meeting it at an angle of *c.* 130°; anteriorly, intercalatory half-rows of tubercles are often present; anterior parts of the tubercle rows not coalesced into ribs. Where ribs meet anterior margin, they are not paired, but interdigitate.

Remarks. The figuring by Cottreau (1929, pl. 54, fig. 1) of the holotype of *T. rupellensis* d'Orbigny revealed that Lycett's conception of the species was not correct. Thus, Lycett's species is in need of renaming, and *M. caytonensis* is introduced here. D'Orbigny's species came from the 'Corallien' (actually the *cymodoce* Zone of the Lower Kimmeridge Clay) of La Rochelle, France, and is a densely-ribbed form with a wide, smooth band between the marginal carina and the posterior end of the tubercle rows. It is more correctly placed in *Laevitrigonia* Lebküchner.

Lycett's figures show the great variation in form and ornamentation present in this species, as do the measurements (above), which reveal that many characters (I, AL, LE) have a range of over 20%. In form, there is gradation from subtrigonal forms, such as the holotype, through more elongate forms, to a markedly elongate form such as that figured by Lycett (1877, pl. 36, fig. 4; GSM 11439); this form variation is independent of overall size. In ornament, there is a gradation from relatively regularly-tuberculate forms, with subparallel tubercle rows (e.g. the holotype) to forms with very irregular ribbing, such as Lycett's pl. 36, fig. 2 (GSM 11437) and fig. 3 (GSM 11438), where the subparallel nature of the tubercle rows is lost, and where there are several intercalatory half-rows of tubercles.

The specimen figured by Krenkel (1915, pl. 27, fig. 16) as *T. rupellensis* is certainly a *Myophorella*, but is probably to be placed in *M. scarburgensis* rather than *M. caytonensis*, as the tubercles are coalescent over much of the anterior part of the shell, and the tubercle rows do not reflect upwards to the marginal carina. Krenkel's figure agrees closely with Lycett's figure of the holotype of *T. scarburgensis* (1863, p. 48, pl. 37, fig. 1). Krenkel believed that *T. scarburgensis* and *T. rupellensis* Lycett (*non* d'Orbigny) were synonymous, but study of populations of topotypes of each species reveals that this is not so, *T. scarburgensis* having the anterior tubercles in each row joined together in a rib, lacking the posterior reflection of the ribs towards the marginal carina, and tending to have different ornament patterns on each valve. There is also a stratigraphic discrepancy, *M. scarburgensis* ranging from the Cornbrash down to the Fuller's Earth, while *M. caytonensis* appears to be restricted to the Yorkshire Kellaways Rock.

T. clavellata Stoll (*non* J. Sowerby), from the Middle Callovian of Pomerania (Stoll 1934, pl. 1, fig. 18) is poorly figured, and not described, but displays several similarities to *M. caytonensis*, in which it is tentatively placed. The specimens figured by Walker (1972, pl. 8, fig. 20) as *M. rupellensis*, from the Kellaways Rock of South Cave, Humberside, agree closely with topotypes of *M. caytonensis*, and I assign them to that species. I therefore consider Walker's statement (1972, p. 125) that typical specimens from the South Cave area are indistinguishable from Krenkel's figure of *T. rupellensis* (= *M. scarburgensis*) to be misleading.

M. caytonensis seems to be restricted to the Kellaways Beds (*calloviense* Zone) of Humberside and Yorkshire, abundant material being available at Cayton Bay, and less well-preserved specimens occurring in the South Cave area. Presumably this may represent an ecological effect, *M. caytonensis* only being found in more arenaceous sediments. Its place in the more argillaceous Kellaways Beds to the south is taken by *M. irregularis*.

Range and occurrence. Kellaways Rock (*calloviense* Zone), Cayton Bay, Scarborough, Yorkshire; *calloviense* Zone Kellaways Rock of South Cave Station Quarry and South Newbald Quarry, Humberside. ?Middle Callovian of north Germany (Stoll, 1934).

Subclass HETERODONTA Neumayr, 1884

Order VENEROIDA Adams & Adams, 1858

Superfamily LUCINACEA Fleming, 1828

Family LUCINIDAE Fleming, 1828

Subfamily MYRTEINAE Chavan, 1969

Genus DISCOMILTHA Chavan, 1952

Type species. Original designation; Chavan 1952, p. 95; *Discomiltha oehlerti* Bigot MS in Chavan 1952, p. 95, pl. 4, figs. 38-40; Sables Astartiens (Upper Oxfordian) of Cordebugle, Calvados, France.

Diagnosis. Moderately large, suborbicular, flattened, of low inflation; sculpture of well-spaced feeble concentric ribs and finer striae; posterior area well-marked; lunule very asymmetrical, narrow, long, larger in left valve than right; ligament projecting, inframarginal; hinge teeth comprising only two weak cardinals, partly obscured by lunular expansion; shell interior punctate and grooved; anterior adductor muscle scars elongate, narrow, distant from pallial line; shell margin smooth internally.

Remarks. Chavan (1969, p. N492) divided the Lucinidae into three subfamilies, the Lucininae, Myrteinae and Milthinae, on the basis of shell thickness and outline, and length of the anterior adductor muscle scars. The Myrteinae are characterized by thin, more or less quadrangular or transverse shells, of moderate inflation, and with medium-sized anterior adductor scars, usually divergent from, and within, the pallial line.

The good preservation of several specimens of *Lucina lirata* Phillips from the *grossouvrei* Subzone (*coronatum* Zone) of Calvert shows that this species belongs in *Discomiltha*, by virtue of its external form and ornament, the length of the narrow anterior adductor muscle scar, and the pustulose nature of the shell interior. Particularly characteristic is the obliquely truncate posterior margin of *Discomiltha*, with a variably developed indentation in the posteroventral margin marking the position of the posterior radial sulcus.

Superficially, *Discomiltha* resembles *Saxolucina* Stewart, a member of the Milthinae. Although there are close similarities in ornament, outline, and details of the musculature, *Saxolucina* has more clearly developed teeth (2 and 3b often being bifid), together with traces of anterior laterals; the asymmetry of the lunule is reversed in *Saxolucina*, the right valve bearing the larger part. Several other genera of Lucinidae, such as *Monitilora* Iredale, *Plastomiltha* Stewart and *Gardnerella* Chavan are also internally pustulose, but may be distinguished from *Discomiltha* by their shorter anterior adductor scars, and differences in dentition. The presence of internal pustules on the shell is of uncertain significance, but is of great taxonomic value at generic level, as very few genera possess these features, and those which do are confined to the Myrteinae and Milthinae; no Lucininae with pustules are known.

Discomiltha lirata (Phillips, 1829) Pl. 9, figs. 6–12

- 1829 *Lucina lirata* sp. nov., Phillips, p. 140, pl. 6, fig. 11.
 non 1830 *Lucina lirata* Phillips; Zieten, p. 84, pl. 63, fig. 1 (non Phillips; = *Lucina zietenii* d'Orbigny).
 non 1843 *Lucina lyrata* Phillips var. *transversa* nov., d'Archiac, pl. 26, figs. 3a, 3b (non *Lucina lirata* Phillips; non *Lucina transversa* Bronn, 1831) [= *Lucina bellona* d'Orbigny].
 1934 *Lucina lirata* Phillips; Arkell, p. 278, pl. 41, figs. 1–3, 7.

Neotype. Designated herein; BM LL10077; figured Arkell 1934, p. 278, pl. 41, fig. 7; Hackness Rock of Scarborough, Yorkshire.

Measurements.

	L	H	I	AL
N	18	18	7	9
\bar{x}	34.2 mm	90.9%	39.8%	51.3%
Max	47.0	98.4	45.4	58.1
Min	21.6	80.1	35.1	46.3
OR	25.4	18.3	10.3	11.8

Description. Large species, equivalve, inequilateral, suborbicular to subrectangular in outline, with umbones submedian, small, fairly prominent, pointed, prosogyrate, salient *c.* 2 mm above dorsal margin. Anterodorsal margin gently concave, variably produced, passing either evenly, or via a rounded anterodorsal angle, into evenly convex anterior margin; occasionally, anterior margin more nearly straight, in which case anterodorsal angle is more marked; fully rounded anterior margin passes smoothly into more gently convex ventral margin, with no perceptible anteroventral angle; at its posterior end, ventral margin becomes slightly more convex, and meets rounded, but prominent, posteroventral angle, the latter often being marked by a clear indentation caused by posterior radial sulcus meeting posterior margin; in some specimens, the sulcus is very weak, and posteroventral angle very ill defined, ventral and posterior margins then curving more smoothly into one another; posterior margin straight to gently convex, occasionally very slightly concave, obliquely truncate, meeting posterodorsal margin in a rounded obtuse angle;

posterodorsal margin straight to gently convex. Posterior area, bounded by variably developed posterior radial sulcus, usually clearly developed, and takes the form of an obliquely flattened region between umbo and posteroventral angle; often ornament becomes slightly coarsened on posterior area, the concentric lamellae being strengthened and slightly elevated. Remainder of shell exterior with irregularly developed narrow concentric lamellae, spaced *c.* 1·5 mm apart, separated by wider interspaces containing concentric growth striae; in Lower Oxford Clay specimens, lamellae not well developed, only slightly coarser than growth lines, giving a more even pattern of ornamentation; no radial elements present on shell exterior.

Dorsal areas well differentiated, prominent. Lunule small, elongate, narrow, sharply bounded by two carinae, asymmetrical, part of lunule on left valve wider than that on right. Escutcheon absent, obscured by external ligament, which occupies the whole of posterodorsal margin between umbo and posterodorsal angle, and is deeply inset into dorsal margin.

Dentition unknown. Anterior adductor muscle scar elongate, narrow, arcuate, parallel-sided, reaching about two-thirds of the way to ventral margin; placed within pallial line, from which it diverges markedly; posterior adductor muscle scar subovate, elongated dorsoventrally, located mostly within posterior area, sometimes crossing posterior sulcus, reaching into body of shell; pallial line entire, lacking a pallial sinus, although there is often a slight reflection where the pallial line crosses the posterior radial sulcus. Shell interior within pallial line strongly pustulose, with a faint radiating pattern. Inner shell margin smooth, lacking marginal denticulations.

Remarks. The holotype of *Lucina lirata* Phillips was stated by Etheridge (*in* Phillips 1875, p. 326) to be in the Phillips collection. It is not, however, in YM, OUM, BM, SM or GSM, and is considered lost. The figure of the holotype (Phillips 1829, pl. 6, fig. 11) is rather stylized, and shows a specimen with a much more oblique posterodorsal margin than is normal, since the many topotypes available show that Phillips exaggerated the truncation of the posterior margin. The most variable features of this species are the elongation and the degree of prominence of the anterior part of the shell, which are often related; frequently the most elongate specimens have rather inflated and produced anterior regions, the more suborbicular specimens being not nearly so anteriorly produced, although a few elongate but not anteriorly-inflated examples occur. Inflation is not as variable as height, and appears to be unrelated to degree of elongation; it is also the most difficult parameter to measure, as most of the specimens occur as disarticulated valves. Maximum inflation always occurs in the middle regions of the shell, never on the produced anterior regions.

The modes of preservation found in *D. lirata* make study of the dentition and dorsal regions very difficult, and as yet no specimens showing the teeth have been seen. Lacking the dentition, it is difficult to place this species with certainty, but the presence of the pustules and the elongation of the anterior adductor scar make it most likely that it belongs in *Discomiltha*. Comparison of the Lower Oxford Clay specimens with the type species of *Discomiltha* shows that there are many close similarities, and so they are provisionally placed in this genus.

Arkell (1934, p. 278) has shown that the Bathonian species *Lucina bellona* d'Orbigny (= *L. lyrata* d'Archiac *non* Phillips) is closely related to *D. lirata*, but differs in being more elongate, less protuberant at the anterior part of the ventral margin, and having shorter and wider anterior adductor scars.

The Callovian to Oxfordian species *Lucina rotundata* (Roemer), common in the arenaceous facies of the Callovian at Brora, and throughout the Oxfordian of Britain and northwest Europe, differs from *D. lirata* in its greater inflation (I 50–63%), its rounded posterior margin without a posterior sulcus, and its ornament style, lacking the concentric lamellae; in general outline, it is much more rounded and globose than *D. lirata*.

Range and occurrence. Throughout the Lower Oxford Clay of central and southern England, although it is only abundant locally in some of the condensed shell-beds; *calloviense* to *athleta* zones; Hackness Rock of Scarborough, Yorkshire; abundant throughout the British Corallian Beds (see Arkell 1934, p. 278).

Superfamily CRASSATELLACEA Férussac, 1822

Family ASTARTIDAE d'Orbigny, 1844

Subfamily ASTARTINAE d'Orbigny, 1844

Genus **NEOCRASSINA** Fischer, 1886

nom. subst. *pro* *Crassinella* Bayle, 1878, *non* Guppy, 1874)

(Synonyms: *Puschia* Rouillier & Vossynski, 1847; *Pruvostiella* Agrawal, 1956)

Type species. Subsequent designation; Dall 1903, p. 1487; *Astarte obliqua* Deshayes 1830, p. 80 (= *Cypricardia obliqua* Lamarck 1819, p. 29); Bajocian of western France.

Diagnosis. Ovate to subtrapezoidal in outline, inequilateral, often with umbones pointed and slightly produced; concentric ribs developed in umbonal regions, fading in adults, leaving merely strong growth lines. Hinge formula:

AI	3a	3b	PI
AII	2	4b	PII

with trigonal cardinals and strong posterior laterals; ligament nymph broad and flattened. Marginal denticulation present or absent.

Remarks. Bayle (1878) introduced *Crassinella* to accommodate the Jurassic to Lower Cretaceous astartids with two trigonal cardinals and a strong posterior lateral tooth in each valve. The name *Neocrassina* was substituted by Fischer (1886) as Guppy had introduced *Crassinella* four years earlier as a genus of Recent Crassatellidae.

There is, however, some confusion over the type species of the genus, as it is uncertain whether Dall's subsequent designation referred to *Astarte obliqua* Deshayes (which some authors believe to be a junior synonym of *A. modiolaris* Lamarck), or to *Cypricardia obliqua* Lamarck, which was transferred to *Astarte* by Deshayes. Likewise, it is not clear on which *obliqua* species Fischer based his interpretation of *Neocrassina*. Accordingly, the type species information is presented here as given by Chavan and the problem is to be the subject of a submission to be made by the author to the ICZN.

Subgenus **PRESSASTARTE** Zakharov, 1970

Type species. Original designation; Zakharov 1970, p. 103; *Astarte trembiasensis* de Loriol 1901, p. 69, pl. 4, figs. 24–26; Oxfordian of the Jura Bernois.

Diagnosis. Shell small, subrectangular, planar, with sharp beak; lateral teeth AI and AII distinct, narrow, tooth AI sometimes united with 3a; lateral teeth PIII and PII distinct, narrow and elongate; cardinal teeth 3b and 2 strongly projecting, 4b more weakly narrow.

Remarks. *Pressastarte* was introduced by Zakharov, as a subgenus of *Neocrassina*, to include those small, very compressed species with a strongly denticulate margin. It is distinguished from *Neocrassina* (*Lyapinella*) Zakharov (1970, p. 113) by being much smaller and more compressed, having a much reduced umbonal cavity; PIV less differentiated from the nymph; and the lunule less excavate. *Neocrassina* (*Coelastarte*) Böhm is also closely related, but *Pressastarte* may be distinguished by its more posteriorly placed lateral tooth (PII), together with a less excavate lunule and a less penetrating escutcheon.

The shell of *Pressastarte* is often thick and heavy, with a wide hinge plate (as in *N. (P.) ungulata*), but in other species, such as *N. (P.) calvertensis*, it is much thinner and has a narrow hinge plate.

1. ***Neocrassina (Pressastarte) ungulata*** (Lycett, 1863) Pl. 10, figs. 5, 7–9, 11; Pl. 11, figs. 2, 3; Text-fig. 28

1829 *Astarte lurida* sp. nov., Phillips, pl. 5, fig. 2 (*non* J. Sowerby, Upper Lias species).

1863 *Astarte ungulata* nom. nov., Lycett, p. 72, pl. 35, fig. 20 (*pro Astarte lurida* Phillips *non* J. Sowerby).

1934 *Astarte ungulata* Lycett; Arkell, p. 244.

1948 *Astarte ungulata* Lycett; Cox & Arkell, p. 26.

Holotype. SM B10715; figured Lycett 1863, p. 72, pl. 35, fig. 20; Cornbrash of Yorkshire.

Measurements.

	L	H	I	AL
N	10	10	3	8
\bar{x}	16.7 mm	95.3%	40.3%	37.9%
Max	21.2	110.1	44.4	42.3
Min	13.8	85.6	32.9	32.0
OR	7.4	25.5	11.9	10.3

Description. Medium-sized species, inequilateral, umbones small, prosogyrate, pointed, variably produced, placed about one-third of the length behind anterior margin; outline suborbicular with length approximately equal to height and umbones not prominent, to subquadrate with length about 10–15% greater than height and umbones rather produced. Anterior margin almost straight to slightly concave, curving smoothly into continuously rounded anterior and ventral margins; posterodorsal margin gently convex, posterodorsal angle obtusely rounded; posterior margin subtruncate and gently convex in subquadrate individuals passing into ventral margin via prominent rounded posteroventral angle, or evenly rounded and passing into ventral margin without a posteroventral angle in suborbicular forms. Inflation variable, usually low and mostly due to the thickness of the valves, rather than to enlargement of the shell cavity. Ornament consists of up to 13 strong concentric ribs, separated by sulci approximately equal in width to ribs; ribs fade out *c.* 7 mm from umbones, and only faint, irregularly spaced concentric growth lines remain; very occasionally coarser growth lines develop in ventral regions to form one or two ribs. Lunule elongate, extending almost to anterodorsal angle, narrow, lanceolate in outline, obliquely flattened and only slightly depressed; escutcheon elongate, lanceolate, reaching almost to posterodorsal angle, obliquely flattened and external.

Cardinal plate heavy and wide, cardinal teeth elongate and subparallel (Text-fig. 28); dental formula:

	AI	3a	3b	PI	
AII		2	4b		PII

with AII and PI forming the dorsal margin; 3b, 2, 4b elongate, trigonal, narrow; 2 and 4b subparallel; 3a shorter and more oblique; laterals laminar, PI and PII placed well behind the nymph. Nymph broad and flattened, ligament suture placed along dorsal margin.

Adductor muscle scars placed immediately beneath ends of cardinal plate, subequal; posterior slightly larger and subrectangular, anterior subelliptical; anterior pedal retractor muscle scar very small, subovate, placed on ventral slope of cardinal plate, just posterior of anterior adductor; posterior pedal retractor scar subovate, placed on ventral slope of cardinal plate immediately beneath cardinal tooth 2. Pallial line entire. Margin denticulate.

Remarks. The relationships of the Upper Jurassic species of *Pressastarte* are complex in view of the great amount of variation which may be present in each species, and it is advisable to work with populations rather than with individuals. *N. (P.) ungulata* shows the normal wide range of variation in outline, but all specimens are characterized by the wide cardinal plate with elongate cardinal teeth (Text-fig. 28), which serves to distinguish it from *N. (P.) calvertensis*. The holotype of *N. (P.) ungulata* is suborbicular in outline, but topotypes reveal that this is merely one morphotype, and that more subquadrate forms, similar to those figured by Phillips (1829, pl. 5, fig. 2) from the *mariae* Zone Oxford Clay of Scarborough, also occur (e.g. GSM 113012). Syntypes of *Astarte lurida* Phillips (not of J. Sowerby) (YM 873) show that a similar range of variation occurs in the Yorkshire Oxford Clay specimens. They are preserved as composite clay steinkerns, with details of the exterior and interior superimposed; specimens such as these show the denticition quite clearly, revealing the presence of a wide cardinal plate and elongate cardinals (e.g. SM

J26767–68). The dentition is best seen in BCM Cb8877, from the Oxford Clay of Trowbridge, Wiltshire.

Some small specimens of *N. (P.) striatocostata* (Münster in Goldfuss), with which should be grouped the type species of the subgenus, *N. (P.) trembiazensis* de Loriol, are very near *N. (P.) ungulata*, as Makowski's (1952, p. 10) figures show. This Continental species may, however, be distinguished from *N. (P.) ungulata* by its consistently smaller size (up to 13.5 mm L), and more pointed and prominent umbones, which give a marked concavity to the posterior part of the lunule. The length-height relationships are also different, the height of *N. (P.) striatocostata* slightly exceeding the length.

Astarte philea d'Orbigny and *A. pelops* d'Orbigny (figured in Cottreau 1927, pl. 46, figs. 1, 2 and 3, 4 respectively) resemble *N. (P.) ungulata* in their suborbicular outline and low inflation, but were placed by Arkell (1934, p. 241) in the synonymy of *Astarte nummus* Sauvage. All three names apply to an Oxfordian species, which may be distinguished from *N. (P.) ungulata* by its tendency to have ribbing all over the shell surface.

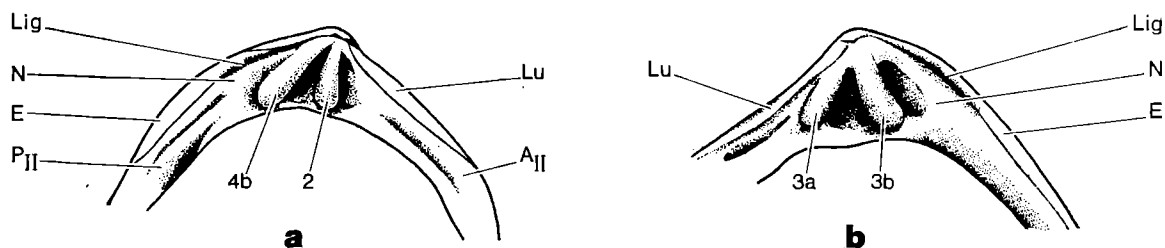

TEXT-FIG. 28. The hinges of left (a) and right (b) valves of *Neocrassina (Pressastarte) ungulata* (Lycett), from the Kelloways Rock of Trowbridge, Wiltshire (BCM Cb8878 and 8876), showing the broad hinge plate, with elongate cardinal teeth, $\times 4$. E = escutcheon; Lig = ligament; Lu = lunule; N = nymph.

Range and occurrence. Cornbrash of Yorkshire, "Kelloway Rock" (= Hackness Rock) of Scarborough, Yorkshire; widespread in parts of the Oxford Clay, of Trowbridge and Chippenham (BCM Cb8876–80), Fairford, Gloucestershire (BU 14708), and the *mariae* Zone of Scarborough, Yorkshire (numerous specimens). Also in the *lamberti* Zone (?) of Lukow, Poland.

2. ***Neocrassina (Pressastarte) calvertensis*** sp. nov. Pl. 11, figs. 4–7, 9–11; Text-fig. 29
1975 *Neocrassina (Neocrassina)* sp. nov.; Duff, p. 446.

Holotype. BM LL27730; Lower Oxford Clay, *jason* Zone and Subzone, of Calvert, Buckinghamshire.

Measurements.

	L	H	I	AL
N	7	7	4	6
\bar{x}	16.7 mm	90.7%	28.0%	36.0%
Max	20.7	96.9	37.3	43.5
Min	13.8	88.3	19.3	26.8
OR	6.9	8.6	18.0	16.7

Description. Medium-sized species of variable outline, but usually suborbicular, with small, prosogyrate, pointed, slightly salient umbones, or subovate with slightly more prominent umbones; most commonly subovate, slightly elongate, with a more concave anterodorsal margin; anterodorsal margin straight to gently concave, concavity greatest in more elongate forms; anterodorsal angle rounded, obtuse, passing evenly into continuously rounded anterior and ventral margins; ventral margin almost straight to evenly convex in outline, dependent upon elongation; posterodorsal margin gently convex, passing into truncate or gently convex posterior margin

via obtuse posterodorsal angle which is very clearly developed in elongate forms; posteroventral angle obsolete. Umbones small, pointed, hardly protruding above general level of shell outline, situated about one-third of the length behind anterior margin. Inflation low, mostly due to the thickness of the valves rather than to inflation of shell cavity. Ornament of 8–10 concentric ribs in umbonal region, fading into concentric growth lines *c.* 5 mm from umbones; rest of shell only with these growth lines. Lunule and escutcheon elongate, lanceolate, shallow, only slightly depressed, reaching to the anterodorsal and posterodorsal angles respectively.

Cardinal plate narrow and slight, cardinal teeth short and peg-like; dental formula:

AIII	AI	3a	3b	PI
AII		2	4b	PII

with 3a + 3b and 2 + 4b short and divergent; AI, PI, AII and PII laminar. AII and PII placed along dorsal margin, allowing overlap of opposite valve margin, PI and PII placed well behind the nymph (Text-fig. 29). Nymph relatively wide (but not as wide as in *N. (P.) ungulata*) and flattened, ligament suture located along dorsal margin. Musculature as in *N. (P.) ungulata*, pallial line entire. Margin denticulate.

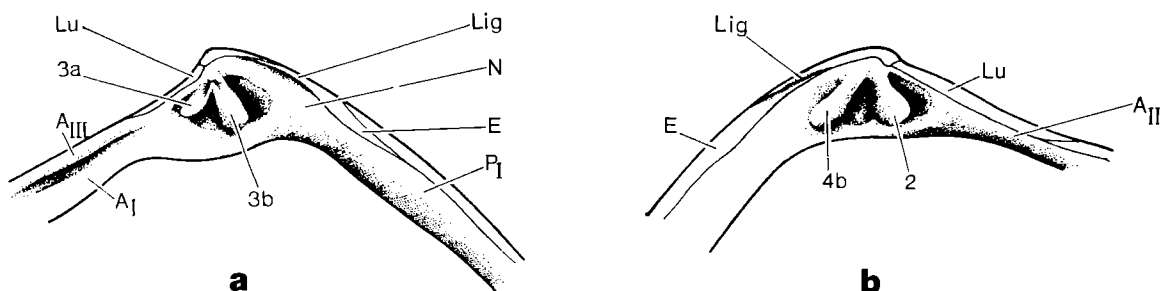

TEXT-FIG. 29. Internal views of the right (a) and left (b) valves of *Neocrassina (Pressastarte) calvertensis* sp. nov., from the *jason* Zone and Subzone of Calvert, Bucks., showing details of the cardinal plate. Note the narrower, thinner hinge plate, with shorter, more peg-like cardinal teeth than in *N. (P.) ungulata*, $\times 6$. **E** = escutcheon; **Lig** = Ligament; **Lu** = lunule; **N** = nymph.

Remarks. All individuals of this species possess a narrow hinge plate with short, peg-like cardinal teeth (Text-fig. 29). Comparison with *N. (P.) ungulata* shows that the latter species also differs in having a higher number of concentric ribs in the umbonal region, fading into growth lines at about 8 mm from the umbo, as compared with 5 mm in *N. (P.) calvertensis*. No comparable forms of *Pressastarte* with a narrow hinge plate are known.

Range and occurrence. Restricted to around the Kellaways Rock to Lower Oxford Clay junction, being known from the *enodatum* Subzone of Stewartby and the *jason* Subzone of Bletchley and Calvert.

Genus **NICANIELLA** Chavan, 1945

Type species. Original designation; Chavan 1945, p. 43; *Astarte communis* Zittel & Goubert 1861, p. 201, pl. 12, figs. 2–4; Oxfordian of France.

Diagnosis. Small, trigonal to trapezoidal in outline, with moderately prominent umbones; ornamented by regular concentric ribs anteriorly and on flanks of shell, but fading posteriorly and ventrally. Lunule and escutcheon broad and well-defined. Hinge with small and strong cardinals, with 3a variably present; laminar laterals. Nymph short and narrow. Inner margin crenulated.

Remarks. In *Nicaniella* s.l., cardinal tooth 3a is variably developed, and frequently absent. On many occasions this has led to confusion, with forms possessing 3a being separated from those

in which it is absent. However, Chavan (1945, p. 45; 1952, p. 60) has shown that the absence of 3a is caused by the lunule overgrowing the more dorsally-placed hinge teeth, and thus it cannot be used as a reliable taxonomic feature in this group.

Subgenus **TRAUTSCHOLDIA** Cox & Arkell, 1948

Type species. Original designation; Cox & Arkell 1948, p. 27; *Astarte cordata* Trautschold 1860, p. 347 (*nom. nov., pro Astarte cordiformis* Rouillier 1846, pl. D, figs. 15a-g, *non* Deshayes); Upper Jurassic of Galiowa, Russia.

Diagnosis. Small, subtrigonal to suborbicular in outline, very inflated, globose, umbones high, inflated, often produced to give a cordate appearance; ornament of regular concentric ribs, often with concentric growth lines superimposed on them and on intervening sulci; ornament not fading posteriorly and ventrally; inner margin usually crenulate; lunule cordiform, escutcheon lanceolate, both broad and well-defined; hinge formula:

AI	AIII	3a	3b	5b	PIII
AII		2	4b	PII	PIV

with laminar laterals and short stout cardinals.

Remarks. Cox & Arkell (1948, p. 27) introduced *Trautscholdia*, as a subgenus of *Astarte*, giving an adequate diagnosis except for the nature of the dentition, which was stated to be of "normal astartid type". However, the type species of *Astarte*, *A. sulcata* da Costa (a Recent species) lacks cardinal tooth 3a, which tooth is well-developed in *Trautscholdia*. The presence of a strong 3a in *N.* (*Trautscholdia*) is due to lack of overgrowth of the hinge plate by the lunule, in contrast to the situation usually seen in *Nicaniella* s.s. This led Chavan (1969, p. N567) to remove *Trautscholdia* from *Astarte*, and place it as a subgenus of *Nicaniella*.

1. **Nicaniella (Trautscholdia) carinata** (Phillips, 1829) Pl. 11, figs. 12-17, 23, 24

1829 *Astarte carinata* sp. nov., Phillips, pl. 5, fig. 3.

non 1850 *Astarte carinata* Phillips; Morris, p. 317, pl. 30, figs. 2-2e (= *Nicaniella (Trautscholdia) phillis*).

non 1860 *Astarte carinata* Phillips; Damon, pl. 2, fig. 4 (= *Nicaniella (Trautscholdia) phillis*).

Holotype. YM 876; figured Phillips 1829, pl. 5, fig. 3; Upper Oxford Clay (*mariae* Zone) of Scarborough, Yorkshire.

Measurements.

	L	H	I	AL	Number of ribs
N	5	5	1	3	9
\bar{x}	5.0 mm	93.2%	87.8%	41.6%	9.4
Max	9.1	96.3	87.8	43.9	12
Min	6.6	88.1	87.8	38.1	8
OR	2.5	8.2	0	5.8	4

Description. Small species, inequilateral, suborbicular to subtrigonal in outline, globular, with umbones moderately prominent (occasionally very prominent), slightly prosogyrate, variably salient above hinge line, submesial, inflated. Anterodorsal and posterodorsal margins straight to slightly concave, anteroventral and posteroventral angles clearly defined; ventral margin evenly rounded, often semicircular in outline, crenulate over its entire length. Dorsal areas not well seen, but both lunule and escutcheon well developed; ligament not seen. Ornament of 8-12 regularly-spaced sharp concentric ribs (most commonly 8-10) with fine concentric threads between. Variably developed umbonal carina runs from umbones to ventral margin, meeting margin just anterior of posteroventral angle. Dentition and musculature not known.

Remarks. The available material of *N. (T.) carinata* consists only of poorly preserved clay steinkerns in which it is not possible to make out any details of the dentition, ligament or musculature.

ture. Consequently the generic assignment of this species is based solely on external shape and its close resemblance to *N. (T.) phillis* (d'Orbigny).

The variation in form is large, although not as much material is available as for *N. (T.) phillis*, but it is nevertheless possible to distinguish the latter species by its greater number of tightly-packed ribs (12–21) and more elongate form ($H \bar{x}$ 81.7%). In *N. (T.) carinata* the umbones are often slightly produced, as in the holotype, although never as much as in *N. (T.) cordata* (Trautschold) and *N. (T.) mosae* (d'Orbigny). The relationships of the Upper Jurassic species of *Trautscholdia* with produced umbones are uncertain, and more material, from a wide geographical and stratigraphical range, is needed before definite conclusions may be drawn. It seems likely, however, that *N. (T.) mosae* is synonymous with *N. (T.) cordata*, although they come from slightly different horizons, the former from the Upper Callovian of France, and the latter from the Lower Oxfordian of Russia.

Range and occurrence. Common in Upper Oxford Clay (*mariae* Zone) of Scarborough, Yorkshire, and Middle and Upper Oxford Clay (*lamberti* to *mariae* zones) of Oxford; Oxford Clay (horizon unknown) of Radipole Backwater, Weymouth, Dorset (BM L20715).

2. **Nicaniella (Trautscholdia) phillis** (d'Orbigny, 1850) Pl. 11, figs. 18–22, 25–28; Pl. 12, figs. 1–4; Text-figs. 30–32

- 1850 *Astarte carinata* Phillips; Morris, p. 317, pl. 30, figs. 2–2e (*non* Phillips).
 1850 *Astarte phillis* sp. nov., d'Orbigny, p. 363, no. 253.
 1860 *Astarte carinata* Phillips; Damon, pl. 2, fig. 4 (*non* Phillips).
 ? 1875 *Astarte sawagei* sp. nov., de Loriol & Pellat, p. 96, pl. 15, figs. 33, 34.
 ? 1911 *Astarte sawagei* de Loriol; Boden, p. 64, pl. 6, figs. 18–18b, 19.
 1915 *Gouldia cordata* (Trautschold); Krenkel, p. 320, pl. 26, figs. 16–18 (*non* Trautschold).
 1919 *Gouldia cordata* (Trautschold); Couffon, p. 90, pl. 6, figs. 8–8e (*non* Trautschold).
 1927 *Astarte phillis* d'Orbigny; Cottreau, p. 49, pl. 46, figs. 6, 7.
 1952 *Astarte cordata* Trautschold; Makowski, p. 10, pl. 5, fig. 6.
 1972 *Astarte multiformis* Roeder; Walker, p. 127, pl. 8, figs. 11–17.
 1975 *Trautscholdia phillis* (d'Orbigny); Duff, pp. 446 *et seq.*

Holotype. MHNP 3669; figured Cottreau 1927, pl. 46, figs. 6, 7; Calcaire-blanc (Oxfordian) of Neuvizy, France.

Measurements.

	L	H	I	AL	Number of ribs
N	84	84	73	15	68
\bar{x}	8.7 mm	85.4%	77.2%	34.1%	14.8
Max	12.4	96.2	100.0	43.2	21
Min	4.8	69.9	56.6	26.9	10
OR	7.6	26.3	43.4	16.3	11

Description. Medium-sized species, inflated, equivalve, inequilateral, umbones placed slightly anterior of median; outline dominantly subtrigonal, with length considerably greater than height, but suborbicular forms, with length only just exceeding height, also occur. Umbones prominent, inflated, prosogyrate, salient up to *c.* 2 mm above hinge line, rounded in lateral profile. Anterodorsal margin slightly concave, posterodorsal margin slightly concave to slightly convex; anterodorsal angle sharply rounded, passing into evenly convex ventral margin; posterodorsal angle variably developed, a rounded obtuse angle passing evenly into the ventral margin in suborbicular forms, or a more sharply angular posterodorsal angle, passing into short truncate posterior margin, which passes into ventral margin via rounded posteroventral angle in elongate forms; in elongate forms a weak umbonal ridge tends to develop between umbones and posteroventral angle. Ligament nymph short but well-defined, located immediately above cardinal tooth 5b in right valve, and above and behind 4b in left. Lunule strongly developed, cordiform, deeply concave, its anterior extremity reaching virtually to anterodorsal angle; escutcheon lanceolate,

bounded by sharp escutcheon carina, extending to posterodorsal angle; lunule and escutcheon with fine concentric growth striae. Ornament of flanks of valve 12–21 regularly spaced concentric ribs, with faint concentric intercostal threads; ribs somewhat more tightly packed than in *N. (T.) carinata*, exact number varies between populations; spaces between ribs usually about three times as wide as ribs themselves. Margin denticulate in its entirety, denticulations extending to ends of lateral teeth.

Dental formula:

AI	AIII	3a	3b	5b	PIII	
AII			2	4b	PII	PIV

with paired laminar laterals posteriorly in left valve and anteriorly on right valve; 2 and 4b prominent, rounded, peg-like; 3a and 3b strongly developed, with 3b almost median, and strong

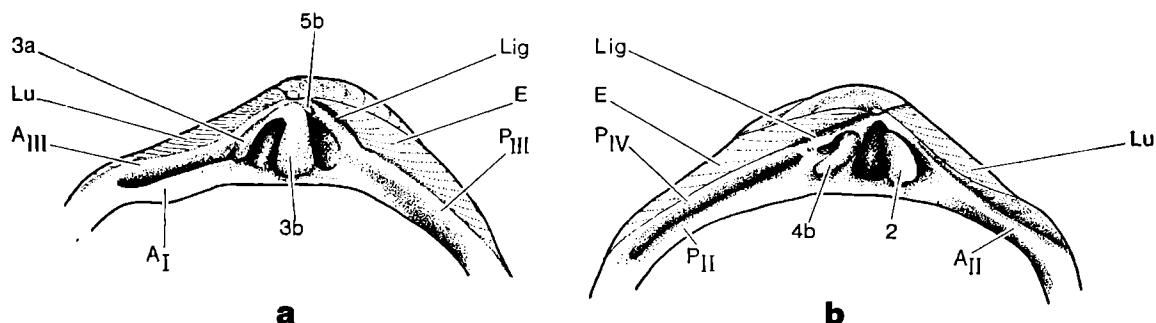

TEXT-FIG. 30. Internal views of the right (a) and left (b) valves of *Nicaniella (Trautscholdia) phillis* (d'Orbigny), from the Lower Oxford Clay of Wiltshire (GSM Zn2544) and the Kellaways Rock of Wiltshire (GSM 113422) respectively, showing the normal dentition for the species, with three cardinals in the right valve and two in the left valve, $\times 8$. **E** = escutcheon; **Lig** = ligament; **Lu** = lunule.

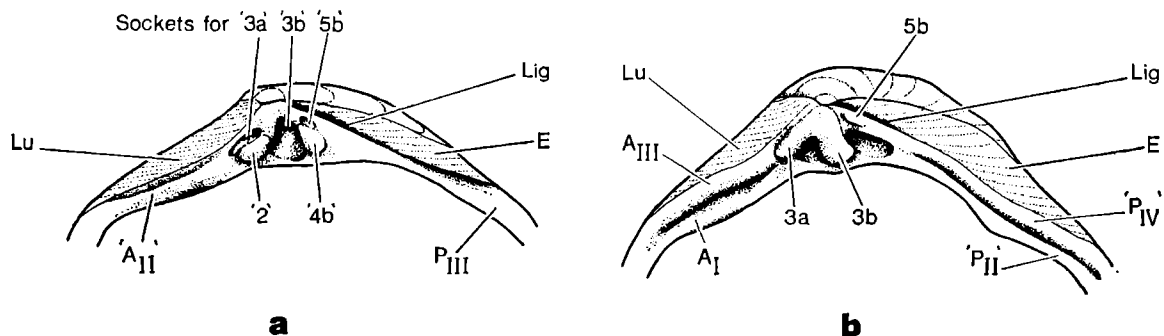

TEXT-FIG. 31. Internal views of two abnormal right valves of *Nicaniella (Trautscholdia) phillis* (d'Orbigny), from the Kellaways Rock of Wiltshire (GSM 113425) and the Lower Oxford Clay (*jason* Zone and Subzone) of Calvert, Bucks. (LU 69943) respectively. a. Transposition of the cardinal and anterior lateral teeth, with '2' and '4b' replacing the normal 3a and 3b, and "AII" replacing the normal AI and AIII. b. Transposition of the posterior lateral teeth, with 'PII' and 'PIV' replacing the normal PIII, $\times 8$. **E** = escutcheon; **Lig** = ligament; **Lu** = lunule.

3a reaching anteriorly from its dorsal margin, and 5b poorly developed, parallel to, and often fused with, shell margin (Text-fig. 30). Transposition of either the anterior laterals or the cardinals occurs occasionally (Text-fig. 31). Adductor muscle scars subequal, posterior slightly larger than anterior; posterior scar subquadrate, anterior scar elongate-elliptical; pallial line entire.

Remarks. The variation within this species is very great, as may be seen from the study of large populations, such as that collected from the basal shell-bed at Calvert. Although the dominant

form in that population is markedly elongate, suborbicular forms are fairly common, together with all intermediate stages, showing variation to be continuous; the variation in ribs is 13–19 in this population. Other populations of comparable age, from different localities, show a similar range of variation. For example, the small population from the Oxford Clay of Chippenham (GSM Y2066–2070; GSM 113419–113427) are of a similar shape to the Calvert population, but have fewer ribs, usually ranging from 12–15, with one specimen having 17 ribs. Variation may be well appreciated from the specimens figured here. In all populations of this species, the dominant shape is subtrigonal, with length considerably greater than height, and it is this feature, together with the consistently high rib density, that separates it from *N. (T.) carinata*. Regression lines for different populations of *N. (T.) phillis* (Text-fig. 32) show the similarity between all populations when their L/H and L/I ratios are considered.

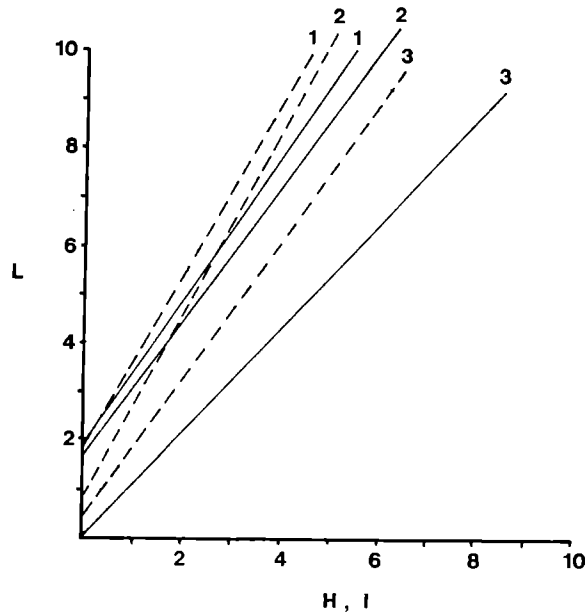

TEXT-FIG. 32. Comparison of the regression lines for various pairs of parameters in three populations of *Nicaniella (Trautscholdia) phillis* (d'Orbigny). Dashed lines represent Length/Inflation regression lines, and unbroken ones Length/Height regressions. Population 1 is from the Lower Oxford Clay of Calvert, Bucks; population 2 from the Kellaways Rock of Wiltshire (specimens in the GSM and SM); and population 3 also from the Kellaways Rock of Wiltshire (specimens in BCM). Note the close correspondence of the lines for each of these populations, and also the close grouping of the L/I and L/H lines, showing the similar growth rates of these two characters. Scale in mm.

Arkell (1934, p. 247) united *Astarte phillis* with *A. contejeani* de Loriol (1875 in de Loriol & Pellat, p. 92), and figured two specimens of the latter species from the Corallian Beds of Weymouth; however, the specimens figured by Arkell do not match the figures of the holotype of *N. (T.) phillis* given by Cottreau.

Astarte robusta Lycett (Holotype SM J5682; Cornbrash of Scarborough) is probably also referable to the subgenus *Trautscholdia*, and is superficially very similar to *N. (T.) phillis*, having 16–18 ribs, but differs in its more suborbicular outline, with length and height being approximately equal. *Astarte cordata* Trautschold has been misidentified several times (Krenkel 1915; Couffon 1919; Makowski 1952), their figures showing specimens identifiable as *N. (T.) phillis*. *A. cordata* is clearly distinct (Rouillier 1846, pl. D, figs. 15a–g), having very pronounced umbones.

Roeder (1882) discussed variation in *N. (T.) multiformis* (Roeder), and showed it to be an extremely polymorphic species in both form and ornamentation. It closely parallels the situation

seen in *N. (T.) phillis*, to which it must be closely related, but consistently differs by being much more orbicular, with length about equal to height. Arkell (1934, p. 239) suggested that this species might be synonymous with *A. extensa* Phillips.

Hinge transposition is fairly common in the Astartidae (Cox 1969, p. 57), Popenoe & Findlay (1933) noting that one specimen in 130 showed this phenomenon. There appears to be variation in the part of the hinge affected by transposition, Popenoe & Findlay (op. cit.) and Newell (1939) reporting that the cardinals and anterior laterals were transposed separately from the posterior laterals, supporting Bernard's observation that the anterior laterals and the cardinals develop from one lamella, and the posterior laterals from another, while Eggleton & Davies (1962) showed that of a population of the Recent freshwater genus *Sphaerium*, 18.5% showed transposition of the complete hinge. The specimens of *N. (T.) phillis* showing transposition of the dentition lend support to the observations of both Newell and Popenoe & Findlay, a right valve from the Oxford Clay of Chippenham (GSM 113425) showing transposition of the cardinals and anterior laterals (Text-fig. 31a), while a right valve from Calvert merely shows transposition of the posterior laterals (Text-fig. 31b). As a result the former has no laminar laterals on the right valve, whilst the latter has paired laminar laterals anteriorly and posteriorly.

Range and occurrence. Widespread in the Kellaways Rock of southern England, and in the transition beds between the Kellaways Rock and the Oxford Clay, in the *jason* Subzone at Calvert, the *medea* Subzone at Bletchley and Stewartby, and in the *medea* and *jason* subzones at Norman Cross; also rarely in the clay facies (*obductum* Subzone of Calvert, Stewartby and Norman Cross). Various horizons in the Callovian and Oxfordian of France, Germany, Poland and Russia.

Superfamily **CARDIACEA** Lamarck, 1809

Family **CARDIIDAE** Lamarck, 1809

Subfamily **CARDIINAE** Keen, 1951

Genus **PROTOCARDIA** von Beyrich, 1845

(Synonym: *Hassbergia* Krumbeck, 1939)

Type species. Subsequent designation; Herrmannsen 1847, p. 336; *Cardium hillanum* J. Sowerby 1813, p. 41, pl. 14, upper figure; (see Text-fig. 33); Blackdown Greensand (Cretaceous, Albian) of England.

Diagnosis. Subquadrate to subovate, umbones subcentral; posterior slope with radial ribs, not usually spinose, remainder of shell ornamented by concentric ribs; hinge long and slightly arched, left valve with AII, 2, 4b, PII; right valve with AI, AIII, 3a, 3b, PI; 2 and 3b peg-like; pallial line mostly entire, sometimes a small sinus near the posterior adductor scar.

Subgenus **PROTOCARDIA** s.s.

Diagnosis. Posterior slope clearly marked off from the rest of the shell by its well-developed radial riblets; remainder of shell with concentric growth lines only.



TEXT-FIG. 33. Internal views of the right (a) and left (b) valves of *Protocardia hillana* (J. Sowerby) from the Upper Cretaceous of England, showing details of the cardinal plate. Figure after Woods (1908), $\times 2$.

1. **Protocardia (Protocardia) striatula** (J. de C. Sowerby, 1829) Pl. 12, figs. 7–11, 131829 *Cardium striatulum* sp. nov., J. de C. Sowerby, p. 101, pl. 553, fig. 1.1859 *Cardium crawfordii* sp. nov., Leckenby, p. 14, pl. 3, figs. 9a, 9b.1859 *Cardium cognatum* Phillips; Leckenby, p. 14, pl. 3, figs. 8a, 8b (*non* Phillips).1860 *Cardium striatulum* J. de C. Sowerby; Damon, pl. 3, fig. 3.1934 *Cardium crawfordii* Leckenby; Arkell, p. 305.1972 *Protocardia crawfordii* (Leckenby); Walker, p. 128, pl. 7, fig. 7.

Holotype. BM 43154; figured J. de C. Sowerby 1829, p. 101, pl. 553, fig. 1; Brora Roof Bed (Kellaways Beds, *calloviense* Zone) of Brora, Sutherland.

Measurements.

	L	H	I	AL
N	15	15	13	14
\bar{x}	13.1 mm	91.9%	70.4%	44.7%
Max	24.1	101.4	85.5	54.8
Min	7.3	81.4	59.0	32.8
OR	16.8	20.0	26.5	22.0

Description. Medium-sized species, equivalve, inequilateral, subrectangular to subquadrate in outline, regularity of outline broken by prominent umbones, placed just anterior of median. Hinge margin slightly reflexed, almost straight, anterior and posterior parts meeting in a very obtuse angle immediately beneath umbones; posterior margin obliquely truncate to gently convex, meeting posterodorsal margin at a rounded obtuse angulation; anterodorsal margin curving smoothly into slightly produced, rather rounded anterior margin; anterodorsal angle weakly angular, but sometimes prominent; ventral margin smoothly and convexly curved, passing evenly into anterior and posterior margins, without angulation. No clearly-developed umbonal carina, posterior area being delimited solely by ornament pattern, not by change in slope of shell flanks. Umbones large, prominent, just anterior of median, slightly prosogyrate, their anterior and posterior borders gently rounded, salient up to 4 mm above hinge line, almost contiguous at their extremities. Ligament external, parivincular, very short, rather deeply impressed; no lunule or escutcheon. Ornament of up to 20 fine radial riblets on posterior part of shell, occupying area between posterior margin and posterior part of umbo; radial riblets coarsest in central part of area, becoming finer anteriorly and posteriorly; remainder of shell solely with fine concentric growth lines. Inflation high, most marked in small specimens.

Dentition heterodont, with a pair of triangular cardinal teeth in each valve, arranged in a Λ -shaped pattern immediately beneath umbones; left valve with elongate anterior and posterior lateral tooth, right valve with two elongate anterior laterals and one posterior lateral (Text-fig. 33). Margin entire, crenulate along margin of area, where radial riblets reach shell margin. Musculature not seen.

Remarks. As may be seen from the synonymy, the nomenclature of British Upper Jurassic *Protocardia* is confused, and in need of clarification. In common with several other species which were described from the Brora Roof Bed of Sutherland by J. de C. Sowerby in 1829, *Cardium striatulum* was largely overlooked by subsequent workers, who had presumably been misled by its being referred to in the Index to the Mineral Conchology (1840) as occurring in the "Inferior Oolite?". The only worker to recognize Sowerby's species was Damon (1860), who correctly identified this species from the Oxford Clay of Weymouth. Study of a large series of *Protocardia striatula* from the type locality, (author's collection, OUM & BM), shows a marked size variation from small subquadrate specimens to medium-sized suborbicular ones, although all intermediates exist. Without the intermediates it is likely that the large and small specimens would be thought of as distinct species, as the two forms are not identical. The small specimens closely resemble the ones described from the "Kellaways Rock" of Scarborough by Leckenby (1859) as *Cardium crawfordii* sp. nov., and also with those occurring in the Kellaways Rock of Wiltshire (Arkell 1934) and Yorkshire (Walker 1972). These tend to be much smaller, more subquadrate (with

subparallel anterior and posterior margins), and more inflated (making them much more globose) than the larger, flatter, more suborbicular forms from the Brora Roof Bed (referred to *P. striatula*), in which the anterior and posterior margins are evenly curved. The holotype of *Cardium crawfordii* (SM J6010), is from the "Kelloways Rock" of Scarborough.

Cardium cognatum Phillips from the Grey Limestone (Bajocian) to "Kelloways Rock" of Yorkshire, has been referred to *Protocardia* by several authors (Cox & Arkell 1948; Walker 1972). The holotype (YM Tsp117) lacks radial ornamentation on the posterior area although Arkell (in a note with this specimen) suggested that there were faint traces of radial striae on the extreme posterior of the shell. It is thus excluded from *Protocardia*. The specimen figured by Leckenby (1859) as *Cardium cognatum* is a large *Protocardia* agreeing perfectly with specimens of *P. striatula* from the Brora Roof Bed, and clearly does not belong with Phillips' conception of the species. Likewise, the specimen mentioned by Callomon (1955, p. 221) as *Protocardia citrinoideum* (Phillips), from the Lower Oxford Clay of Kidlington (OUM J9719), cannot be reconciled with Phillips' original figure (1829, pl. 7, fig. 7) of that species, which shows a specimen with regular concentric ribs, and no evidence of radial striae. The holotype of *P. citrinoideum* is missing from the Yorkshire Museum, but several topotypes from the Upper Cornbrash of Scarborough agree well with Phillips' figure, and clearly do not belong to *Protocardia*. Callomon's specimen agrees perfectly with the many small specimens of *P. striatula*.

Arkell (1934, p. 304) described *Protocardia dyonisea* (Buvignier) from the Corallian Beds of England, and compared it with *P. crawfordii*, with which it agrees well in size. As Arkell noted, *P. crawfordii* is less elongate, and the anterior and posterior margins are more truncated and less rounded; the umbones are also more acute, and the anterior part of the shell more inflated. *P. intexta* (Münster), also from the British Corallian Beds (Arkell 1935, p. 372), more closely resembles the large form of *P. striatula*, but is more perfectly orbicular, much less inflated, and has the umbones much less prominent than in *P. striatula*.

Range and occurrence. Locally abundant in the Kelloways Rock (*calloviense* Zone) of Dorset, Wiltshire, the Midlands, Yorkshire and Scotland; sporadically in the Lower Oxford Clay (*jason* Zone) of the Midlands, the Hackness Rock (*athleta* to *lamberti* zones) of Yorkshire, and Upper Oxford Clay of Cambridgeshire.

2. *Protocardia (Protocardia)* sp. Pl. 12, figs. 5, 6

Description. Large (up to 32.5 mm L) *Protocardia* of low inflation and suborbicular to subtriangular outline, ornamented by a series of fine radial ribs on posterior area, and regular fine concentric ribs on remainder of shell. In the only measurements available, height is measured at 92.6% and anterior length at 33.7%. Umbones appear to be rather more rounded, and considerably less prominent than in *P. striatula*; it is likely that they are more nearly median in position than the AL measurements indicate, as there is some distortion caused by crushing. Radial ribs on posterior area are strongest in central part of the area, and diminish in strength anteriorly and posteriorly; concentric ribs strongest near anterior margin and in umbonal region, but never very highly elevated. Ligament, dentition and musculature not seen.

Remarks. This species is represented by six disarticulated, pyritized valves which because of their relatively large size and fragility, burial and compaction in a shell-bed has led to considerable distortion and breakage. There can, however, be no doubt that they are *Protocardia*, as they clearly show the differentiated radially-ribbed posterior area, and the concentrically ribbed flanks. The strength of the ribbing over the flanks of the shell serves to separate this species from *P. striatula*, which has only very faint concentric growth lines. The ornament style resembles that seen in *P. stricklandi* (Morris & Lycett), from the Great Oolite (Bathonian), and it is possible that the Lower Oxford Clay material may belong with it. In view of the poor preservation specific identification is impossible.

Range and occurrence. Lower Oxford Clay (*obductum* Subzone, *coronatum* Zone) of Marston Moretaine and Stewartby, Bedfordshire.

Superfamily ARCTICACEA Newton, 1891

Family ARCTICIDAE Newton, 1891

Genus **ROLLIERELLA** Cossmann, 1924(Synonyms: *Rollieria* Cossmann, 1923; non *Rollieria* Cossmann, 1920 [Nuculanacea])

Type species. Original designation; Cossmann 1924, p. 48; *Isocardia laubei* Rollier 1913, p. 209, nom. nov. *pro Isocardia cordata* Laube 1867, p. 41, pl. 4, fig. 1 (non J. Buckman 1844); Brown Jura of Balin, Germany.

Diagnosis. Subtrigonal to orbicular, gibbose, inflated; umbones prominent, produced, strongly prosogyrate and enrolled; lunule well marked, escutcheon absent; surface smooth or with radial threads; hinge formula:

AI	3a	1	3b	PI
AII	2a	2b	4b	PII

with 1 arcuate and projecting, 3a–3b a continuous angulate structure, 3b bifid; 2a short and curved, 2b massive and peg-like, 4b elongate and arcuate; pallial line entire.

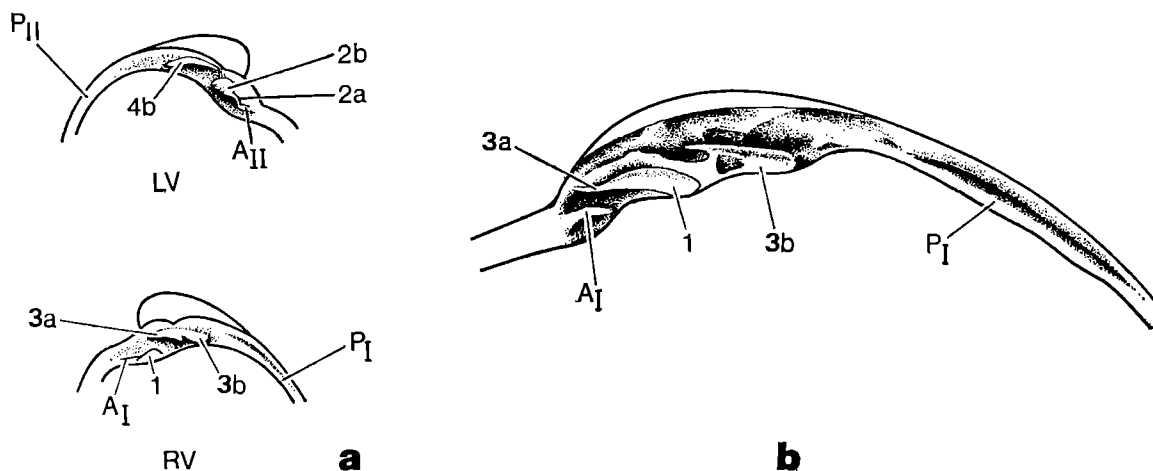

TEXT-FIG. 34. a. Internal view of both valves of *Rollierella* sp., from the Bathonian of France (after Douvillé), showing the characteristic dentition for the genus; from Cox (1947, p. 145, figs. 3a–b), $\times 0.8$. b. Internal view of a right valve of *R. minima* (J. Sowerby), from the Oxford Clay of Lukow, Poland, showing details of the hinge plate. Drawing from a positive "Silcoset" mould made from a limestone steinkern. The teeth 3a and 3b are formed into a continuous lamina, with 3b bifid; in this specimen 3b is broken; 3a is closely applied to the dorsal surface of the arcuate 1. AI is short and peg-like and placed just ventral of the anterior end of 1; it is incomplete in this specimen. Author's collection, $\times 5$.

Remarks. The genus was discussed, and the dentition described, by Cox (1947; see also Text-fig. 34a) who mentioned that several specimens from the Bathonian of Noyen and Langrune (France), referred by Douvillé (1921, p. 121, figs. 13, 14) to "*Eotrapezium*" (mistake for *Pseudotrapezium tenerum* (J. Sowerby)), are present in BM. These are not *Anisocardia tenera*, however, and the species, now needing a new name, is not known to occur in Britain. The present record is thus the first authenticated British record of the genus.

Externally, there are strong resemblances to *Anisocardia*, to which *R. minima* (see below) has been traditionally referred, in that the umbones are rather pronounced and twisted, although generic separation is based on dental characters. *Rollierella* may be distinguished from *Anisocardia* by its strong, continuous, angulated 3a–3b, the same teeth barely meeting at an acute angle in *Anisocardia*; 2b is also very distinctive, being large and peg-like in *Rollierella*, and markedly bifid in *Anisocardia*.

Rollierella minima (J. Sowerby, 1821) Pl. 12, figs. 12, 14–17, 19, 23, 28; Text-figs. 34b, 35, 37

- 1821 *Isocardia minima* sp. nov., J. Sowerby, p. 171, pl. 295, fig. 1.
 1829 *Isocardia tumida* sp. nov., Phillips, pl. 4, fig. 25 (*non Pygocardia tumida* Nyst).
 ? 1829 *Isocardia minima* J. Sowerby; Phillips, pl. 7, fig. 6.
 1850 *Isocardia campaniensis* sp. nov., d'Orbigny, p. 338, no. 168.
 ? 1850 *Isocardia villersensis* sp. nov., d'Orbigny, p. 338, no. 169.
 1853 *Isocardia tenera* J. Sowerby; Morris & Lycett, p. 66, pl. 7, figs. 1, 1a (*non* J. Sowerby).
non 1860 *Isocardia minima* J. Sowerby; Damon, pl. 4, fig. 7 (= *Anisocardia anisocardioides* Blake & Hudleston).
 1863 *Isocardia tenera* J. Sowerby; Lycett, p. 57, pl. 38, figs. 5–5b (*non* J. Sowerby).
non 1863 *Isocardia minima* J. Sowerby; Lycett, p. 56, pl. 36, figs. 1, 1a (= *Anisocardia globosa* (Roemer)).
 1913 *Anisocardia oolithica* nom. nov., Rollier, p. 198 (*pro Isocardia tenera* Morris & Lycett *non* J. Sowerby).
 1913 *Anisocardia lycetti* nom. nov., Rollier, p. 210 (*pro Isocardia tenera* Lycett *non* J. Sowerby).
 1915 *Isocardia campaniensis* d'Orbigny var. *dassei* nov., Cossmann, p. 6, pl. 1, figs. 3, 4; pl. 3, fig. 17.
 1925 *Isocardia campaniensis* d'Orbigny; Cottreau, p. 18, pl. 39, figs. 13, 14.
 ? 1925 *Isocardia villersensis* d'Orbigny; Cottreau, p. 19, pl. 39, figs. 15, 16.
 1934 *Anisocardia minima* (J. Sowerby), Arkell, p. 275, pl. 36, figs. 8–11.
 1947 *Anisocardia minima* (J. Sowerby); Cox, p. 170, text-figs. 43a, 43b.
 1948 *Anisocardia minima* (J. Sowerby); Cox & Arkell, p. 31.
 1952 *Anisocardia tenera* (J. Sowerby); Makowski, p. 12, pl. 5, fig. 7 (*non* J. Sowerby).
 1965 *Anisocardia minima* (J. Sowerby); Cox, p. 112, pl. 18, fig. 8.

Holotype. BM 43164; figured J. Sowerby 1821, p. 171, pl. 295, fig. 1; ? Cornbrash of Wiltshire.

Measurements.

	L	H	I	AL	PW
N	33	33	31	32	4
\bar{x}	17.5 mm	93.1%	88.0%	31.0%	55.3%
Max	24.0	99.4	98.7	42.3	59.9
Min	7.0	84.3	76.4	24.2	46.0
OR	17.0	15.1	22.3	17.1	13.9

Description. Medium-sized species, subtrigonal in outline, inequilateral, equivalve, with margins entire. Umbones prominent, inflated, placed in anterior third of shell, salient up to 4 mm above hinge line, not contiguous, up to 5 mm apart at umbonal extremities, strongly progyrate and enrolled. Dorsal margin arched at *c.* 120°, anterior part slightly concave, posterior part slightly convex; anterodorsal angle very prominent and produced, rounded at its extremity, posterodorsal angle much more evenly curved; ventral margin smoothly curved between antero- and posterodorsal angles. Inflation high. Valves with closely-spaced fine radial riblets, crossed by densely packed fine concentric threads to give a fine cancellate pattern over whole shell surface except for the pseudolunule, where radial riblets are absent; pseudolunule large, wide, bowl-shaped, its edge marked by an impressed line parallel to radial riblets and extending from umbones almost to anteroventral angle, enclosing an area ornamented solely by growth lines (Text-fig. 35). Lunule small, arcuate, flattened, marked off from pseudolunule by deeply impressed line, and forming an obtuse angle with it; escutcheon absent. Ligament external, opisthodontic, nymph situated immediately behind and beneath umbonal terminations; ventral margin finely crenulate.

Hinge heterodont, dental formula as in generic diagnosis; cardinal teeth of left valve anterior to those of right valve, in which AI is short and peg-like, situated immediately beneath anterior end of I, which itself is arcuate, concave ventrally and strongly developed; 3a small, continuous with 3b, closely applied to upper surface of I; 3b elongate and bifid, forming a continuous angulated tooth with 3a; PI long and well-developed (Text-fig. 34b). In left valve, AII short, situated immediately below anterior end of 2a; 2a short and curved, attached posteriorly to massive, peg-like 2b; 4b elongate and gently concave ventrally; PII elongate and well-developed. Pallial line entire; anterior adductor scar elongate and arcuate, located immediately dorsal of antero-

ventral angle and reaching almost to cardinal plate; posterior adductor scar subquadrate, located just ventral to posterior end of posterolateral teeth.

Remarks. In the four exceptionally well preserved specimens of *Rollierella minima* from the Upper Callovian of Lukow, Poland, donated to the author by Dr A. Radwanski of the University of Warsaw, it has been possible to develop the hinge for the first time, thus enabling correct generic placement of the species. The use of normal development techniques, supplemented by serial sectioning, has shown the dentition to be of *Rollierella* type, with 3a + 3b a continuous, angulate, well-developed tooth, rather than two separate elements. 1 is strongly developed and arcuate in form. Thus Cox (1947), who suspected that the globose *Anisocardia*-like forms may belong to *Rollierella*, was correct. It is possible that *Anisocardia tenera* belongs to *Rollierella*, but the dentition of this species has never been seen, and with the lack of evidence to the contrary, it is best to leave it in *Anisocardia*.

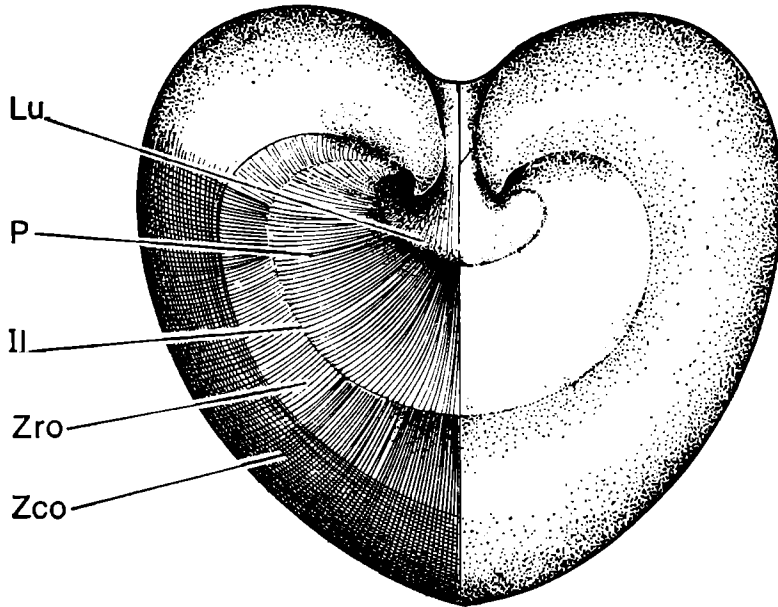

TEXT-FIG. 35. Anterior view of a specimen of *Rollierella minima* (J. Sowerby), from the Oxford Clay of Lukow, Poland, showing the differentiation of the lunule and the pseudolunule. The lunule is flattened, and separated from the obliquely-sloped pseudolunule by an impressed line, making an obtuse angle between the two areas. The two zones of ornamentation on the body of the shell are shown diagrammatically, a narrow zone of radial ornament adjacent to the pseudolunule being replaced on the flanks of the shell by finely cancellate ornament, $\times 4$. **Il** = impressed line; **Lu** = lunule; **P** = pseudolunule; **Zco** = zone of concentric ornament; **Zro** = zone of radial ornament.

The term pseudolunule (Text-fig. 35) is used for the large area anterior to the umbones (P), marked off from the body of the shell by a fine impressed radial line which extends from the umbo to the dorsal margin, reaching almost to the anterodorsal angle. The pseudolunular area includes the lunule, which is itself marked off from the body of the pseudolunule by a more deeply impressed line radiating from the umbones. There is a marked angular discordance between the surface of the lunule and the pseudolunule, the two areas also being distinguished by an important difference in ornamentation, the latter area lacking radial sculpture.

R. minima differs from *Anisocardia tenera* in being more inflated (I 76–98% in *R. minima*, 52–70% in *A. tenera*), in the possession of a much sharper and more prominent anterodorsal angle, in having more inflated and enrolled umbones, and in lacking the slightly rostrate posterior margin of *A. tenera*. Other related species, from the Corallian Beds, are *A. anisocardioides* (Blake & Hudleston), which has a much more rounded anterodorsal angle and less strongly enrolled umbones;

and *A. globosa* (Roemer), which has a more rounded anterodorsal angle and a well-developed posterior carina and flange.

Range and occurrence. Bathonian to Oxfordian of Britain (Cox & Arkell 1948, p. 31); particularly abundant in the Cornbrash and Kellaways Rock; top Kellaways Rock of the Midlands, and transition beds to the Oxford Clay (never in the clay facies). Arkell (1934, p. 276) listed the foreign Callovian records of specimens referable to *R. minima*, the species being known from France, Germany, Poland and East Africa.

Genus **ANISOCARDIA** Munier-Chalmas, 1863

(Synonyms: *Apocardia* Dollfus, 1863; *Cardiodonta* Laube, 1867)

Type species. By monotypy; *Anisocardia elegans* Munier-Chalmas 1863, p. 288, pl. 11, figs. 5–8; (see Text-fig. 36); Kimmeridgian of Le Havre, France.

Diagnosis. Ovate to subtrigonal or trapeziform, sometimes slightly truncate posteriorly; lunule superficial, escutcheon absent; surface smooth or with radial threads; hinge formula:

AI	1	3a	3b	PI
AII	2a	2b	4b	PII

with 1 projecting, 3a laminar and elongate, 3b bifid, 2b chevron shaped, 2a laminar, not well-differentiated from AII, 4b massive, PI strong, elongate, PII confluent with margin of hinge plate; pallial line markedly truncate posteriorly, but not sinuate.

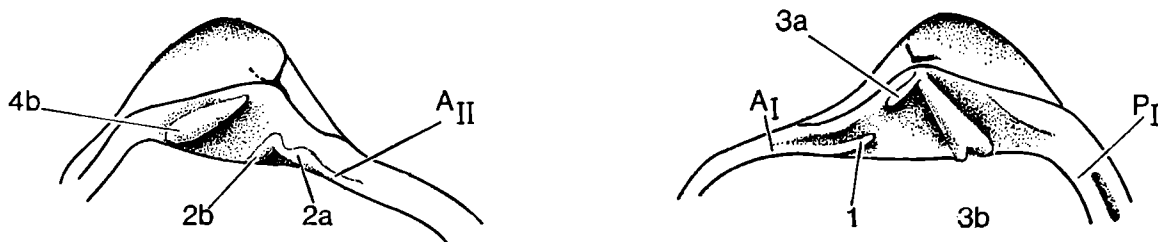

TEXT-FIG. 36. The dentition of *Anisocardia elegans* Munier-Chalmas, from the Kimmeridgian of France (after Cox 1947, p. 145), $\times 1.5$.

Subgenus **ANISOCARDIA** s.s.

Diagnosis. Subtrigonal, posterior margin usually truncate or rostrate; umbones very prominent, strongly prosogyrate, often very markedly salient above the dorsal margin; ornamented by radial threads and concentric growth lines; hinge line strongly arched, anterior laterals very reduced; ventral margin finely crenulated.

Remarks. The status of *Anisocardia* has been discussed at length by Cox (1947) and Casey (1952), with emphasis on the dentition. There is some doubt concerning the generic placement of species such as *Anisocardia minima*, *A. tenera* and *A. gibbosa* (Münster), which have been referred to *Anisocardia* since the work of Zittel (1881). The external features of the shell, if studied in isolation, would suggest that these species belong to *Rollierella*, which differs from *Anisocardia* only in details of the hinge, as discussed above. Development of the hinge of "*A.*" *minima* has shown that it does in fact belong in *Rollierella*, and this increases the possibility that *A. tenera* and *A. globosa* also belong in this genus, but as it has not been possible to examine the hinges of these species, it seems best to leave them in *Anisocardia* until they can be proved to belong elsewhere.

Anisocardia is unusual in that in the right valve 1 is usually placed anterior of 3a, thus posing problems of tooth numeration. The lamina 3a–3b is, however, seen to be of normal arcticacean type, and it is possible that 1 merely represents a rather unusual development of AI, and that 1 itself is obsolete. The same is true to some extent in *Rollierella*, although 3a is often placed dorsal, rather than posterior, to 1.

Anisocardia (Anisocardia) tenera (J. Sowerby, 1821) Pl. 12, figs. 18, 20–22; Text-fig. 371821 *Isocardia tener* sp. nov., J. Sowerby, p. 171, pl. 295, fig. 2.1829 *Isocardia tenera* nom. nov., J. de C. Sowerby; p. 48.non 1853 *Isocardia tenera* J. Sowerby; Morris & Lycett, p. 66, pl. 7, figs. 1, 1a (= *Rollierella minima*).non 1863 *Isocardia tenera* J. Sowerby; Lycett, p. 57, pl. 38, figs. 5–5b (= *Rollierella minima*).? 1904 *Anisocardia tenera* (J. Sowerby); Ilovaisky, p. 258, pl. 9, fig. 10.? 1915 *Anisocardia tenera* (J. Sowerby); Krenkel, p. 325, pl. 26, fig. 37.non 1919 *Anisocardia tenera* (J. Sowerby); Couffon, p. 92, pl. 4, figs. 14–14b.1934 *Anisocardia tenera* (J. Sowerby); Stoll, p. 13, pl. 1, fig. 39.non 1952 *Anisocardia tenera* (J. Sowerby); Makowski, p. 12, pl. 5, figs. 7, 7a (= *Rollierella minima*).? 1972 *Anisocardia tenera* (J. Sowerby); Walker, p. 130, pl. 8, figs. 8, 9.*Holotype*. BM 43165; figured J. Sowerby 1821, p. 171, pl. 295, fig. 2; Kellaways Rock of Wiltshire.*Measurements.*

	L	H	I	AL
N	14	14	14	14
\bar{x}	20.5 mm	89.9%	60.3%	33.6%
Max	25.2	98.3	70.5	39.0
Min	12.7	83.0	52.6	27.3
OR	12.5	15.3	17.9	11.7

Description. Large species, subrectangular to subtrigonal in outline, inequilateral, equivalve. Umbones prominent, prosogyrate, not strongly enrolled, placed within anterior third of shell, only slightly salient (up to 2 mm) above hinge line. Dorsal margin arched at 100–110°, anterior part gently concave, becoming convex anteriorly, posterior part gently convex, becoming more strongly convex into posteroventral margin; anterodorsal angle prominent and rounded, postero-dorsal angle rounded, passing into obliquely truncate posterior margin, which is slightly rostrate; anterior margin rounded, passing evenly into gently convex ventral margin; posteroventral angle rounded; umbonal carina runs from umbones to posteroventral angle, delimiting a small, flattened posterior area. Sculpture of densely packed fine radial riblets, crossed by closely spaced concentric growth lines, to give a finely cancellate pattern to all of shell surface except pseudolunule, which lacks radial ornament; pseudolunule width 22.7%, marked off from body of shell by slightly impressed radial line; lunule not visible, escutcheon absent; ligament external, opisthodontic, placed as in *R. minima*.

Dentition not seen. Pallial line entire, anterior adductor scar elongate and arcuate, placed near anterodorsal angle; posterior adductor scar not seen. Ventral margin finely crenulate.

Remarks. As noted above, the dentition of this species has not been seen in British specimens, although figures of the dentition of closely related species do exist. Boden (1911) figured specimens incorrectly identified as *Anisocardia choffati* de Loriol, which when compared with British material leads to the conclusion that at least part of Boden's series (his pl. 6, figs. 6–8, and possibly fig. 9) may belong to *A. tenera*. Unfortunately, it is his fig. 9 which shows the dentition, and as it is not certain that this figure belongs to *A. tenera*, the nature of the dentition of this species remains uncertain; the dental formula of Boden's right valve is:

AI 1 3a 3b 5b PI

His figure indicates the presence of a fairly well-developed 5b, suggesting that the specimen is not referable to *A. tenera*. Cox's figure (1947) of the hinge of the type species of *Anisocardia* is reproduced as Text-fig. 36.

Statistically, the differences between *A. tenera* and *R. minima* are most obvious in the L/I regression lines (Text-fig. 37a), the L/H and L/AL regressions for the two species being rather similar (Text-figs. 37b, 37c). The regressions shown here are simple arithmetic plots, assuming constant growth rates.

There is a long history of confusion in the literature over the identity of *A. tenera* and *R. minima*, caused in the most part by the scant nature of Sowerby's descriptions, and the apparent similarity of his two figures. Examination of the holotype reveals that the differences between the two are clear-cut. However, study of the synonymies shows that the two species have often been confused, notably by Morris & Lycett (1853), Lycett (1863) and continental authors such as Goldfuss (1837), Couffon (1919) and Makowski (1952). *Anisocardia clarissima* (Leckenby, 1859), from the Hackness Rock of Scarborough, is closely related to *A. tenera*, but specific identity is unlikely. The holotype (SM J6006) and several paratypes (SM J12456-60) are more elongate than *A. tenera* ($H \bar{x} 83.0\%$, compared with 89.9% in *A. tenera*), and also more inflated ($I \bar{x} 68.0\%$, compared with 60.3%). Both these values for *A. clarissima* lie further from the mean of *A. tenera* than one standard deviation, and are thus considered to be significantly different. *A. clarissima* is also much more markedly rostrate than *A. tenera*.

Range and occurrence. Kellaways Beds in Wiltshire and Yorkshire. GSM Y2071-2074, labelled "Oxford Clay, Loudon" probably belong to this species, but the preservation is poor and horizon

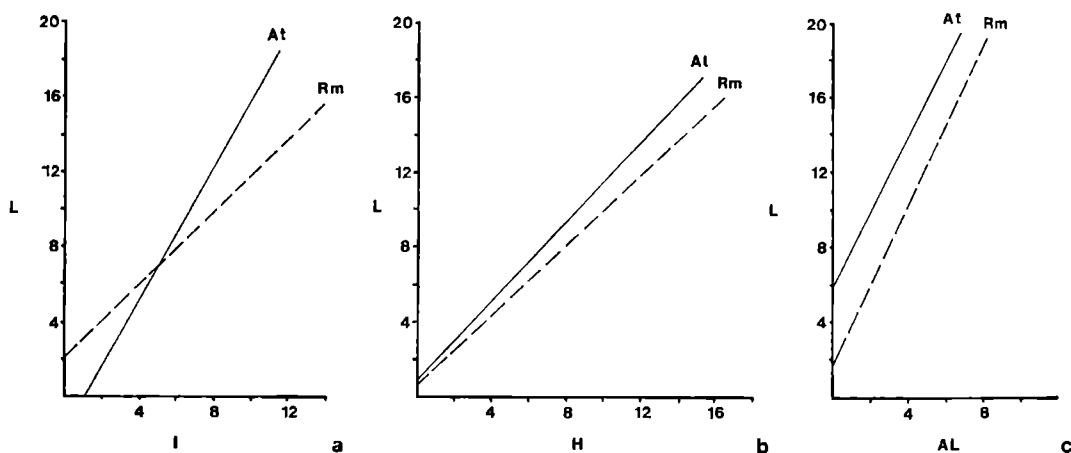

TEXT-FIG. 37. Comparison of the Length/Inflation, Length/Height and Length/Anterior Length regression lines for *Anisocardia tenera* (J. de C. Sowerby) and *Rollierella minima* (J. Sowerby). a. The average L/I regressions for several populations of the two species; note the obvious difference in growth rates, with *R. minima* being much more inflated. b. L/H regressions. c. L/AL regressions. Scale in mm. **At** = *Anisocardia tenera*; **Rm** = *Rollierella minima*.

and locality unknown. Upper Bathonian (*Oppelia aspidoides* Zone) and Middle Callovian of North Germany (Stoll 1934); "Unteren Oxford" (probably *cordatum* Zone) of Popilany, Lithuania (Boden 1911); *athleta* and *lamberti* zones ("Oberes Kelloway") of Popilany (Krenkel 1915).

Genus **ISOCYPRINA** Roeder, 1882

Type species. Subsequent designation; Cossmann 1921, p. 23; *Cardium cyreniformis* Buvignier 1852, p. 15, pl. 13, figs. 23-27; (see Text-fig. 38a); Upper Oxford Clay (Oxfordian) of the Ardennes.

Diagnosis. Suborbicular to ovate, evenly inflated or with a weak umbonal carina; lunule faint, mostly bounded by an impressed line, escutcheon absent; ornamented by faint concentric lines, or smooth; hinge formula (cf. Text-fig. 38):

$$\begin{array}{cccccc} \text{AI} & & (\text{AIII}) & (1) & (3a) & 3b & \text{PI} \\ \hline & \text{AII} & & (2a) & & 2b & & 4b & & (\text{PII}) \end{array}$$

lamina AII (+ 2a) joined to 2b by vinculum, PII merged into margin; PI strong, elongate.

Subgenus **ISOCYPRINA** s.s.

Diagnosis. Hinge with 2a differentiated from AII; laterals smooth; other characters as in the generic diagnosis.

Remarks. Arkell (1934, p. 263) suggested that the distinction between forms with and without cardinal tooth 3a may be of generic or subgeneric significance. However, Casey (1952, p. 136) has concluded, after studying many species of Jurassic and Cretaceous *Isocyprina*, including the type species *I. cyreniformis*, that no taxonomic significance should be ascribed to these variations in dentition. He believed that in *I. cyreniformis*, 3a is present although extremely reduced, and is represented by a minute sliver of shell pressed against the valve margins (Text-fig. 38a). Chavan (1945, p. 80) followed Arkell in noting that the species described by Roeder (1882) as *I. cyreniformis* was not identical with that originally described by Buvignier (1852), on the basis of the dentition, there being no 3a in Buvignier's species, although he recognized that other Jurassic and Cretaceous species have one. This led Chavan to conclude that all the Mesozoic species of *Isocyprina* bearing 3a should be placed in the subgenus *Eotrapezium* Douvillé, and that *Isocyprina*

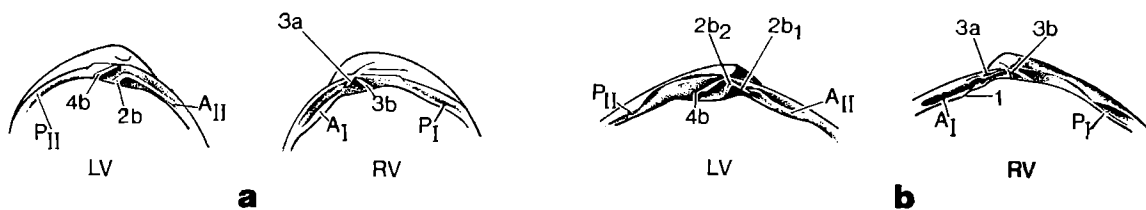

TEXT-FIG. 38. The hinge of *Isocyprina* (*Isocyprina*). a. Internal views of the left and right valves of *I. (I.) cyreniformis* (Buvignier), from the Oxfordian of France; note the vestigial 3a in the right valve. After Cox (1947, p. 145), $\times 0.7$. b. Internal views of the hinge of *I. (I.) sharpi* Cox, from the Bathonian of Oxfordshire; again 3a is vestigial. After Casey (1952, p. 135), $\times 0.7$.

(*Eotrapezium*) *roederi* should be chosen as the "typical form". However, Keen & Casey (1969, N648) restricted *Eotrapezium* to Upper Trias to Lower Jurassic forms with 1 scarcely differentiated from AI, no 2a, and lamina AIII–3a usually suppressed, with the effect that the Jurassic and Cretaceous forms must be placed in *Isocyprina* s.s.

Isocyprina* (*Isocyprina*) *roederi Arkell, 1934. Pl. 12, figs. 25–27, 29, 31

1882 *Cyprina* (*Isocyprina*) *cyreniformis* Buvignier; Roeder, p. 91, pl. 2, figs. 5a, 5b; pl. 4, figs. 11a, 11b (*non Isocyprina cyreniformis* Buvignier).

1934 *Isocyprina roederi* sp. nov., Arkell, p. 263, pl. 35, fig. 21.

1945 *Isocyprina* (*Eotrapezium*) *roederi* Arkell; Chavan, p. 81.

Holotype. The specimen (location unknown) figured by Roeder, 1882, pl. 2, fig. 5b; Oxfordian of Pfirt, Germany.

Measurements.

	L	H	I
N	14	14	3
\bar{x}	15.5 mm	90.1%	35.3%
Max	20.0	96.3	42.2
Min	6.5	83.3	30.9
OR	13.5	13.3	11.3

Description. Medium-sized, equivalve, subequilateral (umbones more or less median), sub-orbicular to subovate in outline; anterodorsal and posterodorsal margins gently convex, except for slight concavity just anterior of umbones which indicates the position of very small lunule; anterior, ventral and posterior margins continuously and evenly curved to give semicircular outline to remainder of shell margin. Inflation low. Umbones small, submedian, prosogyrate,

not prominent, only very slightly salient to the hinge margin, not contiguous. Shell exterior with only irregularly-spaced faint concentric growth lines; no radial elements.

Hinge formula as for subgenus except that 2a is not clearly differentiated from AII; laterals strong, laminar, smooth, AI usually colaminar with, and not differentiated from, cardinal 1; 3a thin, closely pressed against valve margin, 3b strongly triangular, more or less bifid; 2b stoutly triangular, its anterior limb aligned with AII and joined to it by a vinculum; 4b long, slender. Margin entire, without denticulations. Adductor muscle scars unequal, posterior scar higher and more elongate than anterior, both scars elongated dorsoventrally; pallial sinus very small.

Remarks. As noted above, the material figured by Roeder (1882) as *I. cyreniformis* Buvignier differs from Buvignier's species in the possession of tooth 3a; the first available name is *I. roederi* Arkell. This rather distinctive species is rarely well enough preserved to allow examination of the hinge, although one pyritized right valve from Marston Moretaine shows almost all of the cardinal plate. In this, 3a is clearly recognisable, thus separating it from *I. simplex* Arkell. These two species are very similar in form, apparently only differing in dentition. As Arkell (1934, p. 269) noted, no right valves of *I. simplex* showing the dentition properly are known, and it is uncertain how strongly 3a is developed. However, he noted that the hinge was "as *I. cyreniformis*", and so it is necessary to assume, in the absence of evidence to the contrary, that 3a is very weak or absent. The discovery of better-preserved material of *I. simplex* would clarify the position.

Arkell (op. cit., p. 261) recognized five species of *Isocyprina* (excluding *I. roederi*) in the British Corallian Beds, and clarified the position of several of the species described by d'Orbigny (1850). In several of his species, d'Orbigny seems to have united individuals belonging to more than one species, notably in the case of his *Cyprina dimorpha*, which was figured by Cottreau (1927, pl. 46, figs. 15-17). Arkell (p. 265) accepted Cottreau's fig. 17 as being synonymous with *I. cyreniformis*, but questioned the placement of fig. 15 and 16, suggesting that they may belong with *I. simplex*. This seems probable, as the age is equivalent, and there are great similarities of form; the absence of a view of the cardinal plate precludes placement in *I. roederi*.

I. depressiuscula Morris & Lycett (1853) from the Bathonian (holotype GSM 9703), is another smooth species of low inflation, but is clearly distinct from *I. roederi* in that it has a much more produced anterior angle, breaking the regular suborbicular outline and exaggerating the prominence of the umbones. *I. politula* Bean (1839) from the Cornbrash of the Yorkshire coast also has prominent umbones, which are slightly hooked, and is immediately distinguishable.

Range and occurrence. Oxford Clay (*coronatum* to *athleta* zones) of central and southern England; Inverbrora Shale Member (*calloviense* to *jason* zones) of Brora, Sutherland; Oxford Clay (*cordatum* Zone) of Eigg, Inverness; Oxfordian of Germany.

Order *MYOIDA* Stoliczka, 1870
Suborder *MYINA* Stoliczka, 1870
Superfamily *MYACEA* Lamarck, 1809
Family *CORBULIDAE* Lamarck, 1818
Subfamily *CORBULINAE* Lamarck, 1818
Genus **CORBULOMIMA** Vokes, 1945

Type species. Original designation; *Corbulomima nuciformis* Vokes 1945, p. 10, pl. 2, figs. 5-8; Aptian (Cretaceous) of Lebanon.

Diagnosis. Moderately inflated, smooth, very slightly rostrate, lacking special structures for the reception of the resilifer in both valves; single large triangular cardinal tooth in the right valve, received in a socket in the left valve.

Remarks. Chavan (1952, p. 121, 122) recorded two corbulids referable to *Corbulomima* from the Sables Astartiens (Upper Oxfordian) of Calvados, France, *C. glosensis* (Zittel & Goubert) and *C. suprajurensis* (d'Orbigny). Figures of the hinge (Chavan 1952, pl. 4, figs. 73, 74, 77, 79) show the typical cardinal arrangement as defined by Vokes (1945), and there can be no doubt as to the correct placement of these two species.

1. *Corbulomima macneillii* (Morris, 1850) Pl. 12, figs. 24, 30, 32-40; Text-fig. 391850 *Corbula?* *macneillii* sp. nov., Morris, p. 318, pl. 30, fig. 4.1899 *Corbula Greppini* sp. nov., de Loriol, p. 146, pl. 10, fig. 1.*Neotype*. Designated herein, GSM 113999; Kellaways Rock of Trowbridge, Wiltshire.*Measurements*.

	L	H	I	AL
N	132	132	119	132
\bar{x}	5.0 mm	83.3%	72.0%	37.0%
Max	6.8	100.0	90.0	48.5
Min	3.4	67.2	56.5	29.5
OR	3.4	32.8	33.5	19.0

Description. Small species (up to 6.8 mm L), suborbicular to subtrigonal in outline, globose, with maximum inflation in region of hinge line; inequivalve, right valve slightly larger than left valve, overhanging it along ventral margin; inequilateral, umbones placed clearly anterior of

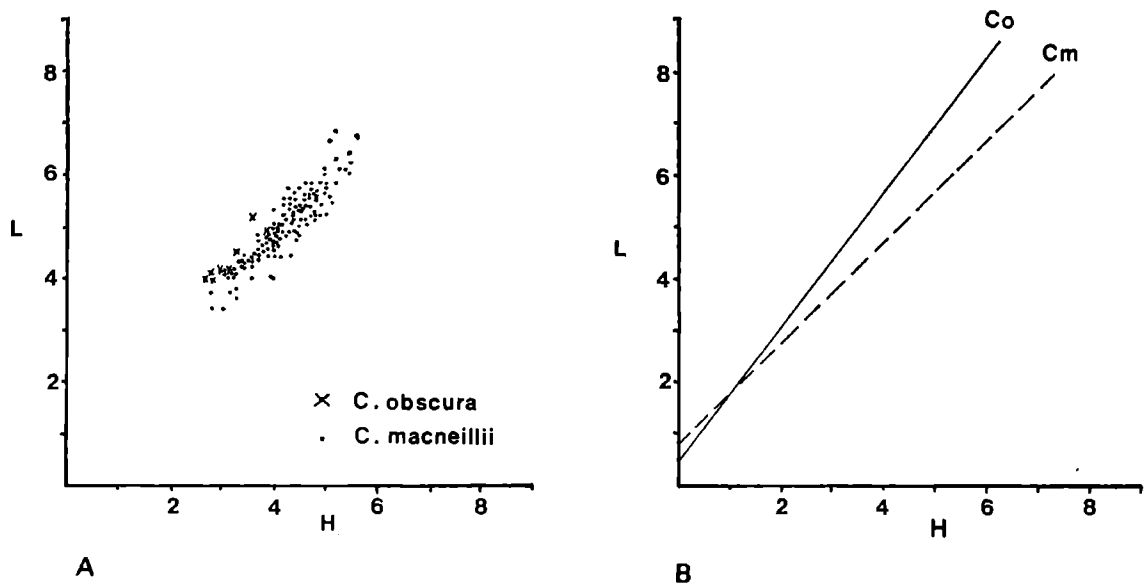

TEXT-FIG. 39. a. Scatter diagram showing the Length/Height ratio of *Corbulomima obscura* (J. de C. Sowerby) and *C. macneillii* (Morris). Note that the points for *C. obscura* indicate a lower value for H than do those of *C. macneillii*. b. Length/Height regression lines calculated from the scatter diagram. Scale in mm.

median. Dorsal margin reflexed, forming an obtuse angle diverging from below umbones, posterior part straight to gently convex, dependent upon development of posterior area, anterior part concave; no lunule; anterior margin rounded, produced into semicircular shape, passing smoothly into gently convex ventral margin; posterior margin obliquely truncate, meeting posterodorsal margin at *c.* 125°; posteroventral angle acute, well developed, located at point at which umbonal carina reaches ventral margin; carina rounded, gently convex towards posterior, posterior area sloping very steeply down from it towards posterior margin. Umbones small, submedian, inflated, prosogyrate, rather salient, not contiguous. Escutcheon absent. Ligament internal, external nymph not present. Shell very thin, with internal nacreous layer, ornamented solely by very faint concentric growth lines. Dentition of a single large triangular tooth on the right valve, with no chondrophore; dentition of left valve unknown. Margins entire, ventral margin of right valve overlapping that of left. Musculature not seen.

Remarks. The basis of this description is a large collection of recrystallised calcite steinkerns from the Lower Oxford Clay cementstones of Wiltshire, (OUM J28229–31 collective), which show the various features much more clearly than the clay steinkerns from the clay facies. In J28231 it was possible to prepare the hinge of the right valve, revealing the presence of a single large triangular cardinal tooth which confirmed the placement of this species within *Corbulomima*; no special structures (such as a chondrophore) for the attachment of the internal ligament were seen. Vokes (1945, p. 10) believed that the ligament was attached to the posterior part of the socket in the left valve in this genus, the socket being too elongate to accept only the cardinal tooth. No interior views of left valves of *C. macneillii* have been seen, but the internal view of a left valve of the closely related *Corbula oxfordiensis* d'Orbigny, given by Cottreau (1926, pl. 45, fig. 16), suggests that the dentition is normal for *Corbulomima*.

Corbulomima obscura (J. de C. Sowerby), from the Brora Roof Bed (= Kellaways Rock) of Brora, Sutherland, is very close to *C. macneillii* in both age and form, but differs in being less inflated ($I \bar{x}$ 61.1%), more elongate ($H \bar{x}$ 70.5%), and having a more reflexed posterior margin, giving a slightly rostrate appearance. Plotted on a simple length/height scatter diagram (Text-fig. 39a), *C. obscura* and *C. macneillii* can be seen to follow the same general trend of growth, although at any given length, the height measurement is slightly less in *C. obscura*. This trend is made even more apparent when the data are replotted to give regression lines (Text-fig. 39b), the line for *C. obscura* having a markedly steeper slope than those of four populations of *C. macneillii* from different parts of England. The consistent differences in both form and growth rates of these two geographically separated species favours their taxonomic separation, and it seems possible that in *Corbulomima* speciation may be allopatric.

Morris (1850, p. 318) stated that *Corbula cucullaeaeformis* Koch & Dunker (1837, p. 31, pl. 2, figs. 6a–6c) was "extremely close" to *C. macneillii*. However, Koch & Dunker's illustrations show that their species is much more rostrate with orthogyrate umbones, and cannot be considered synonymous. *Corbula greppini* de Loriol (1899), from the Lower Oxfordian of the Bernese Jura agrees well with the English Lower Oxford Clay specimens, and is probably synonymous with *C. macneillii*. *Corbula oxfordiensis* d'Orbigny (see Cottreau 1926, p. 47, pl. 45, figs. 16–18), from the Upper Oxford Clay of Normandy, differs from both *C. macneillii* and *C. obscura* in having regular concentric ornament, a feature shared by *Corbula mosae* d'Orbigny (1850).

Range and occurrence. Kellaways Rock (*calloviense* Zone) of Wiltshire; Lower Oxford Clay (*jason* to *athleta* zones) of central and southern England; Hackness Rock (*athleta* to *lamberti* zones) of Yorkshire; Upper Oxford Clay (*praecordatum* Zone) of southern England. Upper Oxford Clay of the Bernese Jura.

2. *Corbulomima obscura* (J. de C. Sowerby, 1827) Pl. 13, figs. 1–4; Text-fig. 39

1827 *Corbula* sp. nov., J. de C. Sowerby in Murchison, p. 320.

1827 *Corbula obscura* sp. nov., J. de C. Sowerby, p. 140, pl. 572, fig. 5.

Holotype. BM 43044; figured J. de C. Sowerby 1827, p. 140, pl. 572, fig. 5; "?Inferior Oolite" (= Kellaways Rock) of Brora, Sutherland.

Measurements.

	L	H	I
N	7	7	2
\bar{x}	4.3 mm	70.5%	61.1%
Max	5.2	73.8	62.2
Min	4.0	67.5	60.0
OR	1.2	6.3	2.2

Description. Small species (up to 5.2 mm L), subrectangular to subtrigonal in outline, gently inflated; inequivalve, right valve slightly overlapping left along ventral margin, inequilateral, umbones just anterior of median. Dorsal margin reflexed, angle about umbones more obtuse than

in *C. macneillii*, with gently concave to straight anterodorsal and posterodorsal outlines; anterior margin rounded, slightly produced, passing smoothly into gently concave ventral margin; posterior margin gently convex to oblique, meeting posterodorsal margin at *c.* 120–125°; postero-ventral angle acute, marking the point where the umbonal carina reaches ventral margin; umbonal carina rounded, less sharp than in *C. macneillii*, the posterior area being slightly wider and flatter than in *C. macneillii*, as carina is concave towards posterior; slight reflection of posterior part of ventral margin is characteristic, giving a slightly rostrate appearance. Umbones small, submedian, just anterior to mid-axis, prosogyrate, only slightly salient to hinge line, not markedly inflated. No lunule or escutcheon, ligament internal. Shell surface only with very faint concentric growth lines, no radial elements. Dentition and musculature unknown.

Remarks. *Corbulomima obscura* is another of Sowerby's species which has largely been overlooked in the literature, at least as regards Upper Jurassic records. This is probable because in the Systematic Index to volume 6 of the "Mineral Conchology", the species was said to have come from the "Inferior Oolite?", although in the description of the species (op. cit., p. 140), its horizon is recorded as the Brora Roof Bed. However, at the time of writing (1827), the Scottish Middle to Upper Jurassic succession was very poorly understood, and it is probable that Sowerby believed the Roof Bed to be possibly of Inferior Oolite Age.

As mentioned in the discussion of the preceding species, the differences between *C. macneillii* and *C. obscura* are fairly small, but constant, and are deserving of specific separation. These are the only two European Callovian to Lower Oxfordian corbulids known which are smooth and lack prominent concentric ribbing, and thus form a closely related species pair. All other contemporaneous European corbulids are much more rostrate, and have a greater valve overlap along the ventral margin. It is possible that these strongly ribbed species, such as *Corbula cucul-laeaeformis* Koch & Dunker, and *Corbulomima carinata* (Buvignier), should be referred to a genus other than *Corbulomima*.

Corbulomima suprajurensis (d'Orbigny), figured by Chavan (1952, p. 122, pl. 4, figs 72–75) from the Upper Oxfordian of Normandy, seems to have characters common to both groups of Upper Jurassic corbulids, as the small, subrectangular form with only faint concentric ornament is typical of the *macneillii-obscura* group, while the strong posterior reflection of the ventral margin is more characteristic of the *carinata* group. The evidence of the hinge mechanism, well seen in Chavan (1952, pl. 4, figs. 73 & 74), places this species undoubtedly in *Corbulomima*, but it cannot be considered synonymous with either of the two British species.

Range and occurrence. *calloviense* Subzone, *calloviense* Zone of the Brora Roof Bed, Brora, Sutherland.

Subclass ANOMALODESMATA Dall, 1889

Order PHOLADOMYOIDA Newell, 1965

Superfamily PHOLADOMYACEA Gray, 1823

Family PLEUROMYIDAE Dall, 1900

Genus **PLEUROMYA** Agassiz, 1842

(Synonyms: *Myacites* Schlotheim, auctt.; *Amphidesma* Phillips, 1829 (non Lamarck);

Myopsis Agassiz, 1842 (pars); *Anaplomya* Kraus, 1843; *Hapalomya* Roeder, 1882;

? *Fogiella* Krumbeck, 1913)

Type species. Subsequent designation; Herrmannsen 1847, p. 297; *Mya gibbosa* J. de C. Sowerby 1823, p. 19, pl. 419 (= *Donacites alduini* Brongniart 1821, p. 571, pl. 7, figs. 6a, 6b); Upper Oxford Clay, near Weymouth, Dorset.

Diagnosis. Subequivalve, right valve slightly larger than left, oval, oblong or trapeziform, moderately to strongly inflated; umbones placed within anterior half, and generally close to anterior margin, inflated, not prominent; lunule and escutcheon absent; no true hinge teeth. Main part of ligament external, opisthodontic, with short nymphs; below and anterior to umbones of each valve is a short rounded protuberance; deep pallial sinus, well-developed posterior gape; surface with or without concentric ribbing.

1. *Pleuromya alduini* (Brongniart, 1821) Pl. 13, figs. 5–10, 12, 151821 *Donacites alduini* sp. nov., Brongniart, p. 571, pl. 7, figs. 6a, 6b.1823 *Mya gibbosa* sp. nov., J. de C. Sowerby, p. 19, pl. 419. (*non Mactra (Lutraria) gibbosa* J. Sowerby, 1812, Inferior Oolite species).1829 *Amphidesma recurvum* sp. nov., Phillips, pl. 5, fig. 25.1835 *Panopaea oblata* nom. nov., J. de C. Sowerby, p. 1 (*pro Mya gibbosa* J. de C. Sowerby, 1823).1851 *Potamomya? sowerbyii* sp. nov., Forbes, p. 112, pl. 5, figs. 2a, 2b.1860 *Homomya oblata* (J. de C. Sowerby); Damon, pl. 3, fig. 4.1863 *Myacites recurvum* (Phillips); Lycett, p. 81, pl. 36, figs. 4a, 4b.1871 *Myacites recurvus* (Phillips); Phillips, pl. 13, fig. 28.1910 *Donacites (Pleuromya) alduini* Brongniart; Cossmann, no. 230.1915 *Pleuromya agassizi* Chapuis; Krenkel, p. 331, pl. 27, fig. 6.1934 *Pleuromya alduini* (Brongniart); Arkell, p. 321, pl. 44, figs. 1–9.1934 *Pleuromya recurva* (Phillips); Stoll, p. 14, pl. 1, fig. 44.1948 *Pleuromya alduini* (Brongniart); Cox & Arkell, p. 40.

Holotype. Brongniart collection, MHNP; figured Cossmann 1910, No. 230; from "Writhenterton, England" (probably Winterton, Lincolnshire, from Boulder Clay; Arkell 1934, p. 323).

Measurements.

	L	H	I	AL
N	70	70	48	67
\bar{x}	39.4 mm	69.2%	49.8%	27.9%
Max	65.9	87.4	67.4	35.7
Min	18.5	53.8	37.1	20.7
OR	47.4	33.2	30.3	15.0

Description. Large species, inequilateral, subequivalve, right valve overlapping left along dorsal margin; subrectangular to elongate subtrigonal in outline, with posterior margin often produced into a rounded angle. Umbones situated close to anterior margin, prosogyrate, often contiguous, not very prominent, elevated up to 6 mm above dorsal margin. Anterodorsal margin merged into anterior margin, gently concave to gently convex, truncate, forming about a right angle with posterodorsal margin at umbo; posterodorsal margin straight to gently concave, often subparallel to ventral margin; posteroventral angle produced and acutely rounded, passing evenly into strongly convex ventral margin; anteroventral angle rounded, forming an angle of *c.* 90° with ventral margin; anterior part of ventral margin and anterior part of posterodorsal margin often parallel, then swinging round posterodorsally towards posterior angle. Lunule and escutcheon absent, but the area on the dorsal margin immediately anterior to umbones is often deeply excavated; ligament external, opisthodontic, inserted upon short prominent nymphs. Ornament of prominent, regularly spaced concentric ribs, becoming wider away from umbones; superimposed upon this pattern are very fine concentric growth lines, well seen in specimens from the Lower Calcareous Grit (Oxfordian) which retain the shell; radial elements absent. In a few specimens, a faint shallow sulcus runs from umbones to ventral margin, reaching margin just behind anteroventral angle and causing a slight sinuosity in anterior part of ventral margin.

No true hinge teeth present, only a small rounded protuberance of dorsal margin below and slightly anterior of umbo of each valve, the protuberance being hollowed out above, with a small niche behind; protuberance of right valve fits above that of left valve, a small internal ligament possibly occupying the space between them (Cox 1969, p. N842). Anterior adductor muscle scar subrectangular, elongated dorsoventrally, *c.* 6 mm high, posterior scar suborbicular, 6 mm long by 5 mm high; pallial sinus well-developed, lower limb not confluent with pallial line. Prominent posterior gape in most specimens, slight anterior gape in a few.

Remarks. The synonymy of *P. alduini* is fully listed and discussed by Arkell (1934, p. 321), and little need be added about this long-ranging species of wide geographical extent.

Study of large populations reveals the extreme nature of variation in this species, both height and inflation having a range of over 30%. There is, however, no consistent pattern of variation

at different stratigraphical levels, and the evidence indicates the presence of a single species, ranging from the Bathonian to the Kimmeridgian. As noted by Arkell (1934, p. 323), *P. alduini* appears to have had a preference for clay environments, being particularly common at certain levels in the Oxford and Kimmeridge Clays. The small specimens found so commonly at the top of the *grossourei* Subzone at Peterborough are typical of the species in all respects, although crushing has affected the inflation, which it is not possible to measure. Uncrushed specimens from septarian concretions in the Lower Oxford Clay of Wiltshire (OUM J28241-42) show the forms present in the Lower Oxford Clay to be exactly comparable with those from the Red Nodule Beds (Upper Oxford Clay) of Weymouth, and elsewhere in the Oxford Clay.

It differs from *P. uniformis* (J. Sowerby) in possessing strong regular concentric ribs, and in being relatively higher and more inflated. *P. calceiformis* (Phillips) is much more elongate than *P. alduini*, and is also smooth-shelled.

Range and occurrence. Fullers Earth Rock (Bathonian) of Dorset and Somerset (Arkell 1939, p. 170); Belemnite Sands (Bathonian) of Staffin Bay, Skye; Cornbrash, Kellaways Beds, Oxford Clay, Corallian Beds and Lower Kimmeridge Clay of Britain, widespread. Callovian to Kimmeridgian age, in France, Germany and Russia.

2. *Pleuromya uniformis* (J. Sowerby, 1813) Pl. 13, figs. 11, 14, 18, 21

- 1813 *Unio uniformis* sp. nov., J. Sowerby, p. 83, pl. 33, fig. 4.
 1821 *Lutraria? jurassi* sp. nov., Brongniart, p. 555, 570, pl. 7, figs. 4-4b.
 1829 *Amphidesma decurtatum* sp. nov., Phillips, pl. 7, fig. 11.
 1836 *Lutraria tenuistriata* sp. nov., Münster in Goldfuss, p. 257, pl. 153, figs. 2a-2c.
 1836 *Lutraria elongata* sp. nov., Münster in Goldfuss, p. 258, pl. 153, figs. 4a, 4b.
 1840 *Amphidesma? ovale* sp. nov., J. de C. Sowerby, pl. 21, fig. 11.
 1840 *Amphidesma? hians* sp. nov., J. de C. Sowerby, pl. 21, fig. 12.
 1851 *Potamomya? sedgwickii* sp. nov., Forbes, p. 113, pl. 5, figs. 3a, 3b.
 1855 *Myacites terquemea* (Buvignier); Morris & Lycett, p. 115, pl. 12, figs. 6, 6a. (*non* Buvignier).
 1855 *Myacites securiformis* (Phillips); Morris & Lycett, p. 136, pl. 13, fig. 15. (*non* Phillips).
 1855 *Myacites decurtatus* (Phillips); Morris & Lycett, p. 137, pl. 15, figs. 10a, 10b.
 1860 *Myacites decurtatus* (Phillips); Damon, pl. 4, fig. 6.
 1888 *Myacites jurassi* (Brongniart) var. *portlandica* nov., Damon, pl. 19, fig. 9.
 1910 *Lutraria (Pleuromya) jurassi* Brongniart; Cossmann, no. 231.
 1915 *Pleuromya tellina* Agassiz; Krenkel, p. 329, pl. 27, fig. 7.
 1915 *Pleuromya polonica* sp. nov., Krenkel, p. 330, pl. 27, fig. 5.
 1932 *Pleuromya decurtata* (Phillips); Spath, p. 117, pl. 6, fig. 5; pl. 7, fig. 6.
 1934 *Pleuromya jurassi* (Brongniart); Stoll, p. 14, pl. 1, fig. 47.
 1935 *Pleuromya uniformis* (J. Sowerby); Cox, p. 15, pl. 2, figs. 9, 10.
 1935 *Pleuromya uniformis* (J. Sowerby); Arkell, p. 325, pl. 45, figs. 1-13.
 1936 *Pleuromya tellina* Agassiz; Spath, p. 128, pl. 45, figs. 4a, 4b; pl. 50, figs. 1a, 1b.
 1948 *Pleuromya uniformis* (J. Sowerby); Cox & Arkell, p. 40.
 1965 *Pleuromya uniformis* (J. Sowerby); Cox, p. 131, pl. 20, fig. 6.

Holotype. BM 43224; figured J. Sowerby 1813, p. 83, pl. 33, fig. 4; from the Cornbrash of Felmersham, Bedfordshire.

Measurements.

	L	H	I	AL
N	29	29	18	29
\bar{x}	39.3 mm	58.4%	40.2%	34.3%
Max	71.2	74.1	45.5	41.9
Min	27.1	49.8	33.1	29.3
OR	44.1	24.3	12.4	12.6

Description. Large species, elongate-elliptical to subrectangular in outline, inequilateral, subequivalve, with right valve slightly overlapping left along dorsal margin. Umbones placed about one-third of shell length behind anterior margin, prosogyrate, contiguous, not prominent or inflated, elevated up to *c.* 4 mm above dorsal margin. Anterodorsal margin short, gently

concave, with no lunule, passing smoothly into evenly rounded anterior margin; anteroventral angle variable, usually rounded and not angular, but becoming almost a right angle in forms with very strong anterior sulcus; ventral margin long and very gently convex, with variably developed sinuosity near anterior extremity marking position of anterior sulcus; convexity of ventral margin becomes stronger posteriorly, where it passes smoothly into posterior margin; clearly defined posteroventral and posterodorsal angles lacking, posterior margin passing evenly into dorsal and ventral margins. Escutcheon absent; ligament external, opisthodontic, nymph short but clearly defined.

Ornament of fine concentric growth lines, with irregularly spaced growth rugae being developed to variable extents in most specimens; occasionally almost smooth; very well-preserved specimens show the whole of shell surface covered with minute radial threads. Posterior adductor muscle scar suborbicular, placed very close to dorsal margin, at the point where posterior margin begins to diverge from it; anterior adductor scar unknown; pallial line with large pallial sinus reaching halfway to anterior margin, its lower limb not confluent with pallial line. Dentition unknown. Margins closed, with no anterior or posterior gapes.

Remarks. The synonymy of *P. uniformis* has been discussed fully by Arkell (1935, p. 327), and Cox & Arkell (1948, p. 40). The species has been given many names by continental authors, the most common being *P. jurassi* (Brongniart), *P. tellina* Agassiz, *P. voltzi* Agassiz and *P. elea* (d'Orbigny). Arkell has shown that all these names refer to the same species, the earliest available name being *P. uniformis* (J. Sowerby), a name overlooked until Cox (1935, p. 15) used it for specimens from the "Argovian" (Lower Oxfordian) of India. Sowerby's name appears to have been overlooked because it was assigned to *Unio*, a freshwater genus.

The range of variation in this species, as in *P. alduini*, is very great, but attempts to separate stratigraphically distinct populations into discrete species or varieties have not been successful, as an overlapping range of variation occurs at all levels from the Inferior Oolite to the Portland Beds (Arkell 1935, p. 327; Lewinski, 1923, p. 80).

P. calceiformis (Phillips), from the Corallian Beds, resembles *P. uniformis* in that it lacks regular concentric ribs, but is much more elongate ($H \bar{x} 43.0\%$), and has the posterior part of the shell produced. *P. uniformis* occurs most commonly in sandy and calcareous deposits, being rather rare in shales and clays, and thus there appears to be ecological separation between it and *P. alduini*.

Range and occurrence. Inferior Oolite to Portland Beds of Great Britain; especially common in the Fullers Earth Rock, Cornbrash, Kellaways Rock, Corallian Beds, Kimmeridge Clay and Portland Beds; Upper Oxford Clay of Dorset. Bathonian to Portlandian of France, Germany, Switzerland, Russia and Poland; Upper Jurassic of Greenland and India.

Superfamily PANDORACEA Rafinesque, 1815

Family THRACIIDAE Stoliczka, 1870

Genus **THRACIA** Leach, in J. de C. Sowerby, 1823

(Synonyms: *Osteodesma* de Blainville, 1825; *Odoncineta* Costa, 1829; *Corymya* Agassiz, 1843;

Homoeodesmata Fischer, 1887; *Eximiothracia* Iredale, 1924; *Cetothrax* Iredale, 1949)

Type species. Subsequent designation; Anton 1839, p. 2; *Thracia pubescens* Lamarck 1819, p. 83 (= *Mya pubescens* Pulteney 1799, p. 27, pl. 4, fig. 6); Recent, Atlantic Ocean.

Diagnosis. Subequilateral, inequivalve, right valve larger than left, which it overlaps; umbones opisthogyrate, prominent; adductor scars small, pallial line with sinus; posterior margin truncate, with a gape; faint umbonal ridge runs to posteroventral margin.

Subgenus **THRACIA** s.s.

Diagnosis. Shell with concentric ornament, surface granulate; umbones contiguous and perforate; ligament external; cardinal plate with fissure occupied by lithodesma; chondrophore moderately long.

Remarks. Some authors (Agassiz 1843; Stoliczka 1871) have used the genus *Corymya* Agassiz for the Jurassic species referred to *Thracia*, but as Terquem (1855, p. 93) and Arkell (1936, p. 354) pointed out, there is no satisfactory evidence for separating Mesozoic from Tertiary and Recent species, and so *Thracia* is retained. Jurassic forms occur only as steinkerns, often crushed, with some thin remnant shell; details of the dentition therefore are not seen, although the position of the external ligament nymphs is clear.

Thracia (Thracia) depressa (J. de C. Sowerby, 1823) Pl. 13, figs. 13, 19, 20, 22, 23, 28;
Text-fig. 40

1823 *Mya depressa* sp. nov., J. de C. Sowerby, p. 19, pl. 418.

1836 *Mya* or *Panopaea depressa* J. de C. Sowerby; J. de C. Sowerby in Fitton, p. 347, pl. 23, fig. 9.

1836 *Tellina incerta* sp. nov., Thurmann in Roemer, p. 121, pl. 8, figs. 7a, 7b.

1888 *Thracia depressa* (J. de C. Sowerby); Damon, pl. 19, fig. 14.

1892 *Thracia depressa* (J. de C. Sowerby); Fox-Strangways, p. 378, pl. 21, fig. f.

1911 *Thracia incerta* (Thurmann); Boden, p. 55, pl. 5, figs. 21, 22.

1929 *Thracia depressa* (J. de C. Sowerby); Cox, p. 172, pl. 5, fig. 3.

1934 *Thracia undulata* (Schlippe); Stoll, p. 16, pl. 2, fig. 2.

1936 *Thracia depressa* (J. de C. Sowerby); Arkell, p. 354, pl. 50, figs. 7-10.

1948 *Thracia depressa* (J. de C. Sowerby); Cox & Arkell, p. 46.

Neotype. Designated herein. BM L6979; figured Damon 1888, pl. 19, fig. 14; Oxford Clay of Weymouth, Dorset.

Measurements.

	L	H	I	AL
N	36	36	14	36
\bar{x}	46.4 mm	74.1%	41.7%	60.5%
Max	65.1	92.3	60.8	69.4
Min	19.9	63.7	29.9	51.2
OR	45.2	28.6	30.9	18.2

Description. Large species, inequilateral, inequivalve, with right valve larger than the left valve; subtrigonal, subrectangular to elongate-elliptical in outline, very variable; umbones prominent, opisthogyrate, contiguous, placed posterior to median, bounded posteriorly by strongly-developed ligament nymphs. Anterodorsal margin gently convex, steepness of slope to the anterior margin dependent upon the height of the shell; posterodorsal margin strongly to gently concave, the area immediately posterior to the umbones being occupied by the short, but prominent, ligament nymphs. Anterior margin evenly rounded, passing smoothly into the gently convex ventral margin; posterior margin slightly rostrate, with variably developed umbonal carina marking off posterior area, truncate or rounded in outline, with strong posterior gape. Inflation very variable, point of maximum inflation located *c.* 30% of height below dorsal extremity of umbones. Lunule absent, but area anterior to umbones marked by a deep channel; ligament opisthodontic, nymphs producing a bisulcate feature on dorsal margin immediately posterior to umbones; escutcheon absent. Sculpture of irregularly spaced growth lines, occasionally coarsened into rugae, sometimes crossed by very fine radial threads.

Dentition unknown. Pallial line with large pallial sinus, lower limb of the sinus nearly confluent with pallial line.

Remarks. All intermediates between relatively short, high, subtrigonal forms and lower, elongate-elliptical forms may usually be found in large collections of this species. The variation which occurs in examples from the Upper Oxford Clay, Corallian Beds, Kimmeridge Clay and Portlandian has been discussed by Arkell (1936, p. 355). The same range of variation is to be found in the Lower and Middle Oxford Clay specimens which are, unfortunately, always crushed. There is a tendency for the Lower Oxford Clay forms to be slightly more elongate than forms from high in the Oxfordian, as may be seen from the measurements in Table 3, but such is the variation

TABLE 3. Comparison of measurement statistics for populations of *Thracia* (*Thracia*) *depressa* from Lower and Upper Oxford Clay.

	LOWER OXFORD CLAY			UPPER OXFORD CLAY		
	H	AL	H	I	AL	
N	20	20	16	14	16	
\bar{x}	70.5%	61.3%	78.6%	41.7%	59.4%	
Max	77.1	66.9	92.3	60.8	69.4	
Min	63.7	54.3	71.5	29.9	51.2	
OR	13.4	12.6	20.8	30.9	18.2	

range, that forms agreeing exactly in shape with Upper Oxfordian examples are often found, and there is no justification for considering them to be different species. Regression lines for the two stratigraphically separated groups are shown in Text-fig. 40, and although they have slightly different intercepts on the y axis, they have similar slopes, and are not significantly different. It is likely that shell proportions have been slightly distorted by crushing in the Lower Oxford Clay, but it is improbable that the differences in form are due to this effect.

Thracia incerta (Thurmann *in* Roemer) has been accepted as a distinct Kimmeridgian and Portlandian species by many authors (Goldfuss 1836; Agassiz 1843; Leymerie 1846; Thurmann

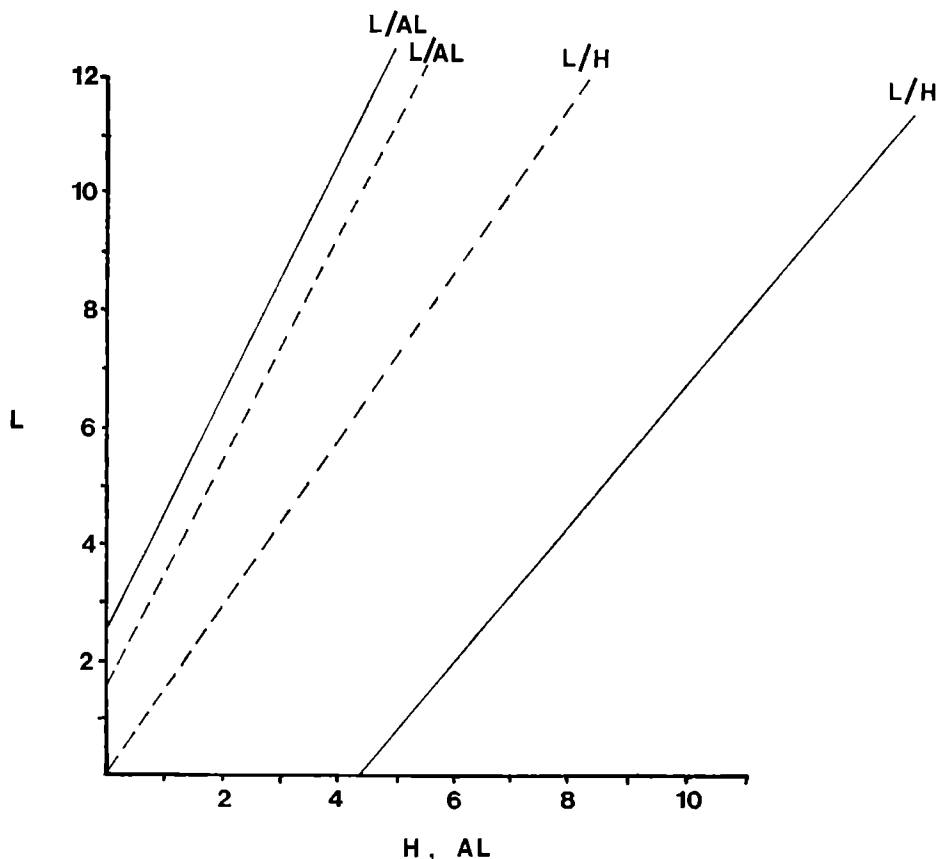

TEXT-FIG. 40. Comparison of the Length/Height and Length/Anterior Length regression lines for populations of *Thracia* (*Thracia*) *depressa* (J. de C. Sowerby), from the Lower (dashed lines) and Upper (unbroken lines) Oxford Clay of England. The L/AL regressions for the two horizons compare closely, but those for L/H vary considerably, with the Upper Oxford Clay forms being higher and less elongate. Scale in mm.

& Étallon 1861-64; de Loriol *in de Loriol & Cotteau* 1868; *in de Loriol, Royer & Tombeck* 1872; *in de Loriol & Pellat* 1875; Lewinski 1923; Cox 1929). The species supposedly differs from *T. depressa* in being more elongate, and having anteriorly placed umbones. Thurmann's figure (*in Roemer* 1836, pl. 8, figs. 7a, b) shows a form indistinguishable from typical British Oxfordian forms, and the author sees no reason to retain it as a distinct species. There are, however, very elongate forms (H 66.3%) with anterior umbones (AL 45.3%) in the English Portland Beds, which Cox (1929, p. 173, pl. 5, fig. 6) referred to *T. incerta*, which may represent a separate species; study of large collections should resolve the issue.

Range and occurrence. Fullers Earth (Bathonian) of Somerset and Dorset (Arkell 1939a, p. 171), throughout the Oxford Clay, and at various horizons in the Corallian Beds, Kimmeridge Clay and Portland Beds, widespread. Upper Jurassic (Callovian to Portlandian) of France, Germany, Switzerland and Russia.

INCERTAE SEDIS

The two species described below are too small and poorly preserved to allow generic or even familial placement, although it seems probable that they belong to the subclass Anomalodesmata.

Anomalodesmatan sp. A. Pl. 13, figs. 16, 17, 27

Description. Small species, equi- or inequilateral, subrectangular to subovate in outline. Umbones small, rounded, contiguous, placed about one-third of shell length behind ? anterior margin, only very slightly salient to hinge margin. Posterodorsal margin passing smoothly into evenly-rounded posterior margin, without clearly marked posterodorsal angle, posteroventral angle often more apparent, forming a rounded right angle, or occasionally, a more even curve; ventral margin straight to gently convex, subparallel to posterodorsal margin; anterodorsal margin gently concave, passing into short, sharply-curved anterior margin; anteroventral angle sharply rounded; in some specimens, anterior part of ventral margin straight, and oblique to posterodorsal margin, giving anterior part of shell a slightly rostrate appearance. Inflation low.

Ornament of low concentric growth striae and rugae, placed rather irregularly, and of variable strength; no radial elements. Shell of friable aragonite.

Measurements.

	L	H	AL
N	26	26	19
\bar{x}	9.4 mm	69.3%	35.2%
Max	14.0	80.2	38.7
Min	5.5	60.2	30.0
OR	8.5	20.0	8.7

Remarks. This small species is widespread in all lithologies of the Lower Oxford Clay of southern England, but is always poorly preserved, and its taxonomic position uncertain. It is preserved as clay steinkerns, often of articulated, wide-open shells, with a very thin layer of aragonitic shell material on the outer surface; because of this, nothing is known of the ligament, cardinal area or musculature, there being no sign of muscle scars on either the steinkerns or the shell material. Because the orientation of the shells is unknown, there is no means of telling whether the umbones are prosogyrate or opisthogyrate.

In external form, this species is unlike any other known from the Lower Oxford Clay, although the ornament is reminiscent of some *Pleuromya* species; however, the early growth stages of both *Pleuromya alduini* and *P. uniformis* do not fit the outline of the material described here. The larger specimens are markedly inequilateral, the posterior region being much more expanded than the rather narrow anterior region, and again, the outline does not agree with small specimens of *P. alduini* or *P. uniformis*; there is also no indication of any shell gapes. The only other Lower Oxford Clay species which is in any way comparable is *Thracia depressa*, which occasionally shows forms similar in shape to this species, and which generally occurs in the same beds, although more

rarely. However, in general, the shape of the early growth lines of *T. depressa* is different. Some Recent species of *Thracia*, such as the type species *T. pubescens* (Pulteney), resemble this species in that they have one end (the anterior) very fully expanded, whilst the other is more rostrate.

Range and occurrence. Lower Oxford Clay (*calloviense* to *athleta* zones) of central and southern England; very common.

Anomalodesmatan sp. B. Pl. 13, figs. 24–26

Description. Small species, equivalve, subequilateral, subovate in outline, with umbones slightly anterior of median; umbones small, rounded, hardly salient above hinge line, prosogyrate. Anterodorsal margin gently concave to gently convex, forming a continuous even curve with anterior margin; ventral margin gently convex, not as curved as anterior and posterior margins, and passing smoothly into them without angulations; posterior margin evenly convex, curved smoothly with posterodorsal margin. Usually rather elongate, with an almost straight ventral margin, but smaller forms tend to be shorter and more perfectly ovate, with a higher L/H ratio. Inflation low.

Ornament faint, of very fine, irregularly spaced concentric growth lines, occasionally with faint growth rugae; no radial elements. Shell of very thin, friable aragonite.

Measurements.

	L	H	AL
N	12	12	7
\bar{x}	7.8 mm	66.7%	44.2%
Max	9.6	70.5	50.0
Min	5.6	61.7	37.9
OR	4.0	8.8	12.1

Remarks. Preservation is similar to that of the preceding species, and again, nothing can be seen of the ligament, cardinal plate or musculature. The shell is thinner than in *Anomalodesmatan* sp. A., and is rarely preserved, except in patches along the dorsal margin; removal of the shell in that area does not help in the elucidation of the structure of the cardinal plate, as the shell has not been deeply enough impressed into the rock. The ornament pattern is much finer than in the preceding species, and parallels the shape of many bivalve genera, making generic placement impossible. This species is much rarer than sp. A., although it occurs sporadically throughout the Lower Oxford Clay of southern England, and does not seem to be associated with any other species of which it could possibly be a juvenile stage.

Range and occurrence. Lower Oxford Clay (*jason* to *athleta* zones) of central and southern England, widespread, but nowhere abundant.

REFERENCES

- ADAMS, H. & ADAMS, A. 1854–58. *The genera of Recent Mollusca arranged according to their organisation*. 2, 661pp. London.
- AGASSIZ, L. 1842–45. *Études critiques sur les Mollusques fossiles. Monographie des Myes*. 287pp., 93 pls. Neuchâtel.
- AGRAWAL, S. K. 1956. Contribution à l'étude stratigraphique et paléontologique du Jurassique du Kutch (Inde). *Ann. Centre d'Étude Doc. Paléont.*, 19, 1–188, pls. 1–12.
- ALLEN, J. A. 1958. On the basic form and adaptations of habitat in the Lucinacea (Eulamellibranchia). *Phil. Trans. R. Soc. (B)*, 241, 421–84, pl. 18.
- ANDREWS, C. W. 1910–13. *A descriptive catalogue of the marine reptiles of the Oxford Clay*. 1 (1910), xxiv + 205pp., 10 pls.; 2 (1913), xxiv + 206pp., 13 pls. London.
- ANTON, H. E. 1839. *Verzeichniss der Conchylien welche sich in der Sammlung von H. E. Anton befinden. Herausgegeben von dem Besitzer*. xvi + 110pp. Halle.
- APPLEBY, R. M. 1956. The osteology and taxonomy of the fossil reptile *Ophthalmosaurus*. *Proc. zool. Soc. Lond.*, 126, 403–47, pls. 1–3.
- 1967. The reptile families Ichthyosauridae and Ophthalmosauridae. *Proc. geol. Soc. Lond.*, no. 1640, 137–8.
- ARCHIAC, A. D'. 1843. Description géologique du département de l'Aisne. *Mém. Soc. géol. Fr.*, 5, 129–419, pls. 21–31.

- ARKELL, W. J. 1926. Studies in the Corallian lamellibranch fauna of Oxford, Berks., and Wilts. II. Pectinidae. *Geol. Mag.*, **63**, 534-55, pls. 31-34.
- 1927. The Corallian rocks of Oxford, Berks., and north Wilts. *Phil. Trans. R. Soc. (B)*, **216**, 67-181, pls. 1, 2.
- 1929-37. A monograph of British Corallian Lamellibranchiata. *Palaeontogr. Soc. [Monogr.]*: (1), 1929, 1-72, pls. 1-4; (2), 1930, 73-104, pls. 5-8; (3), 1931, 105-32, pls. 9-12; (4), 1932, 133-80, pls. 13-20; (5), 1933, 181-228, pls. 21-28; (6), 1934, 229-76, pls. 29-36; (7), 1934, 277-324, pls. 37-44; (8), 1935, 325-50, i-xvi, pls. 45-49; (9), 1936, 351-76, xvii-xxii, pls. 50-56; (10), 1937, 377-92, xxiii-xxxviii, Title-page and Index.
- 1930a. The generic position and phylogeny of some Jurassic Arcidae. *Geol. Mag.*, **67**, 297-310, 337-52, pls. 14-16.
- 1932a. An unknown Kellaways locality in Dorset? *Geol. Mag.*, **69**, 44-45.
- 1933a. *The Jurassic System in Great Britain*. 681pp. Oxford.
- 1934a. The oysters of the Fullers Earth; and on the evolution and nomenclature of the Upper Jurassic *Catinulas* and *Gryphaeas*. *Proc. Cotteswold Nat. Fld Club*, **25**, 21-68, pls. 1-5.
- 1939. The Richardson collection of lamellibranchs from the Fullers Earth Rock. *Proc. Dorset nat. Hist. antiq. Fld Club*, **60**, 165-74.
- 1939a. The ammonite succession at the Woodham Brick Company's pit, Akeman Street Station, Buckinghamshire, and its bearing on the classification of the Oxford Clay. *Q. Jl geol. Soc. Lond.*, **95**, 135-222, pls. 8-11.
- 1940. Fossils from the Fullers Earth of the Weymouth Anticline. *Geol. Mag.*, **77**, 42-49, pl. 1.
- 1941. The Upper Oxford Clay at Purton, Wiltshire, and the zones of the Lower Oxfordian. *Ibid.*, **78**, 161-72, 316.
- 1947. The geology of the country around Weymouth, Swanage, Corfe and Lulworth. *Mem. geol. Surv. U.K.* xii + 386pp., 19 pls.
- 1947a. *The Geology of Oxford*. 267pp., 6 pls. Oxford.
- BAYLE, E. 1878. *Fossiles principaux des terrains. Explication de la Carte géologique de France*. **4**, (1), Atlas. 158 pls. Paris.
- BEAN, W. 1839. Catalogue of fossils in the Cornbrash of Scarborough. *Ann. Mag. nat. Hist. n.s.*, **3**, 57-62.
- BEURLEN, K. 1958. Die Exogyren. Ein Beitrag zur phyletischen Morphogenese der Austern. *Neues Jahrb. Geol. Paläont. Monatsh.* (5), 197-217.
- BEYRICH, H. E. VON. 1845. *Protocardia*, eine neue Gattung fossiler Muscheln. *Zeitsch. f. Malakozool.* **2**.
- BLAINVILLE, H. M. D. DE. 1821. GRYPHÉE, *Griphoea* (Conchyl.): in *Dictionnaire des Sciences Naturelles* (Edit. 2, **19**, 540pp.), p. 533. Paris.
- 1825-27. *Manuel de Malacologie et Conchologie*. viii + 664pp., 109 pls. Paris & Strasbourg.
- BLAKE, J. F. 1905-07. A monograph of the fauna of the Cornbrash. *Palaeont. Soc. [Monogr.]*: (1), 1905, 1-100, pls. 1-9; (2), 1907, 101, 102, Title-page and Index.
- BODEN, K. 1911. Die Fauna des Unteren Oxford von Popilany in Lithauen. *Geol. paläont. Abh., n.s.*, **10**, 125-200, pls. 1-8.
- BORISSIAK, A. 1904. Die Pelecypoden der Jura-Ablagerungen im Europaischen Russland. I. Nuculidae. *Trudy geol. Kom. n.s.*, **11**, 1-49, pls. 1-3.
- 1905. *Idem*. II. Arcidae. *Ibid.*, **19**, 1-63, pls. 1-4.
- 1909. *Idem*. IV. Aviculidae. *Ibid.*, **44**, 1-26, pls. 1-2.
- BOSC, L. A. G. 1802. *Histoire naturelle des coquilles*. 5 volumes. (1st edit.) Paris.
- BOWDICH, T. E. 1822. *Elements of Conchology, including the fossil genera and the animals*. London.
- BRANSON, C. C. 1942. *Parallelodon*, *Grammatodon* and *Beushausenia* (= *Cosmetodon* new name). *J. Paleont.*, **16**, 247-9.
- BRINKMANN, R. 1929. Statistisch-Biostratigraphische Untersuchungen an Mitteljurassischen Ammoniten über Artbegriff und Stammesentwicklung. *Abh. Akad. Wiss. Göttingen, Math. Phys. Kl. n.f.*, **13**, (3), 1-249, pls. 1-5.
- 1929a. Monographie der Gattung *Kosmoceras*. *Ibid.*, **13**, (4), 1-124, pl. 1.
- BRONGNIART, A. 1821. Sur les Caractères Zoologiques des Formations. *Annl. Mines. Carbur.*, Paris, **6**, 537-72, pls. 7, 8.
- 1823. *Mémoire sur les terrains de sédiment supérieurs calcaréo-trappéens du Vincentin*. 86pp., 6 pls., Paris.
- BRONN, H. G. 1829. Verzeichniss der in dem Heidelberger Mineralien-Komptoir vorhandenen Konchylien-Pflanzenztheil und andern Versteinerungen. *Z. Miner. Geol. Paläont.*, **23**, (1), 72-80.
- 1830. *Goea Heidelbergensis, oder Mineralogische Beschreibung der Gegend von Heidelberg*. xii + 237pp. Heidelberg & Leipzig.
- BROWN, T. 1837-49. *Illustrations of the Fossil Conchology of Great Britain and Ireland*. viii + 273pp., 98 pls. London & Edinburgh.
- BUCKMAN, J. 1844. Descriptions of the new species of fossils. In R. I. MURCHISON "Outline of the geology of the neighbourhood of Cheltenham", 2nd edit., 93-106, pls. 1-13.
- BUCKMAN, S. S. 1909-30. *Yorkshire Type Ammonites*, vols. **1**, **2**; *Type Ammonites*, vols. **3-7**, London.
- 1913. The "Kelloway Rock" of Scarborough. *Q. Jl geol. Soc. Lond.*, **69**, 152-68.
- BUVIGNIER, A. 1852. *Statistique géologique, minéralogique, minéralurgique et paléontologique du département de la Meuse*. Atlas. 52pp., 32 pls. Verdun.
- CALLOMON, J. H. 1955. The ammonite succession in the Lower Oxford Clay and Kellaways Beds at Kidlington, Oxfordshire, and the zones of the Callovian stage. *Phil. Trans. R. Soc. (B)*, **239**, 215-63, pls. 2, 3.
- 1964. Notes on the Callovian and Oxfordian stages. *C.r. Mém. Coll. Jurassique, Luxembourg*, 1962, 269-91.

- 1968. The Kellaways Beds and Oxford Clay. In SYLVESTER-BRADLEY, P. C. & FORD, T. D. (eds.). *The Geology of the East Midlands*, 264–90. Leicester.
- CALLOMON, J. H. & COPE, J. C. W. 1971. The stratigraphy and ammonite succession of the Oxford and Kimmeridge Clays in the Warlingham Borehole. *Bull. geol. Surv. Gt Br.*, **36**, 147–76, pls. 6–12.
- CARPENTER, P. P. 1859. List of British Mollusca purchased from Mr. P. P. Carpenter. *Ann. Rep. N. Y. State Cab. Nat. Hist.*, **12**, 102–5.
- CARTER, J. 1886. On the decapod crustaceans of the Oxford Clay. *Q. Jl geol. Soc. Lond.*, **42**, 542–59, pl. 16.
- CARTER, R. M. 1967. On the nature and definition of the lunule, escutcheon and corcelet in the Bivalvia. *Proc. malac. Soc. Lond.*, **37**, 243–63, pls. 1, 2.
- CASEY, R. 1952. Some genera and subgenera, mainly new, of Mesozoic heterodont lamellibranchs. *Ibid.*, **29**, 121–76, pls. 7–9.
- CHARLES, R. P. 1949. Essai d'étude phylogénique des gryphées liasiques. *Bull. Soc. géol. Fr.*, (5), **19**, pt. 1–3, 31–41.
- CHAVAN, A. 1945. Les lamellibranches hétérodontes des Sables Astartiens de Cordebugle (Calvados). *J. Conch.*, **86**, (2), 41–86, pl. 1.
- 1946. L'évolution des faunes marines des mollusques dans le nord-ouest de l'Europe, de la fin du Crétacé à celle de l'Éocène. *Bull. Soc. géol. Fr.*, (5), **16**, 193–212.
- 1952. Les pélicypodes des Sables Astartiens de Cordebugle (Calvados). *Abh. schweiz. paläont. Ges.*, **69**, 1–132, pls. 1–4.
- 1969. Superfamilies Lucinacea, Crassatellacea. In MOORE, R. C. (ed.). *Treatise on Invertebrate Paleontology. Part N. Mollusca 6, Bivalvia*. N491–N518, N562–82, Boulder.
- CHILDREN, J. G. 1822–24. Lamarck's genera of shells. *Quart. J. Sci., Lit., Arts*, **14**, 64–86, pls. 3–4 (Oct. 1822); 298–322, pl. 5 (Jan. 1823); **15**, 23–52, pls. 2–3 (Apr. 1823); 216–58, pls. 7–8 (July 1823); **16**, 49–79, pls. 5–6 (Oct. 1823); 241–64 (Jan. 1824).
- ČIRIĆ, B. M. 1951. Quelques lamellibranches de la faune sénonienne de Jaričko Brdo, près de Guča (Dragačevina-Serbie occidentale). *Bull. Mus. Hist. Nat. Pays Serbe*, (A), **4**, 61–66, pl. 1. [In Serbian.]
- COPE, J. C. W. & COX, B. M. 1970. A Kellaways Beds locality in north Dorset. *Proc. Dorset nat. Hist. archaeol. Soc.*, **91**, 120–2.
- CORROY, G. 1932. Le Callovien de la bordure orientale du bassin de Paris. *Mém. Carte géol. Fr.* vii + 337pp., 29 pls.
- COSSMANN, M. 1907. Description de quelques pélicypodes jurassiques recueillis en France. 2^e Article. *C.r. Ass. Fr. Avanc. Sci. (Congr. Lyons)*, 273–83, pls. 1, 2.
- 1908. *Idem*, 3^{em} article. *Ibid. (Congr. Reims, 1907)*, 1–14, pls. 2, 3.
- 1910. In “*Palaeontologia Universalis*”, *Centuria 3*, no. 230.
- 1915. Description de quelques pélicypodes du Bradfordien et du Callovien de Pouges-les-eaux (Nièvre). *Bull. Soc. nivern. Lett. Sci.*, (3), **15**, 1–15, pls. 1–3.
- 1920. Rectifications de Nomenclature. *Revue crit. Paléozool.* **24**, 81–83.
- 1921. Description de pélicypodes jurassiques recueillis en France. II Sér., 1^{ère} Article. *C.R. Ass. Fr. Avanc. Sci. (Congr. Strasbourg)*, 1–29, pls. 1–4.
- 1923. *Idem*, II Sér., 2^e article. *Ibid. (Congr. Montpellier, 1922)*, 1–22, pls. 5, 6.
- 1924. Extension dans les Deux-Sèvres de la faune du Callovien de Montreuil-Bellay. *Mém. Soc. géol. Minér. Bretagne*, **1**, 1–53, pls. 1–7.
- COSSMANN, M. & THIÉRY, P. 1907. Note sur le Callovien de la Haute-Marne. *Bull. Soc. Agric. Lett. Sci. Haute-Saône*, 1907, (2), 69–147, pls. 1–3.
- COSTA, O. G. DA. 1829. *Catalogo sistematico e ragionato de Testacei delle due Sicilie*. viii + 132pp., 2 pls. Naples.
- COTTREAU, J. 1925–32. Types du Prodrome de Paléontologie stratigraphique universelle d'Alcide d'Orbigny. **2**, Callovien-Portlandien. 1–222, pls. 37–68, *Annls Paléont.* **14–21**.
- COUFFON, O. 1917–19. *Le Callovien du Châlet*. Text (1917), 245pp. Atlas (1919), 18 pls. Angers.
- COX, L. R. 1925. In CUNNINGTON, R. H. Note on Geology. *Proc. Dorset nat. Hist. archaeol. Fld Club*, **46**, 196–98.
- 1929. A synopsis of the Lamellibranchiata and Gastropoda of the Portland Beds of England. *Proc. Dorset nat. Hist. archaeol. Soc.*, **1**, 131–202, pls. 1–6.
- 1935. Jurassic Gastropoda and Lamellibranchia. In *The Mesozoic Palaeontology of British Somaliland*, 148–97, pls. 14–21. London.
- 1936. The Gastropoda and Lamellibranchia of the Green Ammonite Beds of Dorset. *Q. Jl geol. Soc. Lond.* **92**, 456–71, pl. 34.
- 1937. Notes on Jurassic Lamellibranchia. I. On the occurrence of the genus *Palaeoneilo* in the Jurassic of Great Britain. *Proc. malac. Soc. Lond.*, **22**, 190–93, pl. 15.
- 1940. The Jurassic lamellibranch fauna of Kachh (Cutch). *Mem. geol. Surv. India, Palaeont. indica*, (9), **3**, (3), 1–157, pls. 1–10.
- 1941. Notes on Jurassic Lamellibranchiata. VII. On the identity of *Echinotis* Marwick with *Meleagrinnella* Whitfield. *Proc. malac. Soc. Lond.*, **24**, 133–35.
- 1947. The lamellibranch family Cyprinidae in the lower Oolites of England. *Ibid.*, **27**, 141–84, pls. 8–10.

- 1952. The Jurassic lamellibranch fauna of Cutch (Kachh). No. 3, Families Pectinidae, Amusiidae, Plicatulidae, Limidae, Ostreidae and Trigoniidae (Supplement). *Mem. geol. Surv. India, Palaeont. indica*, (9), **3**, (4), 128pp., 12 pls.
- 1964. Notes concerning the taxonomy and nomenclature of fossil Bivalvia (mainly Mesozoic). *Proc. malac. Soc. Lond.*, **36**, 39–48, pl. 1.
- 1965. Jurassic Bivalvia and Gastropoda from Tanganyika and Kenya. *Bull. Br. Mus. nat. Hist. (Geol.) Suppl.*, **1**, 213pp., 30 pls.
- 1969. General features of Bivalvia. In MOORE, R. C. (ed.) *Treatise on Invertebrate paleontology, Part N, Mollusca* 6, pp. N2–129. Boulder.
- 1969a. Superfamily Solemyacea. In MOORE, R. C. (ed.) *Ibid.*, pp. N241–3.
- 1969b. Superfamily Trigoniacea. In MOORE, R. C. (ed.) *Ibid.*, p. 471.
- 1969c. Family Oxytomidae. In MOORE, R. C. (ed.) *Ibid.*, p. N344.
- 1969d. Family Posidoniidae. In MOORE, R. C. (ed.) *Ibid.*, pp. N342–4.
- & ARKELL, W. J. 1948–50. A survey of the Mollusca of the British Great Oolite Series, primarily a nomenclatorial revision of the monographs by Morris & Lycett (1851–1855), Lycett (1863) and Blake (1905–1907). *Palaeontogr. Soc. [Monogr.]*: (1), 1948, i–xiii, 1–48, revised explanation of plates, Morris & Lycett (Bivalves) 1–15; (2), 1950, xiv–xxiv, 49–105, revised explanation of plates, Morris & Lycett (Univalves) 1–15, Lycett (Supplementary Monograph) 31–45, and Blake (Cornbrash) 2–9.
- CRICKMAY, C. H. 1930. The Jurassic rocks of Ashcroft, British Columbia. *Univ. Calif. Publ. geol. Sci.*, **19**, 23–74, pls. 2–7.
- 1930a. Fossils from Harrison Lake Area, British Columbia. *Bull. Nat. Mus. (Dept Min.) Canada*, **63**, 82–113, pls. 8–23.
- 1932. Contributions towards a monograph of the Trigoniidae. *Am. J. Sci.*, **24**, 443–64.
- CUVIER, G. L. C. F. D. & BRONGNIART, A. 1822. *La description géologique des couches des environs de Paris, parmi lesquelles se trouvent les gypses à ossements*: In CUVIER, B. *Recherches sur les ossements fossiles, où l'on rétablit les caractères de plusieurs animaux dont les révolutions du globe ont delvuit les espèces*. New edit. **2**, pt. 2, i–iv, 229–648, pls. 1A–11. Paris.
- DALL, W. H. 1903. Synopsis of the family Astartidae, with a review of the American species. *Proc. U.S. nat. Mus.*, **26**, 933–51, pls. 62, 63.
- DAMON, R. 1860. *Handbook to the geology of Weymouth and the Isle of Portland*. 199pp. London.
- 1888. *Supplement to the geology of Weymouth and the Isle of Portland*. 2nd (revised) edition. 199pp., 20 pls. London.
- DAVIES, A. M. 1916. The zones of the Oxford and Ampthill Clays in Buckinghamshire and Bedfordshire. *Geol. Mag.*, **53**, 395–400.
- DECHASEAUX, C. 1936. Pectinidés jurassiques de l'est du Bassin de Paris. *Annls Paléont.*, **25**, 1–148, pls. 1–10.
- DEFRANCE, M. J. L. 1825. Nucule (Fossiles). *Dict. Sci. nat.*, **35**, 216–19.
- DELAIR, J. B. 1958–60. The Mesozoic reptiles of Dorset. *Proc. Dorset nat. Hist. archaeol. Soc.* (1), 1958, **79**, 47–72; (2), 1959, **80**, 52–90; (3), 1960, **81**, 59–85.
- 1966. New records of dinosaurs and other fossil reptiles from Dorset. *Ibid.*, **87**, 57–66.
- DESHAYES, G. P. 1830. *Histoire naturelle des Vers. Tome seconde, "Encyclopédie Méthodique"*, vii + 256pp.
- 1839–53. *Traité élémentaire de Conchyliologie*. **1**, (1), 1839, 1–272; (2), 1853, 273–368, i–xii. Paris.
- DICKINS, J. M. 1963. Permian pelecypods and gastropods from Western Australia. *Bull. Bur. Miner. Res. Geol. Geophys. Aust.*, **63**, 150pp., 26 pls.
- DOLLFUS, A. 1863. *La faune kimmeridienne du Cap de la Hève*. Paris.
- DOLLFUS, G. F. & DAUTZENBERG, P. 1886. *Étude préliminaire des coquilles fossiles des faluns de la Touraine*. 28pp. Paris.
- DOUGLAS, J. A. & ARKELL, W. J. 1928. The stratigraphical distribution of the Cornbrash. I. The south-western area. *Q. Jl geol. Soc. Lond.* **84**, 117–78, pls. 9–12.
- 1932. *Idem* II. The north-eastern area. *Ibid.*, **88**, 112–70, pls. 10–12.
- DOUVILLÉ, H. 1921. La charnière dans les lamellibranches hétérodontes et son évolution. *Bull. Soc. géol. Fr.*, (4), **21**, 116–24.
- DUFF, K. L. 1975. Palaeoecology of a bituminous shale: The Lower Oxford Clay of central England. *Palaeontology*, **18**, 443–82.
- (In press). The Callovian Stage. In TORRENS, H. S. (ed.). *A Correlation of Jurassic Rocks in the British Isles. Spec. Rep. geol. Soc. Lond.*
- DUMÉRIL, A. M. C. 1806. *Zoologie analytique, ou méthode naturelle de classification des animaux*. xxxii + 344pp. Paris.
- EGGLETON, F. E. & DAVIS, G. M. 1962. Hinge tooth reversal in populations of Ohio Sphaeriidae. *Rep. Am. Malac. Un. Pacif. Div.*, **28**, 19, 20 (abstract).
- ETHERIDGE, R. (ed.) 1875. *Illustrations of the Geology of Yorkshire, by J. Phillips*. 3rd Revised Edition, xii + 354pp., 28 pls.
- EUDES-DESLONGCHAMPS, J. A. 1824. Mémoire sur les coquilles du genre *Gervillie*. *Mém. Soc. linn. Calvados*, **1**, 116–34, pls. 4–9.
- FALCON, N. L. & KENT, P. E. 1960. Geological results of petroleum exploration in Britain 1945–57. *Mem. Geol. Soc. Lond.*, **2**, 56pp.

- FAVRE, F. 1876. Description des fossiles du terrain Oxfordien des Alpes fribourgoises. *Abh. Schweiz. paläont. Ges.*, **3**, 1-76, pls. 1-7.
- FISCHER, P. H. 1880-87. *Manuel de conchyliologie et de paléontologie conchyliologique*. xxv + 1369pp., 23 pls. Paris.
- FITTON, W. H. 1837. Observations on some of the strata between the Chalk and the Oxford Oolite, in the south-east of England. *Trans. geol. Soc. Lond.*, (2), **4**, 103-388, pls. 1-18.
- FORBES, E. 1851. On the Estuary Beds and the Oxford Clay of Loch Staffin, in Skye. *Q. Jl geol. Soc. Lond.*, **7**, 104-13, pl. 5.
- FÖRSTER, R. 1971. Die Mecocheiridae, eine spezialisierte Familie der Mesozoischen Glypheoidea (Crustacea, Decapoda). *Neues Jb. Geol. Paläont. Abh.*, **137**, 396-421.
- FOX-STRANGWAYS, C. 1892. The Jurassic Rocks of Britain. II: Yorkshire. Tables of Fossils. *Mem. geol. Surv. U.K.* 250pp.
- 1904. The geology of the Oolitic and Cretaceous rocks south of Scarborough. *Mem. geol. Surv. U.K.* vi + 119pp.
- GILLET, S. 1924. Remarques sur le rameau d'*Avicula (Oxytoma) inaequalis* Sowerby. *Bull. Soc. géol. Fr.*, (4), **23**, 450-55.
- GIRTY, G. H. 1915. Fauna of the Wewoka Formation of Oklahoma. *Bull. U.S. Geol. Surv.* No. 544, 1-353, pls. 1-35.
- GOLDFUSS, G. A. 1833-40. *Petrefacta Germaniae*. Pt. 2. (1), 1833, 1-68, pls. 72-96; (2), 1836, 69-140, pls. 97-121; (3), 1837, 141-224, pls. 122-46; (4), 1840, 225-312, pls. 147-65. Dusseldorf.
- GOULD, S. J. 1969. The byssus of Trigonian clams: phylogenetic vestige or functional organ? *J. Paleont.*, **43**, 1125-29.
- GRAS, A. 1852. Catalogue des corps organisés fossiles du département d'Isère. *Bull. Soc. Statist. Sci. nat. Arts ind. Dép. Isère*, (2), **2**, 1-54, pls. 1-4.
- GREGORIO, A. DE' 1886. Monographie des fossiles de Ghelpla du sous-horizon Ghelplin de Gregorio. *Ann. Géol. Paléont.* 2^e Livraison, Palermo. 20pp., 6 pls.
- GUILLAUME, L. 1928. Revision des Posidonomyes jurassiques. *Bull. Soc. géol. Fr.*, (4), **27**, 217-34, pl. 10.
- GUPPY, R. J. L. 1874. On the West Indian Tertiary Fossils. *Geol. Mag.* (2), **1** 433-46, pls. 16-18.
- HALL, A. & KENNEDY, W. J. 1967. Aragonite in fossils. *Proc. R. Soc. Lond.* (B), **168**, 377-412.
- HALL, J. 1852. *Geology and Palaeontology of the country traversed by the expedition to Utah, and notes upon some of the fossils collected on the route*. In STANSBURY, H. *An expedition to the Valley of the Great Salt Lake of Utah*. App. E, 401-14, pls. 1-4. London & Philadelphia.
- & MEEK, F. B. 1856. Descriptions of new species of fossils from the Cretaceous formations of Nebraska, with observations on *Baculites ovatus* and *B. compressus*, and the progressive development of the septa in *Baculites*, *Ammonites* and *Scaphites*. *Amer. Acad. Arts Sci. Mem., Boston*, n.s. **5**, 379-411.
- HALLAM, A. 1968. Morphology, palaeoecology and evolution of the genus *Gryphaea* in the British Lias. *Phil. Trans. R. Soc.* (B), **254**, 91-128, pls. 10-12.
- & GOULD, S. J. 1975. The evolution of British and American Middle and Upper Jurassic *Gryphaea*: a biometric study. *Proc. R. Soc. Lond.*, (B), **189**, 511-42, pls. 19, 20.
- HERRMANNSEN, A. N. 1846-47. *Indicis generum malacozoorum primordia*. **1**, xxvii + 637pp. Cassel.
- HERTLEIN, L. G. 1969. Family Entoliidae. In MOORE, R. C. (ed.). *Treatise on Invertebrate Palaeontology, Part N, Mollusca* **6**, N346-47. Boulder.
- HUDLESTON, W. H. 1884-85. Contributions to the palaeontology of the Yorkshire Oolites. No. 2. Gastropoda of the Oxfordian and Lower Oolites. *Geol. Mag.* (3), **1**, **2**. (1), 1884, 49-63, pl. 3; (2), 1884, 107-15, pl. 4; (3), 1884, 145-54, pl. 6; (4), 1884, 193-204, pl. 7; (5), 1884, 241-52, pl. 8; (6), 1884, 293-303, pl. 9; (7), 1885, 49-59, pl. 2; (8), 1885, 121-29, pl. 3; (9), 1885, 151-59, pl. 4; (10), 1885, 201-07, pl. 5; (11), 1885, 252-57.
- HUDSON, J. D. & PALFRAMAN, D. F. B. 1969. The ecology and preservation of the Oxford Clay fauna at Woodham, Buckinghamshire. *Q. Jl geol. Soc. Lond.* **124**, 387-418, pls. 19, 20.
- HYATT, A. 1892. Remarks on the Pinnidae. *Proc. Boston Soc. nat. Hist.*, **25**, 335-46.
- ICHIKAWA, K. 1958. Zur Taxonomie und Phylogenie der Triadischen "Pteriidae" (Lamellibranch.) mit besonderer Berücksichtigung der Gattungen *Claraia*, *Eumorphotis*, *Oxytoma* und *Monotis*. *Palaeontographica*, (A), **111**, 131-212, pls. 21-24.
- IHERING, H. VON, 1900. On the South American species of Mytilidae. *Proc. malac. Soc. Lond.*, **4**, 84-98.
- 1907. Les mollusques fossiles du Tertiaire et du Crétacé Supérieur de l'Argentine. *Anales Museo Nac. Buenos Aires*, Sér 3, **7**, xiii + 611pp., 8 pls.
- ILOVAISKY, D. 1904. L'Oxfordien et le Séquanien des gouvernements de Moscou et de Riasan. *Bull. Soc. imp. Nat. Moscou*, n.s., **17**, 222-92, pls. 8-12.
- IREDALE, T. 1924. Results from Roy Bell's molluscan collections. *Proc. Linnaean Soc. N.S.W.*, **49**, 179-278, pls. 33-36.
- 1929. Mollusca from the continental shelf of eastern Australia. *Australian Mus. Rec.*, **17**, no. 4, 157-89, pls. 38-41.
- 1939. Mollusca, Part 1. Great Barrier Reef Exped., 1928-1929, *Sci. Rept.*, **5**, pt. 6, 209-425, pls. 1-7.
- 1949. Western Australian Molluscs. *Proc. R. zool. Soc. N.S.W.*, 1947-1948, 18-20.
- JAWORSKI, E. 1935. Review of Corroy, G. 1932, Le Callovien de la bordure orientale du Bassin de Paris. *Neues Jahrb. Mineralogie, Geologie, Paläontologie Jahrg.* 1935, pt. 3, *Hist. reg. Geologie, Paläontologie*, 884-86.
- JEFFERIES, R. P. S. & MINTON, P. 1965. The mode of life of two Jurassic species of "*Posidonia*". *Palaeontology*, **8**, 156-85, pl. 19.

- JUDD, J. W. 1875. The geology of Rutland. *Mem. geol. Surv. U.K.* xv + 320pp.
- KAUFFMAN, E. G. 1967. Coloradoan macroinvertebrate assemblages, central Western Interior, United States. In *Paleoenvironments of the Cretaceous Seaway—a Symposium*, 67–143. Golden.
- KEEN, A. M. 1969. Family Nuculidae. In MOORE, R. C. (ed.). *Treatise on Invertebrate Paleontology, Part N, Mollusca* 6, N230–31. Boulder.
- & CASEY, R. 1969. Family Arcticidae. *Ibid.* N645–50.
- KLÜPFEL, W. 1919. Über den Lothringer Jura. *Jb. preussisch. geolog. Landesanstalt für 1917*, **38**, (1), 252–346.
- KOBAYASHI, T. & TAMURA, M. 1955. Studies on the Jurassic trigonians in Japan. Part IV. The Myophorellinae from north Japan. *Japan. J. Geol. Geog.*, **26**, (1–2), 89–103, pls. 5, 6.
- KOCH, C. L. & DUNKER, W. 1837. *Beiträge zur Kenntnis des Norddeutschen Oolithgebildes und dessen Versteinerungen*. 64pp., 7 pls. Braunschweig.
- KOCH, F. 1922. Sitni prinosi poznavanju tercijarne faune u Hrvatskoj. *Glasnik Hrvatsko Prirod. Društvo, Zagreb*, **34**, 185–93.
- KRACH, W. 1951. Anisomyaria du Jurassique moyen aux environs de Cracovie. Familles: Limidae, Ostreidae, Spondylidae, Aviculidae. *Roczn. Pol. Tow. Geol.*, **20**, 333–76.
- KRAUSS, F. 1843. Über die geologischen verhältnisse der östlichen Küste des Kaplandes. *Amtl. Ber. Vers. dtsh. Naturf.*, **20**, 126–31.
- KRENKEI, E. 1915. Die Kelloway-Fauna von Popilani in Westrussland. *Palaeontographica*, **61**, 191–368, pls. 19–28.
- KRUMBECK, L. 1913. Obere Trias von Buru und Misól (Die Fogi-Schichten und Asphaltschiefer West Burus und der Athyridenkalk des Miól-Archipels). *Beiträge Geol. Niederländisch-Indien von Georg Boehm, Abt. 2, Abschnitt 1. Palaeontographica, suppl.*, **4**, (2), no. 1, 25–32, 2 pls.
- 1940. Beiträge zur Geologie von Nordbayern, XIII; Das Rhät in Nordwest-Franken. *Phys.-Med. Soz. Erlangen, Sber.*, **71**, 1–130, 6 pls.
- LAHUSEN, I. 1883. Die Fauna der jurassischen Bildungen des Rjasanschen Gouvernements. *Trudy geol. Kom.*, **1**, (1), 94pp., 11 pls.
- LAMARCK, J. B. DE. 1799. *Prodrome d'une nouvelle classification des coquilles. Mém. Soc. Hist. nat. Paris*, **1**, 69–91.
- 1801. *Système des animaux sans vertèbres*. viii + 432pp. Paris.
- 1818–19. *Histoire naturelle des animaux sans vertèbres*, **5**, 1818, 612pp.; **6**, 1819, 343pp. Paris.
- LAMPLUGH, G. W. & KITCHIN, F. L. 1911. On the Mesozoic rocks in some of the coal explorations in Kent. *Mem. geol. Surv. U.K.*, vi + 212pp.
- , — PRINGLE, J. 1923. The concealed Mesozoic rocks in Kent. *Mem. geol. Surv. U.K.* iv + 248pp., 1 pl.
- LAUBE, G. C. 1867. Die Bivalven des Braunen Jura von Balin. *Denkschr. Akad. Wiss. Wien, Math. nat. Kl.*, **27**, 11–61, pls. 1–5.
- LEACH, W. E. 1815. *Clamys*. In BREWSTER, D. *The Edinburgh Encyclopedia*, **9**, (1), 115. Edinburgh.
- LEANZA, A. F. 1942. Los pelecipodos del Lias de Piedra Pintada en el Neuquén. *Inst. Museo Univ. Nac. de la Plata. Rev. Mus. la Plata, Paleontologia*, **2**, (10), 143–206.
- LEBKÜCHNER, R. 1933. Die Trigonien des süddeutschen Jura. *Palaeontographica*, **77**, 1–120.
- LECKENBY, J. 1859. On the Kelloway Rock of the Yorkshire Coast. *Q. Jl geol. Soc. Lond.*, **15**, 4–15, pls. 1–3.
- LEEDS, E. T. 1956. *The Leeds collection of fossil reptiles from the Oxford Clay of Peterborough*. 104pp. Oxford.
- LEWINSKI, J. 1923. Monographie géologique et paléontologique du Bononien de la Pologne. *Mém. Soc. géol. Fr. Paléont.*, No. 56.
- LEYMERIE, A. 1846. *Statistique, géologique et minéralogique du département de l'Aube*. xii + 676pp., 10 pls. Troyes.
- LINNAEUS, C. 1758. *Systema naturae per regna tria naturae*. 10th edit., **1**, ii + 824pp. Stockholm.
- LISSAJOUS, M. 1912. *Jurassique Maçonnais. Fossiles caractéristiques*. 208pp., 19 pls. Maçon.
- 1923. Étude sur la faune du Bathonien des environs de Maçon. *Mém. Trav. Lab. Géol. Univ. Lyon*, **3**, 286pp., 33 pls.
- LISTER, M. 1678. *Historiae Animalium Angliae tres tractatus*. vi + 250pp., pls. 1–9. London.
- LORIOL, P. DE. 1896–1901. Étude sur les mollusques et brachiopodes de l'Oxfordien supérieur et moyen du Jura bernois. *Abh. schweiz. paläont. Ges.*, **23**, **24**, **28**. (1), 1896, 1–77, pls. 1–11; (2), 1897, 78–158, pls. 12–17; suppl. 1, 1901, 1–119, pls. 1–7.
- 1898–99. Étude des mollusques et brachiopodes de l'Oxfordien inférieur ou Zone à *Ammonites renggeri* du Jura bernois. *Ibid.*, **25–26**. (1), 1898, 1–116, pls. 1–7; (2), 1899, 117–220, pls. 8–12.
- 1902–04. Étude sur les mollusques et brachiopodes de l'Oxfordien supérieur et moyen du Jura lédonien. *Ibid.*, **29–31**. (1), 1902, 1–76, pls. 1–5; (2), 1903, 77–160, pls. 6–19; (3) 161–303, pls. 20–27.
- & COTTEAU, G. 1868. Monographie paléontologique et géologique de l'étage portlandien du département de l'Yonne. *Bull. Soc. Sci. Hist. nat. Yonne*, (2), **1**, 1–260, pls. 1–15.
- & PELLAT, E. 1875. Monographie paléontologique et géologique des étages jurassiques supérieurs de Boulogne sur Mer. *Mém. Soc. Phys. Hist. nat. Genève*, **24**, 1–326, pls. 1–15.
- ROYER, E. & TOMBECK, H. 1872. Description géologique et paléontologique des étages Jurassiques supérieurs de la Haute-Marne. *Mém. Soc. linn. Normandie*, **13**, 1–484, pls. 1–26.

- LYCETT, J. 1850. Tabular view of fossil shells from the middle division of the Inferior Oolite in Gloucestershire. *Ann. Mag. nat. Hist.*, (2), **6**, 401–25, pl. 11.
- 1863. Supplementary monograph on the Mollusca from the Stonesfield Slate, Great Oolite, Forest Marble and Cornbrash. *Palaeontogr. Soc. [Monogr.]*: 129pp., 15 pls.
- 1872–83. A monograph of the British Fossil Trigoniac. *Palaeontogr. Soc. [Monogr.]*: (1), 1872, 1–52, pls. 1–9; (2), 1874, 53–92, pls. 10–19; (3), 1875, 93–148, pls. 20–27; (4), 1877, 149–204, pls. 28–40; (5), 1879, 205–45, pl. 41, title-page; suppl. no. 1., 1881, 1–3; suppl. no. 2, 1883, 5–19, pls. 1–4, title-page.
- MAKOWSKI, H. 1952. La faune callovienne de Lukow en Pologne. *Palaeont. pol.*, **4**, 64pp., 9 pls.
- MANGOLD, C. 1970. The Bathonian and Callovian Perisphinctidae (Ammonitina) of the southern Jura. *Docums. Lab. géol. Univ. Lyon*, **41**, (2), 1–246, pls. 1–16.
- MANSELL-PLEYDELL, J. C. 1879. On the Dorset Trigoniac. *Proc. Dorset nat. Hist. antiq. Fld Club*, **3**, 111–34, pls. 1–5.
- MANTELL, G. A. 1848. Observations on some Belemnites and other fossil remains of Cephalopoda discovered by Mr. R. N. Mantell in the Oxford Clay near Trowbridge (Wiltshire). *Phil. Trans. R. Soc. (B)*, **138**, 171–81, pls. 13–15.
- 1850. Supplementary observations on the structure of the belemnite and *Belemnoteuthis*. *Ibid.*, **140**, 393–98, pls. 28–30.
- MARCH, M. C. 1911. Studies in the morphogenesis of certain pelecypoda. (3). The ornament of *Trigonia clavellata* and some of its derivatives. *Mem. Proc. Manchr lit. phil. Soc.*, **55**, 1–13.
- MARWICK, J. 1935. Some new genera of the Myalinidae and Pteriidae of New Zealand. *Trans. R. Soc. N.Z.*, **65**, 295–303, pls. 34–36.
- MCALISTER, A. L. 1968. Type species of Paleozoic nuculoid bivalve genera. *Mem. Geol. Soc. Am.*, **105**, 143pp., 36 pls.
- MCCOY, F. 1844. *A synopsis of the characters of the Carboniferous Limestone Fossils of Ireland*. viii + 207pp., 29 pls. Dublin.
- 1849. On the classification of some British fossil crustacea with notices of new forms in the University Collection at Cambridge. *Ann. Mag. nat. Hist.*, (2), **4**, 161–79, 330–35, 392–414.
- MCLEARN, F. H. 1948. New Lower Cretaceous species from Alberta and northeastern British Columbia. Appendix to *Geol. Surv. Canada Paper* 44–17, 2pp.
- MEEK, F. B. 1864. Check list of the invertebrate fossils of North America. Cretaceous and Jurassic. *Smithson. Misc. Collns*, **177**, 1–40.
- 1865. Description of fossils from the auriferous slates of California. *Geol. Surv. Calif., Geology*, **1**, 477–82.
- & HAYDEN, F. V. 1858. Description of new organic remains collected in Nebraska Territory in the year 1857, by Dr. F. V. Hayden, geologist to the exploring expedition under the command of Lieut. G. K. Warren, Top. Engr. U.S. Army, together with some remarks on the geology of the Black Hills and portions of the surrounding country. *Proc. Acad. Nat. Sci. Philadelphia*, **10**, 41–59.
- & — 1861. Description of new Lower Silurian (Primordia), Jurassic, Cretaceous and Tertiary fossils, collected in Nebraska, by the exploring expedition under the command of Capt. Wm. F. Reynolds, U.S. Top. Engrs., with some remarks on the rocks from which they were obtained. *Ibid.* **13**, 415–47.
- MILASCHEWITSH, K. O. 1881. Geological research for the year 1878; the southwestern parts of the Kostromsk district. *Mat. geol. Russland*, **10**, 133–331, pls. 1–11. [In Russian.]
- MIRKAMALOV, KH. KH. 1963. Classification of the Exogyras, *Moskovsk. Obshch., Byull., Ispytateley Prirody*, n.s., **68**, *Otdel. Geol.*, **38**, no. 5, 152–53.
- MONTEROSATO, T. A. DI. 1877. Notizie int. alle conch. fossili di Mte. Pellegrino e Ficarazzi. *Boll. R. Comitato Geol. d'Italia*, **8**.
- 1917. Molluschi viventi e quaternari raccolti lungo le coste della Tripolitania. *Boll. Soc. Zool. Ital.*, **12**, Ser. 3, (4), 1–25, pl. 1.
- MÖRCH, O. A. L. 1853. *Catalogus Conchyliorum quae Reliquit D. Alphonso d'Aguirra & Gadea, comes de Yoldi. Fasc. Sec. Acephala*. 74pp. Copenhagen.
- MORRIS, J. 1850. List of organic remains obtained from the railway cuttings described by R. N. Mantell at Christian Malford, Wilts. *Q. Jl geol. Soc. Lond.* **6**, 315–19, pl. 30.
- & LYCETT, J. 1851–55. A monograph of the Mollusca from the Great Oolite. *Palaeontogr. Soc. [Monogr.]*: (1), 1851, Univalves, i–viii, 1–130, pls. 1–15; (2), 1853, Bivalves, 1–80, pls. 1–8; (3), 1855, Bivalves, 81–147, pls. 9–15.
- MÜLLER, C. F. 1776. *Zoologiae Danicae Prodromus, seu Animalium Daniae et Norvegiae Indigenarum, characteres, nomina, et synonyma imprimis popularium*. xxxii + 282pp. Copenhagen.
- MÜLLER, J. M. 1847. *Monographie der Petrefacten der aachener Kreideformation*. Pt. 1, 48pp., 2 pls. Bonn.
- MUNIER-CHALMAS, E. 1863. Description d'un nouveau genre de Kimmeridge Clay. *J. Conchyl.*, **11**, 1–42.
- MURCHISON, R. I. 1827. On the coalfield of Brora in Sutherlandshire, and some other stratified deposits in the north of Scotland. *Trans. geol. Soc. Lond.*, (2), **2**, 293–326.
- NEALE, J. W. 1956. *Chlamys (Radulopecten) drewttonensis* sp. nov. *Proc. Yorks. geol. Soc.*, **30**, 371–74, pl. 28.
- NEAVERSON, E. 1925. The zones of the Oxford Clay near Peterborough. *Proc. Geol. Ass.*, **36**, 27–37.
- NEUMANN, R. 1907. Beiträge zur Geologie und Paläontologie von Süd-America. 13, Beiträge zur Kenntnis der Kreideformation in Mittel-Péru. *N. Jahrb. Min.*, **24**, 69–132, pls. 1–5.

- NEWELL, N. D. 1939 Transposed hinge in a Paleozoic pelecypod. *Am. J. Sci.*, **237**, 178–80.
- 1965. Classification of the Bivalvia. *Am. Mus. Novit.*, no. 2206, 25pp.
- 1969. Classification of Bivalvia. In MOORE, R. C. (ed.). *Treatise on Invertebrate Palaeontology, Part N, Mollusca* 6, N205–18. Boulder.
- 1969. Family Entoliidae. *Ibid.*, pp. N346–47.
- & BOYD, D. W. 1975. Parallel evolution in early trigoniacean bivalves. *Bull. Am. Mus. nat. Hist.*, **154**, 53–162.
- OHDNER, N. H. 1918. Zur Kenntnis der Homologien des Bivalvienschlosses. *Geol. Fören. Stockh. Förh.*, **40**, 562–90.
- OKEN, L. 1815. *Lehrbuch der Naturphilosophie*. **3**. Jena.
- ORBIGNY, A. D'. 1845. Système jurassique (Étage Oxfordien). Mollusques. In MURCHISON, R. I., DE VERNEUIL, A., & KEYSERLING, A. DE, *Géologie de la Russie d'Europe et des montagnes de l'Oural*. **2**, 419–88, pls. 28–42. Paris.
- 1850. *Prodrome de Paléontologie stratigraphique universelle des animaux mollusques et rayonnés*. **1**, lx + 394pp.; **2**, 428pp. Paris.
- OSBORNE-WHITE, H. J. 1925. The geology of the country around Marlborough. *Mem. geol. Surv. U.K.*, xi + 112pp.
- OWEN, R. 1844. A description of certain belemnites, preserved with a great proportion of their soft parts, in the Oxford Clay at Christian Malford, Wilts. *Phil. Trans. R. Soc. (B)*, **134**, 65–85, pls. 2–8.
- PALMER, C. P. 1973. The palaeontology of the Liassic (Lower Jurassic) clay pits at Stonehouse and Tuffley in Gloucestershire. *Geol. Mag.*, **110**, 249–63, pl. 1.
- 1975. A new Jurassic scaphopod from the Oxford Clay of Buckinghamshire. *Palaeontology*, **18**, 377–83, pl. 52.
- PARIS, F. T. & RICHARDSON, L. 1915. Some Inferior Oolite Pectinidae. *Q. Jl Geol. Soc. Lond.*, **71**, 521–35, pls. 44, 45.
- PARKINSON, J. 1811. *Organic Remains of a Former World*, **3**. xv + 479pp., 22 pls. London.
- PEARCE, J. C. 1847. On the fossil cephalopoda constituting the "genus *Belemnoteuthis*". *Geol. Jl London, Record of Discoveries, Brit. & Foreign, Palaeont.*, **1**, 75–78, pls. 15, 16.
- PERSSON, P. O. 1963. A revision of the classification of the Plesiosauria, with a synopsis of the stratigraphical and geographical distribution of that group. *Acta Univ. lund., N.F. Avd. 2*, **59**, no. 1.
- PHILLIPS, J. 1829. *Illustrations of the geology of Yorkshire*. xvi + 192pp., 24 pls. York.
- 1865–70. A monograph of British Belemnitidae. *Palaeontogr. Soc. [Monogr.]*: (1), 1865, 1–28; (2), 1866, 29–52, pls. 1–7; (3), 1867, 53–88, pls. 8–20; (4) 1869, 89–108, pls. 21–27; (5), 1870, 109–28, pls. 28–36.
- 1871. *Geology of Oxford and the valley of the Thames*. xxiv + 523pp., 17 pls. Oxford.
- PLOT, R. 1676. *The Natural History of Oxfordshire*. vii + 358pp., 16 pls. London.
- POLI, J. X. 1795. *Testacea utriusque Siciliae eorumque historia et anatomia tabulis aeneis illustrata*. **2**, lxxvi + 264pp., 20 pls.
- POPENOE, W. P. & FINDLAY, W. A. 1933. Transposed hinge structures in lamellibranchs. *Trans. S. Diego Soc. nat. Hist.*, **7**, (26), 299–315, pl. 19.
- PRATT, S. P. 1841. Description of some new species of ammonites found in the Oxford Clay on the line of the Great Western Railway, near Christian Malford. *Ann. Mag. nat. Hist.*, **8**, 161–65, pls. 3–7.
- PUGACZEWSKA, H. 1971. Jurassic Ostreidae of Poland. *Acta Palaeont. Polonica*, **16**, 195–307, pls. 1–35.
- PULTENEY, R. 1799. *Catalogues of the Birds, shells and some of the more rare plants of Dorsetshire. From the new edition of Hutchin's History of that county*. 92pp. London.
- PURI, H. S. 1969. Family Nuculanidae. In MOORE, R. C. (ed.). *Treatise on Invertebrate Paleontology, Part N, Mollusca* **6**, N234–41. Boulder.
- QUENSTEDT, F. A. 1851. *Handbuch der Petrefaktenkunde*. 792pp., 62 pls. Tübingen.
- 1856–58. *Der Jura*. (1), 1856, 1–576, pls. 1–72; (2), 1857, 577–823, pls. 73–100; (3), 1858, Title-page and Index. Tübingen.
- QUENSTEDT, W. 1930. Die Anpassung an die grabende Lebensweise in der Geschichte der Solenomyiden und Nuculaceen. *Geol. paläont. Abh.*, n.s., **18**, 1–119, pls. 1–3.
- RAFINESQUE, C. S. 1815. *Analyse de la nature*. 225pp. Palermo.
- RASPAIL, J. 1901. Contribution à l'étude de la falaise Jurassique de Villers-sur-Mer. Callovien, Oxfordien. *Feuille jeun. Nat.*, (4), **31**, 125–26, 145–49, 169–72, 193–98, pls. 10–12.
- RHOADS, D. C., SPEDEN, I. G. & WAAGE, K. M. 1972. Trophic group analysis of Upper Cretaceous (Maestrichtian) bivalve assemblages from South Dakota. *Bull. Am. Ass. Petrol. Geol.*, **56**, 1100–13.
- ROBERTS, T. 1889. The Upper Jurassic clays of Lincolnshire. *Q. Jl geol. Soc. Lond.*, **45**, 545–60.
- 1892. *The Jurassic rocks of the neighbourhood of Cambridge*. vii + 96pp. Cambridge.
- RÖDING, P. F. 1798. *Museum Boltianum. Pars secunda continens Conchylia*. viii + 199pp. Hamburg.
- ROEDER, H. A. 1882. Beitrag zur Kenntniss des Terrain à Chailles und seiner Zweischalen in der Umgegend von Pfirt im Ober-Elsass. *Inaug. Diss. Math. naturw. Fak. Kaiser-Wilhelmsuniversität Strassburg*. 110pp., 4 pls.
- ROEMER, F. A. 1836–39. *Die Versteinerungen des Norddeutschen Oolithen-Gebirges*. (1), 1836, 218pp., 16 pls.; (2), Nachtrag, 1839, 59pp., pls. 17–20. Hannover.
- ROLLIER, L. 1911–18. Fossiles nouveaux ou peu connus des terrains secondaires (Mésozoïques) du Jura et des contées environnantes. **1**, xx + 696pp., 40 pls. *Abh. schweiz. paläont. Ges.*, **37–42**.

- ROUILLIER, C. 1846. Explication de la coupe géologique des environs de Moscou. *Bull. Soc. imp. Nat. Moscou*, **19**, (1), 444–500; **19**, (2), 359–467.
- ROUILLIER, C. & VOSSVNSKI, A. 1847. Études progressives sur la paléontologie des environs de Moscou. *Bull. Soc. Imp. Nat. Moscou*, **20**, 371–447, pls. 1–3.
- ROVERETO, G. 1898. Note preventive sui pelecipodi del tongriano ligure. 2. Limidae–Veneridae. *Atti Soc. Ligustica*, **9**, 153–87.
- SACCO, F. 1897. *Pelecypoda (Ostreidae, Anomiidae e Dimyariidae)*. In L. Bellardi & Federico Sacco, 1872–1904, *I molluschi dei terrini Terziarii de Piemonte e della Liguria*. Pt. 23, 66pp., 11 pls. Turin.
- SAUVAGE, C. & BUVIGNIER, A. 1842. *Statistique minéralogique et géologique du département des Ardennes*. xlv + 554pp., 4 pls. Mézières.
- SCACCHI, A. 1833. *Osservazioni Zoologiche*. 27pp. Naples.
- SCALIA, S. 1912. La fauna del Trias superiore del gruppo di Mte. Judica, Parte 2. *Mem. (Atti.) Accad. Gioenia, Sci. natur. Catania*, (5), **5**, 1–58, pls. 1–3.
- SCHAUFUSS, L. W. 1869. *Molluscorum Systema et Catalogus. System und Aufzählung Sämmtlicher Conchylien der Sammlung von F. Paetel . . . Herausgegeben von . . . L. W. Schaufuss*. xiv + 119pp. Dresden.
- SCHENK, H. G. 1934. Classification of nuculid pelecypods. *Bull. Mus. r. Hist. nat. Belg.*, **10**, no. 20, 1–78, pls. 1–5.
- SCHLOTHEIM, E. F. VON. 1813. Beiträge zur Naturgeschichte der Versteinerungen in geognostischer Hinsicht. *Taschenb. miner.*, **7**, 3–134, pls. 1–4.
- 1820. *Die Petrefaktenkunde*. lxii + 437pp., 15 pls. Gothenburg.
- SCHMIDT, F. C. 1818. *Versuch über die beste Einrichtung zur Aufstellung, Behandlung und Aufbewahrung der verschieden Naturkörper und Gegenstände der Kunst, vorzüglich der Conchylien-Sammlungen, nebst Kerzer Beurtheilung der conchyliologischen Systeme und Schriften und einer tabellarischen Zusammenstellung und Vergleichung der sechs besten und neuesten conchyliologischen Systeme welchen ein Verzeichniss der am meisten bekannten Conchylien angehängt ist, wie solche nach dem Lamarkischen System geordnet werden können*. Gotha.
- SCOPOLI, I. A. 1777. *Introductio ad Historiam naturalem, sistema genera lapidum, plantarum et animalium*. 506pp. Prague.
- SEEBACH, K. VON. 1864. *Der Hannoversche Jura*. 158pp., 10 pls. Berlin.
- SEGUENZA, G. 1877. Nuculidi terziarie rinvenute nelle provincie meridionali d'Italia. *Accad. Lincei, Atti*, Ser. 3, **1**, 1163–1200.
- SOWERBY, J. 1812–22. *The Mineral Conchology of Great Britain*: **1**, (1), 1812, i–vii, 9–32, pls. 1–9; (2), 1813, 33–96, pls. 10–44; (3), 1814, 97–178, pls. 45–78, (4), 1815, 179–236, pls. 79–102; **2**, (1), 1815, 1–28, pls. 103–14; (2), 1816, 29–116, pls. 115–50; (3), 1817, 117–94, pls. 151–86; (4), 1818, 195–239, pls. 187–203; **3**, (1), 1818, 1–40, pls. 204–21; (2), 1819, 41–98, pls. 222–53; (3), 1820, 99–126, pls. 254–71; (4), 1821, 127–86, pls. 272–306; **4**, (1), 1821, 1–16, pls. 307–18; (2), 1822, 17–104, pls. 307–27. London.
- SOWERBY, J. DE C. 1822–46. *The Mineral Conchology of Great Britain*: **4**, (3), 1822, 105–14, pls. 328–83; (4), 1823, 115–51, pls. 384–407; **5**, (1), 1823, 1–64, pls. 408–43; (2), 1824, 65–138, pls. 444–85; (3), 1825, 139–71, pls. 486–503; **6**, (1), 1826, 1–86, pls. 504–45; (2), 1827, 87–156, pls. 546–80; (3), 1828, 157–200, pls. 581–97; (4), 1829, 201–35, pls. 598–609; Preface to the General Indexes and Systematic Index to the 6 Volumes, 1835, 239–50; **7**, (1), 1840, Alphabetic Index to volumes **1–6**, 1–11; pp. 1–8, pls. 610–18; (2), 1841, 9–16, pls. 619–23; (3), 1843, 17–24, pls. 624–28; (4) 1844, 25–56, pls. 629–43; (5), 1846, 57–80, pls. 644–48. London.
- 1840. Description of fossils from the Upper Secondary Formation of Cutch collected by C. W. Grant. *Trans. geol. Soc. Lond.*, (2), **5**, pls. 21–23 + explanation.
- SPATH, L. F. 1932. The invertebrate faunas of the Bathonian–Callovian deposits of Jameson Land, East Greenland. *Meddr. Grønland*, **87**, no. 7, 158pp., 26 pls.
- 1936. The Upper Jurassic invertebrate faunas of Cape Leslie, Milne Land. 2. Upper Kimmeridgian and Portlandian. *Ibid.* **99**, no. 3, 180pp., 50 pls.
- SPEFEN, I. G. 1967. Revision of *Syncyclonema* (Upper Cretaceous) and comparison with other small pectinid bivalves and *Entolium*. *Postilla* no. 110, 36pp., 7 pls.
- 1970. The type Fox Hills Formation, Cretaceous (Maestrichtian), South Dakota. Pt. 2. Systematics of the Bivalvia. *Bull. Peabody Mus. nat. Hist.*, **33**, 222pp., 42 pls.
- STAESCHE, K. 1926. Die Pectiniden des schwäbischen Jura. *Geol. paläont. Abh., N.F.*, **15**, 136pp., 6 pls.
- STANLEY, S. M. 1968. Post-Paleozoic adaptive radiation of infaunal bivalve molluscs—a consequence of mantle fusion and siphon formation. *J. Paleont.*, **42**, 214–29.
- 1970. Relation of shell form to life habits in the Bivalvia (Mollusca). *Mem. geol. Soc. America*, **125**, xiii + 296pp., 40 pls.
- 1972. Functional morphology and evolution of bysally attached bivalve mollusks. *J. Paleont.*, **46**, 165–212.
- STENZEL, H. B. 1971. Oysters. In MOORE, R. C. (ed.). *Treatise on Invertebrate Paleontology, Part N, Mollusca* 6, N953–N1224. Boulder.
- STEWART, R. B. 1930. Gabb's California Cretaceous and Tertiary type lamellibranchs: *Acad. Nat. Sci. Philadelphia, spec. Publ.* no. 3, 314pp., 17 pls.
- STOLICZKA, F. 1871. The Pelecypoda, with a review of all known genera of this class, fossil and Recent. In *The Cretaceous fauna of India*, **3**, xxii + 537pp., 50 pls. *Mem. geol. Surv. India, Palaeont. indica*.

- STOLL, E. VON 1934. Die Brachiopoden und Mollusken der pommerschen Dogger-geschiebe. *Abh. geol. palaeont. Inst. Greifswald*, **13**, 1–62, pls. 1–3.
- STOLL, E. VON. 1939. *Malletia gigantea* (Smith). *Acta Zool.*, **20**, 339–41.
- STRAHAN, A. 1898. The geology of the Isle of Purbeck and Weymouth. *Mem. geol. Surv. Eng. Wales*, xi + 278pp.
- SWAINSON, W. 1840. *A Treatise on Malacology*. viii + 419pp. London.
- SYLVESTER-BRADLEY, P. C. 1959. Iterative evolution in fossil oysters. *Proc. 15th int. Congr. Zool., London*, 193–96.
- TARLO, L. B. 1960. A review of Upper Jurassic Pliosaurus. *Bull. Br. Mus. nat. Hist. (Geol.)*, **4**, 145–89, pls. 20–28.
- TEPFNER, W. VON. 1922. *Fossilium catalogus 1: Animalia*, DIENER, C. (ed.). Pars 15: *Lamellibranchiata tertiaria "Anisomyaria"*, II, 67–296. Berlin.
- TERQUEM, O. 1855. Observations sur les études critiques des mollusques fossiles, comprenant la Monographie des Myaires de M. Agassiz. *Mém. Acad. Metz*, **36**, 253–357.
- THIÉRY, P. & COSSMANN, M. 1907. Note sur le Callovien de la Haute-Marne. *Bull. Soc. Agric. Haute-Saône, Vesoul*, 69–147, pls. 1–3.
- THURMANN, J. 1833. Essai sur les soulèvements jurassiques de Porrentruy. *Mém. Soc. Hist. nat. Strasbourg*, (1), **2**, (2), 85pp., 5 pls.
- & ÉTALLON, A. 1861–64. Lethea Bruntrutana, ou études paléontologiques et stratigraphiques sur le Jura bernois et en particulier les environs de Porrentruy. *Neue Denkschr. allg. schweiz. Ges. ges. Naturw.* (1), 1861, **18**, 1–145; (2), 1862, **19**, 146–353; (3), 1864, **20**, 354–500.
- TINTANT, H. 1963. Les Kosmocératidés du Callovien inférieur et moyen d'Europe occidentale. *Publs Univ. Dijon*, no. 29, 500pp., 108 pls.
- TORRENS, H. S. 1969 (ed.) *International Field Symposium on the British Jurassic. Excursion no. 1. Guide to Dorset and South Somerset*. 71pp., Geol. Dept., Keele Univ.
- TRAUTSCHOLD, H. 1860. Recherches géologiques aux environs de Moscou: couche jurassique de Galiowa. *Bull. Soc. imp. Nat. Moscou*, **33**, (3), 338–61, pls. 6–8.
- TZANKOV, V. & BONCEV, E. 1932. Mollusques de la craie supérieur de Nord-Est de la Bulgarie. *Spis. búlg. Geol. Druzh.* **3**, (2), 46–78, pls. 1–7.
- VAN DE POEL, L. 1955. Structure du test et classification des nucules. *Bull. Inst. Sci. nat. Belg.*, **31**, (3), 1–11.
- VERRILL, A. E. 1897. A study of the family Pectinidae with a revision of the genera and subgenera: *Trans. Conn. Acad. Arts Sci.*, **10**, 41–96.
- VOKES, H. F. 1945. Supraspecific groups of the pelecypod family Corbulidae. *Bull. Am. Mus. nat. Hist.*, **86**, 1–32, pls. 1–4.
- VORONETZ, N. S. 1936. The Mesozoic fauna of the Kharaulakh mountain range. *Trudy arkt. nauchno-issled. Inst.*, **37**, 30–36, pls. 1–3.
- VYALOV, O. S. 1946. Triassic oysters from SRSR. Lvovskogo Derzhavnogo Univ. *Ivana Franka naukovy zapiski*, **2**, Ser. geol. (3), 22–54.
- 1948. Principy klassifikacii semejstva Ostreidae. *Trudy Lvov Geol. Obshch. Paleont. Ser.* **1**, 30–40. [In Russian.]
- VYALOV, O. S. & KOROBKOV, I. A. 1939. On the stratigraphy of Pectinidae from the lower Tertiary of Central Asia. *Bull. Acad. Sci. URSS, Géol.*, 1939 (3), 32–43, pls. 1, 2.
- WALKER, K. G. 1972. The stratigraphy and bivalve fauna of the Kellaways Beds (Callovian) around South Cave and South Newbald, East Yorkshire. *Proc. Yorks. Geol. Soc.*, **39**, 107–38, pls. 7–8.
- WHITE, C. A. 1887. On new generic forms of Cretaceous mollusca and their relation to other forms. *Proc. Acad. nat. Sci. Philadelphia*, **39**, 32–37, pl. 2.
- WHITFIELD, R. P. 1885. Brachiopoda and Lamellibranchiata of the Raritan Clays and Greensand Marls of New Jersey. *Mon. U.S. Geol. Surv.*, **9**, xx + 269pp., 35 pls.
- 1891. Observations on some Cretaceous fossils from the Beyrút district of Syria in the collections of the American Museum of Natural History, with descriptions of some new species. *Bull. Am. Mus. nat. Hist.*, **3**, 381–441, pls. 4A–11.
- WOHLEGEMUTH, J. 1883. *Recherches sur le Jurassique Moyen à l'Est du Bassin de Paris*. Stratigraphie. Paris. Unpubl. Ph.D. thesis. (Not seen.)
- WOODS, H. 1899–1913. A Monograph of the Cretaceous Lamellibranchia. *Palaeontogr. Soc. [Monogr.]*: **1**, (1), 1–72, pls. 1–14 (1899); (2), 73–112, pls. 15–19 (1900); (3), 113–44, pls. 20–26 (1901); (4), 145–96, pls. 27–38 (1902); (5), i–xlili, 197–232, pls. 39–42, Title-page and Index for Vol. 1 (1903); **2** (1), 1–56, pls. 1–7 (1904); (2), 57–96, pls. 8–11 (1905); (3), 97–132, pls. 12–19 (1906); (4), 133–80, pls. 20–27 (1907); (5), 181–216, pls. 28–39 (1908); (6), 217–60, pls. 35–44 (1909); (7), 261–84, pls. 45–50 (1911); (8), 285–340, pls. 51–54 (1912); (9), 341–473, pls. 55–62, Title-page and Index (1913).
- 1924–31. The Fossil Macrurous Crustacea of England. *Palaeontogr. Soc. [Monogr.]*: (1), 1924, 1–16, pls. 1–4; (2), 1925, 17–40, pls. 5–8; (3), 1926, 41–48, pls. 9–12; (4), 1927, 49–64, pls. 13–16; (5), 1928, 65–72, pls. 17–20; (6), 1930, 73–88, pls. 20–24; (7), 1931, 89–122, pls. 25–27, Title-page and index.
- WOODWARD, A. S. 1889–1901. *Catalogue of the fossil fishes in the British Museum*: (1), 1889, xlvii + 474pp., 27 pls; (2), 1891, xlv + 567pp., 16 pls.; (3), 1895, xliii + 544pp., 18 pls.; (4), 1901, xxxviii + 636pp., 19 pls.

- WOODWARD, H. B. 1894. The Jurassic Rocks of Britain. 4. The Lower Oolitic rocks of England. *Mem. geol. Surv. U.K.*, xiv + 628pp.
- 1895. The Jurassic rocks of Britain. 5. The Middle and Upper Oolitic rocks of England. *Mem. geol. Surv. U.K.*, xiv + 499pp.
- WRIGHT, J. K. 1968. The stratigraphy of the Callovian rocks between Newtondale and the Scarborough coast, Yorkshire, *Proc. Geol. Ass.*, **79**, 363–99.
- YONGE, C. M. 1937. The formation of siphonal openings by *Thracia pubescens*. *Proc. malac. Soc. Lond.*, **22**, 337–38.
- 1939. The protobranchiate mollusca; a functional interpretation of their structure and evolution. *Phil. Trans. R. Soc. (B)*, **230**, 79–147, pl. 15.
- 1946. On the habits and adaptations of *Aloidis* (*Corbula*) *gibba*. *J. mar. biol. Ass. U.K.*, n.s. **26**, 358–76.
- 1949. On the structure and adaptations of the Tellinacea, deposit-feeding eulamellibranchs. *Phil. Trans. R. Soc. (B)*, **234**, 29–76.
- 1953. Form and habit in *Pinna carnea* Gmelin. *Ibid.*, **237**, 335–74.
- 1973. Functional morphology with particular reference to hinge and ligament in *Spondylus* and *Plicatula*, and a discussion on relations within the superfamily Pectinacea (Mollusca: Bivalvia). *Ibid.*, **267**, 173–208.
- YOUNG, G. & BIRD, J. 1822. *A geological survey of the Yorkshire coast: describing the strata and fossils occurring between the Humber and the Tees, from the German Ocean to the plain of York*. 235pp., 17 pls. Whitby.
- & — 1828. *Idem.*, second edition. 366pp., 17 pls. Whitby.
- ZAKHAROV, V. A. 1970. Late Jurassic and early Cretaceous bivalves of the Siberian north and their ecology. Pt. 2. Family Astartidae. *Trans. Acad. Sci. U.S.S.R. Siberian branch, Inst. geol. geophys.* **113**, 1–144, pls. 1–15. [In Russian.]
- ZAPRUDSKAYA, M. A. 1953. Lamellibranch mollusks of the Lower Turonian Alaysk Range. *Vses. Neft. Nauch-Issled. Geol.-Razv. Inst. (VNI-GRI)* n.s., **73**, 21–61, pls. 1–15.
- ZEISS, A. 1956. *Hecticoceras* und *Reineckeia* im Mittel- und Ober-Callovien von Blumberg (Südbaden). *Abh. bayer. Akad. Wiss. Math.-naturw. Kl., N.F.*, **80**, 1–101, pls. 1–4.
- ZIETEN, C. H. DE. 1830–33. *Les pétrifications de Wurtemberg*. 1, (1830), 1–16; 2, (1831), 17–32; 3, (1832), 33–64; 4, (1833), 65–96. Stuttgart.
- ZITTEL, K. A. 1881–85. *Handbuch der Palaeontologie. Abt. 1. Palaeozoologie. 2. Mollusca und Arthropoda*. 893pp. München und Leipzig.
- & GOUBERT, E. 1861. Description des fossiles du Coral-Rag de Glos. *J. Conchyl.*, **9**, 192–208, pls. 6, 8, 12.

K. L. DUFF, PH.D.,
Nature Conservancy Council,
Foxhold House, Thornford Road,
Crookham Common,
NEWBURY, Berkshire RG15 8EL

INDEX

Numbers in bold type refer to the first page of a description; numbers in italics indicate pages where a text-figure or table occurs; plate and figure numbers are also given, as are all taxonomic names referred to in the text.

- | | | |
|--|---|--|
| <i>Acharax</i> , 31 | —? <i>hians</i> , 116 | <i>anisocardioides</i> , <i>Anisocardia</i> , 105, 106 |
| <i>Actinochlamys</i> , 68 | —? <i>ovale</i> , 116 | <i>Anomalodesmatan</i> sp. A, 120 , 121; |
| <i>acutistriatum</i> , <i>Kosmoceras</i> (<i>Spiniko-</i>
<i>smoceras</i>), 9 | — <i>recurvum</i> , 115 | Pl. 13, figs. 16, 17, 27 |
| <i>Adulomya</i> , 31 | <i>Anaplomya</i> , 114 | — sp. B, 121 ; Pl. 13, figs. 24–26 |
| <i>aemula</i> , <i>Arca</i> , 37 | <i>Anisocardia</i> , 18, 104, 106, 107, 108 | <i>antiqua</i> , <i>Belemnoteuthis</i> , 4 |
| <i>Aequipecten fibrosus</i> , 70, 71, 72 | — <i>anisocardioides</i> , 105, 106 | <i>Apocardia</i> , 107 |
| <i>aequiplicata</i> , <i>Modiola</i> , 41, 42 | — <i>choffati</i> , 108 | <i>Arca aemula</i> , 37 |
| <i>agassizi</i> , <i>Pleuromya</i> , 115 | — <i>clarissima</i> , 109 | — <i>gnoma</i> , 36 |
| <i>alduini</i> , <i>Donacites</i> , 114, 115 | — <i>elegans</i> , 107 | — <i>halie</i> , 40 |
| —, — (<i>Pleuromya</i>), 115 | — <i>gibbosa</i> , 107 | — <i>harpax</i> , 40 |
| —, <i>Pleuromya</i> , 18, 115 , 116, 117, | — <i>globosa</i> , 105, 107 | — <i>hersilia</i> , 37 |
| 120; Pl. 13, figs. 5–10, 12, 15 | — <i>lycetti</i> , 105 | — <i>quenstedtii</i> , 37, 39 |
| <i>alpina</i> , <i>Leda</i> , 30 | — <i>munima</i> , 105, 107 | — <i>subtetragona</i> , 39 |
| —, <i>Posidonomya</i> , 52 | — <i>oolithica</i> , 105 | <i>Arca</i> (<i>Beushausenia</i>) <i>concinna</i> , 36, 37 |
| <i>Amphidesma</i> , 114 | — <i>tenera</i> , 104–109 | — (<i>Cucullaea</i>) <i>inornata</i> , 33 |
| — <i>decurtatum</i> , 116 | — (<i>Anisocardia</i>) <i>tenera</i> , 108 , 109, 109; | — (<i>Macrodon</i>) <i>concinna</i> , 36 |
| | Pl. 12, figs. 18, 20–22 | — — <i>montaneyensis</i> , 37 |

- (*Nemodon*) *gnoma*, 36
 — — *goldfusi*, 33
arcuata, *Gryphaea*, 76
arcuata, *Pecten*, 66
Astarte, 93, 96
 — *carinata*, 97, 98
 — *communis*, 96
 — *contejeani*, 100
 — *cordata*, 96, 98, 100
 — *cordiformis*, 96
 — *extensa*, 101
 — *lurida*, 93, 94
 — *modiolaris*, 93
 — *multiformis*, 98
 — *nummus*, 95
 — *obliqua*, 93
 — *pelops*, 95
 — *philea*, 95
 — *phillis*, 98, 100
 — *robusta*, 100
 — *sawagei*, 98
 — *sulcata*, 97
 — *trembiazensis*, 93
 — *ungulata*, 93
auriformis, *Exogyra*, 84
auritus, *Camptonectes* (*Camptonectes*),
 66, 67, 68; Pl. 5, figs. 22, 25
 — *Chamites*, 65, 66
Avicula braamburiensis, 58, 60
 — *curta*, 57, 58
 — *echinata*, 57
 — *inequivalvis*, 54
 — — var. α , 56
 — — var. β , 56
 — *muensteri*, 53, 54
 — *obliqua*, 48
 — *polyodon*, 48
 — *pygmaea*, 46, 48
 — *subcostata*, 54
 — (*Oxytoma*) *muensteri*, 54
 — — *inequivalvis*, 54
- Bakevellia*, 46
bathonicus, *Grammatodon*, 36, 37
becheri, *Posidonia*, 51
bedfordensis, *Chlamys* (*Chlamys*), 16,
 68, 69, 70, 70; Pl. 5, figs. 14–16,
 18, 21
Belchlamys, 68
Belemnoteuthis antiqua, 4
Belemnopsis sulcata, 4
bellona, *Lucina*, 91, 92
Beushausenia, 33
Bilobata, 76
bilobata, *Gryphaea*, 76, 77
 — — aff., 77
bilobata calloviense, *Gryphaea*, 77
 —, *Gryphaea* (*Bilobissa*), 76, 80
 —, *Ostrea* (*Gryphaea*), 77
Bilobissa, 76
bipartita, *Modiola*, 41
- bipartitus*, *Modiolus* (*Modiolus*), 41,
 42; Pl. 2, figs. 28–33
bispinosum, *Dicroloma*, 4
blakei, *Pteroperna*?, 48
Bositra, 9, 10, 11, 18, 51
 — *buchii*, 16, 51, 52, 53; Pl. 4, figs.
 3–6, 8, 10, 14
braamburiensis, *Avicula*, 58
 —, *Meleagrinnella*, 58, 58, 59, 60, 60,
 61; Pl. 4, figs. 20, 24, 26–28,
 31–32; Pl. 5, figs. 1–2, 6, 11
 —, *Pseudomonotis*, 58, 60
bronni, *Posidonia*, 51
Brotzenia, 11
buchii, *Bositra*, 16, 51, 52, 53; Pl. 4,
 figs. 3–6, 8, 10, 14
 —, *Posidonia*, 51, 52
bulkurensis, *Parainoceramus*, 48
bullata, *Gryphaea*, 80
 —, — (*Lyogyryphaea*), 77
- caecilia*, *Nucula*, 27
calceiformis, *Pleuromya*, 116, 117
calliope, *Nucula*, 25, 27
 —, *Palaeonucula*, 25, 27; Pl. 1, figs.
 14–16, 18–21
calloviensis, *Ostrea* (*Gryphaea*), 77
calvertense, *Pentalium*, 4, 10
calvertensis, *Neocrassina* (*Pressastarte*),
 17, 93, 94, 95, 96, 96; Pl. 11,
 figs. 4–7, 9–11
campaniensis, *Isocardia*, 105
 — var. *dassei*, *Anisocardia*, 105
Camptonectes, 16, 18, 65, 66, 67, 68
 — (*Camptonectes*) *auritus*, 66, 67, 68;
 Pl. 5, figs. 22, 25
 — *laminatus*, 68
 — *lens*, 66, 68
 — (*Camptochlamys*), 68
cancellata, *Cucullaea*, 33, 40
capricornus, *Pinna*, 45
Cardiodonta, 107
Cardium cognatum, 102, 103
 — *crawfordii*, 102, 103
 — *cyreniformis*, 109
 — *hillanum*, 101
 — *striatulum*, 102
carinata, *Astarte*, 97, 98
 —, *Corbulomima*, 114
 —, *Nicaniella* (*Trautscholdia*), 97, 98,
 99, 100; Pl. 11, figs. 12–17, 23, 24
castor, *Nucula*, 19
 —, *Nuculoma*, 21, 22
catyonensis, *Myophorella* (*Myophorella*),
 88, 89, 90; Pl. 10, figs. 2, 10;
 Pl. 11, figs. 1, 8
Cetothrax, 117
Chamites auritus, 65, 66
chassyanum, *Nucula*, 25
 —, *Nuculoma*, 20, 21
Chimaera, 43
- Chimaeroderma*, 43
Chlamydina, 68
Chlamys, 16, 18, 62, 68, 70
 — *fibrosa*, 71
 — *fibrosus*, 72
 — *islandica*, 68
 — *nattheimensis*, 68
 — *qualicosta*, 68
 — *scarburgensis*, 71
 — *splendens*, 68
 — *subtextoria*, 69
 — (*Aequipecten*) *fibrosa*, 72
 — — *fibrosus*, 72
 — (*Chlamys*) *bedfordensis*, 16, 68, 69,
 70, 70; Pl. 5, figs. 14–16, 18, 21
 — — sp. nov., 69
 — (*Radulopecten*) *drewtonensis*, 70, 72,
 74, 74; Pl. 6, figs. 3, 4
 — — *fibrosa*, 16, 18, 70, 71, 72, 72,
 73, 73, 74; Pl. 6, figs. 2, 7–9
 — — *hemicostatus*, 70
 — — *scarburgensis*, 16, 18, 70, 70,
 71, 72, 74; Pl. 5, figs. 19–20,
 23–24, 26–27; Pl. 6, figs. 1, 5–6
choffati, *Anisocardia*, 108
choroschouensis, *Palaeoneilo*, 28, 30
cingulatum, *Entolium*, 64
cingulatus, *Pecten*, 62, 64
citrinoidea, *Protocardia*, 103
clarissima, *Anisocardia*, 109
clathrata, *Cucullaea*, 39, 40
 —, — cf., 39
clathratus, *Grammatodon* (*Grammato-*
don), 39, 40; Pl. 2, figs. 21–23,
 25–27
Clathrolima, 57, 58
clavellata, *Myophorella*, 87
 —, *Trigonia*, 75, 85, 89, 90
Clavitrigonia, 85
Clavotrigonia, 85
cognatum, *Cardium*, 102, 103
communis, *Astarte*, 96
concinna, *Arca* (*Beushausenia*), 36, 37
 —, — (*Macrodon*), 36
 —, *Cucullaea*, 36, 37
 —, — cf., 36
 —, *Parallelodon* (*Grammatodon*), 36
concinna, *Grammatodon* (*Grammato-*
don), 9, 35, 36, 37, 38, 38, 39;
 Pl. 2, figs. 7, 11–17, 19
consobrinus, *Mytilus*, 42
contejeani, *Astarte*, 100
contracta, *Cucullaea*, 39, 40
corallina, *Cucullaea*, 40
Corbula cucullaeiformis, 113, 114
 — *greppini*, 112, 113
 — *macneillii*, 112
 — *mosae*, 113
 — *obscura*, 113
 — *oxfordiensis*, 113
 — sp. nov., 113

- Corbulomima*, 10, 11, 18, 18, 111, 113, 114
 — *carinata*, 114
 — *glosensis*, 111
 — *macneilli*, 18, **112**, 112, 113, 114;
 Pl. 12, figs. 24, 30, 32–40
 — *mosae*, 18
 — *nuciformis*, 111
 — *obscura*, 18, 112, 113, **113**, 114;
 Pl. 13, figs. 1–4
 — *suprajurensis*, 111, 114
cordata, *Astarte*, 96, 98, 100
 —, *Gouldia*, 98
 —, *Isocardia*, 104
 —, *Nicaniella* (*Trautscholdia*), 98
cordiformis, *Astarte*, 96
corneolum, *Entolium* (*Entolium*), **62**, 63,
 63, 64; Pl. 4, figs. 25, 29–30;
 Pl. 5, figs. 3–5
corneolus, *Pecten*, 62
Corymya, 117, 118
Cosmetodon, 33
costatula, *Gervillia*, 45
 —, *Pteroperna*, 46, 47, 48
cottaldi, *Nucula*, 25, 27
 —, *Palaeonucula*, 25
couffoni, *Cucullaea*, 33
craneae, *Lingula*, 4
Crassinella, 93
Crassostrea, 76
crawfordii, *Cardium*, 102, 103
 —, *Protocardia*, 102, 103
Cucullaea, 36
 — *cancelata*, 33, 40
 — *clathrata*, 39, 40
 — cf. *clathrata*, 39
 — *concinna*, 36, 37
 — cf. *concinna*, 36
 — *contracta*, 39, 40
 — *corallina*, 40
 — *couffoni*, 33
 — *minima*, 33
 — sp., 33
cucullaeiformis, *Corbula*, 113, 114
cuneata, *Modiola*, 41
curta, *Avicula*, 57
Cylindroteuthis puzosiana, 4, 9, 79
Cypricardia obliqua, 93
Cyprina dimorpha, 111
 — (*Isocyprina*) *cyreniformis*, 110
cyreniformis, *Cardium*, 109
 —, *Cyprina* (*Isocyprina*), 110
 —, *Isocyprina*, 110, 111

damone, '*Procerithium*', 4
decurtata, *Pleuromya*, 116
decurtatum, *Amphidesma*, 116
decurtatus, *Myacites*, 116
demissum, *Entolium*, 61, 62
demissus, *Pecten*, 61, 62
 —, — (*Entolium*), 62
depressa, *Mya*, 118
 —, *Panopaea*, 118
 —, *Thracia*, 118
 —, — (*Thracia*), **118**, 119, 120, 121;
 Pl. 13, figs. 13, 19, 20, 22, 23, 28
depressiuscula, *Isocyprina*, 111
Dicroloma, 10
 — *bispinosum*, 4
 — *trifidum*, 4
dilatata, *Gryphaea*, 77, 80, 82, 83
 —, — (*Bilobissa*), 80, 81, 82, 83
 — *lituola*, *Gryphaea*, 82
 — var. β , *Gryphaea*, 76, 77
dilobotes, *Gryphaea*, 77
 —, — (*Bilobissa*), **77**, 78, 79–83; Pl.
 6, figs. 16–20; Pl. 7, figs. 1–9; Pl.
 8, figs. 1, 4
dimorpha, *Cyprina*, 111
disciforme, *Entolium*, 62, 64
 —, *Pecten*, 61
Discomiltha, 11, 12, 18, 18, 90, 91, 92
 — *lirata*, **91**, 92; Pl. 9, figs. 6–12
 — *oehlerti*, 90
discrepans, *Pecten*, 70, 71
Donacites alduini, 114, 115
 — (*Pleuromya*) *alduini*, 115
drewtonensis, *Chlamys* (*Radulopecten*),
 70, 72, 74, **74**; Pl. 6, figs. 3, 4
dyonisea, *Protocardia*, 103

echinata, *Avicula*, 57
 —, *Meleagrinella*, 61
 —, *Pseudomonotis*, 61
Echinotis, 57, 58
effulgens, *Kosmoceras* (*Gulielmites*), 11
elea, *Pleuromya*, 117
elegans, *Anisocardia*, 107
elongata, *Lutraria*, 116
Entolium, 12, 16, 18, 61–65
 — *cingulatum*, 64
 — (*Entolium*) *corneolum*, **62**, 63, 63,
 64; Pl. 4, figs. 25, 29–30; Pl. 5,
 figs. 3–5
 — *demissum*, 61, 62
 — *disciforme*, 62, 64
 — *hehlii*, 65
 — *partitum*, 64
 — *proleus*, 64
 — *renevieri*, 64
 — *rhyphemum*, 62, 63
 — sp. A, 12, 16, 62, **64**, 65, 65;
 Pl. 5, figs. 7–10, 12, 13, 17
 — sp. nov., 64
 — (*Cteniolepturium*), 65
Eotrapezium, 104, 110
 — *tenerum*, 104
Eunodiolus, 40
evansi, *Malletia*, 30
Eximiothracia, 117

Exogyra, 84
 — *auriformis*, 84
 — *nana*, 84
expansum, *Oxytoma*, 56, 57
extensa, *Astarte*, 101

fibrosa, *Chlamys*, 71
 —, — (*Aequipecten*), 72
 —, — (*Radulopecten*), 16, 18, 70, 71,
 72, **72**, 73, 73, 74; Pl. 6, figs. 2,
 7–9
fibrosus, *Aequipecten*, 70, 71, 72
 —, *Chlamys*, 72
 —, — (*Aequipecten*), 72
 —, *Pecten*, 70, 71, 72
 —, — (*Aequipecten*), 72
 — var. *duplicostatus*, *Pecten* (*Aequi-*
pecten), 71, 72
fistulosa, *Plicatula*, 75, 76; Pl. 6, fig. 12
 —, — cf., **75**; Pl. 6, figs. 10, 13–15
foersteri, *Nucula*, 27
 ?*Fogiella*, 114

galatea, *Mesosaccella*, 30
 —, *Palaeoneilo*, 30
Gardnerella, 91
Genicularia, 12
 — *vertebralis*, 4
Gervillella, 48
Gervillia costatula, 45
 — *pygmaea*, 46, 48
Gibbomodiola, 41
gibbosa, *Anisocardia*, 107
 —, *Mactra* (*Lutraria*), 115
 —, *Mya*, 114, 115
 —, *Pteroperna*, 46
globosa, *Anisocardia*, 105, 107
glosensis, *Corbulomima*, 111
gnoma, *Arca*, 36
 —, — (*Nemodon*), 36
 —, *Parallelodon*, 36
goldfussi, *Arca* (*Nemodon*), 33
Gouldia cordata, 98
Grammatodon, 11, 12, 17, 18, 33–36
 — *bathonicus*, 36, 37
 — (*Grammatodon*) *clathratus*, **39**, 40;
 Pl. 2, figs. 21–23, 25–27
 — *concinus*, 35, 36
 — (*Grammatodon*) *concinus*, 9, 35, **36**,
 37, 38, 38, 39; Pl. 2, figs. 7,
 11–17, 19
 — *hersilius*, 35, **37**, 38, 38, 39;
 Pl. 2, figs. 18, 20, 24
 — *minus*, 9, **33**, 34, 34, 35, 40;
 Pl. 2, figs. 1–6, 8–10
 — *montaneyensis*, 37
 — *schourovskii*, 35
greppini, *Corbula*, 112, 113
grossouvrei, *Kosmoceras* (*Zugokosmo-*
keras), 9

- Gryphaea*, 11, 12, 16, 18, 76, 77, 79, 80, 84
 — *arcuata*, 76
 — *bilobata*, 76, 77
 — aff. *bilobata*, 77
 — *bilobata calloviense*, 77
 — (*Bilobissa*) *bilobata*, 76, 80
 — *bullata*, 80
 — (*Lyogryphaea*) *bullata*, 77
 — *dilatata*, 77, 80, 82, 83
 — *dilatata* var. β , 76, 77
 — *dilatata lituola*, 82
 — (*Bilobissa*) *dilatata*, 80, 81, 82, 83
 — *dilobotes*, 77
 — (*Bilobissa*) *dilobotes*, 77, 78, 79–83; Pl. 6, figs. 16–20; Pl. 7, figs. 1–9; Pl. 8, figs. 1, 4
 — *lituola*, 82, 83
 — (*Bilobissa*) *lituola*, 80, 81, 82, 83; Pl. 8, figs. 2–3, 5–7; Pl. 9, fig. 1
 — *mima*, 84
 — *nana*, 83, 84
 — (*Bilobissa*) sp. nov., 77
gryphaea, *Ostrea* (*Bilobata*), 77
- Haidaia*, 85
halesus, *Mytilus*, 42
halie, *Arca*, 40
hammeri, *Nucula*, 22
Hapalomya, 114
Harpax, 75
harpax, *Arca*, 40
Hassbergia, 101
Hecticoceras, 9
hehlii, *Entolium*, 65
hemicosstatus, *Chlamys* (*Radulopecten*), 70
 —, *Pecten*, 70
hersilia, *Arca*, 37
hersilia, *Grammatodon* (*Grammatodon*), 35, 37, 38, 38, 39; Pl. 2, figs. 18, 20, 24
hians, *Amphidesma*?, 116
hillanum, *Cardium*, 101
holesa, *Modiola*, 41, 42
Homoeodesmata, 117
Homomya oblata, 115
- imbricatus*, *Modiolus*, 42
incerta, *Tellina*, 118
 —, *Thracia*, 118, 119, 120
inconstans, *Nucula*, 25
inequivalve, *Oxytoma* (*Oxytoma*), 54, 55, 56, 57; Pl. 4, figs. 7, 9, 11, 13, 15–19, 21–23
inequivalvis, *Avicula*, 54
 — var. α , *Avicula*, 56
 — var. β , *Avicula*, 56
 —, *Avicula* (*Oxytoma*), 54
 —, *Oxytoma*, 54, 56, 57
 — var. *borealis*, *Oxytoma*, 54
 —, *Monotis*, 54
- inoceramoides*, *Inoceramus*, 51
Inoceramus inoceramoides, 51
 — *nitiscens*, 51
 — (*Mytiloides*) *labiatus*, 16
inornata, *Arca* (*Cucullaea*), 33
interlaevigata, *Oxytoma* cf., 54
interlaevigatum, *Oxytoma*, 57
intexta, *Protocardia*, 103
irregularis, *Myophorella* (*Myophorella*), 85, 86, 87, 88, 90; Pl. 9, figs. 13–17; Pl. 10, figs. 1, 3, 4, 6
 —, *Trigonia*, 85
 —, — aff., 88
islandica, *Chlamys*, 68
islandicus, *Pecten*, 68
Isocardia campaniensis, 105
 — — var. *dassei*, 105
 — *cordata*, 104
 — *laubei*, 104
 — *minima*, 105
 — *tener*, 108
 — *tenera*, 105, 108
 — *tumida*, 105
 — *villersensis*, 105
Isocyprina, 11, 12, 18, 18, 109–111
 — *cyreniformis*, 110, 111
 — *depressiuscula*, 111
 — *politula*, 111
 — *roederi*, 110, 111
 — (*Isocyprina*) *roederi*, 110, 111; Pl. 12, figs. 25–27, 29, 31
 — (*Eotrapezium*) *roederi*, 110
 — *simplex*, 111
- jason*, *Kosmoceras* (*Gulielmites*), 12
jurassi, *Lutraria*?, 116
 —, — (*Pleuromya*), 116
 — var. *portlandica*, *Myacites*, 116
 —, *Pleuromya*, 116, 117
- kathrynae*, *Nuculoma*, 21, 22; Pl. 1, figs. 2–5
Kosmoceras, 79
 — (*Gulielmiceras*), 79
 — (*Gulielmites*) *effulgens*, 11
 — — *jason*, 12
 — (*Spinikosmokeras*) *acutistriatum*, 9
 — — *pollux*, 9
 — (*Zugokosmokeras*) *grossouweii*, 9
 — — *obductum*, 9
- labiatus*, *Inoceramus* (*Mytiloides*), 16
Laevitrigonia, 89
lamellosa, *Perna*, 50
laminatus, *Camptonectes*, 68
 —, *Pecten*, 66
lanceolata, *Pinna* (*Pinna*), 43, 44, 44, 45; Pl. 3, figs. 14, 16, 19, 20
laubei, *Isocardia*, 104
- Leda alpina*, 30
 — *morrisi*, 28
lens, *Camptonectes*, 66, 68
 —, *Pecten*, 65, 66, 67, 68
Lingula, 10, 11
 — *craneae*, 4
Liogryphaea, 76
Liostrea, 84
lirata, *Discomiltha*, 91, 92; Pl. 9, figs. 6–12
 —, *Lucina*, 91, 92
lyrata, *Lucina*, 92
 — var. *transversa*, *Lucina*, 91
lituola, *Gryphaea*, 82, 83
 —, *Gryphaea* (*Bilobissa*), 80, 81, 82, 83; Pl. 8, figs. 2–3, 5–7; Pl. 9, fig. 1
Lucina bellona, 91, 92
 — *lirata*, 91, 92
 — *lyrata*, 92
 — — var. *transversa*, 91
 — *rotundata*, 92
 — *transversa*, 91
 — *zietenii*, 91
lurida, *Astarte*, 93, 94
Lutraria elongata, 116
 —? *jurassi*, 116
 — *temuistriata*, 116
 — (*Pleuromya*) *jurassi*, 116
lycetti, *Anisocardia*, 105
 —, *Meleagrinnella*, 58
lyrata var. *transversa*, *Lucina*, 91
- macneillii*, *Corbula*, 112
 —, *Corbulomima*, 18, 112, 112, 113, 114; Pl. 12, figs. 24, 30, 32–40
Macrodon, 35
 — *pictum*, 33, 35
 — — var. A, 33, 35
 — — var. B, 33, 35
 — — var. C, 33, 35
 — — var. D, 33, 35
 — cf. *pictum*, 33
Mactra (*Lutraria*) *gibbosa*, 115
Malletia, 30
 — *evansi*, 30
maltonensis, *Pecten*, 66, 68
mantochensis, *Pecten*, 69
margaritacea, *Neotrigonia*, 17
Mecocheirus, 11
 — *pearcei*, 4
mediterranea, *Solemya*, 30
Meleagrinnella, 9, 10, 11, 16, 18, 54, 57, 60, 79
 — *braamburiensis*, 58, 58, 59, 60, 60, 61; Pl. 4, figs. 20, 24, 26–28, 31–32; Pl. 5, figs. 1–2, 6, 11
 — *echinata*, 61
 — *lycetti*, 58
 — *ovalis*, 61

- Mesosaccella*, 9, 11, 12, 18, 19, 27, 28, 30
 — *galatea*, 30
 — *morrissi*, 27, 28, **28**, 29, 29, 30; Pl. 1, figs. 22, 24–33
nima, *Gryphaea*, 84
Mimachlamys, 68
minima, *Anisocardia*, 105, 107
 —, *Cucullaea*, 33
 —, *Isocardia*, 105
 —, *Rollierella*, 15, 104, *104*, **105**, 106, *106*, 107–109, *109*; Pl. 12, figs. 12, 14–17, 19, 23, 28
minimus, *Grammatodon* (*Grammatodon*), 9, **33**, 34, *34*, 35, 40; Pl. 2, figs. 1–6, 8–10
mitis, *Pinna* (*Pinna*), 16, **43**, 44, *44*, 45; Pl. 3, figs. 6–11, 13, 15
Modiola, 40, 41
 — *aequiblicata*, 41, 42
 — *bipartita*, 41
 — cf. *bipartitus*, 41
 — *cuneata*, 41
 — *holesa*, 41, 42
 — *tulipaea*, 41, 42
 — *villersensis*, 41
modiolaris, *Astarte*, 93
Modiolus, 16, 18, 40, 41, 42
 — (*Modiolus*) *bipartitus*, **41**, 42; Pl. 2, figs. 28–33
 — *imbricatus*, 42
modiolus, *Mytilus*, 40
Monitilora, 91
Monotis inequivalvis, 54
montaneyensis, *Arca* (*Macrodon*), 37
 —, *Grammatodon* (*Grammatodon*), 37
 —, *Paralleledon* (*Grammatodon*), 37
morrissi, *Leda*, 28
 —, *Mesosaccella*, 27, 28, **28**, 29, 29, 30; Pl. 1, figs. 22, 24–33
 —, *Palaeoneilo*, 28
mosae, *Corbula*, 113
 —, *Corbulomima*, 18
 —, *Nicaniella* (*Trautscholdia*), 98
multiformis, *Astarte*, 98
 —, *Nicaniella* (*Trautscholdia*), 100
muensteri, *Avicula*, 53
 —, *Oxytoma*, 57
 —, — (*Avicula*), 54
Mya, 18
 — *depressa*, 118
 — *gibbosa*, 114, 115
 — *pubescens*, 117
Myacites, 114
 — *decurtatus*, 116
 — *jurassi* var. *portlandica*, 116
 — *recurvum*, 115
 — *recurvus*, 115
 — *securiformis*, 116
 — *terquemea*, 116
Myochlamys, 68
Myophorella, 11, 12, 17, 18, 85, 87, 90
 — (*Myophorella*) *caytonensis*, 88, **89**, 90; Pl. 10, figs. 2, 10; Pl. 11, figs. 1, 8
 — *clavellata*, 87
 — (*Myophorella*) *irregularis*, **85**, 86, 87, 88, 90; Pl. 9, figs. 13–17; Pl. 10, figs. 1, 3, 4, 6
 — *nodulosa*, 85
 — *rupellensis*, 89, 90
 — (*Myophorella*) *scarburgensis*, 87, 88, 90
Myopsis, 114
Mytilus, 41
 — *consobrinus*, 42
 — *halesus*, 42
 — *modiolus*, 40
 — *nikitiniensis*, 49, 50
nana, *Exogyra*, 84
 —, *Gryphaea*, 83, 84
 —, *Nanogyra*, **84**; Pl. 9, figs. 2–5
Nanogyra, 16, 18, 83, 84
 — *nana*, **84**; Pl. 9, figs. 2–5
nattheimensis, *Chlamys*, 68
Neocrassina, 93
 — (*Coelastarte*), 93
 — (*Lyapinella*), 93
 — (*Pressastarte*), 11, 12, 17, 18, 93, 94, 96
 — — *calvertensis*, 17, 93, 94, **95**, 96, 96; Pl. 11, figs. 4–7, 9–11
 — — *striatocostata*, 95
 — — *trembiazensis*, 95
 — — *ungulata*, 17, 93, **93**, 94, 95, 95, 96; Pl. 10, figs. 5, 7–9, 11; Pl. 11, figs. 2, 3
 — (*Neocrassina*) sp. nov., 95
Neotrigonia margaritacea, 17
Nicaniella, 96, 97
 — (*Trautscholdia*), 9–12, 17, 18, 97, 98, 100
 — — *carinata*, **97**, 98, 99, 100; Pl. 11, figs. 12–17, 23, 24
 — — *cordata*, 98
 — — *mosae*, 98
 — — *multiformis*, 100
 — — *phillis*, 97, 98, **98**, 99, 100, 100, 101; Pl. 11, figs. 18–22, 25–28; Pl. 12, figs. 1–4
nikitiniensis, *Mytilus*, 49, 50
nitiscens, *Inoceramus*, 51
nodulosa, *Myophorella*, 85
 —, *Trigonia*, 85
nuciformis, *Corbulomima*, 111
Nucula, 19, 22, 25
 — *caecilia*, 27
 — *calliope*, 25, 27
 — *castor*, 19
 — *chassyranum*, 25
 — *cottaldi*, 25, 27
 — *foersteri*, 27
 — *hammeri*, 22
 — *inconstans*, 25
 — *nuda*, 28, 29
 — *ornata*, 25
 — *ornati*, 25, 27
 — *pectinata*, 25
 — *phillipsii*, 28
 — *pollux*, 20
 — *symmetrica*, 30
 — (*Leda*) *phillipsii*, 28
Nuculana, 27
Nuculoma, 19, 20, 22, 23, 25
 — *castor*, 21, 22
 — *chassyranum*, 20, 21
 — *kathrynae*, **21**, 22; Pl. 1, figs. 2–5
 — *pollux*, 19, **20**, 21, *21*, 25; Pl. 1, figs. 1a–c
 — sp. nov., 21
Nuculopsis, 22
nuda, *Nucula*, 28, 29
Nudiola, 40
nummus, *Astarte*, 95
obductum, *Kosmoceras* (*Zugokosmoceras*), 9
oblata, *Homomya*, 115
 —, *Panopaea*, 115
obliqua, *Astarte*, 93
 —, *Avicula*, 48
 —, *Cypricardia*, 93
obscura, *Corbula*, 113
 —, *Corbulomima*, 18, *112*, 113, **113**, 114; Pl. 13, figs. 1–4
Odotocineteta, 117
oehlerti, *Discomiltha*, 90
oolithica, *Anisocardia*, 105
'Ophioderma' weymouthense, 4
ornata, *Nucula*, 25
ornati, *Nucula*, 25, 27
 —, *Pseudomonotis*, 58
 —, *Posidonia*, 51, 52
 —, *Posidonomya*, 51, 52
 —, — (*Bositra*), 51
Osteodesma, 117
Ostrea (*Bilobata*) *gryphaea*, 77
 — (*Gryphaea*) *bilobata*, 77
 — — *calloviensis*, 77
ovale, *Amphidesma*?, 116
ovalis, *Meleagrinnella*, 61
oxfordiensis, *Corbula*, 113
Oxytoma, 10, 11, 16, 18, 53, 54, 57, 79
 — *expansum*, 56, 57
 — (*Oxytoma*) *inequivalve*, **54**, 55, 56, 57; Pl. 4, figs. 7, 9, 11, 13, 15–19, 21–23
 — *inequivalvis*, 54, 56, 57
 — — var. *borealis*, 54
 — cf. *interlaevigata*, 54
 — *interlaevigatum*, 57
 — *muensteri*, 57
 — (*Oxytoma*), sp., 54

- Palaeogyra*, 83
Palaeoneilo, 27, 28
— *choroschowensis*, 28, 30
— *galatea*, 30
— *norrisi*, 28
— *phillipsii*, 28
Palaeonucula, 9-1, 3, 18, 19, 22, 23, 25
— *calliope*, 25, 27; Pl. 1, figs. 14-16, 18-21
— *cottaldi*, 25
— sp. nov., 23
— *triangularis*, 20, 23, 24, 24, 25, 26, 27; Pl. 1, figs. 6-13, 17, 23
Panopaea depressa, 118
— *oblata*, 115
Parainoceramus, 11, 16, 18, 48-50
— *bulkurensis*, 48
— *subtilis*, 16, 49, 49, 50, 50; Pl. 3, figs. 12, 17-18, 21-22; Pl. 4, figs. 1, 2, 12
Parallelodon, 33, 36
— *gnoma*, 36
— (*Grammatodon*) *concinnum*, 36
— — *montaneyensis*, 37
— — *pictum*, 33, 35
— — *schourovskii*, 33, 35
parkinsoni, *Posidonia*, 52
partitum, *Entolium*, 64
pearcei, *Mecocheirus*, 4
Pecten arcuatus, 66
— *cingulatus*, 62, 64
— *corneolus*, 62
— *demissus*, 61, 62
— *disciforme*, 61
— *discrepans*, 70, 71
— *fibrosus*, 70, 71, 72
— *hemicosatus*, 70
— *islandicus*, 68
— *laminatus*, 66
— *lens*, 65, 66, 67, 68
— *maltonensis*, 66, 68
— *manlochensis*, 69
— *phillipsii*, 62, 64
— *rigida*, 62, 66
— *scarburgensis*, 70
— *solidus*, 64
— *sulcatus*, 72
— *vagans*, 72
— *vitreus*, 64
— sp., 62, 64
— (*Aequipecten*) *fibrosus*, 72
— — — var. *duplicostatus*, 71, 72
— — — *tenuistriatus*, 72
— (*Entolium*) *demissus*, 62
pectinata, *Nucula*, 25
Pectinites, 66
pelops, *Astarte*, 95
Pennaria, 43
Perna, 40
— *subtilis*, 49
— *lamellosa*, 50
Pernopecten, 62
philea, *Astarte*, 95
phillipsi, *Pteria*, 54
phillipsii, *Nucula*, 28
—, — (*Leda*), 28
—, *Palaeoneilo*, 28
—, *Pecten*, 62, 64
phillis, *Astarte*, 98, 100
—, *Nicaniella* (*Trautscholdia*), 97, 98, 98, 99, 100, 100, 101; Pl. 11, figs. 18-22, 25-28; Pl. 11, figs. 18-22, 25-28; Pl. 12, figs. 1-4
—, *Trautscholdia*, 98
pictum, *Macrodon*, 33, 35
— var. A, *Macrodon*, 33, 35
— var. B, *Macrodon*, 33, 35
— var. C, *Macrodon*, 33, 35
— var. D, *Macrodon*, 33, 35
—, *Macrodon* cf., 33
—, *Parallelodon* (*Grammatodon*), 33, 35
—, *Pseudomacrodon*, 33
Pinna, 10, 11, 12, 16, 18, 43, 45
— *capricornus*, 45
— (*Pinna*) *lanceolata*, 43, 44, 44, 45; Pl. 3, figs. 14, 16, 19, 20
— — *mitis*, 16, 43, 44, 44, 45; Pl. 3, figs. 6-11, 13, 15
— cf. *mitis*, 43, 44
— *rudis*, 43
— *rugosoradiata*, 43
Pinnarius, 43
Pinnites, 43
Pinnula, 43
Plastomiltha, 91
Pleuromya, 18, 18, 19, 114, 120
— *agassizi*, 115
— *alduini*, 18, 115, 116, 117, 120; Pl. 13, figs. 5-10, 12, 15
— *calceiformis*, 116, 117
— *decurtata*, 116
— *elea*, 117
— *jurassi*, 116, 117
— *polonica*, 116
— *recurva*, 115
— *tellina*, 116, 117
— *uniformis*, 18, 116, 116, 117, 120; Pl. 13, figs. 11, 14, 18, 21
— *voltzi*, 117
Pleurotomaria reticulata, 4
Plicatula, 16, 18, 75
— *fistulosa*, 75, 76; Pl. 6, figs. 12
— (*Plicatula*) cf. *fistulosa*, 75; Pl. 6, figs. 10, 13-15
— *weymouthiana*, 75, 76; Pl. 6, fig. 11
Plicatulopecten, 75
plicatus, *Spondylus*, 75
politula, *Isocyprina*, 111
pollux, *Kosmoceras* (*Spinikosmokeras*), 9
—, *Nucula*, 20
—, *Nuculoma*, 19, 20, 21, 21, 25; Pl. 1, figs. 1a-c
polonica, *Pleuromya*, 116
polyodon, *Avicula*, 48
Posidonia, 51
— *becheri*, 51
— *bronni*, 51
— *buchii*, 51, 52
— *ornati*, 51, 52
— *parkinsoni*, 52
— *radiata*, 52
Posidonomya alpina, 52
— *ornati*, 51, 52
— (*Bostira*) *ornati*, 51
Potamomya? sedgwickii, 116
—? *soverbyii*, 115
Procerithium, 9, 11
— *damone*, 4
Prodentalium calvertense, 4, 10, 11
Promyophorella, 85
Protamusium, 61
proteus, *Entolium*, 64
Protocardia, 9-11, 17, 18, 101-103
— *citrinoidea*, 103
— *crawfordii*, 102, 103
— *dyonisea*, 103
— *intexta*, 103
— (*Protocardia*) *striatula*, 102, 103; Pl. 12, figs. 7-11, 13
— *stricklandi*, 103
— (*Protocardia*) sp., 103; Pl. 12, figs. 5-6
Pruvostiella, 93
Pseudomacrodon, 33, 35, 36
— *pictum*, 33
Pseudomonotis, 60
— *braamburiensis*, 58, 60
— *echinata*, 61
— *ornati*, 58
— *subechinata*, 58, 60
— *substriata*, 58
— sp. nov., 61
Pseudotrapezium, 104
Pteria, 16, 46, 47
— *phillipsii*, 54
Pteroperma, 16, 18, 45, 46, 47
—? *blakei*, 48
— *costatula*, 46, 47, 48
— *gibbosa*, 46
— *pygmaea*, 46, 47, 48
—? *pygmaea*, 46, 47, 47, 48, 48; Pl. 3, figs. 1-5
— *pygmaea* var. *baltica*, 46, 48
— *pygmaea*, 46
pubescens, *Mya*, 117
—, *Thracia*, 117, 121
Puschia, 93
puzosiana, *Cylindroteuthis*, 4, 9, 79
pygmaea, *Avicula*, 46, 48
—, *Gervillia*, 46, 48
—, *Pteroperma*, 46, 47, 48

- , *Pteroperna*?, 46, 47, 47, 48, 48;
Pl. 3, figs. 1–5
— var. *baltica*, *Pteroperna*, 46, 48
pygmaea, *Pteroperna*, 46
Pygocardia tumida, 105
- qualicosta*, *Chlamys*, 68
Quantulopinna, 43
quenstedtii, *Arca*, 37, 39
- radiata*, ‘*Posidonia*’, 52
Radulopecten, 68, 70
recurva, *Pleuromya*, 115
recurvum, *Amphidesma*, 115
—, *Myacites*, 115
recurvus, *Myacites*, 115
reneveri, *Entolium*, 64
reticulata, *Pleurotomaria*, 4
rhyphum, *Entolium*, 62, 63
rigida, *Pecten*, 62, 66
robusta, *Astarte*, 100
roederi, *Isocyprina*, 110, 111
—, — (*Isocyprina*), 110, 111; Pl. 12,
figs. 25–27, 29, 31
—, — (*Eotrapezium*), 110
Rollierella, 18, 18, 104, 106, 107
— *minima*, 15, 104, 104, 105, 106,
106, 107, 108, 109, 109; Pl. 12,
figs. 12, 14–17, 19, 23, 28
Rollieria, 104
rotundata, *Lucina*, 92
rudis, *Pinna*, 43
rugosoradiata, *Pinna*, 43
rupellensis, *Myophorella*, 89, 90
—, *Trigonia*, 89, 90
Rygepha, 76
- Saccella*, 27
sauvagei, *Astarte*, 98
Saxolucina, 91
Scaechlamys, 68
Scaphotrigonia, 85
scarburgensis, *Chlamys* (*Radulopecten*),
16, 18, 70, 70, 71, 72, 74; Pl. 5,
figs. 19–20, 23–24, 26–27; Pl. 6,
figs. 1, 5–6
—, *Myophorella* (*Myophorella*), 87,
88, 90
—, *Pecten*, 70
—, *Trigonia*, 90
schourovskii, *Grammatodon*, 35
—, *Parallelodon* (*Grammatodon*), 33, 35
securiformis, *Myacites*, 116
sedgwickii, *Potamomya*?, 116
simplex, *Isocyprina*, 111
Solemya, 10, 11, 17, 18, 29–32
— *mediterranea*, 30
— (*Solemya*) *togata*, 31
— *voltzii*, 30, 32
— *woodwardiana*, 17, 30, 31, 31, 32,
32; Pl. 1, figs. 34–44
— (*Solemyarina*), 32
- solidus*, *Pecten*, 64
sowerbyii, *Potamomya*? 115,
sp. A, *Anomalodesmatan*, 120, 121;
Pl. 13, figs. 16, 17, 27
—, *Entolium*, 12, 16, 62, 64, 65, 65;
Pl. 5, figs. 7–10, 12, 13, 17
sp. B, *Anomalodesmatan*, 121, Pl.
13, figs. 24–26
sp. nov., *Chlamys* (*Chlamys*), 69
—, *Corbula*, 113
—, “*Entolium*”, 64
—, *Gryphaea* (*Bilobissa*), 77
—, *Neocrassina* (*Neocrassina*), 95
—, *Nuculoma*, 21
—, *Palaeonucula*, 23
—, *Pseudomonotis*, 61
Sphaerium, 101
Spinigera spinosa, 4
spinosa, *Spinigera*, 4
splendens, *Chlamys*, 68
Spondylus, 75
— *plicatus*, 75
Steinmannia, 51
Stephanopus, 30
striatocostata, *Neocrassina* (*Pressastarte*),
95
striatula, *Protocardia* (*Protocardia*), 102,
103; Pl. 12, figs. 7–11, 13
striatum, *Cardium*, 102
stricklandi, *Protocardia*, 103
subcostata, *Avicula*, 54
subechinata, *Pseudomonotis*, 58, 60
Subitopinna, 43
substriata, *Pseudomonotis*, 58
subtetragona, *Arca*, 39
subtextoria, *Chlamys*, 69
subtilis, *Parainoceramus*, 16, 49, 49, 50,
50; Pl. 3, figs. 12, 17–18, 21–22;
Pl. 4, figs. 1, 2, 12
—, *Perna*, 49
sulcata, *Astarte*, 97
—, *Belemnopsis*, 4
—, *Venus*, 85
Sulcatopinna, 43
sulcatus, *Pecten*, 72
suprajurensis, *Corbulomima*, 111, 114
symmetrica, *Nucula*, 30
Syncyclonema, 62
- Talochlamys*, 68
Tellina incerta, 118
— *togata*, 30
tellina, *Pleuromya*, 116, 117
tener, *Isocardia*, 108
tenera, *Anisocardia*, 104, 105, 107–109
—, — (*Anisocardia*), 108, 109, 109;
Pl. 12, figs. 18, 20–22
—, *Isocardia*, 105, 108
tenerum, *Eotrapezium*, 104
tenuicostatus, *Pecten* (*Aequipecten*), 72
tenuistriata, *Lutrarina*, 116
- terquemea*, *Myacites*, 116
Thracia, 11, 12, 17, 18, 19, 117, 118,
121
— *depressa*, 118
— (*Thracia*) *depressa*, 118, 119, 120,
121; Pl. 13, figs. 13, 19, 20, 22,
23, 28
— *incerta*, 118, 119, 120
— *pubescens*, 117, 121
— *undulata*, 118
togata, *Solemya*, 31
— *Tellina*, 30
transversa, *Lucina*, 91
Trautscholdia phillis, 98
trembiazensis, *Astarte*, 93
—, *Neocrassina* (*Pressastarte*), 95
triangularis, *Palaeonucula*, 20, 23, 24,
24, 25–27; Pl. 1, figs. 6–13, 17,
23
trifidum, *Dicroloma*, 4
Trigonia, 85
— *clavellata*, 75, 85, 89, 90
— *irregularis*, 85
— aff. *irregularis*, 88
— *nodulosa*, 85
— *rupellensis*, 89, 90
— *scarburgensis*, 90
tulipaea, *Modiola*, 41, 42
tumida, *Isocardia*, 105
—, *Pygocardia*, 105
- undulata*, *Thracia*, 118
ungulata, *Astarte*, 93
—, *Neocrassina* (*Pressastarte*), 17, 93,
93, 94, 95, 95, 96; Pl. 10, figs. 5,
7–9, 11, Pl. 11, figs. 2, 3
uniformis, *Pleuromya*, 18, 116, 116,
117, 120; Pl. 13, figs. 11, 14, 18, 21
—, *Unio*, 116
Unio, 117
— *uniformis*, 116
- vagans*, *Pecten*, 72
Venus sulcata, 85
Veprichlamys, 68
vertebralis, *Genicularia*, 4
villersensis, *Isocardia*, 105
—, *Modiola*, 41
vitreus, *Pecten*, 64
Volsella, 40, 41
voltzi, *Pleuromya*, 117
—, *Solemya*, 30, 32
- weymouthense*, ‘*Ophioderma*’, 4
weymouthiana, *Plicatula*, 75, 76; Pl. 6,
fig. 11
woodwardiana, *Solemya*, 17, 30, 31,
31, 32, 32; Pl. 1, figs. 34–44
- Yoldia*, 19
- zietenii*, *Lucina*, 91
Zygochlamys, 68

PLATES 1-13

Unless otherwise stated all figures show the external surface
of specimens from the Lower Oxford Clay.

Explanation of PLATE 1 (continued from next page)

Solemya woodwardiana Leckenby, 1859
Lower Oxford Clay, Brora, Sutherland

31

- 34 Left valve. LU 69743. $\times 1$.
42 Right valve. LU 69774. $\times 1$.

“Kelloway Rock”, Castle Rock, Scarborough, Yorkshire

- 35 Paratype, left valve. SM J12570. $\times 1$.
37 Holotype, left valve. SM J6008. Figured Leckenby 1859, pl. 3, fig. 7. $\times 1$.

grossourei Subzone, Calvert, Buckinghamshire

- 36 Left valve. LU 69756. $\times 1$.
38a, b Left valve, internal views, $\times 1$ and $\times 3$. LU 69757.
39 Right valve. LU 69752. $\times 1$.
40 Both valves. LU 69754. $\times 2$.
43 Right valve. LU 69758. $\times 1$.

grossourei Subzone, Norman Cross, Cambridgeshire

- 41 Right valve. LU 69750. $\times 1$.

jason Subzone, Calvert, Buckinghamshire

- 44 Left valve. LU 69749. $\times 1$.

Fig.		Page
	<i>Nuculoma pollux</i> (d'Orbigny, 1850)	20
1a-c	Both valves, left view, $\times 2$; detail of ornament, $\times 3$; and dorsal view, $\times 2$. Oxford Clay, Wiltshire. YM 634.	
	<i>Nuculoma kathrynae</i> sp. nov.	21
	Oxford Clay, Wiltshire. All $\times 2$	
2a-c	Holotype, both valves, external, anterodorsal and posterior views. GSM 114030.	
3a, b	Paratype, right valve, internal and external views. GSM 114035.	
4	Paratype, left valve. GSM 114031.	
5	Paratype, right valve. GSM 114033.	23
	<i>Palaeonucula triangularis</i> sp. nov.	
	<i>coronatum</i> Zone, Stewartby, Bedfordshire. All $\times 1.5$	
6	Paratype, left valve, internal view. BM LL27717.	
7a, b	Paratype, both valves, left and dorsal views. BM LL27716.	
8a, b	Holotype, both valves, left and dorsal views. BM LL27713.	
9a, b	Paratype, both valves, right and dorsal views. BM LL27718.	
10a, b	Paratype, both valves, left and dorsal views. BM LL27714.	
11a, b	Paratype, both valves, dorsal and right views. BM LL27719.	
12	Paratype, right valve, internal view. BM LL27715.	
23	Paratype, internal mould, dorsal view. LU 68611.	
	<i>coronatum</i> Zone, Norman Cross, Cambridgeshire	
13	Paratype, left valve. LU 68606. $\times 1.5$.	
	<i>jason</i> Zone, Stewartby, Bedfordshire	
17	Paratype, right valve. LU 68605. $\times 1.5$.	
	<i>Palaeonucula calliope</i> (d'Orbigny, 1850)	25
14a, b	Both valves, left and dorsal views. Oxford Clay, Wiltshire. GSM Y2083. $\times 1$.	
15	Right valve, internal view. Oxford Clay, Wiltshire. GSM Y2082. $\times 1$.	
16	Left valve. Upper Oxford Clay, <i>mariae</i> Zone, Scarborough, Yorkshire. YM 635. $\times 1$.	
18	Left valve, internal mould. Upper Oxford Clay, <i>cordatum</i> Zone, Warboys, Cambridgeshire. GSM Dr2508. $\times 1$.	
19	Right valve, internal mould. Horizon and locality as fig. 18. GSM Dr2526. $\times 1$.	
20	Left valve. Oxford Clay, "Near Osmington", Dorset. GSM Y2049. $\times 1$.	
21	Internal mould, dorsal view. Oxford Clay, Lukow, Poland. $\times 1$. Author's collection.	
	<i>Mesosaccella morrisi</i> (Deshayes, 1853)	28
	<i>obductum</i> Subzone, Stewartby, Bedfordshire. All $\times 2$	
22a, b	Both valves, left and dorsal views. LU 68616.	
26	Right valve. LU 68612.	
27	Left valve, internal view. Author's collection.	
29	Left valve. LU 68613.	
33a, b	Internal mould, left and dorsal views. LU 68623.	
	Lower Oxford Clay, Christian Malford, Wiltshire	
24	Neotype, right valve, internal view. BM L67154. Figured Cox 1937, pl. 15, fig. 1. $\times 2$.	
	Oxford Clay, Kempston, Bedfordshire. All $\times 2$	
25	Right valve. GSM 75700.	
28	Right valve. GSM 75698.	
32	Dorsal view. GSM 75702.	
	<i>grossowrei</i> Subzone, Stewartby, Bedfordshire	
30	Right valve. LU 68617. $\times 2$.	
	<i>grossowrei</i> Subzone, Marston Moretaine, Bedfordshire	
31	Left valve, internal view. LU 68619. $\times 2$.	

(Continued on previous page)

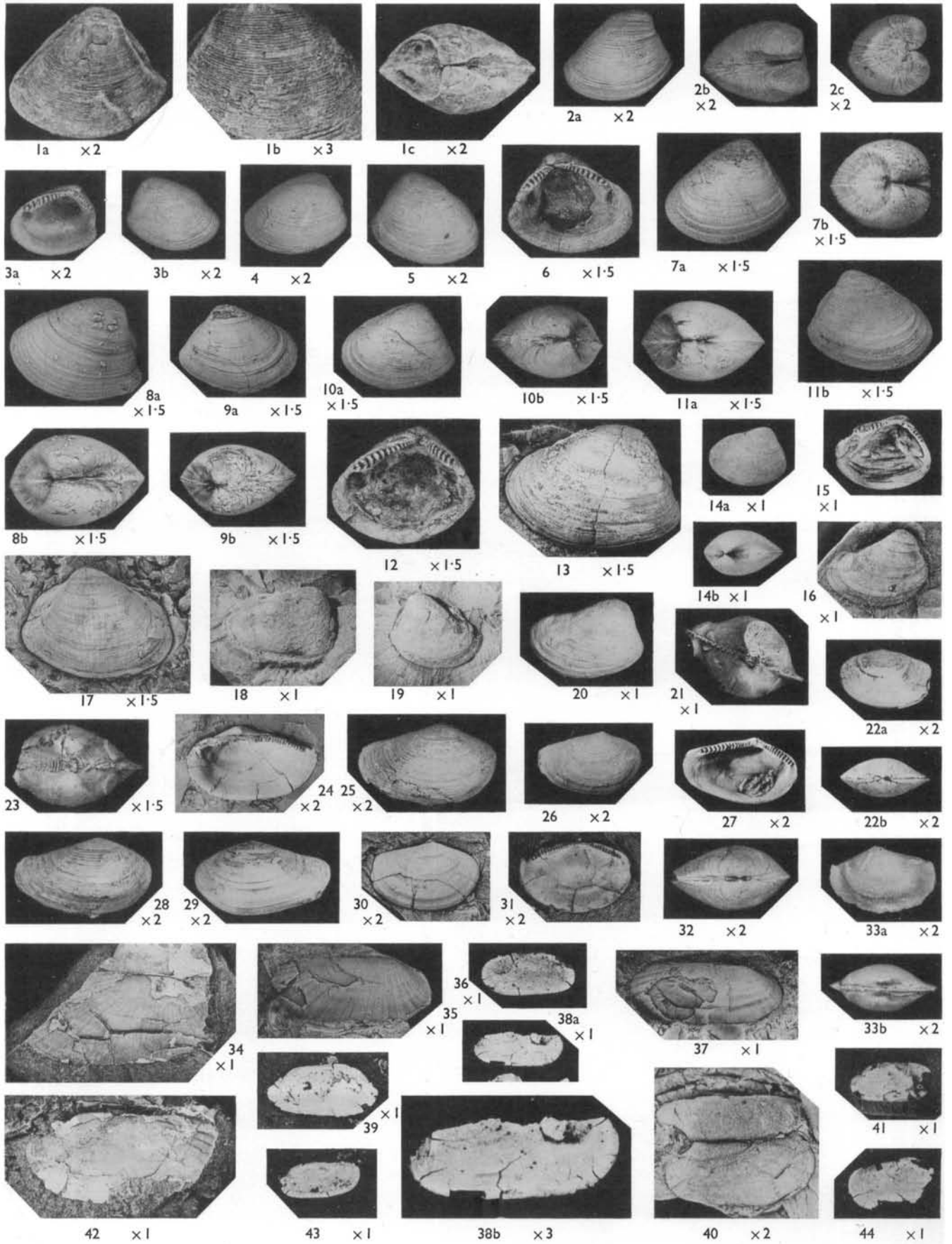

- Fig. *Grammatodon (Grammatodon) minimus* (Leckenby, 1859)
Hackness Rock, Scarborough, Yorkshire
- 1 Holotype, left valve. SM J6007a. Figured Leckenby 1859, pl. 3, fig. 5. $\times 2.1$.
- 2 Left valve, "Silcoset" cast. LU 69759. $\times 1.4$.
- 3 Right valve, "Silcoset" cast. LU 69764. $\times 2.6$.
- grossourei* Subzone, Chickerell, Dorset
- 4 Left valve, "Silcoset" cast. LU 69762. $\times 3.3$.
- 5 Left valve, "Silcoset" cast. LU 69763. $\times 2.7$.
- 6 Left valve, "Silcoset" cast. LU 69761. $\times 2.4$.
- grossourei* Subzone, Stewartby, Bedfordshire.
- 8 Left valve, "Silcoset" cast. LU 69765. $\times 1.8$.
- 9 Left valve, "Silcoset" cast. LU 68626. $\times 1.7$.
- 10 Right valve, internal view. LU 68627. $\times 1.6$.
- Grammatodon (Grammatodon) concinnus* (Phillips, 1829) 36
Upper Oxford Clay, *mariae* Zone, Scarborough, Yorkshire
- 7 Holotype, left valve, internal mould. YM 941. Figured Phillips 1829, pl. 5, fig. 9. $\times 1.7$.
- jason* Subzone, Calvert, Buckinghamshire
- 11 Right valve. LU 68644. $\times 1.2$.
- 12 Left valve. LU 68646. $\times 1.2$.
- 14 Left valve. LU 68648. $\times 1.1$.
- 16 Left valve. LU 68645. $\times 1.2$.
- Kellaways Rock, Sutton Benger, Wiltshire
- 13a-c Right valve, external, internal and dorsal views. GSM Zr1699. $\times 1.1$.
- medea* Subzone, Stewartby, Bedfordshire
- 15a, b Left valve, external and dorsal views. LU 68647. $\times 1.3$.
- jason* Subzone, Norman Cross, Cambridgeshire
- 17 Left valve. LU 68624. $\times 1.4$.
- 19 Right valve, "Silcoset" cast. LU 68650. $\times 1.1$.
- Grammatodon (Grammatodon) hersilius* (d'Orbigny, 1850) 37
Oxford Clay, Chippenham, Wiltshire. GSM 52300. $\times 1.4$.
- 18a, b Both valves, left and dorsal views. Oxford Clay, Chippenham, Wiltshire. GSM 52300. $\times 1.4$.
- 20 Right valve, internal mould. Snowdown Borehole, Kent. GSM K113. $\times 2$.
- 24 Left valve. Kellaways Rock, Sutton Benger, Wiltshire. GSM Zr1700. $\times 1.2$.
- Grammatodon (Grammatodon) clathvatus* (Leckenby, 1859) 39
Cornbrash, Scarborough, Yorkshire
- 21 Right valve. YM 626. $\times 0.8$.
- 27a, b Right valve, external and dorsal views. YM 898. $\times 1$.
- Hackness Rock, Scarborough, Yorkshire
- 22 Holotype, left valve. SM J6005. Figured Leckenby 1859, pl. 3, fig. 4. $\times 1$.
- Oxford Clay, Chippenham, Wiltshire
- 23 Left valve. GSM 113414. $\times 1$.
- jason* Zone, Stewartby, Bedfordshire
- 25a-c Left valve, dorsal, external and internal views. LU 68658. $\times 1$.
- 26 Left valve. LU 68656. $\times 1$.
- Modiolus (Modiolus) bipartitus* J. Sowerby, 1818 41
Upper Oxford Clay, Red Nodule Beds (*cordatum* Zone), Weymouth,
Dorset. BM 43231. Figured J. Sowerby 1818, pl. 210, fig. 4. $\times 1$.
- 28 Lectotype, right valve. Upper Oxford Clay, Red Nodule Beds (*cordatum* Zone), Weymouth,
Dorset. BM 43231. Figured J. Sowerby 1818, pl. 210, fig. 4. $\times 1$.
- 29a-c Both valves, right, anterodorsal and posterodorsal views. Lower Calcareous Grit (*Oxfordian*),
Scarborough, Yorkshire. YM 894. $\times 1$.
- 30 Left valve. Horizon and locality as fig. 29a-c. YM 899. $\times 1$.
- 31 Left valve. Middle Oxford Clay. *lamberti* Zone, Woodham, Buckinghamshire. LU 69943. $\times 1$.
- 32 Both valves, posterodorsal view. *calloviense* Zone, Stewartby, Bedfordshire. LU 69944. $\times 1$.
- 33 Left valve. *coronatum* Zone, Calvert, Buckinghamshire. LU 70015. $\times 1$.

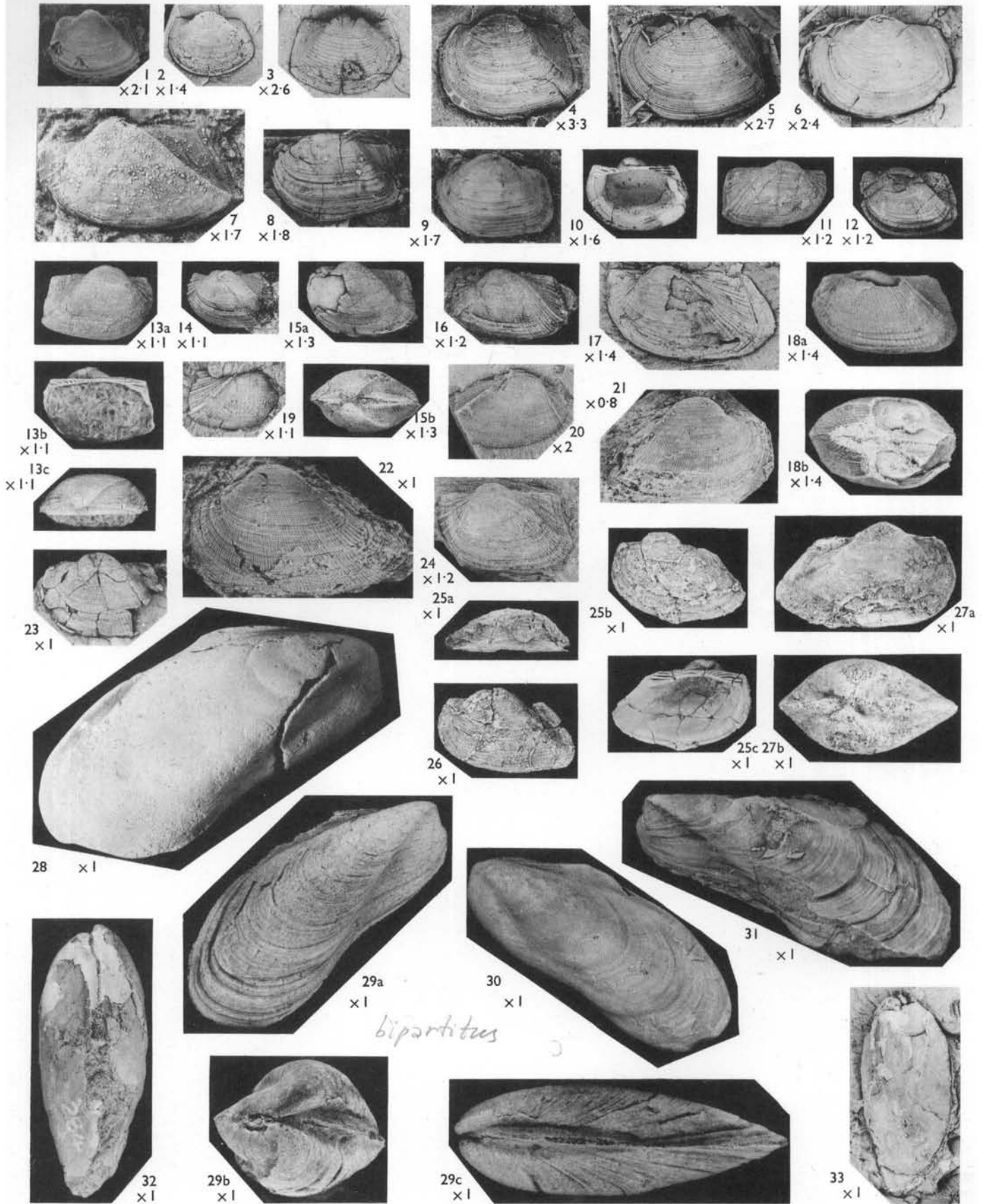
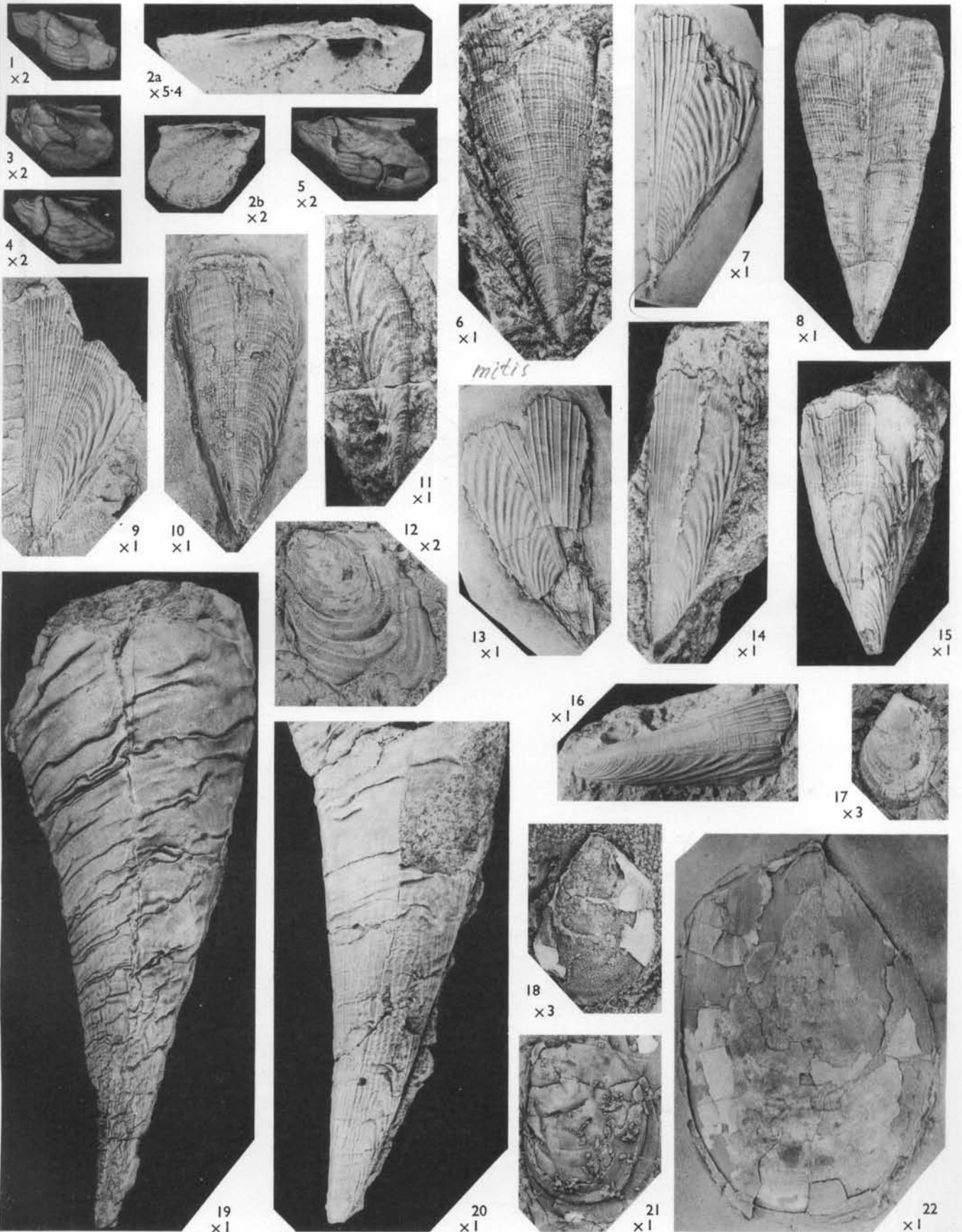

PLATE 3

Fig.		Page
	<i>Pteroperna? pygmaea</i> (Dunker, 1837) Lower Oxford Clay, Wiltshire	46
1	Left valve. BCM Cb4781. × 2.	
2a, b	Left valve, internal views, "Silcoset" cast, × 5.4 and × 2. BCM Cb4777.	
3	Left valve. BCM Cb4779. × 2.	
4	Left valve. BCM Cb4780. × 2.	
5	Left valve. BCM Cb4778. × 2.	
	<i>Pinna (Pinna) mitis</i> Phillips, 1829 Upper Oxford Clay, <i>mariae</i> Zone, Scarborough, Yorkshire	43
6	Right valve. YM 872. × 1.	
10	Left valve. SM J26740. × 1.	
11	Holotype, right valve. YM 219. Figured Phillips 1829, pl. 5, fig. 7; Arkell 1933, pl. 26, fig. 7. × 1.	
	Lower Oxford Clay, Wiltshire	
7	Left valve. BM 34469. × 1.	
13	Right valve. BM L9728. × 1.	
	Upper Oxford Clay, <i>mariae</i> Zone, Woodham, Buckinghamshire	
8	Both valves, dorsal view. OUM J30186. × 1.	
	<i>jason</i> Zone, Stewartby, Bedfordshire	
9	Left valve, "Silcoset" cast. LU 68660. × 1.	
	Kellaways Rock, Chippenham, Wiltshire	
15	Left valve. SM J12887. × 1.	
	<i>Pinna (Pinna) lanceolata</i> J. Sowerby, 1821 Coralline Oolite (Oxfordian), Malton, Yorkshire	45
14	Left valve. YM 874. × 1.	
16	Left valve. BM 66884. × 1.	
	Lower Calcareous Grit (Oxfordian), Scarborough, Yorkshire	
19	Left valve. YM 875. × 1.	
20	Left valve. YM 901. × 1.	
	<i>Parainoceramus subtilis</i> (Lahusen, 1883)	49
12	Left valve. <i>coronatum</i> Zone, Stewartby, Bedfordshire. LU 68687. × 2.	
17	Left valve. <i>jason</i> Zone, Stewartby, Bedfordshire. LU 68676. × 3.	
18	Left valve. Horizon and locality as fig. 12. LU 68685. × 3.	
21	Left valve. <i>coronatum</i> Zone, Marston Moretaine, Bedfordshire. LU 68675. × 1.	
22	Right valve. Lower Oxford Clay, Wiltshire. BCM Cb4774. × 1.	



mitis

lanceolata

Parainoceramus subtilis (Lachner, 1866)

Fig.		Page
	<i>Parainoceramus subtilis</i> (Lahusen, 1883)	49
1	Right valve, internal view. <i>coronatum</i> Zone, Marston Moretaine, Bedfordshire. LU 69946. × 2.	
2	Left valve. <i>coronatum</i> Zone, Stewartby, Bedfordshire. LU 68695. × 2.	
12	Right valve, internal view. Horizon and locality as fig. 2. LU 69948. × 3.	
	<i>Bositra buchii</i> (Roemer, 1836)	52
	<i>coronatum</i> Zone, Stewartby, Bedfordshire. × 2.	
3	Right valve. LU 68702.	
14	Both valves. LU 68701.	
	<i>jason</i> Zone, Stewartby, Bedfordshire. All × 2	
4	Left valve. LU 68703.	
5	Left valve, "Silcoset" cast. LU 68697.	
8	Right valve. LU 68705.	
10	Left valve. LU 68706.	
	<i>jason</i> Zone, Crook Hill, Chickerell, Dorset	
6	Slab with many specimens. LU 68704. × 1.	
	<i>Oxytoma</i> (<i>Oxytoma</i>) <i>inequivalve</i> (J. Sowerby, 1819)	54
7	Left valve. Kellaways Clay, Putton Lane, Chickerell, Dorset. SM J47646b. × 1.5.	
9	Right valve. <i>jason</i> Zone, Stewartby, Bedfordshire. LU 68752. × 2.	
11	Left valve, "Silcoset" cast. <i>coronatum</i> Zone, Calvert, Buckinghamshire. LU 69949. × 1.5.	
13	Right valve. <i>jason</i> Zone, Calvert, Buckinghamshire. LU 69951. × 3.5.	
15	Left valve. Kellaways Rock, Putton Lane, Chickerell, Dorset. OUM J28250. × 1.5.	
16	Lectotype, left valve. Middle Lias, Dursley, Gloucestershire. BM L43259a. Figured J. Sowerby 1819, pl. 244, fig. 2, left hand figure. × 1.	
17	Left valve, "Silcoset" cast. Horizon and locality as fig. 9. LU 68749. × 3.5.	
18	Left valve. Kellaways Rock, Tytherton Lucas, Wiltshire. BU 11435. × 1.	
19	Right valve, internal view. Middle Oxford Clay, <i>lamberti</i> Zone, Woodham, Buckinghamshire. LU 52676. × 2.5.	
21	Paralectotype, left valve. Horizon and locality as fig. 16. BM L43259b. × 1.	
22	Left valve. Horizon and locality as fig. 7. SM J47646a. × 1.5.	
23	Left valve, internal view. Horizon and locality as fig. 19. LU 52671. × 1.5.	
	<i>Meleagrinea braamburiensis</i> (Phillips, 1829)	58
20 and 24	(left figure) Neotype, left valve, internal mould, × 1.5 and × 1. Hackness Rock, Scarborough, Yorkshire. YM 902. Figured Douglas & Arkell 1932, pl. 7, fig. 5.	
24	(right figure) Left valve, internal mould. Horizon and locality as fig. 20. YM 903. × 1.	
26a-c	Left valve, two internal and external views, × 3.5 (26a), × 1 (26b, c). Oxford Clay, Trowbridge, Wiltshire. GSM Y2088.	
27a-c	Left valve, internal, posterior and external views, × 3.5 (27a), × 1 (27b, c). Horizon and locality as figs. 26a-c. GSM Y2087.	
28	Left valve. <i>jason</i> Zone, Calvert, Buckinghamshire. LU 69954. × 3.5.	
31	Left valve. <i>coronatum</i> Zone, Calvert, Buckinghamshire. LU 68756. × 2.	
32	Right valve. <i>coronatum</i> Zone, Stewartby, Bedfordshire. LU 68771. × 3.	
	<i>Entolium</i> (<i>Entolium</i>) <i>corneolum</i> (Young & Bird, 1828)	62
	Lower Oxford Clay, Brora, Sutherland	
25	Right valve, internal view. LU 69958. × 2.	
30	Right valve. LU 69959. × 2.	
	Kellaways Rock, Scarborough, Yorkshire	
29	Left valve. BM 47443. × 1.	

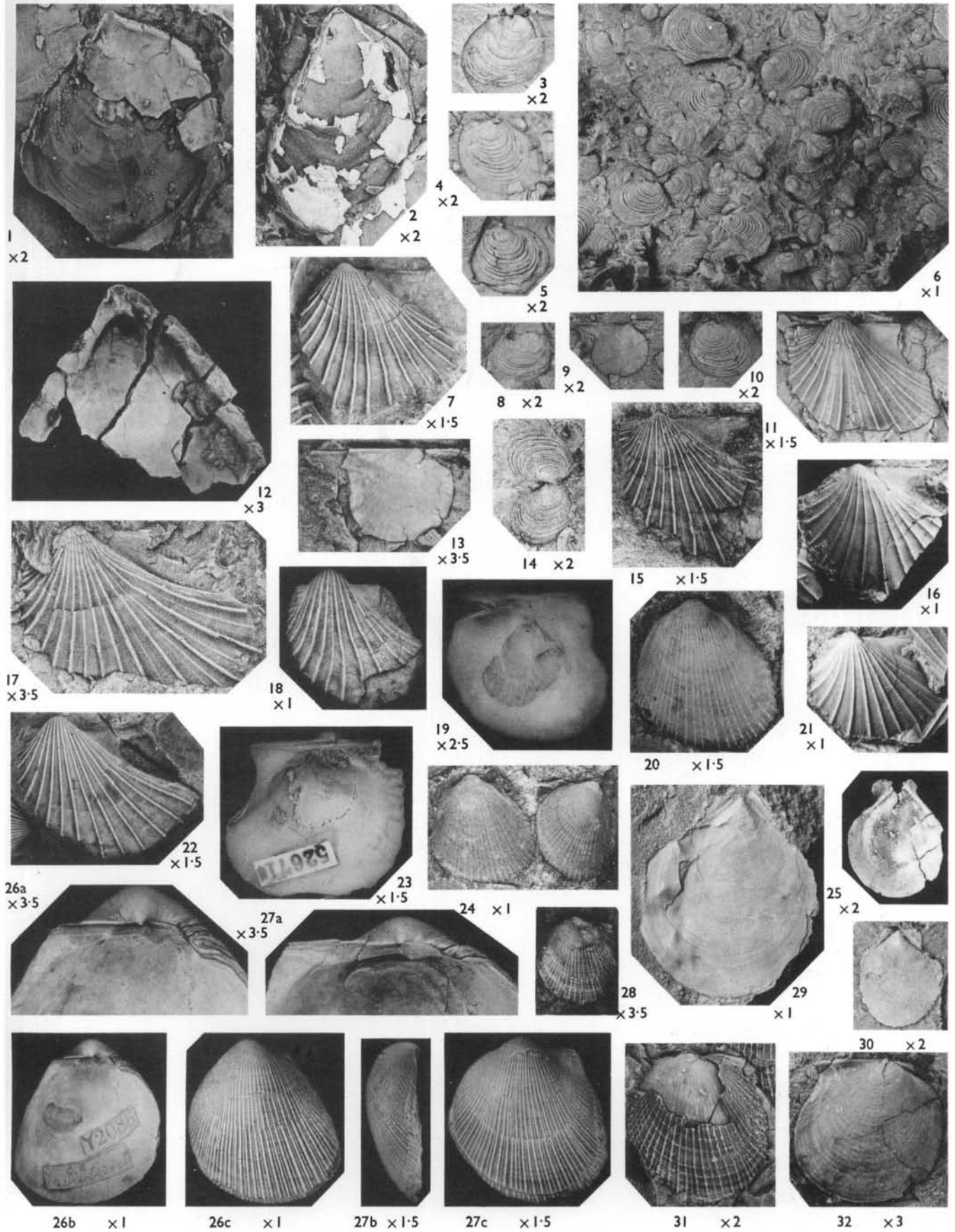

Fig.		Page
	<i>Meleagrinnella braamburiensis</i> (Phillips, 1829) <i>coronatum</i> Zone, Calvert, Buckinghamshire	58
1	Right valve, "Silcoset" cast. LU 69957. $\times 2.5$.	
2	Left valve. LU 68753. $\times 2$.	
6	Left valve, "Silcoset" cast. LU 68761. $\times 2.5$.	
	<i>coronatum</i> Zone, Stewartby, Bedfordshire	
11	Articulated specimen, view from the right. LU 68758. $\times 1$.	
	<i>Entolium (Entolium) corneolum</i> (Young & Bird, 1828) Hackness Rock, Scarborough, Yorkshire	62
3	Left valve. YM 202. Holotype of <i>Pecten demissus</i> Phillips 1829, pl. 6, fig. 5. $\times 1$.	
	Kellaways Rock, Scarborough, Yorkshire	
4	Left valve. SM J12396. $\times 1$.	
5	Left valve. SM J12397. $\times 1$.	
	<i>Entolium</i> sp. A <i>coronatum</i> Zone, Norman Cross, Cambridgeshire	64
7	Right valve, internal view. BM LL27723. $\times 4.5$.	
12	Right valve, internal view. BM LL27722. $\times 4.5$.	
13	Right valve, internal view. BM LL27750. $\times 4.5$.	
17	Right valve, internal view. BM LL27751. $\times 6$.	
	<i>coronatum</i> Zone, Calvert, Buckinghamshire	
8	Right valve. LU 69960. $\times 4.5$.	
	<i>coronatum</i> Zone, Stewartby, Bedfordshire	
9	Right valve. LU 73003. $\times 6$.	
10	Right valve. LU 69937. $\times 6$.	
	<i>Camptonectes (Camptonectes) auritus</i> (Schlotheim, 1813)	66
22a, b	Right valve, external and internal views. Coralline Oolite (Oxfordian), Malton, Yorkshire. BM LL2445. $\times 1$ and $\times 1.2$.	
25	Neotype, left valve. Berkshire Oolite Series (Oxfordian), Headington, Oxfordshire. BM L80525. Syntype of <i>Pecten lens</i> J. Sowerby 1818, pl. 205, fig. 2. $\times 1$.	
	<i>Chlamys (Chlamys) bedfordensis</i> sp. nov. <i>coronatum</i> Zone, Stewartby, Bedfordshire	69
14	Paratype, right valve. BM LL27725. $\times 3$.	
	<i>coronatum</i> Zone, Norman Cross, Cambridgeshire	
15	Paratype, right valve, internal view. BM LL27727. $\times 3$.	
	<i>coronatum</i> Zone, Calvert, Buckinghamshire	
16a, b	Holotype, right valve, detail of ornament and external view. BM LL27724. $\times 6$ (16a), $\times 3$ (16b).	
18	Left valve, "Silcoset" cast. BM LL27726. $\times 3$.	
21	Left valve, internal view. BM LL27728. $\times 3$.	
	<i>Chlamys (Radulopecten) scarburgensis</i> (Young & Bird, 1822)	70
19	Left valve. Upper Oxford Clay, Oxfordshire. BM L8958c. $\times 1.5$.	
20	Left valve, detail of ornament. <i>jason</i> Zone, Stewartby, Bedfordshire. LU 69961. $\times 1.5$.	
23	Both valves, dorsal view. Horizon and locality as fig. 19. OUM J14548. $\times 1$.	
24	Left valve, internal view. Upper Oxford Clay, <i>mariae</i> Zone, Warboys, Cambridgeshire. Peterborough Museum 299/G. $\times 1$.	
26	Right valve. Horizon and locality as fig. 19. BM L8958a. $\times 1$.	
27	Neotype, left valve. Hackness Rock, Scarborough, Yorkshire. SM J12398. $\times 1$.	

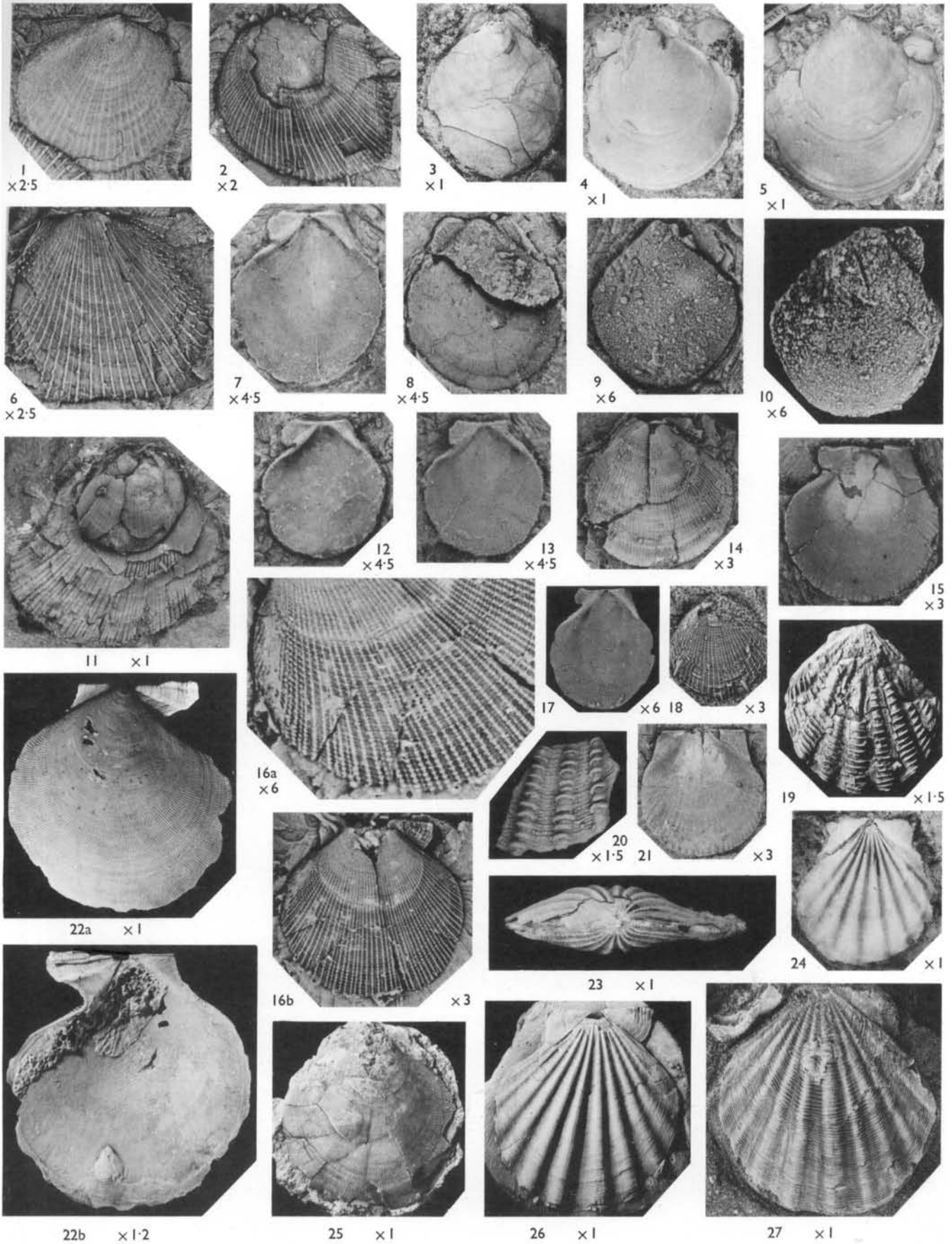
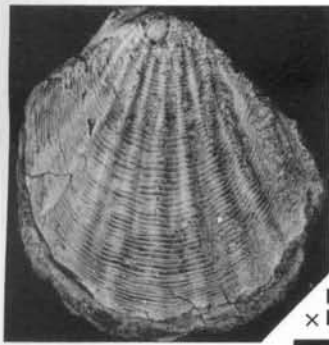

Fig.		Page
	<i>Chlamys (Radulopecten) scarburgensis</i> (Young & Bird, 1822)	70
1	Left valve. Hackness Rock, Scarborough, Yorkshire. SM J12400. × 1.	
5	Right valve. Horizon and locality as fig. 1. SM J12401. × 1.	
6	Right valve. Upper Oxford Clay, Oxfordshire. BM L8958b. × 1.	
	<i>Chlamys (Radulopecten) fibrosa</i> (J. Sowerby, 1816)	72
2	Lectotype, right valve. Cornbrash (?), Chatley, Wiltshire. BM 43305. Figured J. Sowerby 1816, pl. 136, fig. 2, right hand figure. × 1.	
7	Right valve, internal view. Oxford Clay, Chippenham, Wiltshire. GSM 113408. × 1.	
8	Left valve. Kellaways Rock, Scarborough, Yorkshire. SM J12610. × 2.	
9	Left valve. <i>coronatum</i> Zone, Stewartby, Bedfordshire. LU 69963. × 2.	
	<i>Chlamys (Radulopecten) drewtonensis</i> Neale, 1956	74
	Kellaways Rock, South Cave, Humberside	
3	Holotype, right valve, plaster cast. BM L88737. Figured Neale 1956, pl. 28, fig. 3. × 1.	
4	Paratype, left valve. BM L88738. Figured Neale 1956, pl. 28, fig. 1. × 1.	
	<i>Plicatula (Plicatula) cf. fistulosa</i> Morris & Lycett, 1853	75
10	Left valve. Oakley Beds (Oxfordian), Ampthill, Bedfordshire. BM L91702. × 1.	
13a, b	Right and left valves. <i>coronatum</i> Zone, Bletchley, Buckinghamshire. LU 68775. × 1.	
14	Right valve. <i>jason</i> Zone, Norman Cross, Cambridgeshire. LU 68778. × 1.	
15	Right valve. Horizon and locality as fig. 14. BM L87302. × 1.	
	<i>Plicatula (Plicatula) weymouthiana</i> Damon, 1860	75
11a, b	Holotype, right and left valves. Corallian, Weymouth, Dorset. BM L6786. Figured Damon 1860, pl. 9, fig. 7. × 1.	
	<i>Plicatula (Plicatula) fistulosa</i> Morris & Lycett, 1853	76
12	Holotype, left valve. Great Oolite (Bathonian), Minchinhampton, Gloucestershire. GSM 9166. Figured Morris & Lycett 1853, pl. 2, fig. 5. × 1.	
	<i>Gryphaea (Bilobissa) dilobotes</i> nom. nov.	77
16	Left valve. <i>coronatum</i> Zone, Norman Cross, Cambridgeshire. BM LL27755. × 1.	
17a-c	Left valve, posterior, external and internal views. <i>jason</i> Zone, Stewartby, Bedfordshire. BM LL27754. × 1.	
18	Left valve. Horizon and locality as fig. 17. BM LL27751. × 1.	
19	Left valve. <i>calloviense</i> Zone, Norman Cross, Cambridgeshire. LU 69965. × 1.	
20	Left valve, internal view. <i>calloviense</i> Zone, Stewartby, Bedfordshire. BM LL27753. × 1.	



1 x1



2 x1



3 x1

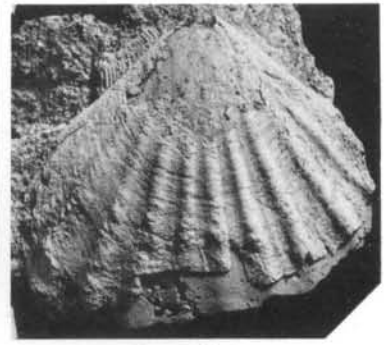

4 x1



5 x1

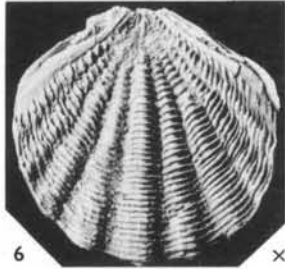

6 x1

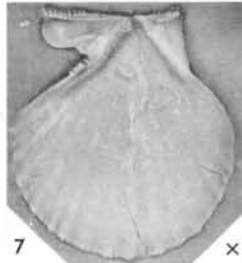

7 x1



8 x2

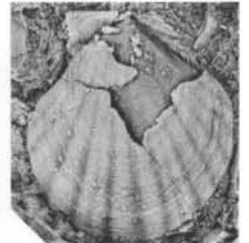

9 x2



10 x1



11a x1



12 x1



13a x1



13b x1



14 x1

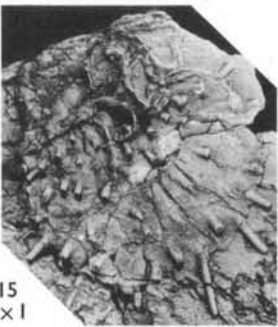

15 x1



11b x1



16 x1



17a x1



17b x1



18 x1



19 x1



20 x1



17c x1

Fig.

Gryphaea (Bilobissa) dilobotes nom. nov.
calloviense Zone, Stewartby, Bedfordshire

- 1a, b Left and right valves. LU 69973. $\times 1$.
2a-d External and internal views of left valve (2a, b) and right valve (2c, d). LU 69964. $\times 1$.
4a, b Left valve, internal and external views. LU 69980. $\times 1$.
5 Left valve. LU 69967. $\times 1$.
6 Left valve. LU 69978. $\times 1$.
7 Left valve. BM LL27729. $\times 1$.
8 Left valve. LU 69981. $\times 1$.

calloviense Zone, Norman Cross, Cambridgeshire

- 3a, b Left and right valves. LU 69969. $\times 1$.

jason Zone, Stewartby, Bedfordshire

- 9 Left valve. LU 69972. $\times 1$.

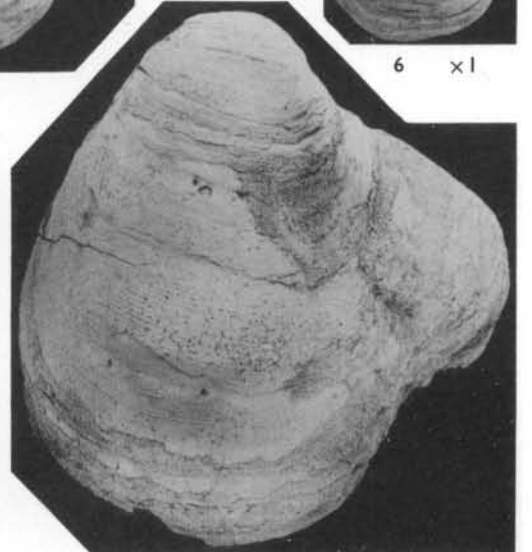
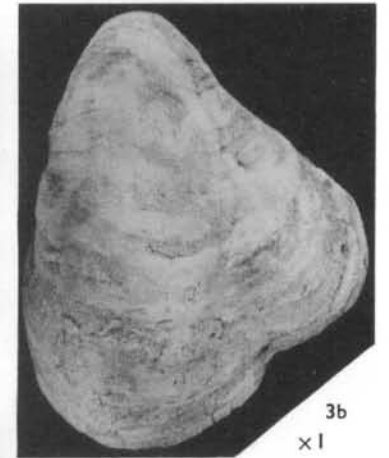
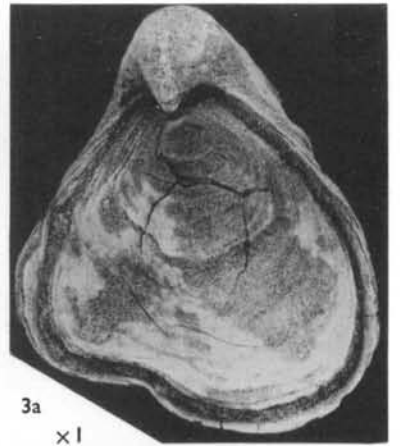
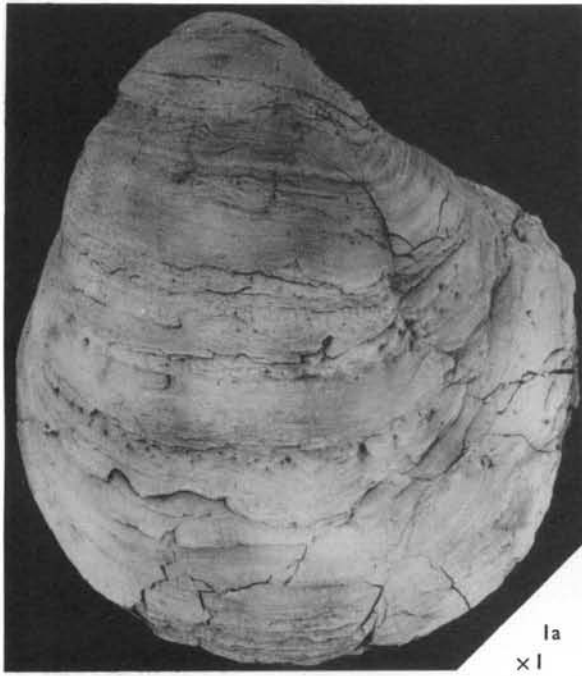
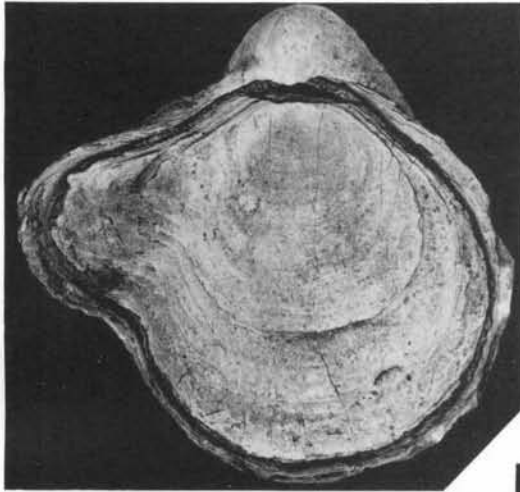

Fig.		Page
	<i>Gryphaea (Bilobissa) dilobotes</i> nom. nov.	77
1a, b	Right and left valves. Kellaways Rock, Drewton, North Cave, Humberside. YM 890. $\times 1$.	
4a, b	Left and right valves, showing xenomorphic attachment areas. <i>jason</i> Zone, Stewartby, Bedfordshire. LU 69985. $\times 1$.	
	<i>Gryphaea (Bilobissa) lituola</i> Lamarck, 1819	82
	Middle Oxford Clay. <i>lamberti</i> Zone, Stewartby, Bedfordshire. All $\times 1$.	
2a-c	External view of left valve and right valve, and posterior view of left valve. LU 68775.	
3	Left valve. LU 68778.	
5	Left valve. LU 68777.	
6	Left valve. LU 69989.	
7a, b	Right valve, internal and external views. LU 68783.	



1a x1



2a x1

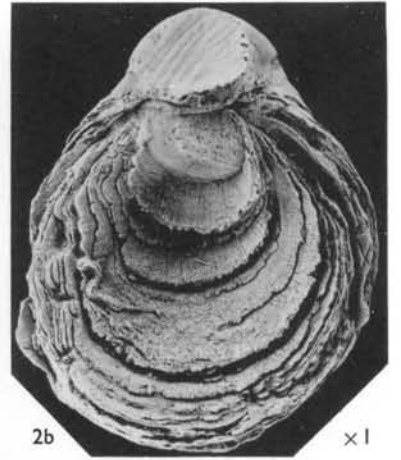

2b x1



1b x1

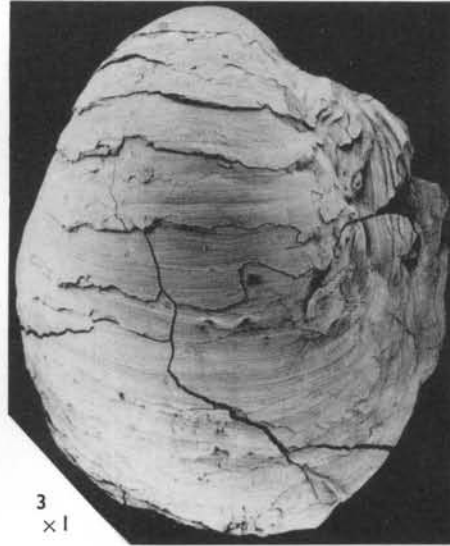

3 x1



2c x1



5 x1



6 x1



4a x1



4b x1

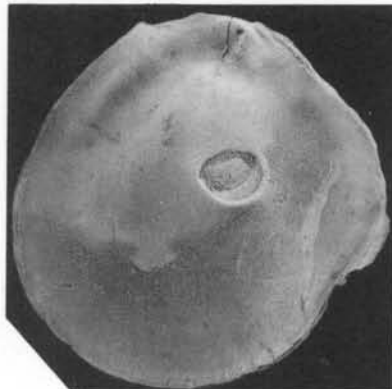

7a x1



7b x1

Fig.		Page
	<i>Gryphaea (Bilobissa) lituola</i> Lamarck, 1819	82
1	Left valve. Middle Oxford Clay, <i>lamberti</i> Zone, Stewartby, Bedfordshire. LU 68782. $\times 1$.	
	<i>Nanogyra nana</i> (J. Sowerby, 1822)	84
	Kimmeridge Clay, Shotover Hill, Oxfordshire	
2a, b	Paralectotype, right valve, external and anterior views. BM 43340b. $\times 1$.	
3	Paralectotype, left valve. BM 43340a. $\times 1$.	
4a, b	Lectotype, left valve, internal and external views. BM 43340c. $\times 1$ (4a), $\times 0.9$ (4b). Figured J. Sowerby 1822, pl. 383, left hand figure.	
	<i>coronatum</i> Zone, Calvert, Buckinghamshire	
5a, b	Right valve, internal and external views. LU 68784. $\times 1$.	
	<i>Discomiltha lirata</i> (Phillips, 1829)	91
	<i>coronatum</i> Zone, Marston Moretaine, Bedfordshire.	
6	Right valve. LU 68786. $\times 1$.	
9	Left valve. LU 68789. $\times 1$.	
10	Right valve, internal view. LU 69990. $\times 1$.	
11	Right valve. LU 68787. $\times 1.5$.	
	Hackness Rock, Scarborough, Yorkshire	
7	Neotype, left valve. BM LL10077. Figured Arkell 1934, pl. 41, fig. 7. $\times 1$.	
8	Right valve. YM 745. $\times 1$.	
12	Right valve, internal mould. YM 877. $\times 1$.	
	<i>Myophorella (Myophorella) irregularis</i> (Seebach, 1864)	85
13a, b	Left valve, external and internal views. Oxford Clay, Weymouth, Dorset. YM 908. $\times 1$.	
14	Left valve. <i>jason</i> Zone, Stewartby, Bedfordshire. LU 68785. $\times 1$.	
15a, b	Both valves, right and dorsal views. Horizon and locality as fig. 13. GSM 43053. $\times 1$.	
16	Right valve. Kellaways Rock, Putton Lane, Chickerell, Dorset. SM J47645. $\times 1$.	
17a, b	Right valve, internal and external views. Horizon and locality as fig. 14. LU 54481. $\times 1$.	

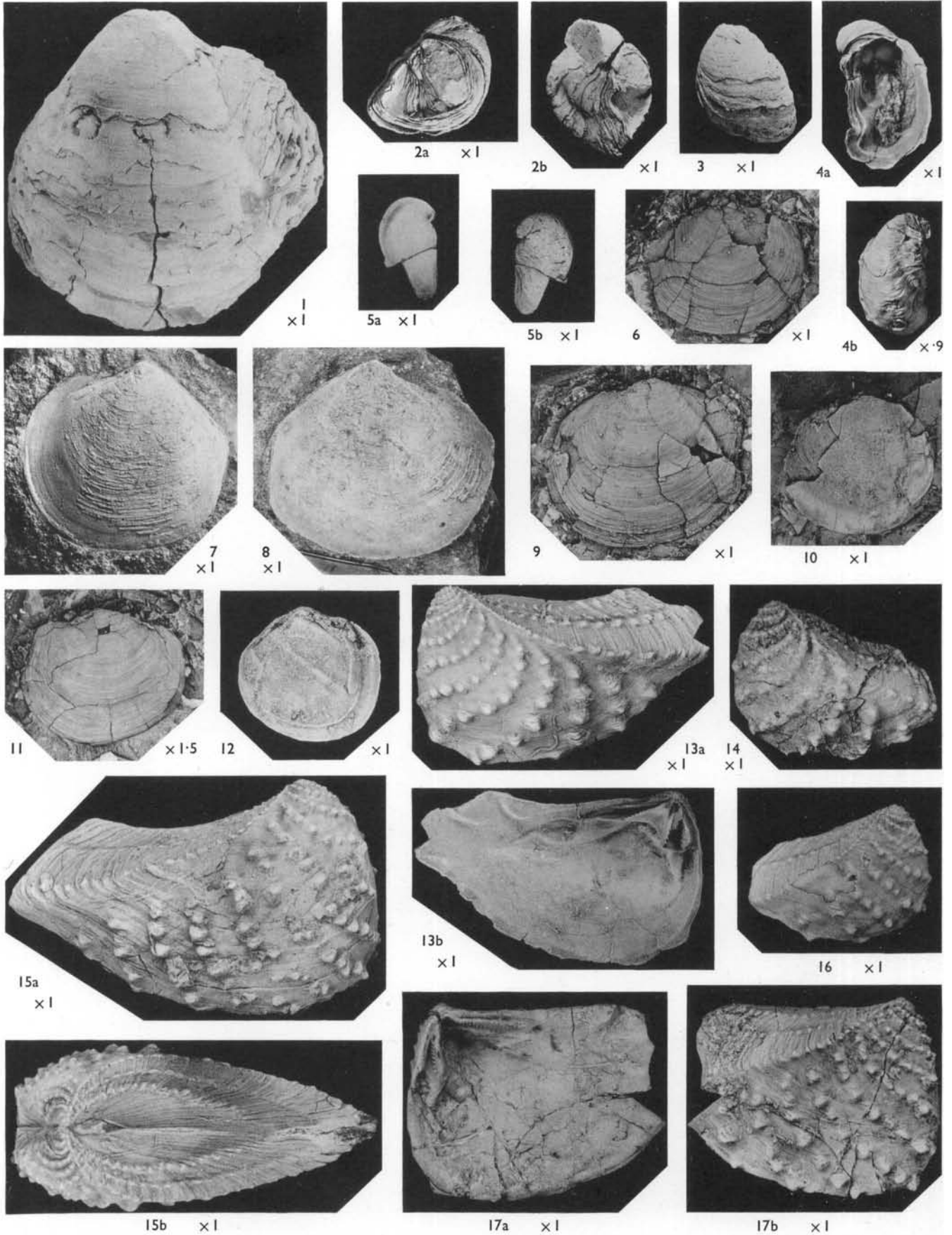
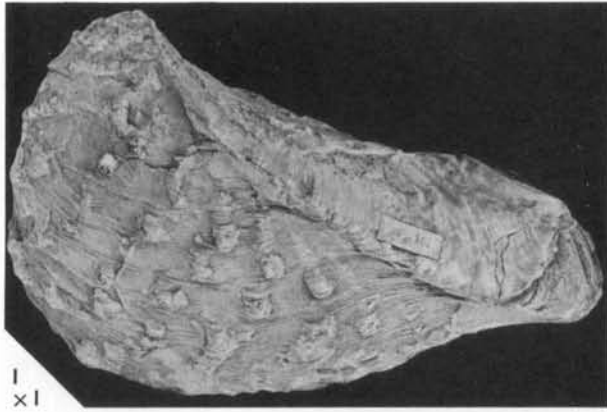
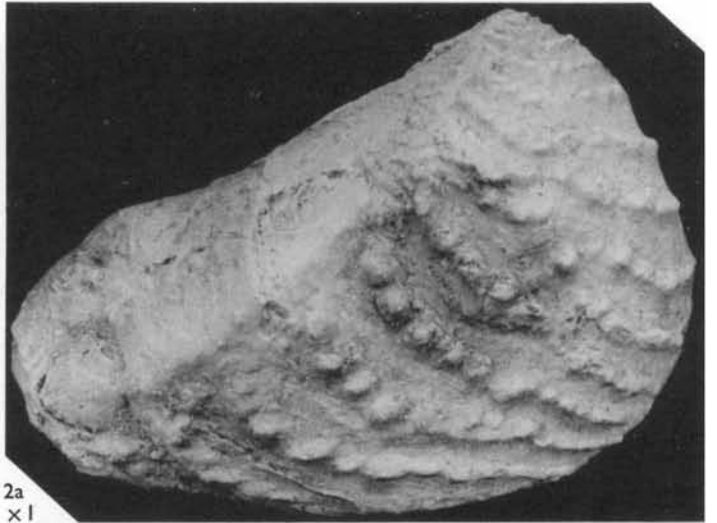

Fig.		Page
	<i>Myophorella (Myophorella) irregularis</i> (Seebach, 1864) Oxford Clay, Weymouth, Dorset. All $\times 1$.	85
1	Left valve. YM 907.	
3a, b	Both valves, right and dorsal views. YM 904.	
4	Left valve. YM 905.	
6	Left valve, oblique internal view. YM 908.	
	<i>Myophorella (Myophorella) caytonensis</i> sp. nov.	89
2a, b	Paratype, right and left valves. Cornbrash, Scarborough, Yorkshire. GSM 112893. $\times 1$.	
10	Holotype, dorsal view. Kellaways Rock, Scarborough, Yorkshire. SM J11377. Figured Lycett 1872, pl. 8, fig. 4. $\times 1$.	
	<i>Neocrassina (Pressastarte) ungulata</i> (Lycett, 1863)	93
5	Right valve, composite internal mould. Upper Oxford Clay, <i>mariae</i> Zone, Scarborough, Yorkshire. YM 873. $\times 1.5$.	
7	Right valve, internal view. Oxford Clay, Trowbridge, Wiltshire. BCM Cb8876. $\times 2$.	
8a, b	Left and right valves. Horizon and locality as fig. 7. BCM Cb8877. $\times 2$.	
9a, b	Both valves, posterodorsal and left views. Oxford Clay, Fairford, Wiltshire. BU 14708. $\times 1.5$.	
11.	Both valves, external view, composite internal mould. Horizon and locality as fig. 5. SM J26766. $\times 1.5$.	



1
x 1



2a
x 1

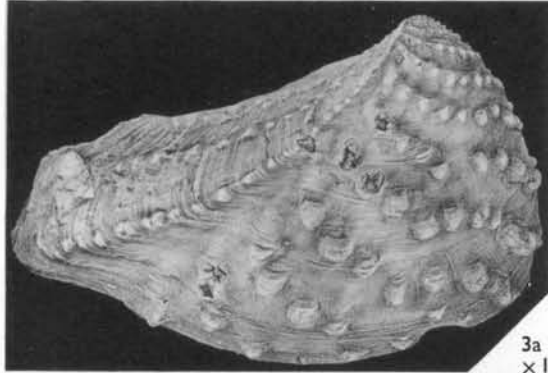

3a
x 1

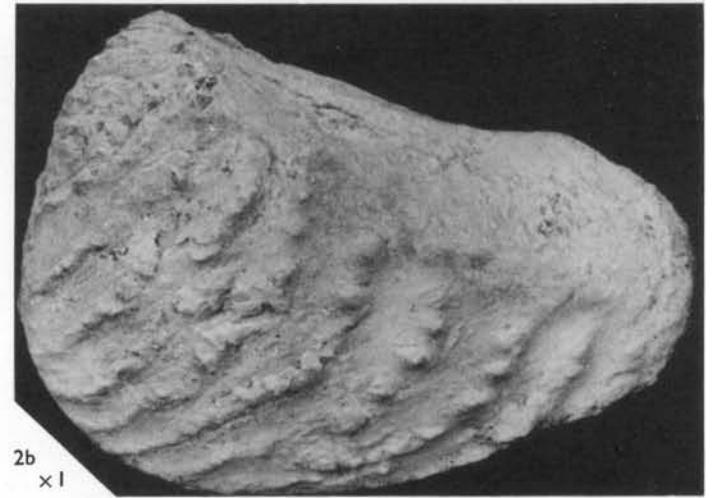

2b
x 1

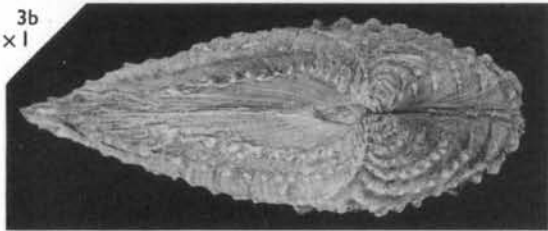

3b
x 1

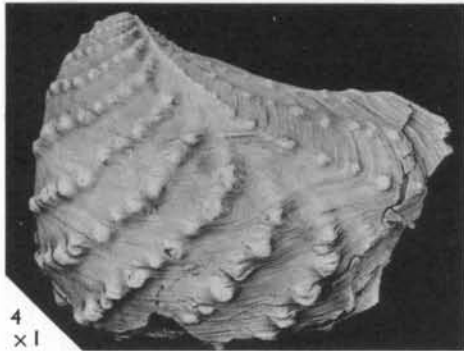

4
x 1

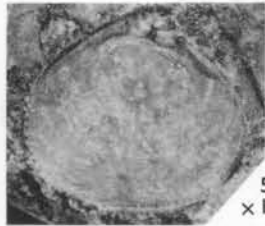

5
x 1.5



6 x 1



7 x 2



11 x 1.5

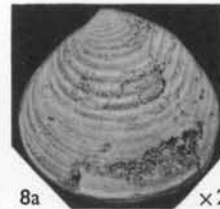

8a x 2



9a x 1.5

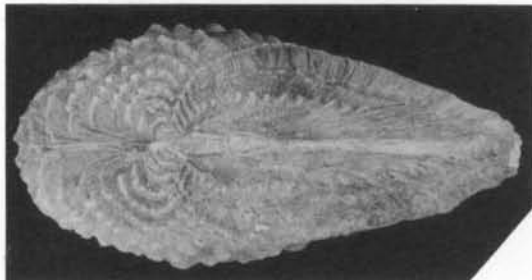

10 x 1



8b x 2



9b x 1.5

Fig.		Page
	<i>Myophorella (Myophorella) caytonensis</i> sp. nov. Kellaways Rock, Scarborough, Yorkshire	89
1	Paratype, left valve. GSM 11436. Figured Lycett 1877, pl. 36, fig. 1. $\times 1$.	
8a, b	Holotype, right and left valves. SM J11377. Figured Lycett 1872, pl. 8, fig. 4. $\times 1$.	
	<i>Neocrassina (Pressastarte) unguata</i> (Lycett, 1863) Oxford Clay, Trowbridge, Wiltshire	93
2	Left valve, oblique internal view. BCM Cb8878. $\times 2$.	
3a, b	Both valves, left and dorsal views. BCM Cb8879. $\times 2$.	
	<i>Neocrassina (Pressastarte) calvertensis</i> sp. nov. jason Zone, Calvert, Buckinghamshire	95
4a, b	Holotype, right valve, external and internal views. BM LL27730. $\times 2.5$.	
6a, b	Paratype, left valve, internal and external views. LU 69993. $\times 1.5$.	
9	Paratype, right valve. BM LL27733. $\times 1.5$.	
10	Paratype, right valve, internal view. LU 69995. $\times 1.5$.	
11a, b	Paratype, right and left valves. BM LL27732. $\times 1.5$.	
	jason Zone, Stewartby, Bedfordshire	
5	Paratype, left valve. LU 68790. $\times 1.5$.	
7a, b	Paratype, left valve, external and internal views. LU 69994. $\times 1.5$.	
	<i>Nicaniella (Trautscholdia) carinata</i> (Phillips, 1829) Upper Oxford Clay, <i>mariae</i> Zone, Scarborough, Yorkshire	97
12	Right valve. SM J26745. $\times 1.5$.	
13	Holotype, right valve. YM 876. Figured Phillips 1829, pl. 5, fig. 3. $\times 1.5$.	
14	Right valve. SM J26747. $\times 1.5$.	
15	Right valve. YM 887. $\times 1.5$.	
16	Left valve. YM 895. $\times 1.5$.	
17	Right valve. SM J26746. $\times 1.5$.	
23	Left valve. YM 886. $\times 1$.	
24	Left valve. YM 888. $\times 1.5$.	
	<i>Nicaniella (Trautscholdia) phillis</i> (d'Orbigny, 1850) <i>coronatum</i> Zone, Marston Moretaine, Bedfordshire	98
18a, b	Right valve, internal and external views. LU 69814. $\times 2.5$.	
	jason Zone, Calvert, Buckinghamshire. All $\times 2.5$	
19a, b	Left valve, internal and external views. LU 69800.	
20	Right valve. LU 69805.	
21	Left valve. LU 68795.	
22	Right valve. LU 69999.	
25	Left valve. LU 68798.	
26	Dorsal view. LU 69998.	
27	Right valve, internal view showing transposed dentition. LU 69943.	
28	Right valve. LU 69996.	

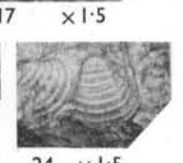
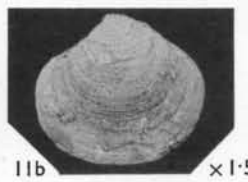
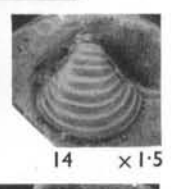
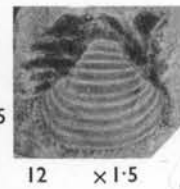
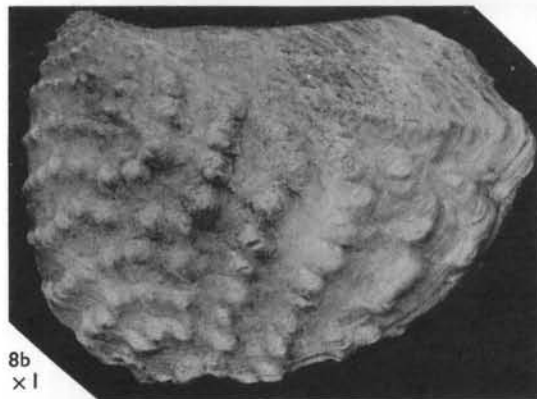
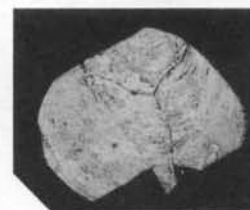
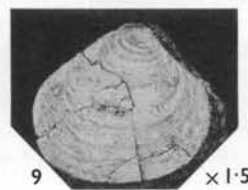
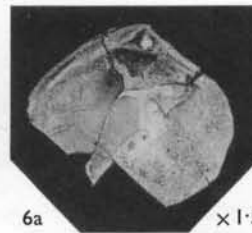
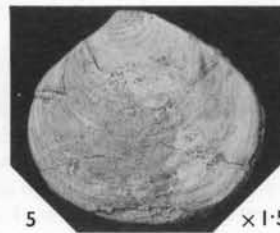
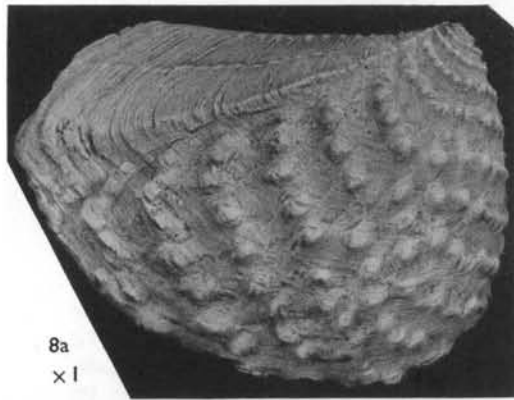
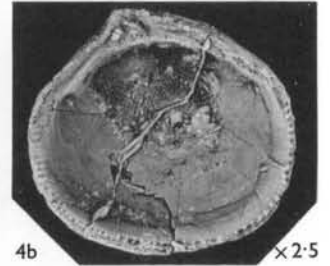
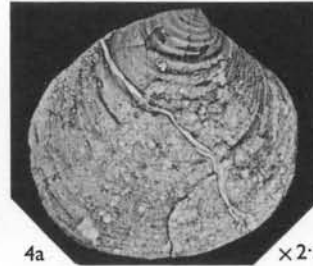
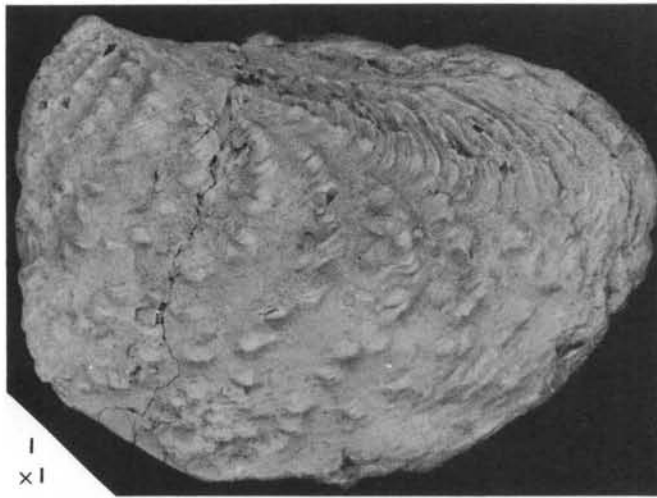

Fig.		Page
	<i>Nicaniella (Trautscholdia) phillis</i> (d'Orbigny, 1850) <i>jason</i> Zone, Stewartby, Bedfordshire. × 2·5	98
1	Right valve. LU 69998.	
4	Right valve. LU 70000.	
	<i>jason</i> Zone, Calvert, Buckinghamshire. × 2·5	
2	Right valve. LU 68799.	
3	Dorsal view. LU 69801.	
	<i>Protocardia (Protocardia) sp.</i> <i>coronatum</i> Zone, Marston Moretaine, Bedfordshire	103
5	Right valve. LU 70005. × 1.	
6	Left valve. LU 70006. × 1.	
	<i>Protocardia (Protocardia) striatula</i> (J. de C. Sowerby, 1829) Kellaways Rock, Brora Roof Bed, Brora, Sutherland	102
7	Right valve, internal mould. LU 69833. × 1.	
8a, b	Holotype, both valves, right and dorsal views. BM 43154. Figured J. de C. Sowerby 1829, pl. 553, fig. 1. × 1.	
13	Left valve. LU 69832. × 1·5.	
	<i>jason</i> Zone, Kidlington, Oxfordshire	
9	Right valve. OUM J9719. × 1.	
	Lower Oxford Clay, Wiltshire	
10	Left valve. OUM J28240. × 1.	
	Kellaways Rock, Scarborough, Yorkshire	
11a-c	Both valves, left, right and dorsal views. SM J6010. Holotype of <i>Cardium crawfordii</i> Leckenby 1859, pl. 3, figs. 9a, b. × 1.	
	<i>Rollierella minima</i> (J. Sowerby, 1821)	105
12	Right valve, internal view, "Silcoset" cast. Oxford Clay, Lukow, Poland. Author's collection. × 2.	
14a, b	Both valves, right and anterior views. Kellaways Rock, Chippenham, Wiltshire. GSM 42917. × 1.	
15	Holotype, left valve. Cornbrash (?), Wiltshire. BM 43164. Figured J. Sowerby 1821, pl. 295, fig. 1. × 1.	
16	Right valve. Kellaways Rock, <i>callowiense</i> Zone, Stewartby, Bedfordshire. LU 70002. × 1.	
17	Right valve, internal view, "Silcoset" cast. Horizon and locality as fig. 12. Author's collection. × 2.	
19a, b	Both valves, left and anterior views. Horizon and locality as fig. 14. GSM 42916. × 1.	
23	Left valve. Kellaways Rock, Kellaways, Wiltshire. BCM Cb4770. × 1.	
28	Right valve. Horizon and locality as fig. 16. LU 70001. × 1.	
	<i>Anisocardia (Anisocardia) tenera</i> (J. Sowerby, 1821)	108
18a, b	Holotype, both valves, right and anterior views. Kellaways Rock, Wiltshire. BM 43165. Figured J. Sowerby 1821, pl. 295, fig. 2. × 1.	
20a, b	Both valves, anterior and right views. Kellaways Rock, Chippenham, Wiltshire. GSM 114040. × 1.	
21a, b	Both valves, anterior and left views. Kellaways Rock, Loudon, Wiltshire. GSM Y2072. × 1.	
22	Right valve. Horizon and locality as fig. 20. GSM 114041. × 1.	
	<i>Isocyprina (Isocyprina) roederi</i> Arkell, 1934 <i>coronatum</i> Zone, Stewartby, Bedfordshire	110
25	Right valve. LU 69837. × 1·5.	
26	Right valve. LU 69839. × 1·5.	
27	Left valve, internal view. LU 70008. × 1·5.	
29	Left valve, internal view. LU 70003. × 1·5.	
31	Right valve, internal mould. LU 69834. × 1.	

(Continued on previous page)

Explanation of PLATE 12 (continued from next page)

Corbulomima macneillii (Morris, 1850)

112

- 24 Right valve. Kellaways Rock, Chippenham, Wiltshire. BCM Cb8881. × 4.
30 Left valve. Kellaways Rock, Trowbridge, Wiltshire. GSM 113985. × 6.
32 Left valve. Horizon and locality as fig. 24. BCM Cb8882. × 4.
33a, b Both valves, dorsal and left views. Lower Oxford Clay, Dauntsey, Wiltshire. LU 70017. × 6.
34a-c Both valves, right, left and dorsal views. Horizon and locality as fig. 24. BCM Cb8883. × 6.
35 Right valve. Horizon and locality as fig. 33. LU 70018. × 6.
36 Right valve. *jason* Zone, Stewartby, Bedfordshire. LU 69859. × 4.
37 Right valve. *jason* Zone, Wiltshire. OUM J28230. × 6.
38a, b Neotype, both valves, dorsal and left views. Horizon and locality as fig. 30. GSM 113999. × 6.
39 Right valve. Horizon and locality as fig. 36. LU 69855. × 4.
40 Left valve. Horizon and locality as fig. 24. BCM Cb8884. × 6.

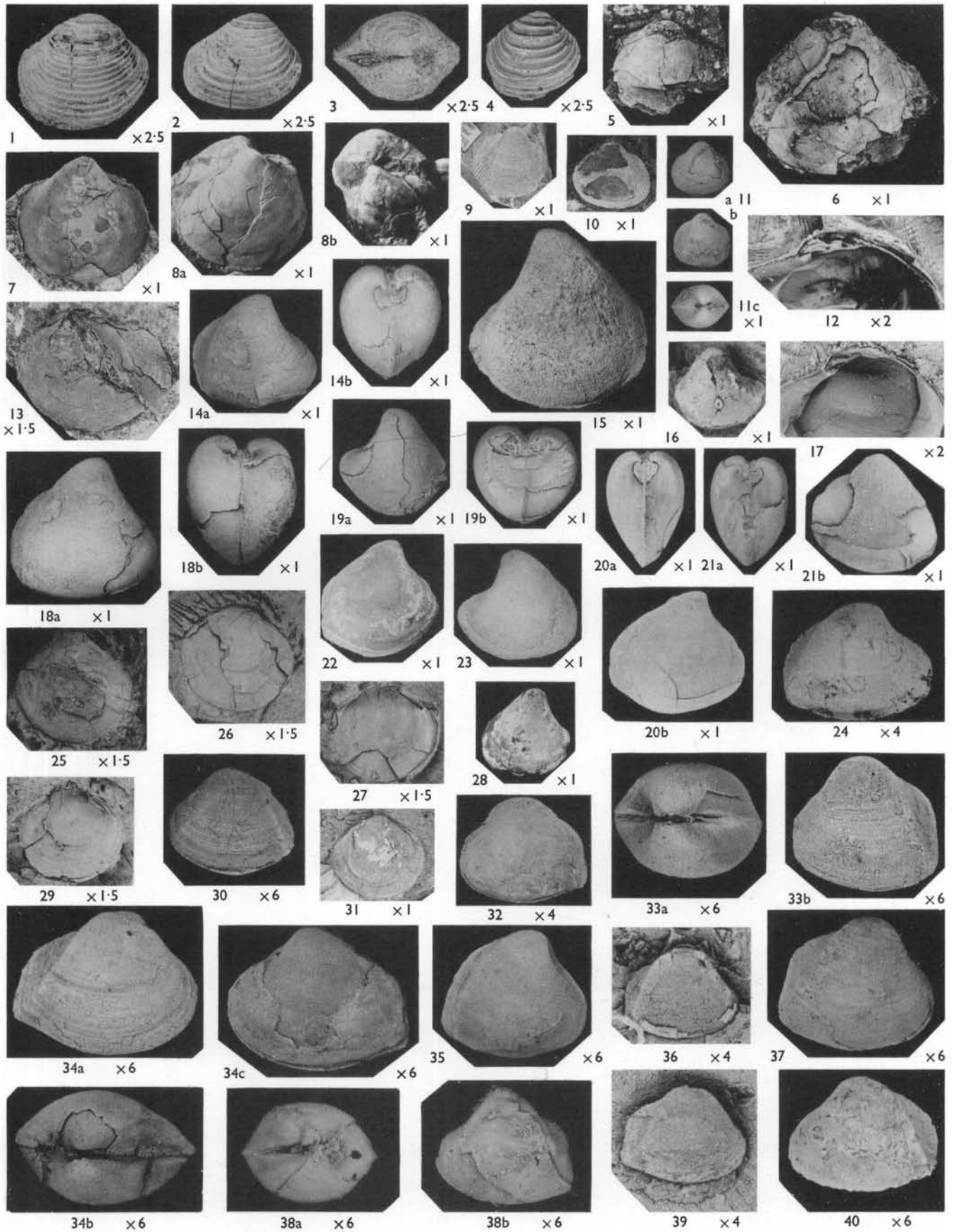

- Fig. Page
- Corbulomima obscura* (J. de C. Sowerby, 1827)
- Kellaways Rock, Brora Roof Bed, Brora, Sutherland. All $\times 5$
- 1 Left valve. LU 69868.
- 2a c Both valves, left, right and dorsal views. LU 69870.
- 3 Left valve. LU 69871.
- 4 Left valve. LU 69872.
- Pleuromya alduini* (Brongniart, 1821)
- Kellaways Rock, Kington Langley, Wiltshire
- 5 Right valve. GSM Ka608. $\times 1$. 115
- coronatum* Zone, Norman Cross, Cambridgeshire. All $\times 1$
- 6 Left valve. LU 69875.
- 7 Left valve. LU 69884.
- 8 Right valve. LU 69882.
- 9 Right valve. LU 69883.
- 15 Left valve. LU 69880.
- jason* Zone, Wiltshire
- 10 Right valve. OUM J28242. $\times 1$.
- calloviense* Zone, Stewartby, Bedfordshire
- 12 Left valve. LU 70014. $\times 1$.
- Pleuromya uniformis* (J. Sowerby, 1813)
- 11 Holotype, left valve. Cornbrash, Felmersham, Bedfordshire. BM 43224. Figured J. Sowerby 116
1813, pl. 33, fig. 4. $\times 1$.
- 14a, b Both valves, dorsal and left views. Kellaways Rock, *calloviense* Zone, Stewartby, Bedfordshire.
LU 70010. $\times 1$.
- 18 Right valve. Belemnite Sands, Staffin Bay, Skye. LU 70011. $\times 1$.
- 21 Right valve. Horizon and locality as fig. 18. LU 70034. $\times 1$.
- Thracia (Thracia) depressa* (J. de C. Sowerby, 1823)
- 13 Left valve. *coronatum* Zone, Calvert, Buckinghamshire. LU 69888. $\times 1$. 118
- 19 Left valve. Upper Oxford Clay, Red Nodule Beds (*cordatum* Zone), Weymouth, Dorset. GSM
Geol. Soc. Coll. GSa3649. $\times 1$.
- 20 Neotype, left valve. Horizon and locality as fig. 19. BM L6979. Figured Damon 1888, pl. 19,
fig. 14. $\times 1$.
- 22 Left valve. Horizon and locality as fig. 19. GSM Geol. Soc. Coll. GSa3648. $\times 1$.
- 23 Left valve. *calloviense* Zone, Stewartby, Bedfordshire. LU 69889. $\times 1$.
- 28 Left valve. Upper Oxford Clay, *mariae* Zone, Scarborough, Yorkshire. YM 891. $\times 1$.
- Anomalodesmatan sp. A.
- 16 Left valve (?). *coronatum* Zone, Stewartby, Bedfordshire. LU 70026. $\times 2$. 120
- 17 Left valve (?). *coronatum* Zone, Crook Hill, Chickerell, Dorset. BM LL27735. $\times 2$.
- 27 Both valves. Horizon and locality as fig. 16. LU 70024. $\times 2$.
- Anomalodesmatan sp. B.
- 24 Both valves. *jason* Zone, Stewartby, Bedfordshire. LU 70028. $\times 2$. 121
- 25 Both valves. Horizon and locality as fig. 24. LU 70029. $\times 2$.
- 26 Both valves. *coronatum* Zone, Stewartby, Bedfordshire. LU 70027. $\times 2$.

