

**PAGES MISSING  
WITHIN THE  
BOOK ONLY**

**TEXT FLY WITHIN  
THE BOOK ONLY**

UNIVERSAL  
LIBRARY

**OU\_158958**

UNIVERSAL  
LIBRARY





**OSMANIA UNIVERSITY LIBRARY**

Call No. 537.83/B62A Accession No. 29872

Author Bell, L.

Title Art of Illumination

This book should be returned on or before the date last marked



THE ART  
OF  
ILLUMINATION

BY  
LOUIS BELL, PH. D.



WESTMINSTER  
ARCHIBALD CONSTABLE AND CO., LTD  
2 WHITEHALL GARDENS  
1903

**COPYRIGHTED, 1902,  
BY THE  
MCGRAW PUBLISHING COMPANY,  
NEW YORK.**



## PREFACE.

---

THIS volume is a study of the utilization of artificial light. It is intended to deal, not with the problem of distributing illuminants, but with their application, and treats of the illuminants themselves only in so far as a knowledge of their peculiarities is necessary to their intelligent use. To compress the subject within reasonable bounds, it has been necessary to discuss general principles rather than concrete examples of artificial lighting. The science of producing light changes rapidly and the apparatus of yesterday may be discarded to-morrow, but the art of employing the materials at hand to produce the required results follows lines which are to a very considerable extent subject to fairly well-defined laws. Sins against these laws are all too common, the more so since artificial light has become relatively cheap and easy of application. If this outline of a complex art shall tend to avert even some of the commoner errors and failures in illumination, it will have served its purpose. The author here desires to express his obligations to the beautiful treatise of M. Allemagne for illustrations of early fixtures and to numerous friends, notably Mr. Luther Stieringer, for valuable material and suggestions.

*November, 1902.*



# CONTENTS.

---

CHAPTER	PAGE
I. LIGHT AND THE EYE, . . . . .	1
II. PRINCIPLES OF COLOR, . . . . .	23
III. REFLECTION AND DIFFUSION, . . . . .	38
IV. THE MATERIALS OF ILLUMINATION—ILLUMINANTS OF COMBUSTION, . . . . .	56
V. THE MATERIALS OF ILLUMINATION—INCANDESCENT BURN- ERS, . . . . .	83
VI. THE ELECTRIC INCANDESCENT LAMP, . . . . .	95
VII. THE ELECTRIC ARC LAMP, . . . . .	140
VIII. SHADES AND REFLECTORS, . . . . .	163
IX. DOMESTIC ILLUMINATION, . . . . .	183
X. LIGHTING LARGE INTERIORS, . . . . .	211
XI. STREET AND EXTERIOR ILLUMINATION, . . . . .	244
XII. DECORATIVE AND SCENIC ILLUMINATION, . . . . .	275
XIII. THE ILLUMINATION OF THE FUTURE, . . . . .	301
XIV. STANDARDS OF LIGHT AND PHOTOMETRY, . . . . .	313



# THE ART OF ILLUMINATION.

---

## CHAPTER I.

### LIGHT AND THE EYE.

WHILE even the Esquimaux and the Patagonian use artificial light and all civilized peoples count it a necessity, it is seldom used skillfully and with proper knowledge of the principles that should govern its employment. Since the introduction of electric lights that very facility of application which gives them unique value has encouraged more zeal than discretion in their use. It is the purpose of the present volume to set forth some of the fundamental doctrines, optical, physiological, and æsthetic, which underlie the proper use of artificial illuminants, and to point out how they may be advantageously adapted to existing conditions.

To begin with, there are two general purposes which characterize two quite distinct branches of the art of illumination. First comes the broad question of supplying artificial light for carrying on such avocations or amusements as are extended into the hours of darkness. Quite apart from this is the case of scenic illumination directed at special objects and designed to produce particular effects or illusions. Lighting a shop or a house exemplifies the one, lighting a picture gallery or the stage of a theater the other. Each has a distinct purpose, and re-

quires special means for its accomplishment. Confusing the purposes or mixing the methods often leads to serious mistakes. Sometimes both general and scenic illumination have to be used coincidentally, but the distinction between them should be fully realized even when it cannot fully be preserved.

General illumination, whether intended to serve the ends of work or play, must fulfill the following conditions: it must be amply adequate in amount, suitable in kind, and must be so applied as not to react injuriously upon the eye.

It must be remembered that the human eye is not merely a rather indifferent optical instrument, but a physical

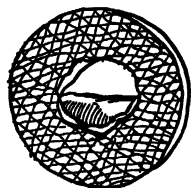

Fig 1—Indian Goggles.

organ which has through unfathomable ages accumulated the characters wrought upon it by evolution, until it bears the impress and incurs the limitations of its environment. It works best over a rather limited retinal area and through a range in intensity of

light which, although great, is yet immensely smaller than the range available to nocturnal creatures. It has, moreover, become habituated to, and adapted to, light coming obliquely from above, and resents strong illumination, whether natural or artificial, from any other direction. It seems to be well established, for example, that the distress caused by the reflected glare from sand, or water, or snow, and the grave results which follow prolonged exposure to it, are due not so much to the intensity of the light as to the fact that it is directed upward into the eye and is quite insufficiently stopped by the rather transparent lower eyelid. Ordinary dark glasses are small protection in this case, but if the lower

part of the eye be thoroughly guarded no difficulty is found. The Alaskan Indians have evolved a very effective protection against snow blindness in the shape of leather goggles with the eye arranged as shown in Fig. 1. The eyepiece is merely a round bit of dark leather with a semicircular cut made for the peep hole, the resulting flap being turned outward and downward, so that the eye is fully guarded from brilliant upward beams. Blackening the whole lower eyelid with burnt cork is stated by one distinguished oculist to be completely efficacious for the same reason.

It is more than likely that the bad effects ascribed to the habit of reading while lying down are due largely to the unwonted direction of the illumination, as well as to the unusual direction of the eye's axis.

All these matters are of fundamental importance in planning any illumination to facilitate hard visual work. Their significance is that we are not at liberty to depart widely from the distribution and character of natural daylight illumination. Of course, one realizes immediately that the eye is neither fitted nor habituated to working to advantage in anything like the full strength of sunlight, but its more general properties—steadiness, absence of pronounced color, downward oblique direction, wide and strong diffusion, freedom from sharp and black shadows—these must be followed rather closely in ordinary artificial illumination, or the eye, that has been taking form through a million years of sunlight and skylight, will resent the change. The eye is automatically adjustable, it is true, for wonderfully diverse conditions, but persistent and grave changes in environment are more than it can bear.

Now from a practical standpoint the key to artificial

illumination is found in the thoughtful contemplation of what is known as Fechner's law, relating to the sensitiveness of the eye to visual impressions. It is stated by Helmholtz substantially as follows: "Within very wide limits of brightness, differences in the strength of light are equally distinct or appear equal in sensation, if they form an equal fraction of the total quantity of light compared." That is, provided the parts of the visual picture remain of the same *relative* brightness the distinctness of detail does not vary materially with great changes of absolute brightness. Now since, barring binocular vision, our whole perception of visible things depends, in the absence of strong color contrasts, upon differences of illumination, the importance of the law just stated needs little comment. It implies what experience proves, that within a rather wide range of absolute brightness of illumination our vision is about equally effective for all ordinary purposes.

Fechner's law, to be sure, fails when extremely brilliant lights are concerned. Few persons realize, for instance, that the sun is twice as bright at noon as it is when still 10 to 15 degrees above the horizon, still less that its brilliancy is reduced more than a hundred fold as its lower limb touches the horizon. Yet while the eye does not detect very small changes or properly evaluate large ones in a body so bright as the sun, the mere fact that one can see to work or read about equally well from sunrise to sunset is most convincing as to the general truth of the law. Full sunlight at noon is generally over-bright for the eye if it falls directly upon the work, but with half of it one can get along very comfortably.

All this is most important from the standpoint of artificial illumination, since it means that within rather wide



limits of intensity artificial lighting remains about equally effective for most practical purposes.

The actual amount of illumination necessary and desirable, the terms by which we measure it, and the laws that govern its intensity are matters of primary importance which must now occupy our attention.

A simple and definite standard of light is greatly to be desired, but we do not yet possess it. The practical and generally legal standard in English-speaking countries is the standard candle. This is defined to be a spermaceti candle of certain definite dimensions, weighing one-sixth of a pound avoirdupois, and burning 120 grains per hour. Such a candle is a fairly steady and uniform source of light, and although far less precise than would be desirable, has served a most useful purpose as a standard of light. From this a standard of illumination is derived by defining the distance at which this standard intensity produces a certain definite illumination, which forms an arbitrary unit. Thus one *candle-foot* has come to be a definite unit of illumination, *i. e.*, the direct illumination given by a standard candle one foot from the object illuminated. Of course, it is entirely empirical, but it serves the practical purpose of comparing and defining amounts of illumination just as well as if it were a member of the C. G. S. system in good and regular standing.

A unit of illumination frequently used abroad is the *bougie-meter*, similarly derived, with the meter as unit distance. This is sometimes known as the *lux*, but unhappily there is neither any convenient and practicable absolute standard of light nor any definitely settled nomenclature of the subject, so that to save confusion the writer prefers to adhere for the present to *candle-foot*, which is at least specific, and bears a determinable relation to the

bougie-meter. (Approximately the candle-foot equals eleven bougie-meters.)

For any light the illumination at one foot distance is obviously a number of candle feet numerically equal to the candle power of the light.

At distances other than one foot the illuminating power is determined by the well defined, but often misapplied, "law of inverse squares." This law states that the intensity of light from a given source varies inversely as the square of the distance from that source. Thus if we have a radiant point ( $P$ , Fig. 2) it will shine with a certain intensity on a surface  $a b c d$  at a distance  $e P$ . If we go to double the distance ( $E P$ ) the same light which fell on  $a b c d$  now falls on the area  $A B C D$  of twice the linear dimensions and four times the area, and consequently the intensity is reduced to one-fourth of the original amount. Thus if  $P$  be one candle and  $e P$  one foot, then the illumination at  $e$  will be one candle-foot, and at  $E$  one-fourth candle-foot.

This law of inverse squares is broadly true of every case of the free distribution of energy from a point within a homogeneous medium, for reasons obvious from the inspection of Fig. 2. It does not hold in considering a radiant surface as a whole, nor for any case in which the medium is not homogeneous within the radii considered.

By reason of these limitations, in problems of practical illumination the law of inverse squares can be considered only as a useful guide, for it is far from infallible, and may lead to grossly inaccurate results. It is exact only in the rare case of radiation from a minute point into space in which there is no refraction or reflection. A room with dead black walls, lighted by a single candle, would furnish an instance in which the illumination could be

computed by the law of inverse squares without an error of more than say 2 or 3 per cent., while a white and gold room lighted by a well shaded arc light would illustrate an opposite condition, in which the law of inverse squares alone would give a result grossly in error.

Fig. 3 shows how completely deceptive the law of inverse squares may become in cases complicated by refraction or reflection. Here one deals with an arc light of perhaps 10,000 nominal cp. as the source of radiation,

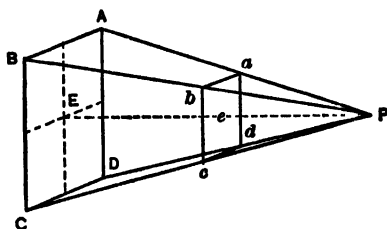

Fig. 2.—Illustrating Law of Inverse Squares.

but a very large proportion of the total luminous energy is concentrated by the reflector or lens system into a nearly parallel beam which maintains an extremely high luminous intensity at great distances from the apparatus. If the beam were actually of parallel rays its resultant illumination would be uniform at all distances, save as diminished by the absorption of the atmosphere, probably not over 10 per cent. in a mile in ordinary clear weather, since the absorption of the entire thickness of the atmosphere for the sun's light is only about 16 per cent.

The searchlight furnishes really a special case of scenic illumination, which frequently depends upon the use of concentrated beams in one form or another, so that one must realize that a very considerable branch of the art of illumination imposes conditions not reconcilable with the ordinary application of the law of inverse squares.

It is worth while thus to examine the law in question, because it is a specially flagrant example of a principle absolutely and mathematically correct within certain rigid limitations, but partially or wholly inapplicable in many important cases.

Having considered the unit strength of light and the

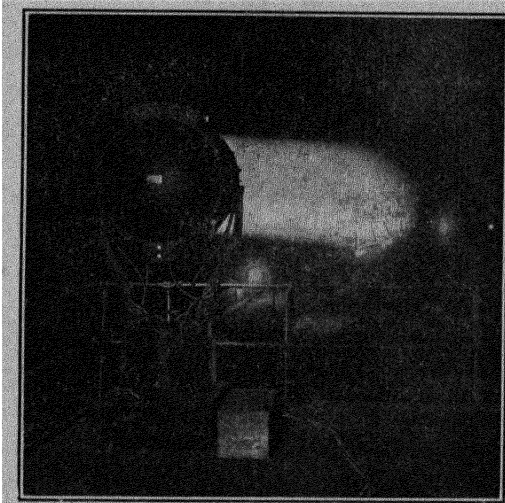

Fig. 3.—Beam From Searchlight.

unit strength of illumination, the other fundamental of artificial lighting is the intensity of the luminous source—generally known as intrinsic brightness. Optically this has no very great or direct importance, but physiologically it is of the most serious significance, and perhaps deserves more thoughtful attention than any other factor in practical illumination. It is of the more consequence, as it is the one thing which generally receives scant consideration, and is left to chance or convenience.

By intrinsic brightness is meant the strength of light per unit area of light-giving surface. If we adopt the

standard candle as the unit of light, and adhere to English measures, the logical unit of intrinsic brightness is one candle power per square inch. One then may conveniently express the brightness of any luminous surface in candle power per square inch, and thus obtain a definite basis of comparison.

Although a measure of intrinsic brightness is obtained by dividing the candle-power of any light by the area of the luminous surface, this latter quantity is very difficult to determine accurately, since with the exception of the electric incandescent filament no source of light is anywhere nearly of uniform brilliancy over its entire surface. For the sake of comparison we can, however, draw up an approximate table by assuming equal brightness over the generally effective lighting area of any radiant. It should be distinctly understood that the values tabulated are only average values of quantities, some of which are incapable of exact determination and others of which vary over a wide range according to conditions.

INTRINSIC BRILLIANCIES IN CANDLE POWER PER SQUARE INCH

SOURCE	BRILLIANCY.	NOTES.
Sun in zenith . . . . .	600,000	} Rough equivalent values, taking account of absorption.
Sun at 30 degrees elev . .	500,000	
Sun on horizon . . . . .	2,000	
Arc light . . . . .	10,000 to 100,000	Maximum about 200,000 in crater.
Calcium light . . . . .	5,000	} Unshaded.
Nernst "glower" . . . . .	1,000	
Incandescent lamp . . . .	200-300	Depending on efficiency.
Melting platinum . . . .	130	1 sq cm = 18 5 c p
Enclosed arc . . . . .	75-100	Opalescent inner globe.
Acetylene flame . . . . .	75-100	
Welsbach light . . . . .	20 to 25	
Kerosene light . . . . .	4 to 8	Very variable.
Candle . . . . .	3 to 4	} Very variable
Gas flame . . . . .	3 to 8	
Incandescent (frosted). .	2 to 5	
Opal shaded lamps, etc..	0.5 to 2	

The striking thing about this table is the enormous discrepancy between electric and other lamps of incandes-

cence and flames of the ordinary character. The very great intrinsic brilliancy of the ordinary incandescent lamp is particularly noteworthy and, from the oculist's standpoint, menacing.

Everyone is familiar with the distress caused the eye by sudden alternations of light and darkness, as in stepping from a dark room into full sunlight, or even in lighting the gas after the eye has become habituated to the darkness. The eye is provided with a very wonderful automatic "iris diaphragm" for its adjustment to various degrees of illumination, but it is by no means instantaneous, although very prompt, in its action. Moreover, the eye after resting in darkness is in an extremely sensitive and receptive state, and a relatively weak light will then produce very noticeable after-images. These after-images, such as are seen in vivid colors after looking at the sun, are due to retinal fatigue.

If the image of a brilliant light is formed upon the retina, it produces certain very considerable chemical changes, akin to those produced by light upon sensitized paper. In so doing it temporarily exhausts or weakens the power of the retina to respond at that point to further visual impressions, and when the eye is turned away the image appears, momentarily persistent, and then reversed, dark for a white image, and of the complementary hue for a colored one. This after-image fades away more or less slowly, according to the intensity of the original impression, as the retina recovers its normal sensitiveness.

A strong after-image means a serious local strain upon the eye, and shifting the eye about when brilliant light can fall upon it implies just the same kind of strain that one gets in going out of a dark room into bright sunshine. The results of either may be very serious. In one case

recently reported a strong side light from an unshaded incandescent lamp set up an inflammation that resulted in the loss of an eye. The light was two or three feet from the victim, whose work was such that the image of the filament steadily fell on about the same point on the retina, at which point the resulting inflammation had its focus. A few weeks' exposure to these severe conditions did the mischief. This is an extreme case, but similar conditions may very quickly cause trouble. A year or two since the writer was at lunch facing a window through which was reflected a brilliant beam from a white painted sign in full sunlight just across the street. No especial notice was taken of this, until on glancing away a strong after-image of the sign appeared, and although the time of exposure was only ten or fifteen minutes, the net result was inability to use the eyes more than a few minutes at a time for a fortnight afterwards.

To certain extent the eye can protect itself from too brilliant general illumination by closing up the iris, and it always does so, reducing the general brightness of the retinal images, as one regulates the illumination on a photographic plate. The following results of experiments by Lambert will give an idea of the way in which the pupil reacts to variations of light. The radiant used was a hole in a shutter admitting bright skylight to a darkened room.

RELATIVE DISTANCE.	AREA OF PUPIL IN SQ. MM.
1	7.3
2	13.0
3	16.6
4	20.5
5	25.0
6	30.6
7	36.8
8	44.5
9	48.0
10	57.1

But a light of great intrinsic brilliancy produces so strong an image that it may cause trouble even when the aperture of the eye is stopped to the utmost limit provided by nature. In the effort to accomplish this adjustment the iris closes so far, when a brilliant light is in the field of vision, that the rest of the field may be dimmed so much as to interfere with proper vision, quite aside from any question of fatigue induced by the bright image wandering over the retina as the eye is shifted.

In general terms the iris adjusts itself with reference to the brightest light it has to encounter, so that if there is in the field of vision a source of light of great intrinsic brilliancy, the working illumination may be highly unsatisfactory. The same principle coupled with retinal fatigue accounts for one's inability to see beyond a brilliant light, as in driving towards an arc lamp hung low over the street.

A very simple experiment, showing the effect of a brilliant source of light on the apparent illumination, may be tried as follows: Light a brilliant lamp, unshaded, in a good-sized room, preferably one with darkish paper. Then put on the light an opal or similar shade. It will be found that the change has considerably improved the apparent illumination of the room, although it has really cut off a good part of the total light. Moreover, at points where there remains a fair amount of illumination, the shade has improved the reading conditions very materially. If one is reading where the unshaded light is at or within the edge of the field of vision, the improvement produced by the shade is very conspicuous. Lowering the intrinsic brilliancy of the light has decreased the strain upon the eye and given it a better working aperture.

As a corollary to these suggestions on the effect of



bright lights on our visual apparatus should be mentioned the fact that sudden variations in the intensity of illumination seriously strain the eye both by fatigue of the retina, due to sudden changes from weak to strong light, and by keeping the eye constantly trying to adjust itself to changes in light too rapid for it properly to follow.

A flickering gaslight, for example, or an incandescent lamp run at very low frequency, strains the eye seriously and is likely to cause temporary, even if not permanent, injury.

The persistence of visual impressions whereby the retinal image remains steady for an instant after the object ceases to affect the eye furnishes a certain amount of protection in case of very rapid changes of brilliancy. It acts like inertia in the visual system.

In the case of arc and incandescent lamps the thermal inertia of the filament or carbon rod also tends physically to minimize the changes, but with a low frequency alternating current they may still be serious.

The exact frequency at which an incandescent lamp on an alternating circuit begins to distress the eye by the flickering effect depends somewhat on the individual eye and somewhat on the mass of the filament. In general, a 16-cp lamp of the usual voltages, say 100 to 120 volts, begins to show flickering at or sometimes a little above 30 cycles per second; one foreign authority noting it even up to 40 cycles. At 25 cycles the flickering is very troublesome to most eyes, and at 20 cycles or below it is generally quite intolerable. In looking directly at the lamp the filament is so dazzling that the fluctuations are not always in evidence at their full value, and a low frequency lamp is quite likely to be the source of trouble to the eye even when at first glance it appears to be quite steady.

Lamps having relatively thick filaments can be worked at lower frequencies than those of the common sort, so that 50-volt lamps, particularly of large candle-power, may be worked at 30 cycles or thereabouts rather well, and out of doors even down to 25 cycles. That is, at a pinch one can do satisfactory work when current is available at 25 cycles or so, by using low voltage lamps of 32, 50, or 100 cp, which, by the way, are capable of giving admirable results in illumination if properly disposed. Of course, such practice is bad in point of efficient distribution of current, but on occasion it may be useful.

As to arc lamps, conditions are not so favorable. The fluctuations of an alternating arc lamp are easily detected, even at 60 cycles, by moving a pencil or the finger quickly when strongly illuminated. The effect is a series of images along the path of motion, corresponding to the successive maxima of light in the arc. At 40 to 45 cycles the flickering becomes evident even when viewing stationary objects, the exact point where trouble begins depending upon the adjustment of the lamp, the hardness of the carbons, and various minor factors. Enclosing the arc mitigates the difficulty somewhat, but does not remove it.

In working near the critical frequency the best results are attained by using an enclosed arc lamp taking all the current the inner globe will stand, with as short an arc as will work steadily.

When polyphase currents are available, as is usually the case where rather low frequencies are involved, some relief may be obtained by arranging the arcs in groups consisting of one from each phase. At a little distance from such a group the several illuminations blend so as to partially suppress the fluctuations of the individual arcs.

This device makes it possible to obtain fairly satisfactory lighting between 35 and 40 cycles. At these frequencies, however, the arcs should not be used except when a very powerful light is necessary, or when the slightly yellowish tinge of incandescents would interfere with the proper judgment of colors. Powerful incandescents are generally better, and are but little less efficient, particularly when one takes into account proper distribution of the light. In using incandescents in large masses, particularly on polyphase circuits, the flickering of the individual lights is lost in the general glow, so that even at 25 cycles the light may be steady enough for general purposes, as was the case with the decorative lighting at the Pan-American Exposition. The fluctuations due to low frequency are usually very distressing to the eye, and should be sedulously avoided. Fortunately, save in rare instances, the frequency can be and should be kept well above the danger point.

The same considerations which forbid the use of very intense lights, unshaded, flickering lights, and electric lights at too low frequency, render violent contrasts of brilliant illumination and deep shadows highly objectionable. It should be remembered that in daylight the general diffusion of illumination is so thorough that such contrasts are very much softened, even in full sunlight, and much of the time the direct light is modified by clouds. In situations where the sun shines strongly down through interstices in thick foliage, the effect is decidedly unpleasant if one wishes to use the eyes steadily, and if in addition the wind stirs the leaves and causes flickering the strain upon the eyes is most trying.

In artificial lighting one should carefully avoid the conditions that are objectionable in nature, which can easily

be done by a little foresight. If for any purpose very strong illumination becomes necessary at a certain point, the method of furnishing it which is most satisfactory from a hygienic standpoint is to superimpose it upon a moderate illumination well distributed. If a brilliant light is needed upon one's work, start with a fairly well lighted room and add the necessary local illumination, instead of concentrating all the light on one spot. This procedure avoids dense shadows and dark corners, and enables the eye to work efficiently in a much stronger illumination than would otherwise be practicable.

It should not be understood that the complete abolition of shadows is desirable. On the contrary, since much of our perception of form and position depends upon the existence of shadows, the entire absence of them is troublesome and annoying. This is probably due to two causes. First, the absence of shadows gives an appearance of flatness, out of which the eye vainly struggles to select the wonted degrees of relief. In a shadowless space we have to depend upon binocular vision to locate points in three dimensions, and the strain upon the attention is severe and quickly felt.

Second, the existence of a shadowless space presupposes a nearly equal illumination from all directions. If it be strong enough from any particular direction to be convenient for work requiring close attention of mind and eye, then, if there be no shadows, equally strong light will enter the eye from directions altogether unwonted. This state of things we have already found to be objectionable in the highest degree.

The best illustration of this latter condition may be found in nature during a thin fog which veils the sun while diffusing light with very great brilliancy. Try to read at

such a time out of doors, and although there is no direct light on the page to dazzle you, and there is in reading no trouble from the sense of flatness, yet there is a distinctly painful glare which the eyes cannot long endure without serious strain.

In artificial lighting the same complete diffusion is competent to cause the same results, so that while contrasts of dense shadows and brilliant light must be avoided, it is generally equally important to give the illumination a certain general direction to relieve the appearance of flatness and to save the eye from crosslights.

With respect to the best direction of illumination, only very general suggestions can be given. Brilliant light, direct or reflected, should be kept out of the eye and upon the objects to be illuminated. In each individual case the nature and requirements of the work must determine the direction of lighting.

The old rule given for reading and writing, that the light should come obliquely over the left shoulder, well illustrates ordinary requirements. By receiving the light from the point indicated direct light is kept out of the eyes, and any light regularly reflected is generally out of the way. The eye catches then only diffused light from the paper before it, and if the light comes from the left (for a right-handed person) the shadow of hand and arm does not interfere with vision. If work requiring both hands is under way the chances are that the best illumination will be obtained by directing it downwards and slightly from the front, in which case care must be exercised to avoid strong direct reflection into the eyes. The best simple rule is, avoid glare direct or reflected, and get strong diffused light from the object illuminated.

This brings us at once to the very important but ill-

defined question of the strength of illumination required for various kinds of work.

Fortunately, the eye works well over a wide range of brightness, but there is a certain minimum illumination which should be exceeded if one is to work easily and without undue strain. The matter is much complicated by questions of texture and color, which will be taken up presently, so that only general average results can be considered. For reading and writing experience has shown that an intensity of about *one candle-foot* is the minimum suitable amount with ordinary type and ink, such as is here used, for instance. With large, clear type

like that used for this particular line

half a candle-foot enables one to read rather easily, while with ordinary type set solid or in type of the smaller sizes,

such type as is employed in this line as a horrible example,

two candle-feet is by no means an unnecessary amount of lighting. Dense black ink and clear white paper not highly calendered, such as some of the early printers knew well how to use, make vastly easier reading than the grayish-white stuff and cheap muddy-looking ink to be found in the average newspaper.

Illumination of less than half a candle-foot usually renders reading somewhat difficult and slow, the more difficult and slower as the illumination is further reduced. At one-tenth or two-tenths of a candle-foot reading is by no means easy, and there is a strong tendency to bring the book near the eye, thereby straining one's power of accommodation, and to concentrate the attention upon single words, a tendency which increases as the light is still further lessened.

In fact, when the illumination falls to the vicinity of

one-tenth candle-foot it is of very little use for the purpose of reading or working.

One may get a fair idea of the strength of illumination required for various purposes by a consideration of that actually furnished by nature. To get at the facts in the case, we must make a little digression in the direction of photometry, a subject which will be more fully discussed later.

To get an approximate measure of the illumination furnished by daylight, one can conveniently use what is

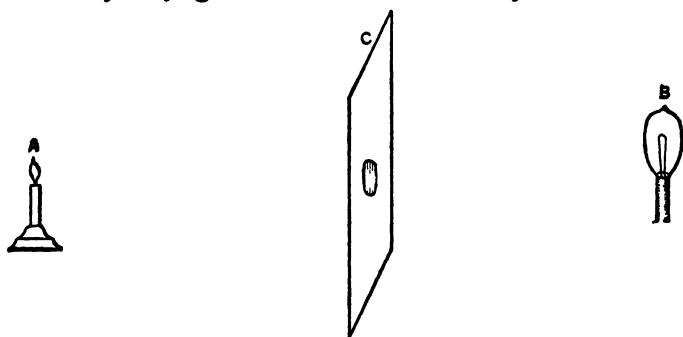

Fig. 4.—Principle of the Photometer.

known as a daylight photometer. This instrument furnishes a means for balancing the illumination due to any source against that due to a standard candle at a known distance. Like most common forms of photometer it consists of a screen illuminated on its two sides by the two sources of light respectively. Equality of illumination is determined by the disappearance of a grease spot upon the screen. A spot of grease on white paper produces, as is well known, a highly transparent spot, which looks bright if illuminated from behind, and dark when illuminated from the front.

Thus, if one sets up such a screen *C* between and equi-

distant from a candle *A* and an incandescent lamp *B*, and then looks at the screen obliquely from the same side as *B*, the appearance is that shown in Fig. 4. Moving around to the other side of the screen one gets the effect shown in Fig. 5. By moving the candle *A* nearer or the incandescent *B* farther off, a point will be found where the spot becomes nearly invisible on account of the equal illumination on the two sides. This "Bunsen photometer screen" requires very careful working to get highly accurate results, but gives closely approximate figures readily.

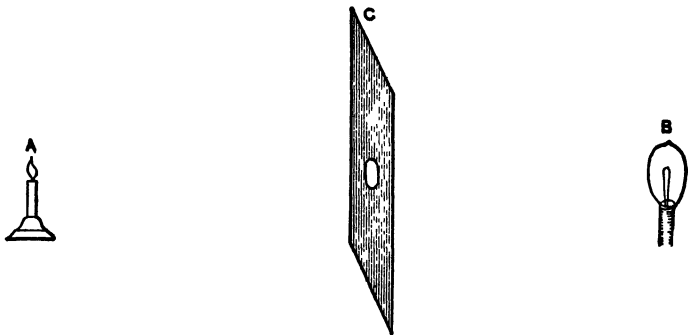

Fig. 5.—Principle of the Photometer.

The daylight photometer, Fig. 6, is the simplest sort of adaptation of this principle. It consists of a box, say five or six feet long and fifteen inches square. In one end is a hole *B* filled with the photometer screen just described, and a slot to receive a graduated scale *A* carrying a socket for a standard candle. The interior of the box is painted dead black, so as to avoid increasing the illumination at *B* by light reflected within the box.

Setting up the box with the end *B* pointing in the direction of the illumination to be estimated, the candle is slid back and forth until the grease spot disappears, when the



distance from the candle to *B* gives the required illumination, by applying the law of inverse squares, which holds sufficiently well for approximate purposes if the box is well blackened.

Of course the results of such measurements vary enormously with different conditions of daylight. A few

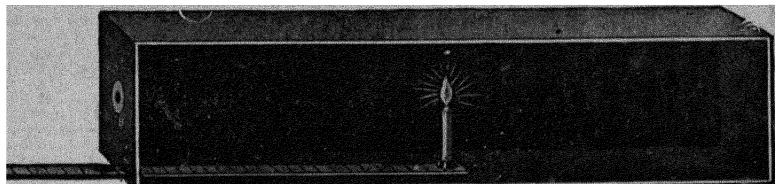

Fig. 6.—Daylight Photometer.

measurements made in a large, low room with windows on two sides, culled from the writer's notebook, give the following results, the day being bright, but not sunny, and the time early in the afternoon :

Facing south window.....	6 candle-feet
Facing east window.....	2.2 " "
Facing north wall.....	0.7 " "
And again, 10 feet from south window, on a misty	
April day, 5 P. M.....	0.5 " "

On a clear day the diffused illumination near a window, while the sun is still high, will generally range from 5 to 10 candle-feet, while in cases where there are exceptionally favorable conditions for brilliant illumination it may rise to twice or even four times the amount just stated.

Now, these figures for the lighting effects of diffused daylight give a good clew, if nothing more, to the intensity of illumination required for various purposes. In point of fact, reading and writing require less light than almost any other processes which demand close ocular attention.

Everything is black and white, there is no delicate shading of colors, nor any degrees of relief to be perceived in virtue of differences of light and shade. Moreover, the characters are sharply defined and not far from the eye. It is therefore safe to say that for any work requiring steady use of the eyes at least one candle-foot is demanded. If practicable, this minimum should be doubled for really effective lighting, while for much fine detail and for work on colored materials not less than five candle-feet should be provided. Even this amount may advantageously be doubled for the finest mechanical work, such as engraving, watch repairing, and similar delicate operations. In fact, for such cases the more light the better, provided the source of light and direct undiffused reflections therefrom are kept out of the eyes.

These estimates have taken no account of the effect of color, which sometimes is a most important factor, alike in determining the amount of illumination necessary and in prescribing the character and arrangement of the sources of light to be employed.

## CHAPTER II.

### PRINCIPLES OF COLOR.

THE relation of color to practical illumination is somewhat intricate, for it involves considerations physical, physiological, and æsthetic, but it is well worth studying, for while in some departments of illumination, such as street lighting, it is of little consequence, in lighting interiors it plays a very important part. In lighting a shop where colored fabrics are displayed, for example, it is necessary to reproduce as nearly as may be the color values of diffused daylight, even at considerable trouble. Such illumination, however, may be highly undesirable in lighting a ballroom, where the softer tones of a light richer in yellow and orange are generally far preferable.

In certain sorts of scenic illumination strongly colored lights must be employed, but always with due understanding of their effect on neighboring colored objects. Sometimes, too, the natural color of a light needs to be slightly modified by the presence of tinted shades, serving to modify both the intrinsic brilliancy and the color.

The fundamental law with respect to color is as follows: *Every opaque object assumes a hue due to the sum of the colors which it reflects.* A red book, for instance, looks red because from white light it selects mainly the red for reflection, while strongly absorbing the green and blue.

White light, as a look through a prism plainly shows, is a composite of many colors, fundamentally red, green, and blue, incidentally of an almost infinite variety of transition tints. If a narrow beam of sunlight passes through a prism it is drawn out into a many-colored *spectrum* in which the three colors mentioned are the most prominent. Closer inspection detects a rather noticeable orange region passing from red to green by way of a narrow space of pure yellow, which is never very conspicuous. The green likewise shades into pure blue through a belt of greenish blue, and the blue in turn shades off into a deep violet. If the slit which admits the sunlight is made very narrow, certain black lines appear crossing the spectrum—the Fraunhofer lines due to the selective absorption of various substances in the solar atmosphere. These lines are for the purpose in hand merely convenient landmarks to which various colors may be referred. They were designated by Fraunhofer by the letters of the alphabet, beginning at the red end of the spectrum.

Fig. 7 shows in diagram the solar spectrum with these lines and the general distribution of the colors. The *A* line, really a broad dark band of many lines, is barely visible save in the most intense light, and the eye can detect little or nothing beyond it. At the other end of the spectrum the *H* lines are in a violet merging into lavender, are not easy to see, and there is but a narrow region visible beyond them—pale lavender, as generally seen. The spectrum in Fig. 7 is roughly mapped out to show the extent of the various colors as distributed in the ordinary prismatic spectrum.

At *A*, Fig. 7, is shown the spectrum of the light reflected from a bright red book, *i. e.*, the color spectrum which defines that particular red. It extends from a deep red into

clear orange, while the absorption in the yellow and yellowish green is by no means complete.

At *B*, is the color spectrum from a green book. Here there is considerable orange and yellow, a little red

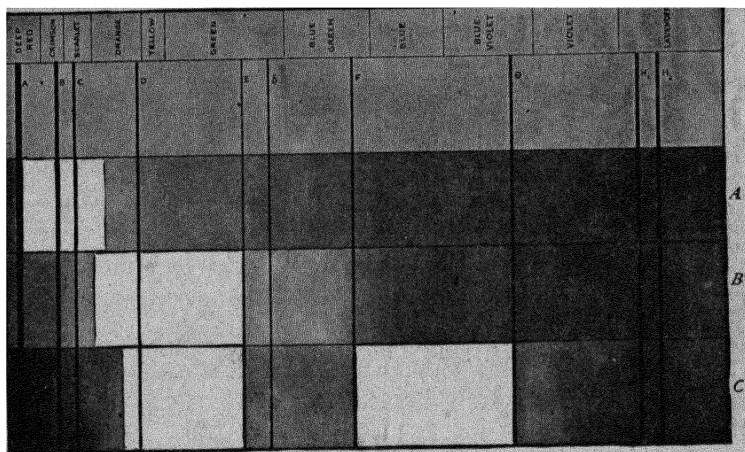

Fig. 7.—Solar and Reflected Spectra.

and much bright green, together with rather weak absorption in the bluish green.

*C* shows a similar diagram from a book apparently of a clear, full blue. The spectrum shows pretty complete absorption in the red and extending well into the orange. The orange-yellow and yellowish-green remain, however, as does all the deep blue, while there is a perceptible absorption of the green and bluish-green.

Now, these reflected spectra are thoroughly typical of those obtained from any dyed or painted surfaces. The colors obtained from pigments are never the simple hues they appear to be, but mixtures more or less complex, sometimes of colors from very different regions of the spectrum. Most of the commoner pigments produce ab-

sorption over rather wide regions of the spectrum, but some of the delicate tints found in dyed fabrics show several bands of absorption in widely separated portions of the spectrum. These are the colors most seriously affected by variations in the color of the illuminant when viewed by artificial light. Fig. 8 is a case in point, a color spectrum taken from a fabric which in daylight was a delicate cornflower blue. The absorption begins in the crimson, leaving much of the red intact, is partial in the orange and yellow, stronger in the green, and quite complete in the bluish-green region. The blue well up to the violet is freely reflected, and then the violet end of the spectrum is

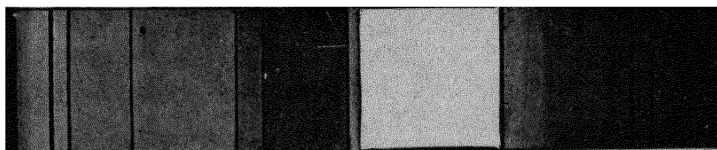

Fig. 8.—Spectrum Reflected From Blue Silk.

considerably absorbed. Most of the reflected light is blue, but if the illumination is conspicuously lacking in blue rays, as is the case with candle light or common gaslight, the blue light reflected is necessarily weak, while the red component comes out at its full strength, and the visible color of the fabric is distinctly reddish.

A similar condition is met in certain blues which in daylight reflect a large proportion of blue and bluish violet, but in which some green rays are left, just as was the clear red in Fig 8. By gaslight the blue becomes relatively very much weakened, and the apparent color is unmistakably green. Such changes in hue are in greater or less degree very common, and furnish some very curious effects. Sometimes a color clear by daylight appears dull and

muddy by artificial light, and in general the quality of the illumination requires careful attention whenever one deals with delicate colors.

The absorption found in the pigments used in painting is seldom so erratic as that shown in Fig. 8, but pictures often show very imperfectly under ordinary artificial illumination.

It is no easy matter to get a clear idea of the color properties of various illuminants. Of course, one can form spectra from each of the lights to be compared, and compare the relative strengths of the red, green, blue, and other rays in each, but this gives but an imperfect idea of the relative color effects produced, for the results themselves are rather discordant, and the relative brightness thus measured does not correspond accurately with the visual effect. Probably a better plan from the standpoint of illumination is to match the visible color of a given illuminant accurately by mixtures of the three primary spectral colors, red, blue-violet and green, and to determine the exact proportions of each constituent required to give a match. Even this evidently does not tell the whole story, but it gives an excellent idea of the color differences found in various lights. Such work has been very beautifully carried out by Abney, from whose results the following table is taken :

	SUNLIGHT	SKY LIGHT	ARCLIGHT	GASLIGHT
Red .....	100	100	100	100
Green.. .....	193	256	203	95
Violet.....	228	760	250	27

Incandescent lamps are not here included, but give enormously different results according to the degree of incan-

descence to which they are carried. If burned below candle-power they give a light not differing widely from gaslight; while if pushed far above candle-power the light is far richer in violet rays, and becomes pure white. Unfortunately, however, the lamp does not reach this point save at a temperature that very quickly ends its life.

The effects of the selective absorption which so deceives the eye when colored objects are viewed in colored lights are shown in a variety of ways according to the colors involved, but the net result of them all is to show the necessity of looking out for the color of artificial lights. Of course, a really strong color may produce very fantastic results. For example, in the rays of an ordinary green lantern, such as is used for railway signals, greens generally appear of nearly their natural hues; but greens, yellows, browns, and grays all match pretty well, although they may appear darker or lighter in shade. Pink looks gray, darkening in shade as it gets redder, and red is nearly black, for the green light which falls upon it is almost totally absorbed.

Practical illuminants do not often present so violent deceptions, and yet gas or candle light is certain to change the apparent hue of any delicate colors containing bluish green, blue, or violet rays. An old Welsbach mantle which gives a light of a strongly greenish cast is pretty certain to change the color of everything not green upon which it falls. Incandescent electric lights affect colors in much the same way as brilliant gaslight, while arc lights give a fair approximation to daylight. It by no means follows, however, that all colors should be matched by arc lights in preference to other sources of illumination. A match so made stands daylight, but may be most faulty when viewed by gaslight.



If matching colors has to be done, it is a safe rule to match them by the kind of light by which they are intended to be viewed. Moreover, different shades of the same color are differently affected in artificial light. As a rule, deep, full colors are far less affected than light tones of the same general hue. Clear yellows, reds, and blues not verging on green are usually little altered, but pale pinks, violets, and "robin's-egg" blues quite generally suffer. Very often when a color is not positively altered it is made to appear gray and muddy.

For while in a green light greens look particularly brilliant, red may be practically extinguished, absorbing all the rays which come to it, so that a deep red will be nearly black, and a very light red merely a dirty white, tinged with green if anything.

Quite apart from any effect of colored illumination, colors seem to change in very dim light. This is a purely physiological matter, the eye itself differing in its sensibility to different colored lights. In very faint illumination no color of any kind is perceptible—everything appears of uncertain shades of gray. As the light fades from its normal intensity, as in twilight, red disappears first, then violet and deep blue follow, settling like the red into murky blackness; then the bluish green and green shade off into rapidly darkening gray, and finally the yellow and yellowish orange lose their identity and merge into the night. At the same time the hues even of simple colors change, scarlet fading into orange, orange into yellow, and green into bluish green.

Obviously, complicated composite colors must vary widely under such circumstances, for as the light grows dimmer their various components do not fade in equal measure. Pinks, for instance, generally turn bluish gray

at a certain stage of illumination, owing to the extinction of the red rays. In fact, in a dim light the normal eye is color blind as regards red, and one can get a rather good idea of the sensations of the color blind by studying a set of tinted wools or slips of paper in the late twilight.

The similarity of the conditions is strikingly illustrated in Fig. 9, which shows in No. 1 the distribution of lumi-

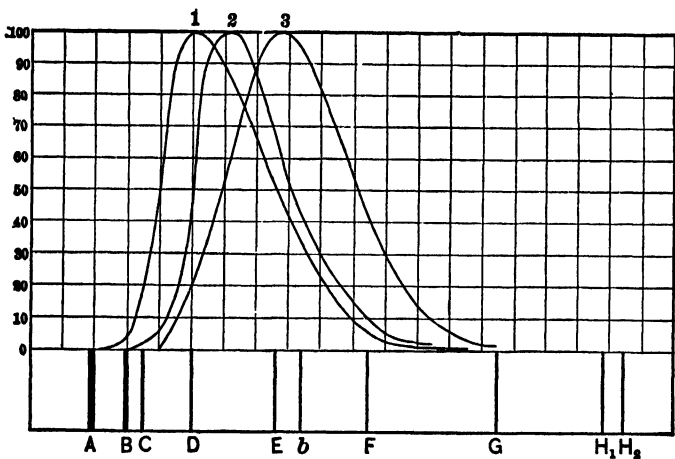

Fig. 9.—Effect of Faint Light on Color.

nosity in the spectrum of bright white light to the normal eye, and in No. 2 the luminosity of the same as seen by a red-blind eye. No. 3 shows the luminosity of the spectrum when reduced to a very small intensity and seen by the normal eye. The data are from Abney's experiments, and the intensity of No. 3 was such that the yellow component of the light corresponding to D of the spectrum was 0.006 candle-foot. The ordinates of No. 2 and No. 3 have been multiplied by such numbers as would bring their respective maxima to equal the maximum of No. 1,

as the purpose is to show their relative shapes only. The "red-blind" curve No. 2 shows very faint luminosity in the scarlet and orange and absence of sensation in the crimson, while the maximum luminosity is in the greenish yellow. It is easy to see that the sensation of red is practically obliterated.

But in No. 3 every trace of red is gone, and the maximum brilliancy has moved up into the clear green of the spectrum at the line *E*. With a still further reduction of intensity, the spectrum would fade into gray as just noted, while a slight increase of light would cause No. 3 closely to approximate No. 2.

Starting with the normal curve of luminosity No. 1, the peak of the curve being one candle-power, the light at *B* would disappear if the illumination were reduced to .01 of its initial value, that at *C* at about .0011, at *D* .00005, at *E* .0000065, at *F* .000015, and at *G* .0003.

Now the practical application of these facts is manifold. Not only do they explain the odd color effects at twilight and dawn, but it is worth noting that the cold greenish hue of moonlight on a clear night means simply the absence of the red and orange from one's perception of a very faint light, for dim moonlight is ordinarily not much brighter than the light of curve No. 3. For the same reason a red light fades out of sight rather quickly, so that a signal of that color is not visible at a distance at which one of another color and equal brightness would be easily seen.

Not only is the eye itself rather insensitive to red, but the luminosity of the red part of the spectrum of any light is rather weak, so that when the other rays are cut off by colored glass, the effective light is greatly reduced. About 87 per cent. of the effective luminosity of white

light lies between the lines *C* (scarlet) and *E* (deep green), the relative luminosities at various points being about as follows:

LINE.	LUMINOSITY.
<i>B</i>	3
<i>C</i>	20
<i>D</i>	98.5
<i>E</i>	50
<i>b</i>	35
<i>F</i>	7
<i>G</i>	0.6

The luminosities of light transmitted through ordinary colored glasses of various colors is about as follows, following Abney's experiments, clear glass being 100:

COLOR OF GLASS.	LIGHT TRANSMITTED.
Ruby.....	13.1
Canary.....	82.0
Bottle green.....	10.6
Bright green (signal green No. 2).....	19.4
Bluish green (signal green No. 1).....	6.9
Cobalt blue.....	3.75

These figures emphasize the need of a very powerful source if it is necessary to get a really bright-colored light. It is worth noting that red is a particularly bad color for danger signals on account of its low luminous effect, and were it not for the danger of changing a universal custom, red should be the "clear" signal and green the danger signal, the latter color giving a much brighter light, and thus being on the average more easily visible.

It is easy to see that any artificial illuminant is at a considerable disadvantage if at all strongly colored, for not only does a preponderance of red or green rays injure color perception, but the luminosity of such rays is rather low,

and they do not compensate for their presence by giving greatly increased illumination.

Owing to this fact the effective illumination derived from various sources of light is pretty nearly proportional to the intensity of the *yellow* component of each. Crova has based on this rule an ingenious approximate method of comparing the total intensity of colored lights by comparing the intensities of their yellow rays, either from their respective spectra or by sifting out all but the yellow and closely adjacent rays by means of a colored screen.

Certainly for practical purposes the rays at the ends of the spectrum are not very useful. So far as the ordinary work of illumination goes, white or yellowish white light should be used, and the only practical function of strongly colored lights is for signaling and scenic illumination.

The general effect of strongly colored lights is to accentuate objects colored like the light and to change or dim all others. Lights merely tinted produce a similar effect in a less degree. Bluish and greenish tinges in the light give a cold, hard hue to most objects, and produce on the face an unnatural pallor; in fact, on the stage they are used to give in effect the pallor of approaching dissolution. Naturally enough such light is unfitted for interior illumination, as, aside from its effect on persons, it makes a room look bare, chill, and unfurnished. In a less degree a similar effect is produced by moonlight, which, from a clear sky, is distinctly cold, the white light growing faintly greenish blue as its diminishing intensity causes the red to disappear.

On the other hand, a yellow-orange tinge in the light seems to soften and brighten an interior, giving an effect

generally warm and cheery. This result is extremely well seen in stage fire-light effects. Strongly red light is, however, harsh and trying and particularly difficult to see well by, so that it should generally be carefully avoided.

While it is not easy to predict accurately the effect of tinted lights upon various delicate shades without a careful study of the light rays forming each, the average effects relating to the simpler colors are summarized in the following table. It is compiled from the experiments of the late M. Chevreul, for many years director of the dyeworks of the Gobelins tapestries. The colored lights were from sunlight sifted through colored glass, and the effects were upon fabrics dyed in plain, simple colors.

The facts set forth in this table show well what should be avoided in colored illumination. As regards various shades of the same colors it must be remembered that light shades are merely the full deep ones diluted with white, which is itself affected by the color of the incident light. In a general way, therefore, one can use this table over a wider range than that written down.

For instance, a very light red in blue light would look blue with a mere trace of violet, while in yellow light it would be bright yellow with a very slight orange cast. Generally a very light color viewed by colored light will be between the effect produced on the full color, and that produced by the light on a white surface. Similarly a light only tinged with color will only slightly modify the tone of a colored object in the direction indicated for the full-colored light in the table.

But delicate shades from modern dyestuffs, which often absorb the light in very erratic ways, as in Fig. 8, are a different matter, and do not obey any simple laws. On

ORIGINAL COLOR OF FABRIC	COLOR OF LIGHT FALLING UPON FABRICS					
	RED	ORANGE	YELLOW	GREEN	BLUE	VIOLET
Black	Purplish Black	Deep Maroon	Yellow Olive	Greenish Brown	Blue-Black	Faint Violet Black
White	Red	Orange	Light Yellow	Green	Blue	Violet
Red	Intense Red	Scarlet	Orange	Brown	Violet	Red-Violet Purple
Orange	Orange Red	Intense Orange	Yellow-Orange	Faint Yellow slightly Greenish	Brown slightly Violet	Light Red
Yellow	Orange	Yellow Orange	Orange-Yellow	Yellowish Green	Green	Brown tinged with faint Red
Light Green	Reddish Gray	Yellow Green	Greenish Yellow	Intense Green	Blue-Green	Light Purple
Deep Green	Reddish Black	Rusty Green	Yellowish Green	Intense Green	Greenish Blue	
Light Blue	Violet	Orange Gray	Yellowish Green	Green Blue	Vivid Blue	
Deep Blue		Gray slightly on Orange	Green-Slate	Blue Green	Intense Blue	Bright Blue-Violet
Indigo Blue		Orange-Maroon	Orange-Yellow (very dull)	Dull Green	Dark Blue-Indigo	Deep Blue-Violet
Violet	Purple	Red-Maroon	Yellow-Maroon	Bluish Green-Brown	Deep Bluish Violet	Deep Violet

the other hand, pure colors, in the sense in which the scarlet around the C line of the spectrum is pure, act in a fashion rather different from that shown in the table, which pertains to standard dyestuffs which never are anywhere near being pure colors. However, as artificial illumination has to do only with commercial pigments and dyes, the table serves as a useful guide in judging the effects produced on interior furnishings by change in the color of the light.

Of common illuminants, none have any very decided

color, yet most are somewhat noticeably tinged. One can tabulate them roughly as follows :

ILLUMINANT.	COLOR.
Sun (high in sky).	White.
Sun (near horizon).	Orange red.
Sky light.	Bluish white.
Electric arc (short).	White.
Electric arc (long).	Bluish white to violet.
Nernst lamp.	White.
Incandescent (normal).	Yellow-white.
Incandescent (below voltage).	Orange to orange-red.
Acetylene flame.	Nearly white.
Welsbach light.	Greenish white.
Gaslight (Siemens burner).	Nearly white, faint yellow tinge
Gaslight, ordinary.	Yellowish white to pale orange.
Kerosene lamp.	Yellowish white to pale orange.
Candle.	Orange yellow.

Outside the earth's atmosphere the sun would look distinctly blue, while its light, after thorough absorption in the earth's atmosphere, gets the blue pretty completely sifted out, so that the light from the eclipsed moon, once refracted by the earth's atmosphere and then reflected through it again, is in color a deep coppery red.

Arc lights vary much in color, from clear white in short arcs with comparatively heavy current to bluish white or whitish violet in long arcs carrying rather small current. The modern enclosed arcs tend in the latter direction, and give their truest color effects with yellowish white inner globes or shades. Incandescents, as generally worked, verge upon the orange. Of the luminous flames in use, only acetylene comes anywhere near being white, although the powerful regenerative burners are a close second. Incandescent gas lamps, at first showing nearly white with a very slight greenish cast, acquire a greenish or yellowish green tinge after burning for some time.

It is evident then that a study of the color effects pro-



duced by colored illuminants is by no means irrelevant, for distinct tinges of color are the rule rather than the exception.

But this is not at all the whole story, for the general color of the illumination in a given space depends not only on the hue of the illuminant, but upon the color of the surroundings. Colored shades, of course, are in common use; sometimes with a definite purpose, more often from a mistaken notion of prettiness. Used intelligently, as we shall presently see, they may prove very valuable adjuncts in interior illumination.

But far more important than shading is the modification in the color of the light which comes from selective reflection at surfaces upon which the light falls. In every enclosed space light is reflected in one way or another from all the bounding surfaces, and at each reflection not only is the amount of light profoundly modified, but its color may undergo most striking changes. It is this phenomenon that gives its greatest interest to the study of color in illumination. Its importance is not always readily recognized, for few persons pay really close attention to the matter of colors, but now and then it obtrudes itself in a way that forces attention.

Take for example a display window lined with red cloth and brightly illuminated. Passing along the sidewalk one's attention is immediately drawn to a red glow upon the street, while the lights themselves may be ordinary gas jets. To get at the significance of this matter, we must take up the effect of reflection and diffusion in modifying the amount and quality of light.

## CHAPTER III.

### REFLECTION AND DIFFUSION.

To begin with, reflection is of two kinds—in their essence the same, yet exhibiting very different sets of properties. The first, or regular reflection, may be best exemplified by the reflection which a beam of light undergoes at the surface of a mirror. The beam strikes the surface and is reflected therefrom as sharp and as distinct as it was before its incidence, and in a perfectly definite direction.

The character of this regular reflection is very clearly shown in Fig. 10. Here  $B$  is the reflecting surface—a plane, polished bit of metal, for instance.  $AB$  is the incident ray and  $BC$  the reflected ray. In such reflection two principal facts characterize the nature of the phenomenon. In the first place, if a perpendicular to the surface of the mirror—as  $BD$ —is erected at the point of incidence, the angle  $ABD$  is always precisely equal to the angle  $DBC$ . In other words, *the angle of incidence is equal to the angle of reflection*, which is the first law of regular reflection. Moreover, *the incident ray  $AB$ , the normal to the surface at the point of incidence  $BD$ , and the reflected ray  $BC$  are all in the same plane.*

In this ordinary form of reflection, such as is familiar in mirrors, the direction of the reflected ray is entirely determinate, and, in general, although the reflected ray has lost in intensity, it is not greatly changed in color. A polished copper surface, to be sure, shows a reddish reflec-

tion, and polished gold a distinctly yellowish reflection. Only in certain dye stuffs which exhibit a brilliant metallic reflection is the color strongly marked. In other words, a single reflection from a good, clean, reflecting surface does not very greatly change either the intensity or the color of the reflected beam. The angle of incidence

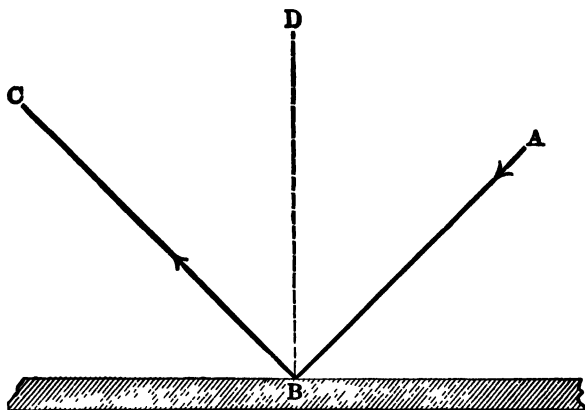

Fig. 10.—Regular Reflection.

affects the brilliancy of the reflection somewhat, but the color only imperceptibly. In the art of practical illumination regular reflection comes into play only in a rather helpful way, and kindly refrains from complicating the situation with respect to color or intensity.

The second sort of reflection is what is technically known as diffuse reflection. This term does not mean that the phenomenon itself is of a totally different kind from regular reflection, but nevertheless, its results are totally different. No surface is altogether smooth. Even with the best polished metallic mirrors, while the reflected image is perfectly distinct at ordinary angles of reflection, it is apt to become slightly hazy at grazing inci-

dence—that is, when the incident and reflected beams are nearly parallel to the surface. This simply means that under such conditions the infinitesimal roughness of the reflecting surface begin to be in evidence.

To get an idea of the nature of diffuse reflection, examine Fig. 11. In this case a section of the reflecting surface is rough, showing grooves and points of every

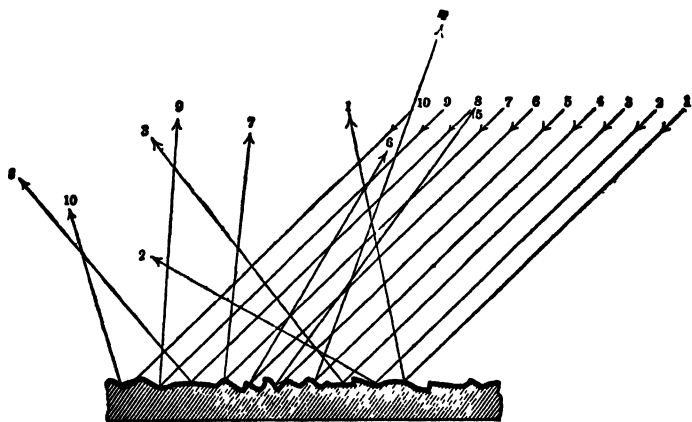

Fig. 11.—Diffuse Reflection.

description—in fact, nearly everything except a plane surface. Consider now the effect of a series of parallel incident beams—numbered in the figure from 1 to 10—falling upon the surface. Each one of them is reflected from its own point of incidence in a perfectly regular manner; yet the reflected rays, on account of the irregularity of the surface, lie in all sorts of directions, and moreover, in all sorts of planes, according to the particular way in which the surface at the point of incidence is distorted. Diffuse reflection, therefore, scatters the incident beam in all directions, for the roughnesses of an unpolished surface are generally totally devoid of any regularity. The point

of incidence upon which a beam falls, therefore, radiates light in a diverging cone and behaves as if it were really luminous.

Some consideration of the nature of this diffuse reflection will bring to light a fact which in itself seems rather surprising: namely, that the total intensities of the two kinds of reflection are not so different from each other as might appear probable at first thought—provided the roughness of the unpolished surface is not on too small a scale; for each of the incident rays in Fig. 11 is reflected from the surface just as in the case of Fig. 10, in a perfectly clean, definite way, and there is no intrinsic reason why the intensity of this elementary ray should be any more diminished than in the case of regular reflection.

A little inspection of Fig. 11, however, shows that rays Nos. 5 and 10 are twice reflected before they get fairly clear of the surface, and if one went on drawing still more incident rays and following out the figure on a still finer scale, a good many other rays would be found to be reflected two or more times before finally escaping from the surface. Such multiple reflection, of course, diminishes the intensity of the light just as in the multiple reflection from mirrors, for there is always a little absorption, selective or otherwise, at any surface however apparently opaque. Thus, while the difference in the final intensities of light regularly and diffusely reflected is not so great as might be imagined, it still does exist, and for a perfectly logical reason.

To go into the matter a little further—suppose the rough surface of Fig. 11 to be not heterogeneous, but made up of a series of grooves having cross-sections like saw teeth. On examining the reflection from such a surface we should find a rather remarkable state of affairs,

for the course of reflection would then vary very greatly with the relation between the direction of the incident light and the surfaces of the grooves in the reflecting surface.

Light coming in one direction, *i. e.*, so as to strike the inclined surfaces of the grooves, would get clear of the surface at the first reflection, and the intensity of the reflected beam would have a very marked maximum in one particular direction. A beam falling on the reflecting surface in the other direction, however—that is, on the perpendicular sides of the saw-tooth grooves, would suffer several reflections before escaping from the grooves, and hence would lose in intensity, might be changed in color, and might be considerably diffused. This sort of phenomenon one may call asymmetric reflection. As we shall presently see, it plays a somewhat important part in some very familiar phenomena.

Reflection from ordinary smooth but not polished surfaces partakes both of the nature of regular and diffuse reflection, and is, in fact, a mixture of the two phenomena, there being a general predominant direction of reflection plus a certain amount of diffuse reflection. This sort of thing is most commonly met with in practical illumination. The light from artificial illuminants usually falls on painted walls, on tinted papers with surfaces more or less regular, on fabrics and on various rough or smooth objects in the vicinity. If these surrounding surfaces are colored—as in the case discussed a little while ago—some curious results may be produced. Of course, light reflected from a colored surface is colored, as we have seen already, but the manner in which it is colored is by no means obvious.

When white light falls upon a colored surface, the re-

flection is generally highly selective as regards color. Fig. 12, from Abney's data, shows clearly enough the sort of thing which occurs. It exhibits the intensity of the reflected light in each part of the spectrum when the reflecting surface is colored. The surfaces in this case were smooth layers of pigment. Curve No. 1 is the light re-

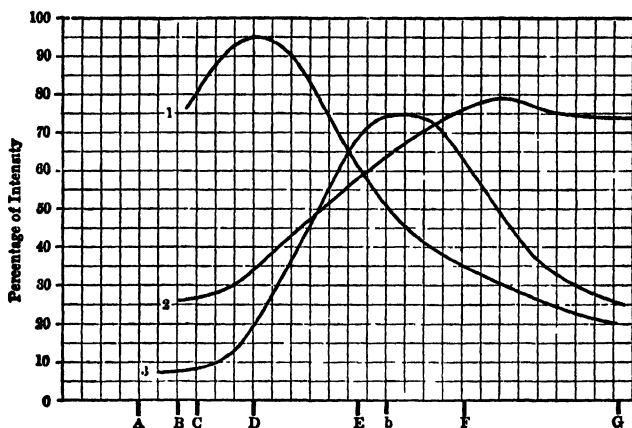

Fig. 12 — Selective Reflection.

flected from a surface painted cadmium-yellow; No. 2, Antwerp blue; No. 3, emerald green. Each curve shows a principal reflection of the color of the pigment, reaching a rather high maximum value, but falling off rapidly in parts of the spectrum other than that to which the predominant pigment color belongs. As has been already shown, pigment colors are nearly always impure, and this fact is strikingly exhibited in the shape of the curves. It is clear enough what will be the color of the main body of light reflected from any one of these surfaces.

The visible color of the light is, however, strongly influenced by the character of the surface. A shiny enamel

paint, for example, will reflect a good deal of light which is not strongly influenced by the pigment, but is reflected from the surface of the medium without much selective action; consequently, there will be in the reflected light both light which has taken the color of the pigment and light unchanged in color. In other words, when viewed by reflected light, the pigment color is mixed with white, and when we have a perfectly simple pigment color—such as is not found in practice—this would lead merely to lightening the tint. It may, however, have results much more far-reaching—for an admixture of white light in sufficient quantity would shut out the distinct perception of any color, diluting it until it becomes invisible.

The effects of this dilution are most marked in the ends of the spectrum—the colors at the middle being least affected by the admixture of white light; hence, the fact that such a surface as we have been considering, reflecting a mixture of white and colored light, may produce a change not only in tint, but in the hue of the color, if the color, as usual, is composite. For example, a purple in enamel paint might—according to its composition—look pinkish or light blue if the surface reflection of white light were particularly strong. If the pigmented surface is not shiny and capable of considerable reflection of uncolored light, another phenomenon may appear.

Fig. 13 shows curve No. 3 of Fig. 12, emerald green pigment and below it a similar curve, resulting from a second reflection of the light selectively reflected from a pigment of that color. Assuming what is nearly in accordance with the fact—that the second reflection follows closely the properties of the first—the result is obviously to intensify the green of the reflected light. The clear green portion of the light reflected from this particular



pigment is practically embraced between the dotted lines *P* and *Q* of Fig. 13. After one reflection the area under the curve embraced by these two lines is about 42 per cent. of the whole. After two reflections it has risen to 55 per cent., and each successive reflection—while greatly reduc-

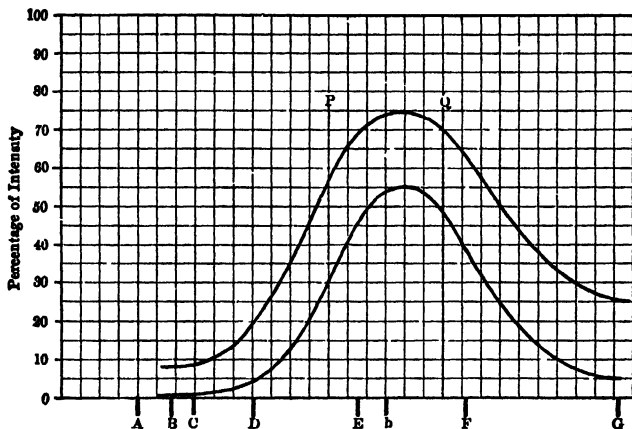

Fig. 13.—Effect of Multiple Reflection.

ing the intensity of the reflected light as a whole—will leave it greener and greener.

Consequently in diffuse reflection those rays which are reflected several times before escaping from the surface are strongly colored, and the more such multiple reflections there are the more pronounced is the selective coloration due to reflection; hence, ordinary colored surfaces, from which diffuse reflection takes place, are apt to take very strongly the color of the pigment—more strongly, perhaps, than a casual inspection of the pigment would suggest.

Now, as we shall presently see, in any enclosed space the light reflected from the bounding surfaces is a very

considerable portion of the whole, and, therefore, if these surfaces are colored, the general illumination is strongly colored also, whatever the illuminant may be; in other words, colored surroundings will modify the color of the illumination just as definitely as a colored shade over the source of light. In planning the general color tone of a room to be illuminated, it must be remembered that if the walls are strongly colored the dominant tone of the illumination will be that of the walls rather than that of the light.

An interesting corollary resulting from Fig. 13 sometimes appears in the colors of certain fabrics. If the surface fibers of the fabric lie in one general direction the light reflected from that fabric, which determines its visible color, follows somewhat the same laws laid down for asymmetric reflection, discussed in the case of Fig. 11.

Light falling on the fabric from the direction toward which the surface fibers run does not escape without profuse multiple reflection, and hence takes strongly the color of the pigment. Light, however, falling on the fabric reversely to the direction of the fibers undergoes much less multiple reflection, and is likely to be mixed with a large amount of white light hardly affected by pigment at all; hence, the curious phenomenon of changeable color in fabrics—for instance, a fine purple from one direction of illumination and perhaps very light pink from another.

If, in addition to the effects resulting from an admixture of white light in certain directions of incidence, one also has the curiously composite colors sometimes found in modern dye stuffs, the changeable color effects may be and often are very conspicuous; the more so, since in such colors, by multiple reflection, or—what amounts to the same thing—by more or less complete absorption of cer-

tain rays, the resultant color may be very profoundly changed.

Absorbing media sometimes show these color changes very conspicuously; as, for example, chlorophyll, the green coloring matter of leaves, which in a weak solution is green, but of which a very strong solution of considerable thickness transmits only the dark red rays. Similar characteristics pertain to many modern dye stuffs, and result, in connection with the composite reflection which has just been explained, in some very extraordinary and very beautiful effects.

From what has just been said about color reflection it is obvious enough that the loss in intensity in a reflected ray may be very considerable, even from a single regular reflection under quite favorable conditions. Many experiments have been made to find the absolute loss of intensity due to reflection. This absolute value of what is called the coefficient of reflection—that is to say, the ratio between the intensities of the incident and reflected light—varies very widely according to the condition of the reflecting surface. It also, in case the surfaces are not without selective reflection in respect to color, varies notably with the color of the incident light.

The following table gives a collection of approximate results derived from various sources. The figures show clearly enough the uncertain character of the data:

MATERIAL	COEFFICIENT OF REFLECTION.
Highly polished silver .....	.92
Mirrors silvered on surface.....	.70—.85
Highly polished brass... ..	.70—.75
Highly polished copper... ..	.60—.70
Highly polished steel.....	.60
Speculum metal .....	60—.80
Polished gold... ..	50—55
Burnished copper.....	40—.50

The losses in reflection are due to absorption and to a certain amount of diffuse reflection mixed with the regular reflection. The above figures are for light in the most intense part of the spectrum and for rather small angles of incidence. For large angles of incidence—85 degrees and more—the intensity of the reflected beam is materially diminished, owing probably both to increase in absorption and to diffuse reflection.

Mirrors silvered with amalgam on the back, and various burnished metals sometimes used for reflectors, belong near the bottom of the table just given. Silver is distinctly the best reflecting surface; under very favorable circumstances the coefficient of reflection of this metal is in excess of .90. A very little tarnishing of the surface results in increased absorption and diffusion and a still further reduction of the intensity of the reflected ray. The values of these coefficients show plainly the considerable losses which may be incurred in using reflectors in connection with artificial lighting.

So far as general illumination is concerned, the light diffused at the reflecting surfaces is not altogether lost, but that absorbed is totally useless. In the case of ordinary reflecting surfaces one deals with a mixture of regular and diffused reflection, and in practical illumination the latter is generally more important than the former, for it determines the amount of light which reaches the surface to be illuminated in ways other than direct radiation from the illuminant.

Obviously, if one were reading a book in a room completely lined with mirrors, the effect of the illumination upon the page would be vastly greater than that received directly from the source of light itself. On the other hand, a room painted black throughout would give very

little assistance from reflection, and the illumination upon the page would be practically little greater than that received directly from the lamp. Between these limits falls the condition of ordinary illumination in enclosed spaces. Generally speaking, there is very material assistance from reflection at the bounding surfaces. The amount of such assistance depends directly upon the coefficient of diffuse

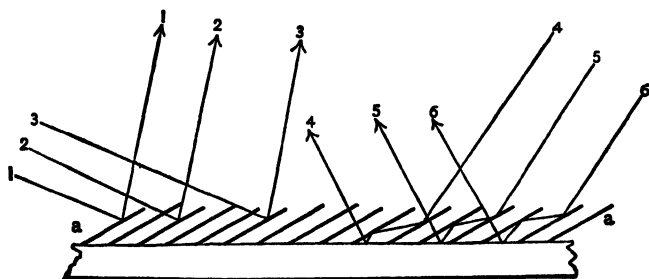

Fig. 14.—Asymmetric Reflection from a Fabric.

reflection of the various surfaces concerned, varying with the color and texture of each.

As has been already indicated, diffuse reflection is rough, heterogeneous, regular reflection, more or less complicated, according to the texture of the reflecting surface, by multiple reflections in the surface before the ray finally escapes, and therefore, the coefficients of diffuse reflection are not so widely different from those of direct reflection as might at first sight appear probable, so far at least as the total luminous effect is concerned.

In certain kinds of diffuse reflection there is considerable loss from absorption as well as from multiple reflections. This is conspicuously the case in the light reflected from fabrics, where there is not only reflection from the surface fibers, but where the rays before escaping are more than likely to have to traverse some of them. This is

illustrated in a rather crude but typical way in Fig. 14, which gives a characteristic case of asymmetric reflection. We may suppose that the beam of light falls upon a surface of fabric having a well-marked nap. In the cut *aa* is the fabric surface composed of inclined fibers or bunches of fibers. These fibers, although colored, are more or less translucent and are not colored uniformly throughout their substance. Owing to their direction, rays 1, 2, and 3 get completely clear of the surface of the fabric by a single reflection. These rays are but slightly colored, because of the comparatively feeble intensity of the coloration of the individual fibers, which have a strong tendency to reflect white light from the shiny surface.

On the other hand, rays 4, 5, and 6, inclined from the other direction, are several times reflected before clearing the surface, and in emerging therefrom have to pass through the bunches of translucent fibers that form the nap. As the result they are strongly colored. The amount of white light is very small and the structure of the surface has produced a marked changeable coloration.

In reality, of course, few rays actually escape on a single reflection, and those striking almost in line with the direction of the fibers, as 4, 5, and 6 in the figure, may be reflected many times, so that the actual effect is an exaggeration of that illustrated.

Moreover, the material of the surface fibers exercises a considerable influence on the amount and character of the selective coloration. Silk is especially well adapted to show changeable color effects, since its fibers can be made to lie more uniformly in the same direction than the fibers of any other substance, and they are themselves naturally lustrous, so as to be capable even when strongly dyed of reflecting, particularly at large angles of incidence, a very

considerable proportion of white light. Being thus lustrous they form rather good reflecting surfaces, and hence the light entangled in their meshes can undergo a good many reflections without losing so much in intensity as to dull conspicuously the resulting color effect; besides, silk takes dyes much more easily and permanently than other fibers and, hence, can be made to acquire a very fine coloration.

Wool takes dye less readily, and it is not so easy to give the surface fibers a definite direction. They are, however, quite transparent and lustrous enough to give fine rich colors. Cotton is inferior to both silk and wool in these particulars; hence, the phenomena we have been investigating are seldom marked in cotton fabrics.

In velvet, which is a very closely woven cut pile fabric, the surface fibers forming the pile stand erect and very closely packed together. It is difficult, therefore, for light to undergo anything except a very complex reflection, and practically all the rays which come from the surface have penetrated into the pile and acquired a strong coloration. The white light reflected from the surface of the fibers hardly comes into play at all except at large angles of incidence, so that the result is a particularly strong, rich effect from the dyes, particularly in silk velvet.

Cotton velvet, with its more opaque fibers, seems duller, and, particularly if a little worn, reflects enough light from the surface of the pile to interfere with the purity and intensity of the color. Much of the richness in color of rough colored fabrics and surfaces is due to the completeness of the multiple reflections on the dyed fibers, which produces an effect quite impossible to match with a smooth surface unless dyed with the most vivid pigments.

In practical illumination one seldom deals with fabrics to any considerable extent, but almost always with papered or painted surfaces. These are generally rather smooth, except in the case of certain wall papers which have a silky finish. Smooth papers and paint give a very considerable amount of surface reflection of white light, in spite of the pigments with which they may be colored. The diffusion from them is very regular, except for this surface sheen, and may be exceedingly strong. When light from the radiant point falls on such a surface it produces a very wide scattering of the rays, and an object indirectly illuminated therefore receives in the aggregate a very large amount of light.

A great many experiments have been tried to determine the amount of this diffuse reflection which becomes available for the illumination of a single object. The general method has been to compare the light received directly from the illuminant with that received from the same illuminant by one reflection from a diffusing surface.

The following table gives an aggregation of the results obtained by several experimenters, mostly from colored papers.

MATERIAL	COEFFICIENT OF DIFFUSE REFLECTION.
White blotting paper.....	.82
White cartridge paper.....	.80
Ordinary foolscap.....	.70
Chrome yellow paper.....	.62
Orange paper.....	.50
Plain deal (clean).. .	.45
Yellow wall paper.....	.40
Yellow painted wall (clean).....	.40
Light pink paper.....	.36
Yellow cardboard.....	.30
Light blue cardboard.....	.25
Brown cardboard.....	.20
Plain deal (dirty).....	.20
Yellow painted wall (dirty).....	.20
Emerald green paper.....	.18
Dark brown paper.....	.13



MATERIAL-	COEFFICIENT OF DIFFUSE REFLECTION.
Vermilion paper.....	.12
Blue-green paper.....	.12
Cobalt blue paper.....	.12
Black paper.....	.05
Deep chocolate paper.....	.04
French ultramarine blue paper... ..	.035
Black cloth.....	.012
Black velvet.....	.004

At the head of the list stands white blotting paper, which is really a soft mass of lustrous white fibers. Its coefficient of reflection—.82—is comparable with the coefficient of direct reflection from a mirror; so far, at least, as lights of ordinary intensity are concerned.

White cartridge paper is a good second, and partakes of the same general characteristics.

Of the colored papers only the yellows, and pink so light as to give a strong reflection of white light from the uncolored fibers, have coefficients of diffuse reflection of any considerable magnitude. Very light colors in general diffuse well owing to the uncolored component of the reflected light, but of those at all strongly colored only the yellows are conspicuously luminous.

Of course, all of the papers when at all dirty diffuse much less effectively than when clean, and the rough papers, which have the highest coefficients of diffusion, are particularly likely to become dirty.

A smooth, clean white board and white painted surfaces generally diffuse pretty well, but lose rapidly in effectiveness as they become soiled. Greens, reds, and browns, in all their varieties, have low coefficients, and it is worth noticing that deep ultramarine blue diffuses even less effectively than black paper coated with lamp-black, which has a diffusion of .05 as against .035 for the blue. Black cloth, with a surface rough compared with the black paper,

diffuses very much less light; while black velvet—of which the structure is, as just explained, particularly adapted to suppress light—has a coefficient of diffusion conspicuously less than any of the others. A little dust upon its surface, however, is capable of reflecting a good deal of light.

These coefficients of diffusion have a very important bearing on the illumination of interiors. It is at once obvious that—except in the case of a white interior finish or a very pale shade of color—the illumination received by any object is not very greatly strengthened by diffused light from the walls. All of the strong colors, particularly if very dark, cut down diffusion to a relatively small amount, although it is very difficult to suppress diffusion with anything like completeness.

One of the standing difficulties in photometric work is to coat the walls of the photometer room with a substance so non-reflecting as not to interfere with the measurements. Even lamp-black returns as diffused light one-twentieth of that thrown upon it, and painting with anything less lusterless than lamp-black would increase the proportion of diffused light very considerably. Walls painted dead black, and auxiliary screens, also dead black, to cut off the diffused light still more, are the means generally taken to prevent the interference of reflected light with the accuracy of the photometric measurements.

In the case of any diffusing surface, or any reflecting surface whatever, for that matter, a second reflection has, at least approximately, the same coefficient of reflection as the first, so that for the two reflections the intensity of the beam that finally escapes is that of the incident beam multiplied by the square of the coefficient of diffusion, and so on for higher powers.

Inasmuch as in any enclosed space there is considerable cross-reflection of diffused light, the difference in the total amount of illumination due to reflection is even more variable than would be indicated by the table of coefficients given; for while the amount of light twice diffused from white paper or paint would be very perceptible in the illumination, that twice diffused from paper of a dark color would be comparatively insignificant.

The color of the walls, therefore, plays a most important part in practical illumination, for rooms with dark or strongly-colored walls require a very much more liberal use of illuminants than those with white or lightly-tinted walls. The difference is great enough to be a considerable factor in the economics of the question in cases where artistic considerations are not of prime importance. The nature and amount of the effect of the bounding surfaces on illumination will be discussed in connection with the general consideration of interior lighting.

## CHAPTER IV.

### THE MATERIALS OF ILLUMINATION—ILLUMINANTS OF COMBUSTION.

At root, all practical illuminants are composed of solid particles, usually of carbon, brought to vivid incandescence. We may, however, divide them into two broad classes according as the incandescent particles are heated by their own combustion or by extraneous means. The first class, therefore, may be regarded as composed of luminous flames, such as candles, lamps, ordinary gas flames, and the like, while the second consists of illuminants in which a solid is rendered incandescent, it is true, but not by means of its own combustion.

The second class thus consists of such illuminants as mantle gas burners, electric incandescent lamps, and the electric arcs, which really give their light in virtue of the intense heating of the tips of the carbons by the arc, which in itself is relatively of feeble luminosity.

Illumination based on incandescent gas, phosphorescence, and the like is in a very early experimental stage, and while it is in this direction that we must look for increased efficiency in illumination, nothing of practical moment has yet been accomplished. To the examination of flame illuminants, then, we must first address ourselves.

They are interesting as being the earliest sources of artificial light, and while of much less luminous efficiency than the second class referred to, still hold their own in

point of convenience, portability, and ease of extreme subdivision.

We have no means of knowing the earliest sources of artificial light as distinguished from heat. The torch of fat wood was a natural development from the fire on the hearth. But even in Homeric times there is clear evidence of fire in braziers for the purpose of lighting, and there is frequent mention of torches. The rope link saturated with pitch or bitumen was a natural growth from the pine wood torch, and was later elaborated into the candle.

It is clear that both lamps and candles date far back toward prehistoric times, the lamp being perhaps a little the earlier of the two. At the very dawn of ancient civilization man had acquired the idea of soaking up animal or vegetable fats into a porous wick and burning it to obtain light, and the use of soft fats probably preceded the use of those hard enough to form candles conveniently.

The early lamps took the form of a small covered basin or jar with one or more apertures for the wick and a separate aperture for filling. They were made of metal or pottery, and by Roman times often had come to be highly ornamented. Fig. 15 shows a group of early Roman lamps of common pottery, and gives a clear idea of what they were. They rarely held more than one or two gills, and must have given at best but a flickering and smoky light. Fig. 16 shows a later Roman lamp of fine workmanship in bronze.

In very early times almost any fatty substance that would burn was utilized for light, but in recent centuries the cruder fats have largely gone out of use, and new materials have been added to the list. It would be a thankless task to tabulate the properties of all the substances which have been burned as illuminants, but those

in practical use within the century just passed may for convenience be classified about as follows :

FLAME ILLUMINANTS.

FATS AND WAXES.

Tallow (stearin).

Sperm oil.

Spermaceti.

Lard oil.

FATS AND WAXES.

Olive oil.

Whale oil.

Beeswax.

Vegetable waxes.

The true fats are chemically glycerides, *i. e.*, combinations of glycerin with the so-called fatty acids, mainly

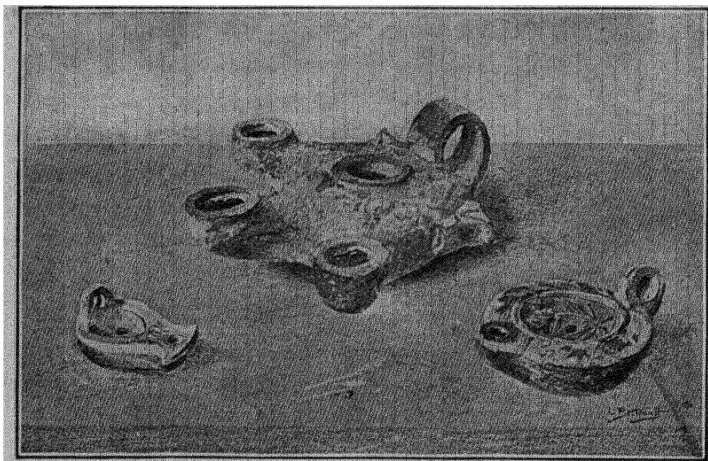

Fig. 15.—Early Roman Lamps.

stearic, oleic, and palmitic. The waxes are combinations of allied acids with bases somewhat akin to glycerin, but of far more complicated composition. Technically, spermaceti is allied to the waxes, while some of the vegetable waxes properly belong to the fats.

All these substances, solid or liquid, animal or vegetable, are very rich in carbon. They are composed entirely of carbon, hydrogen, and oxygen, and as a class have

about the following percentage composition by weight: Carbon, 76 to 82 per cent.; hydrogen, 11 to 13 per cent.; oxygen, 5 to 10 per cent.

They are all natural substances which merely require to

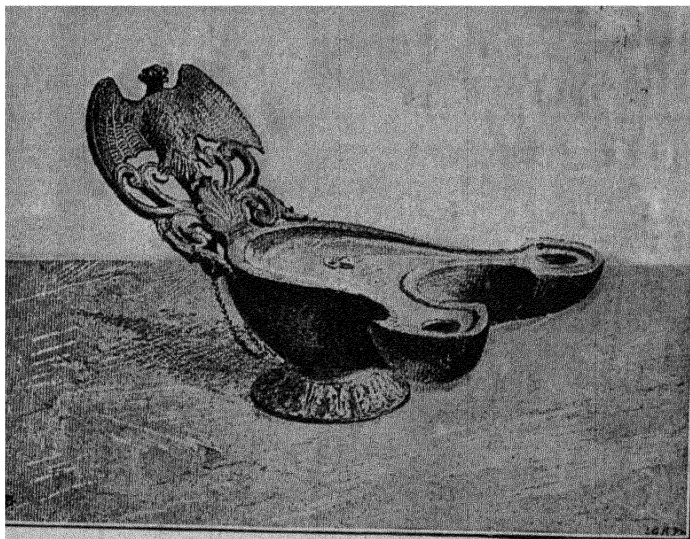

Fig. 16.—Roman Bronze Lamp.

go through a process of separation from foreign matter, and sometimes bleaching, to be rendered fit for use.

An exception may be made in favor of "stearin," which is obtained by breaking up chemically the glycerides of animal fats and separating the fatty acids before mentioned from the glycerin. The oleic acid, in which liquid fats are rich, is also gotten rid of in the commercial preparation of stearin in order to raise the melting point of the product.

In a separate class stand the artificial "burning fluids"

used considerably toward the middle of the century. As they are entirely out of use, they scarcely deserve particular classification. Their base was usually a mixture of wood alcohol and turpentine in varying proportions. From its great volatility such a compound acted almost like a gas generator; the flame given off was quite steady and brilliant, with much less tendency to smoke than the natural oils, but the "burning fluids" as a class were outrageously dangerous to use, and fortunately were driven out by the advent of petroleum and its products.

Petroleum, which occurs in one form or another at many places on the earth's surface, has been known for many centuries, although not in large amounts until recently. Bitumen is often mentioned by Herodotus and other early writers, and in Pliny's time mineral oil from Agrigentum was even used in lamps.

But the actual use of petroleum products as illuminants on a large scale dates from a little prior to 1860, when the American and Russian fields were developed with a common impulse. Crude petroleum is an evil smelling liquid, varying in color from very pale yellow to almost black, and in specific gravity from 0.77 to 1.00, ranging commonly from 0.80 to 0.90.

Chemically it is composed essentially of carbon and hydrogen, its average percentage composition being about as follows: carbon, 85 per cent.; hydrogen, 15 per cent. It is composed in the main of a mixture of the so-called paraffin hydrocarbons, having the general formula  $C_n H_{2n+2}$ , and the members of this series found in ordinary American petroleum vary from methane ( $CH_4$ ) to pentadecane ( $C_{15}H_{32}$ ), and beyond to solid hydrocarbons still more complicated.

To fit petroleum for use as an illuminant, these com-



ponent parts have to be sorted out, so that the oil for burning shall neither be so volatile as to have a dangerously low flashing point nor so stable as not to burn clearly and freely.

This sorting is done by fractional distillation. The following table gives a general idea of the products arranged according to their densities:

	SUBSTANCE.	DENSITY.	USE.
Petroleum ether...	Cymogene,	0.59	Small.
	Rhigoline,	0.63	
	Gasoline,	0.65	Gas, explosion engines.
Petroleum spirit..	Benzine naphtha,	0.68	Gas lamps, engines.
	Naphtha,	0.71	Cleaning, engines.
	Benzine,	0.74	Varnish, etc.
Kerosene.....	Kerosene of various grades,	0.78	Illumination.
		to	
		0.81	
Oils.....	Lubricating oils of various grades.	0.87	Lubrication.
		to	
		0.93	
Solids.....	Vaseline,		Emollient.
	Paraffin,		Candles, insulation, waterproofing, etc.

“Petroleum ether” and “petroleum spirit” find little use in illumination, for they are so inflammable as to be highly dangerous, and form violently explosive mixtures with air at ordinary temperatures.

Kerosene should be colorless, without a very penetrating odor, which indicates too great volatility, and should not give off inflammable vapor below a temperature of 120° F., or, better still, below 140° F. to 150° F. Oils of the latter grades are pretty safe to use, and are always to be preferred to those more volatile. The yield of kerosene from crude oil varies from place to place, but with good American oil runs as high as 50 to 75 per cent.

Paraffin is sometimes used unmixed for making candles,

but is preferably mixed with other substances, like stearin, to give it a higher melting point.

Having thus casually looked over the materials burned in candles and lamps, the results may properly be considered.

*Candles.*—These are made usually of stearin, paraffin, wax, or mixtures of the two first named. They are molded hot in automatic machines, and, as usually supplied in this country, are made in weights of 4, 6, and 12 to the pound. Spermaceti candles are also made, but are little used except for a standard of light. The English standard candle is of spermaceti, weighing one-sixth of a pound and burning at the rate of 120 grains per hour.

Commercial candles give approximately one candle-power, sometimes rather more, and burn generally from 110 to 130 grains per hour. As candles average from 15 to 18 cents per pound, the cost of one candle-hour from this source amounts to about 0.25 cent to 0.30 cent. This is obviously relatively very expensive, although it must not be forgotten that candles subdivide the light so effectively that for many purposes 16 lighted candles are very much more effective in producing illumination than a gas flame or incandescent lamp of 16 candle power.

The present function of candles in illumination is confined to their use as portable lights, for which, on the score of safety, they are far preferable to kerosene lamps, and to cases in which, for artistic purposes, thorough subdivision of the light is desirable. Where only a small amount of general light is needed, candles give a most pleasing effect and are, moreover, cleanly and odorless.

In efficiency candles leave much to be desired. For, taking the ordinary stearin candle as a type, it requires in dynamical units 90 watts per candle-power, consumes per

hour the oxygen contained in 4.5 cu. ft. of air, and gives off about 0.6 cu. ft. of carbonic acid gas. In these respects the candle is inferior to the ordinary lamp, and still more inferior to gas or electric lights. Nevertheless, it is oftentimes a most convenient illuminant.

*Oil Lamps.*—Oils other than kerosene are used in this country only to a very slight extent, the latter having driven out its competitors. Sperm oil and, abroad, colza oil (obtained from rape seed) are valued as safe and reliable illuminants for lighthouses, and in some parts of the Continent olive oil is used in lamps, as it has been from time immemorial.

Here, kerosene is still the general illuminant outside of the cities and larger towns. It has the merits of being cheap (on the average 12 cents to 15 cents per gallon in recent years), safe, *if of the best quality*, and of giving, when properly burned, a very steady and brilliant light.

All oils require a liberal supply of air for their combustion, particularly the heavier oils, and many ingenious forms of lamp have been devised to meet the requirements. On the whole, the most successful are on the Argand principle, using a circular wick with air supply both within and without, although some of the double flat wick burners are admirable in their results. A typical lamp, the familiar "Rochester," is shown in Fig. 17, which sufficiently shows the principle involved. In kerosene lamps the capillary action of the wick affords an ample supply of oil, but with some other oils it has proved advantageous to provide a forced supply. The so-called "student lamp," with its oil reservoir, is the survival of an early form of Argand burner designed to burn whale oil. In other instances clock-work is employed to pump the oil, and sometimes a forced air supply is used.

Kerosene lamps usually are designed to give from 10 to 20 candle-power, and occasionally more, special lamps giving even up to 50 or 60 candle-power. The consumption of oil is generally from 50 to 60 grains per hour per

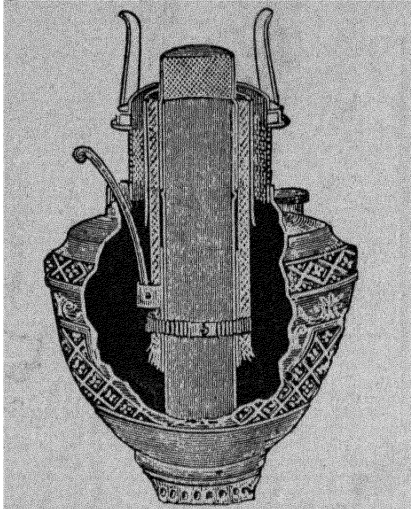

Fig. 17.—“Rochester” Kerosene Burner.

candle-power. As kerosene weighs about 6.6 pounds per gallon, the light obtained is in the neighborhood of 800 candle-hours per gallon.

This brings the cost of the candle-hour down to about 0.018 cent, taking the oil at 15 cents per gallon. No illuminants save arc lights and mantle burners with cheap gas can compare with it in point of economy.

A very interesting and valuable application of oil lighting is found in the so-called “Lucigen” torch and several kindred devices. The oil, generally one of the heavier petroleum products, is carried under air pressure in a good-sized portable reservoir, and the oil is led, with the compressed air highly heated by its passage through the apparatus, to an atomizing nozzle, from which it is thrown out

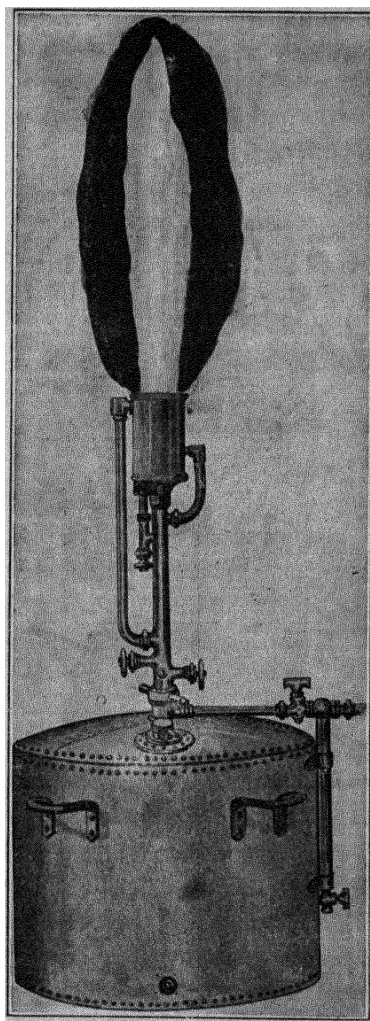

Fig. 18.—“ Lucigen ” Torch.

in a very fine spray, and is instantly vaporized and burned under highly efficient conditions.

These “ Lucigen ” torches give nearly 2000 candle-

power on a consumption of about two gallons of oil per hour, burning with a tremendous flaring flame three feet or more in length and six or eight inches in diameter. They are very useful for lighting excavations and other rough works for night labor, being powerful, portable, and cheap to operate. Fig. 18 gives an excellent idea of this apparatus in a common form. Such a light is only suited to outdoor work, but it forms an interesting transitional step toward the air-gas illuminants which have come into considerable use for lighting where service mains for gas or electricity are not available, or where the conditions call for special economy.

*Air Gas.*—It has been known for seventy years or more that the vapor of volatile hydrocarbons could be used to enrich poor coal gas, and that even air charged with a large amount of such vapor was a pretty good illuminant.

Of late years this has resulted in the considerable use of "carbureters," which saturate air with hydrocarbon vapor, making a mixture too rich to be in itself explosive and possessing good illuminating properties when burned as gas in the ordinary way. The usual basis of operations is commercial gasoline, which consists of a mixture of the more volatile paraffin hydrocarbons, chiefly pentane, hexane and iso-hexane.

The process of gas-making is very simple, consisting merely of charging air with the gasoline vapor. Fig. 19 shows in section a typical air-gas machine. It consists of a large metal tank holding a supply of gasoline, a carbureting chamber of flat trays over which a gasoline supply trickles, a fan to keep up the air supply, and a little gas reservoir in which the pressure is regulated and from which the gas is piped. The fan is driven by heavy weights, wound up at suitable intervals.

The whole gas machine is usually put in an underground chamber, both for security from fire and to aid in maintaining a steady temperature. About six gallons of gasoline are required per 1000 cu. ft. of air, and the result

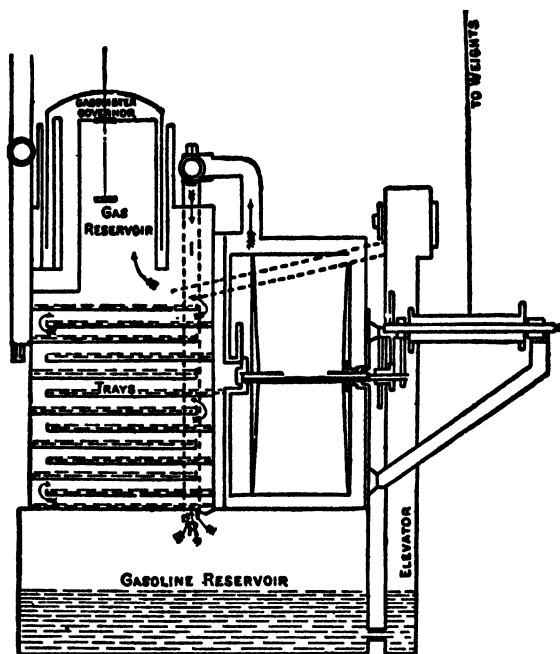

Fig. 19.—Gasoline Gas Machine.

is a gas of very fair illuminating power, rather better than ordinary city gas.

The cost of this air gas is very moderate, but on account of the cost of plant and some extra labor, it is materially greater than the cost of direct lighting by kerosene lamps. It is a means of lighting very useful for country houses and other places far from gas or electric supply companies.

The principal difficulty is the variation of the richness of the mixture with the temperature, owing to change in the volatility of the gasoline, a fault which is very difficult to overcome. At low temperatures there is a tendency to carburet insufficiently and to condense liquid in the cold pipes. The gas obtained from these machines is burned in the ordinary way, although burners especially adapted for it are extensively employed. Recently such gas has been considerably used with mantle burners, obtaining thus a very economical result.

*Coal Gas.*—In commercial use for three-quarters of a century, coal gas was, until about twenty years ago, the chief practical illuminant. Little need here be said of its manufacture, which is a department of technology quite by itself, other than that the gas is obtained from the destructive distillation of rich coals enclosed in retorts, from which it is drawn through purifying apparatus and received in the great gasometers familiar on the outskirts of every city.

The yield of gas is about 10,000 cu. ft. per ton of coal of good quality. The resulting gas consists mainly of hydrogen and of methane ( $\text{CH}_4$ ) with small amounts of other gases, the composition varying very widely in details while preserving the same general characteristics. A typical analysis of standard coal gas giving 16 to 17 candle-power for a burner consuming 5 cu. ft. per hour would be about as follows:

Hydrogen.....	53.0
Paraffin hydrocarbons .....	33.0
Other hydrocarbons. ....	3.5
Carbon monoxide.....	5.5
Carbon dioxide.....	0.6
Nitrogen.....	4.2
Oxygen.....	0.2



Ammonia compounds, carbon dioxide, and sulphur compounds are the principal impurities which have to be removed. Traces of these and of moisture are often found in commercial gas.

In point of fact, at the present time but a small proportion of the illuminating gas used in this country is un-mixed coal gas, such as might show the analysis just given. Most of it is water gas, or a mixture of coal gas and water gas. Water gas is produced by the simple process of passing steam through a mass of incandescent coal or coke, and thus breaking up the steam into hydrogen and oxygen, which latter unites with the carbon of the coal, forming carbon monoxide.

At moderate temperatures considerable carbon dioxide would be formed, but, as this is worse than useless for burning purposes, the heat is always carried high enough to insure the formation of the monoxide. The hypothetical chemical equation is :

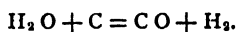

The reaction is never clean in so complete a sense as this, some  $\text{CO}_2$  always being formed. This water gas as thus formed is useless as an illuminant, and requires to be enriched by admixture of light-producing hydrocarbons—carbureted, in other words. This is done by treating it to a spray of petroleum in some form, and at once passing the mixture through a superheater, which breaks down the heavier hydrocarbons and renders the mixture stable.

There are many modifications of this system worked on the same general lines. The enriching is carried to the extent necessary to meet the legal requirements, usually producing gas of 15 to 20 candle-power for a 5-ft. jet.

A typical analysis of the water gas after enriching would show about the following by volume:

Hydrogen .....	34.0
Methane.....	15.0
Enriching hydrocarbons...	12.5
Carbon monoxide ..	33.0
Oxygen, nitrogen, etc.....	5.5
	100 0

The latter part of the enriching process, *i. e.*, superheating and breaking up the heavy hydrocarbons while in the form of vapor, is substantially that used in making Pintsch and allied varieties of oil gas, so that commercial water gas may be regarded as a mixture of water gas and oil gas.

Water gas, when properly enriched, is fully the equivalent of coal gas for illuminating purposes. The main difference between them is the very large proportion of carbon monoxide in the water gas, which adds greatly to the danger of leaks.

For this carbon monoxide is an active poison, not killing merely by asphyxia, but by a well-defined toxic action peculiar to itself. Hence persons overcome by water gas very frequently die under circumstances which, if coal gas were concerned, would result only in temporary insensibility. As the enriched water gas is cheaper than coal gas, however, the gas companies, maintaining, with some justice, that gas is not furnished for breathing purposes, supply it unhesitatingly—sometimes openly, sometimes without advertising the fact.

Very commonly so-called coal gases contain enriched water gas to bring up their illuminating power. In these cases the carbon monoxide is in much less proportion, perhaps only 12 to 15 per cent.

It is often stated that water gas is doubly dangerous

from its lack of odor. The unenriched gas is practically odorless, but when enriched the odor, while less penetrating than that of coal gas, is sufficiently distinctive to make a leak easily perceptible.

Gas burners for ordinary illuminating gas are of three general types: flat flame, Argand, and regenerative. The first named is the most common and least efficient form. It consists of two general varieties, known respectively as the "fishtail" and "bat's-wing." The former has a concave tip, usually of steatite or similar material, containing two minute round apertures, so inclined that the two little jets meet and flatten out crosswise into a wide flame. This form is now relatively little used save in dealing with some special kinds of gas.

The bat's-wing burner, with a dome-shaped tip, having a narrow slit for the gas jet, is the usual form employed with ordinary gas. Flat-flame burners work badly in point of efficiency unless of fairly large size. On ordinary gas of 14 to 17-cp nominal value on a 5-ft. burner, burners taking less than about 4 cubic ft. per hour are decidedly inefficient. A 4-ft. burner will give about 2.5 candles per foot, while a 5-ft. burner will give 2.75 to 3 candle-power per foot.

The Argand burners give considerably better results, their flames being inclosed and protected from draughts by a chimney; and the air supply being good the temperature of the flame is high and the light is whiter than in the flat-flame burners. The principle is familiar, the wick of the Argand oil lamp being replaced in the gas burner by a hollow ring of steatite connected with the supply, and perforated with tiny jet holes around the upper edge. Fig. 20 shows in section an Argand burner (Sugg's) of a standard make used in testing London gas. This burner

uses 5 cubic feet per hour, and the annular chamber has 24 holes, each 0.045" in diameter. The efficiency is a little better than that of the flat-flame burners, running, on good

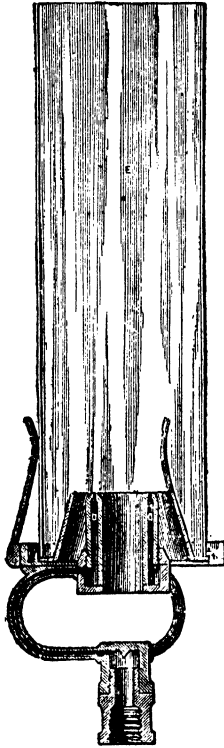

Fig. 20.—Section of Argand Gas Burner.

gas, from 3 to 3.5 candle-power per foot. The London legal standard gas is of 16 candle-power in this 5-ft. burner.

On rich gas the flat-flame burners, particularly the fish-tail, work better than the Argand, the fishtail being better on very rich gas than is the bat's-wing form. With

ordinary qualities of gas, however, the Argand burner is vastly more satisfactory than the flat flames.

For very powerful lights the so-called regenerative burners are generally preferred. These are based on the

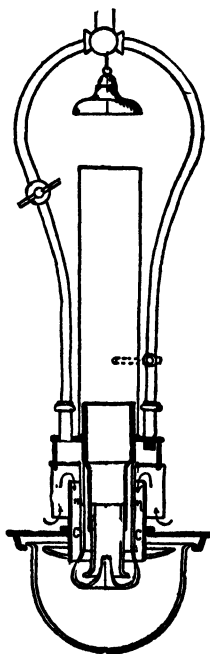

Fig. 21.—Wenham Regenerative Burner.

general principle of heating both the gas and the air furnished for its combustion prior to their reaching the flame. The burner proper is something like an inverted Argand, so arranged as to furnish a circular sheet of flame convex downward, and with, of course, a central cusp. Directly above the burner and strongly heated by the flame, are the air and gas passages.

Fig. 21 shows in section the Wenham burner of this

class. The arrows show the course of the air and the gas, the latter being burned just below the iron regenerative chamber and the products of combustion passing upward

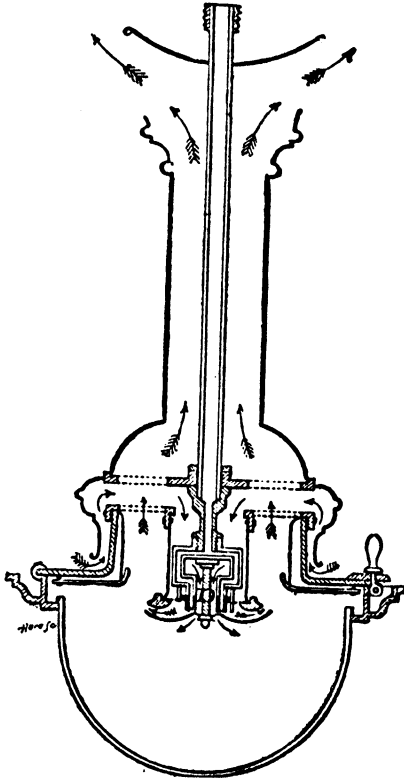

Fig 22.—Siemens Regenerative Gas Burner.

through the upper shell of the lamp, and preferably to a ventilating flue. The globe below prevents the access of cold air, and the annular porcelain reflector surrounding the exit flue turns downward some useful light.

The Siemens regenerative burner, shown in Fig. 22, is

arranged upon a similar plan and gives much the same effect. The regenerative burners of this class give a very brilliant yellow-white light with a generally hemispherical distribution downward. They work best and most economically in the larger sizes, 100 to 200 candle-power, and must be placed near the ceiling to take the best advantage of their usual distribution of light.

With gas of about 16-cp standard these regenerative burners consume only about 1 cubic foot per hour for 5 to 7 candle-power. They are thus nearly twice as economical as the best Argand burners. Their chief disadvantage lies in the fact that to get this economy very powerful burners must be used, of a size not always conveniently applicable.

From such a powerful center of light a large amount of heat is thrown off, obviously less per candle-power of light than in other gas burners, but, in the aggregate, large. Regenerative burners are well suited, however, to the illumination of large spaces, although at the present time the greater economy of the mantle burner has rather pushed the regenerative class into the background. Their light, nevertheless, is of a very much more desirable color than that given by the mantle burners.

The most recent and in some respects most important addition to the list of flame illuminants is *acetylene*. This gas is a hydrocarbon having the formula  $C_2H_2$ , which has been well known to chemists for many years, but which until recently has not been preparable by any convenient commercial process. It is a rather heavy gas, of evil odor, generally somewhat reminiscent of garlic, and, being very rich in carbon uncombined with oxygen (nearly 93 per cent. by weight) it burns very brilliantly when properly supplied with air. Its flame is intensely bright, nearly

white in color, and for the light given it vitiates the air in comparatively small degree.

Acetylene is made in practice from calcic carbide,  $\text{Ca C}_2$ , a chemical product prepared by subjecting a mixture of powdered lime and carbon (coke) to the heat of the electric furnace. By this means it can be prepared readily in quantity at moderate cost. The acetylene is made from the calcic carbide by treating it with water, lime and acetylene being the results of the reaction, which, in chemical terms, is as follows:

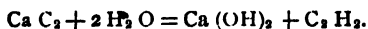

Commercial calcic carbide is far from being chemically pure, so that the acetylene prepared from it contains various impurities, and is neither in quantity nor quality just what the equation would indicate. The carbide is extremely hygroscopic, and hence not very easy to transport or keep, and the upshot of this property and the inherent impurities is that the practical yield of acetylene is only about 4.5 to 5.0 cubic feet per pound of carbide, 4.75 cubic feet being an extremely good average unless the work is on a very large scale, though 4.5 cubic feet is the more usual yield. In theory the yield should be nearly 5.5 cubic feet per pound.

The gaseous impurities are quite varied and by no means uniform in amount or nature, but the most objectionable ones may be removed by passing the gas in fine bubbles through water. If the gas is being prepared on a large scale it can readily be purified.

Acetylene has the disadvantage of being somewhat unstable. It forms direct compounds with certain metals, notably copper, these compounds being known as acetylides, and being themselves so unstable as to be easily ex-



plosive. Acetylene should be therefore kept out of contact with copper in storage, and even in fixtures.

The gas itself is easily dissociated with evolution of heat into carbon and hydrogen, and hence may be inherently explosive under certain conditions, fortunately not common.

At atmospheric pressure, or at such small increased pressures as are employed in the commercial distribution of gas, acetylene, unmixed with air, cannot be exploded by any means ordinarily at hand.

Above a pressure of about two atmospheres acetylene is readily explosive from high heat and from a spark or flame, and grows steadily in explosive violence as the initial pressure rises, until when liquefied it detonates with tremendous power if ignited. At ordinary temperatures it can be liquefied at a pressure of about 80 atmospheres, and it has been proposed to transport and store it in liquid form. But, although even when liquefied it will not explode from mechanical shock alone, it is in this condition an explosive of the same order of violence as gun-cotton or nitro-glycerine, and should be treated as such.

Mixtures of acetylene and air explode violently, just as do mixtures of illuminating gas and air. The former begin to explode rather than merely burn, when the mixture contains about one volume of acetylene to three of air, detonate very violently with about nine volumes of air, and cease to explode with about twenty volumes of air.

Ordinary coal gas begins to explode when mixed with three volumes of air, reaches a maximum of violence with about five to six volumes, and ceases to explode with eleven volumes. Of the two gases, the acetylene is rather the more violently explosive when mixed with air, and it

becomes explosive while the mixture is much leaner. The difference is not of great practical moment, however, except as acetylene generators, being easily operated, are likely to get into unskillful hands. This fact has already resulted in many disastrous explosions.

As regards its poisonous properties, acetylene seems to be somewhat less dangerous than coal gas and very much less dangerous than water gas. Properly speaking, acetylene is very feebly poisonous when pure, and has such an outrageous smell when slightly impure that the slightest leak attracts attention. Some early experiments showed highly toxic properties, but these have not been fully confirmed, and may have been due to impurities in the gas—possibly to phosphine, which is a violent poison.

The calcic carbide from which the acetylene is prepared is so hygroscopic and gives off the gas so freely that it has to be stored with great care on account of possible danger from fire. Fire underwriters are generally united in forbidding entirely the use or storage of liquid or compressed acetylene, or the storage of any but trivial amounts of calcic carbide (a few pounds) except in detached fire-proof buildings.

Acetylene is, when properly burned, a magnificent illuminant. It will not work in ordinary burners, for unless very liberally supplied with air it is so rich in carbon as to burn with a smoky flame and a deposit of soot. It must actually be mixed with air at the burner in order to be properly consumed. When so utilized its illuminating power is very great. The various experiments are not closely concordant, but they unite in indicating an illuminating power of 35 to 45 candle-hours per cubic foot, according to the capacity of the burner, the larger burners, as usual, working the more economically.

This means that the acetylene has nearly fifteen times the illuminating power of a good quality of ordinary illuminating gas when burned in ordinary burners. It will, consequently, give about eight to ten times more light per cubic foot than gas in a regenerative burner, and, it may be mentioned, about three to four times more light than gas in a mantle (Welsbach) burner.

Fig. 23 shows a common standard form of acetylene burner, intended to consume about 0.5 cubic foot per hour.

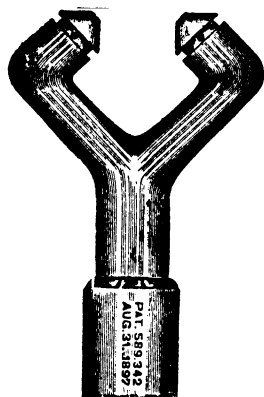

Fig. 23.—Acetylene Burner.

It is a duplex form akin in its production of flame to a common fishtail. Each of the two burners is formed with a lava tip having a slight constriction close to its point. In this is the central round aperture for the gas, and just ahead of it are four lateral apertures for the air supply. The acetylene and air mix just in front of the constriction and the two burners unite their jets to form a small, flat flame. It is in effect a pair of tiny Bunsen burners inclined to produce a fishtail jet.

Larger acetylene burners are worked on a similar principle, all having the air supply passages characteristic of

the Bunsen burner. Too great air supply for the acetylene gives the ordinary colorless Bunsen flame, but on reducing the amount the acetylene burns with a singularly white, brilliant, and steady flame.

Of acetylene generators designed automatically to supply gas at constant pressure from the calcic carbide the

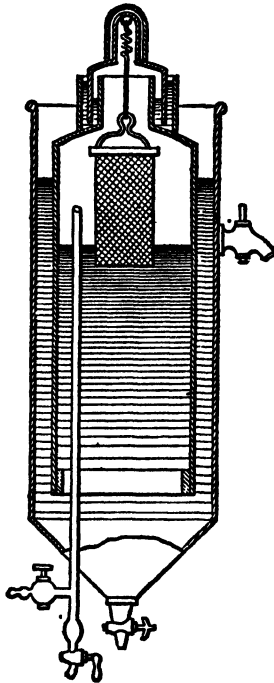

Fig. 24.—Small Acetylene Generator.

name is legion. A vast majority of those in use at present are of rather small capacity, being designed for a few lights locally or as portable apparatus for lamps used for projection. Generators on a large scale have hardly come

into use, and the problems of continuous generation have consequently not been forced into prominence.

A very useful type of the small generator is shown in Fig. 24, a form devised by d'Arsonval. It consists of a small gasometer with suitable connections for taking off the gas and drawing off the water. The bell of the gasometer is furnished at the top with a large aperture closed by a water seal. Through this is introduced a deep iron wire basket containing the charge of carbide.

The acetylene is generated very steadily after the apparatus gets to working and the pressure is quite uniform. The water in the gasometer of the d'Arsonval machine is covered by a layer of oil, which serves an important purpose. When one ceases using the gas the bell rises, and as the carbide basket rises out of the water the oil coats it and displaces the water, checking further evolution of gas. The oil also checks evaporation, so that there is no slow evolution of gas from the absorption of aqueous vapor.

As to the value of acetylene, it is evidently worth about fifteen times as much per cubic foot as gas burned in ordinary burners, or three to four times as much as gas, assuming it to be burned in Welsbach burners. Now one ton of calcic carbide of high quality, efficiently used, will produce nearly 10,000 cu. ft. of acetylene, equal in illuminating value to 150,000 cu. ft. of gas in the one case or to 30,000 to 40,000 cu. ft. in the other.

The cost of the calcic carbide is a very uncertain quantity at present. The best authorities bring the manufacturing cost, on a large scale and under very favorable circumstances, somewhere between \$30 and \$40 per ton. It is doubtful if any finds its way into the hands of bona fide users at less than about \$60 per ton, and the current price in small lots is much higher, and naturally so, by

reason of troublesome storage and the cost of transportation. Adding the necessary allowance for the cost of producing the gas from the carbide, it is at once evident that the cost of lighting by acetylene falls below that of lighting by common gas in ordinary burners at the common price of \$1 to \$1.50 per 1000 ft.

It is equally evident that it considerably exceeds the cost of gas lighting by Welsbach burners. There seems to be small chance of its coming into general competition with either at present. Its cost of production and distribution does not yet render it commercially attractive under ordinary conditions.

Nevertheless, acetylene is for use in isolated places one of the very best and most practical illuminants, for it is fairly cheap, easily made, and gives a light not surpassed in quality by any known artificial illuminant. It is peculiarly well adapted for temporary and portable use, giving as it does a very brilliant and steady light, well suited for use with reflectors and projecting apparatus, admirable in color, and very easy of operation.

## CHAPTER V.

### THE MATERIALS OF ILLUMINATION—INCANDESCENT BURNERS.

THE general class of illuminants operative by the incandescence of a fixed solid body would include in principle both arc and incandescent electric lamps, as well as those in which the radiant substance is heated by ordinary means. In this particular place, however, it seems appropriate to discuss the latter forms only, leaving the electric lights for a separate chapter.

Incandescent radiants brought to the necessary high temperature by a non-luminous flame have their origin in the so-called "Drummond" or "lime" light, which has been used for many years as the chief illuminant in projection, scenic illumination on the stage, and such like purposes, and which has only recently been extensively replaced by the electric arc. The limelight consists of a short pencil of lime against which is directed the colorless and intensely hot flame from a blast lamp fed with pure oxygen and hydrogen, or more commonly with oxygen and illuminating gas.

The general arrangement of the oxy-hydrogen burner is shown in Fig. 25. Here *A* and *B* are the supply pipes for the oxygen and hydrogen, fitted with stop-cocks. These unite in a common jet in the burner *E*, which is usually inclined so as to bring the burner where it will not cast a shadow. Sometimes the two gases are mixed in the burner tube *C*, and sometimes the hydrogen is deliv-

ered through an annular orifice about a central tube which supplies the oxygen. The pencil of lime is carried on a holder *D*, and the whole burner is often carried on an adjustable stand *E*, so that it can be raised, lowered, or

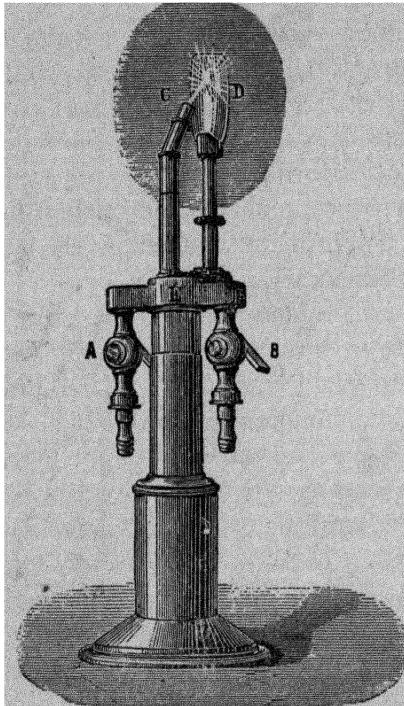

Fig. 25. Oxy-hydrogen burner.

turned, as occasion demands. The mixed gases unite in a colorless, slender flame of enormously high temperature, and when this impinges on the lime the latter rises in a small circular spot to the most brilliant incandescence, giving an intense white light of, generally, 200 to 400 candle-power.

The light, however, falls off in brilliancy quite rapidly,



particularly when the initial incandescence is very intense, losing something like two-thirds of its candle-power in an hour, so that it is the custom for the operator to turn the pencil from time to time so as to expose new portions to the oxy-hydrogen jet.

At the highest temperatures the calcium oxide is somewhat volatile and the surface seems to change and lose its radiative power. Sometimes pencils of zirconium oxide are used instead of lime, and this substance has proved more permanently brilliant and does not seem to volatilize. When properly manipulated, the calcium light is beautifully steady and brilliant, and being very portable, is well adapted for temporary use.

From time to time attempts were made to produce a generally useful incandescent lamp in which the oxy-hydrogen jet should be replaced by a Bunsen burner requiring only illuminating gas and air.

Platinum gauze and other substances were tried as the incandescent materials, but the experiments came to nothing practically until the mantle burner of Auer von Welsbach appeared. This is generally known in this country as the Welsbach light, but on the Continent as the Auer light. In this burner the material brought to incandescence is a mantle, formed like a little conical bag, of thin fabric thoroughly impregnated with the proper chemicals and then ignited, leaving a coarse gauze formed of the active material.

The composition of this material has been kept more or less secret, and has been varied from time to time as the burner has gradually been evolved into its present state, but is well known to consist essentially of the oxides of the so-called "metals of the rare earths," chiefly thorium and yttrium.

These rare earths, zirconia, thoria, glucina, yttria, and a half-dozen others still less well known, form a very curious group of chemical substances. They are whitish or yellowish very refractory oxides occurring as components of certain rare minerals, and most of them rise to magnificent incandescence when highly heated. The hue of this incandescence differs slightly for the different earths and they are very nearly non-volatile except at enormous temperatures. One, erbia, has the extraordinary property of giving a spectrum of bright bands when highly heated instead of the continuous spectrum usual to incandescent solids, a property which is shared in less degree by a few of its curious associates.

The mantle burners of the Welsbach type are formed of various blends of the more accessible of these rare earths, and when brought to incandescence by the flame of a Bunsen burner within the mantle, give a most brilliant light with a very small expenditure of gas.

As first manufactured the mantles were very fragile, breaking on the smallest provocation, but they have gradually been increased in strength until those now made generally hold together for many hundred hours, and usually should be discarded for inefficiency long before they break. This statement refers to mantles burned indoors and not subjected to any unusual vibration, which greatly shortens their life.

As at present manufactured the standard Welsbach burner complete is shown in Fig. 26, of which the several parts are distinctly labeled in the cut. It consists essentially of a Bunsen burner with provisions for regulating the flow of both air and gas, capped by fine wire gauze to prevent the flame striking back, and the mantle within which the Bunsen flame burns. There are suita-

ble supports for the chimney and shades and for the mantle.

The mantle carrier is permanently attached to a cap with a wire gauze top, and this cap goes into place on

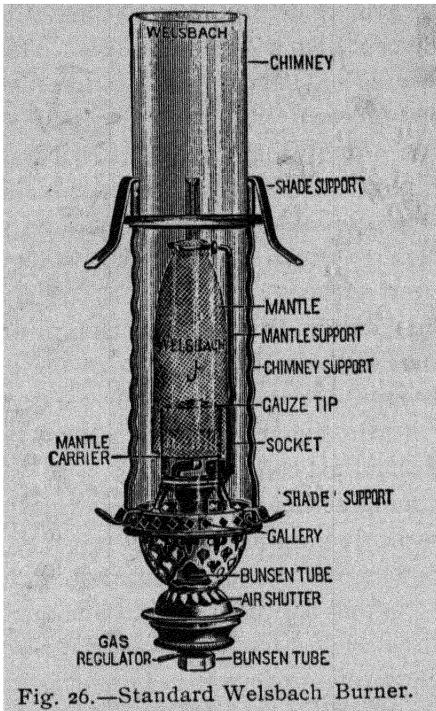

Fig. 26.—Standard Welsbach Burner.

the burner tube with a bayonet joint so that the mantle is brought exactly to the right place, instead of having to be adjusted over a permanent cap. This is one of the most important recent improvements in this type of burner, since previously the risk of breakage in adjusting a new mantle had been very considerable.

Several makes of mantle burners are in use at the present time, but the ordinary Welsbach may be con-

sidered as a type of the best modern practice, and the data here given refer to it, and are at least as favorable as would be derived from any other form.

As in most other burners, the efficiency of the mantle burner increases somewhat with the capacity, but the general result reached in common practice with 16 candle-power (nominal) gas is 12 to 15 candle-power per cubic foot of gas, assuming the mantle to be new. In other words, at the start the mantle burner is nearly

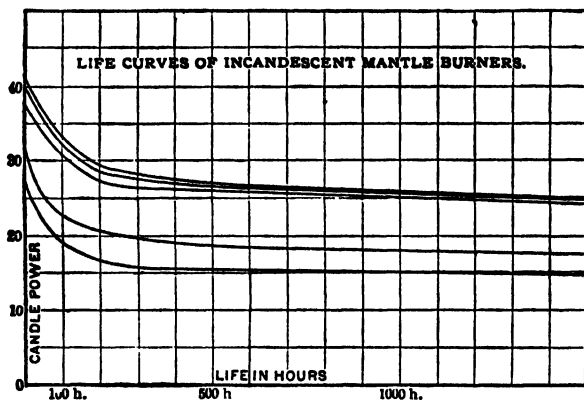

Fig. 27 — Life Curves, Welsbach Mantles.

five times as efficient as an Argand burner, about six times as efficient as an ordinary burner, and two to three times as efficient as the powerful regenerative burners.

This economy is not maintained, the efficiency of the mantle falling off with use, rapidly at first, more slowly afterwards. This is due in part to actual diminution in the radiating surface of the mantle from surface disintegration and in part to real decrease in the radiant efficiency. Fig. 27 shows a set of life curves from Welsbach burners, which are self-explanatory. In about 300 hours the efficiency has fallen off nearly one-third, after

which it decreases much less rapidly during the remainder of the life of the mantle.

This decrease in efficiency with age is similar to that found in incandescent electric lamps, but is initially more rapid. Nevertheless even after 300 hours the mantle is still good for 8 or 10 candle-power per cubic foot of gas, and remains far more efficient than any other class of gas burner. Some recent mantles are even more efficient than these figures would indicate.

The working life of the mantle is stated by Dr. Fährndrich, director of gas at Vienna, to be about 350 hours, taking due account of the decrease in efficiency. It is safe to say that averaging the working efficiency over this term of life the mantle burner with gas at \$1 per thousand cubic feet can be operated at a cost not exceeding 0.01 cent per candle-hour for gas. This should not be raised by more than 0.0025 cent for mantle renewals per candle-hour. The upshot of the matter is that the mantle burner is by far the cheapest known illuminant except the electric arc at a rather low rate for electrical energy. Obviously it uses up the oxygen and contaminates the air only in proportion to the gas used, and hence far less than other burners.

The chief objection to the mantle burner is the unpleasant greenish tinge of its light. With the early burners this was very offensive, and even with the latest forms it is so noticeable that one can walk along the street and pick out the mantle burners by the greenish cast of the illumination long before reaching the window from which they are shining.

The exact tinge of the light varies a little with the kind of mantle and the particular period of its life, but it is always distinctly greenish, sometimes bluish green,

and in recent mantles sometimes a very curious shade of yellowish green, but never yellowish like a gas flame or an incandescent lamp, or white or bluish white like an electric arc.

This color seems thus far to be inseparable from the radiation derived from any feasible combination of the rare earths used to form the mantle. Sometimes in the youth of the mantle the light seems to be nearly free from this tinge, but through change in the specific nature of the radiation or dissipation of some of the components the greenish light soon gains prominence. Whether this difficulty can be overcome in the manufacture of the mantles it is impossible to predict, but it can to a certain extent be avoided by proper shading, and shading is nearly always necessary in using mantle burners on account of their great intrinsic brilliancy.

If the exploiters of these mantle burners had spent half the time in devising remedial measures that they have wasted in denying the greenish hue of the light or in explaining that it is quite artistic and really good for the eyes, the ordinary gas burner would now be practically driven out of use.

As regards the actual color of the light from mantle burners, it varies somewhat, as already explained, but the following table is typical of the peculiarities of the light as compared with that from an ordinary gas flame. In the table the light of the gas flame is supposed to be unity for each of the colors concerned, when the light from the mantle has the given relative values.

As the actual luminosity of the deep red, blue, and violet is comparatively small in either burner, the preponderance of green in the light from the mantle is very marked.

Color .....	FULL RED	YELLOW	YELLOWISH GREEN	BLUISH GREEN	BLUE	VIOLET
Light from Mantle.....	.71	1.47	1.76	2.39	2.74	3.09
Argand taken as.....	1.00	1.00	1.00	1.00	1.00	1.00

To correct this it is necessary to use a shade of such color as to absorb some of the green rays. The actual percentage of light absorbed need not be at all large, provided the absorption is properly selective. The general color of the shade to effect this absorption will generally be a light rose pink, and the result is a fairly white light, better in color than an ordinary gas flame.

The advantage of the mantle burner in steadiness and economy is so great that there would be little reason for using the more common forms of gas burner indoors, except for their better artistic effects and for their convenience for very small lights. The color question and the fragility of the mantle have been the chief hindrances to the general introduction of the Welsbach type, and these are certainly in large measure avertable.

Recently there have been introduced several forms of mantle burner worked with gas generated on the spot from gasoline or similar petroleum products. Sometimes these are operated as individual lamps and sometimes as small systems to which the gas-forming fluid is piped. They give, of course, a fine, brilliant light, and at a low cost—cheaper than ordinary mantle burners worked with any except rather cheap gas. Where gasoline gas would be cheaper than gas taken from the nearest available main, such gasoline mantle burners will prove economical.

But, as a matter of fact, lamps locally generating and

burning their own petroleum gas have been pretty thoroughly tried from time to time during the past twenty-five years, and have never taken a strong or permanent hold on the public. It is therefore difficult to see how mantle burners worked in similar fashion are likely to take a material hold upon the art, although in special cases they may prove very useful, when illuminating gas is not available at a reasonable price.

It must be constantly borne in mind that the lighter petroleum oils are dangerous and must be used with extreme care, and also that they are just now rapidly rising in price, owing to the increasing use of explosion engines and gas machines.

In using any mantle burner it is good economy to replace the mantle after three or four hundred hours of burning, if it is in regular use to any considerable extent. Of course, in cases when a burner is not regularly used and its maximum brilliancy is not at all needed the mantle may properly be used until it shows signs of breaking. In other words, as soon as a mantle which is needed at its full efficiency gets dim, throw it promptly away; but so long as it gives plenty of light for its situation, your consumption of gas will not be diminished by a change.

The commonest trouble with mantles is blackening from a deposit of soot owing to temporary derangement of the burner. This deposit can generally be burned off by slightly, not considerably, checking the air supply so as to send up a long, colorless flame which will soon get rid of the carbon, after which the full air supply should be restored. Too great checking of the air supply produces a smoky flame.

It should finally be noted that the mantle burners are



particularly useful in cases of troublesome fluctuations in the gas supply, since while they may burn more or less brightly according to circumstances, they are entirely free from flickering when properly adjusted.

In leaving now the illuminants which depend upon the combustion of a gas or liquid, a brief summation of some of their properties may not come amiss.

The replacement of candles and lamps by gas worked a revolution, not only in the convenience of artificial lighting, but in its hygienic relations. The older illuminants in proportion to their luminous effect removed prodigious amounts of oxygen from the air and gave off large quantities of carbonic acid. In the days of candles a brilliantly lighted room was almost of necessity one in which the air was bad. The following table, due to a well-known authority on hygiene, gives the approximate properties of the common illuminants of combustion as regards their effects on the air of the space in which they are burned.

	QUANTITY CONSUMED PER HOUR	CANDLE-POWER	O REMOVED CU FT.	CO <sub>2</sub> PRODUCED CU FT	MOISTURE PRODUCED CU FT	HEAT PRODUCED CALORIES	VITATION EQUAL TO ADULT PERSONS
Tallow candles.....	2200 grains	16	10 7	7.3	8 2	1400	12 0
Sperm candles.....	1740 "	16	9 6	6.5	6.5	1137	11.
Paraffin oil.....	992 "	16	6 2	4.5	3.5	1030	7 5
Kerosene oil.....	909 "	16	5.9	4 1	3 3	1030	7 0
Coal gas, batwing.....	5 5 cu.ft.	16	6 5	2.8	7 3	1194	5.0
Coal gas, Argand.....	4 8 "	16	5 8	2.6	6 4	1240	4.3
Coal gas, Regenerative.....	3 2 "	32	3.6	1 7	4 2	760	2 8
Coal gas, Welsbach.....	3.5 "	50	4 1	1 8	4 7	763	3 0

To this it may be added that acetylene in these relations is about on a parity with the Welsbach burner, and that oil lamps other than kerosene, burning whale oil, colza oil, etc., would fall in just after candles. It is somewhat startling to realize, but very desirable to remember, that a common gas burner will vitiate the air of a room as much as four or five persons, in so far, at least, as vitiation can be defined by change in the chemical composition of the air.

In cost also the modern illuminants have a material advantage. In order of cost the list would run at current American prices of materials about as follows: Candles, animal and vegetable oils, gas in ordinary burners, kerosene, acetylene, Welsbachs. Incandescent electric lamps, it may be added, are about equivalent in cost to ordinary gas, with a tremendous hygienic advantage in their favor, while arc lamps would be the lowest on the list, assuming electrical energy relatively as cheap as dollar gas would be. As to the quality of the illumination, incandescent lamps, regenerative gas burners, and acetylene lead the list, while Welsbachs, by reason of their color, and arc lamps, from their lack of steadiness, would take a low rank.

## CHAPTER VI.

### THE ELECTRIC INCANDESCENT LAMP.

AT the present time the mainstay of electric illumination is the incandescent lamp, in which a filament of high electrical resistance is brought to vivid incandescence by the passage of the electric current. To prevent the rapid oxidation of the filament at the high temperature employed, the filament is mounted in an exhausted glass globe, forming the familiar incandescent lamp of commerce.

The first attempts at incandescent lamps were made with loops or spirals of platinum wire heated by the electric current, either in the air or *in vacuo*, but the results were highly unsatisfactory, since in the open air the wire soon began to disintegrate, and even in the absence of air its life was short. Moreover, the metal itself, being produced in very limited quantities, was expensive at best, and rose very rapidly in price under a small increase of demand. Having a fairly low specific electrical resistance, the wire used had either to be very thin, which made it extremely fragile, or long, which greatly increased its cost.

Following platinum came carbon in the form of slender pencils mounted *in vacuo*. These, however, were of so low resistance that the current required to heat them was too great to allow of convenient distribution.

To get a practical lamp it was necessary to use a fila-

ment of really high resistance, and which was yet strong enough to keep down the cost of replacements.

Without going into the details of the many experiments on incandescent lamps, it is sufficient to say that after much labor the problem of getting a fairly workable filament was solved through the persistent efforts of Edison, Swan, Maxim, Weston and others, about twenty years ago, the modern art dating from about 1880.

All the recent filaments are based on the carbonization, out of contact with air, of thin threads of cellulose—the essential constituent of woody fiber. The early work was in the direction of carbonizing thread in some form, or even paper, but Edison, after an enormous amount of experimenting, settled upon bamboo fiber as the most uniform and enduring material, and the Edison lamp came to the front commercially.

In point of fact, it soon became evident that art could produce a far more uniform carbon filament than nature has provided, so that of late years bamboo, thread, paper, and the rest have been abandoned, and all filaments, save those for some special lamps of large candle-power, are made from soluble cellulose squirted into threads, hardened, carbonized, and "treated."

Fig. 28 shows a typical modern incandescent lamp. It consists essentially of four parts; the base adapted to carry the lamp in its socket, the bulb, the filament, and the filament mounting, which includes the leading-in wires. In its original form the bulb has an opening at each end, one at the base end through which the filament and its mounting are put in place, and another in the form of a narrow tube a few inches long, which when sealed off produces the tip at the end of the bulb.

The filament is made in slightly different ways in dif-

ferent factories, and the exact details of the process, constantly subject to slight improvements. are unneces-

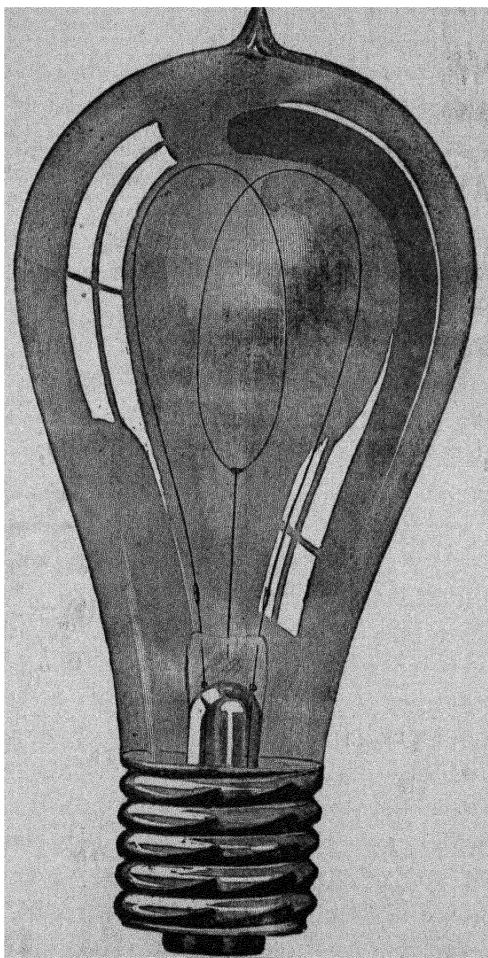

Fig 28.—Typical Incandescent Lamp.

sary here to be described. Substantially it is as follows: The basis of operations is the purest cellulose con-

venient to obtain, filter paper and the finest absorbent cotton being common starting points. The material is pulped, as in paper making, dissolved in some suitable substance, zinc chloride solution being one of those used, evaporated to about the consistency of thick molasses, and then squirted under air pressure into a fine thread, which is received in an alcohol bath to harden it.

Thus squirted through a die the filament is of very uniform constitution and size, and after carbonization out of contact with air it forms a carbon thread that is wonderfully flexible and strong. But even so, there is not yet a perfectly uniform filament, and the carbon is not dense and homogeneous enough to stand protracted incandescence.

On passage of current portions of the filament may show too low resistance, so as to be dull, or too high resistance, so as to get too hot and burn off. It is hard, too, to produce a durable filament of the somewhat porous carbon obtained in the way described.

In making up the filaments they are therefore subjected prior to being sealed into the lamp to what is known as the flashing process. This has a twofold object, to build up the filament with dense carbon, and to correct any lack of uniformity which may exist. The latter purpose is far less important to the squirted filaments than to the old filaments of bamboo fiber or thread, but the former is important in securing a uniform product. The filaments are mounted and then are gradually brought to vivid incandescence in an atmosphere of hydrocarbon vapor, produced from gasoline or the like.

The heated surface decomposes the vapor, and the carbon is deposited upon the filament in the form of a

smooth uniform coating almost as dense as graphite, and a considerably better conductor than the original filament. If, as in the early bamboo filaments, there are any spots of poorer conductivity or smaller cross section than is proper, these become hot first and are built up toward uniformity as the current is gradually raised, so that the filament is automatically made uniform.

The flashing process is actually quick, the gradual rise of current being really measured by seconds. With the squirted filaments now used the main value of the flashing process is to enable the conductivity of the filament to be quite accurately regulated, at the same time giving it a firm, hard coating of carbon that greatly increases its durability. The finished filaments are strong and elastic, generally a fine steely-gray in color, with a polished surface, and for lamps of ordinary candle-power and voltage vary from 6 to 12 ins. in length, with a diameter of 5 to 10 one-thousandths of an inch.

The filaments are joined near the base of the lamp to two short bits of thin platinum wire which are sealed through one end of a short piece of glass tube. Sometimes these platinum leading-in wires are fastened directly to the ends of the filament and sometimes to an intermediary terminal of copper wire attached to the filament. Within the tube the platinum wires are welded to the copper leads which pass down the mounting tube and are attached to the base. The filament itself is cemented to its copper or platinum wires by means of a little drop of carbon paste.

No effective substitute for platinum in sealing through the glass has yet been found, although many have been tried. Platinum and glass have very nearly the same coefficient of expansion with heat, so that the seal re-

mains tight at all temperatures without breaking away. It is possible to find alloys with nearly the right coefficient of expansion, but they have generally proved unsatisfactory either mechanically or electrically, so that the line of improvement has mainly been in the direction of making a very short seal with platinum wires.

The filament thus mounted is secured in the bulb by sealing the base of the mounting tube or lamp stem into the base of the bulb. This leaves the bulb closed except for the exhaustion tube at its tip.

The next step is the exhaustion of the bulb. This used to be done almost entirely by mercury pumps, and great pains was taken to secure a very high degree of exhaustion. It was soon found that there was such a thing as too high exhaustion, but the degree found to be commercially desirable is still beyond the easy capabilities of mechanical air pumps, at least for regular and uniform commercial practice, although they have been sometimes successfully used.

At the present time the slow though effective mercury pump is being to a very large extent superseded by the Malignani process, or modifications thereof. The bulbs are rapidly exhausted by mechanical air pumps, and when these have reached the convenient limit of their action the residual oxygen is chemically absorbed by the gas produced by the vaporization of a small quantity of a solution previously placed in a tubulaire connected with the exhaustion tube. The exact nature of the solution used is at the present time a trade secret, but phosphorus and iodine are said to form the basis of its composition. The process is cheap, rapid, and effective, and with a little practice the operator can produce exhaustion that is almost absolutely uniform.



Whatever be the method of exhaustion, during its later stages current is put on the filaments both to heat them, and thus to drive out the occluded gases, and to serve as an index of the exhaustion. When exhaustion is complete the leading-in tube is quickly sealed off, and the lamp is done, save for cementing on the base and attaching it to the leads that come from the seal. After this the lamps are sorted, tested, and made ready for the market.

The shape of the filament in the lamp was originally a simple U, later often modified to a U with a quarter-twist so that the plane of the loop at the top was 90 degrees from its plane at the base. As the voltage of distribution has steadily crept upwards from 100 to 110, 120, 140, and even 250 volts, it has been necessary either to increase the specific resistance of the filament, to decrease its diameter, or to increase its length, in order to get the necessary resistance to keep the total energy, and likewise the temperature of the filament, down to the desired point.

But the modern flashed filament cannot be greatly increased in specific resistance without impairing its stability, so the filaments have been growing steadily finer and longer. At present their form is various, according to the judgment of the maker in stowing away the necessary amount of filament within the bulb.

One very common form is that of Fig. 28, where the filament has a single long convolution anchored to the base at its middle point for mechanical steadiness. Sometimes there are two convolutions, or even more, and sometimes there is merely a reduplication of the old-fashioned simple loop, as in Fig. 29.

The section of the filaments is now always circular,

although in the early lamps they were sometimes rectangular or square.

There has been a considerable fog of mystery about incandescent lamp practice for commercial purposes, but

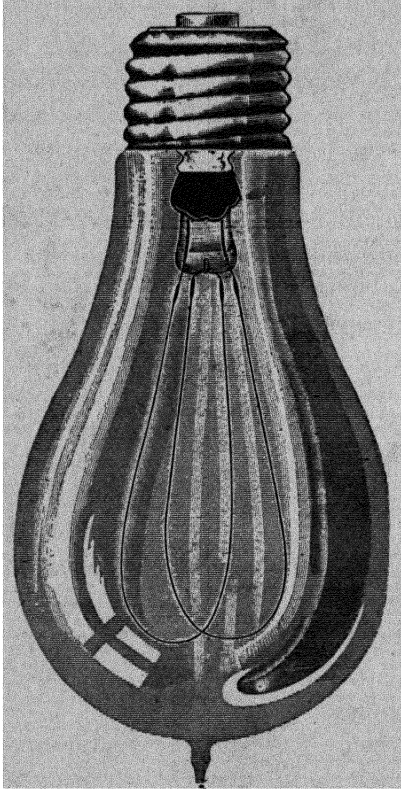

Fig. 29.—Lamp with Double Filament.

the general facts are very firmly established and by no means complicated, and a little consideration of them will clear up much of the haze.

To begin with, it is not difficult to make a good fila-

ment, but it takes much skill and practice to produce, in quantity, one that shall be uniformly good. The quality of the lamps as to durability and other essentials depends very largely on the care and conscientiousness of the maker in sorting and rating his product.

It is practically impossible, for example, to make, say, 10,000 filaments, all of which shall give 15 to 17 horizontal candle-power at a particular voltage, say, 110. With great skill in manufacture, half or rather more will fall within these limits, the rest requiring anywhere between 100 and 120 volts to give that candle-power. Only a few will reach these extremes, the rest being clustered more or less closely around the central point.

The value of the lamps as sold depends largely on what is done with the varying ones and how carefully they are sorted and rated. If the lamps demanded on the market were all of 110 volts, then there would be a large by-product which would either have to be thrown away, sold for odd lamps of uncertain properties, or slipped surreptitiously into lots of standard lamps.

But some companies use lamps of 108 or 112, or some neighboring voltage, and part of the product is exactly fitted to their needs, and so forth, there being involved only some slight difference in efficiency, not important if similar lamps from other lots are conscientiously rated along with them.

The basic facts in incandescent lamp practice are two: First, the efficiency, *i. e.*, the ratio of energy consumed to light given per unit of surface, depends mainly on the temperature to which the filament is carried; second, the total light given is directly proportional to the filament surface which radiates this light. The specific radiating power of modern carbon filaments is substantially the

same, so that if one has two filaments of the same surface brought to the same temperature of incandescence they will work at substantially the same efficiency and give substantially the same amount of light.

And if a filament of a certain surface be brought to a certain temperature it will give a definite total amount of light, utterly irrespective of the form in which the filament is disposed. Changes in the form of the filament will produce changes in the distribution of the light in different directions around the lamp, but will not in the least change the total luminous radiation. Much of the current misunderstanding is due to neglect of this simple fact.

The nominal candle-power of the lamp depends upon a pure convention as to the direction and manner in which the light shall be measured in rating the lamp, and makers have often sought to beat the game by disposing the filament so as to exaggerate the radiation in the conventional direction of measurement.

For example: Many early incandescent lamps had filaments of square cross section bent into a single simple U. These gave their rated candle-power in directions horizontally 45 degrees from the plane of the filaments, and this was the maximum in any direction, so that the lamp when thus measured was really credited with its maximum candle-power, and fell below its rating in all directions save the four horizontal directions just noted.

It is customary to delineate the light from an incandescent lamp in the form of closed curves, of which the various radii represent in direction and length the relative candle-power in those various directions. Such curves may be made to show accurately the distribution

of light in a horizontal plane about the lamp, or the distribution in any vertical plane, and from the average radii in any plane may be deduced the mean candle-power in that plane, while from a combination of the

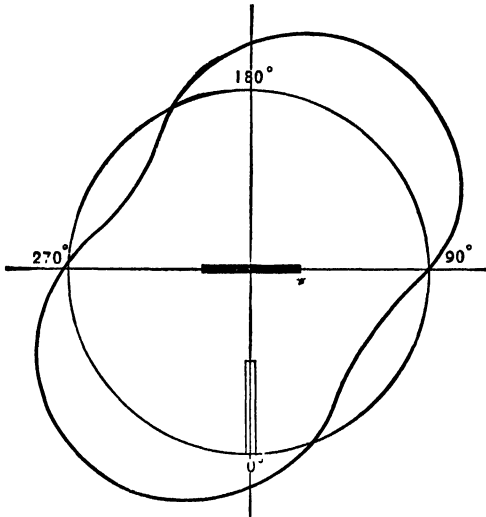
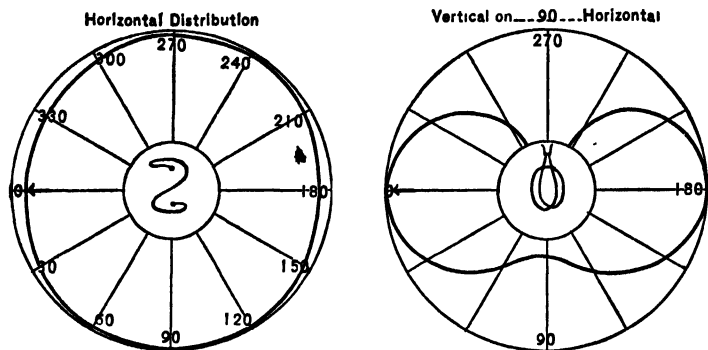

Fig. 30.—Distribution of Light from Flat Filament.

radii in the various planes may be obtained the mean spherical candle-power which measures the total luminous radiation in all directions.

This last is the true measure of the total light-giving power of a lamp. Fig. 30 illustrates the curve of horizontal distribution for one of the early lamps, having a flat U-shaped filament. The circle is drawn to show a uniform 16 candle-power, while the irregular curve shows the actual horizontal distribution of light. This particular lamp overran its rating, but its main characteristic is that it gave a strong light in one horizontal diameter and a weak one in the diameter at right angles to this.

Such a distribution as this is generally objectionable, and most modern filaments are twisted or looped, so that the horizontal distribution is nearly circular. Fig. 31 shows a similar curve for a recent 16-cp lamp of the type shown in Fig. 28. In the small inner circle is shown the projection of the looped filament as one looks down upon the top of the lamp. Fig. 32 shows



Figs. 31 and 32.—Distribution of Light from Looped Filament.

a similar delineation of the distribution of light in a vertical plane taken in the azimuth shown in Fig. 31, with the socket up.

The looping of the filament is such that the horizontal distribution is very uniform, while in the vertical downwards there is a marked diminution of light, and of course in the direction of the socket much of the light is cut off. The total spherical distribution, if one can conceive it laid out in space in three dimensions, resembles a very flat apple with a marked depression at the blossom end and a cusp clear in to the center at the stem end. Fig. 33 is an attempt to display this spherical distribution to the eye.

If the filament were a simple U or the double U of Fig.

29, assuming the same total length and temperature of filament, the apple would have still greater diameter, but the depression at the blossom end would be considerably wider and deeper.

If the filament has several convolutions, as in Fig. 34, this depression is considerably reduced, but there is a

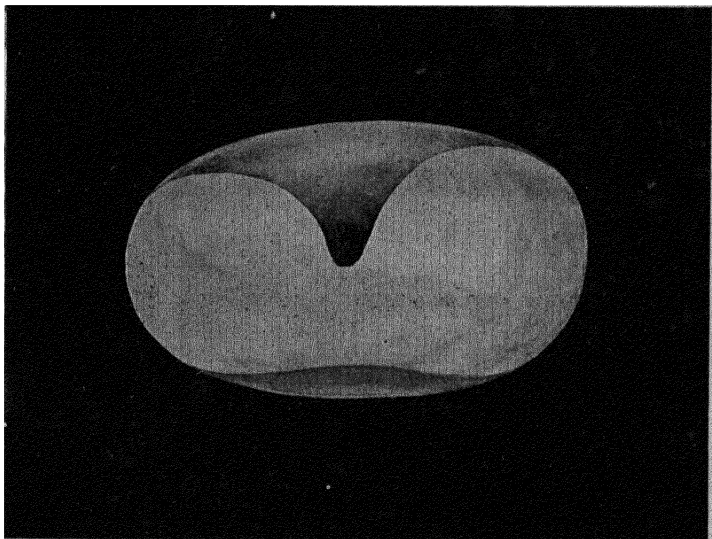

Fig. 33.—Distribution of Light from Incandescent Lamp.

marked flattening in one horizontal direction, so that the horizontal distribution would somewhat resemble Fig. 30. But the total luminous radiation would be quite unchanged.

If the lamps were rated by their mean horizontal candle-power the U filament would show abnormally large horizontal illumination for the energy consumed, and would apparently be very efficient, while if one were foolish enough to rate lamps by the light given off the

tip alone, Fig. 34 would show great efficiency, the distribution in one horizontal diameter having been reduced to fatten the curve at the tip. In reality, however, each one of the three forms of lamp would have exactly the

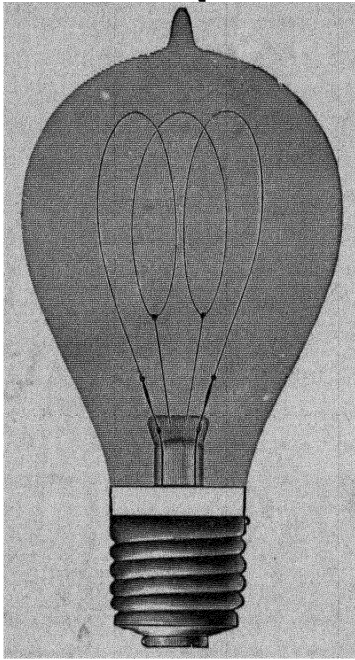

Fig. 34.—Lamp with Multiple-Looped Filament.

same efficiency, and in practice there would be little choice between them.

In the every-day work of illumination incandescent lamps are installed with their axes in every possible direction, the vertical being the rarest, and angles between 30 degrees and 60 degrees downwards from the horizontal the commonest.

Bearing in mind this general distribution of the axes and the fact that diffusion goes very far toward oblit-



erating differences in the spherical distribution as regards general illumination, it is easy to see that the shape of the filament is, for practical purposes of illumination, of little account. In the few cases where directed illumination is needed it is best secured by a proper reflector, which gives far better results than can be obtained by juggling with the shape of the filament.

The thing of importance is to get uniform filaments of first-class durability, and of as good efficiency as possible. The only proper test for efficiency, however, is that based on mean spherical candle-power, since a lamp will give a different apparent efficiency for each direction of measurement, varying from zero in the direction of the socket to a maximum in some direction unknown until found.

Efficiency has most often been taken with respect to the mean horizontal candle-power. But this leads to correct relative results only when comparing lamps having filaments similarly curved. The mean spherical candle-power is usually from 80 to 85 per cent. of the mean horizontal candle-power, a ratio larger than is found in the case of any other artificial illuminant.

As regards efficiency, most commercial incandescent lamps require between 3 and 4 watts per mean horizontal candle-power. Now and then lamps are worked at 2.5 watts per candle when used with storage batteries, and some special lamps, especially some of those made for voltages above 200, range over 4 watts per candle. As has already been remarked, the efficiency depends upon the temperature at which the carbon filament is worked. And it is in the ability to stand protracted high temperature that filaments vary most.

It is comparatively easy to make a filament which will

stand up well when worked at 4 watts per candle, but to make a good 3-watt per candle filament is a very different proposition. Also, at low voltage, 50 volts for instance, the filament is more substantial than the far slenderer one necessary to give the requisite resistance for use at the same candle-power at 100 or 125 volts.

Under protracted use the filament loses substance by slow disintegration and by a process akin to evaporation, so that the surface changes its appearance, the resistance increases so that less current flows, the efficiency consequently falls off, and the globe shows more or less blackening from an internal deposit of carbon.

The thinner and hotter the filament the less its endurance and the sooner it deteriorates or actually breaks down. Modern carbons have by improved methods of manufacture been developed to a point that in the early days of incandescent lighting would have seemed beyond hope of reach. But the working voltage has steadily risen and constantly increased the difficulties of the manufacturer.

So-called high efficiency lamps worked at about 3 watts per candle power require the temperature of the filament to be carried so high that its life is seriously endangered unless it be of fair diameter; hence such lamps are hard to make for low candle-power or for high voltage, either of which conditions requires a slender filament—in the former case to limit the radiant surface, in the latter to get in the needful resistance. An 8-cp 125-volt lamp, or a 16-cp 250-volt lamp presents serious difficulties if the efficiency must be high, while conversely lamps of 24 or 32 candle-power are far more easily made for high voltage.

The annexed table gives a clear idea of the performance of a modern lamp under various conditions of working. It is from tests made on a 16-cp 100-volt lamp (so-called) by Professor H. J. Weber. The effective radiating surface of the filament in this lamp was 0.1178 square inch, so that the intrinsic brilliancy was over 250 candle-power per square inch.

AMPERES	VOLTS	WATTS	CP	WATTS PER CP	TEMPERATURE
0.421	77.19	32.51	2.99	10.87	1464°C.
0.443	80.89	35.85	4.13	8.67	1483
0.467	84.80	39.58	5.60	7.07	1503
0.490	88.83	43.55	7.41	5.88	1522
0.513	92.87	47.70	9.71	4.91	1541
0.536	96.71	51.84	12.42	4.18	1557
0.559	100.60	56.21	15.76	3.57	1574
0.582	104.58	60.90	19.70	3.09	1591
0.605	108.60	65.78	24.25	2.71	1607
0.629	112.57	70.85	29.41	2.41	1621

The absolute values of the temperatures here given are the least exact part of the table, but the relative values may be trusted to a close approximation. Fig. 35 shows in graphical form the relation between the last two columns, showing clearly how conspicuously the efficiency rises with the temperature. At the upper limit given the carbon is too hot to give a long life, although the writer has seen modern lamps worked 12 volts above their rating for several hundred hours before rapid breakage began. Of course the brilliancy had fallen off greatly, however, by that time.

It is worth noting from the table that for a 16-cp lamp of ordinary voltage the candle-power varies to the extent of quite nearly one candle-power per volt, for moderate changes of voltage from the normal. Weber calls attention to the fact that between 1400 degrees and

1650 degrees an increase in temperature of  $n$  degrees corresponds very closely to a saving in energy of  $n$  per cent. in the production of light.

If it were possible to carry the temperature still higher without seriously impairing the stability of the filament, lamps of a very high economy could be produced. It is possible to force lamps up to an economy of even 1.5 watts per candle temporarily, but they often break al-

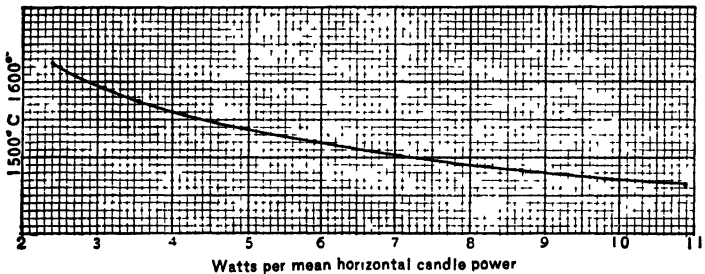

Fig. 35.—Variation of Efficiency with Temperature.

most at once, and even if they hold together they rise to 2 or 2.5 watts per candle within a few hours.

To tell the truth, the temperature corresponding to 1.5 watts per candle is dangerously near the boiling point of the material, so near that it is practically hopeless to expect any approximation to such efficiency from carbon filaments, and even at 2.5 watts per candle the life of the lamps is so short that at present prices they cannot be used commercially.

From such experiments as those tabulated it has been shown that the relation between the luminous intensity and the energy expended in an incandescent lamp may be expressed quite nearly by the following formula:

$$I = aW^3,$$

wherein  $I$  is the candle-power,  $W$  the watts used, and  $a$  is a quantity approximately constant for a given type of lamp, but varying slightly from type to type.

Following the universal rule of incandescent bodies, the radiation from an incandescent lamp varies in color with the temperature, and thus as the voltage changes, or what is about the same thing, as lamps of different efficiencies are used, the color of the light varies very conspicuously. Low efficiency lamps, or lamps in a low stage of incandescence, such as is indicated in the first four lines of the table, burn distinctly red or reddish orange. Then the incandescence passes through the various stages of orange yellow and yellow white until a 3-watt lamp is nearly and a 2.5 watt lamp purely and dazzlingly, white. The color is a good index of the efficiency.

The sizes of incandescent lamps in fairly common use are 8, 10, 16, 20, 24, and 32 candle-power. The standard in this country is the 16-cp size, a figure borrowed from the legal requirements for gas. Some 10 candle-power are used here, very few 8 candle-power, and still fewer of candle-powers above 16. Abroad 8-cp lamps are used in great numbers and with excellent results. The 20-cp and 24-cp lamps are found mostly in high voltages, for reasons that will appear shortly. Four and 6-cp lamps are now and then used for decorative purposes or for night-lights, and excellent 50-cp lamps are available for cases requiring radiants of unusual power.

Lamps of these various sizes are made usually for voltages between 100 and 120 volts, and more rarely for 220 to 250 volts, but in the latter case lamps below 16 candle-power are almost unknown in America.

One hundred and ten volts was for some years the standard pressure here, and with this as a basis one may profitably see what are the problems to be met in lamp construction. At this voltage the filament of a 16-cp lamp is 6 or 8 inches long and .008 to .01 inch in diameter, and ordinarily has a resistance when hot of nearly 200 ohms. Now to produce an 8-cp lamp of the same voltage and efficiency the energy consumed must be reduced by one-half, and so also must be the radiating surface. This means that the filament resistance must be doubled, and the radiating surface so adjusted by varying the length, diameter, and specific resistance as to give the required candle-power.

The latter two factors can be varied during the process of flashing, since the carbon deposited thus is denser and of lower specific resistance than the original squirted core. The net result is a filament considerably slenderer than the 16-cp filament and usually of less stability. On the other hand, in making a 32-cp lamp the filament may conveniently be made longer, thicker, and more durable. In lamps of higher voltage the filaments must be of much higher resistance, and hence longer and thinner, until at 220 volts the 16-cp lamp must have four times the resistance of its 110-volt progenitor, and commonly has a total length of filament of 12 to 15 inches.

In lamps of small candle-power or of high voltage there is some temptation to get resistance by flashing the filaments less thoroughly, to the detriment of durability, since the soft core disintegrates more readily than the hard deposited carbon, which may explain the frequent inferiority of such lamps. The greater the candle-power, and the less efficiency required, *i. e.*, the greater

the permissible radiating surface, the easier it is to get a strong and durable filament for high voltages. Hence, lamps for 220 to 250 volts are generally of at least 16 candle-power, very often of 20 or 24 candle-power, and seldom show an efficiency better than 4 watts per candle-power.

This forms a serious practical objection to the use of such lamps for general distribution, unless with cheap water-power as the source of energy, and while improved methods of manufacture are likely somewhat to better these conditions, yet there are inherent reasons why it should be materially easier to produce durable and efficient incandescent lamps of moderate candle-power and voltage than lamps of extreme properties in either of these directions.

The life of incandescent lamps practically depends on the temperature at which they are worked, other things being equal. There is a steady vaporization and disintegration of the carbon from the moment the lamp is put into service, which ends in a material increase in the resistance of the filament with accompanying decrease of the current, energy, temperature, efficiency, and light.

If the lamp is started at a low efficiency the temperature is relatively low and the decadence of the filament is retarded, while if the lamp is initially of high efficiency the filament under the higher temperature deteriorates more rapidly and the useful life of the lamp is shortened.

Under this latter condition the cost of energy to run the lamp is diminished, but at the price of increased expense in lamp renewals. Operating at low efficiency means considerable cost for energy and low cost of the

lamp renewals. Between these divergent factors an economic balance has to be struck.

It is neither desirable nor economical to operate an incandescent lamp too long, since not only does it decrease greatly in efficiency, but the actual light is so dimmed that the service becomes poor. If the lighting of a room is planned for the use of 16-cp lamps, and they are used until the candle-power falls to, say, 10, which would be in about 600 hours in an ordinary 3-watt-per-candle lamp, the resulting illumination would be altogether unsatisfactory. Quite aside from any consideration of efficiency, therefore, it becomes desirable to throw away lamps of which the candle-power has fallen below a certain point.

Much of the skill in modern lamp manufacture is directed to securing the best possible balance between efficiency and useful life, a thing requiring the best efforts of the manufacturer. Fig. 36 shows graphically the relation between life, candle-power, and watts per candle derived from tests of high-grade foreign lamps. In comparing these, like the previous data, with American results, it should be borne in mind that these foreign tests are made, not in terms of the English standard candle, but generally in terms of the Hefner-Alteneck standard, which is somewhat (approximately 10 per cent.) smaller.

These curves show the results from lamps having an initial efficiency of 2.5, 3.0, and 3.5 watts per candle-power and an initial candle-power of 16. They show plainly the effect of increased temperature on the life of the lamp, and it is unpleasantly evident that in the neighborhood of 3 watts per candle a point is reached at which a further increase of efficiency produces a disastrous result upon the life. In other words, that ef-



efficiency requires a temperature at which the carbon filament rapidly breaks down.

And so long as carbon is used as the radiant material there is a strong probability that there can be no very radical improvement in efficiency. Of course, if incan-

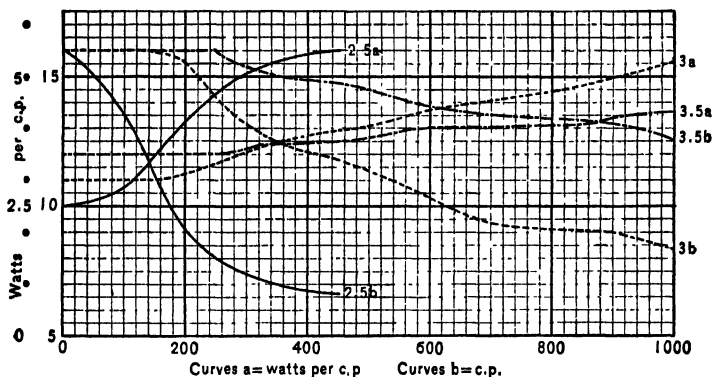

Fig. 36.—Curves Showing Life, Candle-power and Watts per Candle.

descent lamps were greatly cheapened, it would pay to burn them at a higher efficiency and to replace them oftener. It is quite possible that increased experience and persistent efforts at standardization might lead to this result.

In production on a large scale the mere manufacture of the lamps can be done very cheaply, probably at a cost not exceeding 7 to 8 cents, but the cost of proper sorting and testing to turn out a uniform high-grade lamp, and the incidental losses from breakage and from lamps of odd and unsalable voltages, raises the total cost of production very materially. Much of the reduction in the price of incandescent lamps in the past few years has resulted from better conditions in these latter respects, as well as from the improved methods of manufacture.

And it should be pointed out that the difference between good and bad lamps, as practically found upon the market, lies mostly in their different rates of decay of light and efficiency. It is the practice of many of the large lighting companies who renew the lamps for which they furnish current to reject and replace lamps which have fallen to about 80 per cent. of their initial power.

First-class modern lamps worked in the vicinity of 3 watts per candle-power will hold up for 400 to 450 hours before falling below this limit, and at 3.5 or 3.6 watts per candle-power will endure nearly double that time. They are often rated in candle-hours of effective life, and on the showing just noted the recent high efficiency lamp will give a useful life of 6500 to 7000 candle-hours, with an average economy of perhaps 3.25 watts per candle. A medium grade lamp of similar nominal efficiency may not show with a similar consumption of energy more than 250 or 300 hours of effective life—say 4000 to 4500 candle-hours.

The economics of the matter appear as follows: The first lamp during its useful life of, say 6500 candle-hours, will consume 21.125 kilowatt-hours, costing at, say, 15 cents per kilowatt-hour, \$3.17, and adding the lamp at 18 cents, the total cost is \$3.35, or 0.0515 cent per candle-hour, while the poorer lamp at 4000 candle-hours will use \$1.95 worth of energy, and at 18 cents for the lamp, would cost 0.0532 cent per candle-hour. To bring the two lamps to equality of total cost, irrespective of the labor of renewals, the poorer one would have to be purchased at 11 cents. In other words, poor lamps, if discarded when they should be, generally so increase the cost of renewals that it does not pay to use them at any

price at which they can be purchased under ordinary circumstances.

As has already been explained, lamps deteriorate very rapidly if exposed to abnormal voltage, and the higher the temperature at which the lamp is normally worked the more deadly is the effect of increased voltage. It thus comes about that if high efficiency lamps are to be used, very good regulation is necessary. Occasional exposure to a 5 per cent. increase of voltage may easily halve the useful life of a lamp, while, of course, permanent working at such an increase would play havoc with the life, cutting it down to 20 per cent. or less of the normal. Good regulation is therefore of very great importance in incandescent lighting, not only to save the lamps and to improve the service, but to render feasible the use of high efficiency lamps. On the whole, the best average results seem to be obtained in working lamps at 3 to 3.5 watts per candle. Those of higher efficiency fail so rapidly that it only pays to use them when energy is very expensive and must be economized to the utmost. The 2.5-watt lamp of Fig. 36, for example, has an effective life of not more than 150 hours, at an average efficiency of about 2.75 watts per candle. A 2-watt lamp will fall to 80 per cent. of its original candle-power in not far from 30 hours, at an average efficiency of about 2.25 watts, while if started as a 1.5-watt lamp, in a few hours the filament is reduced to practical uselessness.

There is seldom any occasion to use lamps requiring more than 3.5 watts per candle-power, save in case of very high voltage installations, where the saving in cost of distribution may offset the cost of the added energy. The difficulty of making durable 250-volt lamps on account of the extreme thinness of the filament has been

already referred to, and it is certainly advisable to use in such installations lamps of 20 candle-power or more whenever possible, thus making it practicable to work at better efficiency without increased risk of breakage. Even when power is very cheap there is no object in wasting it, and a little care will generally procure regulation good enough to justify the employment of incandescent lamps of good efficiency.

Further, in the commercial use of lamps it is necessary for economy that the product should be uniform. It has already been shown that medium grade lamps are characterized by a shorter useful life than first-class lamps. Unfortunately, there are on the market much worse lamps than those described. It is not difficult to find lamps in quantity that are so poor as to fall to 80 per cent. of their initial power in less than 100 hours. A brief computation of the cost of replacement will show that these are dear at any price. Now, if lamps are not carefully sorted, a given lot will contain both good lamps and poor lamps, and will not only show a decreased average value, but will contain many individual lamps so bad as to give very poor and uneconomical service. Fig. 37 shows what is sometimes known as a "shotgun diagram," illustrating the variations found in carelessly sorted commercial lamps. In this case the specifications called for 16-cp, 3.5-watt per candle-power lamps. The variation permitted was from 14.5 to 17.5 mean horizontal candle-power, and from 53 to 59 total watts, which is a liberal allowance, some companies demanding a decidedly closer adherence to the specified limits.

The area defined by these limits is marked off in the cut, forming the central "target." The real measure-

ments of the lamps tested are then plotted on the diagram and the briefest inspection shows the results. In this case only 46 per cent. of the lamps hit the specifica-

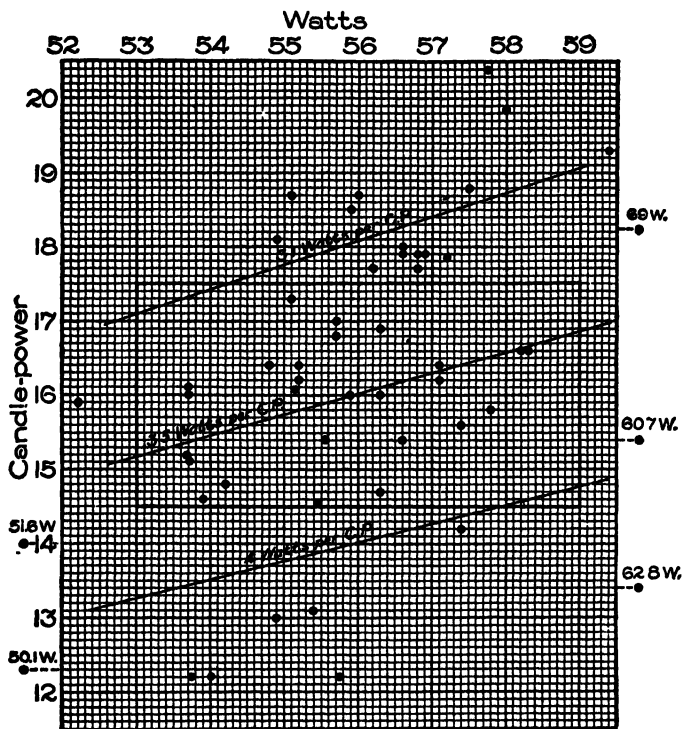

Fig. 37.—Shotgun Diagram

tions. All lamps above the upper slanting line are below 3.1 watts per candle-power, and hence are likely to give trouble by falling rapidly in brilliancy and breaking early. Lamps below the lower slanting line are over 4 watts per candle-power, hence are undesirably inefficient. Moreover, the initial candle-power of the lot varies from 12.2 candle-power to 20.4 candle-power.

Such a lot will necessarily give poorer service and less satisfactory life, and is, as a matter of dollars and cents, worth much less to the user than if the lamps had been properly sorted at the factory. Filaments cannot be made exactly alike, and the manufacturer has to rely upon intelligent sorting to make use of the product. For example, the topmost lamp of Fig. 37 should have been marked for a lower voltage, at which it would have done well. Nearly all the lot would have properly fallen within commercial specifications for 16-cp lamps at some practicable voltage and rating in watts per candle-power. The imperfect sorting has misplaced many of the lamps and depreciated the whole lot.

In commercial practice lamps should be carefully sorted to meet the required specifications, and the persons who buy lamps should insist upon rigid adherence to the specifications and should, in buying large quantities, test them to ensure their correctness. To sum up, it pays to use good lamps of as high efficiency as is compatible with proper life, and to see that one gets them.

The real efficiency of an incandescent lamp, *i. e.*, the proportion of the total energy supplied which appears as visible luminous energy, is very small, ordinarily from 4 to 6 per cent., not over 6.5 per cent. even in a 3-watt per candle-power lamp. This means that in working incandescent lamps from steam-driven plants not over 0.5 per cent. of the energy of the coal appears as useful light. This is a sad showing, and one which should spur invention. To get better results, it seems necessary to abandon the carbon filament, at least in any form in which we now know it, and either to turn to some other material for the incandescent body, or to abandon the

principle of incandescence altogether and pass to some form of lamp in which the luminosity is not due to the high temperature of a solid radiant. The writer is strongly disposed to think that the ultimate solution lies in the latter alternative, although the former offers hope of very considerable and perhaps revolutionary improvements.

Within the past few years a large number of attempts have been made at preparing a filament for incandescent lamps of some material far more refractory than pure carbon, and hence better able to endure the high temperature necessary for securing high efficiency. A glance at the temperature curve, Fig. 35, shows that a rise of 200 degrees C. or so in the working temperature would produce an efficiency of nearly or quite one candle-power per watt.

These attempts have been of several kinds. One method has been to incorporate refractory material with the carbon in manufacturing the filaments, thus both increasing the resistance of the filaments and giving them a certain proportion of heat-resisting substances. Owing, however, to the fact that such filaments still contain a considerable proportion of carbon which is comparatively easily vaporized, there is good reason to doubt the efficacy of the process. The carbon, which is the cement, as it were, once disintegrated, the filament would give way, and experience up to date has tended to throw doubt on the success of any such scheme.

An interesting modification of this method is that proposed by Langhans, who forms filaments of carbide of silicon, *i. e.*, employs carbon in chemical combination instead of merely as a species of cement. This process has not been carried to commercial success, but it cer-

tainly looks more hopeful, on general principles, than the process of incorporation.

Another line of attack on the problem is that of Auer von Welsbach, who proposed a filament of platinum or similar metal, coated with thoria, the rare earth which is the chief constituent of the Welsbach mantle. This looks mechanically dubious. Still another modification of this idea is the use of a filament mainly of carbon, but with a coherent coating of thoria or the like, a line of investigation which appears worth pursuing. Akin to this is the Nernst lamp, which is at present exciting great interest, although it is barely yet in the commercial stage. The basic fact on which Dr. Nernst's work is founded is that many substances, non-conductors at ordinary temperatures, become fairly good conductors when heated. Thus a tiny pencil of lime, magnesia, or the rare earths, when once heated, will allow a current to pass at commercial voltages sufficient to maintain it at vivid incandescence. From this fundamental fact Nernst has developed a most interesting and promising glow lamp.

The variation of resistance with temperature in such substances as the rare earths as used by Nernst is truly prodigious. They seem really to pass from insulators to conductors. Even glass, in fact, conducts fairly well at high temperatures, although in all such cases conduction is probably, at least in part, electrolytic in its character, a fact which is of considerable practical moment. As developed by Nernst the filaments when cold have several hundred times the resistance which they have when hot. Fig. 38 shows graphically from Nernst's tests the way in which the specific resistance falls off as the temperature rises. From the somewhat meager data it is



of necessity only approximate, but it gives a vivid idea of the extraordinary nature of the phenomenon. Of course, carbon shows a great decrease of resistance when hot, but it is a pretty fair conductor when cold, while the Nernst filament is practically an insulator in that

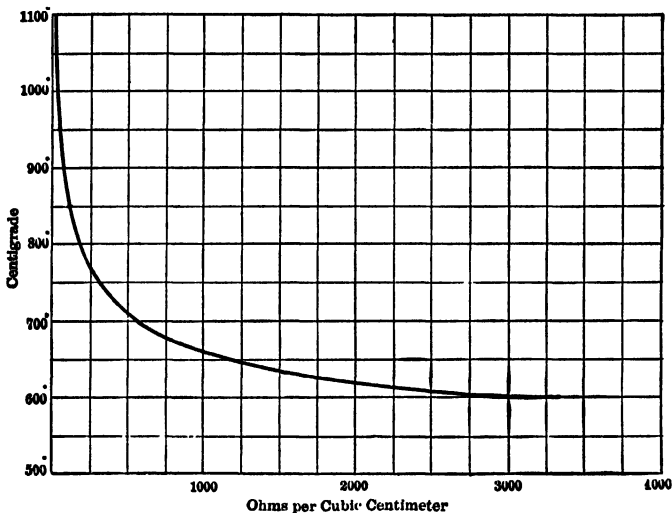

Fig. 38.—Curve of Resistance Variation.

condition. But the oxides of the Nernst filament are enormously more refractory than carbon, and can not only be carried to far higher incandescence without breaking down, but probably have, at least in some of the combinations used, a rather more efficient distribution of energy in the spectrum than is the case with carbon.

But being an insulator at ordinary temperatures some means has to be taken to get current through the filament. It has long been known in a general way that magnesia and similar materials conduct at a high tem-

perature, and both Le Roux and Jablochhoff had dabbled with the idea years ago. But Nernst took up the matter anew and in earnest. The lamp which he has produced consists essentially of a thin pencil of mixed oxides, forming the incandescent body. This pencil is much thicker and shorter than a carbon filament as used

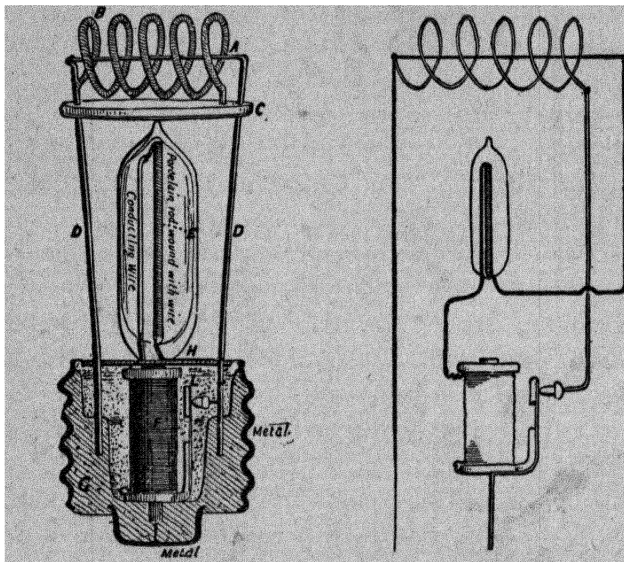

Fig 39 and 40.—Connections of Nernst Lamp.

in incandescent lamps, being, say, from 1-64 to 1-16 inch in diameter, and 3-4 to 1 1-2 inch long. If heated by a match or spirit lamp the filament becomes a conductor, and goes to vivid incandescence. Such artificial heating being somewhat of a nuisance, much of the work spent in developing the Nernst lamp has been in the direction of providing means for artificial lighting. As developed abroad the self-lighting Nernst lamp has taken the form shown in Fig. 39. Rising from the base of the lamp G

are two stiff wires, *DD*, spaced near the ends by a porcelain disk *C*. Across the platinum tips of these rods is fastened the glower *A*, secured at its terminals by conducting cement. Coiled in loose turns about the glower is a porcelain spiral *B*, into the surface of which has been baked a fine platinum wire closely coiled around it. The office of this resistance spiral is to bring the glower to a temperature at which it begins to conduct. At the start *A* and *B* are in shunt, but when current gets fairly started through the former it energizes a tiny electro-magnet, *F*, situated in the base of the lamp, its armature *L* is attracted and the circuit through *B* broken, turning the whole current through *A*.

At *E* is a very interesting and important feature of the lamp. It is a "ballast" resistance of fine iron wire wound upon a porcelain rod and sealed into a little bulb to prevent oxidation. It is connected in series with the filament. Now iron has a resistance that increases rapidly with the temperature, and this increase is particularly rapid at about 450 to 500 degrees C. This resistance coil is designed so that with normal current in the lamp the temperature will rise to the point noted, and its office is to steady the lamp. Without it the Nernst lamp would be terribly sensitive to variations in voltage, but if the voltage rises with this resistance in circuit, its increasing resistance chokes the current. Even with this steadying element the Nernst lamp is still somewhat sensitive to changes of voltage. The glower does not function properly in an exhausted globe, and must be worked in the free air, although a glass shade is provided to protect it from draughts, dust, etc. In point of fact, protection from draughts is at present rather necessary, since the filament is so sensitive to

changes in temperature that it can readily be blown out by the breath. Fig. 40 gives a clear idea of the connections of the lamp of Fig. 39, while Fig. 41 shows

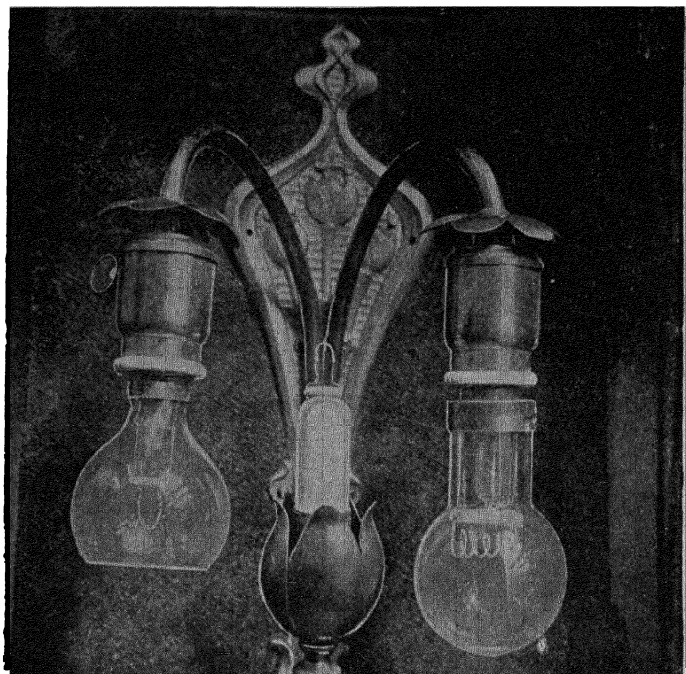

Fig. 41. Nernst Lamps.

complete at the left, one of the earlier Nernst lamps without the automatic lighting device.

The foreign manufacturers of these lamps are producing them of 25, 50, and 100 candle-power, for 110- and 220-volt circuits. The Nernst principle lends itself more readily to powerful high-voltage lamps than to small low voltage ones, and the glower is found to work better on alternating than on continuous-current circuits,

apparently for reasons depending on the electrolytic nature of the conduction. Like other incandescent lamps, it works the more efficiently as the temperature rises, but owing to its refractory composition the Nernst filament can be pushed to very high efficiency. As the lamps are produced at the present time their initial efficiency is about 1.50 to 1.75 watts per candle, including the energy lost in the steadying resistance (about 10 per cent.), and the useful life is said to be about 300 hours. The filament at the end of this time rises in resistance and falls in efficiency, much like an ordinary incandescent filament, but rather more suddenly.

The real life of a Nernst lamp, when defined as it should be in terms of, say, a 20-per-cent. drop in candle-power, is not at the present time known. It has only been put upon the market abroad within the present year, and the owners of the American rights have not yet put lamps out in large commercial quantities, so that really accurate data are entirely lacking as yet.

The American Nernst lamp, as developed in the Westinghouse laboratory, retains all the general features of the foreign lamps, but is modified in some important details. It has been so designed as to give a considerably longer life at a slightly lower efficiency. The heaters are good-sized simple cylinders of porcelain, instead of spirals, and are placed close to and above the glower. The unit is a single 50-cp glower, but it is found that from the higher working temperature and better conservation of heat in a multiple glower lamp a better efficiency is obtained, so that the ordinary sizes are those with two, three, and six glowers, rated respectively at 100, 170, and 400 candle-power. This rating is in the direction of maximum intensity.

Fig. 42 shows the heaters and glowers of these lamps assembled on a porcelain cap with connection wires which automatically make all the necessary connections when the holder is pushed into its base. Thus far only the single glower lamp is made for 110 volts, the others being for 220 volts. Fig. 43 shows the general appearance of the lamps as fitted for indoor use.

					MEAN INTENSITY IN H. U.						WATTS PER MEAN H. U.					
					Spherical			Lower Hemisphere			Spherical			Lower Hemisphere		
	Voltage	Current	Watts	Power Factor	Opal Outer	Clear Outer	Shade	Opal Outer	Clear Outer	Shade	Opal Outer	Clear Outer	Shade	Opal Outer	Clear Outer	Shade
†6-Glower	220	2.35	517	1.0	149*	—	147	240*	—	270	347*	—	35	2.15*	—	1.85
A. C. Arc	110	6.29	417	.6	130	159	152	—	190	254	321	262	249	—	2.23	1.48
D. C. Arc	110	4.9	539	1.0	177	207	—	—	272	—	303	2.60	—	—	1.98	—

An opal inner globe or heater-case was used in all cases except the four readings marked.\*

\* A clear heater-case and sand-blasted spherical globe were used.

† Rated at 400 cp.

The foregoing table gives its performance as compared with alternating current and direct current enclosed arc lamps, the intensities being in Hefner units. From this it appears that the Nernst lamp is fairly comparable in efficiency with the enclosed arcs, while giving a steadier light decidedly better in color.

The distribution of light from these lamps is obviously somewhat peculiar. It is specially strong in the lower hemisphere, being designed with downward illumination in mind. The horizontal distribution from a single glower, as determined by M. Hospitalier, is shown in

Fig. 44. The glower was horizontal and the measurements were taken in the horizontal plane passing through it. The section of the glower appears in the center of the diagram. Broadside on this glower gave about 40 cande-power; when nearly end on, about 10 candle-power.

After about 100 hours' run the inner globe or "heater-case" becomes darkened by a deposit from the glower and its platinum contacts and from the heaters, and has

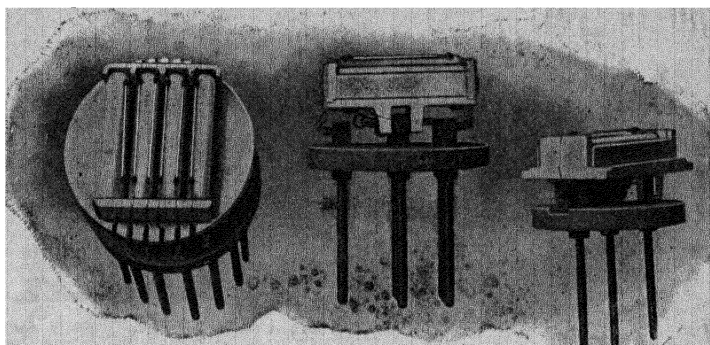

Fig. 42.—Glowers and Heaters of American Nernst Lamp.

to be cleansed, so that with respect to care the new lamp resembles arcs rather than incandescents. The effective life of the glowers is said to be about 800 hours, the efficiency holding up pretty well until they break. The intrinsic brilliancy of the glower is very great, 1000 to 1250 cp per square inch. Hence the shading of Nernst lamps by diffusing globes or other screens must be very thorough, so as to cut down the intolerable brightness of the glower itself.

The automatic lighting device seems to work well, bringing the lamp up to full brilliancy in not far from

half a minute. On continuous current the life of the glower is very greatly reduced, probably to one-third its normal duration, so that at present the device belongs essentially to alternating current distributions, and the life also tends to increase with the frequency,

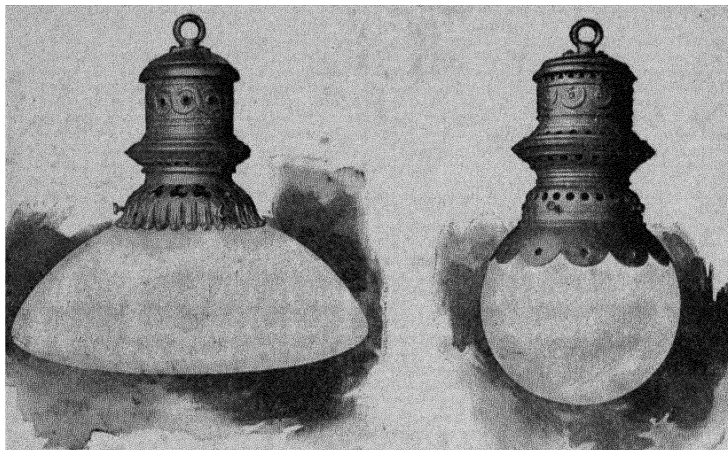

Fig. 43 —Types of Indoor Lamps.

so that the very low frequency circuits are somewhat at a disadvantage in using Nernst lamps.

It seems, however, certain that the Nernst lamp is an important addition to the art within at least a limited sphere of usefulness.

The glower can be replaced at a moderate cost, ultimately below the cost of replacement of incandescent lamps of equivalent candle-power, so that even with a rather short life of the glower the lamp would still be economical in use. While less efficient than the best arc lamps, it compares favorably with enclosed arcs of moderate amperage, and it is just now to be regarded



rather as a competitor of the arc than of the glow lamp. However, it would take no great advance to change this condition, and the ease with which Nernst lamps may be made for high voltage is a rather important matter. If one institutes a comparison on the basis of 250-volt lamps the result is very greatly in favor of the Nernst

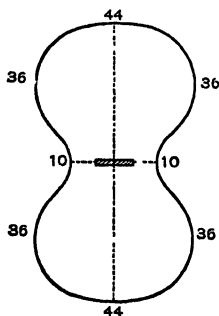

Fig. 44.—Horizontal Distribution from Nernst Lamp.

filament at any reasonable estimate of its life. As in ordinary lamps so with Nernst lamps, filaments for small candle-power involve unusual difficulties, but at present the 16-cp lamp should be taken as the normal glow lamp, while with the Nernst lamp perhaps 50-cp may be regarded as the normal unit glower.

At present one must regard the Nernst lamp as in a tentative condition, and various problems regarding it must be threshed out—in particular there should be radical improvement in the automatic lighting device or such evolution of a filament of higher initial conductivity as will obviate further necessity for special lighting devices. But a highly efficient and very easily replaced incandescent body is in itself a material advantage over the delicate filament and exhausted globe of the ordinary incandescent lamp, and unless the Nernst lamp shall

develop some unexpected limitation, it must be looked upon as a competitor of the incandescent that, although not now serious, may become so at any time, and perhaps to a very material extent.

Following up the question of higher luminous efficiency than that given by the incandescent lamp, one naturally turns to the vacuum tube, in which the illuminant is not a heated solid, but an incandescent gas. It has long been well known that an electric discharge passed through a tube of highly rarefied gas causes the tube to become the seat of very brilliant luminous phenomena. The light produced, however, does not form a continuous spectrum, as does an incandescent solid, but gives a spectrum of bright bands or lines. This fact of itself gives some hope of efficiency, for it is the plentiful production of useless wave lengths that renders an ordinary incandescent body so inefficient a source of light. If a gas could be found giving a brilliant spectrum of bands, all of useful wave lengths, one might expect that a considerable proportion of the energy applied to the tube would turn up as useful illumination. Or if not a single gas, then a combination of gases might be found such as would answer the purpose. During the past ten years much work has been put in along this line by Mr. Tesla and others, but as yet without the production of a commercial lamp, although very magnificent effects have been produced experimentally.

The difficulties which have been met are, first, the need under ordinary conditions of rather high voltage in the discharge, the difficulty of obtaining a steady light of good color, and, most of all, the production of anything like a practicable intrinsic brilliancy. The brightness of an ordinary vacuum tube is apt to be greatly overrated,

seen as it usually is with the room otherwise in darkness, and a tallow candle will make a pretty bright vacuum tube look pale as a wisp of fog.

Now, low intrinsic brilliancy is not in itself at all objectionable, but in the matter under discussion it connotes a radiant of large dimensions. This means that either there must be an enormous multiplicity of small tubes or else a few tubes so large as to involve rather high electromotive force in driving the discharge through them. In large tubes the light is generally very unsteady, and the best effects seem to be gotten from long coiled tubes of small diameter, which are not easy to excite. As to color, there is a strong tendency toward a bluish or greenish hue, which will have to be removed before a practical lamp is produced. It is easy to find gaseous mixtures free from this objection, but perhaps at a considerable loss of efficiency or other disadvantage. The otherwise promising mercury vapor lamp is extremely bad in color.

The efficiency of the light produced by vacuum tubes has been several times measured. It appears that the luminous efficiency, that is, the proportion of radiant energy from the tube which is of luminous wave lengths, is something like 25 or 30 per cent., five or six times better than in case of the incandescent lamp.

If the tubes are forced to anything like the intrinsic brilliancy of even the dullest flames, secondary phenomena involving heating seem to arise, considerably decreasing the efficiency, so that it seems to be still a long step from our present vacuum tubes to "light without heat." This "light without heat" implies radiant energy that is nearly or quite all luminous. But this condition might be fulfilled and the light yet be most

impractical, as, for example, in a sodium flame, which gives an effect altogether ghastly. Any monochromatic light is utterly destructive of color, but it might be possible so to combine nearly monochromatic lights of the primary red, blue, and green as to obviate this difficulty. Or, it may be eventually possible to excite luminous radiation in gases or even in solids so as to get results quite different from the ordinary spectra of the bodies. The vacuum tube lamp is probably capable of development into a commercial method of illumination for some purposes, but in any form in which it has yet been suggested it must be regarded rather as a stepping-stone on the way toward light without heat than as the thing itself. It is given this place in a discussion of practical illuminants, not on account of its present position, but because the author is very strongly of the opinion that it may advance to some degree of importance at almost any moment, and because it gives promise of an efficiency considerably beyond anything which has hitherto been reached in artificial illuminants.

But it may be that we must look to the chemist rather than the electrician for the final word as to illumination. It is well within the bounds of possibility that some exaggerated phosphorescence may be found which will enable us to store solar energy directly for use at night. Or the firefly may give up his secret and teach us how to get light by chemical changes at low temperatures. And the firefly knows. The light emitted by such light-giving insects is unique and most extraordinary in its properties. For so far as can be ascertained the total radiant energy lies within the limits of the visible spectrum, and not only there, but in the most brilliant part thereof. No similar distribution of radiant energy

is elsewhere known. The ordinary firefly of this country is typical of the whole class, giving a greenish-white light that, when examined in the spectroscope, shows a brilliant band extending over the yellow and green and fading rapidly as the red and blue are approached.

Professor S. P. Langley has carefully investigated the radiation from *Pyrophorus noctilucus*, a West Indian species which attains a length of 1 1-2 inch, and of which a half dozen specimens in a bottle give sufficient light for reading. These insects gave spectra bright enough to permit careful investigation, and by comparison with solar light reduced to the same intensity, Langley found the curves shown in Fig. 45. Here *B* is the light radiated by the insect and *A* solar light. The curves show by the ordinates at each point the relative intensities of the various parts of the spectra.

It at once appears that the light of *Pyrophorus* includes much the less range of color, and is much the richer in yellow and green. The maximum intensity is very near the beginning of the clear green (at about wave length 5500), and the light extends only a little way into the red and the blue. Fig. 45, which shows the apparent distribution of light indicated by the two curves, exhibits the narrow limits of the radiation from *Pyrophorus* very clearly. The spectrum is practically limited by the solar lines *C* and *F*, and Langley's most careful experiments showed nothing perceptible outside of these limits, a most remarkable state of affairs, quite standing alone in our knowledge of radiation.

For equal light Langley found that *Pyrophorus* expends only about 1-400 of the energy required by a candle or gas flame. This fact gives us a clew to the efficiency of *Pyrophorus* as a light producer. It appears

to be about five candles per watt, perhaps even a little better—fifteen or twenty times the efficiency of an incan-

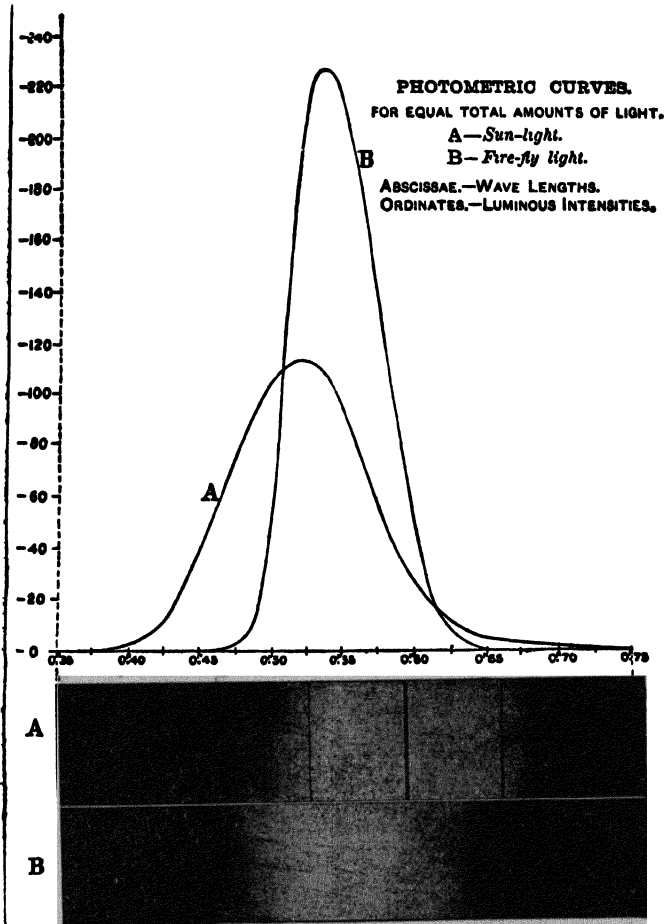

Fig. 45.—Curves of Firefly Light and Solar Light.

descent lamp, about four times the efficiency of an arc lamp at its best. It is a startling lesson. The light-giving

process of *Pyrophorus* is apparently the slow oxidation of some substance produced by it. Even if this substance could be reproduced in the laboratory the light would be too nearly monochromatic to be satisfactory as an illuminant, but it presumably is within the range of possibility to obtain a combination of phosphorescent substances which would give light of better color at very high efficiency.

Certainly the problem is a most fascinating one, and whether the ultimate solution lies in vacuum-tube lighting or in some form of phosphorescence, one may say with an approach to certainty that all forms of incandescence of highly heated solids are too inefficient in giving light to approach the economy desirable in an artificial illuminant. Indeed, a solid substance of great light-giving efficiency, when heated to incandescence, would be somewhat of an anomaly, since it would probably have to possess an enormous specific heat at moderate temperatures. What is really needed is some method, chemical or electrical, of passing by the slow vibrations that characterize radiant heat and stirring up directly vibrations of the frequency corresponding to light. The vacuum tube gives the nearest approach to a solution of this problem yet devised, but it still leaves much to be desired, and there is plenty of work for the investigator.

## CHAPTER VII.

### THE ELECTRIC ARC LAMP.

THE electric arc is the most intense artificial illuminant and the chief commercial source of very powerful light. A full account of it would make a treatise by itself, so that we can here treat only the phases of the subject which bear directly on its place as a practical illuminant. First observed probably by Volta himself, the arc was brought to general notice by Davy in 1808 in the course of his experiments with the great battery of the Royal Institution. If one slowly breaks at any point an electric circuit carrying considerable current at a fair voltage the current does not cease flowing when the conductor becomes discontinuous, but current follows across the break with the evolution of great heat and a vivid light. If the separation is at the terminals of two carbon rods the light is enormously brilliant, and by proper mechanism can be maintained tolerably constant. The passage of the current is accompanied by the production of immense heat, and the tips of the carbon rods grow white hot, and serve as the source of light. In an ordinary arc lamp the upper carbon is the positive pole of the circuit, and is fed slowly downward, so as to keep the arc uniform as the carbon is consumed. The main consumption of energy appears to be at the tip of this positive carbon, which is by far the most brilliant part of the arc, and at which the carbon fairly boils away into



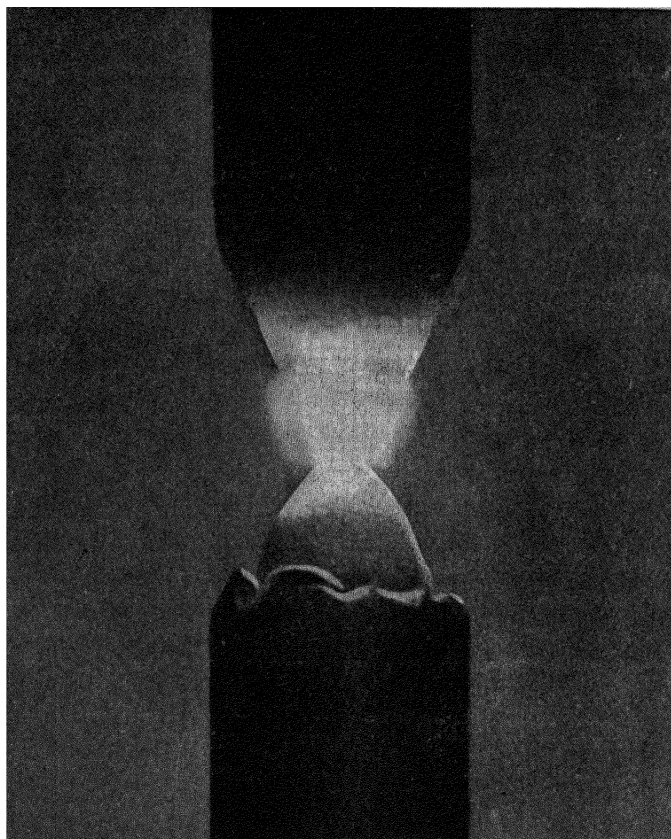

Fig. 46.—The Electric Arc.

vapor, producing a slight hollow in the center of the upper carbon, known as the "crater."

The carbon outside the crater takes the shape of a blunt point, while the lower carbon is rather evenly and more sharply pointed, and tends, if the arc is short, to build up accretions of carbon into somewhat of a

mushroom shape. Fig. 46 shows the shape of these tips much enlarged, as they would appear in looking at the arc through a very dark glass. Under such circumstances the light from the arc between the carbon points seems quite insignificant, and it is readily seen that the crater is by far the hottest and most brilliant region. In

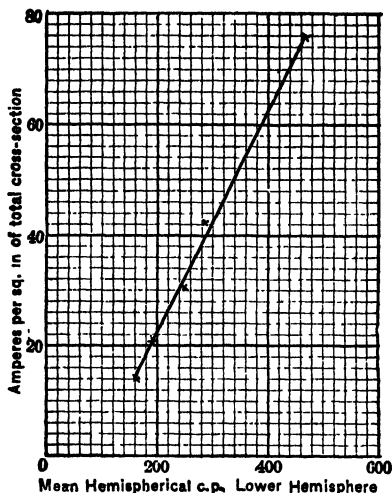

Fig. 47.—Relation between Current Density and Intensity.

point of fact the crater is at a temperature of probably 3500 to 4000 degrees F., and gives about 50,000 candle-power per square inch. of surface—sometimes even more.

It is obvious that the more energy spent in this crater the more heat and light will be evolved, and that the concentration of much energy in a small crater ought to produce a tremendously powerful arc. It is not surprising therefore to find that the larger the current crowded through a small carbon tip,—in other words, the higher the current density in the arc,—the more intense the luminous effects and the more efficient the arc. Fig. 47

shows this fact graphically, giving the relation between current density and light in an arc maintained at uniform current and voltage.

The change in density of current was obtained by varying the diameter of the carbons employed, the smallest being about 5-16 inch in diameter, the largest 3-4 inch. The current was 6.29 amperes, and the voltage about 43.5. The efficiency of the arc appears from these experiments to be almost directly proportional to the current density. But if the carbon is too small it wastes away with inconvenient rapidity, while if it be too large the arc does not hold its place steadily and the carbon gets in the way of the light.

The higher the voltage the longer arc can be successfully worked, but here again there are serious limitations. With too short an arc the carbons are in the way of the light, and the lower carbon tends to build up mushroom growths, which interfere with the formation of a proper arc. In arcs worked in the open air the arc is ordinarily about 3-32 inch long. If the voltage is raised above the 40 to 45 volts at the arc commonly employed for open arcs, the crater temperature seems to fall off and the arc gets bluish in color from the relatively larger proportion of light radiated by the glowing vapor between the carbon poles.

So it comes about that commercial arcs worked in the open air generally run at from 45 to 50 volts, and from 6 to 10 amperes. The softer and finer the carbons the lower the voltage required to maintain an arc of good efficiency and proper length, so that arcs can be worked successfully at 25 to 35 volts with proper carbons, and with very high efficiency, but at the cost of burning up the carbons rather too rapidly. Abroad, where both

high-grade carbons and labor are cheaper than in this country, such low voltage arcs are freely used with excellent results, and give a greatly increased efficiency.

Sometimes three are burned in series across 110-volt mains, where in American practice one, or at most two arc lamps, would be used in series with a resistance coil, the same amount of energy being used in each case. With proper carbons too, a steady and efficient arc can be produced taking only 3 or 4 amperes, and admirable little arc lamps of such kind are in use on the Continent. The carbons are barely as large as a lead pencil and the whole lamp is proportionately small, but the light is brilliant and uniform.

The upper carbon burns away about twice as fast as the lower, and the rate of consumption is ordinarily from 1 to 2 inches per hour, according to the diameter and hardness of the carbons.

The carbons themselves are generally about 1-2 inch in diameter, and one or both are often cored, *i. e.*, provided with a central core, perhaps 1-16 inch in diameter, of carbon considerably softer than the rest. This tends to hold the arc centrally between the carbons and also steadies it by the greater mass of carbon vapor provided by the softer portion. Generally it is found sufficient to use one cored and one solid carbon in each arc, although in this country arcs burning in the open air usually are provided with solid carbons only.

In American practice such open arcs are very rapidly passing out of use, and are being replaced by the so-called enclosed arcs. During the past three or four years these have gone into use in immense numbers, until at the present time the open arc is very rarely in-

stalled, and illuminating companies are discarding them as rapidly as they find it convenient to purchase equipment for the enclosed arcs.

The principle of the enclosed arc is very simple. It merely consists in fitting around the lower carbon a thin elongated vessel of refractory glass with a snugly fitting metallic cap through which the upper carbon is fed, the fit being as close as permits of proper feeding. The result is that the oxygen is rapidly burned out of the globe, and the rapid oxidation of the carbon ceases, the heated gas within checking all access of fresh air save for the small amount that works in by diffusion through the crevices.

The carbon wastes away at the rate of only something like 1-8 inch per hour under favorable circumstances, and the lamp only requires trimming once in six or eight full nights of burning, instead of each night. For all-night lighting it used to be necessary to employ a double carbon lamp, in which were placed two pairs of carbons, so that when the first pair was consumed the second pair would automatically go into action and finish out the night. The enclosed lamp burns 100 hours or more with a single trimming. Even much longer burning than this has been obtained from a 12-inch carbon, such as is customarily used, but one cannot safely reckon on a better performance without very unusual care.

Fig. 48 shows a typical enclosed arc lamp, of the description often used on 110-volt circuits, both with and without its outer globe and case. The nature of the inner globe is at once apparent, but it should also be noted that the clutch by which the carbon is fed acts, as in many recent lamps, directly upon the carbon itself,

thereby saving the extra length of lamp required by the use of a feeding rod attached to the carbon. Finally, at the top of the lamp is seen a coil of spirally wound resistance wire. The purpose of this is to take up the

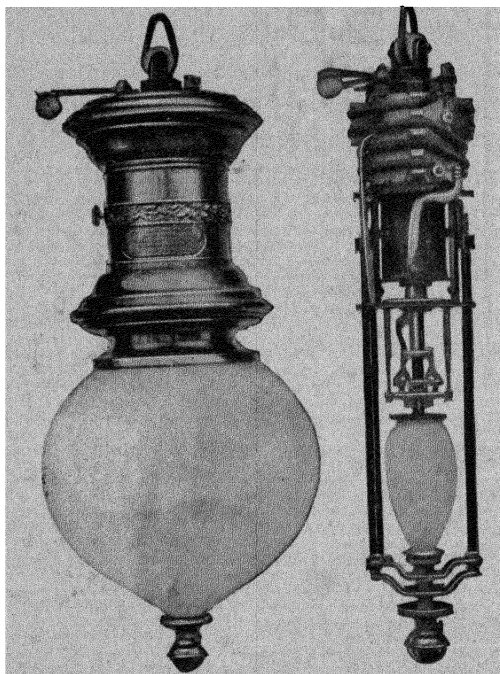

Fig. 48.—Typical Enclosed Arc Lamp.

difference between 110 volts, which is the pressure at the mains, and that voltage which it is desired to use at the arc and in the lamp mechanism.

Such a resistance evidently involves a considerable waste of energy, but in the enclosed arc the voltage at the arc itself is, of necessity, rather high, 70 to 75 volts, so that the waste is less than it would otherwise be.

It has been found that when burning in an inner globe

without access of air, the lower or negative carbon begins to act badly, and to build up a mushroom tip, when the voltage falls below about 65 volts. Hence it is necessary to the successful working of the scheme that the arc should be nearly twice as long as when the carbons are burning in open air. This has a double effect, in part beneficial, in part harmful. With the increased length the crater practically disappears, and the light is radiated very freely without being blocked by the carbons. Hence the distribution of light from the enclosed arc is much better than from an open arc.

On the other hand, there is no point of the carbon at anything like the temperature of the typical open arc "crater," and the intrinsic efficiency is thereby lowered. Also if the enclosed arc is to take the same energy as a given open arc, the current in the former must be reduced in proportion to the increased voltage, hence, other things being equal, the current density is lowered, which also lowers the efficiency.

The compensation is found in the lessened care and the lessened annual cost for carbons. The carbons themselves have to be of a special grade, and are about two and a half times as expensive as plain solid carbons, but the number used is so small that the total cost is low. There is some extra expense on account of breakage of the inner globes, but the saving in labor and carbons far outweighs this. Moreover, the light, albeit somewhat bluish white, is much steadier than that of the ordinary open arc, and the inner globe has material value in diffusing the light, being very often of opal glass, so that the general effect is much less dazzling than that of an open arc, and the light is far better distributed.

In outdoor lighting the greater proportion of horizontal rays from the enclosed arc is of considerable benefit, while in buildings the same property increases the useful diffusion of light, as will be presently shown. Of course, when enclosed arcs are operated in series, as in street lighting, the resistance of Fig. 48 is reduced to a trivial amount, or abolished, so that the extra voltage required with the enclosed arc is the only thing to be considered. The enclosed arc used in this way is very materially better as an illuminant than an open arc taking the same current, and experience shows that it may be substituted for an open arc, taking about the same energy, with general improvement to the illumination.

The weak point of the open arc is its very bad distribution of light, which hinders its proper utilization. The fact that most of the light is delivered from the crater in the upper carbon tends to throw the light downward rather than outward, and much of it is intercepted by the lower carbon. Fig. 49 gives from Wybauw's experiments the average distribution of light from 26 different arc lamps, representing the principal American and European manufacturers. The radii of the curve give the intensities of the light in various angles in a vertical plane. The distribution of light in space would be nearly represented by revolving this curve about a vertical axis passing through its origin, although at any particular moment the distribution of light from an arc may be far from equal on the two sides.

The shape of the curve is approximately a long ellipse with its major axis inclined 40 degrees below the horizontal. The presence of globes on the lamps may modify this curve somewhat, but in ordinary open arcs it always preserves the general form shown. The small



portion of the curve above the horizontal plane shows the light derived from the lower carbon and the arc itself, while the major axis of the curve measures the light derived from the crater. The tendency, then, of the open arc is to throw a ring of brilliant light downward

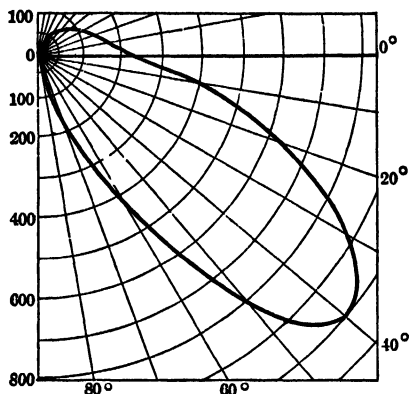

Fig. 49.—Distribution of Light from an Open Arc.

at an angle of 40 degrees below the horizontal, so that within that ring the light is comparatively weak, and without it there is also considerable deficiency. Hence the open arc, if used out of doors, fails to throw a strong light out along the street, while the illumination is dazzling in a zone near the lamp.

For the same reason the open arc is at a disadvantage in interior lighting, for the reason that most of the light, being thrown downward, falls upon things and surfaces far less effective for diffusion than the ordinary walls and ceiling. Hence one of the very best ways of using arcs for interior lighting is to make the lower carbon positive instead of the upper, and to cut off all the downward light by a reflector placed under the lamp. Then

practically all the light is sent upward and outward to be diffused by the walls and ceiling.

The enclosed arc, on the other hand, gives a much rounder, fuller curve of distribution, the light being thrown well out toward the horizontal and there being a pretty strong illumination above the horizontal. For the same energy the maximum illumination is little more than half the maximum derived from an open arc, but the result in distribution is such as to fully compensate for this difference if one considers the lamps as illuminants and not merely as devices for transforming electrical into luminous energy.

Fig. 50 shows a composite distribution curve from ten or a dozen enclosed arc lamps, such as are used on constant potential circuits, including various makes. Most of them were lamps taking about 5 amperes, and therefore using nearly 400 watts at the arc, besides the energy taken up in the resistance and the mechanism. Figs. 49 and 50 afford a striking contrast in distribution, and it is at once obvious that the lamps represented by the latter have a great advantage as general illuminants either indoors or outside. These figures include the inner globe, of course, generally of opal glass, which is of some benefit in correcting the bluish tinge which is produced by the long arc. After a few hours' burning a slight film collects on the inner globe, which tends to the same result. For interior lighting, outer globes of opal or ground glass are generally added, so that the color question is partially eliminated.

As ordinarily employed, enclosed arc lamps take from 5 to 7 amperes, although now and then 3 or 4 ampere lamps are used. These smaller sizes are less satisfactory in the matter of color of the light, and are not widely

used. Abroad open arcs taking as little as 2.5 amperes are sometimes used. The carbons in this case are very slender and of particularly fine quality, and these tiny lamps can be made to give an admirable light.

Outside of America the enclosed arc is little used, for abroad labor is much cheaper than here, and carbons of

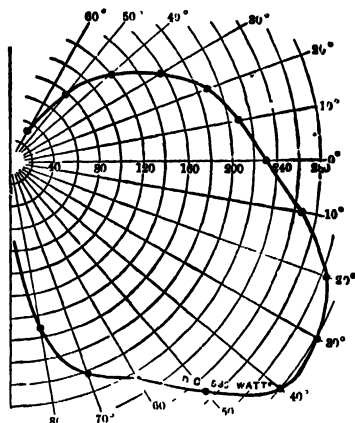

Fig. 50.—Distribution of Light from Enclosed Arc.

a grade costly or quite unattainable here are there reasonably cheap, so that the somewhat higher efficiency of the open arc compensates for the extra labor and carbons. Aside from this the bluish tinge of the light from enclosed arcs of small amperage is considered objectionable, and the gain in steadiness so conspicuous in American practice almost or quite disappears when the comparison is made with open arcs taking the carbons available abroad.

At its best the electric arc has fully three times the efficiency of a first-class incandescent lamp, but this advantage is somewhat reduced by the need of diffusing globes to keep down the dazzling effect of the arc, and

to correct the distribution of the light. Taking these into account, and also reckoning the energy wasted in the resistances in case of arc lamps worked from constant potential circuits, the gain in efficiency is considerably reduced, and if one also figures the better illumination obtained by using distributed lights in incandescent lighting, the arc lamp has a smaller advantage than is generally supposed. Many experiments bearing on this matter have been made, and a study of the results is highly instructive.

By far the most complete investigation of the properties of the enclosed type of arc lamps is that recently made by a committee of the National Electric Light Association. The investigation was upon the arc lamps both for direct and alternating currents, as customarily used on constant-potential circuits. The results, however, are not materially different, so far as distribution of light goes, from those that belong to similar lamps for series circuits. Fig. 50 is the composite curve of distribution obtained by this committee in the tests of direct-current lamps.

The individual curves vary somewhat, although showing the same essential characteristics. Fig. 51 shows a typical example both with the outer globe opalescent, like the inner globe, and also with a clear outer globe. The effect of the former in reducing and also in diffusing the light is very conspicuous. The opalescent globe absorbed a little over 14 per cent. of the light. This absorption is much less than would be given by a ground or milky glass shade, but it serves to cut down the intrinsic brilliancy to a useful degree. A clear globe absorbs about 10 per cent.

The weak point of such lamps as efficient illuminants lies in the large amount of energy wasted in the lamp mechanism, including the resistance for reducing the

voltage of the mains to that desirable for the enclosed arc. This loss amounts ordinarily to nearly 30 per cent. of the total energy supplied, so that while the arc itself is highly efficient, the lamps as used are wasteful. No one but an American would think of working a 75-volt arc off a 120-

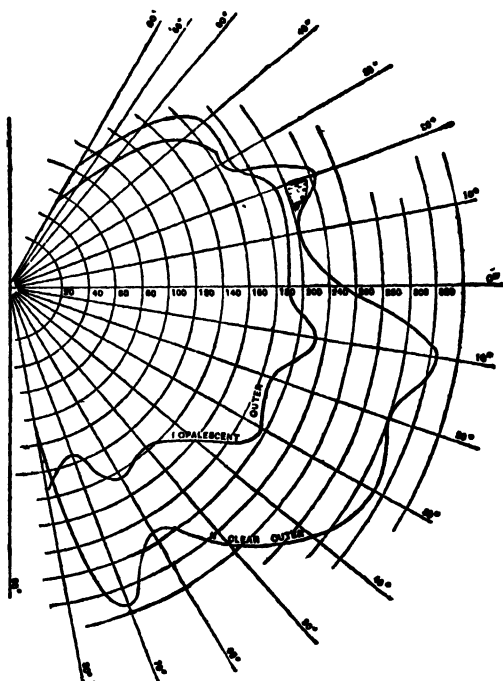

Fig. 51.—Effect of Globes on Enclosed Arc.

volt circuit and absorbing the difference in an energy-wasting resistance, but the advantages of the enclosed arc are so great in point of steadiness and moderate cost of labor that the practice has been found commercially advantageous, and the open arc has been practically driven from the field for all indoor illumination, and is being rapidly displaced in street lighting.

Foreign practice tends, as already noted, toward the use of two or even three open arcs in series on constant potential circuits. These can be fitted with diffusing globes to keep the intrinsic brilliancy within bounds, and obviously give a far larger amount of light for the energy consumed than is obtained here with enclosed arcs, but we have neither cheap high-grade carbons nor cheap labor, and as in the last resort the thing which determines current practice must be the total cost of light per candle-hour, it is likely that both methods of lighting are right when judged by their respective conditions.

At present alternating-current arc lights are being rather widely used, both on constant potential and on constant-current circuits, and such arcs present some very interesting characteristics. Evidently when an arc is formed with an alternating current there is no "positive" and no "negative" carbon, each carbon being positive and negative alternately, and changing from one to the other about 7200 times per minute—120 times per second.

Under these circumstances no marked crater is formed on either carbon, and the two carbons are consumed at about an equal rate. As a natural result of the intermittent supply of energy and the lack of a localized crater, the average carbon temperature is somewhat lower than in case of the direct-current arc, and the real efficiency of the arc as an illuminant is also somewhat lowered. Tests made to determine this difference of efficiency have given somewhat varied results, but it seems probable that for unit energy actually applied to the arc itself the direct-current arc will give somewhere about 25 per cent. more light than the alternating-current arc. But since when working the latter on a constant potential circuit the

surplus voltage can be taken up in a reactive coil, which wastes very little energy, instead of by a dead resistance, which wastes much, the two classes of arcs stand upon a more even footing than these figures indicate. This comparison assumes enclosed arcs in each case, in accordance with present practice.

For street lighting, as we shall presently see, the alternating arcs have certain advantages of considerable moment with respect to distribution, so that as practical illuminants they are often preferred.

The chief objection to the alternating-current arc has been the singing noise produced by it. This is partly due to the vibration produced in the lamp mechanism and partly to the pulsations impressed directly on the air by the oscillatory action in the arc itself. The former can be in great measure checked by proper design and manufacture, but the noise due directly to the arc is much more difficult to suppress.

Abroad where, for the reason already adduced, open arcs are commonly used, a specially fine, soft carbon is used for the alternating arcs, and the noise is hardly perceptible. These soft volatile carbons, particularly when used at a considerable current density, give such a mass of vapor in the arc as to endow it with added stability and to muffle the vibration to a very marked degree. The result is a quiet, steady, brilliant arc of most excellent illuminating power. But in this country such carbons are with difficulty obtainable, and, even if they were to be had at a reasonable price, could not be used in enclosed arc lamps on account of rapid smutting of the inner globe. Hence it is by no means easy to get a quiet alternating arc, and in a quiet interior there is generally a very perceptible singing, pitched about a semi-tone below bass C,

with noticeable harmonics, a kind of chorus not always desirable.

In selecting alternating-current lamps for indoor work great care should be exercised to get a quiet lamp. Some of the American lamps when fitted with tight outer globes and worked with a rather large current are entirely unobjectionable, but in many cases there is noise in the mechanism, or the globe serves as a resonator. With a current of 7 to 7.5 amperes, and a well fitted and non-resonant globe, little trouble is likely to be experienced. Out of doors, of course, a little noise does not matter.

The chief characteristic of the alternating arc, as regards distribution of light, is its tendency to throw its light outward rather than downward like the direct-current arc; in fact, considerable light is thrown above the horizontal, which materially aids diffusion.

For this reason it is often advantageous to use reflecting shades for such lamps, so as to throw the light out nearly horizontally when exterior lighting is being done. Indoors, diffusion answers the same purpose, unless powerful downward light is needed, when the reflector is of service.

Fig. 52, from the committee report already mentioned, shows the distribution of light from an alternating-current lamp, with an opalescent outer globe, with a clear outer globe, and with no outer globe, and with a porcelain reflecting shade of the form indicated by the dotted lines in the figure. The abolition of the outer globe and the use of the reflector produces a prodigious effect in strengthening the illumination in the lower hemisphere, and this hemispherical illumination is for some purposes a convenient way of reckoning the illumination of the lamp. But a truer test is the spherical candle-power,



since that takes account of all the light delivered by the lamp. Alternating arc lamps seem to work best at a frequency of 50 to 60 cycles per second. Above 60 cycles they are apt to become noisy, and below about 40 cycles

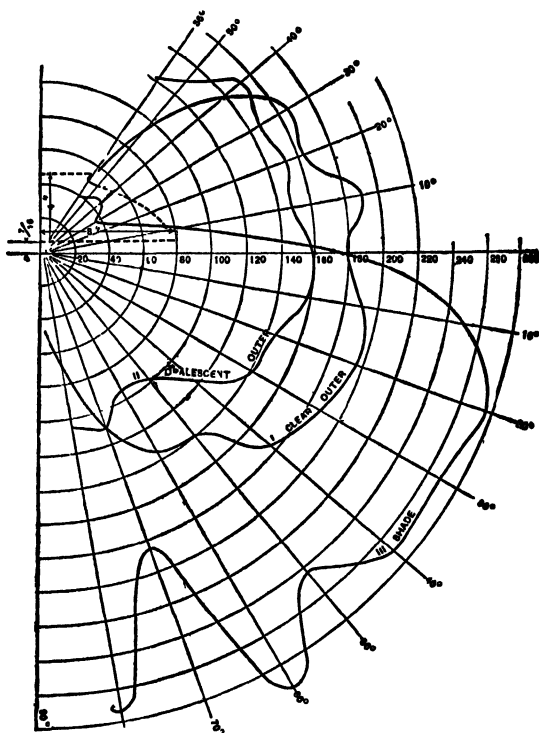

Fig. 52.—Distribution from Alternating Enclosed Arc.

the light flickers to a troublesome extent. The light of the alternating arc is really of a pulsatory character, owing to the alternations. A pencil rapidly moved to and fro in the light of such an arc shows a number of images—one for each pulsation, and this effect would be very distressing if one had to view moving objects, like quick

running machinery, by such light. A harrowing tale is told of a certain theater in which alternating arcs were installed for some gorgeous spectacular effects, and of the extraordinary centipedal results when the ballet came on.

This pulsation is somewhat masked when the enclosed arc is used, even with a clear outer globe, and is generally rather inconspicuous when an opal outer globe is used. It is also reduced when a fairly heavy current (7 to 8 amperes) is used, and when very soft carbons are employed, as they can be in open arcs.

D. C. Lamp	Current	WATTS CONSUMED			MEAN INTENSITY IN H. U.			MEAN WATTS		
		In Lamp	In Arc	Mechanism	Spherical		Lower Hemi-spherical	Spherical H. U.		Lower Hemi-spherical
					Op. Outer	Clear Outer		Op. Outer	Clear Outer	
							Clear Outer			Clear Outer
1	5.01	551	401	150	172	235	332	3.10	2.37	1.66
3	5.08	550	406	252	195	256*	362*	2.85	2.18*	1.52*
4	4.76	524	381	143	127	216	282	4.12	3.76	2.52
5	4.16†	458	333	125	154	174	221	2.06	2.63	2.07
7	4.76	524	381	143	203	333	317	2.63	2.20	1.65
9	4.84	532	387	145	182	226	281	2.83	2.38	1.89
10	4.99	549	390	150	202	242	309	2.74	2.24	1.77
12	4.87	536	390	146	178	195	230	3.05	2.66	2.33
Mean	4.9	529	384	144	176	207	272	3.03	2.60	1.98

A. C. Lamp	Current	In Lamp	Power Factor Lamp	In Arc	Power Factor Arc	Mechanism						
101	6.40	448	.63	340	.82	108	127	141	206	3.52	3.17	2.17
102	6.79	459	.61	375	.73	84	146	203	236	3.31	2.20	1.04
103	5.89	424	.65	344	.75	80	116	176†	226†	3.06	2.60†	1.71†
105	6.20	414	.61	382	.80	32	128	130	147	3.24	3.15	2.88
								187	219	3.24	2.20	1.89
								153	169		2.56	2.23
106	6.12	378	.56	298	.70	80	132	182†	284	2.82	2.19†	1.48†
108	6.48	457	.64	383	.80	74.5	133	175	211	3.30	2.61	2.16
110	6.18	339	.49	276	.72	63	126	143	241*	2.41*	2.68	2.27
Mean	6.29	417	.60	342	.76	74.5	130	159	190	3.31	2.66	2.23

\* Condition of no outer globe. † Condition with shade on lamp.

NOTE.—All marked values not included in the mean.

An interesting comparison of direct-current and alternating-current enclosed arcs, as used on constant potential circuits, is found in the foregoing table, from the report already quoted.

It must be remembered that the results are in Hefner-Alteneck units. This unit is roughly 0.9 cp, so that the mean results, reduced to a candle-power basis, are, for efficiency when using clear outer globes, as follows:

Direct-current arc.....	2.89 watts per cp.
Alternating arc.....	2.96 watts per cp.

These efficiencies are on their face but little better than those obtained from incandescent lamps. There is little doubt that as a matter of fact a given amount of energy applied to 3-watt incandescent lamps will give more useful illumination than if used in arcs of the types here shown. The incandescents lose somewhat in efficiency, but gain by the fact of their distribution in smaller units.

But for many purposes the arcs are preferable on account of their whiter light and the very brilliant illumination that is obtainable near them.

Both direct and alternating-current enclosed arcs gain by the use of rather large currents, both in steadiness and in efficiency, and moreover give a whiter light. The same is true, for that matter, of open arcs, in which the larger the current the higher the efficiency. Very many experiments on the efficiency of open arcs have been made with moderately concordant results. Their efficiency ranges in direct-current arcs from about 1.25 watts per candle in the smallest to about 0.6 or a little less in the most powerful. Fig. 53 shows a considerable number of results by different experimenters consolidated into a curve giving the relation between current and efficiency, as based on mean spherical candle-power.

The data for forming a similar curve for alternating arcs are not available, but there is in this case the same sort of relation between current and efficiency as that just shown. There is generally accounted to be from 15 to

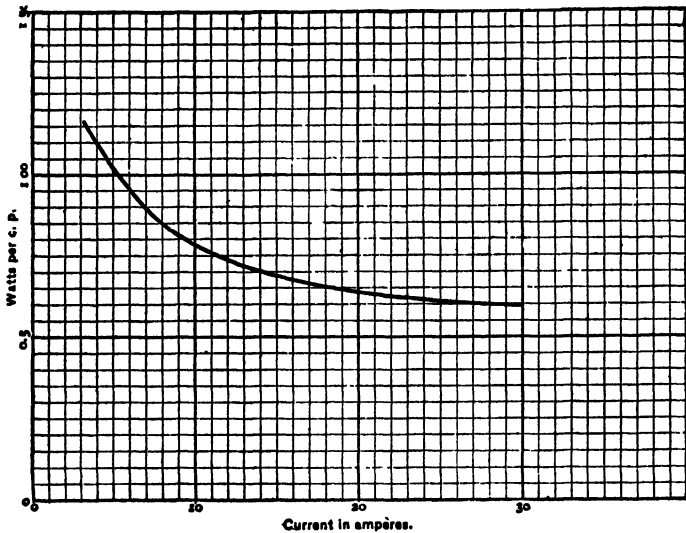

Fig. 53.—Relation between Current and Efficiency.

25 per cent. difference in absolute efficiency in favor of the continuous-current arc.

Obviously the open arc has a much greater efficiency than the enclosed form, but the very great intrinsic brilliancy of the former is from the standpoint of practical illumination a most serious drawback. For all indoor use and for much outdoor use the open arc must be shielded by a diffusing globe, which to be effective should cut off about 25 per cent. of the light. Taking this into account, the working efficiency of the open arc in the sizes generally used is likely to range between 1.25 and 1.50 watts per candle-power. It cannot, however, be made a

satisfactory illuminant upon any terms until better carbons are used than are now available at a moderate price in this country.

Recently some very interesting experiments have been tried abroad with carbons impregnated with certain metallic salts. These composite carbons have given extraordinary efficiency, down to less than 0.5 watt per spherical candle-power, and give a light softer and less brilliantly white than usual. The product has not yet, however, been brought into commercial form, so that it is too early to speak with certainty regarding its merits. Arcs formed between two slender pencils of such material as is used in the Nernst glower have also been tried, and have given an enormous efficiency, even greater than that just mentioned. But the process is yet far from being in commercial shape, so that nothing definite can be judged as to its practical value. The immense intrinsic brilliancy of such an arc would be a serious difficulty with its use as an illuminant.

We may now form some idea of the relative efficiency of different classes of lights. The annexed table puts the facts in convenient form for reference :

KIND OF ARC.	WATTS PER SPIL. CP	REMARKS.
Direct current, open.. . . . .	1 0	Medium power arc.
Direct current, shaded. . . . .	1.3	Medium power arc.
Alternating current, open. . . . .	1.7	Approximate.
Alternating current, shaded. . . . .	2.2	Approximate.
Direct current, enclosed. . . . .	2 4	No outer globe
Direct current, enclosed. . . . .	2.9	Clear outer globe.
Direct current, enclosed. . . . .	3.3	Opal outer globe.
Alternating current, enclosed. . . . .	3 0	Clear outer globe.
Alternating current, enclosed. . . . .	3.6	Opal outer globe.
Alternating current, enclosed. . . . .	2.5	No outer globe.
Direct current, enclosed. . . . .	1.9	Series lamp, approximate.

}  
Constant  
Potential.

In watts per horizontal candle-power the enclosed arcs, particularly the alternating ones, do relatively much bet-

ter than is indicated in the table. And in comparing arcs with incandescents it must be remembered that the latter, when rated like the above arcs, on mean spherical candle-power and average efficiency while in use, will not do much better than 4 to 4.5 watts per candle. But it is adaptation to the work in hand that must determine the use of one or another illuminant.

## CHAPTER VIII.

### SHADES AND REFLECTORS.

As has already been pointed out, the illuminants in common use leave much to be desired in the distribution of light, and have, for the most part, too great intrinsic brilliancy. The eye may suffer from their use, and even if this does not occur, the illumination derived from them is less useful than if the intrinsic brilliancy were reduced.

Hence the frequent use of shades and reflectors in manifold forms. Properly speaking, shades are intended to modify the light by being placed between it and the eye, while reflectors are primarily designed to modify the distribution of the light rather than its intensity. Practically the two classes often merge into each other or are combined in various ways.

There is, besides, a considerable class of shades of alleged decorative qualities, which neither redistribute the light in any useful manner nor shield the eye to any material degree. Most of them are hopelessly Philistine, and have no æsthetic relation to any known scheme of interior decoration. Figs. 54 and 55, a stalactite and globe respectively, of elaborately cut glass, are excellent examples of things to be shunned. Cut glass is not at its best when viewed by transmitted light, and neither diffuses nor distributes the light to any advantage. Such fixtures logically belong over an onyx bar inlaid with silver dollars, and to that class of decoration in general. Almost equally bad are shades that produce a strongly

streaked or mottled appearance, like Figs. 56 and 57. These neither stop the glare from a too intense radiant nor render the illumination more practically useful by improving its distribution. These shades happen to be

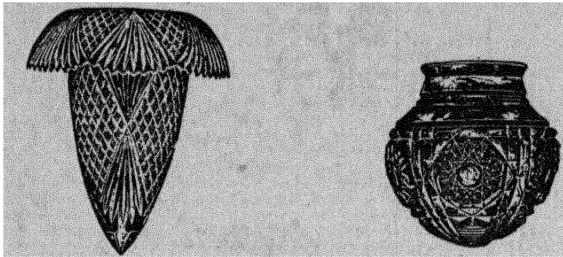

Figs. 54 and 55.—Cut Glass Stalactite and Globe

all of them for incandescent lamps, but they are evil in both principle and application, and would be equally bad in connection with any other kind of illuminant.

With open gas flames a shade may be of some use as a protection from draughts, but generally its purpose is to

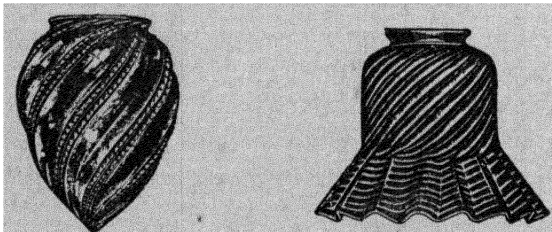

Figs. 56 and 57.—Shades to Avoid.

improve the illumination, and if it fails of this it has no excuse for being. For artistic reasons it is sometimes desirable even to reduce the illumination to a deep mellow glow quite irrespective of economy, and in such case shades may be made ornamental to any degree and of any density required, or lights may be distributed for purely



decorative purposes, but gaudy spotted and striped affairs, like those just shown, are useless even for these ends.

The first requirement of a shade is that it shall actually soften and diffuse the light it shelters. If it does not do this, no amount of ornamentation can make it tolerable from an æsthetic standpoint. Almost any kind of ornamentation is permissible that does not defeat this well-defined object. Translucent porcelain, ground and etched glass are all available in graceful forms. If perfectly plain shades, like Fig. 58, seem too severe, then

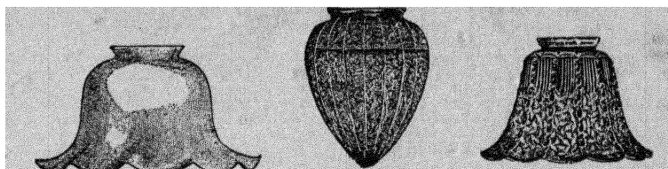

Figs. 58, 59, and 60 — Shades.

those finely etched in inconspicuous figures, like Figs 59 and 60, may answer the purpose. The main thing is to conceal the glaring incandescent filament or mantle so that it will not show offensively bright spots. Hence the general objection to cut glass, which, if used at all, should for the display of its intrinsic beauty be so arranged that it can be seen by strong reflected light rather than by that which comes from its interior.

Thin paper and fabrics may be most effectively employed for shades and can readily be made to harmonize with any style of ornamentation or color scheme that may be in hand. In this respect such materials are far preferable to glass or porcelain, although more perishable and less convenient for permanent use on a large scale. They also entail much loss of light, and are far better suited to domestic illumination than to larger installations.

The real proportion of light cut off by such shades has not, to the author's knowledge, ever been accurately measured, and, indeed, by reason of the immense variety in them, it would be almost impossible to average. It is safe to say, however, that it is generally over 50 per cent., although the light is so much softened that the loss is not seriously felt in reading or in other occupations not taxing the eyes severely.

With respect to porcelain and glass shades the proportion of light absorbed has been measured many times, and on many different kinds of shades, so that actual, even if diverse, figures are available. The following table gives the general results obtained by several experimenters on the absorption of various kinds of globes, especially with reference to arc lights:

	PER CENT.
Clear glass .....	10
Alabaster glass.....	15
Opaline glass.....	20-40
Ground glass....	25-30
Opal glass .....	25-60
Milky glass.....	30-60

The great variations to which these absorptions are subject are evident enough from these figures. They mean, in the rough, that clean, clear glass globes absorb about 10 per cent. of the light, and that opalescent and other translucent glasses absorb from 15 to 60 per cent., according to their density. Too much importance should not be attached to this large absorption, since it has already been shown that in most cases, so far as useful effect is concerned, diffusion and the resulting lessening of the intrinsic brilliancy is cheaply bought even at the cost of pretty heavy loss in total luminous radiation.

The classes of shades commonly used for incandescent

lamps and gas lights have been recently investigated with considerable care by Mr. W. L. Smith, to whom the author is indebted for some very interesting data on this subject.

The experiments covered more than twenty varieties of shades and reflectors, and both the absorption and the redistribution of light were investigated. One group of results obtained from 6-inch spherical globes, intended to diffuse the light somewhat without changing its distribution, was as follows, giving figures comparable with those just quoted :

	PER CENT.
Ground glass.....	24 4
Prismatic glass .....	20.7
Opal glass.....	32 2
Opaline glass.....	23 0

The prismatic globe in question was of clear glass, but with prismatic longitudinal grooves, while the opal and opaline globes were of medium density only.

Etched glass, like Figs. 59 and 60, has considerably more absorption than any of the above, the etching being optically equivalent to coarse and dense grinding. Their diffusion is less homogeneous than that given by ordinary grinding, so that they may fairly be said to be undesirable where efficiency has to be seriously considered.

A plain, slender canary stalactite behaved like the globes as respects distribution, and showed just the same absorption as the ground glass globe, *i. e.*, 24.4 per cent., but permitted an offensively brilliant view of the filament within.

Another group of tests had to do with reflecting shades designed to throw light downward, in some cases giving a certain amount of transmitted light, in others being really opaque. The characteristics of some common forms of

such shades are plainly shown by the curves of light distribution made with the shades in place. Figs. 61 and 62 show two thoroughly typical examples of these shades. Fig. 61 is the ordinary enameled tin 8-inch shade, green

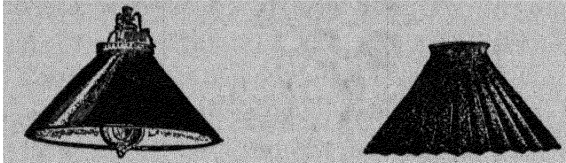

Fig. 61.—Conical Shade.

Fig. 62 —Fluted Cone.

on the outside and brilliant white within, a form too often used over desks. Fig. 62 is almost as common, being a fluted porcelain 6-inch shade, used in about the same way as Fig. 61. Figs. 63 and 64 give the respective vertical distributions produced by these two shades, the outer

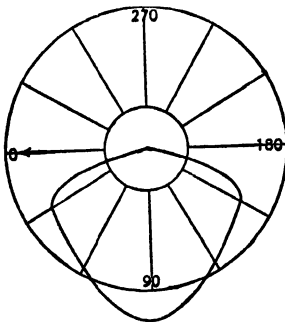

Fig. 63.—Distribution from Conical Shade.

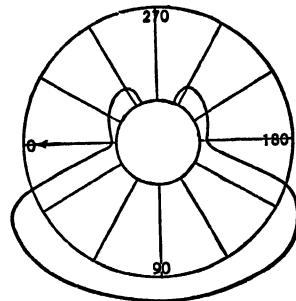

Fig. 64 —Distribution from Fluted Cone.

circles showing for reference the nominal 16-cp rating. The porcelain not only gives a more uniform reflection downwards, but transmits some useful light outwards. The case as between it and the tin shade of Figs. 61 and 63, which gives a strong but narrow cone of light downward, may be tabulated as follows:

	8-INCH TIN &ENAMELED	6-INCH FLUID PORCELAIN.
Mean spherical candle-power .....	8.12	9.89
Maximum candle-power.....	29.49	18.15
Horizontal candle-power... ..	0.00	5.26
Absorption, per cent.....	28.1	12.4

The absorption is, of course, based, as elsewhere, on the mean spherical candle-power. Of these two shades the porcelain one is considerably the better for practical purposes. Although it gives a somewhat smaller maximum candle-power directly below the lamp, it gives a much



Fig. 65.—Shallow Cone.

Fig. 66.—McCreary Shade.

larger well-lighted area, and is for every reason to be preferred. The unaltered vertical distribution of an incandescent lamp is given in the curve shown in Chapter VI., and that curve was from the same lamp used in testing these shades.

It should be noted that the relations of these two forms would not be materially altered if they were of appropriate size and were applied to Welsbach burners, the distribution of light from which bears a rather striking resemblance to that from an incandescent lamp. The tin shade gives too much the effect of a bright spot to be really useful for most purposes. If such a concentrated beam is desired it is far better obtained by other and more perfect methods.

Figs. 65 and 66 show two other forms of reflecting shade in somewhat common use, the former designed to give the light a general downward direction, the latter to produce a strong and uniform downward beam. Fig. 65 is a 6-inch fluted porcelain shallow cone, while Fig. 66 is the well-known and excellent McCreary shade, 7-inch. They are intended for widely different purposes, which come out clearly in the curves of distribution, Figs. 67 and 68.

The flat porcelain cone, Fig. 67, merely gathers a considerable amount of light that would ordinarily be thrown

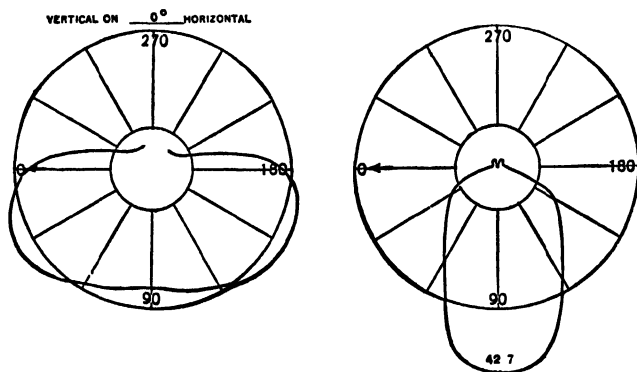

Figs. 67 and 68.—Curves of Distribution.

upward, and scatters it outwards and downwards. It has a generally good effect in conserving the light, and whether applied to an incandescent lamp or a Welsbach deflects downward a good amount of useful illumination.

The McCreary shade, on the other hand, is deliberately intended to give a rather concentrated beam, softened, however, by the ground glass bottom of the shade. As Fig. 68 shows, it accomplishes this result quite effectively, giving a powerful and uniform downward beam. The

annexed table shows in a striking manner the difference in the two cases :

	FLAT PORCE- LAIN CONE.	McCREARY.
Mean spherical candle-power.... .	9.84	7.50
Maximum candle-power..... .	15.72	42.72
Horizontal candle-power..... .	13.94	2.29
Absorption, per cent..... .	12.8	33.5

The small absorption in the first instance is merely due to the fact that the shade is not reached by any considerable portion of the light, while the large absorption in the later case only indicates that nearly the whole body of light is gathered by reflection, and sent out through a diffusing screen.

The porcelain cone is irremediably ugly, but a less offensive shade having the same general properties may often be put to a useful purpose. The McCreary shade is purely utilitarian, but neat, and does its work well in producing a strong, directed illumination—a bit too concentrated, perhaps, for ordinary desk work, but most useful for work requiring unusually bright light. Of fancy shades modified in various ways there are a myriad, usually less good than the examples here shown

In cases where concentration of light downwards along the axis of the lamp is desirable, rather efficient results are attained by combining lamp and reflector, that is, by shaping the bulb of the lamp itself so that when the part of it nearest the socket is *silvered* on the outside it shall form an effective reflector of proper shape. Obviously when the lamp burns out or dim the whole combination becomes useless, in which respect the device is less economical than an ordinary lamp in a carefully designed reflecting shade like the McCreary. On the other hand, the reflector lamps are, on the whole, somewhat more efficient during

their useful life, and for general purposes of illumination are much less obtrusive.

In such lamps the bulb, instead of being pear-shaped, is spherical or spheroidal, with the upper hemisphere silvered, the silvering being protected by a coat of lacquer. The filament usually has several convolutions of rather small radius, so as to bring as large a proportion of the incandescent filament as possible near to the center of the bulb. A filament so disposed throws an unusual proportion of the light upwards and downwards when the lamp is mounted with its axis vertical, but, of course, at the expense of the horizontal illumination.

It has sometimes been proposed to use a filament so shaped in an ordinary bulb for the purpose of throwing a strong light downwards. Evidently, however, such a lamp throws just as much light upwards toward the opaque socket and the ceiling as downwards toward the tip. Hence there is certainly no gain in general illumination, and no important gain in the downward illumination unless the lamp is mounted with a reflector. Fig. 69 shows in outline a nominal 50-cp. spherical bulb lamp with a silvered upper hemisphere, and Fig. 70 the curve of light distribution in a vertical plane. The maximum downwards is about 75 candle-power, while a fair amount of light is thrown out laterally up to 30 degrees from the horizontal. The dotted curve shows the distribution with the silvered bulb, the solid curve the distribution after the silvering had been removed.

Fig. 71 shows a common type of reflecting bulb lamp. As usually employed, the lower part of the bulb is ground so as to soften and diffuse the light. The general characteristics of reflectors and their field of usefulness have already been discussed, so that it is here hardly necessary



to say more than to reiterate that whenever a downward light is desired reflector lamps may furnish a most useful means of getting it. Their weak point, as generally made, is a tendency to produce a spotted effect through too great concentration of the light along the central axis. If a projector effect is the one thing desired silvered bulb lamps are not the best means of getting it, and for their

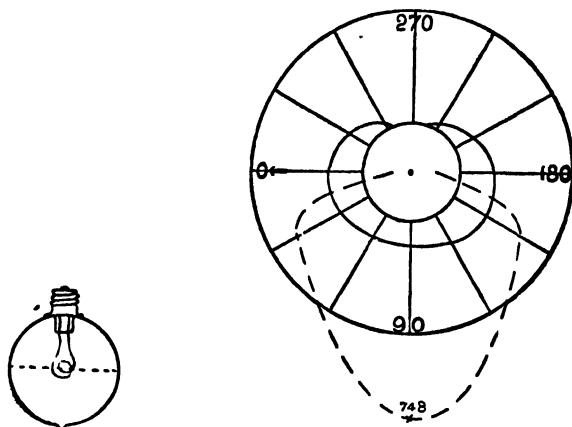

Figs. 69 and 70.—Reflector Lamp and Its Distribution.

greater usefulness as illuminants they should be so constructed as to give a nearly uniform *hemispherical* distribution. Most of the silvered bulb lamps on the market fail to do this. And it should be noted that since the whole lamp is lost when the filament breaks, there is a strong temptation to fit such lamps with a low efficiency filament in order to give a longer life. A properly designed lamp of this class planned for hemispherical distribution could not fail to be of much use in general illumination, and could be produced at a very small extra cost above standard lamps.

For various illuminants shades require to be somewhat modified in form, and an enormous variety of shades and reflectors are on the market, of which those here described may merely serve as samples. Shading the radiant, whatever it may be, is a simple matter, and so is the use

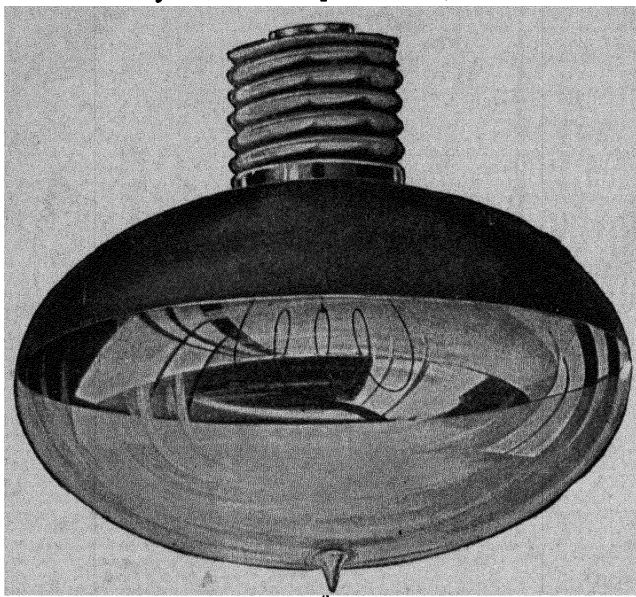

Fig. 71.—Reflector Lamp.

of a pure reflector (best made of silvered glass) to direct the light in any particular direction. But the commonest fault of powerful radiants, as we have already seen, is too great intrinsic brilliancy, which calls for diffusion, and good diffusion without great loss of light is difficult of attainment, particularly if at the same time there is need of redistributing the light so as to strengthen the illumination in any particular direction.

By far the most successful solution of this troublesome

problem is found in the so-called holophane globes, devised a few years ago by MM. Blondel and Psaroudaki, and now in somewhat extensive use both here and abroad. The general principle employed by these physicists was to construct a shade of glass so grooved horizontally as to form the whole shade of annular prisms. These are not formed as in a lighthouse lens, to act entirely by refraction, because in the attempt to bend the rays through a large angle by refraction alone there is a large loss by total reflection.

The prisms of the holophane globe are relieved, as it were, at certain points, so that rays which need to be but little deflected are merely refracted into the proper direction, while those that must be greatly bent to insure the proper direction are affected by total reflection. This combination of refracting and reflecting prisms in the same structure accomplished the efficient redistribution of the light in a very perfect manner. The diffusion remained to be effected, and the means adopted was to form the interior of the globe into a series of rather fine, deep, rounded, longitudinal grooves.

The total result is a great reduction of the intrinsic brilliancy, coupled with almost any sort of distribution required, the total loss of light meanwhile being less than in any other known form of diffusing shade or reflector. Fig. 72 shows in detail, considerably magnified, the structure of the holophane prisms and the combination of refraction and reflection that is their characteristic feature. Here the ray  $A$  is merely refracted in the ordinary way, emerging with a strong downward deflection from the prism face in the direction  $A^1$ . Ray  $B B^1$  is totally reflected at the face  $b^1$ , and then refracted outwards at  $b$ .  $C$  is strongly refracted and emerges from the surface  $c$ ,

while  $DD^1$  is refracted at entrance, totally reflected at  $d^1$ , and again refracted at emergence from  $d$ .

The net result is to keep in this particular form of prism surface nearly all the rays turned downward below the horizontal. Obviously other prismatic forms might be

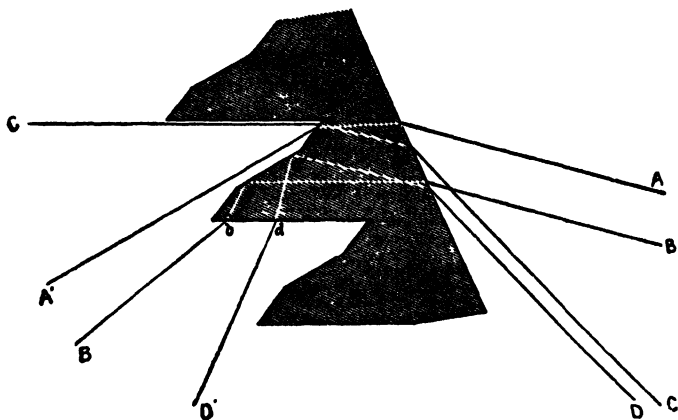

Fig. 72.—Section of Holophane Globe.

employed, which would give a very different final distribution, but the principles involved are the same.

Fig. 73 shows, likewise on a greatly enlarged scale, the interior fluting which accomplishes the necessary diffusion of light. The ray  $a$  is here split up into a reflected component, afterwards refracted— $b$ ,  $e$ ,  $f$ ,  $g$  and a purely refracted component,  $b$ ,  $c$ ,  $d$ . The shape of the flutings is such as by this means to secure very excellent diffusion at a very small total loss of light. The inner and outer groovings being at right angles produce a somewhat tessellated appearance, but aside from this the surface is quite uniformly illuminated.

These holophane globes are made for all kinds of

radiants, but are most commonly applied to Welsbach gas burners and to incandescent electric lights. Evidently the shape of both grooves and globe must vary with the purpose for which the shade is desired, which results in a very large number of forms from which a selection may be made for almost any variety of illumination.

It should be noted that these holophane shades both diffuse and redistribute the light in a very thorough manner. Speaking generally, they are of three distinct classes. The first is laid out according to the general principles of Fig. 72, and is intended to direct most of the

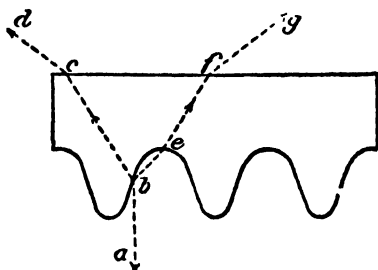

Fig. 73.—Diffusing Curves of Holophane.

light downwards, serving the same end as a reflector, but giving at the same time the needful diffusion without the use of a ground or frosted globe. The general results are strikingly shown in Fig. 74, which gives a very graphic idea of what such a globe actually does.

The second class of globes has for its purpose a fairly uniform distribution of the light, mainly below the horizontal, and it is intended for ordinary indoor lighting, where a particularly strong light in any one direction is quite needless. Its effect is shown in Fig. 75. The third general form of holophane globe is designed for the

especial purpose of throwing a strong light out in a nearly horizontal direction, and is shaped so as thus to redistribute the light, putting it where it is most useful for such work as street lighting, large interiors, and the like. The effect produced is admirably shown by Fig. 76. The

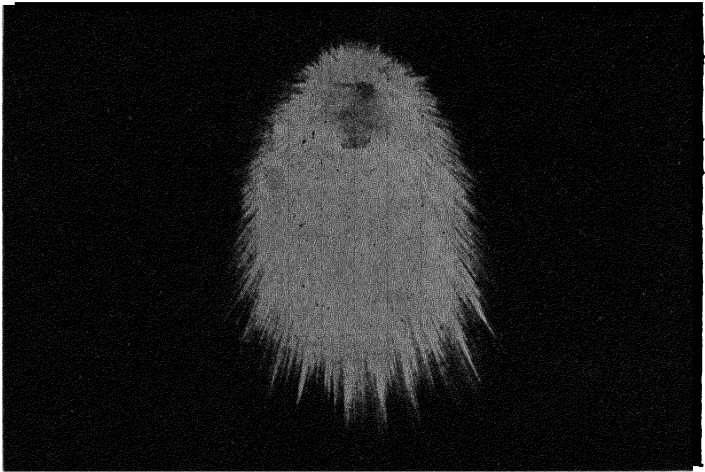

Fig. 74.—Holophane, Downward Distribution.

shapes of globes shown in these last three figures are those intended for mantle burners.

In general, the device enables a good degree of diffusion to be secured together with almost any peculiarity of distribution that could be wanted, and with a degree of efficiency that is unequaled by any known system of shades or reflectors, unless it be the Fresnel lighthouse lenses.

One does not generally get such a combination of good qualities without certain disadvantages that must be taken in partial compensation. In the holophane system the

weak point is dirt. The doubly grooved surface makes an excellent dust catcher, and a layer of dust can easily be accumulated quite sufficient to cut down the efficiency very seriously. And, moreover, a hasty dab with a rag does not clean a holophane globe; it must be gone over carefully and thoroughly. When kept clean, the globes actually will do just what is claimed for them, and are not

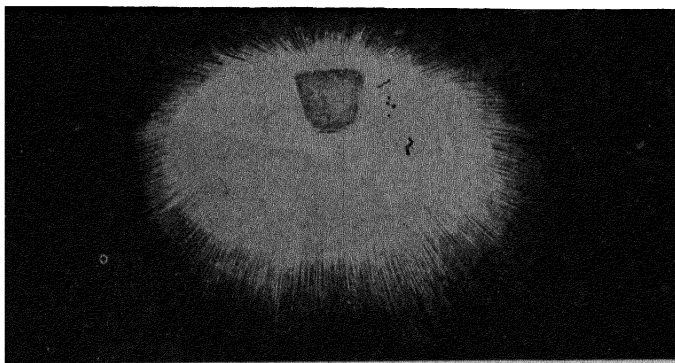

Fig. 75.—Holophane, General Distribution.

at all a merely theoretical development excellent only on paper; but they *must* be kept clean, and should not be used where they cannot or will not receive proper attention.

This is probably the chief reason, aside from the extra cost, why such globes have not been more extensively used for street lighting, to which their power of redistributing the light in the most useful direction admirably fits them. The results obtained in tests of these globes are so striking as to merit examination in some detail.

In spite of the trouble from dust, the holophane globes have come into considerable use for street lighting in some European cities, notably Munich, where several thousand have been used on Welsbach street lamps for several years

past. The net results is reported to be exceedingly good, although the amount of labor involved must be, from an American standpoint, very considerable. Breakage in this case is reported at about 10 per cent. per annum.

If this device could be successfully applied to arc lamps for street lighting, a very valuable redistribution of the

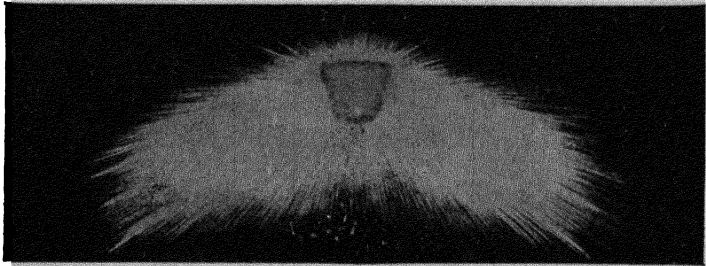

Fig. 76.—Holophane, Outward Distribution.

light might be effected, but certain obstacles seem to be interposed on account of the shifting of the arc as the carbons are consumed. With a focusing form of lamp this trouble would be averted, but such lamps have never yet come into considerable use in this country. With enclosed arcs, however, it should be possible to use these globes with a very fair degree of success.

Tests of holophane globes on incandescent lamps show in a thoroughly typical manner the effect of their peculiar structure in diffusing and redistributing the light. For example, Fig 77 exhibits the distribution produced by a holophane of the "stalactite" shape designed to throw the light downward. It does this very effectively, giving less of a spotted effect than any of the reflecting devices, and at the same time diffusing the light from the bare filament very thoroughly.



The light absorbed by this stalactite was only 14.6 per cent., which is considerably less than would be lost by any equally effective device for diffusion alone, to say nothing of the matter of redistribution. And this figure for absorption is probably increased by the deflection of so much light downwards, since similar shades designed to

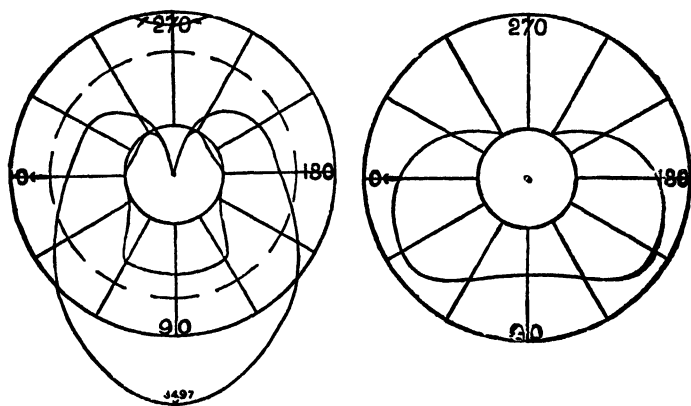

Figs. 77 and 78.—Distribution Curves.

throw more light laterally give materially smaller absorption.

From a considerable number of tests the holophane shades appear to average about 12 per cent. absorption when clean. That is, they actually transmit very nearly as much light as clear glass globes that have no value in redistributing or diffusing the light. As to their usefulness in indoor work there is little doubt.

For street lighting they are capable of immensely improving the distribution of the light, but the matter of keeping them clean is serious. Their greatest chance for practical usefulness would be in connection with arc lamps

if the details of such an application should be thoroughly worked out.

Fig. 78 shows the distribution curve from a holophane stalactite designed to produce a more general distribution than Fig. 77, the absorption in this instance being only 10.8 per cent. The principle employed in these shades would readily lend itself to the distribution of light in special directions for special purposes, but the variety of work in which light has to be directed is so great that special problems are best treated by the use of reflectors which are comparatively cheap and can readily be adapted to any required form.

## CHAPTER IX.

### DOMESTIC ILLUMINATION.

THE lighting of houses is a most interesting and generally neglected branch of illumination. Artificial light has been distinctly a luxury until within comparatively recent times, and in domestic lighting there has not been the same pressure of commercial necessity which has resulted in the general efforts to illuminate other buildings. Indeed, until within half a century there was very little effort at really good illumination in the home, everyone depending on portable lights which could be brought directly to bear upon the work in hand, gas, which provides fixed radiant points, being confined to large cities, and in these to houses of the better class. Even at the present time very little pains is taken to arrange the lighting in a systematic and efficient manner.

The comparatively small areas to be lighted in dwellings, the small need for extremely intense light, and the very discontinuous character of the need for any light at all, render domestic lighting rather a problem by itself. Of ordinary illuminants all may be freely used for such work, save arc lamps and very powerful gas lamps, such as the large regenerative burners and the most powerful incandescent mantles.

Arcs are of very unnecessary power, hence most uneconomical, and are generally so unsteady as to be most trying to the eyes. In the home, as a general thing, one does not keep the eyes fixed in any definite direction, as

one would if working steadily by artificial light, so that far more than usual care must be taken to avoid intense and glaring lights. Therefore, arcs are most objectionable, and the gas lights of high candle-power equally so, particularly as the latter throw out a prodigious amount of heat and burn out the oxygen of the air very rapidly.

As to other illuminants, the main point is to choose those of low intrinsic brilliancy, or to keep down the intrinsic brilliancy by adroit and thorough shading. Anything over two or three candle-power per square inch it is well to avoid as needlessly trying to the eyes without any compensating advantage save economy, which can better be secured in other ways.

Aside from the physiological side of the matter, very bright lights seldom give good artistic results or show an interior at anything like its true value. Of the common illuminants, gas and incandescent lamps are those generally most useful, while petroleum lamps and candles are even now auxiliaries by no means to be despised. Professor Elihu Thomson once very shrewdly remarked to the writer that if electric lights had been in use for centuries and the candle had been just invented, it would be hailed as one of the greatest blessings of the century, on the ground that it is absolutely self-contained, always ready for use, and perfectly mobile.

Now, gas and incandescents, while possessing many virtues, lack that of mobility. They are practically fixed where the builder or contractor found it most convenient to install them, for while tubes or wires can be led from the fixtures to any points desired, these straggling adjuncts are sometimes out of order, often in the way, and always unsightly. Besides, the outlets are often for structural reasons in inconvenient locations,

and their positions need to be chosen very carefully if artistic effects are at all to be considered; so that while these lights are the ordinary basis of illumination wherever they are available, lamps and candles, which can be put where they are wanted and not necessarily where some irresponsible workman chose to locate them, are often most useful additions to our resources.

In domestic, as in other varieties of interior illumination, two courses are open to the designer of the illumination. In the first place, he can plan to have the whole space to be lighted brought uniformly or with some approximation to uniformity, above a certain brilliancy more or less approximating the effect of a room receiving daylight through its windows. Or, throwing aside any purpose to simulate daylight in intensity or distribution, he can put artificial light simply where it is needed, merely furnishing such a groundwork of general illumination as will serve the ends of art and convenience.

While the first method is for purely utilitarian purposes sometimes necessary, it is always uneconomical and generally most inartistic in its results. Its sin against economy is in furnishing a great deal of light which is not really needed, while in so doing it usually sends light in directions where it deadens shadows, blurs contrasts, and illuminates objects on all sides but the right one. The second method is the one uniformly to be chosen for domestic lighting, from every point of view.

In electric lighting the most strenuous efforts are constantly being made to improve the efficiency of the incandescent lamps by a few per cent., and an assured gain of even 10 per cent. would be heralded by such a fanfare

of advertising as has not been heard since the early days of the art. Yet in lighting generally, and domestic lighting in particular, a little skill and tact in using the lights we now have can effect an economy far greater than all the material improvements of the last twenty years. The fundamental rule of putting light where it is most useful, and concentrating it only where it is needed, is one too often forgotten or unknown. If borne in mind, it not only reduces the cost of illumination, but improves its effect.

In applying this rule in practice, one of the first things which forces itself upon the attention is the fact that the conditions can seldom be met by the consistent use of lights of one uniform intensity, or one uniform characteristic as regards the distribution of the light around the radiant. Even one kind of illuminant is sometimes an embarrassing condition. Both the kind and quantity of the illumination must be adjusted to the actual requirements, if real efficiency is to be secured.

As has already been shown, the effective illumination depends upon two factors—the actual power of the radiant in candles or other units, and the nature of the surroundings, which determine the character and amount of the diffuse reflection which re-enforces the direct light. If the radiant in a closed space furnishes a certain quantity of light,  $L$ , then the strength of the illumination produced at any point within the space will depend, if the walls are non-reflecting, simply on the amount of light received from the radiant, in accordance with the law of inverse squares. If the walls reflect, then the total illumination at any point will be that received directly,  $L$ , and in addition a certain amount  $kL$  (where  $k$  is the coefficient of reflection), once reflected, a further

amount  $k^2 L$  twice reflected, and so forth. The total illuminative effect will then be:

$$L (1 + k + k^2 + k^3 + \dots k^n)$$

As  $k$  is obviously always less than unity, this series is convergent upon the limiting value  $L \left( \frac{1}{1-k} \right)$ , which expresses the relative effect of the walls in re-enforcing the light directly received from the radiant.

It is clear from the values of  $k$  already given for various surfaces, that such assistance may be of very great practical importance. A simple experiment showing the value of the light diffusely reflected is to read at some little distance from the radiant in a room having light walls, and then to cut off the direct rays by a screen close to the radiant and just large enough to shade the book. If the conditions are favorable, the amount of diffused illumination will be somewhat startling. A repetition of the experiment in a room with dark walls will exhibit the reverse condition in a most striking manner.

In practice the interior finish of dwelling houses is highly heterogeneous, the walls being tinted and broken with doors and hangings, the ceiling being often of another color, and the floors covered with colored rugs or carpets, and generally provided with furniture at least as dark as the walls. The floor is in point of fact the least important surface from the standpoint of illumination, for it not only carries the furniture, but from its position cannot diffuse light in any useful direction. So far as it is concerned, only the small terms in  $k^2$  and higher powers enter the general equation, since the illumination diffused from below is not of any practical account whatever.

A good idea of the practical amount of help received from diffusion may be gained by computing the effect for various values of  $k$ . The following table shows the results for values of  $k$  between .05 and .95.

$k$	$L \left( \frac{1}{1-k} \right)$
.95.....	20.
.90.....	10.
.85.....	6.66
.80.....	5.00
.75.....	4.00
.70.....	3.33
.65.....	2.85
.60.....	2.50
.55.....	2.22
.50.....	2.00
.45.....	1.81
.40.....	1.66
.35.....	1.53
.30.....	1.42
.25.....	1.33
.20.....	1.25
.15.....	1.17
.10.....	1.11
.05.....	1.05

These values show the great difference between good and poor diffusing surfaces in their practical effect. Reference to the table already given shows that ordinary wall surfaces give values of  $k$  ranging from about .60 down to .10 or less. These are likely to be reduced by the gradual absorption of dust at the surface, but it is quite within bounds to say that the effective illumination in a room may be nearly or quite doubled by the light diffused from the walls.

On the contrary, the ceiling is a very important consideration, for the light diffused downward is highly valuable. Paneled or vaulted ceilings are notorious in their bad effect upon the illumination. If used at all,



they should be employed with full knowledge of the fact that they quite effectively nullify all attempts at brilliant general illumination, and when considerations of harmony permit, ceilings ought to be very lightly tinted.

As to the walls themselves, wainscoting and dark soft-finished papers absorb light very strongly, and render lighting difficult, while the white-painted wood and light papers freely used in Colonial houses produce exactly the reverse effect. The character of interior finish, being determined by the contemporaneous fashion, can of course seldom be really subordinated to the matter of illumination, which affects only personal comfort; but in planning a scheme of decoration it is necessary to bear in mind that the darker the general effect the more light should be provided.

The outlets for gas and electricity provided for and quite adequate to light a brightly-finished house, will prove entirely insufficient if a scheme of decoration in dark colors be afterward carried out, so that it is the part of wisdom to arrange the original outlets to meet the worst probable conditions for lighting. This will generally mean arranging for about double the minimum amount of illumination wanted on the hypothesis of strong diffusion from the walls.

If conditions demand or fashion dictates any attempt at very bright illumination, a sort of simulated daylight, all matters relating to diffusion are of very serious import. Fortunately, such is not the usual case. Where the main purpose is that already strongly urged, of merely furnishing such illumination as is necessary for practical or artistic purposes, there need be no effort at uniform intensity of light or at making dark corners

brilliant; and, while the aid of favorable diffusion is still important in reducing the total amount of artificial light furnished, it no longer so completely controls the situation.

With the data now at hand we can form a fairly definite idea of the quantity of light which must generally be provided. One can get at the approximate facts by considering the amount of light that must be furnished in a room of given size to bring the general illumination up to a certain value. The particular value assumed must depend upon the purpose for which the room is to be lighted. For instance, since 1 candle-foot is an amount which enables one to read rather easily, let us assume that we are to furnish in a room 20 ft. square and, say, 10 ft. high, a minimum of 1 candle-foot.

To start with, we must make some assumption as to the amount gained by diffusion from ceiling and walls. This, in a concrete case, we can make an educated guess at from the data already given. In general, Wybauw found that in moderate-sized rooms the diffusion increased the effective value of the radiant 50 per cent., which, as it agrees pretty closely with our own values, taking into account a light ceiling, we will use for the present purpose.

Let the assumed radiant be at  $r$ , Fig. 79, and at a height of 6' 6" above the floor. Now draw an imaginary plane  $ab$  at a height of 2' 6" above the floor, and take this as the surface to be illuminated. If  $r$  is in the center of the room, the greatest distance from  $r$  to a corner of the plane  $ab$  will be  $\sqrt{216}$  ft. = 14.7 ft. Each candle-power at  $r$  must be reduced proportionately, so that 1 candle at  $r$  would give 1-216 candle-foot at the point in question. According to our hypothesis, diffu-

sion aids by 50 per cent., so that instead of requiring 216 candle-power to give 1 candle-foot in the remotest corner, the real amount would be 144 candle-power, which would be handily furnished by a cluster of nine 16-cp incandescent lamps. The result would be a room quite brilliantly lighted, for, except very near the walls, the illumination would be much in excess of 1 candle-foot, rising to 4 or 5 candle-feet upon the plane of lighting under and near the lights.

Such an arrangement of the lights is, however, uneconomical in the extreme, since the distant corners are

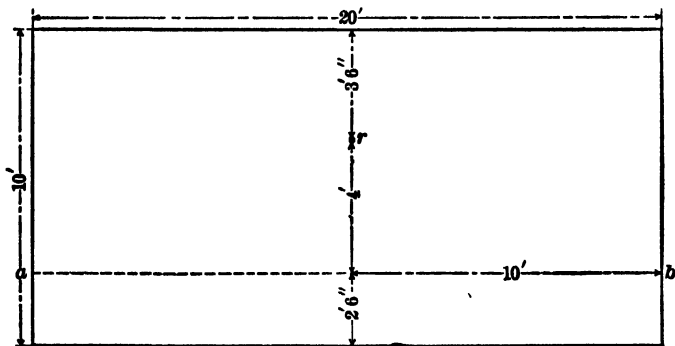

Fig. 79.—Vertical Section of Room.

illuminated at a very great disadvantage. Fig. 80 shows the advantage gained by a rearrangement. Here the room is divided by imaginary lines into four 10-ft. squares, and in the center of each of these is a light 6' 6" above the floor, as before. Now, if a corner of the plane of lighting, as *E*, receives 1 candle-foot, the requirements are fulfilled. But *E* is distant from *D* just about 8 ft., from *C* and *B* almost exactly 16 ft. and from *A* less than 22 ft. It, therefore, receives, neglecting *A*, for each candle-power at *D* 1-64 candle-foot, and for each at *C*

and *B* a total of 1-128 candle-foot, or, allowing for diffusion, 1-43 and 1-87, respectively (nearly), so that it at once becomes evident that four 32-cp lamps are more than sufficient to do the work.

Taking *A* into account, four 25-cp lamps would almost suffice, but obviously the maximum illumination is perceptibly lowered. It would be a maximum at the center, and for 32-cp lamps would there amount to 2 candle-feet. A still further subdivision would lead to

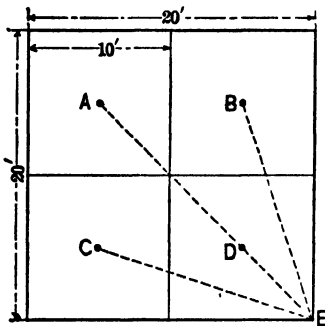

Fig. 80.—Floor Plan

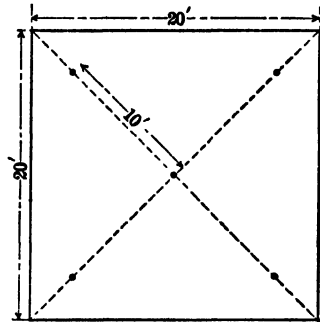

Fig. 81.—Floor Plan.

still better distribution from the point of view of economy, and, indeed, something can still be gained by a further redistribution of the light. For, with lights arranged as in Fig. 81, at the center and on the circle inscribed in the room in question, five 20-cp lamps would very closely fulfill the conditions, reducing the total amount of light required to meet the assumed condition from 144 to 100 candle-power in all.

Obviously, with a fixed minimum illumination and no other requirement, the conditions of economy will be most nearly met by a nearly uniform distribution of the minimum intensity required. There is, however, a limit to practical subdivision in limited areas, such as

rooms. In the case of large buildings, as we shall presently see, one can easily figure out the illumination on the basis just taken, but in domestic lighting we have to deal with a very limited number of radiants, at least in considering gas and electricity.

By far the best results are attained by providing a very moderate general illumination and then superposing upon it strong local illumination for special purposes. For example, in most rooms better practical results than those of Fig. 81 would be reached by following the same arrangement, but using four 16-cp or even four 8-cp lamps and one 32-cp lamp, the latter being placed near the point where the strongest illumination is required. The result would be to give the extreme corners all the light they really need, and to provide plenty of light where it is of most practical value.

The same rules apply to the use of gas or other illuminants, always bearing in mind that the total amount of light required is strongly affected by the hue of the walls, and that the principal radiant should be placed where it will do the most good. Illumination thus regulated is both safer physiologically and far more efficient in use of the material than any attempt at uniform distribution over the entire area.

One's choice of illuminants must obviously be governed by the question of availability. Incandescent electric lamps easily hold the first place when economy is not the first consideration, by reason of their being quite steady, giving out little heat, and in no way vitiating the atmosphere. They should *always*, however, be furnished with ground bulbs, or so shaded as to reduce their otherwise very high intrinsic brilliancy.

Next in order of desirability unquestionably comes

gas. Used with the incandescent mantle burner, it is the cheapest known illuminant for domestic purposes, but in this form is too bright for anything except the principal radiant. Mantle burners should always be shaded, both to reduce the intrinsic brilliancy and to modify the greenish cast of the light which otherwise is highly objectionable. Ordinary gas jets, if the pressure be fairly steady, give a good subordinate illumination.

Lamps and candles have strong merits for particular purposes, but are inferior for general work. The former are often used with good effect to furnish the principal radiant, which may be re-enforced by small gas jets. Candles, on the other hand, are extremely useful for partial and subsidiary illumination, since they are the only available source of small intensity unless one goes to considerable trouble in wiring for tiny electric bulbs, which are better adapted to purely decorative purposes than to the regular work of illumination.

From this general basis of facts we can now take up the practical and concrete side of domestic lighting.

As to the distribution of the lights required for interior illumination, one must be guided by the intensity which is necessary. The examples already given show the general character of the problem. The laws upon which the solution depend may be formulated as follows: If we write  $L$  for the required or existing intensity of illumination in candle-feet at any point,  $C$  for the candle-power of the radiant, and  $d$  for the distance in feet from that radiant, then:

$$L = \frac{C}{d^2} \qquad C = L d^2 \qquad d = \sqrt{\frac{C}{L}}$$

If the point in question receives light from more than

one radiant, the illuminative effects must be summed, and, if the radiants are equal,

$$L = C \left( \frac{1}{d^2} + \frac{1}{d_1^2} \cdots \frac{1}{d_n^2} \right) \left( \frac{1}{1-k} \right)$$

$$C = \frac{L}{\left( \frac{1}{d^2} + \frac{1}{d_1^2} + \cdots \frac{1}{d_n^2} \right) \left( \frac{1}{1-k} \right)}$$

$L$  is of course in candle-feet and  $C$  in candle-power. In these expressions no account is taken of the varying angles of incidence of the light received from the several radiants. In principle,  $L = \frac{C \cos i}{d^2}$ , where  $i$  is the angle of incidence; in other words, the illumination decreases as it becomes oblique.

In certain cases account must be taken of this fact, but since, as a rule, objects to be lighted are oblique to the plane of illumination, and  $\cos i$  is small only in case of rather distant lights, of which the entire effect is small, and since the diffused light cannot be reckoned with, having no determinate direction, the question of obliquity, particularly when the radiants are numerous and well distributed, has seldom to be dealt with. It is rendered the more uncertain by the notorious inequality of the distribution of the light from ordinary illuminants, and it must be remembered that the whole aspect of the matter is changed by the use of reflectors.

In ordinary interior illumination one constantly meets limitations imposed by structural or artistic considerations. For example, we have already seen that the arrangement shown in Fig. 81 was highly desirable for economic reasons. The five lamps dangling by cords

or rods, however ornamental, from the ceiling of a room 20 ft. square, might be tolerated in an office, but would be quite inadmissible in a drawing room. For domestic lighting one is practically confined to chandeliers, side lights, or ceiling lights. The latter have been considerably used of late, sometimes with beautiful effects; sometimes unwisely.

To examine the effect of ceiling lights on the situation, refer to Fig. 82, which shows the same room as Fig. 79.

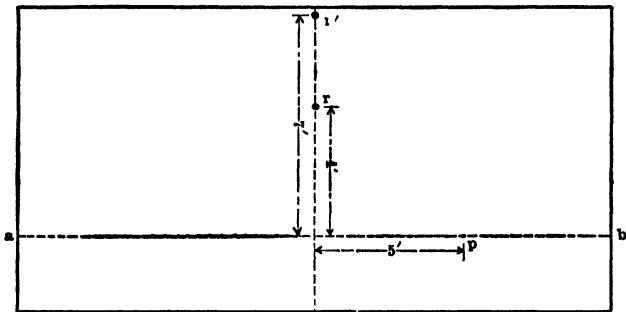

Fig. 82.—Location of Ceiling Lights

Assuming the same general conditions, let us find the illumination at a point  $p$  in the plane of illumination when given by a light  $r$  in the old position, and a ceiling light  $r'$ , 6 ins. below the ceiling. The light being of 16 candle-power, the light at  $p$  is  $L = \frac{16}{41} = .39$  candle-foot, when the lamp is at  $r$ , or  $L = \frac{16}{74} = .21$  when the lamp is at  $r'$ , close to the ceiling, neglecting diffused light.

In a room very bright with white paint or paper, having, for example,  $k = .60$  and  $\left(\frac{1}{1-k}\right) = 2.50$ , the total



illumination would be  $.39 + .97 = 1.36$ , and since the diffusion does not materially change with the position of the light, the illumination in the second case would be, roughly,  $.21 + .97 = 1.18$ ; in other words, the change in position of the light would make but a small change in the intensity of the illumination.

There is evidently some error made in assuming that diffusion increases the illumination by a certain *ratio*, and Wybauw's hypothesis of replacing the diffused light by an imaginary radiant directly above the real radiant involves the same error. It is probably nearer the truth to assume, in case of an apartment having several radiants, that the total illumination at any point is that due to the lights severally, plus a uniform illumination, due to diffusion and proportional to  $k$  and  $C$ .

The practical upshot of the matter, however one may theorize on the rather hazy data, is that shifting the lights in a room from their usual height to the ceiling does not affect the illumination seriously if the walls and ceiling diffuse strongly, while if they are dark the change is decidedly unfavorable. This does not, however, imply that ceiling lights should not be used in dark-finished rooms, although it is very plain that if they are so used the lamps should be provided with reflectors, or themselves form reflectors, as in some lamps recently introduced.

If the walls have a very low coefficient of diffusion it is obvious that all light falling upon them is nearly wasted, at least from the standpoint of illumination, and therefore the economic procedure is to deflect this light so that instead of falling upon the walls it shall be directed upon the plane of illumination, which is chosen to represent the average height from the floor at which

are the things to be illuminated. If reflectors or their equivalents are skillfully applied, the radiants, for the purpose in hand, are nearly or quite doubled in intensity, so that there is a good opportunity for efficient lighting. But these reflecting media must be used with caution to avoid the appearance of beams giving definite bright areas, and by far the best results may be obtained by using ground or frosted bulbs in such cases. So far as economy of light is concerned, reflectors can be advantageously used wherever the effective reflection exceeds the total diffusion coefficient of the walls. For example, with a hemispherical reflector having a coefficient of reflection of .70, the hemispherical intensity of the radiant is 1.70 *C*. assuming a spherical distribution of the light. This value corresponds, so far as the plane of illumination is concerned, with a diffusion of  $k = .40$ , which signifies that, except in very light-finished rooms, the radiant is used more efficiently by employing a reflector than by trusting to the really very serviceable diffusion from the walls.

But if the reflector aperture be as great as a hemisphere, there is still some material aid to be gained by diffusion. In the case already discussed in Fig. 81, if reflector lamps were used, five 16-cp lamps would meet the requirements, and would fall but a trifle below the requirements even if used as ceiling lamps.

It is safe to say that by the use of reflector lamps the work of effective lighting from the ceiling is made fairly easy, if the ceilings are of ordinary height. Without reflectors it is a method greatly lacking in economy.

The use of side lights close to the wall, or on short brackets, is preferable to lighting from the ceiling when the latter is high, or when, as often happens, strong

local illumination is needed. Reflector lamps may here again be used with very great effect if the walls are at all dark in tone. Fig. 83 gives in diagram the simplest arrangement of such lamps. We may assume their height as a trifle less than in the case of the suspended lights, say, 3 ft. above the plane of illumination, and that they are equipped with reflectors giving a hemispherical distribution of light. In Fig. 83 the positions

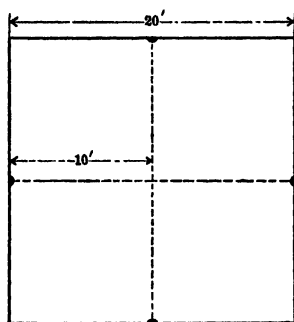

Fig. 83 —Side Lights.

of the lamps are indicated by black dots, as before. It is evident that the corners will be the points of minimum illumination, and that in the central part of the room the lighting will be rather weak, although, on the whole, the distribution of light will be good. With help from diffusion to the extent assumed in the last example, four 20-cp reflector lamps would do the work, while with dark walls the case would call for four 32-cp lamps.

Now, summarizing our tentative arrangements of light, it appears that to illuminate a room 20 ft. square and 10 ft. high on the basis of a minimum of 1 candle-foot, will require from 80 to 144 effective candle-power,

according to the arrangement of the lights, if the finish is light, and half as much again, at least, if the finish is dark. The floor space being 400 sq. ft., it appears that the illumination is on the basis of about 3 to 5 sq. ft. per effective candle-power. The former figure will give good illumination under all ordinary conditions; the latter demands a combination of light finish and very skillfully arranged lights.

For very brilliant effects, no more than 2 sq. ft. per candle should be allowed, while if economy is an object, 1-cp to 4 sq. ft. will furnish a very good groundwork of illumination, to be strengthened locally by a drop-light or reading lamp. The intensity thus deduced we may compare to advantage with the results obtained by various investigators, reducing them all to such terms as will apply to the assumed room which we have had under discussion.

Just deduced.....	1-cp per 3	sq. ft.
Uppenborn.....	1-cp per 3	6 sq. ft.
Piazzoli.....	1-cp per 3	5 sq. ft.
Fontaine. ....	1-cp per 7.0	sq. ft. (approximation).

In very high rooms the illumination just indicated must be materially increased, owing to the usual necessity for placing the lamps rather higher than in the case just given, and on account of the lessened aid received from diffuse reflection. The amount of this increase is rather uncertain, but in very high rooms it would be wise to allow certainly 1-cp for every 2 sq. ft., and sometimes, as in ballrooms and other special cases requiring the most brilliant lighting, as much as 1-cp per square foot.

On the other hand, in most domestic lighting, the amount of lighting needed may be reduced by a little

tact. Ordinary living rooms, such as parlors, libraries, and the like, do not require to be uniformly and brightly lighted in most cases. It is sufficient if there is ample light throughout the main portion of the room.

A groundwork illumination of 0.5 candle-foot over the whole room, plus a working illumination of 1 to 1.5 candle-foot in addition over a part of the room, gives an excellent result. This is something the result that would be reached in Fig. 81 by using a 32-cp central lamp and four 10-cp lamps for the rest of the room. Dining rooms need ample light upon the table, but do not in the least require illumination of equal power in the remote corners. Sleeping and dressing rooms do not require strong light so much as well-placed light. A bedroom of the dimensions we have been discussing could be very effectively lighted with three or four 16-cp lamps, provided they were placed where they would do the most good.

To go into detail a little, perhaps the most important rule for domestic lighting is never to use, indoors, an incandescent or other brilliant light, *unshaded*. Ground or frosted bulbs are particularly good when incandescents are used, and opal shades, or holophane globes, which also reduce the intrinsic brilliancy, are available with almost any kind of radiant. Ornamental shades of tinted glass or of fabrics are exceedingly useful now and then, when arranged to harmonize with their surroundings.

In incandescent lighting the lamps may be placed in any position. With gas or other flame radiants ceiling lights are not practicable. As to the intensity of the individual radiants, considerable latitude may be given. In many instances, incandescents or gas or other lights

of as low as 8 to 10-cp are convenient, while for stronger illumination radiants of 15 to 20-cp reduce the cost of installation, and for special purposes lights of 30 to 50-cp, incandescents or incandescent gas lamps, are most useful. To get a clear view of the application of the principles here laid down it will be well to take up in some detail the illumination of a typical modern house in its various particulars.

Beginning at the porch, the light here is of purely utilitarian value. One 32-cp incandescent or its equivalent in gas would generally be sufficient, enclosed in an inoffensive antique iron lantern. Fig. 84 shows a fine specimen of eighteenth century ironwork.

*Hall.*—Assumed dimensions, 15 ft. x 20 ft., finished in some combination like ebony and old yellow. Generally the staircase forbids the effective use of a chandelier, and lights can best be put upon wrought-iron side-brackets. The lighting required for the 300 sq. ft. is not strong, and four 16-cp or eight 8-cp units, arranged on two or four brackets, would give all the illumination ever required. Fig. 85, an antique two-light iron bracket, will give a useful hint. Lanterns are often used here, but they generally are in the way.

*Library.*—Assumed, 20 ft. x 20 ft., in mahogany and dull green. The form of the room and the presence of bookcases complicate the illumination. The bookcases, unless so much space is absolutely necessary, should not be carried to the ceiling. The conditions are severe. With incandescents very good results could be reached by, say, twelve 8-cp ground-bulb, reflector lamps, worked into the frieze, and a reading lamp of not less than 32-cp, as a drop-light, preferably with a tinted holophane or other globe. With gas, or with high bookcases,

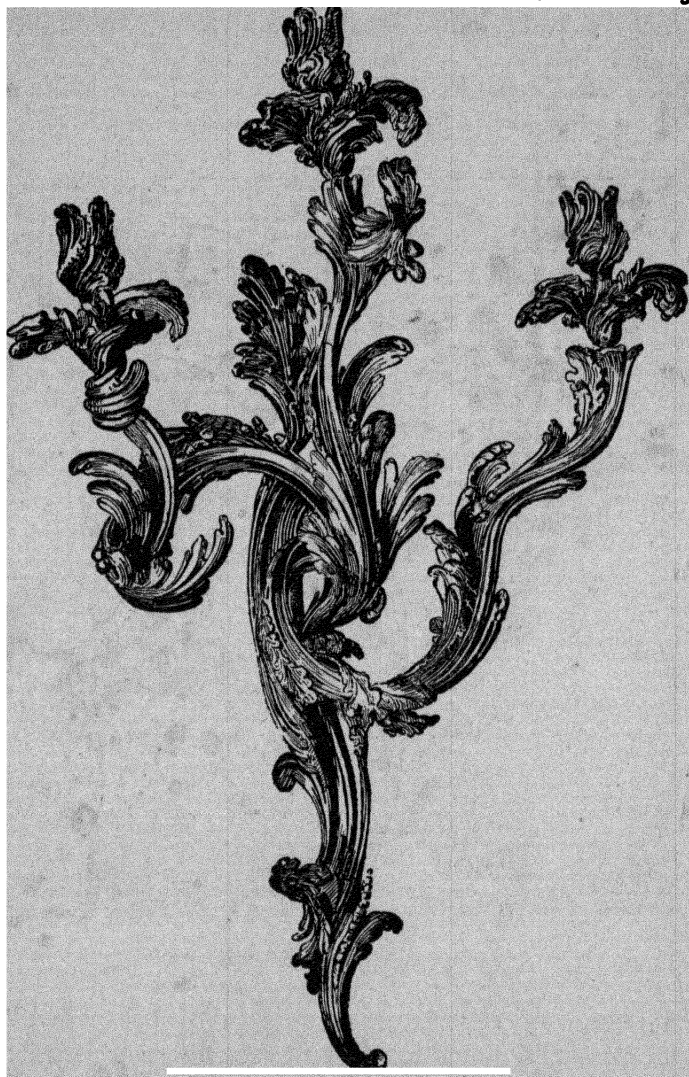

Fig. 86.—Gilt Bronze Bracket.

ballroom, in case of electric lighting provision should be made for replacing the 8-cp by 32-cp lamps. With

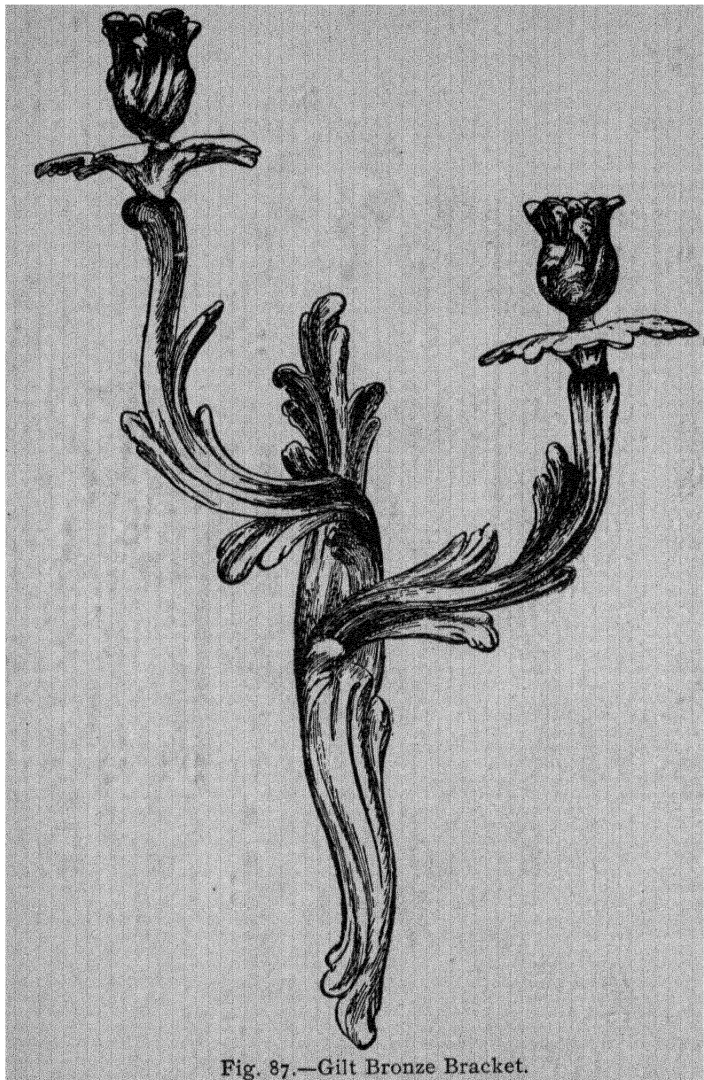

Fig. 87.—Gilt Bronze Bracket.

gas, the fixtures should be planned so as to provide additional lamps. Figs. 86 and 87 show two examples of



fine eighteenth century *bras de cheminée* well adapted to cases like the present.

*Dining Room.*—Assumed, 15 ft. x 20 ft., in dark antique oak or mahogany and tapestries or other dark wall



FIG 88.—Wrought-Iron Bracket.

finish. Here ceiling or frieze lamps are in place, one or the other, according to the nature of the finish. Eight 8-cp reflector lamps, ground, worked into the decoration, would give a good groundwork, backed up by, say,

six more 8-cp or 10-cp ground-bulb lamps, on wrought-iron brackets, of which Fig. 88 gives an excellent antique specimen, flanking the mantle, or, for a yet better artistic effect, by shaded candelabra upon the table itself. Using gas, one would almost be driven to an elaboration of the side brackets, or to a chandelier, too often an abomination, and always difficult to make artistic in such a place.

*Billiard Room.*—Assumed, 15 ft. x 20 ft. Dull reds and greens in finish. Lighting here must be utilitarian. It requires four 32-cp lamps bearing directly upon the table. Incandescents or mantle burners in holophane globes, or with slightly translucent reflectors, answer the purpose well.

*Six Bedrooms.*—Assumed, 15 ft. x 15 ft., finished in cream or other light paint and with rather light walls. In the smaller rooms, two 16-cp lights bearing upon the dressing table are ample, and in the larger rooms these with an additional bracket, carrying another 16-cp lamp, are all that would be required.

*Two Dressing Rooms.*—Assumed, 10 ft. x 15 ft., in light finish, like the chambers. Two 16-cp lamps, bearing on the dressing table, will do the work well. Brackets here and in chambers should generally be of gilt brass.

*Three Bathrooms.*—Assumed, 8 ft. x 10 ft., in white and Delft blue or the like. One 16-cp light, carried on bracket, is sufficient.

*Three Servants' Rooms.*—Assumed, 10 ft. x 15 ft. Light finish. One 16-cp lamp, bracketed, near dressing table.

*Kitchen.*—Assumed, 15 ft. x 15 ft. Light wood and paint. Two 16-cp lamps.

*Pantry.*—Assumed, 10 ft. x 15 ft. One 16-cp.

Back hall, laundry, and cellar would be lighted with 8-cp lamps, in all to the number of about ten. Upstairs halls, three 16-cp.

This programme is merely intended as a hint about the requirements, and while it is laid out for a fairly large house, containing twenty rooms and three baths, its details will furnish suggestions applicable to many places. In closing, it is worth mentioning that where incandescents are available, an 8-cp lamp of the reflector variety should be placed in the ceiling of every large closet, and controlled by a switch from the room or by an automatic switch, turning it on when the door is fully opened.

The lighting just described may be summarized as follows:

ROOM.	8-CP	16-CP	32-CP.	SQ. FT PER CP	REMARKS.
Hall.....	8			4.7	8-cp reflector lamps
Library.....	12		1	3.1	
Reception room....	4			7.0	Eight reflector lamps 32-cp with reflectors
Music room.....	12		2	3.0	
Dining room.....	14			2.7	
Billiard room.....			4	2.3	
Porch.....			1		
Bedrooms (6)....		14		7.0	
Dressing rooms (2)....		4		4.7	
Servants' rooms (3)....		3		9.4	
Bathrooms (3)....		3		5.0	
Kitchen }					
Pantry }		3			
Halls }					
Cellar }	10	3			Reflector lamps
Closets (4).....	4				
Total.....	64	30	8		

The noticeable thing about this table is the large number of 8-cp lamps. These are for the purpose of giving good distribution of light in the rooms where it is most necessary. The total is equivalent to 78 16-cp lamps, by no means a large installation for a house of this size. In using gas, mantle burners should be used where 32-cp lamps are indicated. These should always be given pinkish or yellowish shades, to kill the greenish tinge of the light. Pink glass shades, or, better, holophane globes, are useful, or very diaphanous ornamental fabric shades, lightly dyed with erythrosine, aurine, or saffronine. The former is rather fugitive, although perhaps the best in tint. In a room with red walls of almost any shade, the diffused light partially corrects the greenish tint of the radiant, but the light itself is too bright to go without shading in any event. Mantle burners greatly economize the use of gas, and when properly shaded may be advantageously used almost anywhere, since they use just about the same amount of gas as ordinary burners and give about three times as much light. They are much too powerful to give the best artistic results, however, unless very cautiously used. In applying them to a case such as that we have just been considering, they should be regarded as equivalent to two 16-cp incandescents, for, while really somewhat brighter than this suggestion would indicate, a single radiant is less effective than two, each of half the given power.

## CHAPTER X.

### LIGHTING LARGE INTERIORS.

THIS branch of illumination differs from ordinary domestic lighting in several important particulars. In the first place, the aid received from diffusion from the walls is much less than in the case of smaller rooms, as has already been indicated. The experiments of Fontaine indicate that within moderate limits the light required is determined by the volume of the space to be illuminated, rather than by the floor space. That is, in a given room, doubling the height of the ceiling should double the light required for proper illumination.

Since, however, the only physical effect of the increased height is to increase the mean distances of the diffusing surfaces from the radiants and hence slightly to diminish the significant ratio  $\left(\frac{1}{1-k}\right)$ , the change could, in point of fact, alter only that part of the total illumination due to diffused light, provided that with increased height of ceiling the radiants are not themselves raised. Hence only in the case of walls capable of very brilliant diffusion can the variation due to increased dimensions alone approach the magnitude indicated by Fontaine's empirical rule, which, however, possesses the merit of causing one to err in the right direction and to give ample illumination.

In large and high rooms there is a strong tendency to increase the height of the radiants above the plane of

illumination, especially in case of using chandeliers, and this is perhaps an important factor in the rule aforesaid. Obviously in increasing the distance of the radiants one decreases the direct illumination approximately in the ratio of the inverse squares of the distances, and does not materially improve the diffusion.

Therefore the illumination falls off seriously. In a large and high hall lights arranged in the ceiling or as a frieze, while often giving admirable effects, are quite uneconomical, and should be used, if at all, with a full appreciation of this fact. If for artistic or other reasons the lights must be placed high, reflector lamps, or their equivalent, are strongly to be recommended.

In large buildings, too, the quantity of light required is subject to enormous variation, according to the purposes to which the building is devoted, and whether the whole interior must for artistic reasons be illuminated. In a ballroom an effect of great brilliancy is generally aimed at, while a room of equal size used as a factory needs strong illumination only where it will facilitate the work.

Again, in very large rooms the power of the individual radiants can advantageously be increased, and some sources of light inadmissible in domestic lighting—such as arc lamps and large regenerative gas burners, or to be used only with caution, like mantle gas burners—may be used very freely.

But in large buildings, as elsewhere, the fundamental purpose of the lighting is to produce a certain intensity at the plane of illumination, which in such work should be assumed about three feet above the floor. The absolute illumination required may vary greatly, over a range, in fact, as great as from half a candle-foot to two

candle-feet or even more, but the lighting may properly be calculated from an assumed value, just as in the case already discussed.

For purposes of discussion, we may first consider a hall 100 ft. long by 30 ft. high by 50 ft. wide. The plane of illumination will then have an area of 5000 sq. ft., and the total volume is 150,000 cu. ft. And for simplicity

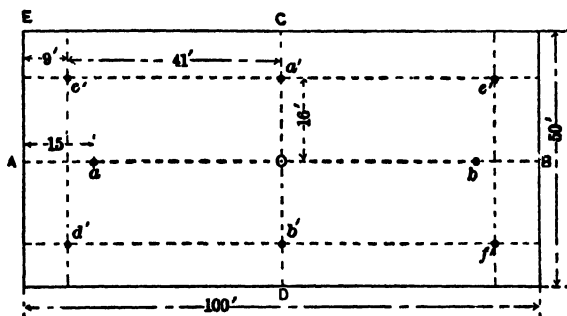

Fig 89.—Plan of Hall

we will assume 1 candle-foot as the minimum intensity to be permitted in any part of the space. Fig. 89 shows the plan of this assumed space. We will first take up the case of suspended radiants, which is the most usual method of treating such a problem.

Obviously in a room of the shape given a single radiant is out of the question, on the ground of economy, since in meeting the requirement of a given minimum of illumination the most economical arrangement is that which exceeds this minimum at the fewest points possible. Two radiants give a possible solution, and are worth a trial. Clearly they must be located on the major axis of the room *AB*; but since a corner, as *E*, is the most unfavorable spot to light, the radiants must be placed well toward the ends of the room. We will as-

sume their height as 15 ft. above the floor, and 12 ft. above the plane of illumination.

Now the best position of a given radiant  $a$  is easily determined—it is such that, calling the projections of the points  $E$  and  $C$  upon the plane of illumination  $E^1$  and  $C^1$ ,  $a C^1 = a E^1 \sqrt{2}$ , approximately. To fulfill this condition  $A a = B b = 15'$  very nearly, and the two radiants are at once located. In this case  $d^2 = 994$ , and since  $C = L d^2$ ,  $C$  should be practically 1000 candle-power. Allowing  $\left(\frac{1}{1-k}\right) = 1.5$ , each of the radiants should be of about 666 candle-power, a requirement which could be practically met by a nominal 2000-cp open arc, if its glare were not so forbidding.

Using incandescents, 42 of 16 candle-power would be required in each group, which should be increased to about 60 if ground bulbs in a chandelier were to be used, since lamps so mounted interfere with each other's effectiveness to a certain extent. Reducing these figures to square feet per candle-power, it appears that the assumed conditions are satisfied by allowing as a maximum about 3.75 sq. ft. per candle-power, or with allowance for properly softening the light, 2.6 sq. ft. per candle-power.

Lighting such a space from two points only is usually by no means the best way, and a much better effect would be secured by using six radiants. The same reasoning which led us to place  $a$  and  $b$  near the ends of the major axis of the room indicates a similar shifting in the case of six lights. From symmetry, two should be on the minor axis  $D O C$ , and as regards the projections of  $C$  and  $O$  on the plane of illumination, the best position for a radiant, located in the same horizontal plane as



before, is at  $a^1$ , about 6' from  $O$ , with  $b^1$  at a corresponding point on the other side of  $O$ . Now for the lateral pairs of lights. One of them may be approximately located with reference to  $E^1$ , and the projection of the middle point of the line to  $a^1$ , much as  $a^1$  itself was located. This leads to a position  $c^1$ , 4.1' from  $a^1$  and 9' from the wall. Forming now the equation

$$C = \frac{L}{n \left( \frac{1}{d^2} + \&c. \right)}, \quad d^2 = 306, \quad d_1^2 = 1906,$$

and the sum of the other terms is little greater than the term in  $d_1^2$ . Simplifying thus, the candle-power of each radiant comes out very nearly 235, without allowance for diffusion on the one hand or for ground bulbs and incidental losses on the other.

Setting these off against each other, it appears that the conditions call for 15, 16-cp lamps in each of the six groups, a total of 90 as against 120 in the previous arrangement. The total rated candle-power is then 1440, or 1 candle-power for every 3.5 sq. ft.

It is interesting to check this computation, based entirely on an assumed minimum illumination of 1 candle-foot, with the result of experiment. For large rooms, ranging from about 1000 to 5000 sq. ft. in area, Uppenborn's careful investigations show that for good illumination 3 to 3.5 sq. ft. per candle-power is the amount required in practice. In most cases these large spaces are finished in light color, so that in spite of the high ceilings they are scarcely more difficult to light than ordinary dwellings. The absolute brilliancy required is determined by the purpose of the illumination, and the proper arrangement of the lights depends largely on

architectural considerations. Oftentimes frieze and ceiling lights are used in halls, and their application to the case in hand is worth considering.

If arranged as a frieze, the lamps would be equally spaced around the walls, at about 5 ft. below the ceiling, bringing them 22 ft. above the plane of illumination. For simplicity we will assume the use of 90 16-cp reflector lamps, or their equivalent. Each gives approximately 27 candle-power in its hemisphere of illumination. These lamps would be spaced a little more than 3 ft. apart, giving 30 on each side of the hall and 15 on each end. Now, taking for examination the corner  $E^1$ , which is as unfavorable a locality as any, and roughly running up the illumination at this point, it falls a little short of 1 candle-foot, but a diffusion factor of 1.25 would carry it just about to the required amount. With lightly ground bulbs, which are far preferable to the clear ones in such a case, an increase to 36 lamps on each side and 18 on each end would be desirable, and 40 and 20 on sides and ends respectively would do still better.

With the original 90 lamps the total rated hemispherical candle-power would be 2430, which is at the rate of 2.06 sq. ft. per candle-power.

Lighting from the ceiling would lead to a slightly worse result, and it is safe to say that an increase of 30 to 50 per cent. in the total candle-power of the radiants is required in changing to frieze or ceiling lighting from pendent or side lights. Lights so arranged, however, can give a very valuable groundwork of illumination when re-enforced by lights more favorably placed. They have the advantage of being unobtrusive and of producing a generally brilliant effect, but give, if used

to the exclusion of everything else, an illumination painfully lacking in *chiar-oscuro*, and light directed almost entirely downwards is, moreover, somewhat trying, like a stage scene in the absence of footlights.

As has been already explained, the illumination at any particular point should have a predominant direction, else the effect on the eyes is apt to be serious. A room lighted by brilliantly phosphorescent wall paper, for example, would produce a most disagreeable effect unless the luminosity were confined to one side, or, in general, to limited portions of wall.

Something of the same objection appertains to ceiling or frieze lighting when pushed to an extreme. In the room under discussion, the best general effect would probably be produced by combining pendent or bracketed lights with about an equal amount of illumination from frieze or ceiling lights. If the room were to be used for purposes like manufacturing, lighting from rather powerful incandescents, in part with reflectors, placed at a convenient height above the machines, would be the most efficient procedure.

Where merely rough work is being done, arcs may be effectively used, always, however, shaded by ground or similar globes. These are distinctly cheaper, because more efficient, than incandescents, but their light lacks the steadiness desirable for work requiring close attention. Six 350-watt arcs would give, in the room shown in Fig. 89, very good illumination when placed in approximately the positions deduced for the six chandeliers, with a total expenditure of 2100 watts as against about 4500 watts required by the clustered incandescents, and, say, 3600 watts required by about 36 pendent 32-cp lamps. In many cases less light than this would

be required, and the total amount of energy could be correspondingly reduced, but about the above ratios would hold good.

From Fig. 89 it appears that in using arcs, about 2000 to 2500 sq. ft. may be assigned to each 500-watt arc, and 1000 to 1500 sq. ft. to each 350-watt arc. It should be remembered that the enclosed arcs with inner globes are somewhat less efficient than this, although greatly to be preferred by reason of their steadiness, and that alternating arcs are slightly less efficient than continuous-current arcs.

Arcs do their best work when placed fairly high and used in cases where protracted close attention on the part of the workmen is not necessary. They are somewhat preferable to incandescents, too, when colored objects are to be illuminated.

In workshops where special objects are to be illuminated, arcs are at a great disadvantage with respect to the distribution of light, since their relatively small number forbids placing them in the most advantageous positions with respect to all the machines. They have, in short, the disadvantage of being radiants too powerful for the best distribution. It is thus found that in practical illumination arcs are considerably less efficient than their actual candle-power would indicate. The effect of the bright radiant upon the eyes, the rather dense shadows and the slanting light at a distance from the arc, unite to produce results that cannot be predicated from photometric measurements alone.

For example, a 350-watt open arc is, in point of mean spherical candle-power, closely equivalent to ten 32-cp incandescent lamps; but in an actual installation in-doors there are few cases in which the arc could not be replaced

by six such incandescents without detriment to the illumination. These interesting questions will be the object of some future attention, but the obvious continuation of the present problem is the adaptation of gas lighting to the case in hand.

If mere illumination is the object to be attained, there is little doubt that mantle burners should invariably be used in rooms of the size considered. As already intimated, each such burner of the ordinary size is equivalent to about two 16-cp distributed incandescents. If the lamps are grouped in each case, the mantle burner must be given a rather better rating, being equivalent to between 2.5 and 3 such incandescents. Properly shaded, the mantle burner is a very economical and effective illuminant. Were it not for the very objectionable color of the unshaded light, it would be much more extensively used than it is at present.

For lighting large areas, like the one we have been considering, it is very well adapted, but if the lights are placed high it is necessary not only so to shade them as to correct the color, but they must in addition be furnished with such shades or reflectors as will throw the light downward; for it must be remembered that mantle burners must be placed with the mantle in a substantially vertical position, and give the maximum intensity of light a little above rather than below the horizontal plane, while incandescent lamps, which we have been chiefly considering, throw the light in more nearly a spherical distribution, although really considerably departing from it. Reflectors or holophane globes used with the mantle burners will correct this faulty distribution and enable them to be used more effectively in the case in hand.

In rooms lower than that already considered it is desirable to increase the number of radiants considerably, to avoid too oblique illumination at the more distant part of the field of each light.

With higher rooms, on the contrary, one can concen-

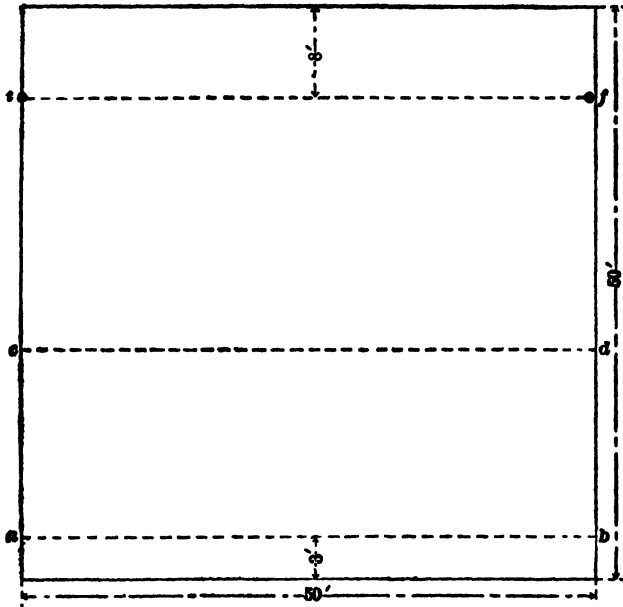

FIG. 90.—Vertical Section of Hall.

trate the radiants more advantageously, and has considerable more liberty of action in placing the lights.

Fig. 90 is intended to illustrate the conditions which exist in a very high room of fairly large area. It shows in vertical section a room supposed to be 50 ft. square and 50 ft. high, the plane of illumination, *a b*, being 3 ft. from the floor. We have here 2500 sq. ft. of floor surface. At the ordinary rate of 3 sq. ft. per candle,

this would demand 833 candle-power, or practically 52 16-cp lamps, or, with a coefficient of diffusion of 1.50, about 36 such lamps.

But the previous calculations having been made for a room only one-half this height, and with lamps placed considerably below the ceiling, it is clear that the greatly increased height in the present case will lead to somewhat different conditions unless the lamps are to be dropped very far below the ceiling—so low as to produce a decidedly unpleasing effect. Lamps placed, for example, in the plane *c d*, corresponding to frieze lamps in the previous instance, are too low to look well, while they would, on the basis just given, furnish the room with satisfactory illumination. If placed on side brackets at or below the plane *c d*, they would work well on the floor, but would produce the effect of the ceiling fading into dimness unless the ceiling itself had an extremely light finish.

Such a room, therefore, while very easy to light thoroughly, is very difficult to light both thoroughly and with good artistic results. Rooms of such dimensions are seldom used for manufacturing purposes, these shapes occurring more frequently in rooms for public uses of various kinds.

Without going into detailed computation which the reader can readily make for himself in the light of previous work on Fig. 89, it is safe to say that by far the best general effects would be produced by placing perhaps one-third of the total candle-power in 8-cp reflector lamps as a frieze, 8 or 10 ft below the ceiling, in the line *e, f*, or thereabouts, and putting the remainder on brackets, in groups of three to six, a little below the plane *c d*. Such an arrangement obviously loses somewhat in the

efficient disposition of light, on account of the great height of the lamps in the frieze, which can be depended on only for a rather faint groundwork of illumination on the plane of illumination *a, b*. If, for example, the total installation consists of 600 candle-power, of which 200 is in the frieze, the mean distance of the frieze lamps from a point, say, in the middle of the floor, would be in the vicinity of 45 ft.

Consequently, allowing for the effect of the reflectors of the frieze lamps, and for what each can do by diffusion, it is safe to say that the frieze lamps would give an illumination of not over one-fifth candle-foot on the plane of illumination. Hence, something like eight-tenths candle-foot would have to be furnished by the lights upon brackets. The amount of light furnished by these would therefore have to be about eight-tenths of the total illumination, as determined by lights placed in the relative position shown by Fig. 89, that is, the ceiling lights of one-third the total candle-power really would be furnishing not over one-fifth of the total light, which means that for lights placed as just indicated, the total candle-power installed should be increased somewhere from 25 to 33 per cent. or rather more, as the bracket lights cannot be conveniently placed in favorable situations.

Hence in a room so illuminated it would not be safe to allow more than 2 to  $2\frac{1}{2}$  sq. ft. of floor space per candle-power, and generally nearer the former figure than the latter. To attempt the lighting of such a room by frieze or ceiling lights, as ordinarily placed, would be wasteful. If economy is not an important factor in designing the illumination, at least half the lights may be placed in the frieze with a distinct gain in artistic effect.



In such case the total installation should be fully 50 per cent. greater than the minimum required. We shall see, however, that there are effective methods of getting a strong groundwork illumination from above without resorting to either of these methods.

To follow up the effect of raising the lights in a high room still further, it is well to note that the critical point is the amount of available diffusion. If one were dealing with a room lined with black velvet, or with translucent walls, in which there is only a very minute amount of diffused light, raising the lights would diminish the illumination almost exactly according to the law of inverse squares.

Writing now  $K$  for the coefficient of diffusion denoted by the fraction  $\left(\frac{1}{1-k}\right)$ , and recurring to the formulæ previously given for illumination, we have at once  $K C = L d^2$ , and for fixed values of  $C$  and  $L$ ,  $d = P \sqrt{K}$ , where  $P$  is a constant. Hence we may conclude that for any desired value of the illumination with a fixed amount of lights available, the height to which these lights can be raised and still produce the required effect is approximately *proportional to the square root of the coefficient of diffusion*.

The moral of this is tolerably obvious. If one deals with a dome finished, let us say, in white and gold, it may be permissible to place a large part of the lights fairly high up, while in a church with a vaulted roof in dark oak, lights placed high are nearly useless for purposes of illumination. In such a case lights placed at the level of the roof beams and unprovided with reflectors have barely more than a decorative value, and should be treated essentially as a decorative feature, use-

ful for bringing out the details of the architectural design.

Any real illumination must be accomplished by lamps with reflectors or by lamps placed down nearer the plane of illumination. In these dark interiors reflector lamps can be used to especial advantage, since the coefficient of diffusion is so small that the lessened diffusion due to the partially directed beams from reflector lamps is of trivial consequence. In fact, there are few cases in which reflectors cannot be used to advantage in rooms having very high roofs.

Churches are generally badly lighted, and are, in fact, rather difficult of treatment, if of any considerable size. They are seldom brilliant in interior finish, usually have rather high vaulted roofs, and require good reading illumination. The few cases in which their form approximates to Fig. 89 may easily be treated as there indicated, but such is not the usual condition. Fig. 91 gives a roughly typical church floor plan as regards the main body of the building. The total floor space is shown as 5000 sq. ft. in the nave and choir combined, and 800 sq. ft. in each transept. The walls are assumed to be 30 ft. high in the clear, with a Gothic roof above. Now the total area to be lighted is 6600 sq. ft., and the value of  $K$  is low, not safely to be taken as exceeding 1.20. The peculiarities of the building, as a problem in lighting, lie in the high walls and the absence of any ceiling, both of which complicate matters.

As to the nature of the radiants, when electric lights are available, one must depend almost entirely upon incandescents. Arc lamps are not to be considered for artistic reasons, save perhaps in indirect lighting of the choir. If only gas is available, mantle burners suitably

and thoroughly shaded had better be the main reliance, as ordinary gas flames are seldom steady in such a place. In either case avoid chandeliers as you would shun poison. A huge circle of lights pendent from a Gothic

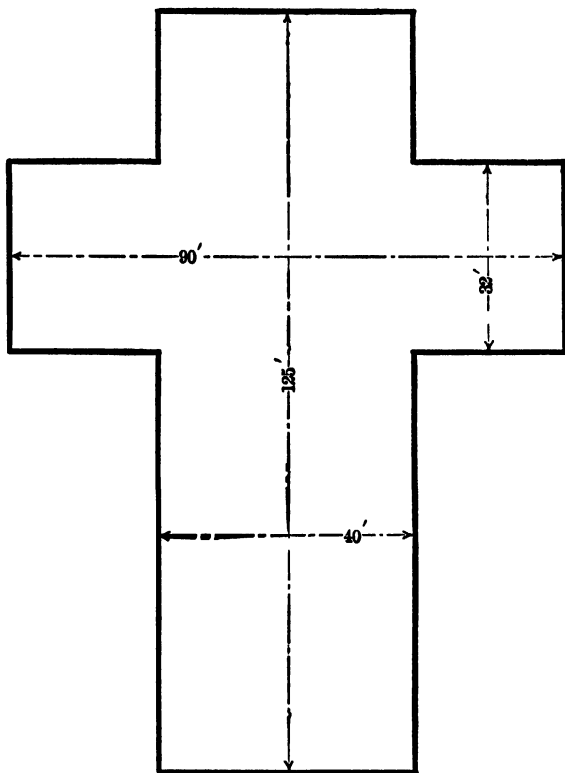

Fig. 91.

roof is about as bad technically and artistically as anything that could be imagined.

As to the amount of light needed, it would be advisable to allow no more than 2.5 sq. ft. per candle-power, which, taking  $K$  at 1.20, would call for 2200 net

candle-power. In point of fact, in using electricity, not less than 150 16-cp lamps should be used, and even this number, on account of the trying conditions, would have to be very deftly arranged to give the required result. For the best effect they should be chiefly reflector lamps, assigned about as follows: 90 to the nave, 20 to the choir, and 20 to each transept. As to position, the most efficient method would be to put them in groups of six or eight on brackets between the windows, at half to two-thirds the height of the wall, with possibly larger groups massed at the four corners of the crossing. With still more lights available very beautiful results could be attained by adding lights at the capitals, and, in some cases, along the tie-beams, or on the brackets from which the pendent-posts rise. These latter arrangements are very effective, but not economical, and if used should be installed on the basis of about 1 candle-power per 2 sq. ft. of floor surface. All incandescent lamps used without diffusing shades should have ground bulbs.

In lighting with gas, brackets are about the only thing feasible, since the flames must point upward, and few capitals would fail to look overloaded with adequately shaded burners. Mantle burners, of course, do the work most efficiently, but used alone the effect is certain to be grimly utilitarian, and especially around the choir small ordinary jets may be used to very great advantage. The mantle burners should be as unobtrusive as possible in such a case, even if they do the main work of the illumination.

Only the barest hints can be given for the detail of church lighting, as so much depends on the architectural peculiarities and on the scheme of decoration,

but the foregoing indicates the general principles to be followed. The most important thing is to give a rather brilliant illumination without the individual radiants obtruding themselves unpleasantly on the eyes of the congregation.

Large public buildings are generally easier to light than churches, since they are, as regards the shape of the several rooms, comparatively simple and are seldom dark in finish. Many rooms may be illuminated along the lines already laid down, but, on the whole, powerful radiants, such as arc lights, may be more freely used here than elsewhere, thereby effecting a very considerable economy.

In high corridors and high halls without galleries arc lights can be used with very excellent results. They should invariably be shielded by ground or opal globes, and, if hung very high, as is sometimes desirable, to keep them out of the ordinary field of vision, should be provided with reflectors. They should be numerous enough to suppress the shadows that ordinarily exist under the lamps. In the absence of such shadows the modern enclosed arcs have a very material advantage.

Rooms lighted by arc lamps ought to be of light finish, since the lamps must be placed rather high to keep them, even shaded, from glaring unpleasantly, and they give a strong nearly horizontal beam which, in lack of good diffusing surfaces, is for the most part wasted. Reflectors deep enough to turn this downward would usually be most unsightly and would give an unpleasant searchlight effect, which should be avoided.

Never let the eye rest simultaneously on arc and incandescent lamps indoors or out, since the latter seem very dim and yellowish in such company, and will never

be credited with anything like their real brilliancy. Similar reasoning applies to the use of mantle burners and ordinary gas jets in the same room. When so used the former should be well shaded and unobtrusively placed, and the latter massed and generally unshaded or lightly shaded, so as not to seem of relatively very small intrinsic brilliancy.

Sometimes in large interiors the powerful regenerative burners may find a place. They give an excellent downward illumination, which is occasionally very useful.

Theaters present some very interesting problems in illumination on account of their peculiar shape and the difficulty of lighting the interior with sufficient brilliancy without making the radiants altogether too conspicuous. They are, as a rule, far more brightly lighted than other interiors, but seldom judiciously. The usual fault is to place the lights so that they shine directly in the eyes of a considerable part of the audience. The auditorium is commonly very high in proportion to its area, and plentifully supplied with galleries. Fig. 92 shows the typical elevation, the floor plan being generally only slightly oblong. The galleries, of course, sweep around the sides, narrowing as they near the proscenium boxes. Not infrequently a fourth gallery is added.

During the acts no very considerable amount of light is needed, but between them it is generally desirable to produce an effect of great brilliancy. The main floor is far below the roof, and the shelving galleries render it difficult to light the spaces between them. The general fittings are usually light, but the dull hue of the floor and galleries when occupied kills much of the diffusion.

The actual floor space to be dealt with as a problem in illumination includes the galleries, and hence greatly exceeds the area of the main floor. Assuming the width in Fig. 92 to be 50 ft., the nominal area in front of the footlights is 3000 sq. ft. The total gallery area is

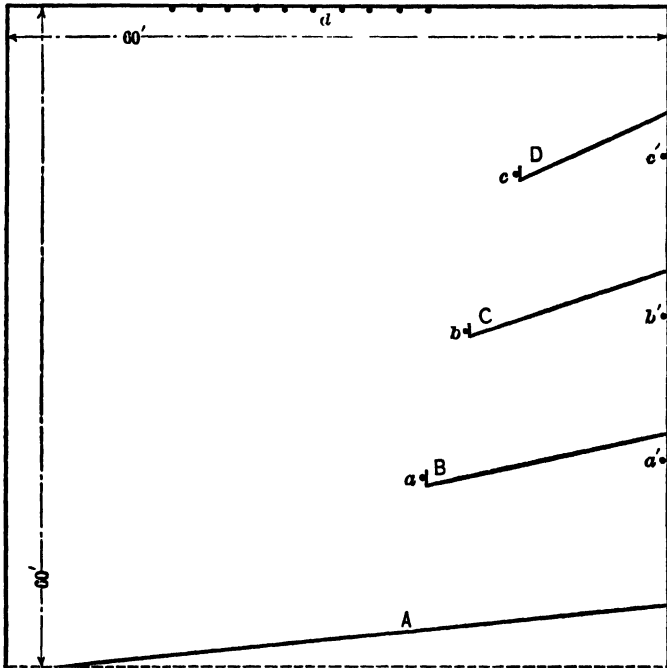

Fig. 92.—Elevation of Theater.

usually from 1 to 1.5 times the floor space, so that the entire space to be lighted would be at least 6000 sq. ft., half of it being located so that it can get little advantage from the illumination of the main space above the floor. The space behind *A*, and the galleries *B*, *C*, and to a less extent *D*, have to be treated almost as separate rooms,

particularly when, as sometimes happens, the galleries are rather lower than shown in Fig. 92.

This is the main reason for the apparently abnormal amount of light that is needed in theaters. The fact is that there is really a very great area to light, and it is so placed that it cannot readily be treated as a whole. The following table shows the approximate amount of illumination furnished in a number of prominent Continental theaters.

If in Fig. 92 we allow, on account of the high ceiling and conditions unfavorable for diffusion, 2 to 2.5 sq. ft. per candle-power, and take account of the real total floor space, including the galleries, we reach just about the figures given, which are based on the floor plan only. And in practice 3600 candle-power would probably do the work well, although, since this only allows ordinary good reading illumination, more light is necessary to give the really brilliant effect which is usually desired. Nearly 5000 candle-power would be required to show off the house effectively.

THEATER.	SQ. FT. PER CP.	CP. PER SQ. FT.
Opéra, Paris .....	0.78	1 28
Opéra, Paris, as hallroom.....	0.38	2.63
Odéon, Paris.....	1 52	0.66
Gaieté, Paris ..	1.14	0.87
Palais-Royal, Paris .....	0.51	1.96
Renaissance, Paris.....	0.52	1.92
La Scala, Milan..	1.07	0 93
Massimo, Palermo (ordinary) .....	0.86	1.16
Massimo, Palermo (en fête) ..	0.53	1 88

As to the location of the lights and their character, the body of the house can be usefully lighted by lamps ranged along the galleries at *a b c*. If these are placed below the edges of the galleries they will glare directly into the eyes of the spectators, so that it is better to illuminate the gallery spaces from the rear and above, at



*a' b' c'*. The radiants may well be provided with reflectors, as the diffusion amounts to little, and all lamps on and under the galleries should have ground globes. These lights may be re-enforced to great advantage by ceiling reflector lamps, best sunk in the ceiling deep enough to make them inoffensive from the galleries. These, with some ornamental lighting about the stage and boxes, should give a capital result. The main point is to light the interior brightly without thrusting bright radiants into the field of vision.

A very beautiful example of theater lighting is shown in the frontispiece, a photograph from the stage of the Metropolitan Opera House, decorated for the performance in honor of Prince Henry of Prussia. The temporary festoons from the ceiling are highly decorative, but better suited to temporary than to permanent use, since they shine directly into the eyes of the occupants of the galleries. In this instance the curtain was brilliantly studded with temporary incandescents, and the whole interior was elaborately decorated.

A useful form of ceiling lighting, applicable to many very high interiors, is arranged by replacing the lamps at *d*, Fig. 92, by opal glass skylights of rather large dimensions, and placing above them arc lamps with reflectors. The skylight surfaces should be flat or slightly projecting rather than recessed, and the reflectors should be planned so that each may throw a cone of light subtending an angle equivalent to the whole floor plan.

By thus superposing the indirect illumination from a group of lamps the general steadiness of the light is greatly increased. In thus using arcs care should be taken to have the diffusing skylights faintly tinted so as

to lessen the color contrast between the powerful ceiling lights and the incandescents used elsewhere in the house. It is a considerable advantage thus to place lights above the ceiling, as it avoids the serious heating effect due to massing incandescents near the ceiling of a generally overheated room.

On account of this heating the use of gas in theaters is highly undesirable, and has been almost completely abandoned. In lack of anything better, fair results could be reached by mantle burners placed somewhat as shown in Fig. 92, and *very thoroughly* shaded by holophane or other diffusing globes, much of the illumination being located above the ceiling in the form of mantle or regenerative burners.

Large and high spaces cannot often be lighted very efficiently, as the conditions ordinarily preclude placing powerful radiants near the plane of illumination. The natural *riposte* is to use highly efficient radiants, and with them to employ reflectors freely. Hence the form of ceiling illumination just explained.

In very large interiors without high galleries, arc lighting may be very effectively used, provided the arcs are well shaded. It is wise to group them so that no single arc shall entirely dominate the illumination at any particular point. It is better to lose a little in uniformity of the total illumination throughout the area than to take the chances of flickering, which is not entirely suppressed even in the best arc lamps.

In a big space arcs can be treated much like incandescents in a small space, but the detail of the work varies so much that only very general suggestions can be given. Often temporary illumination has to be undertaken, and must be fitted to the case in hand. One of

the most beautiful examples of such work that ever fell under the author's notice was the illumination of Madison Square Garden for a chrysanthemum and orchid show a few years since. The feature of this work was the very extensive use of both arc and incandescent lamps enclosed in Chinese lanterns. The huge lanterns containing the arcs were very striking, and the whole effect was most harmonious, while the illumination was thoroughly good. It is mentioned here merely as a clever bit of temporary lighting treated to suit the particular occasion.

In this lighting of large interiors the smaller arcs worked on constant potential circuits are very useful, although not very efficient. Those taking 5 to 6 amperes give excellent service, and fair results can be obtained with lamps working down even to 4 amperes. Such arcs are equivalent to from 10 to 15 16-cp lamps in practical effect, and give a greater candle-power per watt.

Incandescent lamps of the Nernst type, if reduced to a practical form, may be utilized in a similar way, in forming a good basis of illumination where the total amount of light is considerable. In other words, when one is dealing with very large enclosed spaces the lighting is simplified and made more efficient by utilizing the more powerful radiants.

Large incandescent lamps giving from 50 to 100 candle-power, or even more, would be very valuable but for their high cost and generally rather inadequate life and efficiency. Those of 50 candle-power are pretty satisfactory, in spite of their share of these drawbacks, but the larger sizes are much less advantageous.

In certain cases, particularly railway stations and

other buildings likely to be rather smoky, arcs have to be the main reliance, since the globes of incandescents grow dim so quickly that cleaning them is an almost interminable job. Hence it is best to use comparatively few powerful radiants. The arcs should be carried rather high, say 20 to 25 ft. above the ground or floor. Assuming 0.5 candle-foot as the minimum, and taking into account the illumination due to adjacent lamps, each arc can be counted on to illuminate over a distance at which it gives 0.25 candle-foot. For close detail reference must be made to the actual illumination curves of the type of lamp used, and the general problem is analogous to street lighting, but for lamps 25 ft. above the floor the approximate distance between arcs of the commoner kinds, to give the required illumination, may be derived from the following table:

KIND OF ARC	APPROXIMATE WATTS PER ARC.	DISTANCE BETWEEN ARCS	SQ FT. PER ARC.
Direct current, open, 6.6 amperes.....	330	80	6,400
Direct current, open, 9.6 amperes.....	480	105	11,025
D. C. enclosed, 6.6 amperes .....	480	90	8,100
Alternating enclosed, 6.6 amperes... ..	425	75	5,625

The alternating arc would do relatively better if placed, say, 15 ft. high, since its light is thrown more nearly horizontally, and since all the arcs are assumed in this table to have clear outer globes, the open arcs, if given pale opal globes, which they should have to lessen the unpleasant glare, will be about on a par with the enclosed arcs. All arcs in enclosed places should have at least one opal globe, and when used where, as in railway stations, diffuse reflection is of small amount, should be provided with reflectors to utilize the light that would otherwise be wasted. This would somewhat improve

the figures given above, and it is quite safe to say that under ordinary circumstances, with properly placed arcs, one arc taking about 6.5 amperes is good for nearly 10,000 sq. ft. of floor space at the assumed intensity of illumination. More lights are often desired locally in places where considerably more than 0.50 candle-foot is required, as in the central part of a passenger platform, but they seldom would have to be placed nearer than 60 ft. apart, unless the traffic is exceptionally great.

Certain classes of interiors require, on account of the uses to which they are put, especial adaptations of the radiants, either in kind, amount, or position. One of the commonest demands is for an illumination of unusual brilliancy and steadiness in situations like reading rooms, draughting rooms, schools, weave shops, and such like places, where the eyes are under steady, if not severe strain. Ordinary good reading illumination, such as we have been considering, must be considerably strengthened to meet these requirements. Simple increase in the number or power of the radiants sometimes meets the conditions, if such increase can be had without thrusting too powerful lights into the field of vision.

It may be necessary to furnish 1 candle-power for each 2 sq. ft. of area, or, in extreme cases, 1 candle-power per square foot. One of the most useful schemes for supplying such large amounts of light is the use of the inverted arc in connection with a very light interior finish.

The ordinary continuous-current arc, in virtue of the brilliant crater of the positive carbon, throws its light downward; but if the current be reversed so as to form the bright crater on the lower carbon, most of the light is thrown upward toward the ceiling, and is there dif-

fused. If, as usual, these arcs are arranged with inverted conical reflectors of enameled tin or the like, all the direct rays are cut off and the entire illumination is by the diffused rays. The result is a very soft and uniform light, white in color, and of any required brilliancy. Fig. 93 shows in diagram the principle of this device. In case a white ceiling is not available, large white diffusing screens over the lamps, of enameled tin or even of tightly stretched white cloth or paper, answer the purpose. Indeed, this was the original form of the device as shown by Jaspar at the Paris Exposition of 1881.

With reference to Fig. 93, it is sufficient to note that the conical reflector should be rather shallow, just deep enough to throw the light wholly on the ceiling and upper walls, but shallow enough for two neighboring lights, as shown, to distribute light over each other's fields, which improves the average steadiness of the illumination. The arcs need no diffusing globes, a clear globe being sufficient, and open arcs may be freely used, to the material improvement of the luminous efficiency, never very high in this form of lighting.

The heights of the arcs should depend somewhat on circumstances regarding the appearance and the purpose of the lights, but will generally be half to three-fourths the height of the room. The reflectors may be from 3 ft. to 6 ft. in diameter, and may have an angle at the apex of 120 degrees to 140 degrees. Only in case of having to throw the light on special screens rather than on the natural ceiling should the reflectors have less aperture than just indicated. They then become of the nature of projectors, and the angle at the apex may be 90 degrees or so.

As to the efficiency of such illumination, one may

roughly assume 1 watt per spherical candle-power for powerful open continuous-current arcs, and may reckon on a loss of about one-half in the process of diffuse reflection. The diffuse illumination may then be taken as being in candle-power about 0.5 to 0.6 the number of watts expended, not including artificial resistance. Thus, a continuous-current arc, taking 9 amperes to 10 amperes at about 50 volts, utilized in this manner will

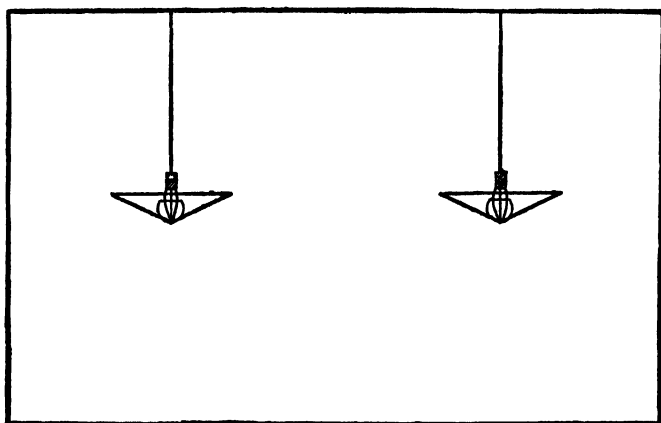

Fig. 93.—Lighting by Inverted Arcs.

illuminate 250 sq. ft. to 300 sq. ft. on the basis of 1 sq. ft. per candle-power, or 500 sq. ft. to 600 sq. ft. at 2 sq. ft. per candle-power.

It must be noted that if enclosed arcs are used in this way, materially less light is obtained, as is well known. Even with both outer and inner globes clear one cannot count on much better than 2 watts per mean spherical candle-power, although occasional results of 1.5 watts or a little below are attained. Alternating lamps require, of course, still more energy, and with enclosed

arcs in general one would hardly find it advisable to allow, when using ceiling diffusion, more than half to three-fifths of the area per watt just indicated for open arcs. Enclosed arcs have no marked crater, which operates somewhat against their effectiveness in this class of lighting.

These figures are necessarily only approximate, but while enclosed arcs have some conspicuous virtues, high efficiency as respects mean spherical candle-power is not one of them. In all this lighting by diffusion the diffusing surfaces *must* be kept clean, else there will be much loss of light. Under even the best conditions one does not do very much better than 2 watts per candle power, and lack of care or bad engineering may easily transform this into 3 or 4 watts per candle-power, which is no better efficiency than incandescents would give.

The chief advantage of this diffused lighting is that it enables one to secure very brilliant illumination with white light, without trying the eyes with intense radiants.

This illumination has, however, one curious failing, in that as ordinarily installed it is *shadowless*, and the light has no determinate direction. For certain kinds of work this is a very trying peculiarity, severely felt by the eyes. It may be remedied in various ways, of which perhaps the simplest is the lateral displacement of the lamps shown in Fig. 94.

This gives a predominant direction to the light, something akin to the effect produced by a row of windows along the side of the room, and is probably as near an approach to artificial daylight as can be attained by simple means. It is not unlike in principle the "artificial moon" used in the reading room at Columbia



University, consisting of a great white ball intensely illuminated by arcs backed by projectors.

In using the arrangement of Fig. 94, about the same relative number of arcs is required as in Fig. 93, but they are placed in one row instead of two. The unilateral effect could be greatly enhanced by a diffusive screen *a b*, Fig. 94, running along back of the arcs. Its

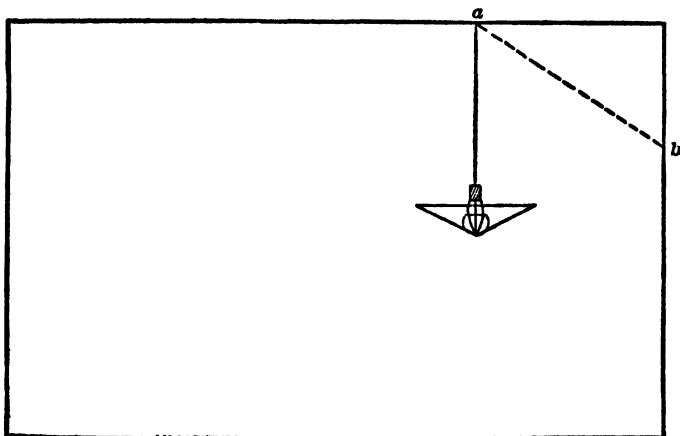

Fig. 94.—Unilateral Illumination.

angle with the ceiling evidently should depend on the shape of the room.

Unilateral illumination, whether diffused or not, is often desirable from a hygienic standpoint. In many cases well-shaded arcs may replace the diffused lighting just described, though such direct lighting is generally rather less steady. But it must be remembered that an arc having both inner and outer globes opalescent is scarcely, if at all, more efficient than incandescent lamps, assuming both to be worked off constant potential mains; hence, unless the whiteness of the arc light is

essential, incandescents, being steadier, are very often preferable.

In factories where colored fabrics are woven, and in shops where they are sold, white illumination is a matter of great importance, and arcs are especially useful. In the mills the necessary illumination depends largely on the color of the fabrics. It should, as a matter of experience, range from 2 sq. ft. per candle-power to 1 sq. ft. per candle-power in passing from white to dark and fine goods. The candle-power noted here is *actually* mean spherical, or hemispherical, if reflectors are used, taken from the real performance of the arc well shaded. This qualification means practically 300 sq. ft. to 400 sq. ft. for each arc of 450 watts to 500 watts in the extreme case, and 600 sq. ft. to 800 sq. ft. for white and light-colored goods. Shops where such goods must be sold by artificial light should be lighted on very nearly the same basis. For brilliant illumination, where color distinctions must be accurately preserved, the arc at the present time stands pre-eminent, and should generally be used, although Nernst lamps and acetylene flames have a similar advantage. It must be remembered, however, that enclosed arcs are distinctly bluish unless the current is pushed up nearly to the limit of endurance of the inner globes, and hence when used in situations where color is important, should have shades tinted to correct this idiosyncrasy. The common opalescent inner globe is entirely insufficient for the purpose.

Where arc lights are not available, and it is desired to furnish approximately white light, there is difficulty in meeting the requirement. Mantle gas burners with extreme care in selecting tinted shades to correct the generally greenish cast of the light may be made to give

fair results, but are considerably inferior to arc lights. Incandescent lamps fail to meet the requirement, and perhaps the closest approximation to the arc in the matter of color is to be found in the acetylene flame or in the Nernst lamp.

In the lighting of workshops for various purposes, no such brilliant illumination as has been mentioned with reference to textile factories is required. The most economical scheme of illumination is to furnish general illumination in moderate amount, and to re-enforce it, in points where brilliant light is needed, by extra lights at these places. So far as the general illumination is considered, 1 candle-power to about 4 sq. ft. or 5 sq. ft. is ample. The extra lights should be put bearing as directly as possible on the work in hand, and should furnish illumination at that work to the extent of from 1 candle-foot to 2 or 3 candle feet, according to the needs of the work.

It should not be forgotten that good illumination in a workshop tends materially to increase the quantity and improve the quality of the work turned out.

In most instances the color of the light within the range of ordinary illuminants is not a matter of considerable importance, but the light must always be reasonably steady. Hence the incandescent lamp and the mantle burner for gas are by far the most valuable sources of light generally to be found. Ordinary bat-wing gas burners are probably the worst in point of steadiness, although a badly adjusted electric arc is a close second.

Where very powerful radiants are desired, the large regenerative gas burners give a very brilliant and steady light. They throw out, however, a great deal of heat, which is sometimes objectionable, and are less econom-

ical of gas than the mantle burner. If the Nernst incandescent lamp is brought, as it promises to be, into commercial usefulness, it will prove exceedingly valuable for the illumination of large enclosed spaces, by reason of its considerable power and the whiteness and steadiness of its light. At the present time it is not far enough past the experimental stage to be a serious competitor of other illuminants.

A very special branch of illumination is the lighting of immense enclosed spaces, such as are found in exposition buildings. This work is on such a large scale that it almost partakes of the nature of outdoor lighting, with which it is very intimately connected as a practical problem. The amount of light required in single enclosed spaces of colossal dimensions, like exposition halls, varies considerably according to the practical use to which the space is to be put. As a rule, the most brilliant and useful illumination in these large spaces is secured by the use of arc lights to the exclusion of other illuminants. In a building covering one or several acres, and perhaps 100 ft. or more in height, incandescents of ordinary powers look lost; and if the roof is not to fade away into darkness, a very large number of lights must be required to bring it into prominence, placed so high from the floor as to be of little service for the general illumination.

Moreover, such buildings have generally a very large amount of glazed side and roof space, furnishing the ordinary daylight illumination. Consequently the walls and ceiling diffuse very little light. With arc lights the power of the individual radiants bears some respectable proportion to the size of the space to be illuminated. The luminous efficiency is increased, and by sufficient

massing of lights with reflectors, even the highest halls can be admirably lighted. The work can, of course, be beautifully done with incandescents if enough are available, but at considerably lessened economy.

The amount of light required per square foot of floor space is very considerable, owing to the height and bad diffusing properties of the building, and for the best results 1 actual candle-power should be furnished for each 2 sq. ft. to 3 sq. ft., according to conditions.

Incandescent lamps have a very high decorative value in connection with such work, but to be used effectively must be massed somewhere near the plane of illumination, lights in and about the roof being practically only for decorative purposes. Used in sufficient numbers, however, they give, in virtue of their complete subdivision of the illumination, a better artistic result than can be obtained with arcs.

The subject of exposition illumination is so large and so special in its character as to be hardly appropriate to the scope of the present work.

## CHAPTER XI.

### STREET AND EXTERIOR ILLUMINATION.

A SPECIAL and very important department of illumination has to do with streets and other outdoor spaces. It involves not a few unusual difficulties, for there is unlimited space to deal with, as well as an indefinite variety of natural and artificial obstructions. Save in narrow streets bordered by high buildings, one gains little or nothing from the diffusion that is so important a factor in interior lighting, and in many instances the streets are so thickly shaded by trees that the problem of adequate lighting is very difficult.

Light above the horizontal plane is of comparatively little value, while the ground should receive a strong and even illumination. In the comparative freedom from reflecting and diffusing surfaces there is, however, one small gain, for this is the case in which the law of inverse squares holds good. Of course, there is some diffusion from the street—when the ground is snow covered, a considerable amount—but, broadly, one can compute the illumination with fair accuracy.

In computing the illumination, however, two radically different methods have come into use. In one of these the radiant in street lighting is supposed to illuminate a geometrical plane, of which each element receives illumination depending, not only on its distance from the radiant, but on the obliquity of the rays which strike it. The other method assumes that in reckoning the illumi-

nation at any point the element of surface to be considered is not in the plane of the ground, but in a plane perpendicular to the direction of the ray.

The first method would determine the legibility of a bit of newspaper lying flat on the pavement, the second method the visibility of a stone projecting above it. The distinction might at first appear like that between tweedle-dum and tweedle-dee, but in fact it makes an absurdly great difference in the theoretical illumination. Fig. 95 shows the conditions which arise in the two cases. Assume a light  $L$  of 1000 uniform spherical candle-power at the top of a pole 25 ft. high, and then calculate the

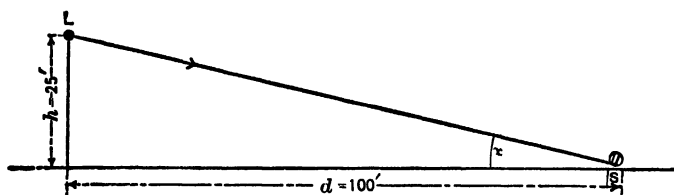

Fig. 95.—Illumination at a Surface.

illumination at a surface  $S$ , 100 ft. from the foot of the pole, by the law of inverse squares on the two hypotheses. In the first place, taking account of the obliquity, calling the illumination  $l$ , we have

$$l = \frac{L \sin a}{h^2 + d^2} = 0.023 \text{ candle feet.}$$

But considering  $S$ , the surface, as on a projecting cobblestone at the same point,

$$l = \frac{L}{h^2 + d^2} = 0.094 \text{ candle feet.}$$

And the worst of the discrepancy is that it is greatest at

considerable distances from the radiant, where the light is feeble at best.

Now in point of fact, the object of lighting streets is neither to enable one to read a page laid flat on the pavement nor to observe a surface perpendicular to the ray. But the intensity and distance of the radiants is determined by the minimum illumination allowable midway between lights, and not by the brightness of the regions near the poles, and in these comparatively dimly lighted spaces the things which must be observed and for which the users of streets keep their eyes open are things not in the plane of the pavement, but above it. For observing these the obliquity of the light as regards the pavement does not much matter; in fact, at equal intensities oblique light gives stronger contrasts than perpendicular light.

Under these circumstances, however, one is justified in reckoning upon the illumination received from one direction only. A printed page laid on the pavement at the point *S* receives useful light from both the neighboring radiants, and so, if *S* is halfway between two lamp-posts, it will really receive on the first hypotheses 0.046 candle-foot. But a projecting stone or the face of a wayfarer is illuminated so far as a given viewpoint is concerned by only one of the adjacent radiants.

For these reasons, in the ensuing discussion, the illumination at a point *S* will be assumed to be that which falls on either hemisphere, let us say, of a billiard ball at *S*. It will then be reckoned by the second formula,

$$l = \frac{L}{h^2 + d^2}$$

but only one radiant, or the radiants on one side only, will be considered as useful.



It must not be understood from the preceding statement as to the importance of the minimum illumination that the lighting of a street should be specified in terms of this minimum only. For such a proceeding leads at once to a *reductio ad absurdum*. And this is particularly the case if the illumination on the plane of the pavement is considered. For assuming a sidewalk lighted by common candles placed 6 ft. apart and 6 ft. high, and reckoning only the first four candles on each side of a point on the pavement, the illumination based on the formula

$$l = \frac{L \sin a}{h^2 + d^2}$$

amounts to no less than 0.052 candle-foot as against 0.046 candle-foot from a pair of powerful arc lights placed 200 ft. apart. In other words, the street on this hypothesis would be better lighted by the candles giving less than one-sixtieth the actual amount of light. A very slight effort of the imagination will picture the really vivid contrast between the two conditions.

In determining the conditions with reference to the minimum illumination, therefore, one must also take into account the real amount of light furnished the street as a whole. We do not judge the lighting of a street by the darkest spots so much as by the general effect. A large number of small lights give an impression of dinginess unless the aggregate candle-power be large. A few large lights, on the other hand, give in places a brilliant effect, although the minimum illumination may be rather small.

If artificial illuminants gave a spherical distribution of light the computation of street lighting would be easy, but as has already been seen, they do not. What

is worse, the nominal brilliancy is generally not found in practice.

For years open arc lamps have been classified as 2000-cp or "full arc," and as 1200-cp, or "half-arc" lamps, but these alleged candle-powers are never obtained even in the direction of maximum illumination. The former are lamps taking about 9.5 to 10 amperes, and 450 to 480 watts, the latter 6.5 to 7 amperes and 325 to 350 watts. Their actual maximum intensities are, respectively, about 1200 cp. and 700 cp., located at about 45 degrees below the horizontal plane. Reduced to mean spherical measures their ordinary intensities are about 600 and 300 cp., respectively. In the horizontal plane these intensities fall to about 350 cp and 200 cp.

The result of this distribution is a zone of very brilliant light in a circle having its radius equal to about the height of the light, comparatively weak light within it, and rather feeble light at greater distances where the rays are more nearly horizontal. Fig. 96 shows this illuminated ring with startling distinctness. The dark area within is exaggerated by the effect of a dirty globe, the globes on open arc lamps being accessible to dust and hence difficult to keep clean.

More conspicuous even than the dark space is the narrowness of the area of brilliant illumination, and the rapid fading away into darkness of such details as the picket fence merely across the sidewalk from the pole by which is carried the mast-arm for the arc lamp. This was a so-called 2000-cp arc, not kept in the best order, to be sure, but still no worse than can easily be found in any town where there are many open arc lamps.

Obviously one cannot compute the illumination from such a lamp on the theory that the distribution is even

approximately spherical. In order to calculate the effect it is necessary, instead of assuming  $L$  in the formulæ to be constant, to treat it as a variable, and to use its real value at each angle below the horizontal in



Fig. 96.—Shadow below Open Arc.

computing the illuminating effect at various points. In other words, the illumination at distant points must be made with reference to the luminous distribution curve of the lamps.

Fig. 97 gives a set of distribution curves for the forms of arc lamps in most frequent use.

Curve *A* is from a series alternating-current enclosed-arc lamp taking 425 watts with a current value of 6.6 amperes. It was fitted with the usual opalescent inner

globe and a clear outer globe, and was used with a solid upper and cored lower carbon.

Curve *B* is from the ordinary open continuous-current arc, taking 330 watts at 6.6 amperes, and including

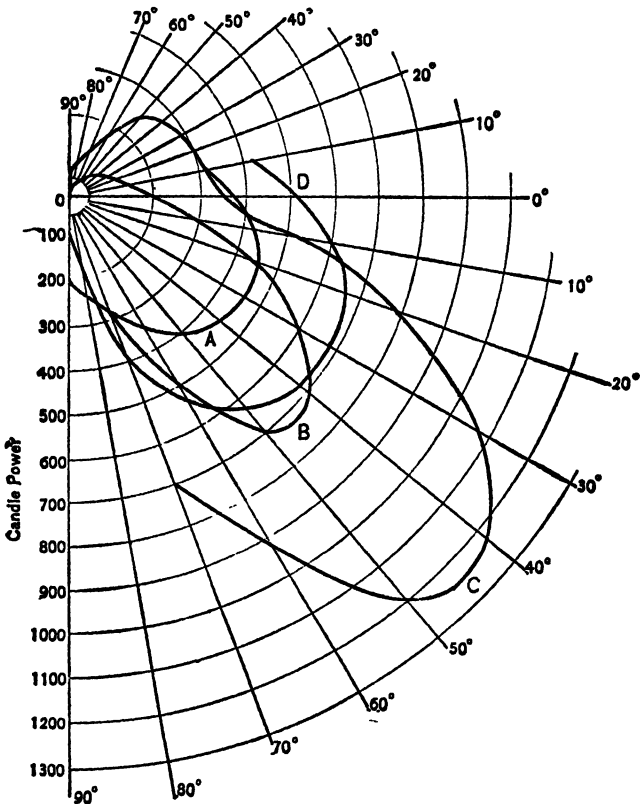

Fig. 97.—Distribution of Light from Arcs.

the usual clear glass globe. This is the arc nominally rated at 1200 cp.

Curve *C* is from the 9.6-ampere 480-watt arc usually

classed as 2000 cp. Like the preceding, it is a continuous current arc with clear glass globe.

Curve *D* is from a continuous-current series arc lamp taking 6.6 amperes and 480 watts. It was provided with an opalescent inner and a clear outer globe, and was worked with both carbons solid.

Lamps *A* and *D* were provided with reflecting shades to turn outwards and downwards the light ordinarily thrown upwards. Lamps *B* and *C* could not be thus treated for the reason that so little light is thrown above the horizontal that a reflector is practically useless.

All these curves are from tests made on commercial arc lamps of recent manufacture at the same period and by the same experimenters in the laboratory of one of the large electrical companies, which manufactures lamps of each of these types. As the tests were at the time made not for publication, but for the private use of the company's engineers, and under uniform conditions, the author believes them to be more reliable, particularly as regards the comparative results from the several lamps, than even the average of tests made by different observers on lamps under diverse conditions. Such curves are of necessity only approximate, because of the variations due to differing adjustments and to the peculiarities of different lamps.

Now looking at curve *C*, for example, we may repeat the computation made with respect to Fig. 95, using the real value of the candle-power instead of the assumed value.

Taking the arcs as 25 ft. above the ground, and computing the illumination at 100 ft. from the pole, the required ray is depressed 14 degrees below the horizontal

plane. The corresponding candle-power from curve *C* is about 620, so that putting this value for *L*

$$l = \frac{L}{h^2 + d^2} = 0.058 \text{ candle-foot,}$$

instead of 0.094 candle-foot as in the previous example. If we take  $d = 150$  ft., the result is still more unsatisfactory, for  $l = 0.0433$  with the assumed 1000 cp, but since in this case  $a = 9$  degs. 30 min., *L* is really only 490, whence  $l = 0.0168$  candle-foot.

It therefore becomes evident that with the distribution curve of *C* it is very easy to get good illumination not far from the lamp, but that at distances from the lamp of four or five times the height of the lamp the illumination is very deficient. A glance at curve *B* shows a distribution curve of very similar shape, and, in fact, all open arcs have the common weakness of giving more light than is necessary near the pole and too little far away from it. The distribution would be much improved if the curve could be swung upward about 20 degs. toward the horizontal.

If there were any convenient way of getting a distribution that would give uniform illumination up to a reasonable distance it would be extremely useful. The polar equation for such a distribution curve would be

$$L = \frac{l h^2}{\sin^2 a}$$

Fig. 98 shows this curve plotted for  $h = 25$  and  $l = 0.1$  candle-foot. The theoretical curve obviously becomes asymptotic, which no practical curve could ever do under finite conditions, but it is not outside the bounds of possibility to construct a reflecting and refracting system after the pattern of the holophane globe,

which should send out at angles not far from the horizontal most of the light which is now wasted in needlessly brilliant illumination near the light.

Unhappily the arc slowly changes place in common lamps as the carbons are consumed, so as to interfere

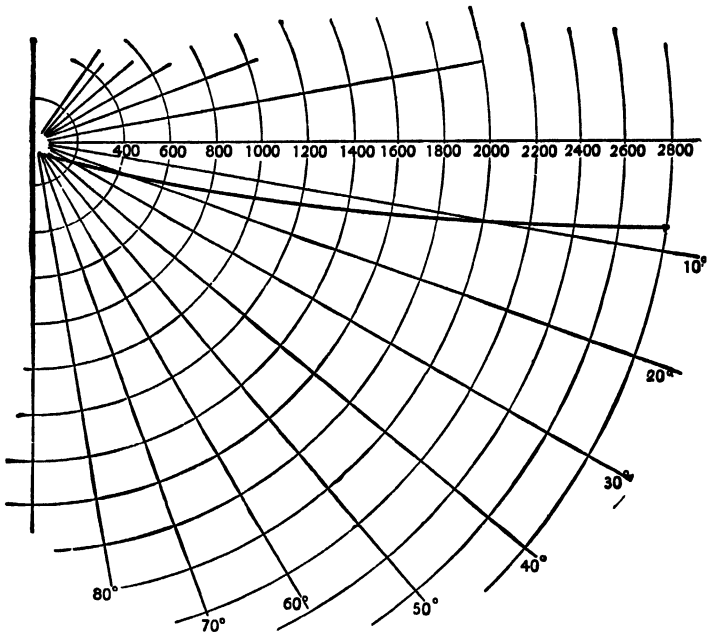

Fig. 98.—Ideal Distribution Curve.

with the use of such a device. But it would be quite feasible with a focusing lamp, or with Nernst or similar lamps, although globes of the kind in question are not easy to keep clean, and would have to be kept dust-tight to obtain the best results.

Now, when we remember that the curves of Fig. 97 represent the lamps in their respective best working

conditions, and not when the globes are ill-cared for or the arc abnormal in length and position, it becomes evident that if any attention is to be paid to minimum illumination, even the most powerful commercial arcs cannot be very widely spaced. At 400 ft. spacing the midway point receives from an ordinary 1200-cp arc 25 ft. high just about 0.01 candle-foot, which, for most practical purposes, is no light at all. Only by raising the lamp high enough to take advantage of the light at angles further from the horizontal can adequate light at such a distance be obtained, and this is an impracticable expedient on account of the cost and trouble and the interference of trees and other obstacles. For with such arcs the maximum illumination is obtained when the height of the lamp is about seven-tenths the distance to the point to be lighted. The tower system of lighting, used extensively in this country fifteen years ago, but now practically abandoned, was the result of this consideration.

The important thing to be decided as a basis for all computations on street illumination is the amount of light required. There is little general agreement on this important matter. We may get an idea of the magnitudes to be employed by remembering that moonlight in the latitude of the Northern States is generally from 0.01 to 0.03 candle-foot. This intensity is of considerable service at the maximum limit, but of little use at the minimum. When anything like adequate illumination is to be furnished the minimum should not be less than 0.03 candle-foot. With this minimum derived from arc lamps the street, as a whole, will be brilliantly lighted. Under ordinary circumstances only principal streets would be lighted to this extent, and elsewhere the minimum might fall somewhat lower.



To determine the real illumination produced at any distance by a particular radiant, it is necessary to take the assumed height and the distribution curve for the radiant, and then to compute the illumination at that distance, using the real candle-power corresponding to the direction of the ray considered. To save labor it is convenient to plot the illumination at various distances in the form of a curve, thus enabling the illumination in candle-feet to be read directly.

Fig. 99 shows a set of curves thus computed from the four types of arc lamps, of which distribution curves were shown in Fig. 97. The first important lesson to be drawn from them is that none of the lamps shown gives really useful illumination at a distance of more than 150 ft., and that lamps *A* and *B* should not be spaced more than 225 ft. apart if the minimum illumination is to be about 0.03 candle-foot. Lamps *C* and *D* might be spaced at 300 ft., but not much further without producing a conspicuous dark belt.

*A* and *D*, the enclosed arcs, give relatively better illumination at considerable distances than the open arcs. It should be noted that the height of all lamps is assumed to be 25 ft., and that the curves begin at 50 ft. from the lamp, the space within that distance being relatively well lighted.

Comparing the several types of lamps, it at once appears that for street lighting the 6.6-ampere enclosed continuous current arc is fully equal to the 9.6-ampere open arc (so-called 2000-cp), while the 6.6-ampere alternating arc is rather better than the 6.6 ampere continuous-current open arc (so-called 1200-cp), but is materially less effective than the other two. In the author's opinion, it would correspond to a nominal 1500



Fig. 99.—Illumination from Arcs.

cp as respects the open arcs rated in the old-fashioned way.

But theory and experience unite in indicating that effective illumination on streets is not measured exactly by the process just explained, useful though it may be. There is a physiological as well as a physical factor in illumination, for in the presence of lights of great intrinsic brilliancy the iris closes and the image on the retina grows faint, like the image in a camera when the lens is stopped down.

Thus it is difficult to see beyond a brilliant light, and when the eye is exposed to the intense glare of an open arc it does not recover promptly enough in passing on to get the full value of the relatively feeble light at a distance from the lamp. This effect and the more uniform distribution of light account for the well-established fact that enclosed arcs, for both alternating and continuous currents, give more satisfactory lighting than would seem to be warranted by the computed intensity of the illumination. Besides, the enclosed arcs are generally steadier, which also tends greatly to improve matters.

The same advantages would be secured by using open arcs with properly designed diffusing globes, but these last really require the employment of a focusing lamp in which both carbons are fed into the arc at rates proportional to their rates of consumption, so as to hold the arc in a fixed position. Such lamps are more complicated and less fitted to outdoor use than ordinary lamps, and have not come into use for this purpose in this country.

The advantages in uniformity of distribution and in absence of shadowed areas, gained by the use of enclosed arcs, are very conspicuous. Fig. 100 shows the

illumination from an ordinary open arc in excellent operative condition, aided by a globe ground below to diffuse the light and to lessen the shadows beneath the arc. In spite of this the illumination is far from uniform, and the side rods of the lamp, on account of the small luminous area of the arc, throw dense lateral shadows. Fig. 101 shows the result of replacing this particular lamp by an enclosed arc. The shadows completely dis-

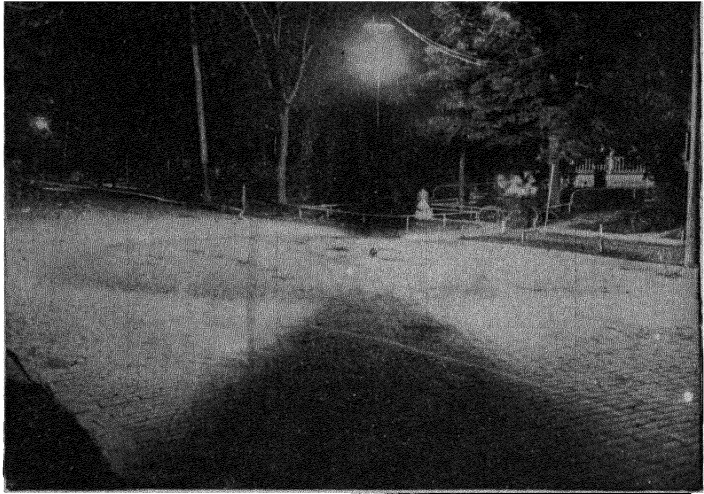

Fig 100.—Open Arc at Its Best

appear and the more powerful rays near the horizontal are shown both by the better illumination along the street and by the glare that evidently entered the camera. These results are very striking, and amply justify the present tendency to replace open by enclosed arcs, quite irrespective of the lessened cost of carbons and of trimming in the latter case.

Enclosed continuous-current arcs can be operated for about 100 hours with one pair of carbons; in other words, they have to be trimmed only about once a week in all-night street lighting, while the ordinary open arcs require trimming daily under like circumstances. The resulting saving in labor and in carbons is variously estimated, and changes somewhat with local conditions, but the weight of the evidence indicates a net saving of about \$10 per year per lamp, the same energy being used in each case.

Of late a strong tendency has developed toward the

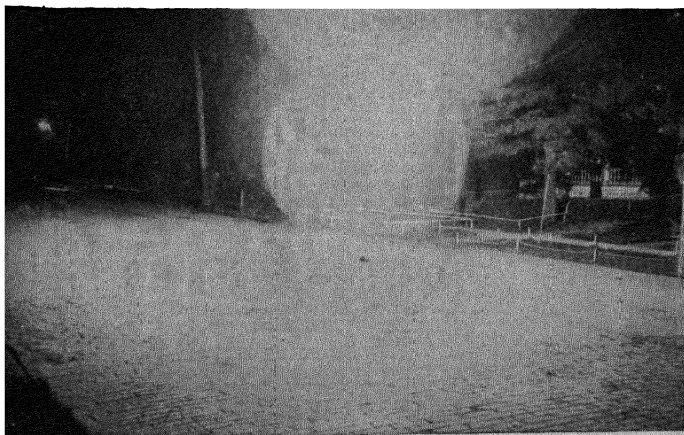

Fig. 101 —Light from Enclosed Arc.

use of alternating-current lamps, worked in series like the others through the aid of constant-current transformers or automatic regulators, which take the alternating current at constant voltage and deliver a current constant in amount, but varying in voltage according to the load to be carried. To discuss these interesting

mechanisms in detail is without the purpose of this volume. Suffice it to say, that they do their work extremely well, although at the cost of certain inconveniences, less on the whole than those attending the use of ordinary arc generators.

As has already been noted, the alternating arcs demand a little more energy relatively than continuous-current arcs, but as a rule this loss is fully compensated by the more economical distribution of current rendered possible. The enclosed alternating arcs require slightly more expensive carbons, and rather more frequent trimming than the enclosed continuous-current arcs. As a rule one pair of carbons will last seventy-five or eighty hours, and the street lamps must be trimmed once in five or six days, but a considerable saving in carbons and labor is still effected. It probably amounts in average cases to about \$8 per year per lamp.

The smaller intrinsic brilliancy of enclosed arcs enables some gain to be made by placing them lower than 25 ft., perhaps no more than 18 or 20 ft., which means a still further gain in effective lighting. As between continuous current and alternating-current arcs taking the same current, the former are distinctly more powerful; but either at 6.6 amperes can replace the open arcs either of 1200 or 2000 nominal candle-power, lamp for lamp, and give about equally satisfactory illumination. In new installations the alternating lamps may advantageously be spaced a little closer than the continuous-current enclosed arcs, as the curves of Fig. 99 indicate.

There is no question that where plenty of light is wanted in a street comparatively clear of trees, well distributed arc lights give by far the best results yet at-

tained. But where, as in many residence streets in the smaller cities, the whole roadway is well shaded by trees, arc lamps as ordinarily installed find their usefulness greatly limited by shadows. If the foliage does not come too low good results can be obtained by putting the arcs on cross suspensions over the center of the street at a height of not over 18 to 20 ft. In this case the enclosed or otherwise shaded arcs have an immense advantage, as they can thus be swung low without seriously dazzling the eyes, and throw shadows far less intense than the open arcs.

But there are streets so well shaded that even arcs so placed are at a disadvantage, and there are also many cases in which there is no real need of a brilliant illumination, but merely enough light is desired to make the way fairly clear. Economy also sometimes dictates caution in the expenditures for street lighting, and in such cases incandescent electric lamps or gas lamps are capable of doing good service at comparatively moderate cost. The incandescent lamps used for such service are nearly always operated in series, either on the same circuits as arc lamps or on separate series circuits by themselves.

In the former case the lamps are generally 50, 65, or 100 candle-power, made to take a constant current corresponding to that used for arcs, and it should be noted that such lamps are costly in the matter of renewals and difficult to operate satisfactorily. In the latter case the incandescents are generally of 16, 25, or 32 candle-power, worked in series upon an alternating-current circuit of 1000 or 2000 volts, taking 2 to 4 amperes. The running conditions in either case are rather severe, owing to the likelihood of fluctuations in current, and in-

candescent lamps intended for such service are rarely of higher initial efficiency than 3.5 to 4 watts per candle.

In the case of gas lighting, the present tendency is to use mantle burners giving initially 50 to 100 candle-power. Their color is comparatively inoffensive in street lighting, and they can be run at very low cost, but outdoor conditions seem to tend to very rapid deterioration of the mantles, so that in practice it is difficult to find a street in which most of the mantles have not long

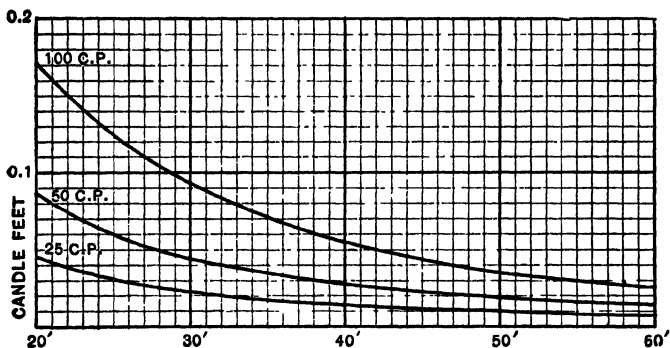

Fig. 102.—Illumination from Incandescent Lamps.

outlived their usefulness. Incandescent electric lamps deteriorate fast enough, but even in street service they hold their brilliancy much better than the mantle burners. The moral is that in using either of these illuminants, a very liberal allowance should be made for falling off in candle-power.

As in case of arcs, the illumination should be computed from the distance, height, and light-distribution curve of the radiant. For incandescent lamps of 25, 50, and 100 candle-power the resulting illumination curves are shown in Fig. 102, which may be compared with



Fig. 99. It is clearly evident therefrom that such lights should hardly be spaced over 120 ft. apart, even when of 100 candle-power, while those of 50 and 25 candle-power should be spaced much nearer. If they held their brilliancy well, one might space them further, but, in fact, it is undesirable.

In using the above curves for mantle burners it should be noted that one such burner corresponds approximately to a 50-cp incandescent electric lamp, being somewhat better in the early stages of its life, but losing brilliancy rather more rapidly.

In heavily shaded streets incandescents and mantle burners may best be bracketed out a few feet from the curb, with alternate lamps on opposite sides of the street; 100-cp lamps spaced in this way, with 200 ft. between consecutive lamps on the same side, or even 250 ft. under favorable conditions, will produce a tolerably lighted street, and 50-cp lamps spaced a little closer, say, at 150 to 200 ft. on each side, will do even better, but except for use in shaded streets arcs are generally to be preferred.

When close economy is an object, 25-cp lamps spaced at 150 ft. between lamps on the same curb, or mantle-burners similarly placed, will give tolerable lighting, but when in suburban districts lights must be economized, it is better to trust to arcs spaced even so widely as to leave regions of comparative darkness between them.

Whenever possible, lights should be so located at street corners as to shine effectively in all four directions. They should be placed preferably on long mast-arms or on cross-suspensions, unless in a fairly clear street, where pole tops or short brackets are effective. One small but useful point in locating lights is as fol-

lows: Never locate a lamp, particularly an arc, at the curb squarely opposite a crossing, for the shadow of one walking on the crossing plunges his way into inky blackness as soon as he has passed the light.

Squares and open spaces should be treated somewhat in the same manner as streets, but if the spaces are clear the lights may well be placed higher than in street lighting, 30 to 40 ft. being advantageous. In well shaded spaces one may use lights of small intensity to considerable advantage, but ordinarily arcs do the best work.

As to intensity, the lighting depends on the character of the space, but it should never be less than in a well-lighted street. Now and then such lighting drifts naturally into a species of scenic illumination, the object being to bring some fine square into brilliant relief. Occasionally in such work incandescent lamps can be massed with admirable results, although in general it is not advisable to mix arc and incandescent lighting.

The arrangement of public lights should be more or less influenced by the general illumination of the private premises along the streets. In large cities it often happens that through the evening hours, when the citizens are much abroad, the sidewalks are fully lighted by the stray illumination from windows. In such instances the public lighting can be well directed toward special points where it will do the most good, care being always taken to see that the illumination does not fall below minimum requirements when the mass of private lights is out. In small cities there is comparatively little aid of this sort. The most troublesome problems are those connected with the environs of such cities where miles of sparsely settled streets must be dealt with.

The practical problem of adequately lighting the streets of a city is one which requires the local data for its solution. The amount and distribution of streets and the needs and distribution of the population are the controlling factors in the matter, and obviously these vary greatly from place to place.

Then, too, the cost of lights and the funds available for the purpose depend on local conditions. In particular, the price of lights varies so much that it is difficult even to strike an average. Few topics offer less chance for certitude or are more unsatisfactory to investigate. It makes a great difference whether full arcs or half arcs (so-called) are in use, or incandescents, or Welsbachs; also whether the lights are burned all night and every night, every night until midnight, or on "moonlight schedule," that is, on all nights and at all hours of the night when there is not clear moonlight.

In large cities the tendency is toward powerful arc lights burning every night and all night, supplemented by incandescent lamps and by gas burners. In smaller cities and towns the smaller arcs are apt to be used, burned either on moonlight schedule or until 12 or 1 o'clock.

In the latitude of the Northern United States "all night and every night" public lighting usually means from 3900 to 4200 hours of lighting yearly, according to the treatment of twilight and dawn, and the weather. The moonlight schedule is carried out with various slight modifications, and evidently depends considerably upon the weather, but in practice it amounts to not far from 3000 hours per year, while lights run from dusk to midnight, or 1 a. m., usually will burn 2000 to 2200 hours per year. All night and every night lighting is,

of course, the thing to be desired, but if economy is necessary, places of moderate size can be very satisfactorily lighted on a liberally administered moonlight schedule.

As between "full" and "half" arcs, the advantage economically lies, on the whole, with the former, provided the same total illumination is to be obtained in each case. The following table gives the spacing required for various radiants on an assumed minimum illumination of 0.02 candle-foot at a point midway between lights:

KIND OF LIGHT.	DISTANCE BETWEEN LIGHTS.	LIGHTS PER MILE.
6 6-ampere enclosed D. C. arc .....	340	15
9 6-ampere open D. C. arc . . . . .	315	17
6,6-ampere enclosed A. C. arc. . . . .	275	19
6 6 ampere open D. C. arc. . . . .	260	20
50-cp incandescent lamp, electric (or mantle burner).....	100	53

The relative expense of lighting by these various radiants depends in great measure upon circumstances not to be predicted. The price charged by lighting companies for public lighting is simply whatever the community will stand.

The relations between lighting companies and municipalities are, in most cases, mutually predatory. The former, having acquired and utilized a public franchise can, in a measure, hold the street against competition, and can maintain prices at the highest figure that can be juggled through the city government without public scandal. The latter, through the earnest efforts of its practical politicians, can worry and threaten the former into yielding up a substantial annual rake-off in the form of jobs for heelers, contributions to campaign funds, or plain cash. Occasionally simple and decent business

relations are maintained, but seldom for any great length of time.

The prices actually charged for public arc lights burned all night and every night range very widely, but usually between \$75 and \$125 per lamp per year. The former price is seldom reached or discounted, save in stations operated by water power or under very strong competition, and even then generally is only for "half" arcs. The latter price is seldom exceeded, save where underground distribution is demanded or in case of very scattered service.

Incandescent lamps of 50 candle-power, or thereabouts, usually bring \$30 to \$35 per year, and the former figure is a common one for mantle burners on the gas system. For equal minimum intensity of illumination there is not much to choose between the several illuminants at the prices mentioned, the choice between them being due to suitability.

At the same total cost, however, the arc lights give a considerably higher average illumination, and experience shows that on the whole the arcs, which have to be inspected at frequent intervals for the purpose of trimming, are kept nearer their point of maximum efficiency than either incandescents or gas burners.

The real cost of public lighting is, of course, immensely variable, since amount and price are both variable. In the average New England city most of the lighting is by arcs, and there is an average of one arc for each 175 to 200 inhabitants. The total cost of public lighting is frequently from 50 cents to \$1 per inhabitant, and sometimes rises to \$1.50, and even to \$2 per inhabitant. It is, therefore, no inconsiderable item of public expense.

Whether street lighting should be done by contract with a corporation or directly by the municipality is one of the mooted questions of economics. In theory, it would seem that such a public service should be done by the city or town itself, on the same principle that all towns own their sewerage systems and most own their waterworks. But while experience seems to have shown that public waterworks are in every way desirable, the same cannot be said of gas and electric plants. The arguments pro and con are about the same in each case, yet the average results seem to be different. In some municipal lighting plants, mostly small, the economic results have been excellent, in most they have been unmistakably bad.

If a municipality could start in *de novo* and erect its complete lighting system according to the best modern practice, and run that system anything like as economically as it would be run by a private company, it could unquestionably do its public lighting at a great saving in the majority of cases.

But it can rarely start and operate thus freely. It often is compelled by law to buy out the existing plant, generally at a price far larger than would suffice to erect a modern plant, for the art has been changing rapidly. It is lucky if a plant, old or new, can be secured without furnishing pickings and stealings for somebody, and in its operation the finger of the politician is too often inserted for no honest purpose.

In this matter of municipal plants statistics are even more utterly mendacious than usual, and conceal rather than disclose the facts in the case. With respect to electrical plants at least, however owned, there is nearly always deliberate concealment or entire neglect of de-

preciation, both that due to wear and tear and the larger amount due to improvements in the art, so that from the books or reports it is almost impossible to figure the actual cost of furnishing the electrical energy.

The matter may, on the whole, be summed up about as follows: If a municipality could both acquire a lighting plant and operate it at the ordinary current rates for apparatus, labor, and material paid by private buyers and employers, it could effect a large saving in its cost of public lighting; but if the plant is touched by venal politics it will assuredly prove a costly failure.

Many improvements are possible in street lighting, but for the present the arc lamp must be the main reliance. At first thought the Nernst lamp would seem to offer advantages, but it does not readily lend itself to the distribution in series which is desirable in street lighting for the sake of economy. Improvements in mantle gas burners may bring them into a position of great usefulness, which they have not yet attained by reason of their rapid deterioration. But for the most part the electric arc is the best available source of light.

Contracts for arc lighting should never be drawn on the basis of a nominal candle-power. They should clearly specify the kind of arc to be installed, the amount of energy to be taken in each arc, and the kind of shades to be used. The nature of the fixtures should be specifically designated, whether pole tops, brackets, mast-arms, or cross suspensions. These and the locations of the lamps should be designated by someone familiar with practical street lighting, following the general line of the data which have here been given. The hours of lighting should be distinctly stated, with rebates for failure to provide continuous light within these hours.

Such rebates should be merely nominal for deficiencies up to, say, 1 or 2 per cent. of the total hours of lighting, and punitive on an increasing scale for greater deficiencies.

The fixtures used for street lighting are of very various patterns, but fall into four general classes: pole-tops, brackets, mast-arms, and cross-suspensions. These have been, with the exception of the mast-arm, in use for public lighting for a very long period, going back to the days of oil lamps and candles. The pole-top fixture is essentially a support for a lamp on the top of a post. In arc lighting it is generally combined with a protecting

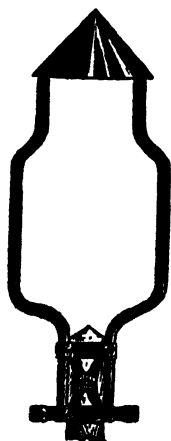

Fig. 103.—Pole-top.

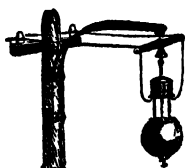

Fig. 104.—Bracket.

weather hood to shield the top of the lamp from the weather, and also sometimes to shield the individual switch for short-circuiting the lamp. Fig. 103 shows a typical pole-top such as is often used for enclosed arc lamps. The thin side rods are placed edge toward the arc to obviate shadows, and the whole affair fits neatly



upon the top of the pole, the arc lamp hanging from an insulated hook within the hood. The obvious objection to pole-top fixtures, whether for arc lights or for gas lamps, is that the light must be on the curb, and sometimes does not light the street properly. For open spaces where the pole can be out from the curb the pole-tops work well and may be freely used.

A very obvious modification is the lateral bracket carrying the lamp well clear of the curb, yet not so far out as to make it difficult to trim the lamp from the pole without lowering it. Fig. 104 is a specimen of this class, which carries the lamp 2 ft. out from the pole. If longer than this the lamp should be supported by a rope and lowered for trimming. Such brackets in various forms have been in use for a long time, and a neat iron pole and bracket dating back some seventy-five years is shown in Fig. 105. This is fitted with a pulley and cord for lowering the oil lamp for filling. It might be copied to advantage even now.

A somewhat analogous type of bracket has been introduced and very extensively used by the Boston Electric Light Company. It is a hollow casting, fitted to the top of a neat wooden pole, and permits the line wires to be carried within it clear to the lamp without exposing them. For underground service the pole itself may be hollow, thus entirely eliminating exposed wires. The lamp can be trimmed easily from the pole, and a cut-out, *A*, is fitted in the slight expansion near the base of the upright part of the casting. Fig. 106 shows this very neat and convenient fixture in outline.

Mast-arms are really modified brackets lengthened so much as to bring the lamps nearly or quite to the center line of the street, and usually arranged to permit the

lamp being readily lowered to the street for trimming. Now and then the lamp is carried on a trolley, which can be pulled in to the pole for trimming, but the preference is generally for the former plan. Fig. 107 shows a com-

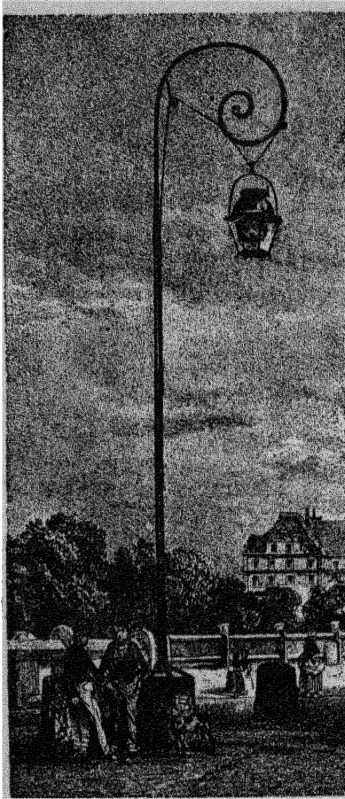

Fig. 105.—Antique Iron Pole.

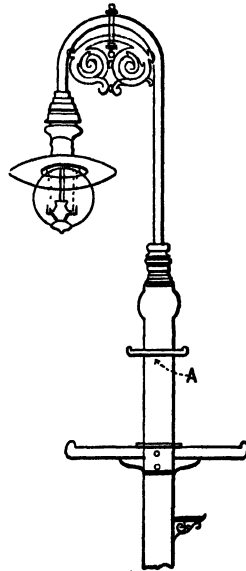

Fig. 106.—Boston Pole Fixture.

mon form of mast-arm fitted for lowering the lamp. The lamp is usually carried some 14 or 15 ft. out from the pole, hence the truss form becomes necessary to secure the proper degree of strength and stiffness.

Mast-arms furnish, on the whole, the best means of carrying the light out over the street. They call for but a single pole at the curb, and put the light exactly where it is wanted, and hold it there steadily. They are far from beautiful, however, and from the æsthetic standpoint the cross suspension is generally to be preferred. This is a very old method of supporting lights, and con-

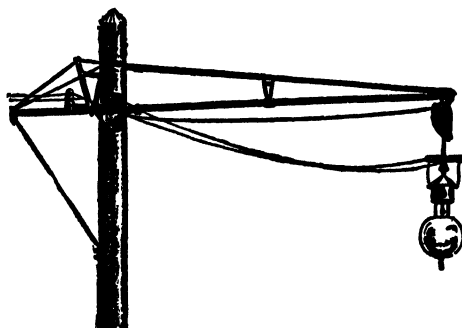

Fig. 107.—Mast Arm.

sists merely of a rope stretched across the street and bearing midway a pulley from which the lamp is carried. Fig. 108, from an old French print showing street lighting in Paris early in the eighteenth century, illustrates the principle as well as a more modern instance. To-day the rope is of wire strands and the lamp is an electric arc, but the rest has changed little.

In ordinary cases the cross suspension requires a pole set at the curb on each side of the street, which, except at corners where the pole lines cross, is somewhat of an inconvenience. Sometimes a tree is used for one support, but the practice is not to be encouraged, since it is both bad for the tree and renders the lamp rather unsteady in a wind. When conditions permit, cross sus-

pension, however, is a most useful and unobtrusive method of carrying the lamps.

In general, where there is an underground distribution, either of electricity or gas, pole-top and bracket fixtures are most useful for ordinary purposes. Fixtures like Fig. 105 lend themselves very readily to artistic treatment either for electric lights or for mantle or



Fig. 108.—Antique Cross Suspension.

regenerative gas burners. In streets thickly shaded by trees recourse must generally be taken to mast-arms or to cross suspensions in order to put the lights where shadows will not be troublesome. Sometimes even incandescent lamps are carried in the latter manner, though being rather closely spaced they, like mantle burners, give fairly good results if placed alternately on each side of the street and bracketed clear of the curb.

Generally, the lighting of a town will call into useful service all the ordinary types of fixtures, and an attempt to adopt a single standard form will lead to considerable embarrassment in the effective lighting of certain localities.

## CHAPTER XII.

### DECORATIVE AND SCENIC ILLUMINATION.

IN lighting large spaces either indoors or out, effective use may be made of arc lamps as well as incandescents. In some instances fairly good results are obtained by using for this purpose ordinary open or enclosed arc lamps with large metallic reflectors behind them. They produce a powerful and partially diffused illumination that is rather serviceable in many situations, but is neither very uniform nor intensely brilliant. Such places as piers are often thus lighted, the reflectors saving considerable light that would otherwise be thrown in useless directions and wasted. Even a reflector of tin covered with white enamel paint can be made very serviceable for this purpose.

If for any reason the white or bluish white light of the arc is undesirable, the color can easily be slightly modified by using on the arc lamp a globe of colored glass or coating a clear outer globe with the solution employed for coloring incandescent bulbs.

These cannot strongly tinge the light without greatly reducing it, since they color only in virtue of absorption, a red screen, for instance, giving a ruddy tinge to the arc by cutting off a large amount of blue and green rays.

In the absence of electric lamps display and scenic illumination is a rather difficult matter, this part of the art having been developed mainly by the stimulus of electric lighting. A certain amount of display lighting can be done by gas jets with ample reflectors arranged

much like those already shown, but the results are not generally satisfactory, since on account of the heat evolved the whole apparatus has to be bulky. Mantle burners are nearly useless in this connection, on account of their offensive color. For brilliant scenic work the calcium light is, however, extremely useful, although its use of many years in the theater has now been almost abandoned in favor of electric arcs.

Theatrical lighting effects really form an art quite by itself. It is quite impossible to give a connected account of it apart from an enormous amount of detail applicable to special problems. Broadly, it may be divided into three branches: The general illumination of the stage, scenic illumination of the stage, and the illumination pertaining to tricks and illusions.

The first mentioned branch differs radically from ordinary interior illumination in that the lights visible from the auditorium take little or no part in the real work. The footlights, merely incandescents in front of enameled reflectors, are of primary importance, and the remaining illumination has to be furnished from the wings and flies. Contrary to all usual practice elsewhere, such illumination must be nearly or quite shadowless, for it would be most awkward to have a massive stage oak casting the linear shadow appropriate to the board or canvas on which it is painted. Therefore, the general body of the lighting should be thoroughly diffused, as in illumination from a cornice or from concealed lamps above the ceiling, and if for any reason shadows are desired, they should be produced by auxiliary bright lights introduced for that particular purpose and screened from throwing telltale shadows where they are not wanted.

Not only must the general stage lighting be beautifully

diffused, but it must be under perfect control as to amount. To this end theaters usually have an elaborate equipment of rheostats, which can be thrown in series with the lamp circuits, and these latter are in numerous sections, so that the light can be made to fade gradually out without changing its intensity or its direction by perceptible degrees. When alternating currents are used the inductive regulators can be made to accomplish this very perfectly, and with an auxiliary storage battery one can do equally well with continuous current. Without these a smooth reduction of illumination is not easy.

One of the useful devices to this end is to divide the whole body of lights into overlapping groups. For example, if we imagine 100 incandescents to be massed across the flies, the division would be somewhat as follows: Lamps, 1, 6, 11, 16, etc., would form one circuit, 2, 7, 12, 17, etc., the second circuit, and so on, forming five groups. Then a rheostat of moderate size cut into circuit with each group successively prior to its extinguishment would enable the operator to fade out the light by almost imperceptible steps without altering its distribution.

Such, or an equivalent arrangement, is quite necessary, and should be capable of producing a uniform shadowless illumination of any required intensity, from the full glare of a spectacle down to a light so faint that a candle in the hand of one of the actors will cast a flickering shadow, for the stage is seldom really dark, however dark it may seem to the audience.

Whenever the illumination should have a definite direction, it can easily be given by special lights or circuits, but the groundwork of the lighting must be uniform and diffused.

The mainstay of special lighting effects is the stage projector. In the rough, this is a wide angle searchlight. For the source, there is a first-class focusing arc lamp taking an amount of current which can be regulated by a convenient rheostat. The reflector varies according to conditions. Sometimes it is a polished or enameled metallic parabolic mirror, sometimes for other purposes a wide parabolic wedge giving strong lateral distribution.

Fig. 109 is a good example of the adjustable projector lamp with universal adjustments for height and position of the lamp, and carrying at the base a well ventilated rheostat for the proper regulation of the current at the arc. Such lamps are made to take a considerable amount of current, often up to 10 or 15 amperes, and give a very steady and powerful light.

For the general purposes of stage illumination a condensed beam is not required. In this case a rack at the mouth of the reflector is arranged to take colored screens of any shade required. Those most often used are reds and pale blues. By means of such reflector lamps are produced most of the gorgeous spectacular stage effects, although in some cases regular stereopticon lanterns arranged with the dissolving view apparatus and fitted with colored screens are employed with admirable results, particularly in producing a very concentrated beam.

No general directions can be given for the amount of illumination required for this theatrical work, for the obvious reason that each stage setting has its own special requirements, which cannot be predicted. Roughly, the stage may require at times fully as much light as the auditorium proper. Considering the fact that the lamps must for the most part be out of sight of the audience and in rather disadvantageous position, it is safe to say that



a maximum illumination of not less than 1 candle-power per square foot should be provided for, aside from reflector lamps and the like. Most or all of this should be

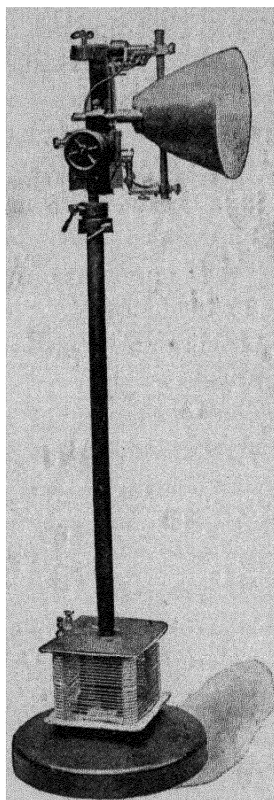

Fig. 109.—Projector Lamp

from incandescents, or gas jets, where electric lights are not available, for the more powerful single radiants dominate the illumination too strongly, unless used with great caution.

The more specialized part of scenic illumination which has to do with local illusions is even less easy to reduce to general principles. It is part of the art of the stage manager and his assistants. Since electric lighting has become general, the range of such work has been enormously widened. Stage lightning, which used to be produced by a prodigious flash of lycopodium powder blown across a gas jet, is now beautifully given by the momentary flash of a powerful arc.

Touches like Fafner's gaudy eyes and the forging of the sword in "Siegfried" are due to the skill of the stage electrician, and would have been quite impracticable a quarter century ago. A great deal of temporary work has to be done for any important performance, and much intelligent skill is required on the part of the operators, who sometimes have to follow a rapidly moving object about the stage with the beam from a projector, when a single slip would—and sometimes does—destroy the illusion and provoke unseemly merriment. It is almost needless to say that in stage illusions much depends on the arrangement of the background.

Another and very important branch of scenic illumination is the decorative lighting of large buildings and public places. The illumination proper in such cases has been already discussed, but the intelligent use of lights to bring out the full value of their architectural characteristics at night is quite another matter. Even so apparently simple a problem as the adequate illumination of a single monument requires considerable skill and care, and without these almost inevitably fails of producing the proper results. And when a great public building is concerned the task becomes far more difficult.

As a simple example of scenic illumination of this

general type let us take an assumed case and see what can be done with it. We will suppose the subject of our study to be a soldier's monument, such as may be found in scores or hundreds of American cities. It will generally be a shaft of marble or granite, surmounted by a figure or group in bronze, and with symbolic panels in bas-relief about the base. Now, the wisest course to pursue is to let the kindly shades of night cover the whole affair, but sometimes the monument is really fine, and so situated that it can be appropriately brought into relief by suitable illumination, or the citizens insist upon lighting it, and the attempt has to be made.

The broad rule that governs every such case is that it is both impossible and useless to attempt to simulate daylight. Full sunlight brings out details and produces effects that art cannot duplicate, so it is advisable to attack the problem along quite another line.

The chief difficulty of the task lies in the fact that bronze lights up very badly, particularly after it has acquired the fine *patina* given by age or skillful chemical treatment. Reflecting little light, it is very hard to bring into proper relief, and the usual result of attempting it is to bring the funereal shaft into great prominence, and to leave the figures almost imperceptible in the general gloom.

Lights placed upon the pedestal or shaft almost inevitably fail of reaching any useful result, by reason of throwing their light too sharply upwards. The angle of the illumination with the vertical should be at least 45 degrees, to obtain even a moderately good effect, and this is very rarely attainable. Arc lights placed on pole tops about the monument are sometimes tried, but since from every direction of view some of them must be visible to

the observer who is trying to see the object which they are supposed to illuminate, their glare quite defeats their main purpose.

Lights around the base may be able to illuminate the pediment properly, but they should be enough below the general line of vision to be pretty well out of the field of view.

About the only way of getting any effective illumination at the top of the monument is to use focusing lamps with projectors, something after the arrangement shown in Fig. 109. Three or four of these mounted symmetrically about the object to be lighted at any convenient distance will come as near an effective illumination as one may expect to get. Their beams should be inclined upwards enough to keep them effectively out of the field of vision, and the rest of the monument, if of light stone, should be left to itself. A figure wholly light in tone can be very beautifully illuminated by such means, as witness the fine colossal figure of Liberty at the Columbian Exposition, but if of bronze or similar dark material, *e. g.*, the great Bartholdi Liberty, adequate illumination is both very difficult, and if successful, decidedly expensive.

The problem of effective illumination is still further complicated when the object is a large building or group of buildings. The arcs with reflectors, which may be so well utilized for illuminating a comparatively small object, become almost useless on a large scale, owing to the total impracticability of furnishing from suitable directions enough light for the purpose. The lighting of a single monument may be regarded as a special case of the illumination often used on the stage, but architectural illumination is a matter very different from both this and from the illumination of large open spaces purely for

utilitarian purposes. It has for its object the display, in the most artistic manner, of the architectural values of great buildings and their surroundings. It is essentially decorative rather than utilitarian, and the methods must be governed by the effect desired to be produced rather than by considerations of rigid economy.

Such work must be done in connection with great expositions, important public places, and sometimes in a temporary manner for great civic functions. The object to be attained is no longer solely the illumination of a plane near the ground, but the bringing into splendid prominence of architectural features which would otherwise be lost in the darkness.

The first fundamental rule in this class of work is to abandon any attempt to simulate daylight, and after providing for adequate illumination of the ground by means which shall not interfere with higher planes of illumination, to sketch in light the principal effects of the scene before the eye.

Illumination of a great mass of buildings by reflected light is out of the question. If of dark material, it is a sheer impossibility, and even if the buildings be white, the shadow values of the daylight cannot be successfully imitated by radiants placed near the objects, which will therefore look either white and flat or mottled with petty shadows which melt in the distance into a muddy gray.

The configuration of the lights to be used in the luminous sketch that seems needful for the best artistic results may be roughly determined by making by daylight, or better, near sunset, a rough, clear, line drawing of the scene to be illuminated from a rather distant viewpoint, the further as the scale of the work increases. Then the distribution of lights following the principal points and

outlines of this drawing will give the main effects that one wishes to produce. The sketch may be filled up by adding necessary details not too brightly, and the ground illumination must be such as not to interfere with this general arrangement. Reflected light from the radiants thus dis-

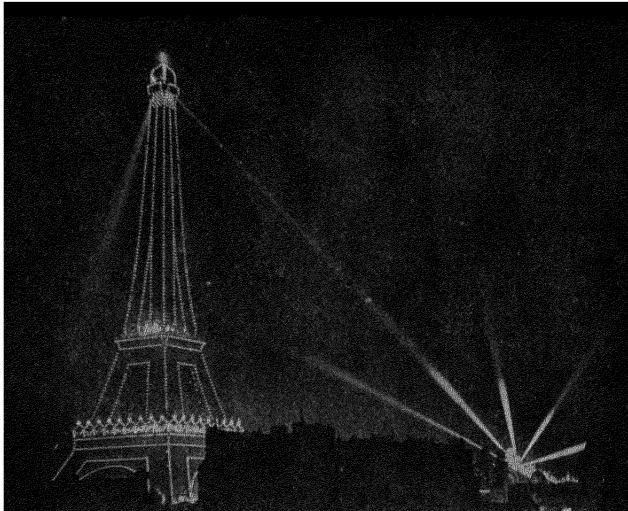

Fig 110.—Illumination of the Eiffel Tower.

tributed plays a useful part in adding to the general brilliancy of the effect without marring its artistic unity.

This was the principle applied in lighting the Eiffel Tower at the Paris Exposition of 1900, and the result, shown in Fig. 110, is most striking. The treatment must depend somewhat on the distance from which the general view is to be taken. The Eiffel Tower demanded, from its immense height looming against the sky, a simpler and more sketchy treatment than would have been advisable in a smaller structure generally viewed at comparatively

short range. Minute detail is lost at a distance in the general glitter, so that only broad treatment remains practicable.

The result of this general method has never been so magnificently shown as in the lighting of the Pan-American Exposition recently held at Buffalo. This was

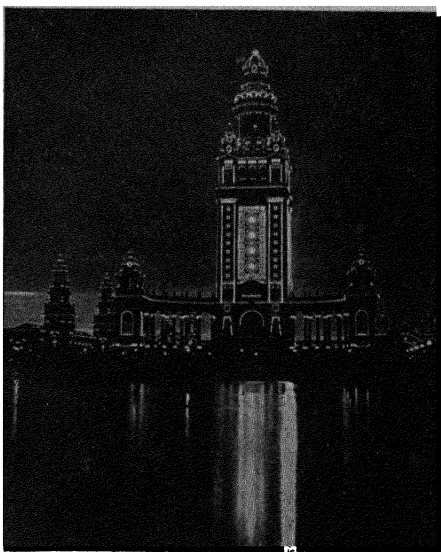

Fig. 111.—The Electric Tower at Buffalo.

planned by Mr. Luther Stieringer, a past master in the art of decorative lighting—in fact, one of the builders of the art itself. Two buildings at this Exposition show with beautiful distinctness the artistic value of the sketching principle just indicated. One, the great Electric Tower, 400 ft. high, shown in Fig. 111, is a perfect example of the application of the principles just laid down. This tower is the dominating note of the whole scheme of illumina-

tion, and it is therefore brought to an intensity greater than would be called for were it considered by itself. Even this characteristic would be indicated by a line sketch of the whole Exposition in grand perspective.

The treatment of a less important building is admirably shown by the other, the Temple of Music, Fig. 112. It is strikingly beautiful, yet perhaps might have been

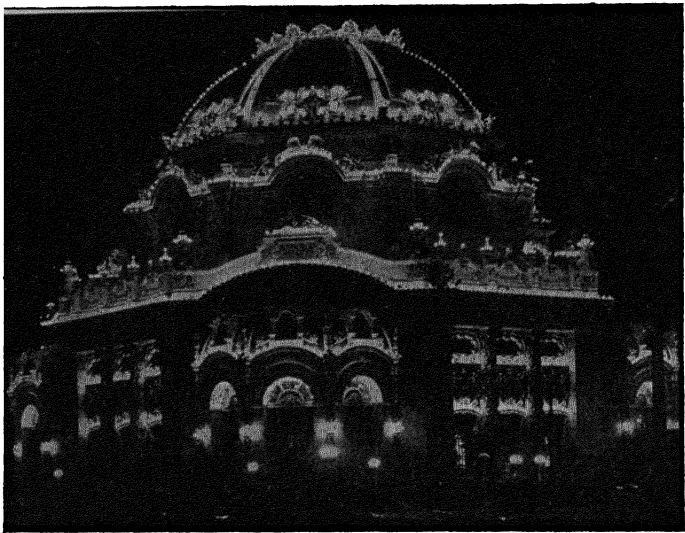

Fig. 112 —The Temple of Music at Buffalo.

improved by indicating some of the vertical lines in the lower part of the dome. A feature worth mentioning in the Electric Tower was the simultaneous turning on of all the lights and their gradual increase to normal brilliancy by the use of a huge water rheostat.

In this method of illumination powerful radiants are both needless and harmful, since they interfere with the



freedom of the sketching and blur the effect by masses of reflected light. If used at all in the architectural work, they should be used very sparingly, and Mr. Stieringer very wisely used the 8-cp incandescent lamp as his unit in the great work at Buffalo. Number of lights, and power of free sketching with them, is what is wanted, and for this an 8-cp lamp is quite as effective and far more economical than one of higher power.

Arcs must not be allowed to intrude themselves on the effects thus produced, following the principles long ago laid down in this volume. When used, as they may sometimes be, for ground or interior illumination, they should be so effectively guarded by opal globes that there shall not be a violent contrast in brilliancy between the various planes of illumination.

At Buffalo Mr. Stieringer dropped the arc altogether, save in certain features of display lighting, like the illumination of fountains and cascades by reflectors, and produced the ground lighting by clusters of incandescents. The real question, however, is not so much the choice of one or another source of light as the preservation of a uniform or skillfully graded tone of brilliancy in the general illumination. This is most easily secured by the use of incandescents alone, although there certainly are cases in which arcs could be used with admirable results as part of the general scheme. One difficulty with the use of incandescents heavily massed near the ground is the certainty of a number of them being burned out every evening, producing unsightly gaps in the symmetry of the display. Such failures are far less conspicuous at a distance, when the lights melt together. The general effect produced may be greatly modified by varying the number and intensity of the lights used. Small luminous

units not too thickly crowded give a transparency, an airy, unsubstantial appearance, that is lost when the radiants are so powerful or so numerous as to render much of the structure visible by reflected light.

The principles of architectural illumination have been well understood and skillfully acted upon, though perhaps not definitely formulated, for many years. Before the introduction of electric light reliance had to be placed on gas jets, lamps, and even candles for such work, and there is no doubt that very beautiful effects were produced, although at great cost of labor, and only temporarily. The nature of the radiants was such as almost to preclude the possibility of overdoing the illumination, and only with the advent of electric lights has there developed a strong temptation to try for daylight effects, always a failure from the artistic standpoint.

The absolute number of lights required to produce certain effects is more a matter of judgment than of calculation. If a row of radiants is intended to melt into a line of light, of course far more lamps are needed than if one merely desires a row of star-like points. Both arrangements may be advantageously used even on the same building. The ordinary 8 or 16-cp lamps melt into a practically continuous line at 500 to 800 times the distance between lamps, so that if, as on high buildings, they are normally to be viewed from a considerable distance, they may be rather widely spaced, while near the ground they may well be more closely spaced. A little tact will enable a certain perspective effect to be attained if desired.

The use of illumination by reflected light cannot well be combined with any other method, except as the lights used for the illumination may give enough surface reflection to enhance the general brilliancy. Therefore the

beams from reflector arcs must be kept away from reflecting surfaces which are to be sketched out in lines of light.

Colored light can be effectively used with reflector arcs, on white surfaces, on cascades, in fountains, and the like, but is seldom successful when tried with incandescent lamps, save on a very small scale. The difficulty lies in the dimness of colored bulbs and the failure of attempts to get delicate tints in this way. Colored glass bulbs are expensive, and coated bulbs accumulate dust and are seldom weather proof.

Much decorative lighting is for temporary purposes, but with the present facilities for obtaining current and the temporary mountings that can readily be obtained, the work is comparatively easy.

Special receptacles for signs and decorative designs are now made in convenient form for quickly putting together, and enable temporary work for special occasions to be very easily done. Fig. 113 shows one useful form of mounting device, in which the weather-proof receptacles can be quickly strung together with clamps and held neatly spaced in any way desirable. For decorative work on a considerable scale the retaining clamps would, of course, be much longer than here shown.

There is a fine chance for art in turning on the lights in architectural and other decorative work. The water rheostat, bringing all the lights simultaneously from a dull red glow to full brilliancy, is by far the most comprehensive scheme for the purpose. In the absence of this, or in permanent work of which only a part is regularly used, the circuits should be so arranged as to allow a perfectly symmetrical development of the lighting without throwing on a very large current at any one time.

In any and all decorative work the illumination must

be subordinated to the general architectural effect. Sins against art in this respect are all too common. Imagine, for example, a Doric temple with arc lights at the corners of the roof and festoons of red, white, and blue incandescents hung between the columns. About a structure of such severe simplicity lights must be used with extreme caution, while more ornate buildings can be treated with far greater freedom of decoration.

It requires both fine artistic instinct and great technical skill to cope adequately with the problems of decorative illumination. The tricks of the art are manifold, and mostly meretricious. The facility with which electric currents may be manipulated is a continual temptation to indulge in the ingenious and the spectacular without due regard for the unity of the results. Whirligigs, waving banners, rippling water, and the like are better suited to a Coney Island merry-go-round than to serious attempts at decoration.

Another class of work, hardly a part of ordinary lighting, but yet of considerable interest, is the use of lights purely for decorative purposes in interiors, in halls and auditoriums for special designs, and as part of the decorative scheme of ballrooms and the like. This is really a branch of the art due entirely to electric lighting—since only by this means can it be rendered fully serviceable. Most branches of illumination are in a measure independent of the particular radiants employed. But the ease and safety with which incandescent lamps can be installed renders them peculiarly applicable to such interior work.

In operating on a comparatively large scale, all sorts of decorative designs can be carried out by means of 8-cp or 16-cp lamps strung together in receptacles, in the manner of Fig. 113, or otherwise temporarily mounted

for the purpose. For work on a smaller scale, or in the preparation of very elaborate designs, other means may be employed.

For purely decorative purposes the miniature lamps serve a very useful purpose. Regular incandescents are made down to 6, or even 4, candle-power, but as has already been explained, the filaments for these powers at ordinary voltages must needs be very slender and fragile, and the lamps are nearly or quite as bulky as those of ordinary candle-power.

Hence for many uses it is better to make miniature lamps for connection in series, each lamp taking 5 to 25

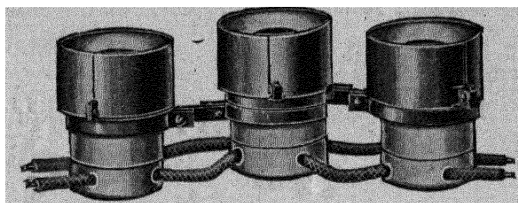

Fig. 113.—Chain of Receptacles.

volts to bring it to normal candle-power. Imagine a 16-cp, 100-volt lamp filament cut into four equal parts, and each of these parts mounted in a separate small bulb, and you have a clear idea of the principle involved. Commonly the miniature lamps for circuits of 100 to 125 volts are of 5 or 6 candle-power, and connected five in series across the ordinary lighting mains. Fig. 114 gives an excellent idea of the size and appearance of the perfectly plain miniature lamp. It is fitted to a tiny socket of the same general construction as the standard sockets for ordinary lamps, but taking up so little room that the lamps can conveniently be assembled in almost any desired form.

It is not altogether easy to manufacture these lamps so as to attain the uniformity necessary, if the lamps are to be run in series, and this at present constitutes a serious obstacle to their use on a large scale. They are generally not of high efficiency, since great uniformity and good life are the qualities most important.

They can be fitted with tiny ornamental shades, and

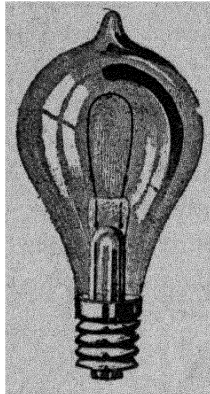

Fig. 114.—Miniature Incandescent Lamp.

may be obtained of various shapes and colors, so that very elaborate decorative designs can be built up of them. In indoor work colored lamps may be freely used, and are capable of producing some very beautiful effects, but the plain or ordinary frosted lamps are most generally used.

Owing to the small size of the sockets and fittings, the miniature lamps can be packed so closely as to produce the effect of an almost uniform line of light at comparatively small distances, so that most ornate schemes of ornamental illumination can be carried out by their aid. They are also very useful in building up small illuminated signs.

Lamps of special sizes and shapes, from a tiny  $\frac{1}{2}$ -cp bulb, hardly bigger than a large pea, to the candle-shaped lamp of 5 or 6 candle-power, are sometimes used with good effect in interior decoration. Figs. 115, 116, 117, and 118 show some of the commoner shapes used for such purposes. When a regular electrical supply is not available, these little lamps can be obtained for very moderate voltages, say, from 5 to 10 volts, and can be run in parallel from storage cells, or even from primary batteries, for temporary use.

Such small lamps are sometimes used in the table decorations for banquets, and for kindred purposes. By their aid surprising and beautiful effects are attainable, which would be quite impossible with any flame illuminant. But they must be cautiously used, for their very facility tends to encourage their employment in effects more bizarre than artistic.

It is well, too, to add a word of caution as regards the possible danger from fire. It is so easy to wire for incandescents that, particularly when using miniature lamps, there is a natural tendency to rush the work at the expense of safety. Lamps in series on a 110-volt circuit are quite capable of dangerous results if anything goes wrong, and even the battery lamps are not absolutely safe in the presence of inflammable material.

It should therefore be an invariable rule not to install a temporary decorative circuit without the same attention to detail that would be exercised in a temporary circuit of the ordinary incandescents. The same precautions are not always necessary, but all the wiring should be carefully done, joints should be fully protected, and, particularly, lamps should be kept out of contact with inflammable material.

The incandescent lamp is often commended as producing little heat, and, in fact, as compared with other illuminants, its heating power is small. But a vessel of water can be boiled by plunging an ordinary 16-cp lamp in it nearly up to the socket, and cloth wrapped about such a lamp will infallibly be ignited within a comparatively

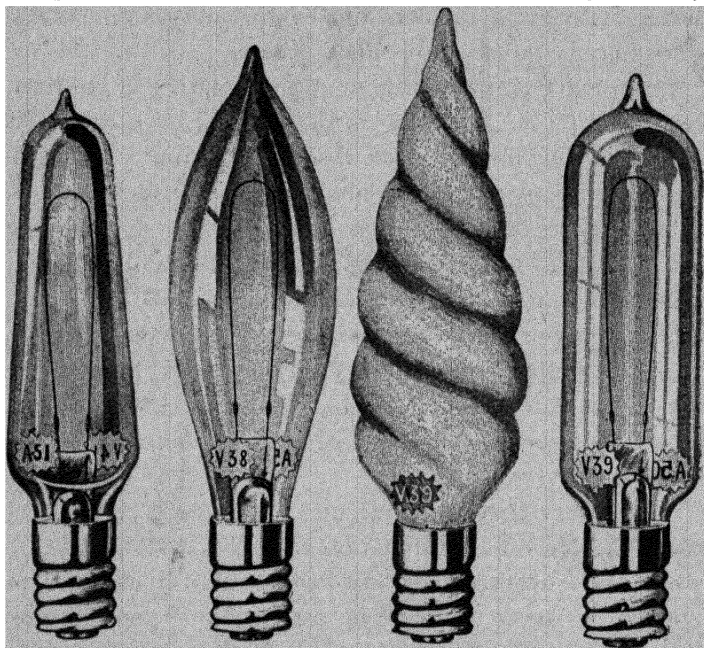

Fig. 115.

Fig. 116.

Fig. 117.

Fig. 118.

Various Forms of Miniature Lamps.

short time. The fact that the cloth does not burst into flame in a few minutes does not indicate safety, for time is an important element in ignition, and even an overheated steam pipe is capable of setting a fire, low as its temperature is. A good many fires have been started in shop windows by hanging fabrics too near to incandes-



cent lamps, and even the miniature lamps are quite capable of similar mischief if in contact with anything easily inflamed. No illuminant has so high an efficiency that it produces a negligible amount of heat from the standpoint of fire risk.

Special cable is now made to which lights can be attached with great facility, and by this means temporary work may be quickly and safely done.

In ordinary domestic illumination miniature lamps have very little place. Nothing is to be saved by using them so long as they must be used in series at ordinary voltages. Now and then a 4 or 6-cp lamp may be useful as a night lamp, but it is better to use an ordinary lamp of moderate efficiency than to try miniature lamps. Sometimes, however, a circuit of miniature lamps may be installed for a dining room or a ballroom with excellent artistic results. In such cases it is better to use ground than plain lamps, and, as a rule, colored lamps should be eschewed, on account of the impossibility of getting delicate tints to show effectively.

Temporary decorative circuits may, however, be very useful in domestic illumination for fêtes and the like, in which case delicately colored ornamental shades can be applied or the lamps may be used in Japanese lanterns. Any country house fitted for electric lights can be temporarily wired for such purposes rather easily, and out-of-door temporary wiring can be installed without the rigid precautions necessary indoors.

In all decorative lighting it is important to recognize the fact that illumination is a means to an artistic end, and not of itself the primary object. One is, in these days of electric lighting, far more likely to err by providing too much light than by failing to supply enough.

Great brilliancy is far less important than good distribution and freedom from glare. It is highly probable, for instance, that the effect of the illumination of the Electric Tower at the Pan-American Exposition would have been seriously injured by the substitution of 32-cp lamps for the 8-cp actually used, and it is absolutely certain that a dozen arc lights injudiciously placed would have detracted greatly from the harmonious result.

In interior illumination the same rule holds true. By the reckless use of brilliant radiants one can key the vision up to a point where its power of appreciating values in illumination is almost entirely lost. In decorative lighting great care must be used not to approach this point, to leave the relief afforded by light and shade, and to realize the perspective in the details of the illumination.

In the absence of a foreground one's judgment of distances is completely upset, as witness the great difficulty experienced in estimating distances correctly over water on the one hand or in a thin fog on the other. In scenic illumination the distribution of luminous values can be utilized with great facility for producing illusions of distance, giving at will the effect of startling flatness or of interminable vistas. In stage illumination such devices are now and then used to heighten the effects, although other exigencies often interfere with the proper development of the scheme.

The commonest cause of failure in proper illumination is thrusting a brilliant light between the spectator and the object to be viewed, with the inevitable result of losing detail and hurting the eyes. Brilliant diffused light is in this particular only less objectionable than direct light, and both should be assiduously avoided.

It must not be supposed that decorative lighting must

necessarily be electric, since very beautiful results were attained before electric light was heard of, but electric lighting is unquestionably the most facile means of securing artistic results on a large scale.

A special department of lighting, peculiar to the electric branch of the art, is the use of the searchlight for scenic or utilitarian purposes. The searchlight is now a familiar object, consisting of a very powerful arc light, taking

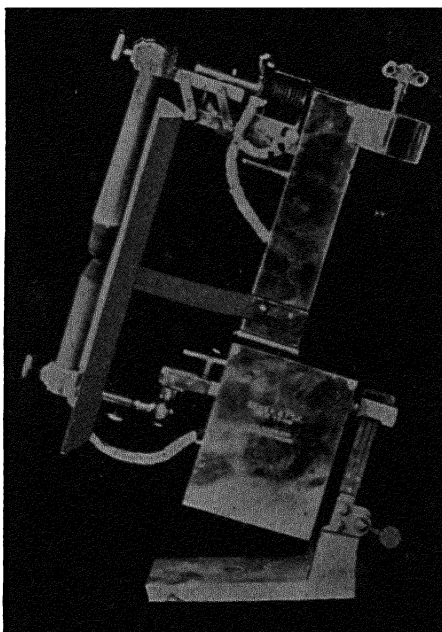

Fig. 119.—Searchlight Lamp.

from 20 to 50 or more amperes, kept steadily by automatic focussing apparatus in the focus of a parabolic mirror, sometimes with an auxiliary lens system. The material of the mirror is most often silvered glass, unless

the parabolic surface is very deep, when silvered metal is generally employed.

As the purpose of the searchlight is to give a parallel beam of light, the carbons between which the arc is formed are not in line, but staggered, as shown in Fig. 119 so that the crater of the arc points obliquely backward, and the carbons are tilted so that this crater faces fairly the apex of the mirror instead of its aperture. An opaque disk between the arc and the mirror aperture cuts off all stray direct light, so that all the light sent out is delivered from the mirror in a nearly parallel beam. The whole affair is mounted in a case having rotation about a horizontal and a vertical axis, forming the familiar device shown as a whole in Fig. 120.

The mirror aperture may vary from a foot or so up to 4 or 5 ft., the searchlights most often used having from 2 to 3 ft. of aperture. The most perfect results are given by using a rather shallow parabolic mirror of silvered glass, which can be given a better and more permanent figure than a deep metallic mirror, and hence gives a beam more accurately parallel.

The searchlight, when properly constructed, will throw a dazzling beam many miles on a clear night, but in foggy weather, or even in a comparatively thin haze, its field of usefulness is greatly limited. It is of only casual use in ordinary forms of illumination, and its chief legitimate use is the illumination of special objects, in the manner already described in connection with the simpler reflector arcs. It is often abused by its application to advertising, and to a glaring and offensive simulation of daylight in places that have no need of it.

It is of considerable military and naval value, serving to detect movements of an enemy's troops or to pick up

hostile vessels, and it is also of no small importance in military signaling over long distances. For this purpose it is turned upwards upon the distant sky, where its glare is visible in clear weather even up to a distance of forty or fifty miles. Then, by deflections of the beam, or by periodically cutting it off by a register shutter over the front, communication may be established by the regular Morse or heliographing code, either openly or in cipher.

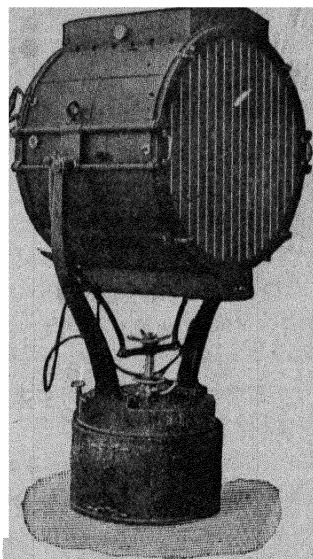

Fig. 120.—Search Light.

Its use in this fashion was especially striking during the recent operations for the relief of Kimberley.

It is also a valuable adjunct in coast defense, particularly of narrow channels and of mine fields, where it can be used both to confuse the hostile pilots and to make a clear target of hostile ships. But its range of effectiveness for such purposes is popularly much over-estimated.

In clear weather it would quite certainly pick up a large vessel by the time it had come within effective gun range. On torpedo boats and similar small craft, however, painted in neutral tints, as they are for war, the searchlight has a useful scope of little over a mile in distance, and in hazy weather even less. It has therefore for naval, as for general purposes, a somewhat circumscribed field of usefulness, within which, however, it is undeniably of great value.

## CHAPTER XIII.

### THE ILLUMINATION OF THE FUTURE.

At the present time the ordinary materials of illumination are pretty well understood, and their proper use is a matter of good judgment and artistic sense. Illumination is not a science with well-defined canons of what one might call illuminative engineering, but an art wherein an indefinable and uncommunicable skill pertains almost as it does in the magic of the painter.

There are certain general rules that must be followed, certain utilitarian ends to be served, but whether the result is brilliantly successful or hopelessly commonplace depends on the skill that inspires it. There must be in effective illumination a constant adaptation of means to ends, and a fine appreciation of values that quite defies description. One may attack the problem of illuminating a great building with all the resources of electrical engineering at his command, and score a garish failure, or he may conceivably be confined to the meager bounds of lamps and candles, and still triumph.

The general tendency with the modern intense radiants at command is to light too brilliantly, to key the vision to so high a pitch that it fails to appreciate the values of the *chiar-oscuro* on which the artistic result depends.

The desideratum in illumination, except for a small group of scenic effects, is the possession of cheap and fairly powerful radiants of low intrinsic brilliancy capable of

modification in delicate color tones. It is doubtful whether these qualities are compatible with very high luminous efficiency in a flame or incandescent radiant. In modern gas and electric lighting the progress toward efficiency is in the direction of very high temperature, which implies high intrinsic brilliancy.

Vacuum tubes lamps, at present in only a crude experimental stage, give hope of better things, but at great risk of color difficulties, particularly if high efficiency is reached.

Ideally, a gaseous radiant, with nearly its whole luminous energy concentrated in the visible spectrum, would give magnificent efficiency, but it by no means follows that it would give a good light. Sodium vapor meets the requirements just noted tolerably well, yet there is no more ghastly light than that given by a salted spirit lamp.

It might be possible to work with a mixture of gases such as would give a light approximately white to the eye, and yet be very far from a practicable illuminant, for the phenomena of selective absorption are such, as we have already seen, that the color of a delicately tinted fabric depends on its receiving a certain scale of colors in the light which it reflects. To the eye a much simpler color scheme is necessary to reproduce light substantially white, and such light falling on a colored fabric would by no means necessarily bring out the tints that glow by daylight.

Even the firefly's secret, could man once penetrate it, might not prove such a valuable acquisition as it would seem at first thought. To the eye the light of most species seems greenish, and, in point of fact, it so completely lacks the full red and the violet rays that its effect as an illuminant on a large scale would be most



disagreeable, far worse than an early Welsbach at its most evil stage of decrepitude. We must not only steal the firefly's secret, but give him a few useful hints on the theory of color before the net result will be satisfactory from the æsthetic standpoint. Firefly light might do for a factory, but it would find but a poor market as a general illuminant.

It is a somewhat difficult matter satisfactorily to define the efficiency of an illuminant. Luminosity depends, like sound, upon the physiological relations of a certain form of energy, and cannot be directly reduced to a mechanical equivalent.

The commonest conception of the efficiency of an illuminant is to regard it as defined by the proportion of the total radiant energy which is of luminous wave lengths. From this point of view the efficiency may approach unity either by the absence of infra-red and ultra-violet rays, in other words, by purely selective radiation or by so great an increase of radiation in the visible spectrum as to render the energy of the remainder nearly negligible.

In the former sense the luminous radiation of the firefly is of perfect efficiency; but, obviously, a purely monochromatic light utilizing the same total amount of energy might give a vastly better illumination—or a much worse one, according to the wave length of the light in relation to its effect on the eye.

On the other hand, an arc between tiny pencils of the material used for Nernst glowers is reputed to give, so far as watts per candle-power go, an efficiency nearly as good as can be claimed for the firefly. The experiments in this case are perhaps not beyond cavil, but, even granting their substantial accuracy, it is perfectly certain that

such an arc gives radiation by no means confined to the visible spectrum.

The most that can be said in a definite way is that assuming a continuous spectrum with its maximum luminous intensity in the yellow or yellowish green, there seems to be little chance of doing much better than about 0.2 watt per candle-power.

Until practical illuminants of some kind can be worked at an efficiency within hailing distance of this figure, one need scarcely worry about the possibility of combining nearly monochromatic radiations so as to give true chromatic values.

At the present time only the most powerful arcs approach an efficiency of 1 watt per spherical candle-power when so shaded as to be of much use as illuminants in the ordinary sense. Ordinary arcs properly shaded are good for 2 to 3 watts per candle-power, and even the best incandescents will hardly do better than 4 watts per candle-power.

For everyday work the thing most needed is an efficient light of moderate candle-power and moderate intrinsic brilliancy combined with low cost and good color. Save under special circumstances very powerful radiants are disadvantageous, particularly if of great intrinsic brilliancy.

Casting about the field, it certainly appears at first glance as though most modern radiants had been developed in the wrong direction. In particular, electric lights have been steadily pushed in the direction of enormous working temperature and very great intrinsic brilliancy, gaining greatly in efficiency, of course, but losing in convenience. What is most wanted is not a light giving 5000 candle-power at 0.2 watt per candle, but one

giving 5 or 10 candle-power at even 1 watt per candle. The vacuum tube lamp seems at present to give the greatest chance for revolutionary improvements, and even this seems to involve very serious difficulties.

Similarly, in gaslights we have regenerative and mantle burners giving 50 or 100 candle-power at a very good efficiency, but they are too powerful and too bright to be entirely satisfactory, even were they open to no other objections. For most purposes a Welsbach giving 15 candle-power on 1 cubic foot of gas per hour would be vastly more useful than one giving 75 candle-power on 4 cubic feet per hour. Of flame radiants none save acetylene marks any material advance in recent years in point of easy applicability.

It would seem that modern chemistry might achieve something of value in adding to the materials of illumination. There is a group of occult substances possessing enormous power of giving off radiation akin to that involved in the X-ray, whatever that might be. It is perhaps not too much to hope that some material of similar potency with respect to luminous rays may reward the pertinacious investigator. There is no intrinsic reason why an exaggerated type of phosphorescence, capable of storing sunlight at a high efficiency, may not in due season be evolved. This would settle the artificial lighting problem—unless the color were irremediably bad—in a beautifully simple way. Or it might be possible to reproduce by a commercial process the slow oxidation or analogous change responsible for the glowing of decaying wood and of certain micro-organisms, and probably also for the light of the firefly and his allies.

Whatever the method, the aim of improvement should be the production of efficient lights of moderate intensity

and intrinsic brilliancy, coupled with good color, preferably capable of easy modification.

The steady tendency as the art of illumination has advanced has been towards more and more complete subdivision of the radiants, and the subordination of great brilliancy to perfect distribution. One of the most important lessons of the Pan-American Exposition was Mr. Stieringer's demonstration of the magnificent usefulness of 8-cp incandescent lamps, skillfully installed.

In the art of illumination as much depends on the efficient use of lights as on the efficiency of the lights themselves. A tallow candle, just where it ought to be, is better than a misplaced arc lamp, and, even taking our present illuminants with all their limitations, skill will work wonders of economy.

It is particularly in the direction of adroit use that the present path of progress lies. One of the fundamental facts in practical lighting which has been many times suggested in these pages, and which lies at the root of improvements, is the need of keeping down intrinsic brilliancy.

The true criterion of effective and efficient lighting is not simple illumination, which resolves itself into a pure matter of candle feet, but *visual usefulness*, which takes account of the physiological factors in artificial lighting.

If one denotes the illumination measured in candle feet or other convenient units by  $I$ , then the *visual usefulness* is measured by the product  $I \sigma$ , where  $\sigma$  is proportional to the effective area of the iris. This of course is constantly shifting as the illumination changes, but, broadly, it is an inverse function of the intrinsic brilliancy of the radiants used. The criterion thus becomes of the form

$i = \frac{I}{f(B)}$ , where  $B$  is the intrinsic brilliancy of the

radiant, and  $i$  is the visual usefulness, or the effective brilliancy of the illumination.

Now as a matter of practice this is important, for it indicates that a badly placed arc light, for example, may actually work serious injury to the effective illumination, and within reasonable limits one could fairly go so far as to say that the usefulness of an unmodified radiant varies inversely with its intrinsic brilliancy. Obviously, then, shading the radiant may actually gain useful illumination, although it actually loses light, which in fact experience has shown to be the case.

As to the permissible intrinsic brilliancy for ordinary cases of illumination, exact figures are from the nature of the case hardly attainable. Yet one may derive a pretty clear idea of the situation from the experiments of Professor L. Weber given in the following table—reduced to candle-power per square inch.

Horizontal white card reflecting brilliant sunlight,	. . .	25
White cloud reflecting brilliant sunlight,	. . .	7
Argand burner,	. . . . .	65
Horizontal white card under a dull winter sky,	. . .	0.26

Now the intensity in the first named case is certainly most painfully great, and even those in the second and third cases are still great enough to be very unpleasant if fairly in the field of view. On the other hand, the last case evidently is one in which the intrinsic brilliancy is unnecessarily low.

Taking all these things into consideration, it is a safe working rule to *keep the intrinsic brilliancy of all radiants within the field of vision below 5 cp per square inch*—preferably down to half that value.

This limit affords a means of determining the approximate size of any diffusing globe or shade, since evidently

whatever the candle-power of the light, the visible diffusing surface must not exceed a brilliancy of 5 cp per square inch. If, therefore, we are dealing with a light of 100 candle-power, that amount of light must be scattered over and by at least twenty square inches of diffusing surface. Two conditions enter to modify the situation: On the one hand, a certain amount of the inwardly incident light is actually intercepted by the shade; on the other hand, the diffusion is not uniform, especially if the radiant has great intrinsic brilliancy and the shade is fairly translucent. For heavily ground or fairly dense opal shades the above ratio is not far from right, the modifying factors tending to offset one another. Such shades intercept about one-third of the total light as a necessary feature of keeping the intrinsic brilliancy within bounds, so that it is not unfair to say that for most practical purposes 100 candle-power in a radiant of really low intrinsic brilliancy is as useful as 150 candle-power in a very intense radiant.

Now practically all our modern sources of light require shading, if within the field of vision. The obvious moral is that one of the great economies in lighting is centered in keeping the radiant out of this field.

In electric lighting, incandescent lamps at 3 watts per candle area, so disposed as to keep clear of the field of vision, are fully as valuable illuminants as lamps at 2 watts per candle wrongly installed, so as to either dazzle the eye or to require shading to avoid it. Shaded they must be for hygienic reasons whenever visible.

In actual practice it is a matter of great difficulty to place lights wholly out of the field of vision, and the more brilliant the lights are the greater necessity for shading them. Hence, it becomes a difficult matter to treat modern illuminants without loss of efficiency.

Perhaps the most promising line of improvement in artificial lighting, and the one from which most may be expected in the near future, is indirect lighting by diffusion. A glance at the tables in Chapter III. shows that with a good diffusing surface scarcely more light is lost than is cut off by proper shading. As the intrinsic brilliancy of the source rises, the relative importance of diffusion increases, since shading to be effective must be denser.

Of diffusing shades only the holophanes intercept materially less light than would be lost in a good diffuse reflection, and even in this case the shade must be of considerable dimensions to keep the intrinsic brilliancy sufficiently low. As compared with a ground glass or opal shade, they should have considerably greater total surface for a light of equal power.

There is room for splendid developments in diffuse lighting, using arcs, Nernst lamps, incandescents, Welsbach mantles, and acetylene. In this way such radiants can be used unshaded with the full advantage of their great efficiency, and with good diffusion from white or nearly white surfaces the net efficiency remains high. As has already been noted, lighting by diffusion in ordinary dwellings, where the surfaces are not generally good, requires a liberal use of light, but with a careful study of the conditions will come the possibility of very efficient and beautiful lighting in which the radiants shall, save in rare instances, be wholly invisible.

This method of working, too, has a great artistic advantage, in that the light can be successfully modified by tinted diffusing surfaces with far greater success than by any arrangement of colored shades.

The latter are not available in delicate and easily

graduated shades, while pigments can be worked upon diffusing surfaces in almost any desired manner.

It thus becomes possible to use effectively not only radiants of intrinsic brilliancy too great to be easily managed by shades, but those of naturally objectionable colors. Bad color is of course equivalent to inefficiency in many instances, since a considerable amount of light must be cut off and thrown away to correct the color, but this can be done at as little loss by diffuse reflection as by any other method.

The weak point of lighting by diffusion is the fact that the radiants are then usually installed in rather inaccessible places, and the globes are likely to suffer from dust, unless special care is taken. A favorite location for such lights is above and partly behind a cornice, a situation in itself very advantageous but difficult to get at. Ordinary ceiling or cornice incandescent lamps can be removed for cleaning by a special handler made for the purpose, but lights behind a cornice must be reached with a step ladder.

Gaslights, of course, cannot be readily installed in such a situation, and when used by diffusion must be screened like arc lamps.

The introduction of new illuminants is very likely to effect useful modifications in our methods of lighting. If the vacuum tube line of experimentation leads to anything practical, it will probably provide light of rather low intrinsic brilliancy, so that shading will be relatively less important than it now is. There will thus be a practical gain in efficiency even greater than the gross relative efficiencies of the lights would indicate.

Perhaps the most promising light of the class just mentioned is the mercury lamp, to which some reference



has already been made. Up to the present its very objectionable color stands in the way of its commercial development, but if this fault can be remedied the mercury lamp certainly has a future, since it is highly efficient, and can be worked successfully on the ordinary continuous current constant potential circuits. Most vacuum tube schemes, and indeed most of the other devices recently suggested for securing high efficiency, require alternating currents, so that the mercury lamps would be particularly welcome as averting the need of an extensive change of equipment.

Increase of efficiency in mantle radiants may in some degree be obtained by the use of substances giving more strongly selective emission of light than any now familiar, but, aside from this, efficiency can only be raised by forcing the temperature.

The somewhat promising field of phosphorescence is practically unexplored. A few interesting, but so far futile, experiments have been tried by Edison and others as a result of X-ray investigations. The subject is well worth investigation, both from the electrical and the chemical sides, and will doubtless take its turn sooner or later.

Meanwhile we must do the best we can with the illuminants which are now at hand, to furnish light of suitable amount and quality. To sum up the suggestions repeatedly made in these pages, the commonest failings in present methods of lighting are a tendency to use too brilliant radiants and to make up in quantity what is lacking in quality. More study of the practical conditions of lighting and less blind faith in bright lights would generally both improve practical illumination and tend to economy.

Imagine, for example, an attempt to light a billiard room where the balls had been stained to match the cloth. Yet this sort of thing, on a less aggravated scale, happens far oftener than would be thought possible. Even in buildings designed to fulfill hygienic conditions, sins against the fundamental principles of lighting are distressingly common. An observing writer has grimly designated modern schools, "Bad-eye factories," and certainly, even with the full advantage of natural light and buildings in which conditions ought to be favorable, the results are frequently bad.

With artificial light the task of proper lighting is of increased difficulty, and is further complicated by the sometimes impossible requirements of the latest fashionable scheme of decoration. The best results can be attained only by constant attention to details and a keen perception of the conditions to be met.

The illumination of the future ought to mean the intelligent use of the lights we now have, not less than the application of the lights which we may hope in the fullness of time to obtain.

## CHAPTER XIV.

### STANDARDS OF LIGHT AND PHOTOMETRY.

OF all important physical constants none are in so unsatisfactory a state as those pertaining to illumination. In spite of the efforts of several scientific congresses, there is no international convention regarding the unit of luminous intensity, nor is there any one practical unit in general use.

A standard to be worthy the name should be accurately reproducible without extreme difficulty, and ought, as well, to bear a fairly simple relation to other units which are related to it. Now, a standard of light stands quite by itself in kind, and should consist of some determinate light-giving body so constituted that it can be reproduced and used in any part of the world without material error.

Unhappily, such a light-giving body is not easily, if at all, obtainable, hence the present confusion.

The only attempt yet made to produce a really logical and scientific unit was that brought to the world's attention by M. Violle at the international electrical congress held in Paris in 1884. Violle proposed as the unit of luminous intensity the light emitted, normal to its surface, by one square centimeter of platinum at its melting point.

This unit was one based on definite things; was of very convenient magnitude, about 20 candle-power; and of good color, nearly white. But it is a very inconvenient unit to work with, and to reproduce accurately, on account

of the enormous temperature necessary to melt platinum, the uncertainty introduced as to its exact melting point by the presence of trifling impurities, and for other minor but sufficient reasons. So the upshot of the matter has been that this unit has been laid upon the shelf, and while much good came from the agitation of the subject, the world still depends on the curious assortment of units sanctioned by more or less extensive usage.

The practically and legally adopted unit of light in English-speaking countries is the so-called *standard candle*. This illuminant has its composition, dimensions, weight, and rate of burning specified by law, and can be cheaply and easily obtained. It is a spermaceti candle, weighing 1200 grains avoirdupois (6 to the pound), and burning at the rate of 120 grains per hour. The standard diameter is 0.8 inch at the top and 0.9 inch at the base, and the normal height of the flame is about  $1\frac{7}{8}$  inches over all.

The rate of burning may vary in practice from about 110 grains to 130 grains per hour, and in photometric work the luminous intensity is assumed to vary directly with the rate of burning. Selected candles burned under uniform conditions run somewhat closer to the standard rate of burning than the above figures, and burn with a uniformity that, considering their structure, is remarkable, but the presence of the wick, accidental variations in manufacture, and numerous minor causes make the candle at best rather unreliable. With great care in using it may be coddled into a degree of precision of approximately two or three per cent.; but variations of twice that amount are common.

In France, and to a considerable extent in Italy, the Carcel lamp is used. This is a standard which was

adopted after the investigations of Dumas and Regnault some forty years since. It is an oil lamp of special construction, made according to a very minute specification as to dimensions, including the structure and weight of the wick, and burns refined colza oil, largely used as an illuminant in France. Its normal consumption of this oil is 42 grams per hour, with a permissible variation of 4 grams per hour in either direction. It gives a rather yellowish light of nearly 10 candle-power, and has probably about the same possible degree of precision as the English candle, though it should average a little better.

In Germany a standard paraffine candle, made in pursuance of a most elaborate specification, is used to some extent. It carries a longer flame than the English candle, two inches being the standard height, and is about 10 per cent. more powerful, with, in other respects, much the same general properties.

The standard most used in Germany, however, and often employed in other countries for purposes of reference, is the so-called Hefner unit, being the light given by the amylocetate lamp introduced by Von Hefner-Alteneck. This standard lamp is made from a uniform specification as to dimensions, and has the great advantage of burning a perfectly definite chemical compound easily obtained in a state of great purity. It has been very exhaustively investigated at the Reichanstalt, from which certified tested standard lamps can readily be obtained, and its performance under varying conditions of flame height, temperature, barometric pressure, and so forth, has been carefully studied. Its normal flame is 40 mm. high and its intensity is then about 10 per cent. less than that of the English candle.

Being the legal standard in Germany, and widely used

elsewhere on account of its steadiness and the accessibility of certified examples, the Hefner-Alteneck lamp comes nearer to being a real international standard than any other. When used in strict accordance with the minute instructions accompanying each lamp, it is subject to errors less than half as great as those met with in standard candles, and, while not perfectly steady, is far steadier than a candle or a Carcel lamp. Its weakest point is its color, which is distinctly reddish orange.

This constitutes a rather serious objection to its use as a working standard in measurements made, for instance, on mantle burners or incandescent lamps. Even as a primary standard its color and rather small intensity form an obstacle to its convenient use; but all in all it has been rather generally recognized as the best primary standard yet devised.

Reproducibility is after all one of the most important requirements in a primary standard, and this the Hefner-Alteneck lamp possesses in a very unusual degree.

In working standards the most necessary qualities are great temporary steadiness and convenience as to color and intensity. These requirements are far more easily met than that of exact reproducibility, and in practical photometry reliable secondary standards are obtained with comparative ease.

One of the simplest and most useful is obtained from an Argand gas burner, such as has already been described as used for testing purposes.

Burned at a carefully regulated pressure, with a delicate meter by which to adjust the consumption, and a blackened screen to cut off all the light save that through a narrow aperture of definite dimensions, a gas jet gives a wonderfully steady light, extremely well suited to

photometric work. This arrangement is substantially that of the Methven screen, which is widely used in photometry. If it were practicable to prepare at short notice a gas of definite composition, this apparatus might make a good primary standard, but attempts along this line have not been very successful. Acetylene has been suggested for the purpose, but experience has shown that it is peculiarly subject to variations in luminous intensity, and is worthless as a standard illuminant.

Aside from the Methven screen, the most generally used secondary standard is the incandescent lamp. If the filament is not worked at too high a temperature, *i. e.*, at too great efficiency, and is aged by several hundred hours of preliminary burning, it constitutes an admirably reliable standard.

Burned at a fixed and uniform voltage, its intensity can be accurately determined by comparison with a primary standard, and remains very nearly uniform, having a slight and definitely ascertainable decrement with time.

In practical photometry such a lamp is merely balanced against an ordinary aged lamp used in the photometer for testing purposes, remaining itself a standard of reference.

Several attempts have been made at an incandescent lamp as a primary standard, the filament being of definite material and dimensions enclosed in a globe of specified character, and worked with a definite amount of current.

The result has not so far been encouraging, and in the absence of anything better the Hefner-Alteneck lamp is the main reliance as a reproducible standard.

At the time the Violle standard was proposed the one-twentieth part of it was tentatively adopted as a working unit and was styled the bougie décimale, but this somewhat hypothetical unit has never come into any repute,

although its relation to the more common standards has been determined with a fair degree of precision.

The following table gives the relation between the several primary standards here referred to with as much precision as the nature of the case permits, perhaps rather more, since one must admit that in photometry the third significant figure is of very dubious value:

	BOUGIE DÉCI- MALE	CARCEL.	HEFNER UNIT.	GERMAN CANDLE.	ENGLISH CANDLE.
Bougie décimale .....	1.	0.104	1.13	0.955	0.97
Carcel.....	9.6	1.	10.9	0.20	0.6
Hefner unit .....	0.885	0.92	1.	0.815	0.91
German candle.....	1.05	0.109	1.23	1.	1.092
English candle.....	1.03	0.104	1.00	0.915	1.

There are here some evident discrepancies which serve to mark the unsatisfactory state of the art, and to measure the uncertainties which exist.

Given a standard, such as it may be, the process of comparing a given radiant with it is extremely simple in principle and somewhat troublesome and unsatisfactory in practice. The difficulties come in part from the inherent difficulties of the process in general, and in part from the complications introduced by variations in the color of the light.

The Bunsen screen, which in ordinary practice is the backbone of photometry, has already been in some measure described, together with one of its simplest applications. The general principle is that a translucent spot in a nearly opaque screen of light texture disappears when equally illuminated from each side.

But for this to happen requires that the screen be entirely symmetrical. Light falling upon it must be transmitted through and reflected from the surface of the



grease-spot in precisely equal measure irrespective of the side of the spot on which the light falls. If not, when viewed obliquely from one side the spot will seem to disappear at a particular point, but when viewed from the other side this point will be shifted. Moreover, unless the screen be viewed from the same angle on each side, it will not balance at the same point, even if the spot be

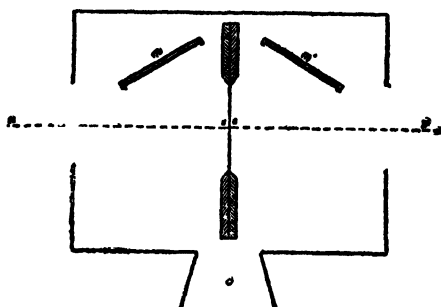

Fig. 121.—Bunsen Photometer Screen.

absolutely symmetrical as regards its two faces. If this condition is fulfilled, one side of the spot will generally accumulate dust a trifle more freely than the other, and throw things out of balance again.

To eliminate as far as possible such difficulties, it is usual to arrange the Bunsen screen so that both sides can be observed simultaneously, and from the same angle. To this end the apparatus is arranged as in Fig. 121. The screen marked *sc* in the cut is placed in a blackened box having openings in the ends along the line *xy* between the lights to be compared, and a lateral opening *o*, in which the edge of the screen is central. Two ordinary pieces of mirror, cut side by side from the same glass, are set vertically in the screen box in the positions *mm'*, as

shown. To the observer looking fairly into *o* the reflected images of the two sides of the screen then appear side by side, and the slightest change in the appearance of either may be at once noted. Sometimes the mirrors are fitted to slide out so that they may be interchanged and another reading taken, and sometimes the sight box itself is arranged to revolve 180 degrees about a horizontal axis in the plane of the screen. The interior of the box must be blackened with extreme care to avoid diffused light.

In observing with this sight box one soon falls into a very uniform habit of setting the screen by reference to

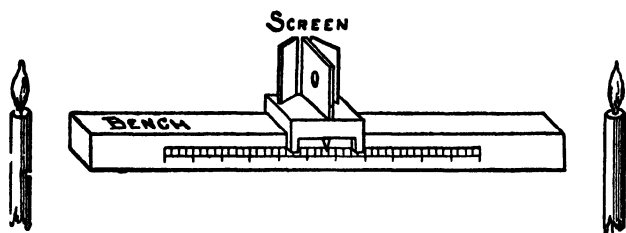

Fig. 122.—Bunsen Photometer.

both its sides, and can take wonderfully concordant readings. But vision differs in different persons, and the "personal equation" in photometric work is of considerable importance.

Aside from the sight box, the essential parts of a photometer are a long, graduated bar along which the sight box can be slid, suitable supports for the lights to be compared, so that they may always be in their proper relation to the graduated bar, and the screens already referred to for cutting off stray light. The elementary arrangement of a Bunsen photometer, except for the screens, is very well shown by Fig. 122. The two lights are sup-

ported at known equal distances from the ends of the graduation, and the sight box is then slid along the bench until the grease spot shows a balance between the illumination from the two sides. Then the intensities of the two lights are inversely as the squares of their respective distances from the grease spot.

This relation assumes that the lights illuminate their respective sides of the Bunsen screen strictly according to the law of inverse squares, uncomplicated by any sensible regular or diffused reflection. Right here is where the trouble begins. No one who has not tried it realizes the difficulty of eliminating reflection. There must be no reflecting surfaces about the photometer, and it must be in a darkened room with non-reflecting walls, as far as it is possible to obtain them. Several coats of dead black paint prepared from lampblack with just enough thin shellac to serve as a medium answers the purpose fairly well. The photometer bench should allow not less than six feet between the lights, and better eight or ten. A room about twelve feet by six feet is a convenient size for photometric work, and the higher the better, as a low room is apt to become unpleasantly hot after working in it awhile. The bench should run along one side, and all the apparatus should be stowed on a shelf under it within easy reach of the hand, for the room should be kept as dark as possible to avoid loss of sensitiveness in the eye.

A couple of small heavily shaded incandescent lamps, with switches in easy reach, form a convenient means for securing what little light is needed, and it is convenient also to have a tiny miniature lamp, with a ground bulb and an opaque screen to keep the light from the observer, carried on the sight box just above the pointer. This lamp should be furnished with a mere contact key on the

carriage of the sight box, so that it can be momentarily lighted to read the graduated scale.

For very precise work the Lummer-Brodhun photometric screen is sometimes used. This need not be described here, further than to say that it is a somewhat complicated but beautifully effective device, rather costly, and not as widely used in this country as the simpler Bunsen screen. Opinions differ widely as to the real relative merits of these two devices. In the writer's judgment the Lummer-Brodhun screen, when carefully used for the comparison of lights not differing greatly in intensity or color, permits a somewhat closer balance than the Bunsen screen, but under ordinary conditions the latter is nearly or quite as effective, and much easier to use.

The general structure of the photometric apparatus should be rigid and substantial. All the working parts should move easily and smoothly, and all the accessories should be as conveniently placed as possible, so as not to distract the attention of the observer from the work in hand.

Attempts are sometimes made to reduce the photometer to a compact, portable form, that can be easily set up for testing in any convenient location. As a rule, such portable photometers are rather unreliable. It is hard enough to do precise photometric work under the most favorable conditions, and in portable apparatus the tendency is to sacrifice too much to compactness. For certain classes of work in which high precision is not necessary, the portable photometers are convenient, but they are not to be advised for general purposes.

Many commercial photometers, both permanent and portable, are provided with scales so graduated as to read candle-power directly, assuming a certain fixed distance

between the lights under comparison and a fixed intensity of the standard. It is, of course, much easier to make photometric tests rapidly with such a scale, but it should be used with extreme caution, and as an auxiliary. When once correctly adjusted it is most convenient, but it should be assumed to be mal-adjusted at the start, and its correctness carefully verified before it is regularly used, and it should be subsequently checked at frequent intervals. The same precaution should be taken with any other apparatus graduated for convenience in arbitrary units.

The holders for the lights to be compared should be easily adjustable, so as to enable the operator to bring the luminous areas into exactly the right position with respect to the graduated scale. When incandescent lamps are under test it is convenient to mount the lamp to be tested upon a rotating spindle, so that by revolving it at the rate of three or four turns a second the mean horizontal candle-power may be obtained at a single reading. Other sources of light are generally also measured horizontally, but in a single conventional azimuth, and it is a question whether in the long run it is not better to measure incandescent lamps in a similar fashion. If any mean value of the luminous energy is to be considered important, it is the mean spherical rather than the mean horizontal, and it has already been explained how by changing the shape of the lamp filament the distribution may be widely altered without being changed in amount, so that spherical candle-power is really the significant thing.

Rotators for incandescent lamps are, however, convenient, and particularly so if arranged so as to allow the axis of rotation to be tilted at any required angle. But they require watching, if accurate work is desired, since

it is very difficult to avoid small and variable losses in voltage at the lamp due to varying resistance at the brushes which convey the current from the fixed to the rotating part of the device. Mercury-cup contacts are somewhat more reliable, but do not lend themselves readily to tilting the axis of rotation.

Fig. 123 shows an excellent typical form of photometer intended primarily for testing incandescent lamps, but readily adaptable to more general purposes. It consists

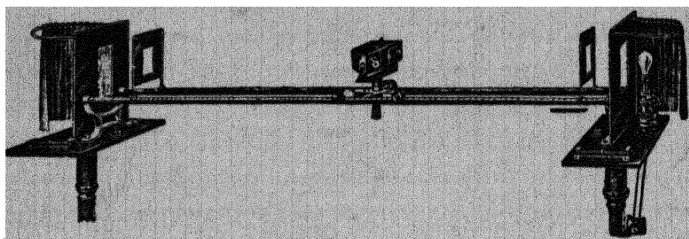

Fig. 123.—Photometer Bar Complete.

of a pair of little standards supported by cast iron columns, and supporting in turn the lights and their accessories and the pair of steel shafts extending between them and bearing the photometer carriage. The forward bar carries the graduation. On the left is the carriage for the standard lamp, screened in front and curtained behind, and on the right is the rotator, similarly screened, for the lamp to be tested. A pair of sliding screens help to cut off extraneous light from the sight box, and each lamp is provided with a rheostat for the exact adjustment of its voltage, and with the necessary electrical connections.

In setting up such a photometer, even in a room painted dead black, the screens supplied should be supplemented by other and larger ones placed nearer the sight box to cut off indirect illumination. It would also be advisable to

place a long shelf from standard to standard under the photometer bar. This should be painted dead black, and used to carry instruments and accessories ready to the observer's hand. In this instance the distance between lights is made either two or three meters, the longer bar being preferable for measurements of precision.

The sight box is mounted on trunnions, so as to be reversible as a whole with respect to the ends of the bar. In thus reversing, the errors due to difference in the reflecting mirrors or in the sides of the Bunsen screen proper, as well as the personal errors between the observer's two eyes, are eliminated from the result. There is, however, a personal error as between different observers that it not easy to be rid of. The idiosyncrasies of the eye in photometric work almost pass understanding. Two observers setting the Bunsen screen alternately on the same lights in quick succession will not infrequently obtain results differing by nearly 10 per cent., each man's readings, however, being closely consistent. The same observer will, as a rule, get consistent results from day to day, but has his own habit of seeing the spot on the screen disappear. Such individual differences are particularly marked when comparing lights differing in color.

In comparing, however, lights of approximately the same intensity and color, as in testing incandescent lamps, there is a convenient way of avoiding most of the errors in photometry, which can hardly be too strongly commended. It is one of the general processes of physical investigation, known as the "method of substitution." It consists of comparing the standard, which we will call *A*, with an intermediary standard *B*, and then, leaving everything else unchanged, replacing *A* by the object to be tested, *C*.

In applying this method to photometry proceed as follows: Place the standard lamp on the rotator of Fig. 123, and the intermediary standard in the socket at the other end of the photometer bar, setting the sight box at the midway point. Then vary the intermediary, either by turning it slightly or by shifting the rheostat belonging to it, until an accurate balance is obtained. Then any lamp of equal intensity with the standard on the rotator may replace it without changing the balance. This eliminates all the errors of comparison save two: first, that due to possible variation of resistance in the rotator, and, second, that due to a possible variation in the observer's habit of seeing during the progress of subsequent observations.

Most standard lamps are intended to be used in a fixed azimuth, and not in rotation, so that the former error may enter unless the rotator is in first-class order. The existence of this error is a strong argument in favor of measuring lamps in one or more fixed azimuths.

As to the second error, it is seldom of much moment in the case of a practiced observer, but may be detected and approximately evaluated by repeating at the close of the observations the original observation with the fundamental standard, setting in this case the sight box without varying either lamp. If the observer has been uniform in his habit of setting, and the resistance in the rotator has not varied materially, the sight box will give balance at the same point as before.

The possible residual error is that due to the varying resistance of the rotator when at rest from its resistance when in motion. This error may be detected, if it exists, by measuring the mean horizontal candle-power of a lamp having quite uniform horizontal distribution, first, by



rotating, and, second, by averaging the readings taken, say, in six azimuths 60 degrees apart. If the rotator has introduced no error, the two values thus obtained should check each other within the ordinary error of observation.

In incandescent lamp testing there are two general ways of arranging the connections. In the first, called the two-circuit method, the working standard is placed on an independent source of energy, generally a storage battery, brought to its proper voltage by means of a rheostat in circuit with it and a voltmeter, and kept constant during the observations by occasional adjustment of the rheostat, if necessary. The lamps being tested are similarly treated. When a storage battery is available, the method

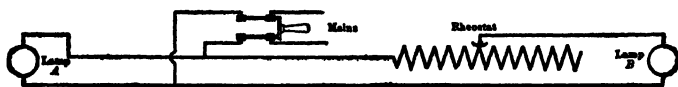

Fig. 124.—Photometer Circuits.

is a very satisfactory one, the only errors involved being those in the voltmeters, which need to be frequently compared, and very carefully read.

The second or single-circuit method is shown in diagram in Fig. 124. Here the two lamps to be compared are put in multiple off the same set of mains worked at the usual voltage. The standard, *B*, is brought to its proper voltage by means of the rheostat and a voltmeter, and afterwards the voltages at the two lamps vary together, if at all. This method of connection is very much more convenient than the two-circuit method, especially in alternating-current stations. It is, moreover, sufficiently precise if carefully applied. A second rheostat is employed for lamp *A*, if the voltage of the supply circuit varies from the rated voltage of *A*.

The essential difference between the two methods is that in the two-circuit scheme each lamp is tested rigorously at its rated voltage, while in the single-circuit method the two lamps are tested either at their rated voltages or at voltages equally at variance from these ratings. In the latter case there is a chance for error, unless equal increments of voltage correspond to equal increments of in-

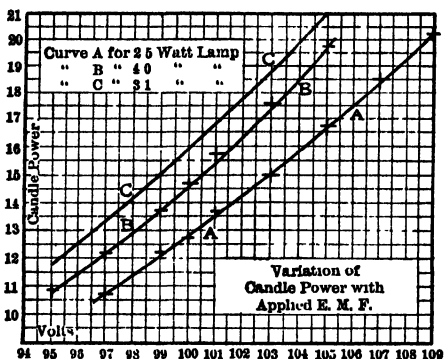

Fig. 125 —Variation of Light with Voltage.

tensity. In other words, if *A* and *B* are once balanced, will variation in the voltage of supply destroy that balance?

In general terms, two incandescent lamps of the same candle-power at some particular voltage will not remain equal if the voltage be changed. On the other hand, for small variations of voltage the difference will generally be so small as to be within the ordinary errors of observation, and, in fact, practically negligible. Fig. 125 shows the curves of variation of candle-power with voltage, in three typical lamps of differing efficiencies. All three show an approximation to the common rough-and-ready rule of a variation of one candle-power per volt. Of course,

the slope of the curves is the important consideration, and this generally decreases slightly with the efficiency of the lamp.

A brief examination discloses the relations between the curves. Suppose the working standard to be a lamp of moderate efficiency, say, 4 watts per candle, as shown in Curve B. Assuming the working voltage as 100, a rise of one volt or a fall of one volt increases or diminishes the light by, as nearly as possible, .85 candle-power. If the lamp under comparison corresponds to Curve A, the increment or decrement is not far from .75 candle-power per volt, while with the lamp of Curve C the change is a little over .9 candle-power per volt. These three lamps represent about as large differences as will generally be found, and it is therefore safe to say that for variations of less than one volt on either side of the normal the differences in candle-power as between the lamps tested will be less than 0.1 candle-power, and for practical commercial testing may generally be neglected. But a difference of four or five volts would obviously lead to variations of a considerable fraction of a candle-power, which would evidently be quite inadmissible.

The single-circuit method then must be used with caution, but when so used is generally quite as good as the two-circuit method, unless the latter be applied with extraordinary care. It should be remembered that unless the voltmeters employed have very open scales, the ordinary errors in reading them involve errors in candle-power quite as great as those between two lamps on the same circuit under a slightly shifting voltage.

Of the two methods the writer, on the whole, prefers the single circuit one for ordinary use. It is usually easy to find a time for testing when the variations in voltage

are small and slow enough to be easily reduced by a little attention to the rheostat.

It is not advisable in commercial testing to attempt the comparison of incandescent lamps with standards of another character. Such comparisons depend for their correctness on a knowledge of the absolute value of the voltage—a knowledge seldom very precise. They also introduce the factor of color difference, which is enormously troublesome, even with trained observers and the full resources of a well-equipped laboratory.

When the lights compared by means of a Bunsen or Lummer-Brodhun screen differ considerably in color, absolute balance is attainable at no one point on the scale. The same observer will obtain very regular apparent values for the comparison, but another observer is likely to obtain a somewhat different set of values. Such personal differences may easily amount to 5 per cent. or more, in comparing, for instance, a Welsbach with a Hefner lamp, or an incandescent lamp with an enclosed arc.

There will also be considerable differences in the results with a single observer if the absolute brightness of the colored radiants changes, even when the relative brightness remains the same. That is, if one were comparing a Welsbach and a Hefner lamp, and obtained what appeared to be a satisfactory balance, that balance would be destroyed by doubling the distance of each light from the screen.

These color difficulties are physiological and subjective. They depend upon a property of vision sometimes known as Purkinje's law, stated by Von Helmholtz as follows: "Intensity of sensation is a function of the luminous intensity which differs with the kind of light."

This difficulty in color photometry is precisely akin to

that involved in comparing the loudness of two noises of differing quality, although fortunately somewhat less serious. For example, one would have extreme difficulty in forming any notion of the relative loudness of a bugle note and a pistol shot, or a shout and a steam whistle. One's first instinctive effort at comparison would probably be made by investigating the distance at which each sound became inaudible, or barely audible.

A similar procedure based on visual acuteness has often been tried in rough color photometry. In its crudest form it consists of noting the distance from each radiant at which a printed page held at arm's-length just becomes legible. A very little experience will convince the experimenter that the results depend upon the general state of the eye, the personal equation of the observer, practice, preconceived notions of the relative intensities, and other factors so variable that the result is little better than guesswork. Yet this wildly inaccurate method has not infrequently been used in estimates of street lighting.

With proper apparatus and a careful and unprejudiced observer, however, the principle involved is capable of giving useful approximate determinations of illumination. An instrument for this purpose which has become fairly well known in this country is Houston and Kennelly's illuminometer, shown in section in Fig. 126. In the cut,  $X$ ,  $X$  is a small box thoroughly blackened on the inside and provided with an eye tube  $T$ ,  $T$ , pointing directly at a removable inclined block  $B$ , on the face of which is placed a group of printed test characters. A focusing eye-piece  $E$  enables any observer to see the test object distinctly. In the top of the box is a window  $W$ , closed by a translucent diaphragm of porcelain, opal glass, or the like, which serves to illuminate the test object. This window can be

closed by an opaque shutter *S*, moved by a rack and pinion, the latter turned by a milled head outside the box.

The instrument is used by facing the window toward the source of illumination, and opening or closing the shutter until the test characters are just legible. A scale attached to the shutter then gives the illumination directly in *bougie-metres*.

The scale is calibrated empirically by testing with a source of light of known intensity at definite distances.

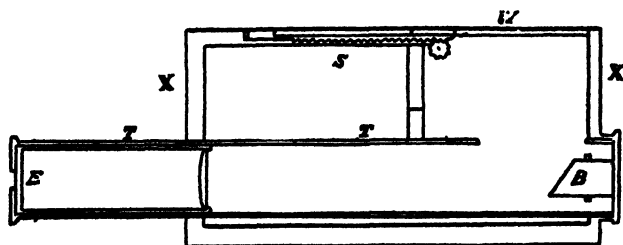

Fig. 127.—Illuminometer.

The instrument is small enough for the pocket, and is very convenient for relative measurements. So far as absolute values of the illumination are concerned, it can hardly be considered seriously, unless in experienced hands, and calibrated by the user; but in comparative measurements the average error of a single careful reading is less than 10 per cent., which is a great improvement on guesswork. A skillful observer by frequently checking the calibration of his instrument could bring the absolute errors somewhere nearly down to this figure. The question of color is partially eliminated by the great reduction in intensity of the light. As has been noted in a previous chapter, color differences are inconspicuous in very faint light.

To return to photometry proper, this same expedient of reducing the intensity of the light that reaches the eye from the photometer screen is of material assistance in comparing colored lights. Observing the screen with nearly closed eyes makes comparisons very much easier, and leads to fairly consistent results. But color perception changes so notably in dim illumination that results so obtained do not represent working conditions nearly enough to justify making any pretense of precision.

Numerous expedients to avoid these difficulties have been devised, all amounting in the last resort to the selection of conventional conditions, representing the practical requirements of illumination. None of them are perfectly satisfactory under all conditions, but probably the best available method is Crova's. This is based on the experimental fact that in comparing two lights, even of very different color, their total intensities are sensibly proportional to their relative intensities in the region of the spectrum of wave length, about  $0.582 \mu$ , that is, in the clear yellow of the spectrum.

The troublesome part of such a comparison is to segregate the rays of about this wave length without resorting to spectro-photometry, which necessitates the formation of two spectra from the two sources side by side. Crova found that a solution of 22.3 grams anhydrous perchloride of iron and 27.2 grams chloride of nickel in 100 cubic centimeters of distilled water forms an absorbing screen that serves the purpose. The former constituent cuts out the green and blue, the latter the red. A layer of this standard solution 7 millimeters thick, used as a screen through which to observe the photometer screen, serves the purpose, although a thicker layer limits the desired region more closely.

The objection to the method is principally the large amount of light cut off by the screen, so that it works best in comparing rather powerful lights.

As a matter of general practice such refinements are seldom used. Excepting arc lamps, the ordinary sources of light can be compared without serious difficulty from differences of color. With flame radiants a well standardized Methven screen forms by far the best working standard, while in comparing incandescent lamps the working standard should be an incandescent of moderate efficiency.

In comparing arc lamps serious trouble is encountered. In the first place, the difference between the intensity of an arc and any feasible standard is inconveniently great, and in the second place the colors are widely different, especially in dealing with enclosed arcs. The first difficulty may be averted by using the arc at a sufficient distance from the screen to give a proper working distance, say, three or four feet, between the screen and the standard. In the tests by the committee of the National Electric Light Association already quoted, the color trouble was dealt with by observing the screen through a rapidly rotating disk having narrow radial slits. This in effect cut down the brilliancy of the screen to a point where color perception was considerably weakened. It is rather doubtful whether this procedure affected the standard and the arc in equal ratios.

In arc photometry still another troublesome factor is met, in the tendency of the arc to wander from side to side of the carbon, or to slowly rotate, so that the real luminous intensity is very difficult to catch. In the research just mentioned this was escaped by using a pair of mirrors simultaneously reflecting light from two sides of



the arc lamp, diametrically opposite, upon the photometer screen, the direct radiation being screened off. The line joining these mirrors was, of course, perpendicular to the line of the photometer bar, and the absorption of the mirror surfaces could readily be allowed for.

There is at present no conventional method of comparing the brilliancy of different sources of light. Flames are universally rated by their intensity as measured in a horizontal plane, in a direction generally 45 degrees from the plane of the flame, if the flame is flat, or irrespective of direction in Argand and other symmetrical round burners, including mantle burners.

In the early days of electric lighting the photometric question assumed some importance, and all sorts of wild statements were afloat as to the power of the new illuminant. Arc lamps were apparently rated at their momentary maximum intensity on the most favorable direction. The rivalry between makers of arc lamps did not tend to depreciation of their intensity, and so it came about that an open arc taking about 450 watts was rated at 2000 candle-power, while a similar arc of about 325 watts was rated at 1200 candle-power.

While it is possible that some experimenter at an especially favorable moment may have obtained these intensities in a single direction, it is certain that the ratings were very soon regarded as merely conventional. They have long since been relegated to the category of merely commercial designations, the rating bearing no more precise relation to the thing than does the term "best," as applied to flour or other commodities.

When an individual or a municipality contracts for a 2000-cp arc light, the thing bought, received, and paid for is an arc light taking about 450 watts of electrical

energy, and such is the general understanding of the term as interpreted at various times by the courts. There is not, nor has there ever been, in commercial use in this country or elsewhere an arc lighting system using lamps actually giving anywhere near 2000 candle-power, either as maximum zonal intensity or as mean spherical intensity. The former requirement would demand about 750 watts at the arc, the latter nearly 1200. Lamps of such power have only been used for searchlights and similar purposes, and are far too powerful to be advantageously used for ordinary illumination.

In incandescent lighting the ratings are intended to express the real candle-power of the lamps. Sixteen candle-power is a figure borrowed from the legal requirements for gas, and corresponded originally to a measurement corresponding to that applied to gas flames, *i. e.*, in a horizontal plane 45 degrees from the plane of the curve formed by the filament.

With the introduction of looped and spiraled filaments giving a better distribution of light than the simple U-shaped filament, demand arose for a method of measurement which would credit these lamps with their just due. Hence arose the measurement of mean horizontal candle-power by rotating the lamp. This credits the lamp with its just horizontal candle-power as against a lamp giving 16 candle-power only in certain horizontal direction, but it fails to give credit for gains in spherical distribution, and puts a premium on lamps with long U-filaments adapted to throw out a large proportion of horizontal illumination.

Mean spherical candle-power, *i. e.*, total luminous flux, is unquestionably the fairest basis of comparison between various sources of light, but it is somewhat troublesome

to measure, and runs counter to long established custom and legal requirements as to gas lighting. It is certainly desirable that a uniform method should be established for all radiants, and this is no easy matter. There is a strong tendency to apply the mean spherical measurements to arc lamps, although the lower hemispherical candle-power is sometimes used instead, on the ground that downward light is the proper criterion of useful illumination. This rating is approximately true of lamps having reflectors over them, but it is certainly not true in general, for it neglects the very great effectiveness of diffuse reflection from walls and ceiling.

The fact is that no simple rating can be applied with equal fairness to all commercial sources of light, by reason of their very great diversity in the nature of the light-distribution.

The mean spherical measurement comes nearer to general fairness than any other, and could it be universally adopted it would afford a very satisfactory basis of comparison. As a practical standard at the present time, it leaves considerable to be desired.

Mean horizontal candle-power is by far the easiest thing to measure, and it is to be recommended, save in the comparison of radiants deliberately planned, as in case of intensive gas burners, the American type of Nernst lamp, and certain arcs and incandescents, to give particularly strong illumination in some other direction.

The thing most to be desired in practical photometric work is a general international convention defining empirically, if need be, certain bases of work. A working reproducible standard of greater intensity and better color than the Carcel or Hefner lamp is badly needed. As actual standards for use on the photometer bar, nothing

can be better than incandescent lamps, but as has already been noted, they are not reproducible. The nearest approach to a reproducible standard of good size and color at present available seems to be the Vernon-Harcourt 10-cp pentane lamp, which is the present official standard in London. It has not been subjected to as searching and protracted an investigation as the Hefner lamp, but the reports so far obtained from it are highly encouraging, while its intensity and color are great advantages in passing from it to the more powerful modern radiants.

Granted a proper standard, there is also needed a definite conventional method of dealing with the color difficulty. This involves a tougher problem even than the standard itself. Possibly Crova's method, or some modification of it, might be made to serve a useful purpose. Finally, aside from the difficulty of comparing lights differing widely in color, there remains the question of the different illuminative values of such lights when put into practical service. This again suggests the question of measuring illumination, instead of the intensity of the radiants, but as has already been indicated there are no methods of measuring illumination comparable in precision with ordinary photometry, which is saying little enough.

It is to be hoped that the recently organized Bureau of Standards may facilitate the study of these puzzling matters, and promote an international photometric congress that can give general sanction to a definite programme in commercial photometry.

A great deal of time and effort has been wasted in this world in the promulgation of so-called "absolute" standards, referred in a perfectly definite way to immutable constants of nature. Desirable as they are, it is of far

greater importance to have a convenient, reproducible, and international set of units in universal use. The metric system started on its career as an absolute system, but its value lies not in the supposed relation of its units to natural constants, but in their relation to each other, and in its well-nigh universal acceptance as the basis of scientific measurements of length and mass.

Standards as concrete things may be constantly susceptible of improvement without limit. They are important practically only in proportion to their general recognition at a certain conventional determinable value.



## INDEX.

Absorption, selective, 28  
Acetylene, 75  
——, burners for, 79  
——, generators for, 80  
——, dangers of, 77  
——, preparation of, 76  
——, value of, 81  
After-images, 10  
Air-gas 66  
——, cost of, 67  
——, machines, 66  
Architectural illumination, 283  
—— illumination, fundamental principles of, 284  
Arc, best length of, 143  
——, relation between length of, and voltage, 143  
——, relation between current density and light in, 142  
——, relation between current and efficiency in, 160  
Arcs, actual intensities of, 248  
——, alternating and direct current comparison of, 158  
——, alternating, best frequency for, 157  
——, alternating, distribution of light from, 156  
——, alternating, advantages of, 155  
——, alternating, annual saving from, 260  
——, alternating current, 154  
——, alternating current series, 259  
——, enclosed, 144  
——, low voltage, 144  
——, classification of, 248  
——, computing illumination from, 251  
——, distribution curves from various, 249  
——, distribution of light from, 148  
——, enclosed, amperage of, 150

Arcs, enclosed, distribution of light from, 150  
——, enclosed, characteristics of, 147  
——, enclosed, consumption of carbon in, 145  
——, enclosed, voltage in, 146  
——, illumination curves from, 255  
——, for lighting large rooms, 217  
——, alternating, objections to, 155  
——, rating of, 335  
——, result of distribution from, 248

*Bougie décimale*, 317

Bougie-meter, 5

Bracket fixtures, 271

Bulbs, exhaustion of, 100

——, Malignani process for exhausting, 100

Bunsen screen, construction of, 318

Burner, Argand, 71

——, bat's-wing, 71

——, fishtail, 71

——, oxy-hydrogen, 83

——, Siemens, 74

——, Welsbach, 85

——, Welsbach, form of, 86

——, Wenham, 73

Burners, regenerative, 73

Burning fluids, 59

Calcic carbide, 76

—— carbide, cost of, 81

Candle-foot, 5

Candle power, mean spherical, 105

——, standard, 314

Candles, 62

——, efficiency of, 62

Carcel lamp, 314

- Ceiling lighting, advantage of, 232  
 — lights in halls, 216  
 — lights, practical effect of, 196  
 Churches, amount of light for, 225  
 —, choice of lights for, 224  
 —, illumination of, 224  
 Coal gas, 68  
 — gas, composition of, 68  
 — gas, impurities in, 69  
 Color, effects of dilution on, 44  
 —, fundamental law of, 23  
 —, in illumination, 23  
 —, of walls in illumination, 55  
 Color-blindness, effect of, 30  
 Color-photometry, 330  
 — Crova's method of, 333  
 Colors, changeable, 26  
 —, from pigments, 25  
 —, in very dim light, 29  
 —, luminosity of, 32  
 —, matching, 29  
 Colored illumination, limitations of, 289  
 — light on fabrics, 34  
 — light, effect of, 33  
 Common illuminants, cost of, 94  
 — illuminants, properties of, 93  
 Crater, temperature of, 142  
 Cross-suspensions, 273  
 Danger from light oils, 92  
 Daylight, intensity of, 21  
 Decorative lighting of large buildings, 280  
 — lighting, temporary, 289  
 — lighting, miniature lamps for, 291  
 Diffuse lighting, development of, 309  
 — lighting, objections to, 310  
 Diffusion, difficulty of checking, 54  
 —, help received from, 188  
 —, in large rooms, 211  
 —, relation of, to quantity of light, 189  
 Display and scenic illumination, 275  
 Domestic lighting, illuminants for, 183  
 — lighting, importance of low intrinsic brilliancy in, 184  
 — illumination, 8 c. p. lamps in, 210  
 — illumination, mantle burners in, 210  
 — lighting, quantity of light for, 190  
 Draughting rooms, inverted arcs in, 236  
 — rooms, light required in, 235  
 Electric arc, 140  
 — arc, crater of, 141  
 Enclosed arcs, annual saving from, 259  
 — arcs, illumination from, 258  
 Exposition buildings, illumination of, 242  
 — lighting, principles of, 285  
 Eye, properties of, 2  
 Factories, illumination required for, 240  
 Fats, 58  
 Fechner's law, 4  
 Filament of Auer von Welsbach, 124  
 Filaments of refractory material, 123  
 —, disintegration of, 110  
 —, flashing, 98  
 —, effect of flashing on, 99  
 —, manufacture of, 96  
 —, material of, 96  
 —, practical dimensions of, 114  
 —, section of, 101  
 —, shapes of, 101  
 — from soluble cellulose, 96  
 Firefly, efficiency of light of, 138  
 —, emission spectrum from, 137, 138  
 —, light of, 136



- Fire risks of illumination, 295  
 Flames, luminous, 56  
 Fraunhofer lines, 24  
 Gas-burners, 71  
 Hefner unit, 315  
 Holophane globes, 175  
   — globes, classes of, 177  
   — globes, distribution of light from, 180  
   — globes, structure of, 175  
   — globes, weak points of, 179  
 Illuminants, choice of, 193  
   —, colors of, 36  
   —, color properties of, 27  
   —, conception of efficiency in, 303  
   —, incandescent, 56  
   —, ultimate efficiency of, 304  
 Illumination, apparent, 12  
   —, common fault in, 296  
   —, computation of, for a room, 191  
   —, best direction of, 17  
   —, effect of direction in, 3  
   —, effective, 186  
   —, effect of height on, 223  
   —, formulæ for computing, 194  
   —, general, 2  
   —, of a hall, computing, 213  
   —, of very high rooms, 220  
   —, of a modern house, 202  
   —, predominant direction of, 217  
   —, needed improvements in, 304  
   —, over-brilliant, 301  
   —, relation of, to yellow component, 33  
   —, scenic, 1  
   —, standards of, 5  
   —, necessary strength of, 18  
 Illuminometer, 311  
 Interior illumination, limitations imposed upon, 195  
 Incandescent lamps, rotators for, 323  
   — lamps, value of, 103  
 Incandescent electric light, 95  
 Incandescents, color of light in, 113  
   —, actual cost of, 117  
   —, effect of temperature on life of, 116  
   —, high efficiency, 110  
   —, importance of sorting, 120  
   —, intrinsic brilliancy of, 111  
   —, illumination curves from, 262  
   —, light-curves from, 104  
   —, life of, 115, 116, 117  
   —, life of, in candle-hours, 118  
   —, low efficiency, 113  
   —, nominal candle-power of, 104  
   —, position of axis in, 108  
   —, rated efficiency of, 109  
   —, real efficiency of, 122  
   —, rating of, 336  
   —, rating, 107  
   —, relation between intensity and energy in, 112  
   —, relation of light and voltage in, 111  
   —, relation of temperature and efficiency in, 109, 111, 112  
   —, need of good regulation for, 119  
   —, standard sizes of, 113  
   —, total light from, 104  
   —, value of, 118, 119, 120  
   —, variation of light, with voltage in, 328  
 Inertia, visual, 13  
 Intrinsic brilliancy permissible, 307  
   — brightness, 8  
   — brightness, table of, 9  
 Inverse squares, law of, 6  
 Inverted arcs, unilateral lighting by, 239  
 Iris, action of, 11  
 Kerosene, 61  
 Lamp, arc, fluctuations of, 14  
   —, incandescent electric, 13

- Lamp, incandescent flickering of, 13  
 ———, Nernst, 124  
 ———, Nernst, advantage of, on high voltage, 133  
 ———, Nernst, American form of, 129  
 ———, Nernst, arrangement of, 126  
 ———, Nernst, ballast resistance in, 127  
 ———, Nernst, on continuous current, 132  
 ———, Nernst, intrinsic brilliancy of, 131  
 ———, Nernst, life of, 129, 131  
 ———, Nernst, light-curve from, 133  
 ———, Nernst, tests of, 130  
 ———, Nernst, variation of resistance in, 124  
 ———, "Rochester," 63  
 ———, vacuum tube, 134  
 ———, vacuum tube, color of light from, 135  
 ———, vacuum tube, difficulties with, 134  
 Lamps and candles, function of, 194  
 ———, incandescent, of large power, 233  
 ———, kerosene, 63  
 ———, oil, 63  
 ———, Roman, 57  
 ———, silvered bulb, 171  
 Light, artificial, sources of, 57  
 ———, diffused, value of, 187  
 Lights, importance of steadiness in, 241  
 Lighting, criterion of effective, 306  
 "Lucigen" torch, 64  
 Lummer-Brodhun screen, 322  
 Lux, 5  
 Mantle burners, 86  
 ——— burners for air-gas, 91  
 ——— burners, color of light of, 89  
 ——— burners, efficiency of, 88  
 ——— burners, life of, 89  
 Mantles, composition of, 85  
 Mast-arms, 271  
 Mean spherical candle power as a basis of rating, 336  
 Methven screen, 317  
 Miniature lamps, objections to, 292  
 Monuments, illuminating, 281  
 Moonlight schedule, 265  
 Municipal lighting, 268  
 Nernst filament, efficiency of, 129  
 Oils, combustion of, 63  
 Paraffin, 61  
 Petroleum, 60  
 ———, composition of, 60  
 ——— products, 61  
 Phosphorescence, possible value of, 305  
 Photometer bench, 321  
 ———, Bunsen, 20, 320  
 ——— circuits, 327  
 ———, daylight, 19  
 ———, practical arrangement of, 324  
 Photometers, portable, 322  
 Photometry of arc lamps, 334  
 ———, "method of substitution" in, 325  
 Plane of illumination, 190  
 Pole-top fixtures, 270  
 Projectors, stage, 278  
 Public buildings, lighting, 227  
 ——— lights, relation of general illumination to, 264  
 ——— squares, lighting of, 264  
 Quantity of light required in large buildings, 212  
 Railway stations, lighting, 231  
 ——— stations, spacing of arcs in, 234  
 Rare earths, properties of, 86  
 Reflection, 38  
 ———, asymmetric, 42, 49  
 ———, asymmetric, in fabrics, 50  
 ———, coefficient of, 47  
 ———, diffuse, 39  
 ———, coefficients of diffuse, 53  
 ———, coefficients of regular,

- Reflection, selective, effect of,**  
 37  
 ———, total intensity of, 41  
 ———, losses in, 48  
 ———, multiple, 45  
 ———, diffuse, nature of, 40  
 ———, regular, 38  
 ———, selective, 43  
**Reflector lamps, 171**  
 ——— lamps, objections to, 173  
**Reflectors, 163**  
 ——— for inverted arcs, 236  
 ———, economy of, 198  
**Rooms, light required to illuminate, 199**
- Search light, 7**  
 ——— lights, 297  
 ——— lights, use of, 298  
**Selective coloration, effect of material on, 50**
- Shades, 163**  
 ———, light intercepted by, 166  
 ———, paper and fabric, 165  
 ———, reflecting, 167  
 ———, reflecting, tests of, 169  
 ———, requirements for, 165  
**Shadows, function of, 16**  
 "Shotgun diagram," 120  
 ——— diagram, interpretation of, 121  
**Single-circuit method, 327**
- Snow blindness, 3**  
**Spectra of colors, 25**  
**Spectrum, 24**  
**Standards, requirements for, 313**  
 ———, relation between primary, 318  
 ———, secondary, 316  
**Stearin, 59**
- Street lighting, 244**  
 ——— lighting, annual hours of, 265,  
 ——— lighting, contracts for, 269  
 ——— lighting, cost of, 267
- Street lighting, fixtures for, 270**  
 ——— lighting, incandescents in, 261  
 ——— lights, location of, 263  
 ——— light, spacing of various, 266  
**Streets, amount of light required for, 254**  
 ———, effective illumination in, 257  
 ———, computing illumination for, 244  
 ———, minimum illumination in, 247  
 ———, principles of lighting, 246
- Temporary lighting effects, 233**  
 ——— lighting, installation of, 293
- Theaters, ceiling lighting for, 231**  
 ———, actual floor space of, 229  
 ———, illumination of, 228  
 ———, light required in, 230  
 ———, location of lights in, 230  
 ———, stage lighting in, 276  
**Two-circuit method, 327**
- Vacuum tube, efficiency of, 135**
- Velvet, action of dyes in, 51**
- Vernon Harcourt pentane standard, 337**
- Violle's unit, 313**
- Visual usefulness, 306**
- Walls, diffusion from, 197**
- Water-gas, 69**  
 ———, composition of, 70  
 ———, danger from, 70
- Waxes, 58**
- White light, composition of, 24**
- Workshops, arc lights in, 218**  
 ———, light required in, 241  
 ———, mantle burners in, 219



