

Engineering
Library

UNIVERSITY OF CALIFORNIA
DEPARTMENT OF CIVIL ENGINEERING
BERKELEY, CALIFORNIA

UNIVERSITY OF CALIFORNIA
DEPARTMENT OF CIVIL ENGINEERING
BERKELEY, CALIFORNIA

0020
0021
0022
0023
0024
0025
0026
0027
0028
0029
0030
0031
0032
0033
0034
0035
0036
0037
0038
0039
0040
0041
0042
0043
0044
0045
0046
0047
0048
0049
0050
0051
0052
0053
0054
0055
0056
0057
0058
0059
0060
0061
0062
0063
0064
0065
0066
0067
0068
0069
0070
0071
0072
0073
0074
0075
0076
0077
0078
0079
0080
0081
0082
0083
0084
0085
0086
0087
0088
0089
0090
0091
0092
0093
0094
0095
0096
0097
0098
0099
0100

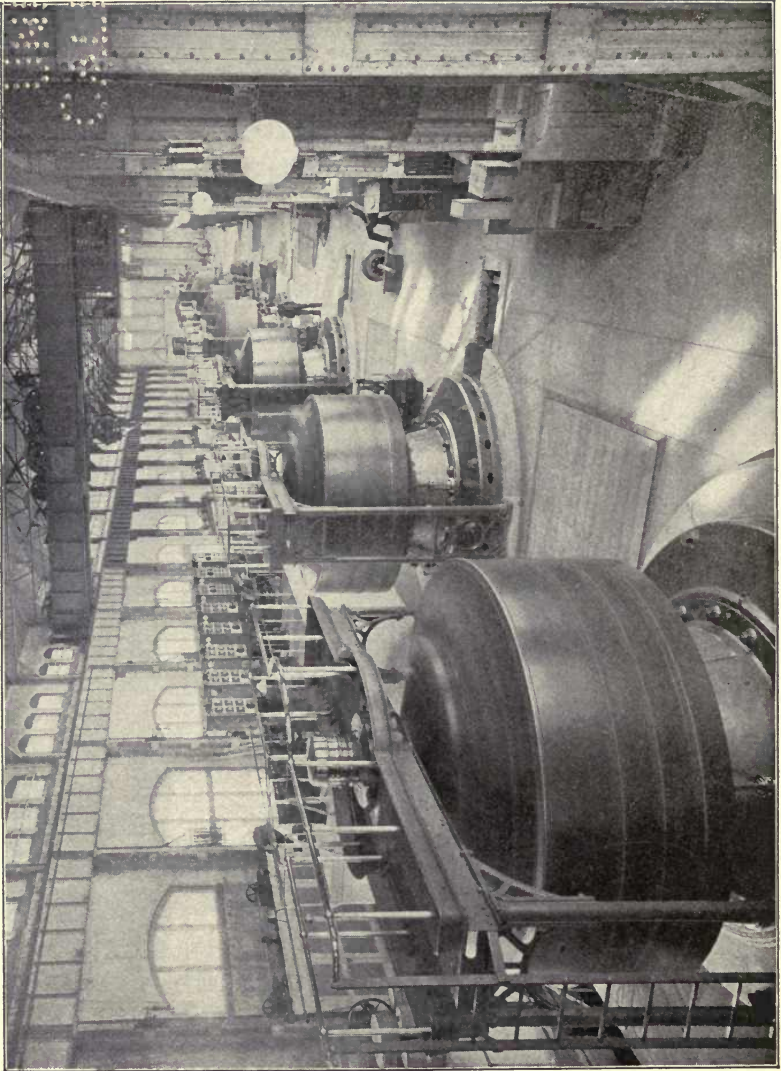

PLATE I.

ELECTRIC POWER TRANSMISSION

*A PRACTICAL TREATISE
FOR PRACTICAL MEN*

BY

LOUIS BELL, Ph. D.

MEMBER AMERICAN INSTITUTE OF ELECTRICAL ENGINEERS

*FIFTH EDITION
REVISED AND ENLARGED*

NEW YORK
McGRAW PUBLISHING CO.

1907

TK1007

B4
1907

Engineering
Library

TO THE
LIBRARY

Engineering
Library
COPYRIGHT, 1906, BY
MCGRAW PUBLISHING CO.
NEW YORK

PREFACE TO FIRST EDITION.

THIS volume is designed to set forth in the simplest possible manner, the fundamental facts concerning present practice in electrical power transmission.

Busy men have little time to spend in discussing theories of which the practical results are known, or in following the derivation of formulæ which no one disputes. The author has therefore endeavored, in introducing such theoretical considerations as are necessary, to explain them in the most direct way practicable; using proximate methods of proof when precise and general ones would lead to mathematical complications without altering the conclusion for the purpose in hand, and stating only the results of investigation when the processes are undesirably complicated.

In writing of a many-sided and rapidly changing art, it is impossible in a finite compass to cover all the phases of the subject or to prophesy the modifications that time will bring forth; hence, the epoch of this work is the present, and the point of view chosen is that of the man, engineer or not, who desires to know what can be accomplished by electrical power transmission, and by what processes the work is planned and carried out. This treatment is not without value to the student who wishes to couple his investigations of electrical theory with its application in the hands of engineers, and puts the facts regarding a very great and important development of applied electricity in the possession of the general reader.

Such apparatus as is described is intended to be typical of the methods used, rather than representative of any particular scheme of manufacture or fashion in design. These last change almost from month to month, while the general conditions remain fairly stable, and the underlying principles are of permanent value.

January, 1897.

PREFACE TO FIFTH EDITION.

THE art of electrical power transmission has changed but little in the past two years, since the fourth edition of this work went to press. There have been very many plants installed, few of them at all sensational in magnitude, voltage, or distance of transmission. The great bulk of such work is now rather commonplace. The upper limit of voltage has already risen to nearly 70,000 volts, and the next few years will assuredly see a very material increase over this figure. A few new pieces of apparatus have been recently brought into use, which have been noted in their appropriate places. Perhaps the most considerable impending changes are those in the resources of electric lighting which affect only those transmission systems which do their own distribution. These changes, however, bid fair to be on a very large scale and of very striking character within the next few years.

June, 1907.

CONTENTS.

CHAPTER.	PAGE.
I. ELEMENTARY PRINCIPLES	1
II. GENERAL CONDITIONS OF POWER TRANSMISSION	23
III. POWER TRANSMISSION BY CONTINUOUS CURRENTS	77
IV. SOME PROPERTIES OF ALTERNATING CIRCUITS	125
V. POWER TRANSMISSION BY ALTERNATING CURRENTS	158
VI. ALTERNATING CURRENT MOTORS	217
VII. CURRENT REORGANIZERS	280
VIII. ENGINES AND BOILERS	310
IX. WATER-WHEELS	349
X. HYDRAULIC DEVELOPMENT	387
XI. THE ORGANIZATION OF A POWER STATION	418
XII. AUXILIARY AND SWITCHBOARD APPARATUS	455
XIII. THE LINE	474
XIV. LINE CONSTRUCTION	536
XV. METHODS OF DISTRIBUTION	581
XVI. THE COMMERCIAL PROBLEM	639
XVII. THE MEASUREMENT OF ELECTRICAL ENERGY	660
XVIII. HIGH VOLTAGE TRANSMISSION	687

LIST OF TABLES.

	PAGE.
EFFICIENCY OF WIRE ROPE DRIVES	39
WIRE ROPES AND PULLEYS THEREFOR	42
LOSS OF HEAD IN HYDRAULIC PIPES	47
LOSS OF AIR PRESSURE IN PIPES	52
EFFICIENCIES OF ELECTRIC MOTORS	62
EFFICIENCIES OF ELECTRIC AND OTHER TRANSMISSIONS	74
PERFORMANCE OF SMALL POLYPHASE MOTORS	270
STEAM CONSUMPTION OF ENGINES	319
EVAPORATIVE POWER OF FUELS	329
EVAPORATIVE TESTS OF BOILERS	330
COAL CONSUMPTION OF ENGINES	332
TABLE FOR WEIRS	391
PROPERTIES OF STEEL HYDRAULIC PIPE	408
PROPERTIES OF COPPER AND OTHER WIRES	486
SIZE, RESISTANCE, AND WEIGHTS OF COPPER WIRES	509
NATURAL TANGENTS, SINES, AND COSINES	522
SIZE, WEIGHT, AND TENSILE STRENGTH OF LINE WIRES	539
SIZES AND WEIGHTS OF WOODEN POLES	551
TENSILE STRENGTH OF WOODS	554
PROPERTIES OF DIRECT AND ALTERNATING CURRENT ARCS	592
COST OF POWER WITH VARIOUS ENGINES	640
COST OF INTERMITTENT POWER WITH VARIOUS ENGINES	643
COST OF ELECTRIC MOTORS	644
TYPICAL LIST OF DISCOUNTS	657
LIST OF AMERICAN TRANSMISSION AT OR ABOVE 20,000 VOLTS	704

ELECTRIC TRANSMISSION OF POWER.

CHAPTER I.

ELEMENTARY PRINCIPLES.

IT has long been the fashion to speak of what we are pleased to call electricity as a mysterious "force," and to attribute to everything connected with it occult characteristics better suited to mediæval wizardry than to modern science. This unhappy condition of affairs has, in the main, come about through the indistinctness of some of our fundamental ideas and inexactitude in expressing them.

To speak specifically, there has been, even in the minds and writings of some who ought to know better, a tendency toward confusing the extremely hazy individuality of "electricity" with the sharply defined properties of electrical energy. We have been so overrun by theories of electricity, two-fluid, one-fluid, and non-fluid — by electrically "charged" atoms and duplex ethers, that we have well-nigh forgotten the very great uncertainty as to the concrete existence of electricity itself. Even admitting it to be an entity, it most assuredly is not a force, mysterious or otherwise. Electrical force there is, and electrical energy there is, and with them we can freely experiment, but for most practical purposes "electricity" is merely the numerical factor connecting the two. It is related to electrical energy much as that other hypothetical fluid "caloric" was supposed to be related to heat energy. The analogy is not absolutely exact, but it nevertheless summarizes the real facts in the case.

The day has passed wherein we were at liberty to think of "electricity" as flowing through a material tube or as plas-

tered upon bodies like a coat of paint. The things with which we have now to deal are the various factors of electrical energy.

It is the purpose of this chapter to treat of that form of energy which we denominate electrical, to discuss its relation to other forms of energy and some of the transformations which they may reciprocally undergo.

Speaking broadly, *energy* is power of doing work. The energy of a body at any moment represents its inherent capacity for doing work of some sort on other bodies. This, however, must not be understood as implying that the aforesaid energy is limited by our power of utilizing it. We may or may not be able to employ it to advantage or under possible conditions. As an example, take the massive weight of a pile driver. Raised to its full height it possesses a certain amount of gravitational energy — a possibility of doing useful work. This energy is temporarily unemployed and appears only as a stress on the supporting rope and frame-work. Under these circumstances, wherein the energy exists in static form, it is generally known as *potential* energy.

Now let the weight fall and with swiftly gathering velocity it strikes the pile and does work upon it, settling it deep into the mud. The energy due to the blow of the *moving weight*, energy of motion in other words, is called *kinetic*. But at the bottom of its fall the weight still has potential energy with reference to points below it, and we realize this as the pile settles lower and each successive blow becomes more forceful. At some point we are unable further to utilize the fall, and have then reached the limit of the *available* energy in this particular case.

We must not forget, however, that each time the weight was lifted, work had to be done against gravitation to give the weight its point of vantage with respect to available energy. This work was probably done by utilizing the energy of expanding steam — in other words, the energy of the steam was transformed through doing work on the piston into kinetic energy of the latter, which, through doing work against gravitation, has been enabled again to reappear as the energy of a falling body, and to do work on the driven pile. And back

of the steam energy is the heat energy, by which work is done on the water in the boiler, and yet back of this the chemical energy of the coal, transformed into heat energy and doing work on the minute particles of iron in the boiler, for we know that heat is a species of kinetic energy.

Even the work done on our pile is not permitted to go untransformed into energy. Part is transformed into heat energy through friction and compression of the pile, part through friction of the water, and part raises ripples that may lift against gravity chips and pebbles on a neighboring shore. Other fractions go into the vibrational energy of sound; into heating the weight so that it gives out warmth — radiant energy — to the hand when held near it and to the surrounding air; and into electrical work done on the weight and neighboring objects, for the weight unquestionably receives a minute amount of electrical energy at each blow. Thus, a comparatively simple mechanical process involves a long series of transformations of energy.

No energy is ever created or destroyed, it merely is changed in form to reappear elsewhere, and work done is the link between one form of energy and another. And we may lay down another law of almost as serious import: No form of energy is ever transformed completely into any other.

On the contrary, the general rule is that with each transformation several kinds of energy appear in varying amounts, and among them we may always reckon heat. The object of any transformation is usually a single form of energy, hence practically no such thing as perfectly efficient transformation can be obtained. The energy by-products for the most part cannot be utilized and are frittered away in useless work or in storing up kinds of potential energy that cannot be employed.

The greatest loss is in heat, which is dissipated in various ways and cannot be recovered. The presence of unutilized heat always denotes waste of energy.

From what has gone before, we can readily appreciate that when we do work with the object of rendering available a particular kind of energy, the method must be intelligently selected, else there will result useless by-products of energy which will seriously lower the efficiency of the operation.

Whenever possible we utilize potential energy already existing in securing a transformation. Thus if heat is wanted, the easiest way of getting it is to burn coal, and to allow its energy to become kinetic as heat. If we want mechanical work done, we set heat energy to work in the most efficient way practicable. If electrical energy is desired, we set the energy of steam to revolving the armature of a dynamo. If the right method of transformation is not chosen, much of the energy will turn up in forms that we do not want or cannot utilize. Burning coal is a very bad way of getting sound, just as playing a cornet is but a poor means of getting heat, although a fire does produce a trifling amount of sound, and a cornet by continual vibration must be warmed to a minute degree.

These seem, and perhaps are, extreme instances, but when we realize that, somewhat to the discredit of human ingenuity, less than one-twentieth of the electrical energy supplied to an incandescent lamp appears in the form of light, the comparison becomes grimly suggestive.

Understanding now that in order to obtain energy in any given form (such as electrical), particular methods of transformation must be used in order to secure anything like efficiency, we may look a little more closely at various types of energy to discover the characteristics that may indicate efficient methods of transformation, particularly as regards electrical energy.

Speaking broadly, one may divide energy into three classes:

1st. Those forms of energy which have to do with movements of, or strains in, masses of matter. In this class may be included the ordinary forms of kinetic energy of moving bodies and the like.

2d. Those which are concerned with movements of, or strains in, the molecules and atoms of which material bodies are composed. In this class we may reckon heat, latent and specific heats, energy of gases, and perhaps chemical energy.

3d. All forms of energy which have to do with strains which can exist outside of ordinary matter, *i.e.*, every kind of radiant energy and presumably electrical energy.

These classes are not absolutely distinct; for example, we do not know the relation of chemical energy to the third class, nor of gravitational energy to any class, but such a division

serves to keep clearly in our minds the kind of actions to which our attention is to be directed.

It is only within the past few years that we have been able with any certainty to classify electrical energy, and even now much remains to be learned. For a very long while it has been known that light, *i.e.*, luminous energy, must be propagated through a medium quite distinct from ordinary matter and possessing certain remarkable properties. It was well known that luminous energy is transferred through this medium by vibratory or wave motion. Even the period of the vibrations and the lengths of the waves were accurately measured, and from these and similar measurements it has been possible to classify the mechanical properties of this medium, universally called "the ether," until we really know more about them than about the properties of many kinds of ordinary matter — a number of the rare metals, for example.

The next important step was the discovery, verified in the most thorough manner, that what had been known as radiant heat, such as we get from the sun or any very hot body, is really energy of the same kind as light. That is, it was found to be energy of wave motion of precisely the same character and in the same medium, differing only in frequency and wave length. It also has turned out in similar fashion that what had been called "actinic" rays, that are active in attacking a photographic plate and producing some other kinds of chemical action, are only light rays of shorter wave length than usual, and so ordinarily invisible to the eye.

So much having been ascertained, it became clear that instead of three kinds of energy — "heat, light, and actinism," we were really dealing with only one — radiant energy, vibrating energy in the ether, varying in effect as it varies in frequency. Speaking in an approximate way, such wave energy has a frequency of *six hundred thousand billion* vibrations per second and a velocity of propagation of about a hundred and eighty-five thousand miles per second, so that each wave is not far from one fifty-thousandth of an inch long. These dimensions are true of light waves; chemical action can be produced by waves of half the length, while so-called heat rays may be composed of waves two or three times as long as

those of light. Such figures are startling, but they can be verified with an accuracy greater than that of ordinary mechanical measurements.

We see that this radiant energy is capable of producing various disturbances perceptible to our senses, such as chemical action, light, and heat, and that these different effects simply correspond to waves of energy having different frequencies and wave lengths. This being so, it is not unnatural to suppose that at still different frequencies other effects might be noted. This idea gains further probability from the experimental fact that waves of very different frequency traverse the ether with precisely the same velocity, showing no signs of slowing down or dying out, so that there seems to be no natural limit to their length.

During the past half dozen years it has been clearly shown that "radiant energy" is capable of producing profound electrical disturbances, such as violent oscillations of electrical energy in conducting bodies, and that these effects exist whatever the frequency of the ether waves concerned. This very important fact was clearly foreseen by Maxwell more than twenty years ago, regarding light, and his prediction has been thoroughly verified through the persistent researches of the late Professor Hertz and others.

This discovery is often expressed by saying that radiant energy is an electro-magnetic disturbance, or that light is one kind of electrical action. It is more strictly accurate to say that radiant energy, just as it produces chemical disturbances on the photographic plate, affects the eye as light, and material bodies as heat, is also capable of producing electrical effects when transferred to the proper media. Most of our experiments on its electrical effects have been performed with waves many thousand times longer than those of light, but their general character has proved to be exactly the same.

A given substance may be differently related to waves of radiant energy of different lengths, but the phenomena are still essentially the same. For instance, a plate of hard rubber is thoroughly opaque to waves of a length corresponding to light, but is quite transparent to those of considerably greater length, such as can produce thermal or electrical

effects. A plate of alum will let through light waves and very long waves, but will stop most of those which are efficient in producing heat. A thick sheet of metal is quite opaque to all known waves of radiant energy. Hence the fact noted long ago by Maxwell, that all good conductors are opaque to light, although the converse is not true.

The substance of all this is, that the same sort of disturbance in the ether which produces light is also competent to set up electrical actions in material bodies, and conversely, such actions may and do produce corresponding disturbances in the ether, which are thus transferred to other bodies. Such a transference corresponds to all that we know concerning the velocity with which electrical and electro-magnetic disturbances pass from body to body. It is equally certain that this velocity totally transcends anything we could hope to obtain from bodies having the dynamical properties of ordinary matter, while it does fit exactly the dynamical properties of the ether.

We are thus forced to the conclusion that when an electrical current, as we say, "passes along" a wire, whatever a "current" may be, it is not simply transferred from molecule to molecule in the wire as sound or heat would be, but that there is an immensely rapid transfer of energy in the neighboring ether that reaches all points of the wire almost simultaneously. It takes a measurable time for the electrical energy to reach and utilize the centre of the wire, although its progress along the surface, thanks to the free ether outside, is enormously rapid.

Thus takes place what is generally called a "flow of electricity" along the wire. Looking at the process more closely, the nearest approach to flow is the transfer of energy along the wire by means of stresses in the ether which in turn set up strains in the matter along their course.

Whenever we cause in matter the particular stress which we call electromotive force for lack of a more exact name, the resulting strain is electrification, and if the stress be applied at one point of a conducting body, the strain is immediately transferred to other points by the stresses and strains in the surrounding ether. Wherever this transference of strain exists

we have an electrical current, although this name is generally reserved for those cases in which there exists a perceptible transference of energy by the means aforesaid. If the conditions are such that energy must be steadily supplied to keep up the electromotive stress, we have such a state of things as we find in a closed circuit containing a battery.

To cause such a flow of energy we must first find means of setting up electromotive stress capable of being propagated through the ether. Now atoms and molecules are the only handles by which we can get hold of the ether. Only in so far as we can work through them can we do work on the ether.

As a matter of fact, we cannot do work of any kind on the molecules of a body without setting up electrical stresses of some sort. In most cases of mechanical work, which in the main produces stress on the molecules only by strains in the mass, the energy appears mainly as heat, and is only incidentally electrical, as for instance the energy wasted in a heated journal.

When, however, by any device we do work more directly on the molecules of a body, or on the atoms which compose the molecules, we are more than likely to transform much of this work into electrical energy. As a rough example of the two kinds of action just mentioned, pounding a body heats it without causing any considerable electrification, while on the other hand rubbing it rather gently, sets up a considerable electrification without heating it noticeably.

In fact, for many centuries, friction was the only known method of causing electrification. Later, as is well known, it was discovered that certain sorts of chemical action, which has to do directly with interchanges of energy between molecules, were very potent in electrical effects. With this discovery came the ability to deal with steady transfers of electrical energy in considerable amount (electric currents), instead of the relatively slight and transitory effects previously known (electrification, "frictional" electricity).

To clear up the real nature of this difference it is well to consider what we mean by saying that a body is electrified, or has an electrical charge. In other words, what is electrifica-

tion? Not very many years ago this question would have been answered by saying that a quantity of a substance, positive electricity (or negative as the case might be), had been communicated to the body in question; that this remarkable substance could reside only at the surface of the body and was able to produce in surrounding bodies exactly an equal quantity of negative electricity; that this "charge" of electricity would repel another "charge" of the same substance placed near it, or attract a charge of its opposite, the other substance called negative electricity; and much more to the same effect. All this was a very convenient hypothesis — it explained, after a fashion, the common facts and enabled investigators to discover many important electrical relations and laws. But it expressed much more than there was any reason to know. From the standpoint of our modern doctrines of energy, electrification is a very different thing.

Let an electromotive stress (from whatever source) be applied to a body, a metallic sphere for example, long enough to transfer to it a finite amount of energy. This energy appears as stresses and strains in the ether everywhere about the body under consideration and thence extends to the molecules and atoms of neighboring bodies, causing "induced charges." It is as if one were to fill a box with jelly, and then pull or push or twist a rod embedded in its centre. The result would be strains in the rod, the jelly, and the box, and in a general way the total stress on the box would equal that on the rod. By proper means we could detect the strain all through the substance of the jelly, but most easily by its variations from place to place.

We do not know exactly what sort of a strain in our ether jelly is produced by electromotive stress, but we do know that it possesses the quality of *endedness*, so that the strains in the matter concerned, *i.e.*, in the ball and surrounding bodies, are equal and opposite.

In fact, the two "charges" are in effect the two ends of the same strain in the ether. They appear to us to be real attributes of the two opposed surfaces, because at these surfaces the dynamical constants, such as density, elasticity, etc., of the medium through which the strain is propagated, change

in value, and differences in state of strain there become physically manifest.

In electric currents we have a very different state of things. The energy supplied by the electromotive stress, instead of becoming potential as electrostatic strain, and producing "charge," does work and is transformed into other kinds of energy, thermal or chemical, mechanical or luminous.

When a stress of whatever kind is applied to a body, only a limited amount of energy can be transferred by it so long as the energy remains potential. Thus, in our box of jelly before referred to, a twist of given intensity applied to the stick, as for instance by a string wound around it and pulled by a given weight, can only transfer energy until the stresses produced in the jelly come to an equilibrium with it. On the other hand, if the box were filled with water and the stick were the axle of a sort of paddle wheel, the very same intensity of twist could go on communicating energy to the water as long as one chose to apply the necessary work.

This roughly expresses the difference between electric charge and electric current, viewed from the standpoint of energy. An electromotive stress applied to a wire *charges* it and then the transfer of energy ceases. If the same stress be applied under conditions that allow work to be done by it, energy will be transferred so long as the stress is kept up. In an open electric circuit we have a charge as the result of electromotive stress. When the circuit is closed, *i.e.*, when a continuous medium is furnished on which work can be done, we have an electric current. The amount of this work and the flow of electrical energy that produces it depend on the nature of the circuit. Certain substances, especially the metals, and of metals notably copper and silver, permit a ready continuous transfer of energy in and about them. Such substances are called good conductors. The real transfer of energy takes place ultimately *via* the ether, but its amount is limited by the amount and character of the matter through which work can be done.

Whenever the strains in the ether, such as we recognize in connection with electrical charge, shift through space as when a current is flowing, other strains bearing a certain relation

to the direction of flow are made manifest. Where there is a rapid and intense flow of energy, these strains are very great and important compared with any electrostatic strains that exist *outside the conducting circuit*. In other cases they may be quite insignificant. These strains are electro-magnetic, and with them we have to do almost exclusively in practical electrical engineering. They appear wherever there is a moving electrical strain, whether produced by moving a charged body or causing the charge upon a body to move.

Both kinds of strains exist in radiant energy, as in other cases of flowing energy. The stresses in electro-magnetic energy are at right angles both to the electrostatic stresses and to the direction of their motion or flow. If, for example,

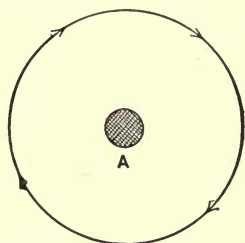

FIG. 1.

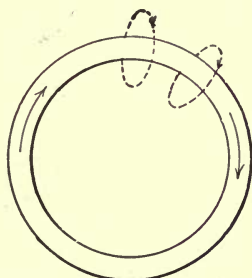

FIG. 2.

we have a flow of electrical energy in a straight wire (Fig. 1), the electro-magnetic stresses are in circles about it.

If *A* be a wire in which the flow of energy is straight down into the paper, the electro-magnetic stresses are in circles in the direction shown by the arrow heads. If the wire be bent into a ring (Fig. 2), with the current flowing in the direction of the arrows, then the electro-magnetic stresses will be (following Fig. 1) in such direction as to pass downward through the paper inside the ring.

These electro-magnetic stresses constitute what we call a *magnetic field* outside the wire. The intensity of this field can be increased by increasing the flow of energy in the desired region in the systematic way suggested by Fig. 2. If, for example, we join a number of rings like Fig. 2 into a spiral coil shown in section in Fig. 3, in which the current flows

downward into the paper in the lower edge of the spiral, there will be produced a magnetic field in which the stresses have the direction shown by the arrows. Such a spiral constitutes a genuine magnet, and if suspended so as to be free to move would take up a north and south position with its right-hand end toward the north. In and about the spiral there exists a magnetic "field of force," which is merely another way of saying that the ether there is under electro-magnetic stress. Its condition of strain is closely analogous to that about an electrified body, and, as in that case, there is no

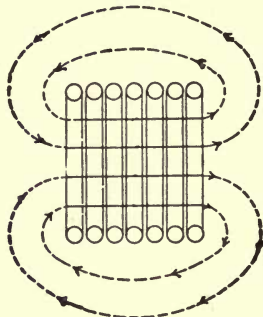

FIG. 3.

work done on the ether after the strains are once established, since the energy then becomes potential. While this is being accomplished, work is done just as when a body is charged.

If, now, setting up such an electro-magnetic field requires energy to be spent by causing a current to flow in the spiral, we should naturally expect that if the same field could be set up by extraneous means, energy would momentarily be spent on the spiral in producing stresses and strains similar to those that set up the original field. This is found to be so, the process working backward as well as forward.

If, for example, we have two rings (Fig. 4), and by sending a current around one, transfer energy to the medium outside it, this energy will set up an electromotive stress in the other ring. The direction of this stress is not at once obvious, but we can get a very clear idea of it by considering the work done. If current is started in *A* (Fig. 4), in the direction shown, electro-magnetic stresses are produced in the direction

of the arrow C . If these are to do work on B , the electromotive stress in the latter cannot have such a direction as to set up on its own account a magnetic field that would *assist* that of A , otherwise we could increase the field indefinitely without added expenditure of energy. Therefore, the electromotive stress in B , and hence the current, must be in a direction opposing the original current in A , as shown in the figure.

In like manner if the current in A be stopped and the field due to it therefore changes, there are changes in the electromagnetic stresses about B , that again set up an electromotive stress in it. If, however, this change of stress is to do work, the electromotive stress in B must be of such direction as to

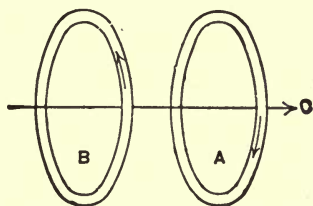

FIG. 4.

oppose by its field the change in the field of A — *i.e.*, it must change its direction and will now give us a current in the same direction as the original one in A . All this follows the general law, that if work is to be done by any stress it must be against some other stress. There can be no work without resistance.

In Fig. 4 we have the fundamental facts of current induction on which depend most of our modern methods of generating and working with electrical energy. Summed up they amount to saying that whenever there is a change in the electromagnetic stresses about a conductor, work is done upon it, depending in direction and magnitude on the direction and magnitude of the change in the stresses.

This is equally true whether the stresses change in absolute value or whether the conductor changes its relation to them. Thus, in Fig. 4, if A carries an electrical current the result on B is the same whether the field of A changes through cessation of the current, or whether the same change in the stresses

about B is produced by suddenly pulling B away from A . The rate at which work is done depends on the rate at which the stresses are caused to change, as might be expected. So long as the stresses are constant with reference to the conductor in which current is to be induced, no work can be done upon it.

These principles form the foundation of the dynamo, motor, alternating current transformer, and many other sorts of electrical apparatus. Their details may differ very widely, but we can get all the fundamental ideas from a consideration of Figs. 3 and 4. To define somewhat the specific idea of the dynamo, consider what happens when a conducting wire is thrust into a magnetic field such as is produced by a coil, as in Fig. 5. As in Fig. 3, let the current in the coil be flowing downward into the paper in the lower half of the figure. A is a wire perpendicular to the plane of the paper in front of the coil, its ends being united at any distant point that is con-

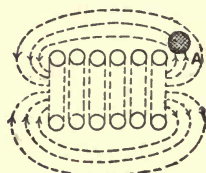

FIG. 5.

venient. Knowing that moving the wire into the field will set up electromotive stresses in it, we can as before determine their direction by remembering that work must be done. That is (see Fig. 1), the induced current will flow through A downward into the paper. In passing out of the field, the current would be upward.

We have so far neglected the rest of the circuit. To be exact, we should consider it as in Fig. 6. Following the same line of reasoning as in Fig. 5, we see that while the ring A is entering the magnetic field the current induced in it must be opposite to that in the inducing coil (see Fig. 4). When the coil is leaving the field, however, this direction will be reversed. Considering the coil A as a whole, we see that so long as the total field tending to set up stresses in it is *increasing*, a current will be induced opposed to that in the inducing coil.

While the total field is diminishing, the induced current will be in the other direction. The work that is spent in moving the coil *A* will for the most part reappear as electrical energy in that coil. Arrange the parts of Fig. 6 so that the motion of *A* can be accomplished uniformly and continuously, and

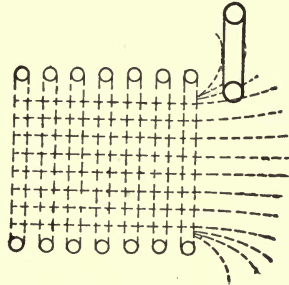

FIG. 6.

we should have a true, though rudimentary, dynamo. Such a structure could be made by fixing *A* to the end of an arm pivoted at the other end and then revolving the arm so that at each revolution the coil *A* would sweep through the field of the magnetizing coil (see Fig. 7). The result of this, as we have seen, would be on entering the field, a current in one direction, and on leaving, a current in the other. There would thus be an alternating current developed in the ring *A*.

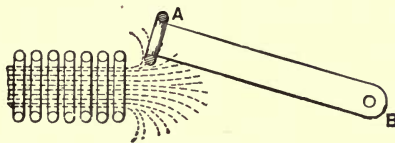

FIG. 7.

If it were cut at some point, and wires led down the arm and to two metal rings on the axis *B*, we could obtain, by pressing brushes on these rings, an alternating current in any outside circuit. To make more of the revolution of the arm useful, we could arrange inducing coils in a circle about *B*. There would then be an alternation as *A* passed each coil.

All these devices, however, would produce comparatively weak effects, because it is difficult to produce powerful mag-

netic stresses in so simple a way. There are very few materials in which magnetic stresses are easily set up or propagated. Chief among these is iron, which bears somewhat the same relation to magnetic actions that copper does to electrical ones. By giving to the coil in Fig. 7 a core of soft iron, the electromagnetic effects obtained from it would be greatly enhanced. They are comparatively feeble in air, and the more iron we put in their path the better. Developing this idea, we have in Fig. 8 a much better device for setting up electric currents. Here the coil of Fig. 7 is wound around an iron core, the ends of which are brought near together. The arm of Fig. 7 is

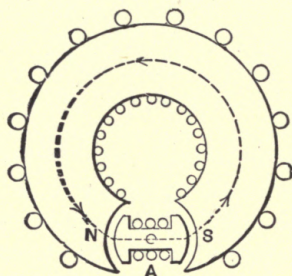

FIG. 8.

also of iron with enlarged ends, and the ring *A* is replaced by a coil of several turns.

The magnetic stresses brought to bear on the coil *A* are thus made comparatively powerful. Following out on Fig. 8 the reasoning applied to Fig. 7, we see that considerable electromotive stresses would be set up by the revolution of *A*, alternating in direction at each half revolution. In fact, *A* is the armature of a simple alternating dynamo, having two poles *N* and *S*, so called from their magnetic relations (see Fig. 3).

We have not thus far considered the source of the electromagnetic field involved. It may be obtained as shown by utilizing the electro-magnetic stresses set up by a wire conveying electrical energy, or on a small scale from permanent magnets. The essential fact, however, is that by forcing a wire through a region of electro-magnetic stress, electromotive stresses are set up in that wire, the action in every case being in such direction as to compel us to do work on the wire.

This work appears as electrical energy in the circuit including the moving wire.

Now return to Fig. 5 and consider the effect if the wire *A* is carrying a steady flow of electrical energy. It will set up electro-magnetic stresses about it as already described. If the current be downward into the paper in *A*, these stresses will be opposed to the stresses in the field. Inasmuch as we have seen that in setting up such a current, work had to be done in forcing the wire into the field, it follows that given such a current, there must be between its field and that of the coil a repulsive force which had to be overcome by doing the work aforesaid. In other words, there must have been a tendency to throw *A* out of the field of the coil. Just as work had to be spent to produce electrical energy in *A*, so electrical energy will be spent in keeping up the stresses around *A* that tend to drive it out of the magnetic field. If the current in *A* were in the other direction, the stresses in its field and that of the coil would be concurrent instead of opposed, and their resultant would tend to draw wire and coil together, *i.e.*, work would have to be spent to keep them apart. This is the broad principle of the electric motor. It is sometimes referred to as simply a reversal of the dynamo, but it really makes no difference whether the structure in which the action just described takes place is well fitted to generate current or not. Given a magnetic field and a wire carrying electrical energy, and there will be a force between them depending in direction on the directions of the electro-magnetic stresses belonging to the two. If either element is arranged so as to move and still keep up a similar relation of these stresses we have an electric motor. Whether so arranged as to fulfil this condition with alternating currents, or in such manner as to require currents in one direction only, the principle is the same.

So far as unidirectional or "continuous" currents are concerned they are usually obtained from dynamo electric machines similar in principle to Fig. 8. This machine, if the ends of the winding on the armature be connected to two metal rings insulated from each other, serves as a source of alternating currents which can be taken off the two rings by brushes

pressed against them. If it is necessary to obtain currents in one direction only, this can be readily done by reversing the connection of the outside circuit to the windings at the same moment that the current reverses in them. The simplest way of doing this is by a "two part commutator," such as is shown in diagram in Fig. 9. Here *A* is the shaft surrounded by an insulating bushing. On this are fitted two half rings, *C* and *C'*, of metal (the commutator segments). On these bear brushes *B* and *B'*. If the ends of the winding are connected to *C* and *C'*, and the brushes are so placed that they pass from one segment to the other at the moment when the current in the winding changes its direction, the direction of the current

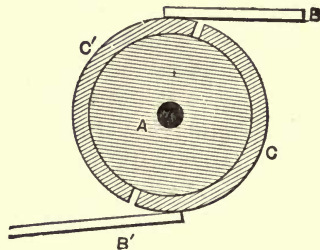

FIG. 9.

with respect to the brushes and the outside circuit with which they are connected obviously remains constant.

In the actual practice of dynamo building very many refinements have to be introduced to serve various purposes, but the underlying principle remains the same, *i.e.*, to set up in a conductor electromotive stresses by dragging it into and out of the strained region of ether under an electro-magnetic stress.

According as the dynamo is intended for producing continuous or alternating currents, its structure is somewhat modified with its particular use in view. These modifications extend not only to the general arrangement but to the details of the winding. Alternating dynamos usually have a more complicated magnetic structure than continuous current machines, and are almost invariably separately excited, *i.e.*, have their magnetizing current supplied from a generator specialized for producing continuous current. The magnetic complication is really only apparent, as it consists merely of an increased num-

ber of magnet poles, due to the desirability of obtaining tolerably rapid alternations of current.

Dynamos designed for producing continuous current are modified with the armature as a starting point. The winding is very generally much more complicated than that of an alternator, and the commutator that serves to reverse the relation of the windings to the brushes at the proper moment is correspondingly elaborate. The magnetic structure is usually comparatively simple. The whole design is necessarily subordinated to securing proper commutation. Continuous current dynamos are almost universally self-excited, that is, the current which magnetizes the field is derived from the brushes of the machine itself. Whatever the character of the machine the electromotive force generated in it increases with the intensity of the magnetic field (that is, with the magnitude of the electro-magnetic strains which affect the armature conductors), with the speed (that is, with the rate of change of electro-magnetic stress about these moving conductors), and with the number of turns of wire of which the electromotive forces are added. The capacity of the machine for furnishing electrical energy varies directly with the electromotive force and with the capacity of the armature conductors for transmitting the energy without becoming overheated. Practically all the energy lost in a dynamo appears in the form of heat, which must be limited to an amount which will not cause an undue rise of temperature.

It is not the purpose of this chapter to deal with the practical details of dynamo design and construction. For these, the reader should consult special treatises on the subject, which consider it with a fulness which would here be quite out of place. Special machines, however, will be briefly discussed in their proper places and in relation to the work they have to do.

Having now considered the principles which underlie the transformation of mechanical into electrical energy, we may profitably take up the fundamental facts in regard to the measurement of that form of energy and the units in which it and its most important factors are reckoned.

All electrical quantities are measured directly or indirectly

in terms of the dynamical units founded upon the units of length, mass, and time. These derived dynamical units can serve alike for the measurement of all forms of energy, so that all have a common ground on which to stand. As the electrical units are derived directly from the same units that serve to measure ordinary mechanical effects, electrical and mechanical energies are mutually related in a perfectly definite way.

A natural starting point in the derivation of a working system of electrical units may be found in electro-magnetic stress, such as is developed about an electrical circuit or a permanent magnet. To begin with, the mechanical units that may serve to measure any form of energy are derived from those of length, mass, and time. These latter are almost universally taken as the centimetre, gramme, and second, the "C. G. S." system. Starting from these the unit of force is that which acting for one second on a mass of one gramme can change its velocity by one centimetre per second. This unit is called the dyne, and as a magnetic stress it is equivalent to a push of about $\frac{1}{443000}$ of a pound's weight on a similar "unit pole" one centimetre distant. This unit is inconveniently small for practical use, and before long some multiple of it is likely to be given a special name and used for practical reference. In fact, one megadyne (*i.e.*, 1,000,000 dynes) is very nearly equivalent to the weight of a kilogramme. Magnetic measurements may thus be made by direct reference to the dyne and centimetre, since the unit pole is that which repels a similar pole 1 centimetre distant, with a force of 1 dyne.

Referring now to what has been said about the causes which vary the electromotive force produced in a dynamo, we fall at once into the definition of the unit electromotive force, which is that produced when field, velocity, and length of wire under induction are all of unit value. The unit electromotive force is, then, that which is generated in one centimetre of wire moving one centimetre per second, perpendicular to its own length, straight across unit field, which is that existing one centimetre from unit pole as indicated above. This unit, too, is inconveniently small, so that one hundred million times this quantity is taken for the practical unit of electromotive force and called the volt.

The unit electrical current is that which flowing through one centimetre length of wire will create unit field at any point equidistant from all parts of the wire (as when the wire is bent to a curve of 1 centimetre radius). One-tenth of this current is taken as the working unit and called the ampere.

The unit electrical resistance (one ohm) is that through which an electromotive force of one volt will force a current of one ampere.

The C. G. S. unit of work is that due to unit force acting through unit distance; that is, one dyne acting through one centimetre. As this is too small to be generally convenient, ten million times this amount is taken as the working unit (called the joule). This is a little less than three-quarters of a foot-pound (exactly .7373). The unit rate of doing work is one joule per second. This unit rate is called the watt, and translating this into English measure, one watt equals $\frac{1}{746}$ horse-power.

Although the watt is often spoken of as an electrical unit, it belongs no more to electrical than to any other form of energy. It only remains to show the relation of the watt to the more strictly electrical units just mentioned. Recurring to our definition of the volt, let us suppose that the resistance of the circuit of which the moving wire is a part is such that unit electromotive force produces unit current in it. The stress between the field of the moving wire and the other unit field in which it moves is then one dyne at unit distance. In maintaining this for one second at the given rate of moving (1 cm. per second) the work done is, as above, one C. G. S. unit. At this rate, if the E. M. F. were 1 volt and the current 1 ampere, the work would be one joule and the rate of doing work one watt. If either E. M. F. or current were changed, the work would be proportionally changed. So, the number of volts multiplied by the number of amperes is numerically equal to the watts, *i.e.*, we have obtained the dynamical equivalent of the two factors that make up electrical energy as ordinarily reckoned. So the output of any dynamo in watts is determined by the volt-amperes produced, and we see the reason of the ordinary statement that 746 volt-amperes make one horse-power. This is always true whether the output is steady

or variable, so long as we give to the product of volts and amperes their true concurrent values.

What few other electrical units appear in practical work will be referred to in their proper places.

It has been the purpose of this chapter, not so much to set forth the ordinary elements of electrical study, as to present these elements as viewed from the standpoint of energy. The author has purposely avoided the conception of electricity as a material something, to lay the greater emphasis on the paramount importance of electrical energy. The present recrudescence of a material theory of electrical charge in no way affects the validity of the principles here laid down, since it deals merely with a possible mechanism behind the stresses and strains which are experimentally apparent.

CHAPTER II.

GENERAL CONDITIONS OF POWER TRANSMISSION.

THE growth of human industry depends on nothing more than upon the possession of cheap and convenient power. Labor is by far the largest factor in the cost of many manufactured articles, and in so far as motive power is cheap and easy of application it tends to displace the strength of human hands in all manufacturing processes, and so to reduce the labor cost and to set free that labor for other and less purely machine-like purposes.

Therefore industrial operations have steadily gravitated toward regions where power is easily procured, often at the sacrifice of certain other advantages. This is in no wise better shown than by the growth of cities around easily available water-powers, even in regions where both raw material and finished product became subject to considerable cost of transportation. With the introduction of the steam engine came a corresponding tendency to gather factories about regions of cheap fuel. These localities, like those in which water-power is plentiful, seldom coincide with centres of cheap material and transportation, so that it has generally been desirable to strike an average condition of maximum economy by transporting the necessary power, stored in the form of fuel, to some advantageous point.

Experience has shown, however, that, while the hauling of coal is a simple and comparatively cheap expedient, fuel utilized for running heat engines is in very many cases so much more expensive than hydraulic power as to be quite out of competition in cases where the latter can be transmitted, with a reasonable degree of economy, to places that are favorable for its utilization. And in general it is found that there is a wide field for the transmission of power obtained from a given source, in competition with power from some other source utilized *in situ*.

The sources of energy on which we may draw for mechanical power to be employed on the spot or transmitted elsewhere are very diversified, although few of them are to-day utilized in any considerable amount. Taking them in the order of their present importance we arrive at something like the following classification:

- I. Fuel.
- II. Water-power.
- III. Wind.
- IV. Solar radiation.
- V. Tidal and wave energy.
- VI. Internal energy of the earth.

Of these only the first two play any important part in our industrial economy. The third is employed in a very small and spasmodic way, the fourth and fifth although enormous in amount are almost untouched, while the last is not at present used at all, owing to inherent difficulties.

I. The world's supply of fuel is almost too great for intelligible description. Aside from a widely distributed and steadily renewed supply of wood, the extent and capacity of available coalfields give promise that for a very long time to come fuel will be the chief source of energy. Coal is found in nearly every country, and in most quite plentifully, while exploration both in old fields and in new, is constantly bringing to light fresh supplies. Many computations concerning the probable duration of the coal supply have been made, but they are generally unreliable owing to the great probability that only a very small proportion of the available coal is as yet known to mankind. Certain it is that there is unlikely to be a marked scarcity of fuel for several centuries to come, even at the present rate of increase in its consumption. Still, it is altogether probable that it may become considerably dearer than at present within perhaps the present century, owing to the increased difficulty of working the older mines and the comparative inaccessibility of new ones.

Besides coal we have petroleum and natural gas in unknown but surely very great quantities, since the distribution of both is far wider than has generally been supposed. At present the cost of these as fuel does not differ widely from that of coal,

but appearances indicate that they are likely to be sooner exhausted.

Every improvement that is made in the generation of power by steam and its subsequent distribution, helps to economize the fuel supply and stave off the already distant day when fuel shall be scarce. The work of the past half century has by direct improvement in steam practice, nearly if not quite doubled the energy available per ton of fuel. Beyond this much has been done along collateral lines. Particularly, explosive vapor engines have been developed to a point at which they are for small powers decidedly more economical than steam engines. Gas engines of moderate size, 5 to 25 HP, are readily obtained of such excellence as to give a brake-horse-power hour on an expenditure of little, if any, more than 20 cu. ft. of ordinary gas, reducing the cost per HPH to below that of power from a steam engine of similar size. Engines using an explosive mixture of air and petroleum vapor are at least equally economical, in fact more so unless the comparison be made with very cheap gas.

These explosive engines have nearly double the net efficiency of steam engines as converters of thermal energy into mechanical power, and are capable of giving under favorable circumstances 1 HPH on the thermal equivalent of less than 1 pound of coal.

II. Water-power derived from streams is not distributed with the same lavish impartiality as fuel, but nevertheless exists in many regions in sufficient amount to be of the greatest importance in industrial operations. Available streams exist around almost every mountain range and are capable of furnishing an amount of power that is seldom realized. In the United States the total horse-power of the improved water-power is approximately 1,500,000. New England is especially rich in this respect, as is, too, the entire region bordering on the Appalachian range. The Rocky Mountains are less favored, the available water being rather small in amount, on account of the smaller rainfall and the severe cold of the winters.

The Pacific slope is rather better off, and the high price of coal operates to hasten the development of every practicable power. All over the country are scattered small water-powers, and one

of the interesting results of the growth of electrical power transmission has been to bring to light half forgotten falls, even in familiar streams. Abroad, Switzerland is rich in powers of moderate size, as is the entire Alpine region, while a few years of experience in electrical transmission will probably cause the discovery or utilization of many water-powers that have hardly been considered, even in highly developed countries. Of the world's total water-power supply we know little more than of its coal supply, but it is quite certain, now that transmission of power over very considerable distances is practicable, that the employment of the one will every year lessen the relative inroads upon the other. And this is in spite of the fact that water is by no means always cheaper than steam as a motive agent.

III. Wind as a prime mover has been employed on a rather small scale from the very earliest times. Were it not for the extreme irregularity of the power supplied by it in most places, the windmill would be to-day a very important factor in the problem of cheap power. Unhappily, winds in the same place vary most erratically, from the merest breeze to a hurricane sweeping along at the rate of 50 to 75 miles an hour. As all strengths of wind within very wide limits must be utilized by the same apparatus running at all sorts of speeds, it is no easy matter to employ it for most sorts of work. It seems especially unfitted for electrical work, and yet several small private plants have obtained good results from windmills used in connection with storage batteries.

In ordinary winds the great size of the wheel necessary for a moderate power militates against any very extensive use. For example, with a good breeze of 10 miles per hour a wheel about twenty-five feet in diameter is needed to produce steadily a single effective horse-power, and the rate of rotation, about 30 revolutions per minute, is so low as to be inconvenient for many purposes. Hence windmills are generally used for very small work which can be done at variable speed, such as pumping, grinding, and the like, for which they are unexcelled in cheapness and convenience. For large work we can hardly count much on wind-power, in spite of ingenious speculations to the contrary, and as a source of power for general distribution it

is out of the question, for such as it is we have it already distributed. It must rather be regarded as a local competitor of distributed power, and even so only in a small and limited field.

IV. Aside from being in a general way the ultimate source of nearly all terrestrial energy, the sun steadily furnishes an amount of radiant energy, which if converted into mechanical power would more than supply all possible human needs. Its full value is the equivalent of no less than ten thousand horse-power per acre of surface exposed to the perpendicular rays of the sun.

This prodigious amount is reduced by perhaps one-third through atmospheric absorption before it reaches the sea level, and in cloudy weather by a very much larger amount. Nevertheless, with clear sunlight the amount of energy practically available, after making all allowances for increased absorption when the sun is low, and for the hours of darkness in any given place, is very great. If we suppose the radiant energy to be received on concave mirrors kept turned toward the sun and arranged so as to utilize the heat in the boiler of a steam or vapor engine, the average result after making all allowances for losses would be one mechanical horse-power for each 100 square feet of mirror-aperture, available about ten hours per day.

Very important pioneer work was done on solar engines by John Ericsson and by M. Mouchot more than a quarter century ago, but it is only within the past few years that the solar engine has approached really commercial form. At the present time solar heating apparatus is being regularly produced although on a rather small scale, and gives good economic results. The solar motor is essentially a steam engine supplied with steam by a boiler placed in the focus of a concave mirror. This is shaped like an open umbrella with its handle pointed toward the sun. The umbrella is carried on a polar axis at right angles to the handle and pointing toward the celestial pole. The actual mirror is segmental, built upon a steel frame, of rectangles of plane thin glass silvered on the back. Each segment is about six inches wide and two feet long, supported by cushioned clamps at the corners, and the whole are arranged to focus the sun's rays on a cylindrically disposed blackened boiler formed of copper tube. The structure is

supported on a polar axis about which it is moved automatically by steps every few minutes, remaining locked in the intervals to avoid needless strain on the clockwork. There is also a motion in declination to take care of the apparent motion of the sun, adjusted by hand every day or two as becomes necessary. The engine is generally a rather highly organized one, worked condensing and with superheated steam at a pressure of 200 lbs. per square inch or more. The net result is one brake HP for each 100 square feet of mirror surface. The mirror structure becomes rather unwieldy when of dimensions great enough to supply an engine of more than 15 HP, so that for greater powers several mirrors with their boilers should be coupled together. The initial cost of each equipment is high, say \$250 per horse-power, but the fuel cost is *nil* and the attendance required very little, so that even now there are localities where its use is economical. The full power is available about eight hours per day, and there is upon the earth's surface a vast, irregular equatorial belt in which such solar engines can be successfully used for irrigation and other purposes. The power is steady, and reliable during the hours of sunshine, and gives constant speed like any other steam engine. It is worth mentioning that general heating and cooking apparatus on the same plan is entirely practicable in regions of scant fuel and high sun, and has been tried successfully.

V. Of tidal energy but little use has yet been made. Here and there, both here and abroad, are small tidemills, feebly suggesting the enormous store of tidal power as yet unutilized. The intermittent character of tidal currents and the small extent of the rise and fall generally available, make the practical part of the problem somewhat difficult. The easiest way of harnessing the tides is to let the rising water store itself in artificial reservoirs, or natural ones artificially improved, and then during the ebb to use it with water-wheels. But usually the head is so small that for any considerable power stored the area of reservoir must be very large, and the wheels must be of great size in order to make the stored water do its work before the rising tide checks further operations. The average tide is seldom more than 10 to 12 feet along our coast, and of this hardly more than half could be utilized to give even a few

hours of daily service. At 6 feet available head about 100 cubic feet of water must be stored for each horse-power-minute, even with the best modern turbines. Hence for say 1,000 HP available for 5 hours there must be impounded 30,000,000 cubic feet of water, making a pond 6 feet deep and almost 120 acres in extent.

Tidal operations are therefore likely to be restricted to a few favored localities where through special configuration of the ground natural reservoirs can be found, and where the rise of the tide is several times the figure named. In rare cases, by the use of more than one reservoir and outlet, work may be made nearly or quite continuous. Still, with all these difficulties the possibilities of tidal power are enormous in certain cases. Take for example the Bay of Fundy with its 40 feet of normal tidal rise. If half this head can be used in practice 30 cubic feet will be required per horse-power-minute, and a single square mile of reservoir capacity gained by damming an estuary or cutting into a favorable location on shore will yield 62,000 horse-power ten hours per day in two five-hour intervals. Generally speaking, economic conditions are not favorable for such an employment of the tides, but in some localities a peculiarly fortunate contour of the shore coupled with high local cost of fuel may render it easy and profitable to press the tides into service. The author has had occasion to investigate a few cases of this kind in which the commercial outlook was good. The main difficulties in utilizing the tides are two: first, the very variable head; and, second, the short daily periods in which the outflow can be advantageously used. Moreover, these periods shift just as the times of high tide shift, by a little less than an hour per day, so that if the power were used directly it would often be available only at very inconvenient times.

To work the tides on a really commercial scale, therefore, some system of storing power is absolutely necessary. And since one would have to deal with very large amounts of power, much of the time the entire output of the plant, the storage must be fairly cheap and efficient. For work on the scale contemplated, it is probable that the storage battery is the most available method. Used in very large units in

a colossal plant, most of the serious objections to the storage battery are in great measure obviated, since attendance and repairs can be part of the duties of a regular maintenance department, inspecting, testing, and repairing damaged cells, casting and filling new plates, and keeping the plant in first-class working condition all the time.

The cost of battery would be, of course, a serious matter, but not prohibitive, and its efficiency could probably be kept as high as 80 per cent. The best idea of the economic side of the case can be gained by investigating a hypothetical case of tidal storage, based, for convenience, on the square mile of reservoir just mentioned. To simplify the case we will assume use of the power locally, so as not to complicate the situation by the details of a long-distance transmission. We will take the generators, which can be worked at steady full load, at 94 per cent efficiency. Then the efficiency to the distributing lines would be

$$.94 \times .80 = .752.$$

At this rate, the 62,000 HP available would give substantially 35,000 KW; *i.e.*, 350,000 KW-hours daily. Storage capacity would have to be provided for this whole amount in a gigantic battery, weighing about 18,000 tons and costing in the neighborhood of three million dollars. To this, of course, the cost of the electrical and hydraulic machinery must be added, and beyond this must be reckoned the really very uncertain cost of the reservoir and hydraulic work. In spite of all this, an assured market for the output would lead to economic success under conditions quite possible to be realized. If extensive transmission had to accompany the enterprise there would be still further loss of efficiency, so that the final figure would not exceed 60 per cent, which would reduce the salable power to about 27,000 KW. Evidently this would have to command a very good price, to carry the burden of the heavy investment, which would probably rise to between \$10,000,000 and \$15,000,000. The cost of such an enterprise is so formidable that it is practically out of the question, unless it can reach a market for power in which a very high price is admissible. When fuel begins to get

scarce it will be profitable to utilize the tides on a large scale; until then, their use will be confined to isolated cases in which local causes lead to high cost of other power and tidal storage is unusually cheap.

All these considerations apply with similar force to wave motors, which have been often suggested, and now and then used, as sources of power. The energy of the waves is very great, as the havoc wrought by storms bears witness; but it is most irregular in amount, and requires very large apparatus for its utilization. What is worse, the power is intermittent, so that to be of any material advantage it must be brought to a steady output by means of storage of energy in some form. The periodicity of wave motion is so low, roughly about 6 to 10 crests per minute, that flywheels and the like are of little use, and storage is practically reduced to a question of compressing air or pumping water. Even if some such wasteful intermediary were not necessary, and one could work directly by means of floats or their equivalent, a float would have to have a displacement of at least one ton per horse-power, even if working in a pretty heavy sea, and under ordinary circumstances several times that amount of displacement. At best, wave motors are cumbersome, and give small promise of economic development while other sources of energy are available.

VI. Of the earth's internal heat energy there is little to be said. It is quite unused save as an occasional source of hot water, and except in a very few cases could not be employed at all, much less to any advantage. Immense as is its aggregate amount, it is, save at isolated points, so far separated from the earth's surface as to be very difficult to get at. Hot springs, very deep artesian wells, and some volcanic regions, furnish the only feasible sources of terrestrial heat energy, so that the whole matter is only of theoretical interest.

We see that at present only two sources of energy, viz., fuel and water-power, are worthy of serious consideration in connection with the general problem of the transmission and distribution of power. The other sources enumerated are either very irregular, uncertain in amount, or so difficult of utilization as to remove them at once from the sphere of practical work.

Granted, then, that fuel and water-power are and are likely long to remain the dominant sources of energy, let us look more closely into their possibilities. From each energy can be readily transmitted and distributed by any suitable means; each, in fact, can be transferred bodily to a distant scene of action without any transformation from its own proper form. In fact, for certain purposes and under certain conditions such is the very best method. Fuel for ordinary heating and water for such uses as hydraulic mining can be taken as cases in point. In a more general way, both fuel and water for the development of mechanical power may often profitably be transferred from place to place.

The conditions of economy in the transmission of fuel as such are comparatively easy to examine and define. Coal may be produced at the mine for a certain quite definite cost per ton. It can be transported over railroads and waterways for an easily ascertainable price. Such a transmission may be said to have a definite efficiency, as for example 90 per cent, when the total transportation charges against a ton of coal amount to 10 per cent of its final value. From this standpoint it is quite possible to transmit power at this very high efficiency even to the distance of hundreds of miles. If the final object be the distribution of power on a large scale, as from a great central station, this transmission by transportation of fuel is often at once the most reliable and the cheapest method.

Transformation of the fuel energy at its source into some other form for the purpose of transmission is generally only justifiable, first, when by so doing fuel not available for transportation at a high efficiency can be rendered valuable by transformation of its energy, or second, when it is to be utilized at some distant point in a manner which compels a loss of efficiency greater than that encountered in transmission. As an example of the first condition, fully one-third of the coal as ordinarily mined is unfitted, through its finely divided condition or poor quality, for transportation over considerable distances. Its commercial value is so small per ton that it could not be carried far without incurring charges for carriage amounting to a large part of its value. Hence, every coal mine accumu-

lates a mountainous culm pile that is at present not only valueless but cumpers the ground. This waste product could sometimes be very profitably employed in generating power which could be transmitted at a relatively very high efficiency and sold at a good price.

A specimen of the second kind may be found in the somewhat rare case of power which must be used in small units scattered over a considerable territory, so that they could be replaced with a great gain in efficiency by a single large generating station. Such a state of affairs might be found in certain mining regions where coal and iron mines are interspersed. This must not be confounded with the very ordinary case of distributing energy from a central station to various scattered points, for we are here considering only the original source of the fuel.

When an extensive distribution of energy from a power station is contemplated, electrical or similar transmission of power to that station is generally economical only on the condition above expressed, of using fuel otherwise valueless, since the facilities for transportation to points at which power distribution on a large scale would be profitable, are generally good and fairly cheap. All this applies to piping gas or petroleum as well as to hauling coal, with the difference that neither gas nor petroleum has any waste corresponding to culm, and hence the transportation of each of them becomes a process entirely comparable with the transmission of energy and directly competing therewith. It has even been proposed to pipe coal dust by pneumatic power for fuel purposes.

Water-power is by no means always cheaper than fuel, but as a general rule it is, and by such an amount that it can be transformed into electrical energy and transmitted to at least a moderate distance without losing its economic advantage. It therefore is usually the cheapest source from which to derive power for general distribution on a large scale.

It is very difficult to give a clear idea of the relative cost of steam and water-power, for while the one can be predicted for any given place with fair accuracy, the other is subject to immense variations. Once established, a water-power plant can be operated very cheaply, but the cost of developing the

water-power may be almost anything, and each case must be figured by itself. It is easy to obtain estimates of the cost of developing a given stream and to form a close estimate of both the interest charges to be incurred and the additional expense of repairs and of operation. The cost of steam-power for the same conditions can be accurately estimated. The details of such estimates we will discuss later. In general, one can only safely say that the costs of steam and water-power overlap, as it were, so that while the more easily developed water-powers are cheaper sources of energy than fuel at any ordinary price, there are many cases in which the great cost of development of difficult water-powers prohibits competition with steam except where fuel is very dear. Much depends on the topography of the country, the amount and reliability of the available head of water, the price at which water rights can be obtained and various other local conditions. To utilize the normal minimum power of a stream is generally comparatively easy, while so to take account of high water as to obtain nearly the full continuous working power of the stream often means great added expense for storage capacity and works to control and regulate the flow.

In addition we have to consider two distinct phases of the comparative cost — first, the cost of steam and water as prime movers for a source of power to be distributed, and second, the relation between these costs and that of steam-power at the points where the distribution takes place.

Given a proper source of energy, there is vast variety in the character of the work of transmission and distribution that is to be undertaken. In the first place, the point of utilization may be distant anywhere from a few hundred feet to many miles, and at that point the object may be the delivery of mechanical power in a single unit, in one or several groups of allied units, in one or several widely scattered groups, or finally for transformation into some other form of energy in the most direct way possible.

There is no single method of power transmission which meets in the best possible manner all these widely varying conditions. Although electrical transmission is the most general solution of the difficult problem in hand, there are cases in

which other methods are preferable and should be adopted. Those besides electric transmission which have come into considerable use are the following:

- I. Wire Rope Transmission.
- II. Hydraulic Transmission.
- III. Compressed Air Transmission.
- IV. Gas Transmission.

It will be well to look into the distinguishing characteristics of these and their relation to electrical transmission, with the purpose of finding the advantages and limitations of each, so that the proper economic sphere of each may be determined, before taking up the electrical work which forms the main subject of this volume. Each method will be found to have its own legitimate place.

I. The transmission of power by wire ropes is merely a very useful extension of the ordinary process of belting. Belts are made of material which will not stand exposure to the weather, and which being of low tensile strength is heavy and bulky in proportion to the power transmitted. The advantage of wire rope over belting lies in its high tensile strength and freedom from deterioration when used out of doors. To gain the fullest benefit from these properties it is necessary to use light ropes driven at high speed.

It should be borne in mind that the power transmitted by anything of the nature of belting depends directly on the speed and the amount of pull exercised. If the force of the pull is 100 pounds weight and the speed of belt or rope is 4,000 feet per minute, the amount of power transmitted is 400,000 foot-pounds per minute or (since 1 horse-power is 33,000 foot-pounds per minute) about 12 HP. The greater the speed, the more power transmitted with the same pull, or the less the pull for the same power. Wire rope can be safely run at a considerably higher speed than belting and is much stronger in proportion to its size and weight. It does not often replace belting for ordinary work, for the reason that owing to its small size it does not grip ordinary pulleys anywhere nearly in proportion to its strength. Hence, to best take advantage of its ability to transmit large powers, the rope speed must be high and the pulleys unusually large in diameter to give suffi-

cient surface of contact. Such large wheels are inconvenient in most situations, and as the alternative is a number of ropes which are troublesome to care for, rope driving save for outdoor work is rather uncommon.

A typical rope transmission is shown diagrammatically in Fig. 10. Here *A* and *B* are two wheels, usually of cast iron, generally from 5 to 15 feet in diameter and with deeply grooved

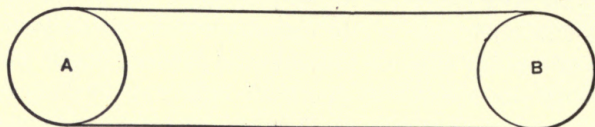

FIG. 10.

rims. They are connected by a wire rope perhaps from $\frac{1}{2}$ inch to $1\frac{1}{2}$ inch in diameter, which serves to transmit the power as the wheels revolve. The rope speed is usually from 3,000 to 5,000 feet per minute, sometimes as high as 6,000. The distance between the centres of *A* and *B* may be anything required by the conditions up to four or even five hundred feet. Greater distances are seldom attempted in a single span, as, if the rope is not to be overstrained by its own weight, it must be allowed to sag considerably, compelling the pulleys to be raised to keep it clear of the ground, and subjecting it to danger from swaying seriously by reason of wind pressure or other accidental causes.

The rope employed is of special character. The material is the best charcoal iron or low steel, and the strands are usually

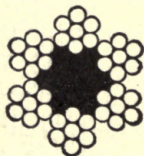

FIG. 11.

laid around a hemp core to give added flexibility. The rope generally employed in this country is of six strands with seven wires per strand, and is shown in cross-section in Fig. 11. Even with the hemp core there is still in an iron rope sufficient resistance to bending to make the use of pulleys of large

diameter necessary. Sometimes each separate strand is made with a hemp core, or is composed of nineteen small wires instead of seven larger ones, to increase the flexibility and to make it possible to use smaller sheaves and drums, as in hoisting machinery.

Steel rope is slightly more costly than iron, but gives greater durability. The wheels on which these ropes run are furnished with a deep groove around the circumference, provided with a relatively soft packing at the bottom on which the rope rests, and which serves to increase the grip of the rope and to decrease the wear upon it. Fig. 12 shows a section of the rim of such a wheel. The bushing at the bottom of the

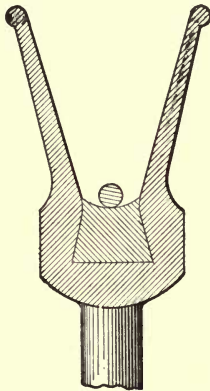

FIG. 12.

groove, upon which the rope directly bears, has been made of various materials, but at present, leather and especially prepared rubber are in most general use. The small pieces of which the bushing is composed are cut to shape and driven into the dovetailed recess at the bottom of the groove. The bushings have to be replaced at frequent intervals, and the cables themselves have an average life of not much over a year.

When a straightaway transmission of a few hundred feet is necessary, when the power concerned is not great, and the size of the pulleys is not a serious inconvenience, this transmission by wire rope is both very cheap and enormously efficient. No other known method can compete with it within these somewhat narrow limitations. For a span of ordinary length

and the usual rope speeds, the efficiency has been shown by experiment to be between 96 and 97 per cent. At a distance of four to five hundred feet the weight and sag of the rope becomes a very serious inconvenience, and the arrangement has to be modified. Perhaps the most obvious plan is

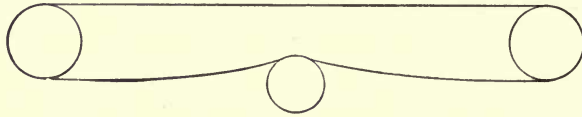

FIG. 13.

to introduce a sheave to support the slack of the cable, as shown in Fig. 13.

On longer spans several sheaves become necessary, and both the slack and the tight portions of the cable need such support. In cable railway work, the most familiar instance of power transmission by wire ropes, numerous sheaves have to be employed to keep the cable in its working position in the somewhat contracted conduit. These reduce the efficiency of the system considerably, so that the power taken to run the cable light is often greater than the net power transmitted. In aërial cable lines multiple sheaves are seldom used, and the more usual procedure is to subdivide the transmission into several independent spans, thus lessening swaying and sagging as well as the length of rope that must be discarded in case of a serious break. This device is shown in Fig. 14. It employs intermediate pulley stations at which are installed double

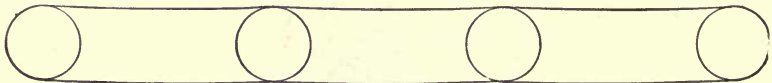

FIG. 14.

grooved pulleys to accommodate the separate cables that form the individual spans. Such a pulley is shown in section in Fig. 15. The spans may be three or four hundred feet long; as soon as the length gets troublesome another pulley station is employed. There is necessarily a certain small loss of energy at each such station. This is approximately proportional to the number of times the rope passes over a pulley. From

the best experimental data available the efficiency of a rope transmission extended by separate spans is nearly as follows:

Number of spans	1	2	3	4	5	6	7	8	9	10
Per cent efficiency96	.94	.93	.91	.89	.87	.86	.85	.84	.82

These figures are taken to the nearest per cent and are for full load only. At half-load the loss in each case would be doubled. For instance, a 10-span transmission at half-load

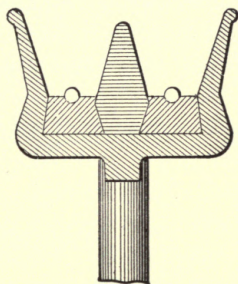

FIG. 15.

would give about 64 per cent efficiency. The pulley stations consist of the double-grooved wheel before mentioned mounted on a substantial and rather high pedestal or frame-work. In this country a timber frame is generally used; abroad

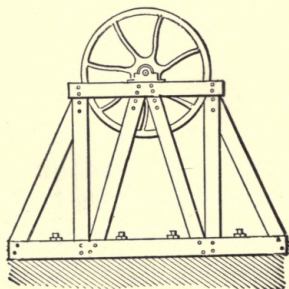

FIG. 16.

a masonry pier is more common. A convenient form of frame-work is shown in Fig. 16. An idea of its dimensions may be gained from the fact that the wheel is likely to be 6 to 10 feet in diameter.

It is interesting to note that the efficiency just given for a 10-

span transmission at full load is quite nearly the same as would be obtained from an electrical-power transmission at moderate voltage over the same distance, assuming a unit of say 50 HP or upward. The first cost of the latter would be considerably higher than that of the rope transmission, but the repairs would certainly be much less than the replacements of cable, bringing the cost per HP at full load to about the same figure by the two methods.

From actual tests of electrical apparatus we have the following efficiency for a transmission of 50 HP 5,000 feet, assuming 2,000 volts and 2 per cent line loss, which would require

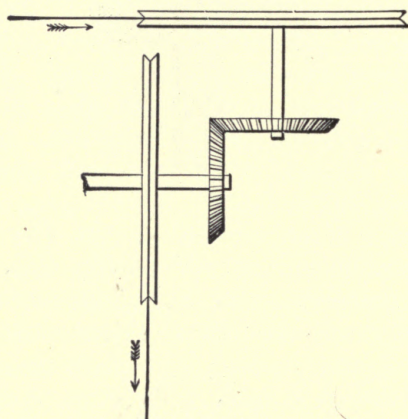

FIG. 17.

a wire less than one-fourth of an inch in diameter. Efficiency at full load 81 per cent, at half-load 72. These values are lower than those attainable with machinery of the most recent type, which should give at least 86 per cent at full load and 80 per cent at half-load for the complete transmission, which beats out rope transmission at a distance much less than 5,000 feet. Except at full load the electrical transmission has a very material advantage. This advantage would be greatly increased if the transmission were in anything but a straight line. An electric line can be carried around any number of corners without loss of efficiency, while a rope transmission cannot. If it becomes needful to change the direction of a

rope drive, it is done at a station provided with a pair of rope wheels connected by bevel gears set at any required angle. Fig. 17 shows such a station in diagram. The loss of energy in such a pair of bevel gears amounts to from 7 to 10 per cent, more often the latter. The bevel gears may be avoided by a sheave revolving in a horizontal plane, and carrying the turn in the cable, but while this arrangement is tolerably efficient, it greatly decreases the life of the rope.

From what has been said, it will be seen that while cable transmission is for short distances in a straight line both cheap and very efficient, at 2,000 to 3,000 feet it is equalled and surpassed in efficiency by electric transmission, with lesser maintenance although greater first cost. The steel rope for a 50 HP transmission of 5,000 feet would cost about \$400, and replacement brings a considerable charge against each HP delivered. If the transmission is not straightaway, or if branches have to be taken off *en route*, the efficiency of the system is considerably reduced by gear stations, while even aside from these the efficiency is high only at or near full load. But the general simplicity and cheapness of cable transmission have made it a favorite method, and there have been many such installations, some of them of a quite elaborate character. Most of them are small, since the amount of power that can be transmitted by a single rope is limited to 250 or 300 HP. Ropes suited to a larger power are too heavy and inflexible; $1\frac{1}{4}$ inch is about the greatest practicable diameter of cable, and even this requires pulleys between 15 and 20 feet in diameter for its proper operation. Besides, even at moderate distances the rope transmission suffers in wet or icy weather, so that at anywhere nearly equal costs the electrical drive is to be preferred save in the simplest cases.

Under all circumstances the need of replacing the cables every year or so causes a high rate of maintenance. The following table, giving the sizes of iron-wire cables and pulleys necessary for transmitting various amounts of power, will help to give a clearer idea of the conditions of cable transmission and aid in defining its limited but useful sphere. Speed is given in revolutions per minute, and pulley diameter is the smallest permissible. These figures are, as will readily be seen, for rope

CIVIL ENGINEERING

U. of C.

ASSOCIATION LIBRARY

Diameter of Rope.	Speed.	Diameter of Pulley.	HP.
$\frac{1}{2}$ "	150	6'	25
$\frac{9}{16}$ "	140	7'	35
$\frac{3}{8}$ "	140	8'	45
$\frac{1}{4}$ "	100	10'	85
$\frac{1}{2}$ "	80	12'	100
$\frac{3}{4}$ "	80	14'	140
$1\frac{1}{8}$ "	80	14'	150

speeds of not far from 3,000 feet per minute. This can frequently be safely raised to 5,000 with somewhat larger pulleys than those given and increased revolutions, while for steady loads the tension can be slightly augmented without danger. So while the figures given are those suitable for ordinary running with a good margin of capacity, the HP given can be nearly doubled when all conditions are favorable.

But from all these figures it is sufficiently evident that rope transmission is very limited in its applicability and is not at all suited to work of distribution in small units. For a good many years, however, a wire-rope transmission, now practically superseded by electric driving, was operated at Schaffhausen on the falls of the Rhine. The power station delivered more than 600 HP to a score of consumers over distances of half a mile or so. There were two bevel-gear stations, and on the average, five cable spans between the power station and the consumer, so that the efficiency even at full load was somewhere between 60 and 70 per cent and ordinarily very much less. Nevertheless, in default of any better means of transmission at the time of installation, some twenty years since, the plant did fairly successful work, even from a commercial standpoint. In this country the system is very little used save for short straight runs between building and building across streets, for instance.

II. Noting, then, that cable transmission does excellent work in its proper place, but is unsuited for the distribution of power or for transmissions of anything save the simplest sorts, we may pass to the hydraulic method of transmitting and distributing power. This in its crude form of small water-motors attached to ordinary city mains is very familiar, but nothing

more extensive has been attempted in this country. Abroad there are a number of hydraulic power plants specially intended for the distribution of power for general use, and the method is one which has been fairly successful. There are two distinct types of hydraulic plant, one utilizing such pressure as is available naturally or by pumping to reservoirs, the other employing very high artificial pressures, up to 750 pounds per square inch, and used only for special purposes.

There are somewhat extensive works of the former kind at Zurich, Geneva, and Genoa, the effective head of water being in each case not far from 500 feet. In each case the power business has been an outgrowth of the municipal water-supply system. At Zurich and Geneva elevated reservoirs are supplied by pumping stations driven by water-power. At Genoa the head is a natural one, 20 miles from the city, and much of the fall is utilized 18 miles from Genoa in driving the fine constant current electric plant described elsewhere in this volume.

At Zurich there is in addition to the ordinary low pressure water system a special high service reservoir supplying power to a large electric station and to small consumers. Water is pumped 6,000 feet into this reservoir through an 18-inch main, and the total power service from both systems is something like 500 HP, reckoned on a ten-hour basis. The price charged is from \$37 to \$80 per HP per year.

The Geneva plant is on a much larger scale, the total turbine capacity being about 4,500 HP. Here, as at Zurich, there are two sets of mains, one at nearly 200 feet head, the other at about 450. Each supplies water for both power and general purposes. The high pressure service reservoir is about $2\frac{1}{2}$ miles from the city, and the working pressure is supplied indifferently from this or from the pumps direct. There is an electric light plant with 600 HP in turbines driven by the pressure water, and a large number of smaller consumers. Water is supplied to the electric light company for as low as \$15 per HP per year.

Both these installations are extensions of the city water service, and have done excellent work. Operated in this way the economic conditions are somewhat different from those to be found in a hydraulic plant established by private enterprise

for power only. An inquiry into the efficiency of such a system may be fairly based on the facts given. At Zurich, for example, the efficiency from turbine shaft to reservoir cannot well exceed .75. The distributing mains must involve a loss of not less than 10 per cent, while the motors cannot be counted on for an efficiency of over .75. The total efficiency from turbine shaft to motor shaft is then about $.75 \times .75 \times .90 = 50.6$ per cent. The character of the motors has an important influence on the economy of the system, particularly at low loads. The motors most used particularly for small powers

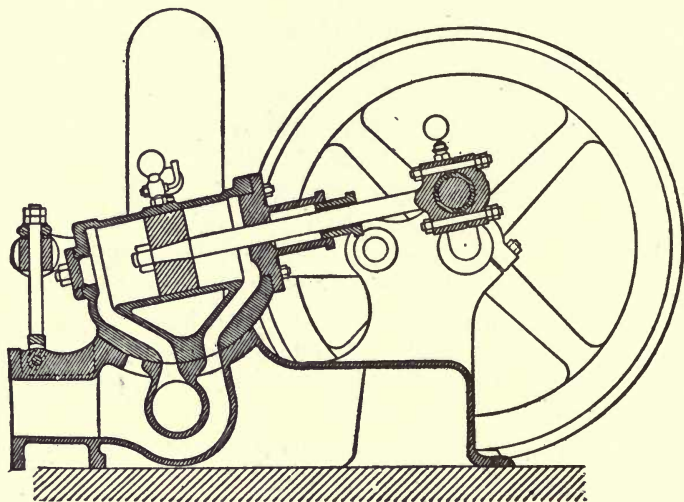

FIG. 18.

are oscillating water engines of the type shown in Fig. 18. The form shown is made by Schmid of Zurich. It possesses, in common with all others of similar construction, the undesirable property of taking a uniform amount of water at uniform speed, quite irrespective of load. The mechanical efficiency falls off like that of a steam engine, friction being nearly constant. Better average results are secured with impulse turbines (see Chapter IX) of which the efficiency varies but little as the load falls off, or for high rotative speeds with impulse wheels like the Pelton, shown in Fig. 19, as adapted for motors of moderate power. At half-load, *i.e.*, half flow, the losses in distributing

mains would be reduced to about one-third, while the efficiency of the engine motors would certainly not be lowered by less than 5 per cent. The total half-load efficiency would then be $.75 \times .97 \times .70 = 50.9$ per cent, actually a trifle higher than at full load. This apparently remarkable property is shared by all transmissions wherein the transmission loss proper is fairly large.

The second type of hydraulic distribution of power is that at very high pressures and employing a purely artificial head. The pressures involved are usually 700 to 800 pounds per square

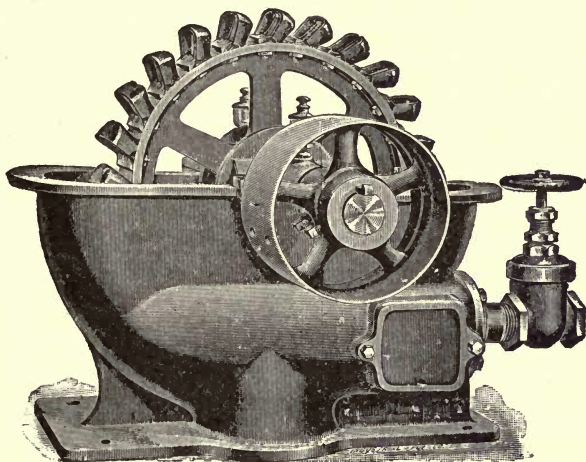

FIG. 19.

inch, and a small amount of storage capacity is gained by employing what are known as hydraulic accumulators, fed by the pressure pumps. These accumulators are merely long vertical cylinders adapted to withstand the working pressure, which is kept up by a closely fitting and enormously heavy piston. The distribution of power is by iron pipes leading to the various water motors. This high pressure water system is a device almost peculiar to England, and has been slow in making headway elsewhere. Its especial advantage is in connection with an exceedingly intermittent load, such as is obtained from cranes, hoists, and the like. This is for the reason that with a low average output a comparatively small

engine and pump working continuously at nearly uniform load can keep the accumulators charged, while the rate of output of the accumulators is enormous in case of a brief demand for very great power.

Power plants on this hydraulic accumulator system are in operation in the cities of London, Liverpool, Hull, and Birmingham, England, and at Marseilles, France. The London plant is the most important of those mentioned, consisting of three pumping and accumulator stations and about 60 miles of mains. The total number of motors operated was in 1892 about 1,700. The charges are by meter, and are based on intermittent work, being quite prohibitive for continuous service — from \$200 to \$500 per effective HP per year of 3,000 hours. The largest accumulators have pistons 20 inches in diameter and 23 feet stroke, giving a storage capacity of only 24 horse-power-hours each. While very convenient for the supply of power for intermittent service only, this system, like hydraulic supply at low pressure, is rather inefficient, the more so as it has been found advisable to employ hydraulic motors of the piston type, although special Pelton motors have been used in some cases.

Any hydraulic system suffers severely from the inefficiency of pump and motors and from loss of head in the pipes. The amount of power that can be transmitted in the mains is quite limited, since the permissible velocity is not large. About 3 feet per second is customary — more than this involves excessive friction and danger from hydraulic shock. At this speed a pipe about 2 feet in diameter is necessary to transmit 500 HP under 500 feet head.* The power delivered increases directly with the head, but as the pressure increases the largest practicable size of pipe decreases, and on the high pressure systems nothing larger than 12 inches has been attempted, and even this requires the use of solid drawn steel

Whatever the size of pipe, the loss in head is quite nearly inversely as the diameter and directly as the square of the velocity. Even for high pressure systems this loss is by no means negligible, since the pipes used are rather small.

The following table gives the loss of head in feet per 100 feet

* Cost per mile laid in average unpaved ground about \$15,000.

of pipe and at a uniform velocity of 3 feet per second. This applies to pipe in good average condition. When the pipe is new and quite clean, the losses may be slightly less. If the pipe is old and incrustated, the above losses may be nearly doubled. Bends and branches still further reduce the working pressure.

Diameter	1"	2"	3"	4"	5"	6"	7"	8"	10"	12"
Loss of Head	4.89	2.44	1.62	1.22	.98	.81	.70	.61	.49	.41

Diameter	14"	16"	18"	20"	22"	24"	26"	28"	40"	36"
Loss of Head35	.32	.27	.25	.22	.20	.19	.17	.16	.13

We may now look into the efficiency of these high pressure hydraulic systems. Of the mechanical horse-power applied to the pump we cannot reasonably hope to get more than 75 per cent as energy stored in the accumulators. Tests on the Marseilles plant have shown 70 to 80 per cent efficiency between the indicated steam power and the accumulators, the former figure at the speeds corresponding to full working capacity. As the pumps were direct acting the difference between brake and indicated HP was presumably very small. The motors can be counted on for about .75 efficiency, and the losses of head in the pipes for any ordinary distribution cannot safely be taken at less than 5 per cent. Hence the full load efficiency is about $.75 \times .75 \times .95 = .53$. The efficiency at full load is thus not far from that of the low pressure system, but at half-load it suffers from the use of piston motors, generally necessary on account of the too high speed of rotary motors at high pressure. At even 500 pounds per square inch pressure the normal speed of a Pelton wheel of say 20 HP would be over 4,000 r. p. m., and could not be greatly reduced without seriously cutting down the efficiency. At half-load the piston motors could not be relied on for over .65 efficiency, reducing the total efficiency, even allowing for greatly lessened pipe loss, to about 45 per cent. On the whole, the hydraulic accumulator system must be

regarded as a very ingenious and occasionally useful freak. It may now and then be useful as an auxiliary in the storage of energy from a very irregular power supply.

The strongest point of hydraulic transmission is its ready adaptability in connection with water supply systems for general purposes. Skilfully installed, as for instance at Geneva, it furnishes convenient, reliable, and fairly cheap motive power. As a distinct power enterprise the high first cost is against it, and the efficiency is never really good. All this applies with even greater force to the special high pressure systems, which suffer from inability to cope with continuous work, thus seriously limiting the possible market. Even for intermittent service the charges are enormously high.

The methods of power transmission already mentioned are then somewhat limited in their usefulness by rather well defined conditions, which make their employment advisable in some cases and definitely inadvisable in general.

III. We may now pass to the pneumatic method of transmitting power, which is far more general in its convenient applicability than either of the others, and which is the only system other than electric which has been extensively applied in practice to the distribution of power in small units, although only short distances have been involved in any of the plants hitherto operated, and the possible performance at long distances is more a subject of speculation than of reasonable certainty. Transmission of power by compressed air involves essentially three elements: An air compressor delivering the air under a tension of from 50 to 100 or more pounds per square inch into a pipe system, which conveys the compressed air to the various motors. These motors are substantially steam engines in mechanical arrangements, and indeed almost any steam engine can be readily adapted for use with compressed air. The compressor itself is not unlike an ordinary steam pump in general arrangement. Its appearance in the smaller sizes is well shown in diagram in Fig. 20. The system was originally introduced about fifty years ago for mining purposes, and owed its early importance to its use in working the drills in the construction of the Hoosac, Mont Cenis, and St. Gothard tunnels. Since then it has come to be used on a

very extensive scale for drilling operations, and recently has also been applied for the distribution of power for general purposes, particularly in Paris, where the only really extensive system of this kind is in operation. Its best field has been and still is in mining operations where the escaping air is a welcome addition to the means of ventilation and where, as a rule, the distances are not great.

Transmission of power by piping compressed air has even for general distribution certain very well marked advantages. The subdivision of the power can be carried on to

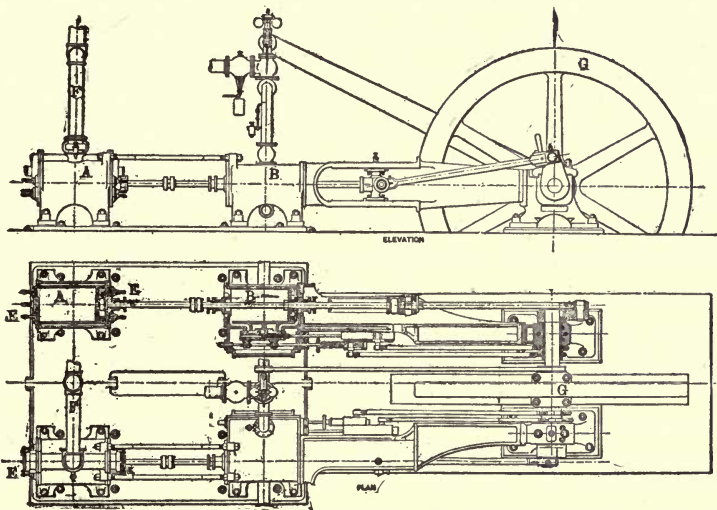

FIG. 20.

almost any extent, and the motors are fairly efficient, simple, and relatively cheap. In addition, the power furnished to consumers can very easily be metered. The loss of energy can be kept within moderate limits, and the mains themselves are not liable to serious breakdowns, although losses from leakage are frequent and may be large. Finally, the system is exceptionally safe. On the other hand, the efficiency of the system, reckoned to the motor pulleys, is unpleasantly low. The mains for a transmission of any considerable length are very costly, and the compressed air has no considerable use aside from motive power, instead of being applicable,

like electric or even hydraulic transmission of power, to divers profitable employments quite apart from the furnishing of mechanical energy. To obtain a clearer idea of the nature of these advantages and disadvantages, let us follow the process of pneumatic transmission from the compressor to the motor, looking into each stage of the operation with reference to its efficiency and economic value.

The compressor is the starting point of the operation. Fig. 20 shows in section a typical direct acting steam compressor, one of the best of its class. It consists essentially of the air cylinder *A* and a steam cylinder *B*, arranged in line and having a common piston rod. The steam end of the machine is simply an ordinary engine fitted with an excellent high speed valve gear worked by two eccentrics on the crank shaft of the flywheels *G*, which serve merely to steady the action of the mechanism. The air cylinder *A* is provided with a simple piston driven by an extension of the steam piston rod.

At each end of the air cylinder are automatic poppet valves *E E*, which serve to admit the air and to retain it during the process of compression. *F* is the discharge pipe for the compressed air leaving the cylinder. In the compressor shown there are two steam and two air cylinders connected with the cranks 90° apart, thus giving steady rotation in spite of the character of the work. In some machines the pistons and piston rods are hollow and provided with means for maintaining water circulation through them, to assist in cooling the air. Round the air cylinder is a water jacket shown in the cut just outside the cylinder wall. The purpose of this is to keep the air, so far as possible, cool during compression, and thus to avoid putting upon the machine the work of compressing air at a pressure enhanced by the heat that always is produced when air is compressed. And just here is the first weak point of the compressed air system. However efficient is the mechanism of the compressor, all heat given to the air during compression represents a loss of energy, since the air loses this heat energy before it reaches the point of consumption. The higher the final pressure which is to be reached, the more useless heating of the air and the lower efficiency. Hence the water jacket, which, by abstracting part of the heat

of compression, aids in averting needless work on the air during compression. Even the most thorough jacketing leaves much to be desired, generally leaving the air discharged at from 200° to 300° F., more often the latter. A cold water spray is often used in the compressing cylinder. This is somewhat more thorough than the jacket, but is still rather ineffective. Both serve only to mitigate the evil, since they cool the air by absorbing energy from it, and at best cool it very imperfectly. A careful series of investigations by Riedler, perhaps the best authority on the subject, gives for the efficiency of the process of compression from .49 to .72. These figures, derived from seven compressors of various sizes and types, include only those losses which are due to heat, valve leakage, clearance, and the like, taking no account of frictional losses in the mechanism. These are ordinarily about the same as in a steam engine, say 10 per cent, so that the total efficiency of a simple compressor may be taken as .44 to .65, the latter only in large machines under very favorable conditions. The most considerable recent improvement in compressors is the division of the compression into two or more stages, as the expansion is divided in compound and triple expansion engines. This limits the range of heating that can take place in any given cylinder, and greatly facilitates effective cooling of the air. Riedler has obtained from two-stage machines of his own design a compressor efficiency of nearly .9. Allowing for the somewhat greater friction in the mechanism, the total efficiency was found to be about .76. In general, then, we may take the total efficiency of the single stage compressors usually employed in this country as .5 to .6, very rarely higher, while the best two-stage compressors may give an efficiency slightly in excess of .75. For steady working, .75 would be an excellent result.

We may next look into the action of the compressed air in the mains. As in the case of water, the frictional resistance and consequent loss of pressure vary directly with the square of the velocity of the air and inversely with the diameter of the pipe. By reducing the one and increasing the other, the efficiency of the line may be increased at the cost of a considerable increase in original outlay. Any attempt to force the

output of the main rapidly increases the losses. At a working gauge pressure of 60 pounds per square inch, which is in very frequent use, the per cent of pressure lost per 1,000 feet of pipe of various diameters is given in the following table — the velocity being taken at 30 feet per second:

Diameter . . .	1"	2"	3"	4"	5"	6"	12"	18"	24"	36"	48"
Per cent loss . .	21.8	10.9	7.8	5.45	4.37	3.66	1.0	0.66	0.5	.33	.25

The friction in the pipes is proportionally greater in small pipes than in large, and this table is taken as correct for the medium sizes. No allowance is made for increase in velocity through a long main, for leakage, nor for draining traps, elbows, curves, and other extra resistances, so that as in practice the larger and longer mains suffer the more from these various causes, the table will not be found widely in error for ordinary cases. Very large straightaway mains will give somewhat better results, and the five last columns of the table are computed from Riedler's experiments on the Paris air mains, 11 $\frac{3}{4}$ inches in diameter and 10 miles long. All losses are included. Losses in the air mains can therefore be kept within a reasonable amount in most cases. With large pipes and low velocities, power can be transmitted with no more loss than is customary in the conductors of an electrical system. Small distributing pipes, however, entail a serious loss if they are of any considerable length.

The motor is the last element of pneumatic transmission to be considered. Generally it is almost identical with an ordinary steam engine; in fact, steam engines have been often utilized for air, and common rock drills may be used indifferently for steam or air with sometimes slight changes in the packing of the pistons and piston rods. Some special air motors are in use with slight modifications from the usual steam engine type. In most of these the air is used expansively and at a fairly good efficiency. Tests by Riedler on the Paris system show for the smaller air motors an efficiency of as high as 85 per cent so far as the utilization of the available

energy in the air is concerned, or, taking into account the mechanical losses, 70 to 75 per cent. Occasional results as low as 50 to 60 per cent were obtained even when the air was used expansively, while if used non-expansively the total efficiency was uniformly below 40 per cent. Tests on an adapted steam engine with Corliss valve gear gave a pneumatic efficiency of .90, with a total efficiency of .81. These figures are under more than usually favorable conditions.

One of the principal difficulties with air motors is freezing, due to the sudden expansion of the compressed air, and the congelation of any moisture carried with it. It is quite useful, therefore, to supply to the motor artificially a certain amount of heat, sufficient to keep the exhaust at the ordinary temperature, especially if the air has been cooled by spray during compression. This heating process is very frequently extended so as not only to obviate all danger of freezing but to add to the output of the air motor by giving to the compressed air a very considerable amount of energy. The air is passed through a simple reheating furnace and delivered to the motor at a temperature of about 300° Fahrenheit. The energy delivered by the motor is composed of that actually transmitted through the mains *plus* that locally furnished by the reheater.

The amount of fuel used is not great, usually from $\frac{1}{2}$ to $\frac{1}{4}$ of a pound of coal per horse-power-hour, and the increase of power obtained is about 25 per cent of that which would otherwise be obtained from the motor. This means that the heat is very effectively utilized. Reheating is not a method of increasing the efficiency of the system, as is sometimes supposed, but a convenient way of working a hot air engine in conjunction with an initial pressure obtained from air mains. It increases the operating expense by a very perceptible though rather small amount, and gains a good return in power. In so far it is desirable, but it no more increases the *efficiency* of the pneumatic transmission than would power from any other source added to the power actually transmitted.

We are now in a position to form a clear idea of the real efficiency of transmission of power by compressed air. Taking the compressor and motor efficiencies already given, and assuming 10 per cent loss of energy in the mains, we have for the

total efficiency from indicated horse-power at the compressor to brake-horse-power at the motor: $.75 \times .90 \times .80 = .54$ for large two-stage compressors and large motors; while with ordinary apparatus it would be about $.70 \times .90 \times .75 = .47$. At half-load these figures would be reduced to about .45 and .35 respectively. In operating drills, which are motors in which the air is used non-expansively and to which the air is carried considerable distances through small pipes, the total efficiency is almost always below rather than above .30. The efficiency of .54 given above cannot well be realized without recourse to artificial heating to enable the air to be used expansively without trouble from freezing.

Compressed air has been mainly used for mining operations, where its entire safety and its ventilating effect are strong points in its favor. More rarely it is employed for general power purposes. Of such use the Popp compressed air system in Paris is the best and the only considerable example.

This great work started from a system of regulating clocks by compressed air established a quarter-century ago. Nearly a decade later the use of the compressed air for motors began, and after several extensions of the old plant the present station was built. It contains four 2,000 HP compound compressors, of which three are regularly used and the fourth held in reserve. The steam cylinders are triple expansion, worked with a steam pressure of 180 pounds. The air pressure is 7 atmospheres, and the new mains are 20 inches in diameter, of wrought iron. There are in all more than 30 miles of distributing main, most of it of 12 inches and under in diameter. A very large number of motors of sizes from a fan motor to more than 100 HP are in use. Their total amount runs up to several thousand HP, even though the majority of them are less than a single horse-power. Except in very small motors, reheaters are used, raising the temperature of the air generally to between 200° and 300° F. The efficiency of the whole system from Professor Kennedy's investigations is about 50 per cent under very favorable conditions. The prices charged for power have not been generally known, but are understood to be somewhat in excess of \$100 per horse-power per working year. An interesting addition to the apparatus of pneumatic trans-

mission has recently appeared. It is a modification of the ancient "trompe," or water blast, used for centuries to feed the forges of Catalonia, very simple in operation and cheap to build. In its present improved form it is known as the Taylor Hydraulic Air Compressor, and an initial plant of very respectable size has been in highly successful operation for some five years past at Magog, P. Q., from which the data here given have been obtained.

The compressing apparatus which is shown in Fig. 21 is in principle an inverted siphon having near its upper end a series of intake tubes for air, and at the bend a chamber to collect the air which, entrained in the form of fine bubbles, is carried down with the water column, which flowing up the short arm of the siphon escapes into the tail race. In Fig. 21, *A* is the penstock delivering water to the supply tank *B*. In this tank is the mouth of the down tube *C*, contracted by the inverted cone *C* so as to lower the hydraulic pressure and allow ready access of air from the surrounding apertures. The air bubbles trapped in the water sweep down *C*, which expands at the lower end, and finally enters the air tank *D*. Here the water column encounters the cone *K*, which flattens into a plate at the base. Thus spread out and escaping into the air chamber by the circuitous route shown by the arrows, the air bubbles from the water accumulate in the top of the air tank, while the water itself rises up the shaft *E*, and flows into the tail race *F*. The air in *D* is evidently under a pressure due to the height of the water column up to *F*, and quite independent of the fall itself, which consequently may vary greatly without affecting the pressure of the stored air, a very valuable property in some cases, as in utilizing tidal falls. From *D* the compressed air is led up through a pipe, *P*, for distribution to the motors. To get more pressure, it is only necessary to burrow deeper with the air tank, not a difficult task where easy digging can be found. The fall and rate of flow determine the rate at which the air is compressed, and contrary to what might be supposed, the process of compression is quite efficient. It is quite sensitive to variations in the amount of flow, the efficiency changing rapidly with the conditions of inlet; and since there certainly is a limit to the

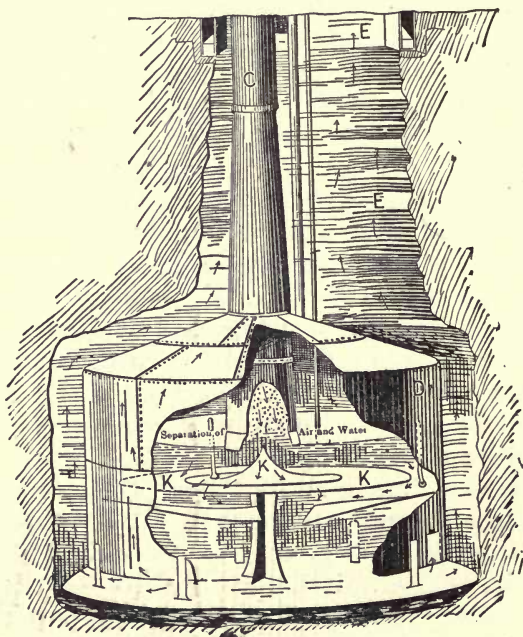
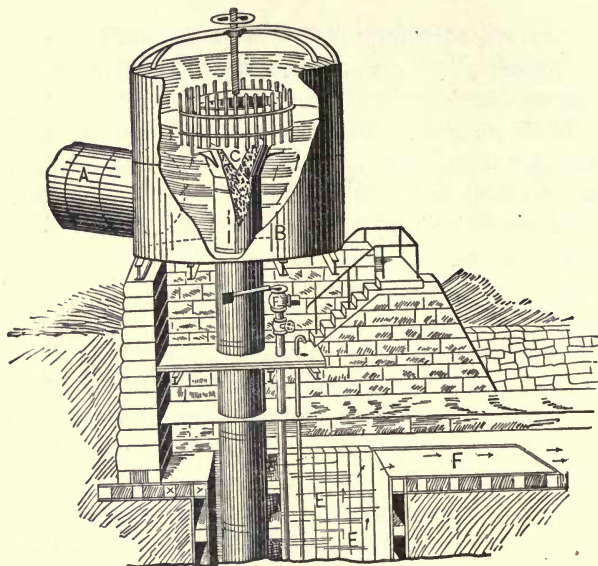

FIG. 21.

amount of air that can be entrained in a given volume of water, the process is likely to work most efficiently at moderate heads and with large volumes of water. In the Magog compressor about 4 cubic feet of water are required to entrain 1 cubic foot of air at atmospheric pressure, and it is open to question as to how far this ratio could be improved. This ratio, too, would be changed for the worse rapidly in attempting high compression, so that the Magog results probably represent, save for details, very good working conditions. The dimensions of the Magog apparatus are given in the accompanying table, which is followed by the details of one of the tests made by a very competent body of engineers.

The general dimensions of the compressor plant are:

Supply penstock	60 inches diameter
Supply tank at top	8 feet diameter by 10 feet high
Air inlets (feeding numerous small tubes)	34 2-inch pipes
Down tube	44 inches diameter
Down tube at lower end	60 inches diameter
Length of taper in down tube, changing from 44-inch to 60-inch diameter	20 feet
Air chamber in lower end of shaft	16 feet diameter
Total depth of shaft below normal level of head water	about 150 feet
Normal head and fall	about 22 feet
Air discharge pipe	7 inches diameter
Flow of water, cubic feet, minute	4292.
Head and fall in feet	19.509
Gross water HP	158.1
Cubic feet compressed air per minute, reduced to atmos- pheric pressure	1148.
Pressure of compressed air, lbs.	53.3
Pressure of atmosphere, lbs.	14.41
Effective work done in compressing air, HP	111.7
Efficiency of the compressor, per cent	70.7
Temperature of external air, Fahr.	65.2
Temperature of water and compressed air, Fahr.	66.5
Moisture in air entering compressor, per cent of saturation	68.
Moisture in air after compression, per cent of saturation	35.

The efficiency given is certainly most satisfactory, being quite as high as could be attained by a compound compressor of the best construction driven by a turbine, and for the head in question at a very much lower cost. It is probable that

the test given does not represent the best that can be done by this method, and the indications are that within a certain, probably somewhat limited, range of heads the hydraulic compressor will give as compressed air a larger proportion of the energy of the water than any other known apparatus. Just what its limitations are, remains to be discovered, but several plants are now under construction which will throw considerable light upon the subject.

In certain cases the power of getting compressed air direct from hydraulic power by means of a simple and, under favorable conditions, cheap form of apparatus, is very valuable, and while it is unlikely to change radically the status of pneumatic transmission, it is an important addition to available engineering methods. As in most pneumatic plants, the Magog installation is worked in connection with reheaters. A similar plant on a somewhat larger scale is in successful operation near Norwich, Conn.

IV. In point of convenience and efficiency, compressed air is nearer to electricity for the distribution of power over large areas than any other method. The only other system that approaches them is the transmission of gaseous fuel for use in internal combustion engines. At equal pressures one can send through a given pipe twenty times as much energy stored in gas as in air. A good air motor requires about 450 cubic feet of air at atmospheric pressure per indicated HP hour, while a gas engine will give the same power on a little over 20 cubic feet of gas. But the cases wherein the distribution of gas would be desirable in connection with a transmission over a long line of pipe are comparatively few. Particularly this system has no place in the development of water-powers, the most important economic function of electrical transmission. Nevertheless it must be admitted that for simple distribution of power a well-designed fuel gas system is a formidable competitor of any other method yet devised, particularly in the moderate powers — say from 5 to 25 HP.

We are now in a position to review the divers sorts of power transmission that have been discussed, and to compare them with power transmission by electricity.

Without going deeply into details, which will be taken up in

due course, we may say that electrical machinery possesses one advantage to an unique extent — high efficiency at moderate loads. Machinery in which the principal losses are frictional is subject to these in amount nearly independent of the load; hence the efficiency drops rapidly at low loads. In dynamos, motors, and transformers, however, the principal losses decrease rapidly with the load, so that within a wide range of load the efficiency is fairly uniform. Fig. 22 gives the efficiency curves for a modern dynamo, motor, and transformer. The

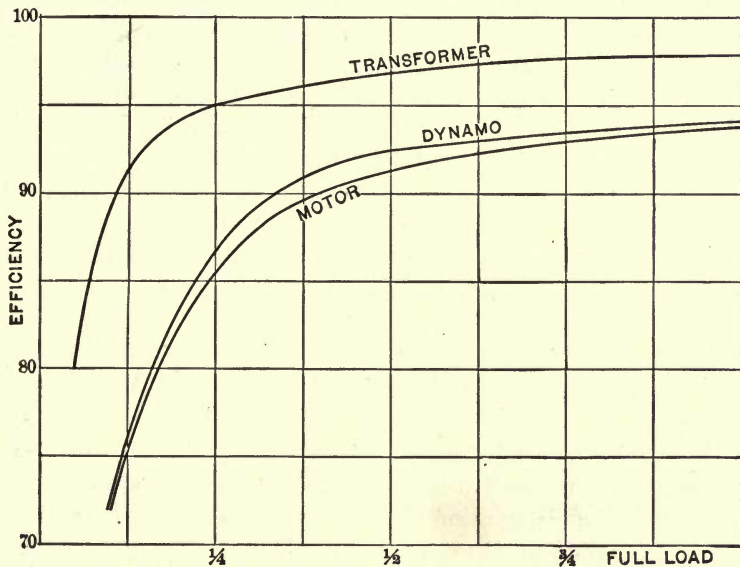

FIG. 22.

generator curve is from a 200 KW 500-volt direct-current machine, the motor curve from a smaller machine of the same type, and the transformer curve from a standard type of about 30 kilowatts capacity. In the generator curve the variation of efficiency from half load to full load is less than 2 per cent, in the motor only $2\frac{1}{2}$ per cent, and in the transformer just $1\frac{1}{2}$ per cent. In addition, the efficiency of all three at full load is very high. Hence, not only is an electrical power transmission of great efficiency if the loss in the line be moderate, but this efficiency persists for a wide range of load. As

in hydraulic and pneumatic transmission, the efficiency of the line depends on its dimensions; so that by increasing the weight of copper in the line, the loss of energy may be decreased indefinitely. And since the loss of energy in the line diminishes as the square of the current, the percentage of loss at constant voltage diminishes directly with the load.

Hence, the total efficiency may be constant or even increase from half load to full load, even with a quite moderate loss in the line. In pneumatic and hydraulic transmission this condition may occur, but only with large loss in the mains, since the efficiencies of the generator and motor parts of such systems decrease too rapidly to be compensated by the gain in the main, unless its efficiency is low at full load. Hence, for ordinary cases of distribution in which the average load is considerably less than full load, often only $\frac{1}{3}$ to $\frac{1}{2}$ of full load, electric transmission has a very material advantage over all other methods. To appreciate this we need only to run over the details of electrical power transmission and compare the results with those which we have obtained for the other methods described.

There are to be considered in electrical power transmission, as in transmission of every sort, two somewhat distinct problems:

First, the transmission of energy over a considerable distance and its utilization in one or a few large units.

Second, the distribution of power to a large number of small units at moderate distances from the centre of distribution. This latter case may sometimes also involve the transmission of power to a real or fictitious centre of distribution. This second problem is the commoner, and, while not so sensational as the transmission of power at high voltage over distances of many miles, is of no less commercial importance.

We have all along been considering, in treating of transmission of power by ropes and by hydraulic and pneumatic engines, the case first mentioned, excepting in so far as some special distributions have been referred to. We have already the data for figuring the efficiency of an electric power transmission with large units. In cases of this kind the distance between the generator and motor is likely to be much greater than in

the case of distribution to small motors from some central point, and the loss in the line, the only uncertain figure in the transmission, would generally range from 5 to 10 per cent. In case of distributing plants intended to furnish from a single point small units of power over a moderate distance, it is generally found that losses in the line of from 2 to 5 per cent do not involve excessive cost of copper. In cases where a distribution is coupled with the transmission of power to the central point, the loss from the distant generator to the motors is in most cases from 10 to 15 per cent.

Taking up first the transmission of power from one or more large generators to one or more large motors, we may take safely the commercial efficiency of the generator as that given by the curve, Fig. 22, and that of the motors as at least as good as that given for a motor in the same figure. The efficiency of the line for moderate distances may be taken as 95 per cent. It should be noted that the efficiencies of large alternating generators and motors do not differ materially from those shown; in fact, are quite certain to be above them. We thus have for the efficiency in a transmission of this kind: $94 \times 95 \times 93 = 84$ per cent. This is largely in excess of that which could be obtained at distances of say a couple of miles by any other method of transmission.

Even more extraordinary is the efficiency at half load in this case, which is $92 \times 97.5 \times 91 = 81.6$ per cent. It should be borne in mind that these efficiencies are taken from experiments with ordinary machines, and the efficiencies are those which can be bettered in practice. These results show the great advantage to be derived from electrical transmission when, as in most practical cases, full load is seldom reached. It is most important for economical operation to employ a system which will give high efficiency at low loads, and it would be worth while so to do even if the efficiency at full load were not particularly good. With electrical machinery, however, there is no such disadvantage. Even at one-fourth load the efficiency of the electrical system still remains good. It is nearly 73 per cent on the assumed data. The efficiencies thus given are from the shaft of the generator to the pulley of the motor inclusive.

In the case of distributed motors supplied from a central point not very distant from any of them, the efficiencies of generator and line remain about as before, but the motor efficiencies for the sizes most often employed are below that just given. The average motor efficiency is largely dependent on the skill with which the units are distributed. It has often been proposed to drive separate machines by individual motors, while in other cases comparatively long lines of shafting are employed, grouping many machines into a dynamical unit operated by a motor. To secure economy it is desirable on the one hand to use fairly large motors well loaded, while on the other hand the losses in shafting and belting must be kept down.

The larger the motors, the better their efficiency at all loads and the less the average cost per HP, but with small motors the cost and inefficiency of shafts and belts may be in large measure avoided. The most economical arrangement depends entirely upon the nature of the load. Much may be said in favor of individual motors for each machine, but so far as total economy is concerned, this practice is best limited to a few cases — machines demanding several HP (say 5 or more) to operate them, machines so situated as to necessitate much loss in transmitting power to them, and certain classes of portable machines. In applying electric power to workshops already in operation, the group system will usually give the best results, individual motors being used only for such machines as might otherwise cause serious loss of power. The following table gives the average full load efficiencies that may safely be expected from motors of various sizes, irrespective of the particular type employed.

HP of motor . .	1	3	5	7½	10	15	20	25	40	50	75
Per cent efficiency	72	78	81	83	85	86	87	88	90	90	92

These are commercial efficiencies reckoned from the electrical input to the mechanical output at the pulleys. Below 5 HP the efficiencies fall off rapidly. At partial loads the efficiencies

are somewhat uncertain, inasmuch as some motors are designed so as to give their maximum efficiency at some point below full load, while others work with greater and greater efficiency as the load increases until heating or sparking limits the output. The former sort are most desirable for ordinary workshop use, while the latter are well suited to intermittent work at very heavy loads, as in hoisting. The difference in the two types of machine is very material. It is easily possible to procure motors that will not vary more than 5 per cent in efficiency from full load to half load, and this even in machines as small as 2 or 3 HP. We may now calculate the efficiency of an electric distribution with motors of moderate size — such a case as might come from the electrical equipment of large factories. The generator efficiency may be taken as before at .94 and that of the line at .95, while the motors must be taken close account of in order to estimate their collective efficiency. Assuming the sizes of motors in close accordance with those in several existing installations of similar character, we may sum them up about as follows:

5	3 HP
5	5 HP
10	10 HP
10	20 HP
5	25 HP
2	50 HP

In all 37 motors, aggregating 565 HP. The mean full load efficiency of this group is very nearly .87. The efficiency of the system is then

$$.94 \times .95 \times .87 = 77.6.$$

This result requires full load throughout the plant, a somewhat unusual condition with any kind of distribution. From the data already given, the half load efficiency should be about

$$.92 \times .975 \times .82 = .735.$$

Between the limits just computed should lie the commercial efficiency of any well-designed motor distribution reckoned from the dynamo pulley. In the case of steam-driven plants it is often desirable to consider the indicated HP of the engine as the starting point, and the question immediately arises as

to the commercial efficiency of the combination of dynamo and engine. In cases where high efficiency is the desideratum direct coupling is usually employed, saving thereby the loss of power, perhaps 5 per cent, produced by belting. The losses in such direct-coupled units vary considerably with the size and type of both machines. Fig. 23 shows the efficiency of two such combinations at various loads. Curve *A* is from an actual test of the combination; curve *B* from tests of an engine and dynamo separately. Each unit was of several

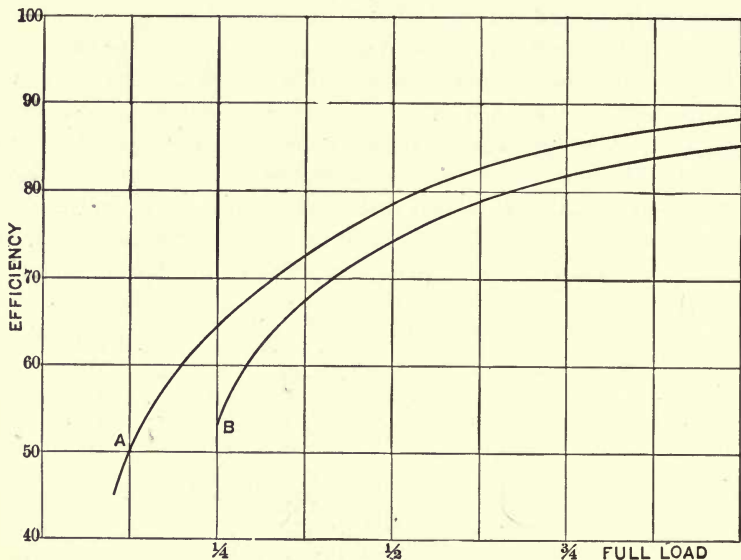

FIG. 23.

hundred HP. The high result from curve *A* is mainly due to very low friction.

These curves give handy data for computing the total efficiency of a motor plant from the motor pulleys to the indicated horse-power of the driving engine. Taking the combined engine and dynamo efficiency from *A*, and assuming the same figures as before on motors and line, we have at full load,

$$.88 \times .95 \times .87 = .727.$$

And from the same data at half load,

$$.78 \times .975 \times .82 = .651.$$

For certain computations, as in case of figuring out a complete installation, the above efficiencies are convenient. They show that in very many instances the distribution of power by electric motors is very much more economical of energy than any other method employed. In ordinary manufacturing operations power is generally transmitted to the working machines through the medium of lines of shafting of greater or less length. These are very rarely belted directly to the machines, but transfer power to them through one or more countershafts. Often the direction of shafts is changed by gearing or quarter turn belts, and even when the power is distributed through only a single large building there will be found more often than not, intervening between the driving engine and the driven machine, three belts and two lines of shafting of considerable length, and not infrequently still other belts and shafts. It very often happens, too, that to keep in operation one small machine in a distant part of the shop, it is necessary to drive a long shaft the friction of which consumes half a dozen times as much power as is actually needed at the machine. The constant care required to keep long lines of shafting in operative condition is an irritating and costly concomitant. The necessary result is a considerable loss of power, which, being nearly constant in amount, is very severe at partial loads.

Allowing 5 per cent loss of energy for each transference of power by belting, a figure in accordance with facts, and 10 per cent loss for each long line shaft driven, it is sufficiently evident that from 20 to 25 per cent of the brake-horse-power delivered by the engine must be consumed even under very favorable circumstances by the belting and shafting at full load. This means an efficiency at half-load of from 50 to 60 per cent only, and at lesser loads a very low efficiency indeed.

The large number of careful experiments carried out on shafting in different kinds of workshops, and under various conditions, shows that only under very exceptional circumstances is the loss of power by shafting between the engine and the driven machines as low as 25 per cent. Far more often it is from 30 to 50 per cent, and sometimes as high as 75 or 80 per cent. The figures, which have been well estab-

lished, regarding the efficiency of the transmission of power by motors, show that at full load it is comparatively easy to exceed 75 per cent efficiency; thus more than equalling the very best results that can be obtained with shafting. At half-load and below, the advantage of the electric transmission becomes enormous, even supposing shafting to be at its very best.

Compared with ordinary transmission by shafting, the motor system is incomparably superior at all loads, so that it may easily happen that a given amount of work can be accomplished through the medium of a motor plant with one-half the steam power required for the delivery of the same power through shafts and belts. Such results as this have actually been obtained in practice. It is, therefore, safe to conclude that the distribution of power by motors is, under any ordinary commercial conditions, at least as efficient as the very best distribution of power by shafting at full load, and much more efficient at low loads. Under working conditions in almost all sorts of manufacturing establishments, light loads are the rule and full loads the rare exception; consequently the results of displacing shafting by motor service have, as a rule, been exceedingly satisfactory in point of efficiency, and the lessened operating expense more than offsets the extra cost of installation.

In one early three-phase plant, that of Escher, Wyss & Co. at Winterthur, Switzerland, 300 HP in 32 motors worked from a 12-mile transmission line displaced far greater capacity in steam engines, and similar results on a smaller scale are not uncommon.

To add force to this comparison between the efficiency of shafting and of motors, the following results from electrical distribution plants already installed may be pertinent. A typical example of the sort is from a plant installed some years since in a fire-arms factory at Herstal, Belgium. There were there installed 17 motors of an aggregate capacity of 305 HP, driven by a 300-KW generator direct-coupled to a 500-HP compound-condensing engine. The efficiency guaranteed from the shaft of dynamo to the pulleys of the motors is 77 per cent. Since its first installation, the plant has been increased by the

addition of a second direct-coupled dynamo and the total horsepower of motors is 428. A second notable installation of motors in the same vicinity is at the metallurgical works of La Société de la Vielle-Montagne, consisting of a 375-KW 500-volt dynamo direct driven at a speed of 80 revolutions per minute by a 600-HP compound-condensing engine. The plant consists of 37 motors with an aggregate HP of 329. The full load efficiency of the plant from dynamo shaft to motor pulley is 76 per cent. The loss in the lines, both in this case and in the preceding, is very small, only 2 per cent. They are both typical cases of transmission to motors driving groups of machines, and in spite of rather low dynamo efficiencies at full load, these being in each case 90 per cent, the results obtained are in close accordance with those already stated as appropriate to similar cases. As an example of work under more favorable conditions, the early three-phase power plant at Columbia, S. C., may be instanced.

The problem here undertaken was to drive a very large cotton mill, utilizing for the purpose a water-power about 800 feet distant. Two 500-KW dynamos direct-coupled at a speed of 108 turns per minute deliver current at 550 volts to an underground line connecting the power station with the mills. The motors are suspended from the ceiling, and each drives several short countershafts. The motors are wound for the generator voltage without transformers, and are of a uniform size, 65 HP each. The commercial efficiency of this plant, taken as a whole from the shaft of the dynamo to the pulleys of the motors, is not less than 82 per cent at full load. This good result is due to the use of large motors, and to the small line loss of 2 per cent as in the preceding foreign examples. These results are thoroughly typical, and can regularly be repeated in practice. In general a net efficiency of 80 to 85 per cent can be counted upon in plants of the approximate size of those here mentioned, assuming the apparatus now commercially standard. Even smaller plants can be counted on to give nearly or quite as good results, since the difference in efficiency, supposing motors of the same size to be used, between a dynamo of 100 KW and one of 400 or 500 KW is hardly more than 1 per cent at full load, supposing machines

of the same general design to be employed, nor is there any substantial difference in efficiency between plants employing direct current and those using polyphase apparatus, as may be judged from the figures just given.

We are now in position intelligently to compare the transmission and distribution of power by electric means with the other methods which have sometimes been employed.

All comparisons between methods of transmitting power have to be based in a measure on their relative efficiency. Now, in every such method there are three essential factors: 1st, the generating mechanism, which receives power direct from the prime mover and in conjunction with which it is considered; 2d, the transmitting mechanism, which may be an electric line, a pipe line, ropes, or belts; and 3d, the motor part of the transmission, which receives power from the transmitting mechanism and delivers it for use. For a given capacity of the generating and receiving mechanisms, the efficiency of each at all loads is determined within fairly close limits. The transmitting mechanism, however, is not so closely determined, save in the case of the rope drive.

Electric, pneumatic and hydraulic transmission lines are all subject to the general principle that the loss in transmission can be made indefinitely small by an indefinitely large expenditure of capital, enormous cross-section in the one case, or huge pipe lines in the others. The efficiency of these methods is, therefore, a fluctuating quantity depending on that loss in the transmitting mechanism which may be desirable from an engineering or economical standpoint. In making comparisons between these methods, there is a wide opportunity for error unless some common basis of comparison is predetermined. In the next case any such comparison must differ widely in its results according to the character of the power distribution which is to be attempted. We have already seen that with the rope drive, distribution is very difficult, while with electric and pneumatic systems it is comparatively easy.

A general valuation of the commercial possibilities of these divers matters is, therefore, hard to make except in a general way. We can, however, by assuming a given transmission of

given magnitude and character, and further assuming such loss in the transmitting mechanism as might reasonably be expected in practice, arrive at a reasonably accurate conclusion for the case considered. As a very simple example of power transmission, let us take the delivery of power over a distance of two miles, the delivery being in one unit or, at most, two units. We will assume the same indicated HP furnished at the generating end of the line in each case, of which as much as possible is to be delivered at the receiving station, the losses in transmission being taken as 10 per cent of the power delivered to the line; this is to cover all losses of energy by resistance and leakage on the electrical line or loss of pressure and resulting expenditure of energy, leakage, friction, and all other sources of loss in the other cases.

As the same indicated power is generated in each case, we will suppose a modern plant with compound condensing engines costing complete with buildings \$50 per HP. We will further assume that each indicated horse-power per working year of 3,000 hours will cost \$18; this covering all expenses except those chargeable to interest and depreciation. For this simple case we have the following costs of initial plant and of operation per mechanical horse-power delivered from the motor, full load only being considered. The four methods considered are rope driving, pneumatic, pneumatic with reheating apparatus at the motors, and electrical. The prices are from close estimates of the cost in each case. The dynamos are supposed to be direct-coupled. The compressors to be direct-acting, two-stage compressors. The steam cylinders Corliss compound-condensing type. The air-pressure assumed is 60 lbs. above atmospheric pressure. The electric voltage 3,000. The rope speed about one mile per minute. Interest and depreciation are taken at 10 per cent of the total cost of the plant, save in the case of the rope drive, where an additional charge for renewal of cable is made on the supposition that the cable will last somewhere from 18 months to 2 years, which is fully as favorable a result as can fairly be expected. The following are the comparative estimates:

ROPE, EFFICIENCY 67 PER CENT.

COST.

Steam plant	\$50,000
Pulley stations	25,000
Cables, steel	17,000
Total cost	<u>\$92,000</u>

OPERATING EXPENSE.

1,000 I.H.P at \$18	\$18,000
Interest and depreciation on plant, at 10 per cent	7,500
Depreciation of cable	8,000
	<u>\$33,500</u>

Net HP produced, 672.

Cost per HP-year, \$49.

PNEUMATIC, EFFICIENCY 54 PER CENT.

COST.

Steam plant, excluding engines	\$35,000
Compressors	17,000
Air mains laid, 12 inches	18,000
Air motors	12,000
Total cost	<u>\$82,000</u>

OPERATING EXPENSE.

1,000 I.H.P at \$18	\$18,000
Interest and depreciation, at 10 per cent	8,200
	<u>\$26,000</u>

Net HP delivered, 540.

Cost per HP-year, \$48.

AIR REHEATED, APPARENT EFFICIENCY 65 PER CENT.

COST.

Steam plant, excluding engines	\$35,000
Compressors	17,000
Air mains laid	18,000
Air motors and reheaters with chimney, etc.	14,000
Total cost	<u>\$84,000</u>

OPERATING EXPENSE.

1,000 I.H.P at \$18	\$18,000
Interest and depreciation, at 10 per cent	8,400
Coal and labor for reheating	1,500
	<u>\$27,900</u>

Net HP delivered, 650.

Cost per HP-year, \$43.

ELECTRIC, EFFICIENCY 73 PER CENT.

COST.

Steam plant	\$50,000
Dynamos	18,000
Line	3,000
Motors	13,000
Total cost	<u>\$84,000</u>

OPERATING EXPENSE.

1,000 I.HP at \$18	\$18,000
Interest and depreciation, at 10 per cent	8,400
Electrician	1,500
	<u>\$27,900</u>

Net HP, 730.

Cost per HP-year, \$38.

It appears at once that the rope drive is beyond the range of its efficient use. Its first cost is greater than that of either of the other methods, and the expense is carried to a very high figure by the item of depreciation on the cables, which cannot be avoided; hence in spite of a high efficiency, the cost per HP year delivered rises to \$49. We may next consider the schedule of cost for the pneumatic system. In this case the most formidable item is the cost of the air-mains, which should be at least 12 inches in diameter. Nevertheless, the total initial cost is the lowest of the four. The operating expense is also the lowest, but the very low efficiency of the pneumatic system without reheating raises the cost per HP delivered to a very considerable amount — almost as much as in the case of the rope drive. Reheating would almost always be used in connection with a plant of this size, and with reheating the result is much more favorable. The initial expenditure is somewhat increased by the addition of the reheaters, piping and chimney. The operating expense is also slightly increased by the coal necessary for reheating, taken at $\frac{1}{4}$ of a pound per HP per hour, and the small amount of additional labor involved in caring for the reheaters, disposing of the ashes, and looking after the reheating plant generally. The apparent efficiency in this case is very excellent, 65 per cent being reasonably attainable, and the cost per HP year falls to \$43, showing conclu-

sively enough the advantage of reheating; at least, where the units are so large that the presence of a reheater is not a practical nuisance.

Finally, we come to the electric power transmission. In this case the most striking feature is the low cost of the line, supposed here to be overhead. It may be noted, however, that an underground line, consisting of cable laid in conduit, still leaves the cost per HP year lower than that of any of the other methods. Operating expense is fairly increased by the addition of an electrician to the cost of the indicated horse-power, interest, and depreciation. The total first cost is practically the same as that of air with reheater, as is also the operating expense. The added efficiency, however, brings the cost per HP year to \$38; decidedly the lowest of the four cases considered. It may be thought that difference of loss in transmission might possibly alter the relation of the electric plant to the air-plant with reheaters, but an added efficiency of line would in either case be accompanied by added expenditure of not very different amounts in the two cases, and the efficiency of the electric plant would always be enough higher than that of the air-plant to give it the advantage in net cost per HP, however the two plants might be arranged. We thus find that at a distance of two miles the electric transmission has a material advantage, air with reheaters, air without reheaters, and rope drive following it in the order named. The pneumatic method would at the distance of one mile, as may readily be computed, take about the same relative position as before, since the efficiency maintains approximately the same relation to the others.

The pneumatic plant gains in first cost at this lesser distance, not enough, however, to alter the final result. At half a mile distance, the rope drive will be found to be the cheapest in first cost, and also, through its enormous efficiency, to be a little the cheapest per HP delivered, in spite of the large depreciation in the cables, while the electric and pneumatic systems would be very close together, the electric, however, still retaining a slight advantage due to its greater efficiency. Neither can, in point of absolute cost of power delivered, compete with the rope drive at this distance for

this simple transmission at full load, although both would surpass it were there any considerable distribution of the power. Figures that have heretofore been given on the relative cost and efficiency of such transmissions have as a rule been in error in two very essential particulars: first, the efficiencies of the electrical system have been greatly underestimated owing to the poor machines with which the first experiments were made; second, the commercial advantage of reheating in the pneumatic transmission has not generally been given its proper weight. It is, as has been already stated, not a method of increasing the efficiency, but of increasing the power delivered by addition of energy at the receiving end of the line under very favorable conditions. The figures just given are believed to be as nearly exact as roughly assumed conditions permit.

One modification in the electric transmission should here be noted. The recent introduction of the steam turbine has rendered it possible to lower the cost of the generating plant very materially, while retaining a cost of power at the prime mover not in excess of that here given. The generating unit also comes in for some reduction in the combined frictional loss, so that the final cost per HP year would on the basis here taken probably fall to \$35 or \$36, giving the electrical system a still greater advantage. This statement does not mean broadly that a turbo-generator can regularly deliver power six or eight per cent cheaper than an ordinary generating set, but merely that it would probably do so under the circumstances here assumed.

All these estimates are subject to change of prices from year to year, but no changes are likely to be sufficient to alter the relative position of the methods compared as regards cost. It is not a difficult matter to construct a set of estimates arranged to favor any given method. In the long run, whatever minor variations may appear in the items here given, the totals will be found to scale up or down in about the same ratios.

At less than full load and hence under variable loads, the electric system enjoys the unique advantage of having the losses of energy in every part of the system decrease as the load

decreases, while in rope driving all the losses are practically constant, and in the hydraulic and pneumatic systems all are nearly constant save that in the pipe-line.

Hence, under low and varying loads, electric transmission has a great additional advantage. Since in distributions of power employing a considerable number of motors light load on the motors is the invariable rule, as soon as we depart from the very simple case discussed the electrical system gains in relative economy at every departure. These more general cases have already been described, and gathering the results we may construct the following table, showing the efficiency of each system under full and half-loads:

System.	Full Load.	Half Load.
Wire rope	67	46
Hydraulic high pressure	53	45
Hydraulic low pressure	50	50
Pneumatic	50	40
Pneumatic reheated (virtual efficiency)	65	50
Electric	73	65

The efficiencies in the electric system as here given are lower than would be reached practically in large plants. The present practice of using generators and motors wound for pressures up to 10,000 or 12,000 volts makes a most material difference in the matter of efficiency. For a well-designed transmission of a few miles in units of say 500 KW and upwards, one may fairly expect to get at full load as much as 94 per cent from generator and motor, and perhaps 98 per cent from the line, giving a total efficiency of transmission of

$$.94 \times .94 \times .98 = .866$$

at full load and of nearly .85 at half-load or say 79 and 72 per cent respectively when reckoning efficiency from the indicated HP of the engine as in the foregoing comparisons. This means far higher efficiency than can be obtained by any other method at any but the shortest distances.

All the figures must be taken as approximate. They are under conditions fairly comparable except in case of the low-

pressure hydraulic system, in which the large proportion of loss due to pipe-friction operates to hold up the half-load efficiency to an abnormal degree. With the ordinary proportion of small motors this half-load efficiency would be nearer 40 than 50 per cent. The electric system is easily the most efficient at any and all loads. Of the others, wire-rope transmission, if the distributed units are fairly large, holds the second place for short distances, and the pneumatic system with energy added at the motors by reheating, at moderate and long distances. Without reheating it occupies the last place in order of efficiency, although even so, it is, next to electricity, the most convenient method of distributing power.

In fact, electricity and compressed air are the only two systems available for the general distribution of energy. The latter is, save for a single system in Paris, used only on a small scale, and in this country hardly at all save in mining. Of course, the very largest power stations are those belonging to electric railway systems in the largest American cities. Several of these exceed 50,000 HP in generator capacity and frequently in actual output, notably the systems in Boston, Brooklyn, and Philadelphia. Recent advances in electrical engineering, particularly the effective utilization of alternating currents, have greatly cheapened the distribution of electrical energy, and other systems are now seldom installed for ordinary purposes. A few pneumatic and hydraulic plants will continue to be used, owing to the large capital already invested in them, but new work is, and in the nature of things must be, almost exclusively electrical. As the transmission of power from great distances becomes more common and the radii of distribution themselves increase, the electrical methods gain more and more in relative value, and all others become more inefficient and impracticable.

We have now discussed in some detail the sources of natural energy which are available for human use, and the most prominent of the systems employed for their utilization. We have found that for practical purposes steam-power and water-power must at present be used to the virtual exclusion of all others, the former perhaps less than the latter save for distribution of power over short distances.

Of the methods of distribution we have found all save compressed air and electricity very limited in their application, the hydraulic systems to special classes of work under favorable topographical conditions, and rope transmission to extremely short distances and small numbers of power units delivered. Both are noticeably inefficient. The pneumatic system is very general in its applicability, but of very low intrinsic efficiency. When used in connection with reheating apparatus it requires additional care, and the motors, like steam-engines, are heavy and inconvenient. The electric system on the other hand employs motors which are compact and far more efficient than any other type of machine for delivering mechanical power, run practically without attention, and can be placed in any situation or position that is convenient. Furthermore, in average working efficiency the electric system is 10 to 15 per cent higher than any other yet devised, so that it is more economical in use at nearly all distances and under nearly all conditions. Finally, it unites with power distribution the ability to furnish light and heat, thus gaining an immense commercial advantage. This advantage is shared only by gas transmission, which up to the present time remains of doubtful value on account of the cost of the motors, their imperfect regulation, and their inefficiency at moderate loads. Gas transmission, however, is likely to grow in importance, owing to the great improvements in small gas-engines stimulated by the rapid development of the automobile. Having now overlooked the advantages of electrical power, it is proper to pass to the details of the methods employed for its utilization, and thence to the general problem of its economical generation, transmission and distribution.

CHAPTER III.

POWER TRANSMISSION BY CONTINUOUS CURRENTS.

UP to the present time the larger part of electrical power transmission has been done by continuous currents. All the earlier plants were of this type, and even now, when transmission by alternating currents, polyphase and other, is generally used, the older type of apparatus is still being installed on an extensive scale, and on account of the large number of plants now in operation, even if for no other reason, will probably remain in use for a long time to come. New power transmission plants, both here and abroad, are, save for rare exceptions, for alternating currents, and in many cases this practice is almost absolutely necessary, but there still remain many cases wherein the conditions are as well met in the old-fashioned way.

Chief among these may be mentioned electric railway work, which in America alone certainly requires more than a full million horse-power in generators and motors. Certain difficult work at variable speed and load, and many simple transmissions over short distances, are at present best handled by continuous current machinery. As alternating practice advances, many, perhaps all, of these special cases will be eliminated, but we are dealing with the art of power transmission as it exists to-day, and hence continuous current working deserves consideration.

The broad principle of the continuous current generator has already been explained, but its modifications in actual work are important and worthy of special investigation. In a general way, continuous currents are almost always obtained by commuting the current obtained from a machine which would naturally deliver alternating currents. This process is, however, by no means as simple as Fig. 9 would suggest. With a two-part commutator the resulting current, although unidirectional, would necessarily be very irregular, owing to the fact

that the total current drops to zero at the moment of commutation. Such a current is ill fitted for many purposes, and the commutator would be rapidly destroyed by sparking if the machine were of any practical size.

To avoid these difficulties, the number of coils on the armature is increased, and they are so interconnected that, while each coil has its connection to the outside current reversed as before, when its electromotive force is zero, the other coils in which the E. M. F. still remains in the right direction continue in circuit unchanged. In this way the E. M. F. at the brush is the sum of the E. M. F.'s of a number of coils, each of which is reversed at the proper moment. The number of commutator segments is increased proportionally to the number of coils,

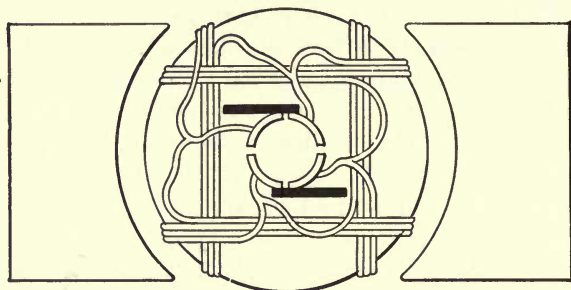

FIG. 24.

and the commutator thus becomes a comparatively complicated structure. The result, however, is that the total E. M. F. of the armature cannot vary by more than the variation due to a single coil. The nature of this modification is shown in Fig. 24, which shows a four-part commutator connected to a four-coil drum armature.

An eight-part winding of modern type is shown in Fig. 25. Tracing out the currents in this will give a clear idea both of a typical winding and of the process of commutation.

In commercial machines the number of individual coils and of commutator segments often exceeds 100, but the principle of the winding is the same. Nearly all the early dynamos had several turns of wire per coil, as in Fig. 24, but at present, in most large machines, one turn constitutes a complete coil.

This subdivision is to avoid sparking at the commutator, which becomes destructive if the current be large and the E. M. F. per commutator segment more than a few volts.

If each coil generates a considerable voltage, there is even under the best conditions of commutation a strong tendency for sparks to follow the brush across the insulation between segments, or even to jump across this insulation elsewhere. As this goes from bad to worse, and rapidly ruins the commutator, every precaution has to be taken against such a contingency. The E. M. F. generated by each coil is kept low by subdividing the winding, and in large machines it is the

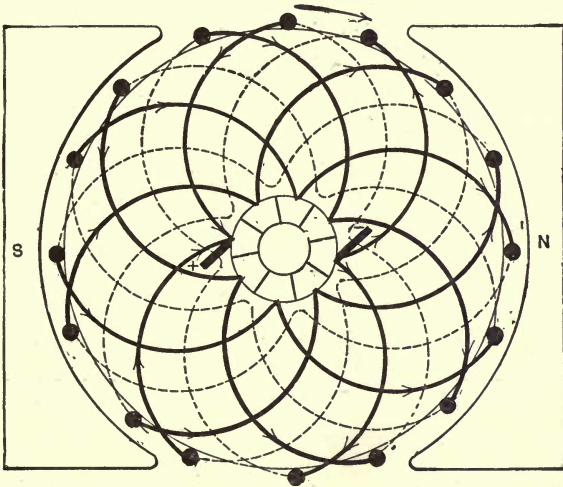

FIG. 25.

rule that the E. M. F. of a single loop is quite all that can safely be allotted to a single commutator segment.

Present good practice indicates that, in generators for lighting, up to 100 or 150 volts the voltage between brushes should be subdivided so that it shall not exceed 3 or 4 volts for each segment between the brushes. For 500 or 600 volt machines it should not ordinarily exceed 8 or 10 volts, while for dynamos of moderate output and even higher voltage it may rise to 20 volts or more.

The reason for these different figures is that the destructive-

ness of the spark depends on the amount of current which is liable to be involved. On a low voltage commutator intended for heavy currents, even very moderate sparking may gnaw the segments seriously, while the spark of an arc machine, in spite of its venomous appearance, may do very little harm, as the maximum current in the whole bar will not exceed 8 or 10 amperes. Consequently the voltage per bar in such cases is sometimes 50 or more, while in very large incandescent machines, and in those designed for electrolytic purposes, the E. M. F. per bar is often less than 2 volts or even below 1 volt.

Windings like those of Figs. 24 and 25 are of the so-called

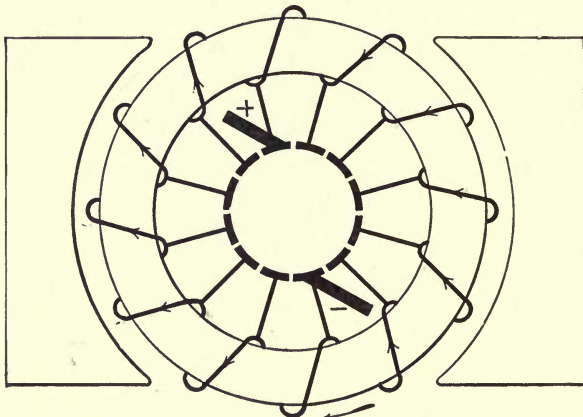

FIG. 26.

dram type, in which each convolution extends around the whole body of the armature, either diametrically or nearly so. Another sort of armature winding frequently used, although less now than formerly, is the *Gramme*, so called from its inventor. Here the iron body of the armature is, instead of being cylindrical, in the form of a massive ring of rectangular cross-section. The windings are looped through and around this ring, fitting it firmly and closely. Fig. 26, which shows in diagram a winding in ten sections, furnishes a good example of the Gramme construction. There may be one or several turns per coil, as in drum windings. These two general types of windings are used with various modifications in

nearly all continuous current dynamos. Each has its good and bad features. The Gramme winding makes it very easy to keep down the voltage per segment, inasmuch as for each external armature wire there is a commutator bar, while in the drum form there is but one bar for two wires. It is also mechanically solid even when wound with small wire, and no two adjacent wires can have a considerable voltage between them, thus making it easy to build an armature for high E. M. F. On the other hand, the drum winding gives a very compact armature of easy construction, and the magnetism induced in it is less likely to disturb that of the field.

In the small machines once usual, the Gramme type was preferred for high voltages on account of the ease with which it could be repaired, while the drum was liked for its simplicity of mechanical construction as a whole and excellent efficiency as an inductor. In modern practice the differences between these types have become much less marked. With large units, particularly of the multipolar form now usual, the drum winding is as easily insulated as the Gramme, for with the winding now used in such cases there need be no considerable voltage between adjacent wires, and repairs are of very infrequent occurrence. In fact, the drum winding can be made quite as accessible as the other, and is on the whole cheaper and simpler. Almost the sole advantage of the Gramme (*or ring*) winding is that of low voltage per commutator bar. Mechanically, too, there is less difference than formerly, for the coils are in both types generally bedded in slots in the iron of the armature core.

It must be noted that the armature of the modern dynamo, unless of small size or unusually high voltage, is seldom wound with wire in the ordinary sense of the word. Instead, the conductors are bars of copper, usually of sections rectangular rather than round, and generally lacking any permanently attached insulation. Whatever the winding, the conductors on the armature face are inclosed in close fitting tubes of mica and specially treated paper or the like, and then put in place on the armature core or in more or less completely closed channels cut in it. If on the core surface, the bars are often not insulated on the exterior surface at all. If the arma-

ture core be slotted, the insulating material is preferably put in position first and the bar put in afterward. As to the rest of the winding, it is completed by connectors of copper strip or rod soldered to the face conductors and insulated in a substantial manner. Thus each convolution, whether of ring or drum winding, is composed of from two to four pieces.

A typical modern ring winding is shown in Fig. 27. It well exemplifies the construction above mentioned, and in this case the uninsulated faces of the exterior conductors form the commutator of the machine. Such a construction of course ex-

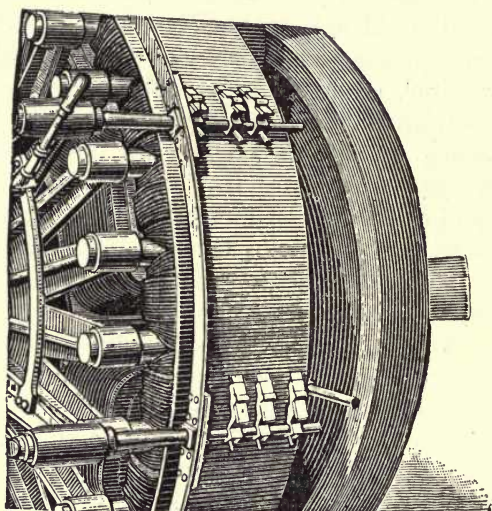

FIG. 27.

cludes iron clad armatures, and is best fitted for a machine having a field magnet inside the ring armature. A similar arrangement which avoids the above limitations, uses the side connectors of the ring as commutator segments. The general principle, however, is the same, whether the commutator forms part of the winding proper or is a separate structure.

An iron clad drum winding of typical character is shown in Fig. 28. Here the exterior bars are fitted into thoroughly insulated slots in the core, and wedged firmly into place by insulating wedges. Sometimes the bars themselves are shaped

so as to act as wedges. In either case the bars are held almost as solidly as if they formed an integral part of the core. The commutator in these windings must be a separate affair. Fig. 28 shows well the nature of the winding, with its slotted core, ventilating spaces, and massive bars — in this example 4 per slot. The end connectors lie in a pair of reverse spirals, one outside the other, and separated by firm insulation. The relation of these connectors to the rest of the winding is illustrated in Fig. 25.

Between the modern drum and ring armatures it is needless to discriminate. Both have been successfully used in dynamos of the largest size, but the iron-clad drum is in the more general use, while the use of ring armatures is steadily declining:

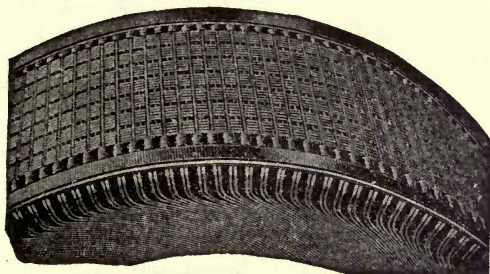

FIG. 28.

It is very unusual to find a standard generator of recent build of 100 KW or more output with a regular wire wound armature, and the most of them have some modification of the bar windings just described.

We have briefly reviewed here the armature windings at present in general use and may now pass to the various windings employed for the field magnets. These are, in continuous current dynamos, almost always connected with, and supplied with current from, the armature winding, thus making the machines self-exciting. As the armature is turned the action begins with the weak residual magnetism left in the field magnets, and the current set up by the small E. M. F. thus produced is passed around and gradually strengthens the magnets, building them up to full strength. If this residual magnetism is very feeble, as may happen when it is knocked out of the iron

by rough handling or the continual jarring of a long journey, it is sometimes quite difficult to get the machine into action.

The simplest form of field winding, and the one which was most extensively used at first, is that in which the current from one of the brushes passes around the field magnet coils on its way to or from the external circuit of the machine, as shown in Fig. 29. This *series* winding possesses more than one advantage. It consists of a comparatively small number of convolutions of rather large wire and so is cheap to wind, it is, for this same reason, little liable to injury and easy to repair when injured; and what is of particular importance, whenever

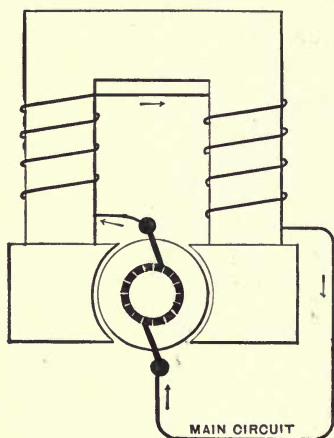

FIG. 29.

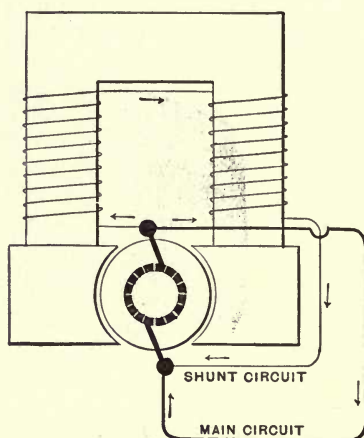

FIG. 30.

the series dynamo is called upon for more current, the magnetizing power of the field is raised by the increase, thus increasing the electromotive force. This property, once considered a disadvantage, becomes of great value in modern windings adapted for the purpose. As the generation of E. M. F. at the start depends entirely on the residual magnetism, series wound machines do not "build up" full voltage very easily unless the resistance of the outside circuit is fairly low, thus giving the current a chance.

The common shunt winding shown in Fig. 30 almost describes itself. The brushes are, independently of the circuit, connected to magnetizing coils of relatively fine wire. Although such a

field winding is slightly harder to construct and to maintain, it produces a magnetic field that is relatively free from any actions in the working circuit of the machine. So long as the E. M. F. at the brushes is unaffected by changes of speed, the field will be quite steady except as a very large current in the exterior circuit may reduce the voltage available for the field by causing a loss of voltage in the armature. If the armature resistance be very small, there will be almost a constant E. M. F. at the brushes except as the current flowing in the armature may produce a magnetization opposed to the shunt field. For a considerable time, then, the shunt winding was always used when a constant E. M. F. was required. At the same time, it permits the E. M. F. to be varied, if desired, with a very small loss of energy, by the simple expedient of putting a variable resistance in circuit with the field magnets.

As the principles of dynamo construction became better known, it was apparent that the above method of getting a constant E. M. F. was rather expensive. To build an armature that would carry a heavy current without noticeable loss of voltage and to inclose it in fields so strong as to be disturbed only in a minute degree by the magnetizing effects of such current, was a task requiring much care and a great amount of material. Even if this difficult problem were solved, the constant voltage would be at the brushes of the machine and not at the load, where it is needed.

An easy way out of these difficulties is found by considering an important property of the series-wound machine just mentioned, *i.e.*, the rise of E. M. F. as the load on the external circuit rises. If now one takes a good shunt-wound dynamo and adds to the field magnets a few *series* turns wound in the same direction as the shunt, the result is as follows: At no load, the voltage at the brushes is that due to the shunt alone. As the load comes on this voltage would naturally fall off by the loss of voltage from armature resistance and reaction. The series turns, however, at this juncture strengthen the field and thus compensate for these losses. This is the *compound winding*, now almost universally used. It is shown in diagram in Fig. 31. Ordinarily the series turns are more than would be needed for merely compensating the losses due to armature

resistance and reaction, so that the voltage at the brushes under load will rise enough to make up for the increased loss in the line due to carrying heavier current.

Machines thus *over-compounded* five or ten per cent are in very common use.

The foregoing gives the rudiments of the machines used for generating direct current. It now remains, before taking up the question of power transmission proper, to consider briefly the use of such machines as motors. The underlying principle has been already discussed. The power of a motor to do

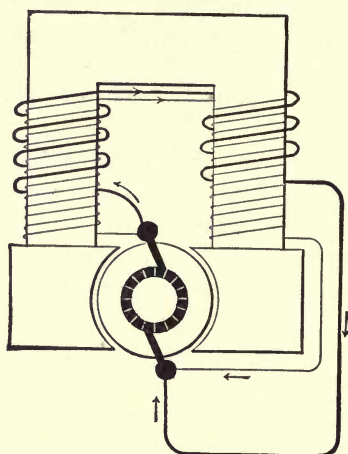

FIG. 31.

work depends on the stress of the magnetic field on conductors carrying current in it and free to move. This stress is virtually the same as that which has to be overcome in using the machine as a generator, and reaches a very considerable amount in machines of any size.

In motors with the field strengths often used, the actual drag between the field and the armature wires may amount at a rough approximation, to nearly an ounce pull on each foot of conductor in the field for every ampere flowing through the wire. With a 20 HP motor the actual twisting effort or *torque* at the surface of the armature might easily be considerably over a hundred pounds pull. Forces of this size emphasize

the need of solid armature construction, with the conductors firmly locked in place, particularly since the magnetic drag is not steady, but comes somewhat violently upon the conductors as they enter the field. With the old smooth core armatures wound with wire, the conductors not infrequently worked loose and chafed each other, and even the entire winding has been known to slip on the core. In modern windings, either iron-clad or modified smooth core, such accidents are nearly impossible.

When the armature conductors of the motor cut through its field as the armature revolves, an electromotive force is necessarily generated in them as in every other case when the magnetic forces on a conductor change. There is thus produced, as a necessary part of the action of every motor, a *counter electromotive force* in the armature. This electromotive force plays a very important part in the internal economy of the motor.

In the first place, the magnitude of the counter electromotive force determines the amount of current that can flow through the motor when supplied at a given voltage. The resistance of the armature from brush to brush may be only a few thousandths or even ten thousandths of an ohm, while the applied voltage may be several hundred volts. The resulting current, however, is not that which would flow through the given resistance under the pressure applied, but the flow is determined by the difference between the applied electromotive force and the counter E. M. F. of the motor, so that in starting a motor when the armature is at rest and there is therefore no counter E. M. F., a resistance must be inserted outside the armature to cut down the initial rush of current.

In the second place, the counter electromotive force measures the output of the motor for any given current. It does this because the very same things, *i.e.*, strength of field, amount of wire under induction, and speed, which determine the output for a given current, also determine the magnitude of the counter electromotive force.

Therefore, when the machine is running as a motor, while the energy supplied to it is the product of the voltage by the amperes which flow through the armature, the output of the

motor is determined by the product of the counter electromotive force into the selfsame current; hence, under given conditions, the ratio between the counter and impressed electromotive forces of the motor determines the efficiency of the motor. The difference between these electromotive forces determines the input of energy, since it determines the current which may flow; therefore, as the counter electromotive force increases, the efficiency of the motor increases, but the output is limited by the decreased input.

With a fixed electromotive force supplied to the armature, the output of the motor per ampere of current will diminish as the counter electromotive force diminishes, but the total amperes flowing will increase because the difference between the applied and counter E. M. F. has also increased. Thus the total output increases, although at a lower efficiency, when the counter E. M. F. decreases. Since the input (which is determined by the difference between counter and applied E. M. F.'s) multiplied by the efficiency (which is determined by the counter E. M. F.) equals the net output of the motor, this output will be at a maximum when the counter E. M. F. and the effective E. M. F. are equal to each other. This follows from the general law, that the product of two quantities, the sum of which is fixed, will be a maximum when these quantities are equal.

It must be distinctly understood, however, that at this point of theoretical maximum output the motor is very inefficient, and that mechanical considerations prevent the efficiency being wholly determined by the counter E. M. F., while sparking and heating generally prevent working with the counter E. M. F. equal to the effective E. M. F.

In actual practice motors are worked under very diverse conditions, and some of these it is worth while to take up in detail, following the preceding generalizations. The energy may be supplied at constant current, at constant voltage, with neither current nor voltage constant, at fixed or variable speed, and subject to a wide variety of conditions; the motors may be wound either series, shunt, compound, or with various modifications of these windings, and may be either self regulating with respect to various requirements, or regulated by

extraneous means. In the ordinary problems dealt with in power transmission, these conditions may be classified in a fairly simple way as follows :

Case I. Series-wound motors at constant current.

Case II. Series-wound motors at constant voltage.

Case III. Series-wound motors with interdependent current and voltage.

Case IV. Shunt-wound motors at constant voltage.

The first class is now rarely found in practice, and is of real commercial importance only in a few cases. The second class is very widely used in a particular case, to wit: electric railway service, and consequently it is of great practical importance. The third class of motors is used occasionally with great success but not very extensively, while the fourth includes the vast majority of all the continuous current machines running for purposes other than electric railway service. These latter cases, therefore, it is worth while to take up somewhat thoroughly.

CASE I. — Series-wound motors operated with a constant current originally came into use in connection with arc lighting circuits, which for some years formed the most generally available source of current. Such lines are fed from dynamos in which the current is kept constant by special regulation, while the voltage rises and falls in accordance with the load, consisting of lamps or motors in series with each other. We are therefore relieved of any concern about the current, since it is kept constant quite irrespective of what happens in the motor.

Under these circumstances, in a series-wound motor, the torque will be constant, since the field is constant, and the output of the motor will vary directly with the speed. If it be loaded beyond its capacity, it simply refuses to start the load, inasmuch as its torque is limited by the current. If it starts with a load within its limit of torque, its speed will steadily increase until that limit is reached. This may be comparatively soon if the load is a rapidly increasing one, or the machine may race until its own friction of air and bearings, magnetic resistances, and the induction of idle currents in the core and frame serve to furnish resistance up to its limit of

torque. When running at a given speed, any increase of load causes the speed to fall off, while decrease of load produces racing. Unless these tendencies are controlled, this type of machine becomes almost useless for practical purposes, as regularity of speed under change of load is generally highly desirable. In fact, the tendency to run at constant torque is generally inconvenient. To obviate this very serious difficulty, various devices have been tried with tolerable success. The commonest is to vary the torque in accordance with the load by changing the field strength, or by shifting the brushes so as

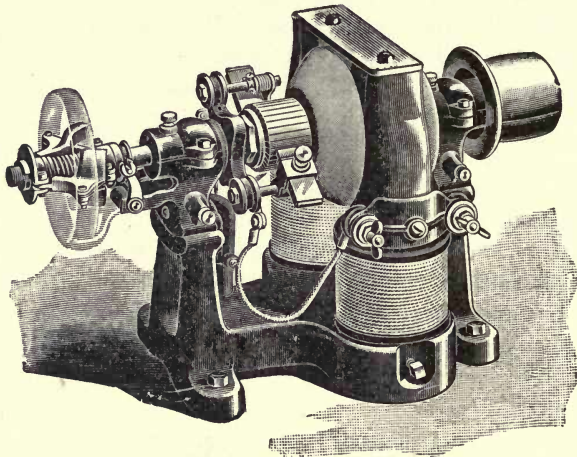

FIG. 32.

to throw the armature coils out of their normal relation to the magnetic field.

Since the object of such changes is to vary the output at constant current, and since this output is measured by the counter E. M. F. of the motor, the real problem of such regulation is to vary the counter E. M. F. in proportion to the output desired. Therefore, the same general means that serve to accomplish this end in an arc dynamo, keeping the current constant and varying the E. M. F., will serve to regulate the corresponding motor.

As in this case the speed is the thing to be held constant, the usual means taken for working the regulating devices is a

centrifugal governor, which generally acts to shift the brushes or to put in circuit more or less of the field winding, which for this purpose is divided into sections. In still other arrangements the governor acts to slide the armature partially into or out of the field, or to work a rheostat which shunts the field magnet, as in the Brush regulator for constant current. An excellent example of a small constant current motor regulated on the last mentioned principle is shown in Fig. 32.

As to the operation of these regulating devices, it is tolerably good if everything is carefully looked after and kept in adjustment. The efficiency of such motors is not generally as high as that of other types at light loads, owing to the nearly constant loss in the armature due to constant current working. At and near full load the efficiency may be good.

In addition, the current is highly dangerous, coming as it does from generators of very high voltage, and even the voltage across the brushes is, in machines of any size, sufficient to give a dangerous or even fatal shock. A 10 HP motor, for example, on the customary 10-ampere circuit, would have a difference of potential of about 800 volts between the brushes at full load. As a few such motors would load even the largest arc dynamos, besides being dangerous in themselves, operations have generally been confined to smaller units. On account of the danger and the mechanical and other difficulties, the arc motor has come to be looked upon as a last resort, is seldom or never used when anything else is available, and, to the credit of the various manufacturers be it said, is nearly always sold and installed with a specific explanation of its general character and the precautions that must be taken with it.

In spite of all these objections, the constant current motor often does good and steady work, and some such motors have been used for years without accident or serious trouble of any kind. They have been employed, however, only sparingly for power transmission work of any kind, and when so used are mostly on special circuits of 50 to 150 amperes.

CASE II. — Series motors worked at constant potential are very widely used for electric railway service and other cases, such as hoisting, in which great variations of both speed and

torque are desirable. When supplied at constant potential, the speed of a series-wound motor varies widely with the load. In any case the speed increases until the counter E. M. F. rises high enough to cut the current down to the amount necessary to give the torque sufficient for that load and speed.

If the field be strengthened, the motor will give a certain output at a lower speed than before; if it be weakened, at a higher speed; the torque being in these cases correspondingly increased or decreased.

The torque increases rapidly with the current, so that when the counter E. M. F. is small, or zero, as in starting from rest, the torque is very great, a property of immense value in starting heavy loads. For in starting, not only is the current through the armature large, but the field is at its maximum strength. If the field strength varied directly as the current, the torque would vary nearly as the square of the current.

As a rule, however, these, like most other motors, are worked with a fairly intense magnetization of the fields, so that doubling the magnetizing current by no means doubles the strength of the field. In fact, most series motors for constant potential circuits are of the type used for electric railways, and wound so that the field magnets are nearly saturated even with very moderate currents. Hence the torque in such cases increases but a trifle faster than the current. This construction is adopted in order to reduce the amount of iron necessary to secure a given strength of field, and so to lighten and cheapen the motor.

It is quite obvious that while series motors at constant potential have the advantage of being able to give on occasion very great torque, they suffer from the same disadvantage as constant current motors, in that they are not self-regulating for constant speed. Centrifugal governors could, of course, be applied to them, but since it happens that most work requiring great torque also requires variable speed, nothing of the kind is usually necessary.

As previously explained the speed can be easily regulated to a certain extent by changing the field strength, thus changing the counter E. M. F., but owing to the peculiarity of design just noted, this method is rather ineffective, requiring a

great change in the field winding for a moderate change in speed.

In general, when a considerable range of speed is needed, constant potential working is abandoned and the speed is changed by varying the impressed E. M. F. by means of a rheostat. If this E. M. F. be lowered, the current decreases and the speed sags off until the new counter E. M. F. is low enough to let pass just enough current to maintain the output at the reduced speed. When the applied E. M. F. is increased the reverse action takes place. Under these circumstances, for

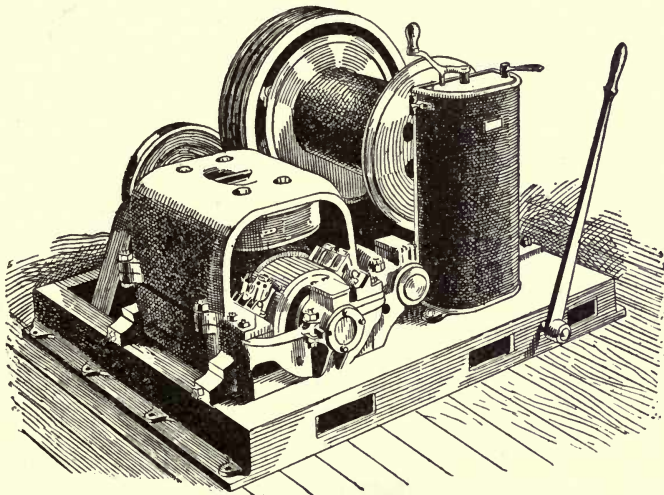

FIG. 33.

a fixed load the current is approximately the same, independent of the speed; for with a uniform load the torque is constant, while the output (*i.e.*, rate of driving the load) varies. Many railway motors are regulated in the manner just described, although in addition the field strength is sometimes varied by cutting out or recombining fields and by series parallel control. Rheostatic control necessarily wastes energy, and the greatest recent improvement in railway practice consists in reducing the E. M. F. applied to the car motors by throwing them in series. This secures a low speed economically, though the rheostat still comes into play at intermediate speeds.

Speaking broadly then, series-wound motors, while possessing many valuable properties, are limited in their usefulness by their tendency to vary widely in speed when the load changes. Hence they are used chiefly in cases where the speed is to be varied deliberately. A typical early motor of this class, used for hoists and the like, with rheostatic control, is shown in Fig. 33.

In spite of the difficulty in regulation, the series motor possesses some considerable advantages: The field coils being of coarse wire are easily and cheaply wound, even in motors for very high voltage; the same quick response to changes in current or load that makes it hard to obtain uniform speed is also most important in many kinds of work; the powerful initial torque is coupled with the useful property of prompt reversal. All these make the series motor preëminent for certain purposes, especially where severe work is to be coupled with hard usage.

There is one case, too, in which the series-wound motor can be made accurately self-regulating for constant speed — a case somewhat peculiar and unusual, but yet worthy of special attention.

CASE III. — We have seen that when the load on a series motor supplied at a certain voltage increases, the speed falls off until the increasing current due to the lessened counter E. M. F. raises the torque sufficiently to meet the new conditions. Imagine now the impressed E. M. F. to be so varied that the slightest increase of current in the motor is met by a rise in the E. M. F. applied to it. Evidently the speed would not have to fall as before, for the greater applied voltage would furnish ample current for all the needs of the load. If the variation in voltage could be made to depend on change of torque, not giving the speed time to change, the regulation would be almost perfect. Such a method has been proposed, but owing to mechanical difficulties has not been used to any extent.

It is possible, however, so to combine a special motor and generator that the former will be very closely uniform in speed, quite independent of the load. In this connection we must revert to the properties of the series-wound dynamo. If such

a machine be driven at constant speed its electromotive force will increase with the current, since the strength of field, here the only variable factor in the voltage, will increase with the current. If the field magnets of the generator are unsaturated, that is, not so strongly magnetized as to require considerable current to produce a moderate increase of magnetization, they will respond very promptly to an increase of load by raising the voltage. If such a generator be connected to a series-wound motor of proper design, the pair will work together almost as if connected by a belt instead of a long line, and the motor will run at a nearly uniform speed, since

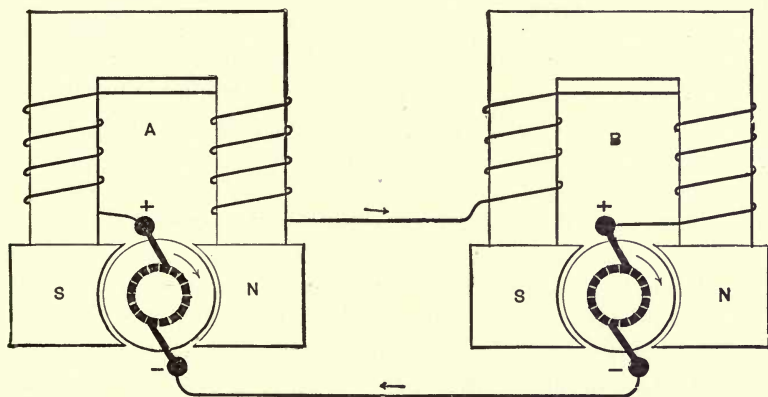

FIG. 34.

the least diminution of speed, with its accompanying increase of current, will be met by a rise in the voltage of the generator. Such an arrangement is shown in diagram in Fig. 34.

In this cut *A* is the generator supplying current to the motor *B*. The machines should be of practically the same capacity, for the generator cannot supply current except to the one motor without disturbing the regulation. Whenever the load on *B* changes, a very small reduction in speed suffices to raise the voltage of *A* and thereby to hold up the speed of *B*. To this end the field magnets of *B* must be more strongly saturated than those of *A*, else the same increase of current will raise the counter E. M. F. of the motor and defeat the purpose of the combination. If the fields of the two machines

are properly designed, the generator will increase its voltage under increasing load just enough to hold the motor at speed, as a very slight change in current immediately reacts on the generator.

It is even possible to make the motor rise in speed under load if the generator is sufficiently sensitive to changes of current. This is generally needless, but it is often useful so to design *A* and *B* that the former will rise in voltage fast enough not only to compensate for the added load on the motor but for the added loss of energy in the line, entailed by the increase of current, thus regulating the motor even at a long distance. The difference of saturation between the generator and motor fields need not involve material difference of design, since it may be effected by shunting the motor field. When properly adjusted, the system is capable of holding the motor speed constant within two per cent through the range of load for which the machines are planned.

It should be noted in connection with Fig. 34 that, whereas the current circulating in the armature of a generator tends to disturb the magnetic field in one direction, in a motor the same reaction is in the opposite direction. For the current in the motor is driven through the armature against the counter E. M. F., *i.e.*, in the direction opposite to that of the current the machine would give if running as a generator. As the effect of the reaction is to skew the direction of the magnetic field that affects the armature conductors, and the commutation must take place when the commuted coil is not under a varying induction, the armature reaction compels one to shift the brushes slightly away from the position they would have if the field were perfectly symmetrical. This shifting is in the direction of armature rotation in a generator, but for the reason above noted has the opposite direction in a motor. In either case it need be only a few degrees.

CASE IV. — Shunt-wound motors are almost invariably worked on constant potential circuits, to which they are particularly well suited. They form by far the largest class of motors in general use and owe this advantage mainly to their beautiful self-regulating properties.

The shunt motor is in construction practically the same as

a shunt-wound dynamo. Let us look into the action of such a machine when supplied from a source of constant voltage. If the design be reasonably efficient, the armature will have a very low resistance and the shunt circuit, which includes the field coils, a resistance several hundred times greater. When such a machine is supplied with current of constant voltage at its brushes and is running at any given speed and load, the current through the armature is practically determined by the counter E. M. F. developed, the armature resistance being almost negligible. The shunt is of high resistance and takes a certain small amount of current, determined by the voltage across the brushes. Now let the load increase; the field is, aside from loss of voltage on the line, practically constant, and the first effect of the added load is, as in a series motor, to reduce the speed. But this lowers the counter E. M. F., and consequently the armature current rises and the torque is increased, thereby enabling the motor to operate under the larger load. The torque necessary to enable the motor to maintain an increased load varies directly as the load and is also directly proportional to the current. But since the current is closely proportional to the difference between the impressed and counter E. M. F.'s, it is possible to design a machine so as to run at almost exactly constant speed.

The constancy depends really on the armature resistance, small as it is. For example, a motor is designed to run at 100 volts. Running light the counter E. M. F. is 99.9 volts, and with an armature resistance of 0.01 ohm the current will be 10 amperes. The work done is say 1 HP. Now let a full load, say 20 HP, be thrown on. The torque will have to be increased 20 times, requiring 200 amperes. But this will flow through the armature under an effective pressure of 2 volts. Hence the counter E. M. F. will only have to fall to 98 volts to provide current enough to meet the new condition. As the counter E. M. F. varies directly as the speed, a fall in speed of less than 2 per cent will follow the increase of load. This computation neglects all questions of armature reaction as well as the effect of this minute fall in speed on the output, but fairly represents a case that might actually be met with in the best modern practice. In fact, shunt motors have been so

designed as to vary no more than $1\frac{1}{2}$ per cent in speed from no load to full load. A variation of 5 or 6 per cent is, however, more usual.

When supplied from an over compounded generator so that the impressed voltage may increase with the load, a shunt motor can be operated even more closely to constant speed than indicated above, since there is no longer need for a fall in speed to maintain the requisite difference between the impressed and counter E. M. F.'s. In such case any tendency to fall in speed is at once corrected by the rise in voltage on the line. This scheme is seldom used, however, since it is ill fitted for simultaneously operating a number of motors at varying loads, and for single units has no particular advantages over the series-wound pair previously noted, or a very simple arrangement of alternating apparatus.

Not only can the shunt motor be worked at nearly constant speed, but it also has the advantage of permitting a considerable range of speed variation without sacrificing much in the matter of efficiency. We have already seen that a change in field strength involves a change of speed, since it necessarily alters the counter E. M. F., which in turn modifies the current.

In a shunt motor the immediate effect of a decrease of field strength is to lower the counter E. M. F., letting more current through the armature and increasing the torque. Hence, the speed rises until the current and torque adjust themselves to the requirements of the load. On the other hand, if the field be strengthened, the current necessary to carry the load cannot be obtained without a fall in speed. It is clear that the changes of speed thus obtained may be quite considerable, for in a motor such as that just described a variation of 10 per cent in the field would produce an immense variation of current, which would have to be compensated by a change in speed as great as the change in the field. Inasmuch as these field changes can be produced by varying the field current, which is always small, through a rheostat in the circuit, this change of field strength can be accomplished with but a trifling waste of energy. If the field magnets are comparatively unsaturated, it is not difficult to obtain perhaps 50 per cent variation in speed. A motor designed for such work is, how-

ever, bulky, as it must if necessary be possible to get torque enough to handle the full load with a field much below its normal strength.

It should be noted that even when running at a considerably modified speed, the motor must still be nearly self-regulating for changes in load, for the conditions that govern self-regulation are within moderate limits unaffected by the particular strength of field employed. Only when the armature reaction has been greatly modified will the regulation be sensibly disturbed.

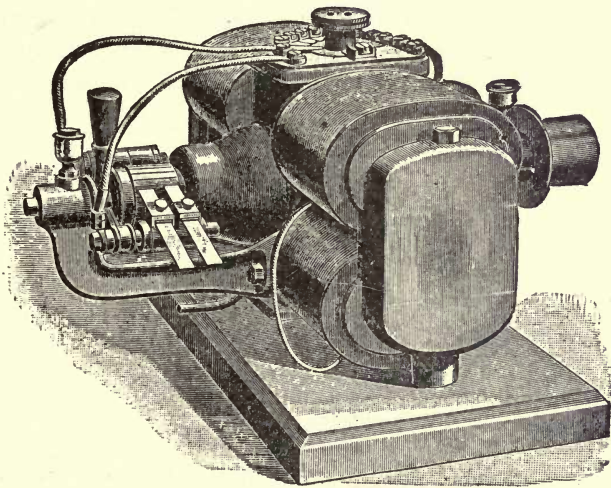

FIG. 35.

A device sometimes used to improve the regulation of motors essentially shunt wound is the so-called differential winding. This consists of an additional field winding in series with the armature, but around which the current flows in such a direction as to demagnetize the field. The total field strength is then due to the difference between the magnetizing power of the shunt and of this regulating coil. When the load on the motor increases, the additional current due to a minute change of speed will weaken the field, and thence cause the motor to run faster until the counter E. M. F. adjusts the current to the new speed and output. Differential winding obviously requires an extra expenditure of energy in the field, since the shunt and

series turns act against each other. Fig. 35 shows the Sprague motor wound on this differential plan, now only of historical interest, but which through its good qualities did much to popularize the electric motor in America. Plate II shows in Fig. 1 a Westinghouse bi-polar shunt motor, and in Fig. 2 a G. E. six-pole shunt motor for slow speed.

Various modifications of shunt- and series-wound motors have from time to time appeared, devised for particular adaptation to special purposes or sometimes merely for the sake of novelty. None of them, however, are of sufficiently general importance to find a place here except a single very beautiful method of obtaining efficiently a very wide range of speed.

The principle of this method is to work the motor at normal

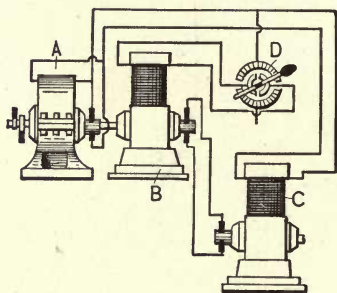

FIG. 36.

full excitation, but to deliver to the armature a current of variable E. M. F. so that a given current and hence torque may accompany very various values of the counter E. M. F. Fig. 36 shows the connections employed to effect this result. Here *C* is the working motor, *B* the special generator which feeds its armature, *A* the motor used to drive this generator, and *D* the rheostat and reversing switch in the generator field circuit which allows the generator E. M. F. to be varied. In the figure the motor *H* is shown as a synchronous alternating machine with a commutator from which are fed the fields of the three machines. In ordinary central station practice *A* is a continuous current motor, and the fields are fed direct from the distributing mains. The result of this arrangement is that the motor field *C* remains at full strength, while the armature

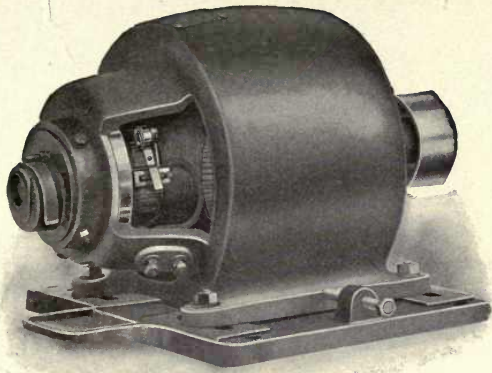

FIG. 1.

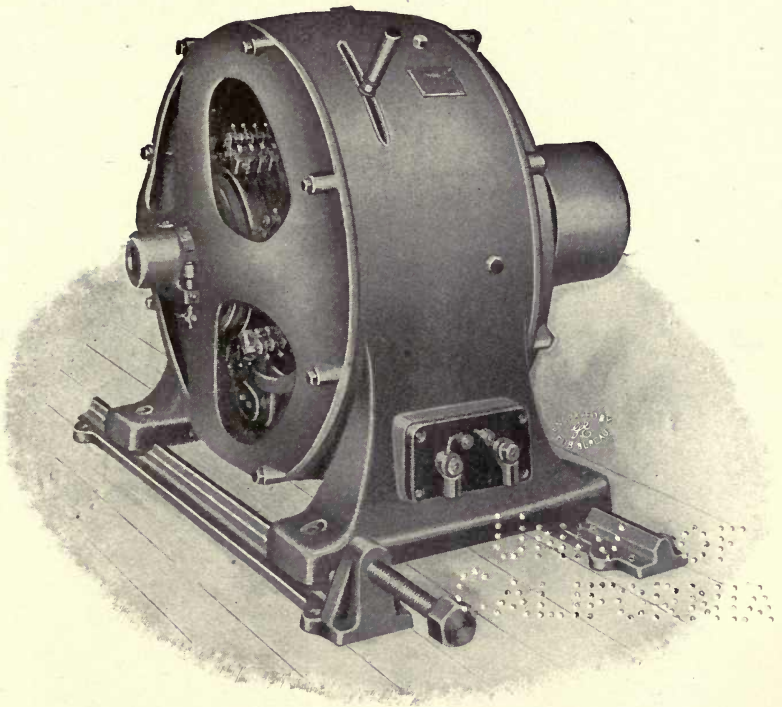

FIG. 2.

001 002 003 004 005 006 007 008 009 010
011 012 013 014 015 016 017 018 019 020
021 022 023 024 025 026 027 028 029 030
031 032 033 034 035 036 037 038 039 040
041 042 043 044 045 046 047 048 049 050
051 052 053 054 055 056 057 058 059 060
061 062 063 064 065 066 067 068 069 070
071 072 073 074 075 076 077 078 079 080
081 082 083 084 085 086 087 088 089 090
091 092 093 094 095 096 097 098 099 100

001 002 003 004 005 006 007 008 009 010
011 012 013 014 015 016 017 018 019 020
021 022 023 024 025 026 027 028 029 030
031 032 033 034 035 036 037 038 039 040
041 042 043 044 045 046 047 048 049 050
051 052 053 054 055 056 057 058 059 060
061 062 063 064 065 066 067 068 069 070
071 072 073 074 075 076 077 078 079 080
081 082 083 084 085 086 087 088 089 090
091 092 093 094 095 096 097 098 099 100

current can be brought to any required strength at any desired armature speed within a very wide range. Hence, C can give full load torque or even more while the armature is merely turning over a few times per minute, and the speed can be brought up with the utmost delicacy and held at any desired point. And at every speed the motor holds its speed fairly well, irrespective of changes of load. For elevators, hoists, and similar work this device is extremely useful. The only objection to it is the cost of installing the two extra machines, which is of course considerable. Nevertheless the regulation attained is so beautiful and perfect that the cost often becomes a minor consideration, and the device is very widely used in cases where variable speed is essential.

POWER TRANSMISSION AT CONSTANT CURRENT.

In its general aspect this method must now be regarded as a makeshift. It came into existence at a time when the only circuits extensively installed were those for arc lighting, and hence, if motors were to be used at all, they must needs be of the constant current type. As incandescent lighting became more common the arc motors were gradually replaced by shunt motors worked at constant potential. A few constant current plants especially for motor service have been installed both here and abroad, but for the most part they have merely dragged out a precarious existence, and in this country have been abandoned.

There is good reason for this. The motors usually regulate indifferently, and there is serious objection to running high voltage wires into buildings when it can be avoided.

The objections of the insurance companies alone are quite sufficient to discourage the practice. The constant current has often been advocated for long distance transmission of power where high voltage is a necessity. For such service the method has the great advantage that the motors do not need extraordinary insulation except from the ground. A constant potential service at 5,000 volts continuous current would be utterly impracticable, if distribution of power in moderate units were to be attempted, while with constant currents it

is entirely feasible, although objectionable on the grounds mentioned. In addition, unless a proposed transmission be for power alone, the constant current method shares with constant potential of high voltage the very grave difficulty that an incandescent lamp service is out of the question, without secondary transformation of the necessarily high line voltage to a very moderate pressure. This is somewhat expensive with continuous currents of any kind, and at once introduces the

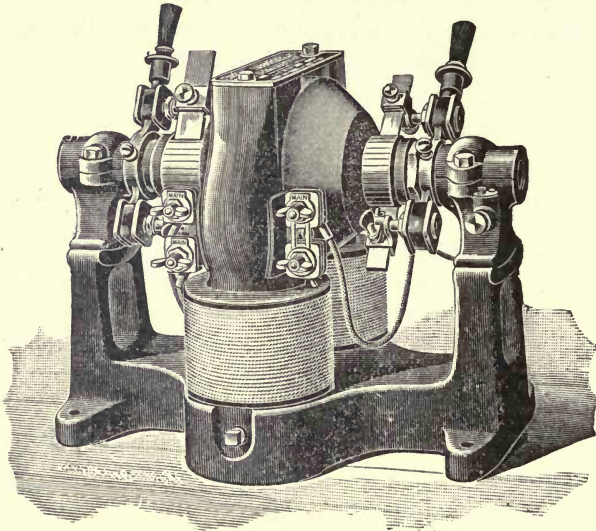

FIG. 37.

troublesome question of regulation at constant current into the problem.

To reduce the energy sent over a high voltage continuous current line to a pressure at which incandescent lamps can be fed, two methods are possible. We may pass by the plan of using many lamps in series as of very limited applicability and forbidden by the fire underwriters. First, the required power may be received by a motor of appropriate size, which is belted or coupled to a low voltage generator. This device does the work, but it involves installing three times the capacity of the lamps desired in machinery of a somewhat costly character, and losing in the motor and gen-

erator perhaps 15 or 20 per cent of the energy supplied from the line. The other alternative is to employ a composite machine combining the functions of motor and generator. This piece of apparatus is variously known as a motor-generator, dynamotor, or continuous current converter. It is a dynamo electric machine having a double-wound armature and two commutators. One winding with its commutator receives the high line voltage and operates as a motor. The other winding and its commutator furnishes, as a dynamo, low tension current. The field is common to both windings. Fig. 37 shows a small machine of this kind, adapted to receive 5,000 volts from the line, and to deliver 110 volts, or vice versa.

This particular machine works at constant voltage on both circuits. Either circuit, however, could be made to work at constant current, provided the means of regulation for this purpose were so chosen as to leave the field and speed unchanged.

The cost of a motor generator, while less than that of two separate machines, is still high, and although its efficiency is somewhat greater than that of the pair mentioned above, it is obtained at the cost of a rather complicated armature, which, from a practical standpoint, is quite objectionable.

In spite of the difficulties incident to working incandescent lamps from a high voltage constant current circuit, the ease with which such circuits can be worked, even if for power alone, at voltages far above those available on the constant potential system, encouraged their installation during the period between the first efforts at long distance transmission and the more recent date at which alternating current apparatus has become thoroughly available. For some years it was constant current or nothing, so far as long distance transmission, coupled with distribution, was concerned.

As a result of the various adverse conditions mentioned, transmission at constant current has never made really any headway in American practice, and in fact the method has been followed to a noticeable extent in only one locality — San Francisco. There, through the activity of local exploiters, constant current power circuits were early established and remained in fairly successful operation for several years.

There were until recently three companies operating constant current circuits in San Francisco for the distribution of power. The currents employed were of 10, 15, and 20 amperes. Most of the motors were small, a very large proportion of them being under one horse-power. The total number of motors in circuit on the various systems was between six and seven hundred.

Except in San Francisco, what few constant current motors have been in operation were operated on regular arc circuits. Their use has been much discouraged by the operating companies, and very few such motors are now manufactured or sold; in fact, constant current distribution in modern American practice is almost non-existent. Abroad, the conditions are somewhat different, and on the Continent constant current distribution for long distance transmission work has been exploited to a very considerable extent, probably owing to the early and successful establishment of a number of transmission plants for single motors worked on the series system. There are several successful plants operated at constant current, one of the most considerable of them being that at Genoa, which is an excellent example of the kind and as such is worth more than a passing mention, even although the probability is that it will seldom be duplicated, at least on this side of the Atlantic.

The Genoa transmission is derived from the River Gorzente, which about twenty years ago was developed for hydraulic purposes, artificial lakes being established and a tunnel about $1\frac{1}{4}$ miles long being built for an outlet. Beyond the tunnel, an aqueduct some fifteen miles in length conveyed the water to Genoa, where a considerable amount of power is utilized directly. In this development there was left at the mouth of the tunnel an unused fall of nearly 1,200 feet aside from the head employed in the aqueduct. This has been developed electrically. It was divided into three partial falls of 338, 357, and 488 feet, respectively. At each of these was erected a generating station with its own transmission line. These stations were named after the three renowned electricians, Galvani, Volta, and Pacinotti. The first mentioned station was the first installed. It consists of two generators operated in series. Each is of about 50 KW capacity, giving 47 amperes

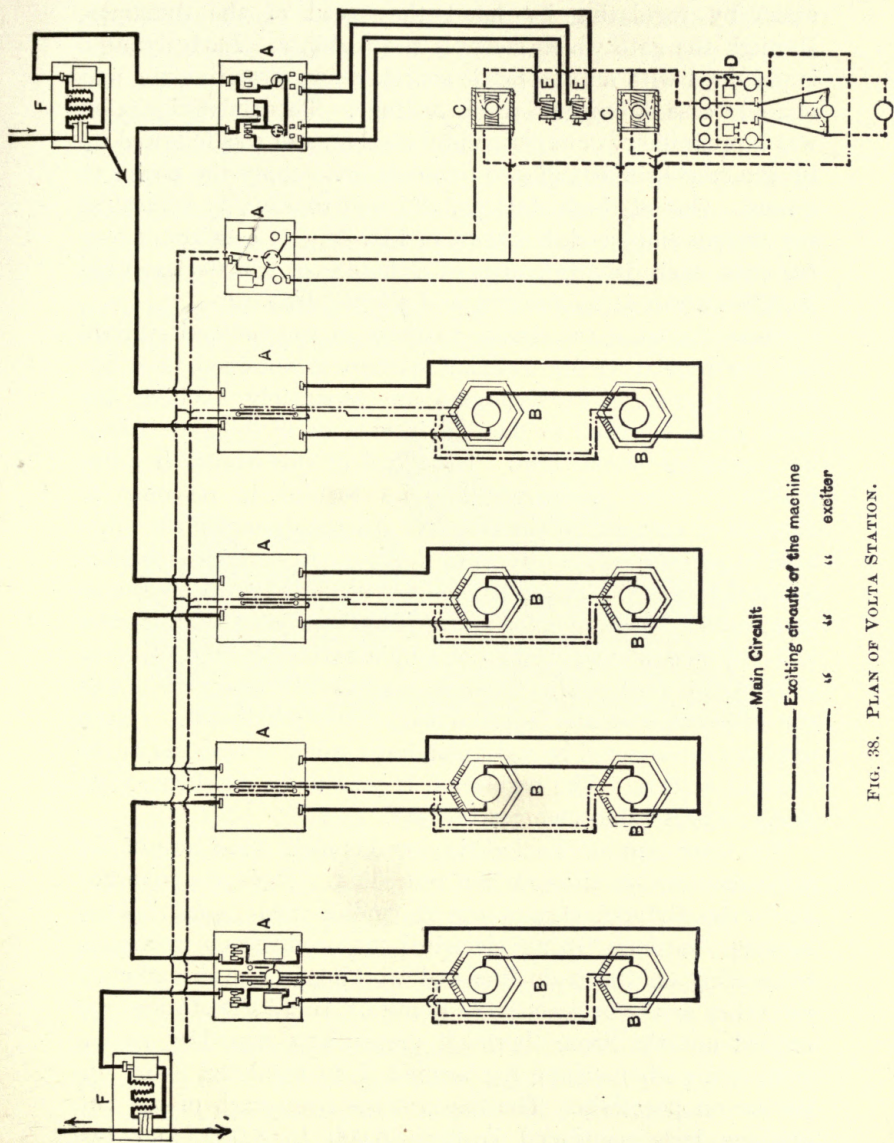

FIG. 38. PLAN OF VOLTA STATION.

with a maximum pressure of 1,100 volts. Current is kept constant by regulating by hand the speed of the dynamos, through the gate which controls the turbines. Each dynamo is provided with an automatic switch, short circuiting the machine in case of extreme rise in voltage. This Galvani station was a preliminary or experimental station, and was followed up by the establishment of two others which supply the power to Genoa. One of these stations, which is thoroughly typical of the system employed, is shown in Fig. 38. It consists of four turbines, each driving a pair of dynamos of a little less than 50 KW output at 45 amperes and about 1,000 volts.

These dynamos are similar to those in the Galvani station, but the regulation for constant current is obtained in a different manner. The dynamos are separately excited, the fields being supplied in parallel from a small dynamo driven by a separate waterwheel. The speed of this exciter is automatically varied by controlling its turbine in response to changes of current in the circuit. All the dynamos are operated in series, and like those in the Galvani station are direct coupled in pairs. The machines are insulated with enormous care, heavy layers of mica being placed between the magnets and the bed plates, while the windings themselves are very elaborately protected. Carbon brushes are employed, and the commutators are reported to behave admirably. Each dynamo is protected by most elaborate safety devices, as in the Galvani station. The regulation is said to be excellent, even under considerable changes of load.

The third station, Pacinotti, contains eight machines of the same capacity as those in the preceding. They are governed as in the Galvani station by controlling their speed. This, however, is done by an electrical motor-governor controlled by a relay on the main line and working in one direction or the other as the occasion may require. In all the stations are carried out the same thorough precautions regarding insulation, and each machine has around it an insulated floor supported on porcelain. The line voltage from each of the two stations last mentioned is from 6,000 to 8,000, and two circuits are carried into Genoa, the extreme distance of transmission being about eighteen miles. The conductors, of wire

9 mm. in diameter (nearly No. 00 B. & S.), are for the most part bare, except when passing through villages, and are supported on oil insulators carried by wooden poles, save in some few cases where iron poles have been used. The two circuits running into Genoa transmit power for motors only. The loss in the line at full load is 8 per cent.

At full load, nearly 1,000 HP is transmitted over the lines, the motors being of all sizes between 10 and 120 horse-power. They are of the ordinary series-wound type, and their speed is automatically controlled by centrifugal governors, which act by varying the field strength. Fig. 39 shows one of the Genoa motors, fitted with an automatic governor acting upon a com-

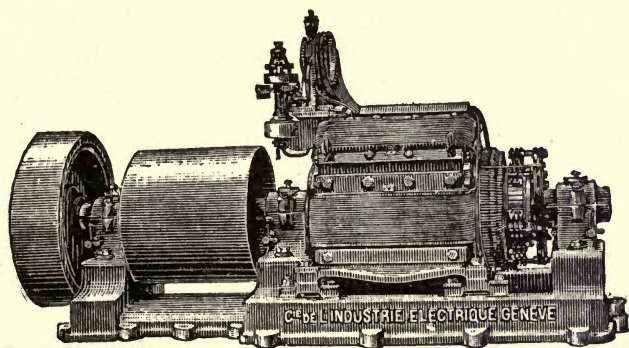

FIG. 39.

mutated field winding. They are provided with carbon brushes, and are reported to operate very successfully.

It is to be noted, however, that the motors are placed in special rooms with insulated floors and walls, owing to the enormous voltage which has to be taken into the buildings. They are fitted with heavy fly-wheels to assist the governors, and with automatic switches to short circuit around the motor in case of excessive voltage. The motors are under the special care of skilled assistants connected with the staff of the generating station, who inspect the lines and go over the motors at intervals of a few days. These extraordinary precautions both in the matter of insulation and skilled attendance account in great measure for the success of what, under

American conditions, would have almost infallibly resulted in disastrous failure. The efficiency of the plant from turbine shaft to motor pulleys is said to be a little over 70 per cent.

As may be judged from this description, the whole installation is of enormously complicated character, although perhaps as simple and efficient as any alternating plant of the same early date. The plan of the Volta station for the most part explains itself. The switchboards for each machine with their plugs for connecting the pair of dynamos coupled to it are shown at *A*, dynamos at *B*, the exciters at *C*, exciter switchboard and rheostat at *D*, and the solenoids, which control the exciter turbines, at *E*. Lightning arresters are shown at *F*. These consist of a spark gap, impedance coils in series with the line and condenser shunted around them. Every motor is provided with a similar lightning arrester. Taken altogether, this Genoa plant is an excellent example of the constant current system followed to its legitimate conclusion. A description of the system is a sufficiently condemnatory criticism judged from our present point of view; at the same time, it should be remembered that while this station was being built, the method adopted was practically as good as any available in the existing state of the art, and that the system has in more recent installations been materially improved. Encouraged by the favorable results obtained at Genoa, a similar station was soon afterwards built delivering a maximum of 700 HP at Brescia at an extreme full-load pressure of about 15,000 volts over a 12-mile line. Since these stations nearly a dozen others have been installed, aggregating about 17,000 HP, and their performance has been uniformly good. In spite of a predilection for modern polyphase work one must admit that a system which has been installed to such an extent, and of late in competition with alternating methods, is far from moribund. Two strong points it undoubtedly has; freedom from all inductive disturbances, and the property of carrying its extreme voltage only at full load, the importance of which will be discussed later. It has shown itself capable of doing steady and efficient work over long distances and under climatic conditions by no means favorable. The Continental makers of this class of machinery have gone far be-

CIVIL ENGINEERING
U. of C.
ASSOCIATION LIBRARY

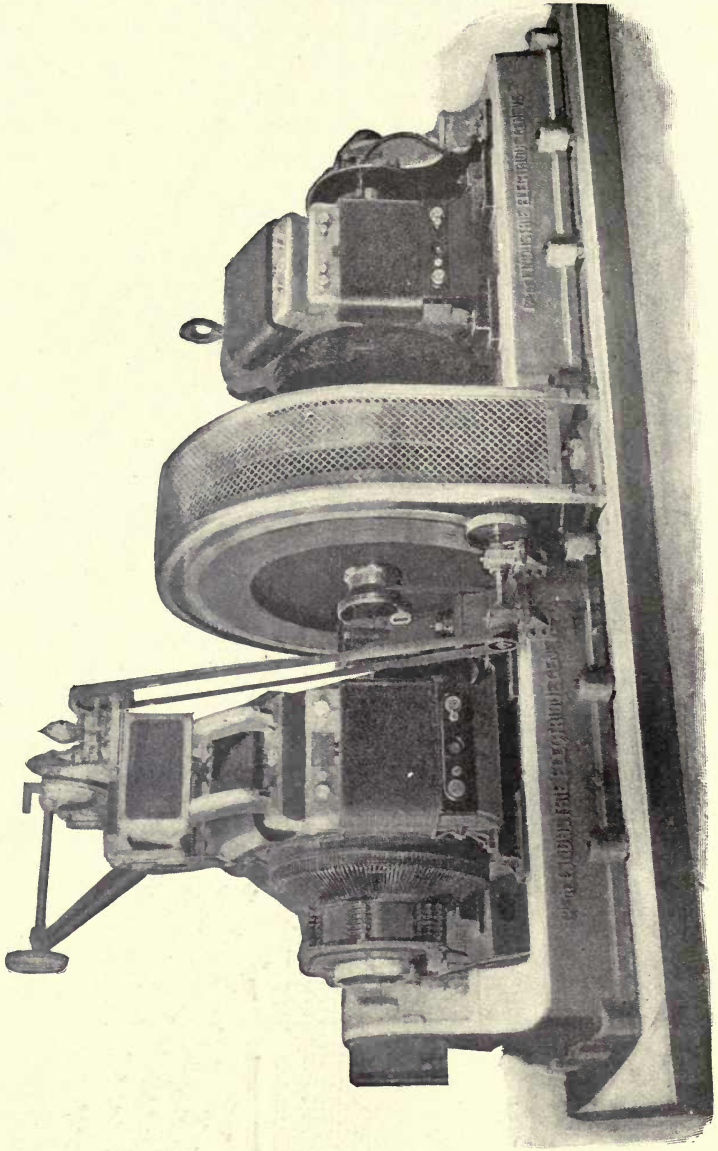

PLATE III.

yond anything that has been attempted in American practice and have turned out constant current dynamos of really remarkable properties.

At present, machines of 50 to 60 amperes have been given successfully E. M. F. as high as 3,500 volts, while those of 100 to 150 amperes have gone to 2,500 volts. As they are usually coupled in pairs, a single unit may have a capacity of about 700 KW, each component machine giving over 300. Without pushing beyond present apparatus it then becomes possible to arrange a plant of 1,000 to 1,500 KW having a working E. M. F. at full load of 10,000 to 14,000 volts. Such a plant is not especially complicated and is nearly as easy to operate as an alternating plant. For a load of a few large motors, it is capable of good work, without, however, presenting any advantages over a polyphase system save that the line is simpler and the insulation requirements less severe. An alternating power station of similar output would contain practically as many generators, for sake of security. When it comes to combined lighting and power service the constant current system is hard pushed. In practice, recourse is had to motor generators. Perhaps the best idea of the situation may be given by a brief description of the Swiss transmission from Combe-Garot to La Chaux-de-Fonds, a distance of 32 miles. At the former place are installed 8 generating units each giving 150 amperes at 1,800 volts, giving a total capacity of 2,160 KW at 14,400 volts. These generators are six pole Thury machines with drum armatures, and are series wound. Regulation is by automatic variation of the speed of the turbines, the normal full load speed being 300 r. p. m. The line is overhead, of cables having a cross section of about 300,000 cm., bare except in the towns where the power is delivered — Locle, and La Chaux-de-Fonds at the end of the line. Motors aggregating 2,400 HP are in circuit at these points, 2,000 HP being used in the transforming stations. All motors above 20 HP are upon the high tension circuit. The substation at La Chaux-de-Fonds is typical of the methods employed. It is equipped with motor-generators of 200 HP working a three wire system at 320 volts between the outside wires. One of the motor-generator units is shown in Plate III. It is composed

of two six pole machines with a fly-wheel between them. The machine to the left is the motor and upon it is mounted the automatic speed regulator. The principle upon which this works is shown in Fig. 40. The regulating shunt around the fields and the brush shifting mechanism are simultaneously actuated by the dogs thrown into gear by the governor. This form of governor is very generally used for the motors upon the system.

The efficiency of both generator and motor under test has

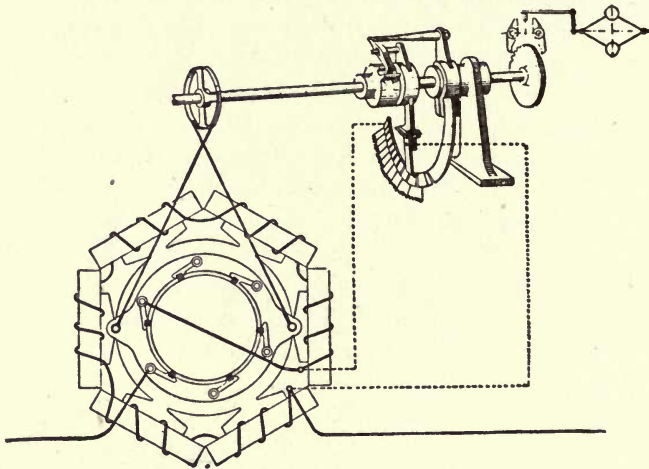

FIG. 40.

been shown to be 93.5 per cent, or 87 per cent for the complete unit. Similar motor-generators in connection with a storage battery furnish current at 550 volts for railway service.

Now the drop in the line at full load is 6 per cent, so that we are in position to make a very close estimate of the efficiency of the system from waterwheel to low tension mains. It is obviously

$$93.5 \times .94 \times .87 = 76.5 \text{ per cent.}$$

This is a very creditable figure for the total efficiency, and it is worth while comparing it with the results ordinarily reached in polyphase working. Taking the generator at 94 per cent, the raising and reducing transformers at 97.5 per cent each, the

line at .94, and the distributing banks of transformers at 96.5, we have

$$.94 \times .94 \times .975 \times .975 \times .965 = .81.$$

The difference is substantially that due to the difference in efficiency between the static transformers and the motor generator. If the comparison be made with the railway part of the proposition, assuming the use of a rotary converter, the case would stand about as follows:

$$.94 \times .94 \times .975 \times .975 \times .94 = .79.$$

In the simple case of large motors the advantage lies rather the other way, for the constant current plant would show

$$.935 \times .94 \times .935 = 82.1$$

against, for the alternating plant,

$$.94 \times .94 \times .975 \times .975 \times .94 = .79.$$

This merely indicates that after passing the voltages which can be derived directly from the armature, more is lost in the transformers than is gained in a low voltage winding. The figures for the efficiency of the alternating plant are taken from actual data on machines of about the capacity concerned. To tell the unvarnished truth, a constant current transmission coupled with a three wire distribution at 220 to 250 volts on a side is capable of giving even the best alternating system a pretty hard rub over moderate distances. In this country no constant current power transmission machinery is available, but where it is readily to be had, it is by no means out of the game. A still larger constant current transmission plant is now in operation between the falls of the Rhone at Saint-Maurice, and Lausanne, a distance of 34.8 miles. The first installation is of five pairs of generators aggregating 3,300 KW, giving at full load a combined voltage of 23,000. The current in this case is 150 amperes, as in the Combe-Garot plant just described.

POWER TRANSMISSION AT CONSTANT POTENTIAL.

The transmission of power to series-wound motors at constant potential is a branch of the art which as regards station-

ary motors has been developed only in special cases. It is, however, the method universally employed for electric railway work. Two or three sporadic efforts have been made to operate electric railway systems at constant current, but with such indifferent success that the method has been abandoned. Counting in electric railways, it is safe to say that at present the majority of all electrical power transmission in the world is done with series motors worked at constant potential or as nearly constant potential as may be practicable. As before mentioned, regulation is generally obtained through the use of rheostats in series with the motors, thereby cutting down the applied voltage, or by throwing the motors either in parallel or in series with each other, or in the third place by a combination of the above methods. Concerning the operation of motors thus arranged, sufficient has been said to explain the situation clearly. The general good properties of the method are most prominently exhibited in the simplicity of the motor windings and the very powerful effort which can be obtained in starting the motors from rest. These properties are of extreme value in railway service.

Aside from the operation of electric railways, series motors at constant potential are frequently employed for hoists and similar work where a powerful starting torque and considerable range of speed at the will of the operator are desirable. In spite of the large use of motors for such purposes, there are no plants either here or abroad which may be said to be operated exclusively after this method, for it is generally found desirable to combine in the same system series-wound motors for severe work and shunt-wound motors for purposes where uniform speed is of prime importance. As a rule the power transmission so accomplished is over a comparatively small distance and really involves the problem of distribution more than transmission alone. A very large number of electric hoists designed by different makers are in use at various points throughout this and other countries, doing service in mines, operating elevators of one kind or another, working derricks, and travelling cranes and employed for a large variety of similar purposes. Many of the motors employed are of the ordinary railway type.

The voltage utilized for this work, in America at least, is usually either 200 to 250 volts or 500 to 600 volts, the former being most generally used in mines, where difficulties of insulation are considerable, or in operating motors supplied by three-wire systems already installed. The latter voltage is generally selected for work above ground. None of the plants so equipped are, however, sufficiently large or characteristic to be worth a detailed description. The power installations and the methods of distribution are in general, closely similar to those employed for electric railway work. Plants of higher voltage than from 500 to 600 are so infrequent as to be hardly worth considering in practical engineering. It is perfectly possible to wind series motors for voltages considerably exceeding this figure, say for 1,000 or 1,200 volts, or, in rare cases, more, provided the units are of tolerable size, but inasmuch as most plants for the distribution of power require both large and small motors, wound both series and shunt, the general voltage is in nearly every case kept at a point at which it will be easy to meet these varied requirements; therefore 500 volts, the American standard for railway practice, has usually been selected.

The only noteworthy exception may be found in the use of the Edison three-wire system for distribution of power to railway and other motors. By this method it becomes possible to transmit the power at the virtual voltage of 1,000 and to employ 1,000 volt motors, either series- or shunt-wound for the larger units in order to help in preserving the general balance, while at the same time using motors of all sizes with any kind of direct current winding, connected between the middle wire and either of the outside wires. The advantages of such an arrangement are very evident, and if the number of motors be considerable, so that it is possible to balance the system with a fair degree of accuracy, we have at our disposal a very convenient method for the distribution of continuous currents. It is interesting to note that this scheme found its first considerable development in electric railway service itself. Of course, the use of both 110 and 220 volt motors on Edison three-wire systems is very common, but the extension of the plan to operating electric roads, and under conditions which

as regards balance are somewhat trying, is a considerable step toward an individual method.

The method of working electric railways on the three-wire system is well shown in Fig. 41. Here the road is a double track one, to which the method is generally best suited. The ground, track, and supplementary wires serve as a neutral wire, both tracks being placed in parallel for this purpose and thoroughly bonded. On a double track road, the cars running on each side of the system will be substantially the same in number, and if the total number of cars be considerable, a very fair balance can be obtained, although never as good as is customarily and necessarily used in an Edison three-wire system for lighting. In order to still further improve the balance of the system and prevent its being disturbed as

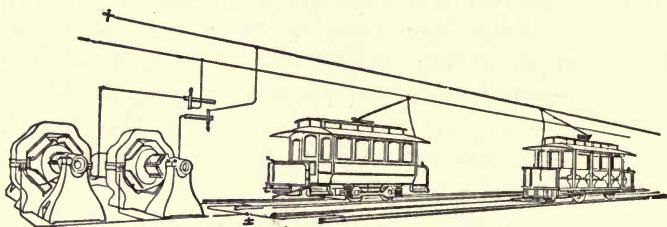

FIG. 41.

might otherwise occur by a blockade on one track at some point, it is better to make the trolley wire above each track consist of sections of alternate polarity and of convenient length, so that even in case of a blockade, stopping a considerable number of cars, the load would be removed almost equally from both sides of the system.

Installed in this way, a railway system is operated at a virtual voltage of 1,000, and the saving of copper over the ordinary distribution at 500 volts is considerable, in spite of the inevitable lack of balance and the loss of the track as part of the main conducting system. Nevertheless, the three-wire distribution for tramways has proved generally unsatisfactory on account of the complication of the overhead wiring and the difficulty of preserving balance, so that it has entirely disappeared from

American practice. A few years ago it was tried in Bangor, Maine; Portland, Oregon; and experimentally elsewhere, but was abandoned after no very long experience as troublesome and unreliable. It has found some use abroad, even in a few recent plants, and is reported to be successful in spite of the difficulties here mentioned.

In several of these foreign plants the voltage from either lead to the neutral is 750 to 1000 volts, and each car has its motors coupled in pairs so as to form a self-contained 3-wire unit. In this form a very important saving in copper is effected; and there is a good chance for successful distribution of power over considerable lines.

INTERDEPENDENT DYNAMOS AND MOTORS.

Aside from the distribution of power for railway purposes, by far the most interesting kind of power transmission by continuous currents is that in which a special combination of two series machines is employed, giving a self-regulating system comprising a motor unit and a generator unit. This plan has been successfully used abroad, but has never been employed in American engineering practice except in an experimental and tentative way, owing largely to the difficulties that have been encountered in the production of large direct-current generators for high voltage.

While it is not at all a difficult matter to build a machine giving five or six thousand volts with a rather small current, such as is used in arc lighting, the troubles at the commutator have proved forbidding when any attempt has been made to use currents large enough to obtain units of any considerable size. Power transmission in this country took its first stimulus from the development of polyphase apparatus and methods, and consequently, so far as the art has now been carried forward, it has been almost wholly in the line of alternating current work. It is obvious, nevertheless, that a system of power transmission such as we are considering, possesses great convenience where single units are to be operated over moderately long distances. In the first place, the induc-

tive difficulties familiar with alternating currents are avoided. In the second place, the motors are self-starting under load, a condition that was not true of alternating machinery prior to the introduction of the polyphase system. Through the energy of several foreign engineers, notably Mr. C. E. L. Brown, much was done in power transmission by this method long before alternating current apparatus had been suitably developed. The same difficulties were encountered abroad as here. It proved to be very difficult to build machines of sufficient voltage and of any considerable output.

In this connection it is noteworthy that nearly all the plants of this character on the Continent have been installed at relatively low voltages, most of them less than 1,000, corresponding in general character to the American plants over similar distances worked at constant potential. In the very few instances where long distances have been attempted, the usual method has been to employ generators and motors permanently connected together in series, on account of the impracticability of getting sufficient power in one unit at a very high voltage. This proceeding somewhat complicates the system. In addition, the generators and motors have to be especially designed for each other in order to secure regulation; which, of itself, is a considerable disadvantage.

This last difficulty may be in part avoided by using a shunt around the field coils of the generator, thereby changing its regulation under variations of current. A similar device is widely used in this country in connection with compound-wound generators, where a shunt applied across the terminals of the series coils is used to regulate the compounding. In either case, the obvious result of such a shunt is to diminish the change in the field produced by a given increase in current. In this way the necessity for special machines can be partially obviated. The plants installed on this peculiar series plan have been uniformly successful, and permit of the convenient transmission of moderate amounts of power over considerable distances. Such plants have even been employed in connection with motor-generators to supply a general distribution system, though evidently at a high cost for apparatus.

In order to distribute low tension currents from such a transmission system, it is necessary to employ either a motor, coupled to a dynamo, or a composite machine with a double winding, as in case of transmission at constant current. Either alternative involves the loss of energy substantially equivalent to that lost in two dynamo-electric machines of the capacities concerned. These losses are necessarily much more serious than those in an alternating current transformer, as has already been seen. They are likely to amount to from 12 to 15 per cent, so that quite aside from the efficiency of the generating dynamo and of the line, the price paid for the privilege of obtaining a low tension current is considerable.

For the delivery of power alone, where motors in series coupled to appropriate generators can be used, the method is well fitted for use under certain circumstances and is closely approximate in efficiency to that which would be obtained by an alternating current transmission over the same distance. It is worth mentioning that one of the longest of the early power transmissions was operated upon this now obsolescent system.

CONSTANT POTENTIAL SYSTEMS.

Shunt- or compound-wound generators used in connection with shunt-wound motors have found very extensive use in this country, working over inconsiderable distances. The very obvious advantage of such a system is that it permits the ready distribution of power as well as its easy transmission. If it becomes necessary to transmit power from one point to another, the chances are much more than even that at the distributing end of the line it will be desirable to utilize the power in a number of units of varying size. Such an arrangement bars out transmission from series dynamos unless upon the constant current system with its inherent difficulties of regulation, whereas with shunt-wound apparatus the problem is easy. It often happens, as previously mentioned, that at the receiving end both series and shunt motors are used, the former for hoisting and similar work, the latter for operation at constant speed.

The growth of the electric railway has encouraged the establishment of such transmission plants, and their number is very considerable, scattered over all parts of the Union, not a few of them being in the mining regions of the Rocky Mountains and on the Pacific coast, as well as in various isolated plants through the rest of the country. In most of them, the distances being moderate, an initial voltage of from 500 to 600 has been employed; more rarely, voltages ranging from 1,000 to 1,800. Plants of these latter voltages have now generally been replaced by polyphase machines. The efficiency of this method of transmission is about the same as that of the series method, just described, but with the advantage that the shunt motor supplied at constant potential can advantageously be distributed wherever the work is to be done, while with interdependent series units any distribution of power has to be accomplished by means of shafting and belting or its equivalent.

The net efficiency from generator to driven machine is likely to be rather better with the transmission at constant potential than in the case just discussed. The generators and motors are of nearly the same efficiency; the line at ordinary distances is customarily worked at about the same pressure in both methods, but distribution by shafting is far less efficient at any but short distances than distribution of electric power by wire. The loss from the centre of distribution to individual motors will very seldom exceed 5 per cent, while the loss in equivalent shafting will seldom be less than 10 per cent, and more often 20 or more; in fact, it generally turns out upon investigation that so far as efficiency is concerned there is a noticeable saving in transmitting power electrically, even within the limits of a mill or large factory, over the results which can be obtained by the use of transmission by shafts and belts. In a large building where the power is to be widely distributed, it seldom happens that the loss in the shafting is less than 25 per cent. Anything in excess of this figure represents remarkably good practice. With motors, 80 per cent efficiency, if the units are of tolerable size, can be reached without much difficulty, and there are comparatively few cases where the efficiency need fall lower than 75. In such a plant, installed some years since in a Belgian gun factory,

and described in the last chapter, the guaranteed efficiency was 76.6 per cent. As the efficiency of the dynamo was reckoned at but 90 per cent, the total efficiency would in practice be raised without difficulty to 78 or 79 per cent at full load.

As regards efficiency in general, aside from the disadvantages previously mentioned in changing the voltage of direct current circuits, the efficiency of transmission by such currents is in itself as high as has ever been reached by other means. There is no material difference between the efficiency of direct and alternating current generators, nor between the efficiency of direct current motors and the polyphase motors, at least, among alternating motors. In these particulars, the direct current is able to hold its own against all comers, and in the cost of motors it has at present a material advantage.

The most important recent improvement in d. c. motors is the so-called "interpole" construction, which effects such an automatic shifting of the neutral points of the armature as to ensure almost complete abolition of sparking even under great variations of load and field strength. Fig. 42 shows diagrammatically the features of the interpole construction. Small intermediate pole pieces are provided bearing series windings which give a cross magnetization, opposing that created by the armature windings, and thus prevent that displacement of the field which is a prolific source of sparking. The series turns form a species of compound winding which neutralizes the distortion of the field. The general idea of providing a special field for this purpose is an old one, but it is only recently that designers have gone to the length of providing extra pole pieces to effect the result.

The device is most useful and checks sparking even under severe overloads and great reductions in field strength. It is particularly valuable in motors designed, as in industrial plants, to operate over a great range of speed, and has also been applied extensively to railway motors. It can, of course, be made similarly useful in generators, and when skillfully applied, seems to be almost a panacea for field distortion. It has, of course, limitations, just as compound winding has, but for all that it meets very successfully many difficult conditions. The additional poles involve some extra cost in material and labor, not enough, how-

ever, to be a serious matter in the class of work in which extreme variations in load and speed are necessary.

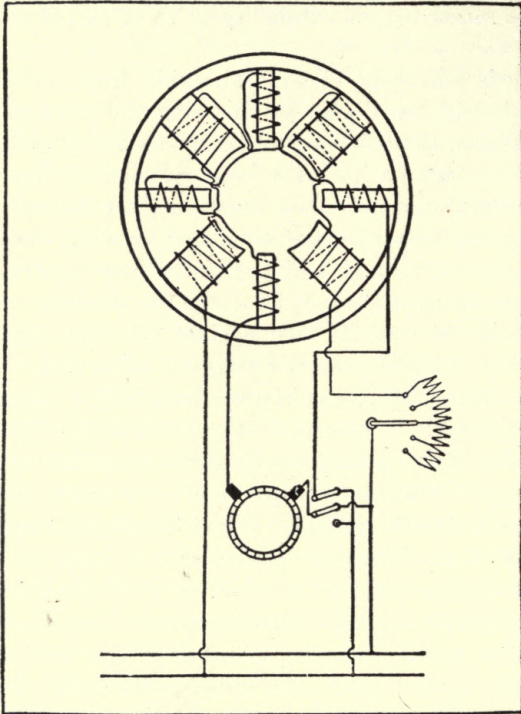

FIG. 42. CONNECTIONS OF INTERPOLE MOTOR.

current is able to hold its own against all comers, and in the cost of motors it has at present a material advantage.

As regards transmission of power over considerable distances, a case has already been mentioned in which the result is as good as can reasonably be expected. Direct current, however, continually runs into the limitation of available voltage as soon as distribution is to be attempted. Where single or a few large motor units are to be used, consisting of either single machines or groups operated as a unit, the efficiency of the system is likely to be as high as that obtained from units of similar magnitude on alternating current systems. The only disadvantage of the direct current in point of efficiency in this particular case is that if the amount of power to be transmitted be large, it is necessary to use generators and

motors coupled in series, while if alternating currents were used, one would have the advantage of employing a single machine of equivalent capacity. The principal disadvantage of direct current machinery is the commutator, which at high voltages is likely to be sooner or later the source of considerable trouble. Careful mechanical and electrical construction may materially reduce this difficulty, but it always remains to be faced, and is liable at any time to become troublesome.

On long lines, the direct current has the advantage of producing no inductance in the line, an advantage, however, which does not apply to plants which can advantageously be operated as single units. Such a single unit system, arranged for alternating currents, can have the inductance of the circuit completely nullified by the simple expedient of strengthening the field of the motor.

It must be remembered, however, that in several particulars continuous current has peculiar advantages. In the first place, it is well known that a direct current is decidedly less dangerous than an alternating current of the same nominal voltage, so far as the question of life is concerned. The difference between the two is even greater than would be indicated by the difference in maximum voltage.

An alternating current has a maximum voltage of approximately 1.4 times its mean effective voltage, and in addition to this an alternating current is certainly intrinsically more dangerous by reason of the greater shock to the nervous system produced by the alternations of E. M. F. The ease of transforming alternating current to a lower voltage partially obviates this objection, but the fact remains. So far as danger of fire is concerned, the continuous current has the power of maintaining a much more formidable arc than an alternating current of the same effective voltage; but, on the other hand, the alternating current has somewhat greater maximum voltage with which to start the arc, so that, practically, honors are even.

The increase of experience with resonance and kindred phenomena, acquired on long lines and at high voltages, has emphasized the fact that alternating transmission work is not exactly a bed of roses for the engineer, and when it comes to

a question of transmission at 60,000 volts or so, difficulties multiply. At and above this pressure, there can be little doubt that insulation is a very difficult task, and there is equally little doubt that of two lines, one constant current and the other polyphase, transmitting the same energy at the same effective voltage, the former would be in trouble much less frequently than the latter. In the first case there are but two wires involved, while in the second there are certain to be three, and generally considerations of inductance would lead to not less than six in a plant of large size. And when the point is reached where insulation is a costly matter, the extra wires and precautions may easily outweigh any intrinsic saving in copper. The constant current plant, too, always has the advantage that it is only working at its maximum voltage during the peak of the load and the rest of the time has a very considerable factor of safety.

Whether the increased cost and complication of the generating station of a constant current system can ever be endured for the sake of these advantages is a matter open to discussion; it certainly cannot be answered in the negative offhand, however. The continuity of service possible in an alternating plant materially above 60,000 volts is an unknown quantity, and in the absence of data upon this point one is not justified in estimating the importance of an alternative method.

Recent experiments seem to indicate that the insulation adequate, say for 50,000 volts a. c., will stand something like 100,000 volts d. c., without reducing the factor of safety. Part of this difference is of course due to the fact that the crest of the a. c. wave is 40 to 50 per cent above the nominal rated voltage. For the rest, a direct current is free from the surges and minor resonance that impose added strains on the a. c. circuit. How far this advantage is practically important depends mainly on the ability of the insulator maker to produce insulators capable of use with adequate factors of safety at a. c. voltages much above those now in use. Some promising insulators designed to carry the wire in suspension have recently been introduced, and are said to test out successfully on pressures as high as 250,000 to 300,000 volts. If these claims are substantiated the cases in which direct current would be preferable on account of easier insulation would be very few. In the matter of one of

the great dangers to an overhead line and apparatus, *i.e.*, injury from lightning, direct current has a very material advantage in that it is possible to use coils of considerable self-induction in connection with such circuits, so as to keep oscillatory or impulsive discharges out of the machines. This is well shown in the singular freedom of arc lighting stations from serious damages to the machines by lightning, as compared with stations containing other kinds of electrical apparatus. In this case the magnets of the arc machines themselves act as a powerful inductance, tending to throw the lightning to earth. High voltage shunt-wound dynamos and alternators are much more sensitive in this respect.

Consequently, part of the price one has to pay for the privilege of utilizing alternating currents is extra care with respect to protective devices against lightning. In the present state of the art, the best field for combined transmission and distribution of power by continuous currents is in cases involving distribution over moderate distances, within, say, a couple of miles from the centre of distribution, and even then in problems where lighting is not an essential part of the work. The voltage of a lighting circuit is determined by the voltage of the lamps which can be employed upon it, and this is so limited that if lighting is to be done on the same circuit as power distribution there are few cases where such a combined system can be successfully used with continuous currents. The field seems at present to be somewhat widened by the advent of 3-wire systems at 220 to 250 volts on a side, but their place in the art is hardly yet secure, although their use is extending.

At all long distances continuous current is at a disadvantage in point of available voltage where distribution is to be done, and has in most cases no very material advantages for single unit work. It will require considerable further advance in dynamo building to render continuous current thoroughly available for high voltages, and even then only in units of moderate size, say 300 to 400 KW. In this lies its weakness. Its strength is largely in its present firm foothold in electrical practice, and in the fact that standard apparatus for continuous currents is available everywhere, and is manufactured

cheaply in large quantities by numerous makers. It is, furthermore, interchangeable to a degree which will never be true of alternating-current machinery until there is far greater unity in alternating-current practice than we are likely to have for some years to come.

CHAPTER IV.

SOME PROPERTIES OF ALTERNATING CIRCUITS.

WE have already seen in Chapter I that the current normally produced by a dynamo-electric machine is an alternating one, so that a continuous current exists in the external circuit only in virtue of the commutator. Until within the last fifteen years the original alternating current was utilized to but a trivial extent. Nevertheless, it possesses certain properties so valuable that their practical development has wrought a revolution in applied electricity.

To describe these properties with any degree of completeness would require several volumes the size of the present, and would involve mathematical considerations so abstruse as to be absolutely unintelligible to any save the professional reader. We shall therefore at the very start drop the academic methods of treatment and confine ourselves, so far as possible, to the physical facts concerning those properties of alternating currents which have a direct bearing on the electrical transmission of energy. This discussion will therefore be somewhat unconventional in form, although adhering rigidly to the results of experiment and mathematical theory. The student who is interested in the exact development of this theory will do well to consult the excellent treatises of Fleming, Mascart and Joubert, Bedell and Crehore, and Steinmetz, all of which are full of valuable demonstrations.

The fundamental differences between the behavior of continuous and of alternating currents lie in the fact that in the former case we deal mainly with the phenomena of a flow of electrical energy already steadily established, while in the latter case the phenomena of starting and stopping this flow are of primary importance. These differences are akin to those which exist between keeping a railway train in steady motion over a uniform track, and bringing it up to speed from a state of rest. In steady running the amount of, and the

variations in the power needed, depend almost wholly on the friction of the various parts, while in starting both the power and its variations are profoundly affected by the inertia of the mass, the elasticity of the parts, and other things that cut little figure when the train is up to a uniform speed.

The characteristic properties of alternating currents are due mainly to the starting and stopping conditions, and are only incidentally affected by the circumstance that the flow of current alternates in direction. As, however, this alternating type of current is in general use and its uniform oscillations give the best possible opportunity for observing the effect of repeated stops and starts, we will look into the generation of alternating current, not forgetting that for certain purposes we shall

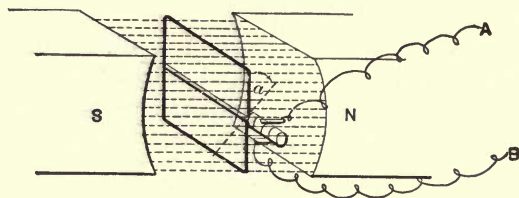

FIG. 43.

have to recur to the phenomena of a single stop or start in the current.

Fig. 43 shows an idealized generator of alternating currents. It is composed of a single loop of wire arranged to turn continuously in the space between the poles of a magnet. This space is a region of intense electromagnetic stress directed from pole to pole, as indicated by the dotted lines. The two ends of the loop are connected to two insulated metallic rings connected by brushes to the terminals *A* and *B* of the external circuit. We have already seen that what we call electromotive force appears whenever the electromagnetic stress about a conductor changes in magnitude. Now, in turning the loop as shown by the arrow, the electromagnetic stress through it changes, and of course sets up an electromotive force. In the initial position of the loop shown in Fig. 43, it includes evidently the maximum area under stress; after it has turned through an angle α , this area will be much lessened, and when

$a = 90^\circ$, the loop will be parallel to the plane of the electromagnetic stress, and hence can include none of it at all.

But the resulting electromotive stress is, other things being equal, proportional to the rate at which work is expended in uniformly turning the coil, *i.e.*, it is proportional to the *rate of change* in the electromagnetic stress included by the coil. This rate is, during a single revolution, greatest when the sides of the loop are moving directly across the lines of stress, and least when moving nearly parallel to them. Hence, we see from Fig. 43 that the electromotive force in our coil will be a maximum when $a = 90^\circ$ or 270° and a minimum in the two intermediate positions. For a simple loop it is easy to compute exactly the way in which the electromotive force will vary as the loop turns. The area of strain included by the coil in any

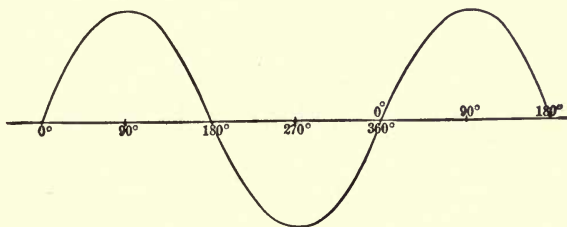

FIG. 44.

position is proportional to the cosine of the angle a , hence, for uniform motion the rate of change in the area is proportional to the sine of a . Therefore, the E. M. F. at every point of the revolution is proportional to $\sin a$.

If now we draw a horizontal line and measure along it equal distances corresponding to degrees, and then, erecting at each degree a line in length proportional to the sine of that particular angle, join the ends of these perpendiculars, we shall have an exact picture of the way in which the E. M. F. of our loop rises and falls. Fig. 44 is such a curve of E. M. F. — a so-called “sine wave,” which is expressed by the equation, $E = E_1 \sin at$.

This simple form of E. M. F. curve — the “sine wave” — is assumed to exist in most mathematical discussions of alternating current to avoid the frightful complications which would

result from assuming such E. M. F. curves as often are found in practice. This assumption is somewhat rash, for a true sine wave is never given by any practical generator, but the error does not often invalidate any of the conclusions, for the exact form of the wave only matters in discussing certain cases, where it can often be taken into account without much difficulty.

Actual alternating generators give curves of E. M. F. greatly influenced by the existence of an iron armature core which collects the lines of force so that as the core turns the change of stress through the armature coils is not directly proportional to anything in particular. A glance at the rudimentary dynamo of Fig. 8, Chapter I, will suggest the reason. It is evi-

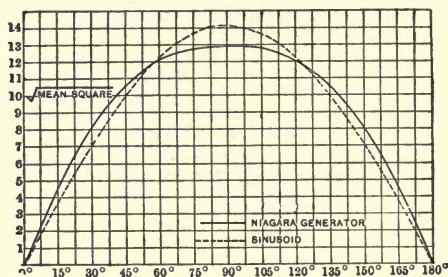

FIG. 45.

dent enough that the armature could turn almost 30° from the horizontal with scarcely any change in the magnetic relations of the coils. The result would be a wave with a very flat and depressed top, since the rate of change of induction would be very moderate when it should be considerable. The practical bearings of wave form on power transmission work will be taken up in the next chapter. At present it will suffice to say that the best standard alternators give a fairly close approximation to the sine form. Fig. 45 shows the E. M. F. curve of one of the great Niagara generators. This is an excellent example of modern practice and shows a form slightly flatter than the sine curve and with a mere trace of depression at the crest. Plenty of machines are in operation, however, that give curves not within hailing distance of being sinusoidal — *e.g.* Fig. 46, which shows the E. M. F. curve of one of the earliest alternators

designed for electric welding. In this case there is a far sharper wave than the sinusoidal, of a curious toothed form. Many of the early alternators with ironclad armatures gave curves quite far from the sine form, generally rather pointed, while the tendency in recent machines has been rather in the opposite direction, toward curves like Fig. 45, although seldom so nearly sinusoidal. The general equation for their E. M. F. is,
 $E = E_1 \sin at + E_3 \sin 3 at + E_5 \sin 5 at \dots E_{(2n-1)} \sin (2n-1) at.$

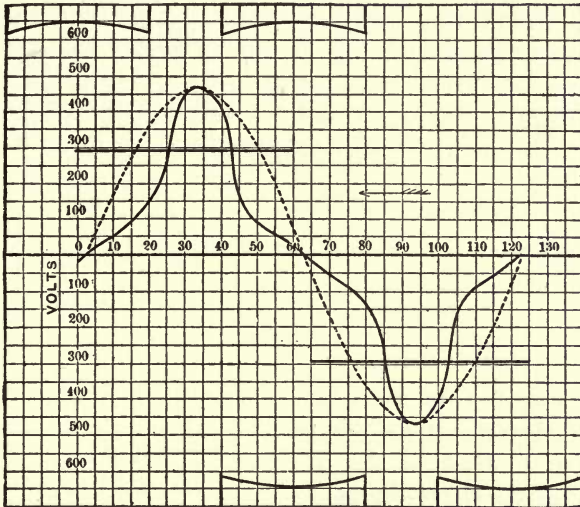

FIG. 46.

In other words, the E. M. F. is built up of the fundamental frequency and its *odd harmonics*.

Now as to the current produced by this oscillating electro-motive force. In ordinary work with continuous currents, the current corresponding to each successive value of the E. M. F. would be very easy to determine by simple reference to Ohm's

law, $C = \frac{E}{R}$. If the dynamo of Fig. 43 gave one volt maximum

E. M. F. and were connected through a simple circuit of one ohm resistance the maximum current would be one ampere, and the current at all points would be directly proportional to

the voltage. Hence if the E. M. F. varied as shown in Fig. 44, the current would vary in precisely the same manner, and the curve showing its variation would, if drawn to the same scale, exactly coincide with the curve of Fig. 44. This would be generally true if we had only resistance to consider, and the treatment of alternating currents would then be very simple.

But the starting and stopping of current which takes place periodically in alternating circuits produces great changes in the electro-magnetic stresses about the conductors, and these changes are in turn capable of very important reactions. They give to the alternating current its most valuable properties, but also involve its action in very curious complications.

Turn back to Chapter I and examine Fig. 4. We see from it that whenever the electro-magnetic stresses about a circuit

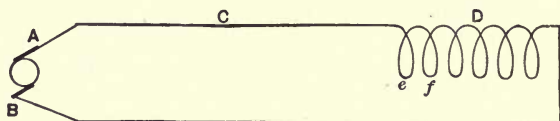

FIG. 47.

as A, change by the variation of the current flowing in it, an E. M. F. is set up in the parallel circuit B, opposing the change of E. M. F. in A. This fact, as we shall see later, is the root of the alternating-current transformer. Suppose now that in the circuit of our alternator is a coil of wire wound in close loops as shown in Fig. 47. Here A and B are the dynamo terminals, C the general circuit, and D the aforesaid coil. Let an E. M. F. be started in the direction A C D. The resulting current flows through D, but the electro-magnetic stresses set up by the current about, for instance, the loop e, produce an E. M. F. in neighboring coils tending to drive current in a direction opposite to that from the dynamo. In other words, e acts toward f just as A acted toward B in Fig. 4. Thus each turn tends to oppose the increase of current in the others. When the current in C ceases to vary, of course the reactive E. M. F.'s in e and f stop, for there is for the moment no change of stress to produce them, but as the main current begins to decrease, the reactive E. M. F.'s set in again.

The main or "impressed" E. M. F. is thus opposed in all its changes by the reactive or "inductive" E. M. F. due to the combined action of the loops at *D*. Hence the impressed E. M. F. in driving current through the system has to overcome, not only the resistance of the conductors, but opposing electromotive forces. Therefore since a part of the impressed E. M. F. is taken up with neutralizing the inductive E. M. F., only the remainder is effective against the true resistance of the circuit. Ohm's law, then, cannot apply to alternating circuits in which there is inductive action, except in so far as we deal with the "effective" E. M. F. The relation between the impressed E. M. F. and the current is not $C = \frac{E}{R}$, but $C = \frac{E}{R}$

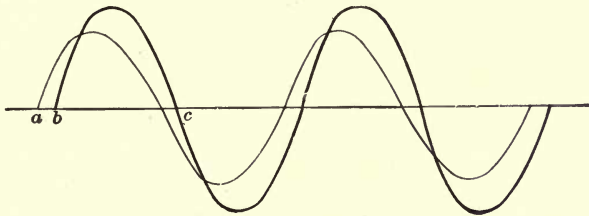

FIG. 48.

less a quantity depending on the amount of inductive E. M. F. encountered.

This state of things leads to two very important results: First, the current in an inductive circuit is less than the impressed E. M. F. would indicate. Second, this current reaches its maximum later than the impressed E. M. F. For the current depends on the effective E. M. F., and for each particular value of this the impressed E. M. F. must have had time to rise enough to overcome the corresponding value of the inductive E. M. F. The current is thus damped in amount and caused to lag in "phase" as shown in Fig. 48. The heavy line here shows the variations of the impressed E. M. F., and the light line the corresponding variations of current in a circuit containing inductive reaction — *inductance*. The distance *a b* represents the "angle of lag," while *b c* is 180° as shown in Fig. 44. Very similar relations are found in practice, although the lag is often greater than shown in the cut,

particularly when alternating motors are in circuit. Fig. 49 shows the curves of E. M. F. and current from a very small alternating motor at the moment of starting. The angle of lag in this case is a trifle over 45° , and the curves are much closer to sine waves than is usual.

The inductive E. M. F., as has already been explained, is due to the magnetic changes produced by the variation of the current. Just as in the dynamo of Fig. 43, the actual amount of E. M. F. is directly proportional to the rate of change in magnetic stress, which is in turn proportional to the change of current. The inductive E. M. F. is therefore at every point proportional to the rate of variation of the current. But the

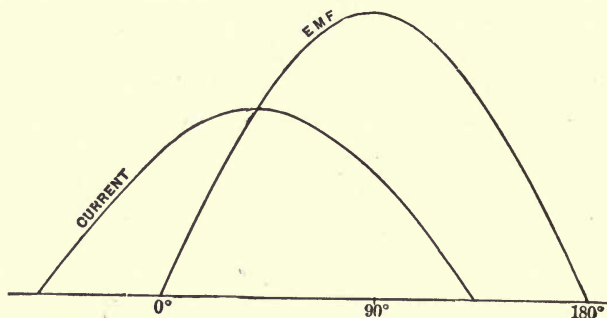

FIG. 49.

current wave is, like the impressed E. M. F. wave, still approximately a sine curve, for it has been merely shifted back through the angle of lag, and although damped, it has been simply changed to a different scale. Being still essentially a sine curve, its rate of variation is a cosine curve, or, what is the same thing, a sine curve shifted backward a quarter period, 90° . Indeed, this is at once evident, for, since the current varies most slowly at its maximum, the inductive E. M. F. must be a minimum at that point, *i.e.*, it must be 90° behind the current in phase, while since E. M. F. and current vary symmetrically, in general the forms of the two curves will be similar. The effective E. M. F. which is actually engaged in driving the current is a wave in phase with the current it drives, and of similar shape, *i.e.*, a sine curve.

We have, then, in an inductive circuit three E. M. F.'s to be considered:

- I. The impressed E. M. F., acting on the circuit.
- II. The inductive E. M. F., opposing I.
- III. The effective E. M. F., the resultant of I and II.

Plotting the respective curves, they bear to each other the relation shown in Fig. 50. Here a is the impressed E. M. F., b the effective E. M. F. (or the current) lagging behind a through an angle usually denoted by ϕ , and c is the inductive E. M. F. 90° behind b . Now since b is the resultant of the interaction of a and c , and we know that b and c are 90° apart in phase, it is comparatively easy to find the exact relation between the three.

For we can treat electromotive forces acting at known angles with each other just as we would treat any other forces work-

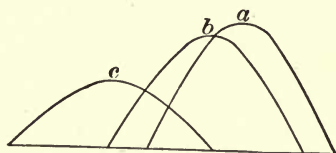

FIG. 50.

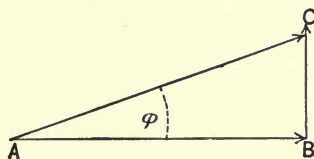

FIG. 51.

ing conjointly. If for example we have a force $A B$, Fig. 51, acting simultaneously with a force $B C$, at right angles to it, the magnitudes of the forces being proportional to the lengths of the lines, the result is the same as if a single force in magnitude and direction $A C$ were working instead of the two components. This is a familiar general theorem that proves particularly useful in the case in hand.

If we take $A B$ equal to the effective E. M. F., and $B C$ equal to the inductive E. M. F., then $A C$ is the impressed E. M. F. It at once appears that the angle between $A B$ and $A C$ is ϕ , the angle of lag. Then from elementary trigonometry it appears that

$$A B = A C \cos \phi$$

$$C B = A C \sin \phi = A B \tan \phi, \text{ hence}$$

$$\tan \phi = \frac{C B}{A B}.$$

We are therefore in a position to determine the three E. M. F.'s and the angle ϕ , knowing any two of the four quantities. Thus for a given impressed E. M. F., E , such as is found on any constant-potential alternating circuit, the effective E. M. F. which determines the current is given by $E \cos \phi$. As ϕ grows less and less through decrease of the inductive E. M. F., $A C$, the impressed E. M. F. necessary for a given current also decreases, and finally, when ϕ becomes zero, $A C = A B$. In other words, the impressed E. M. F. is then simply that needed to overcome the ohmic resistance.

For any particular current, then, $A B$ is directly proportional to the resistance of the circuit, while $C B$ is directly proportional to the "inductance" of the circuit, that property of the particular circuit which determines the inductive E. M. F. Calling this I we may redraw Fig. 51 in a very convenient form — Fig. 52. Here we see the relation between R and I in determining the impressed E. M. F. necessary to drive a certain current through an inductive circuit. The magnitude of the E. M. F. evidently is $\sqrt{R^2 + I^2}$ if the units of measurement are chosen correctly, and it is always proportional to this quantity, which is related to the impressed E. M. F. as resistance is to the effective E. M. F.

Hence $\sqrt{R^2 + I^2}$ has sometimes been called "apparent resistance." The more general name, however, is impedance, which indicates the perfectly general relation between E. M. F. and current. If I be zero, as in a continuous-current circuit, then the impedance becomes the simple resistance. We can now write out some of the general relations of current and E. M. F. in alternating circuits as follows, calling E the impressed E. M. F. as before:

$$C = \frac{E}{\sqrt{R^2 + I^2}}$$

$$E = C \sqrt{R^2 + I^2}$$

and with respect to the angle of lag,

$$\sqrt{R^2 + I^2} = \frac{E}{C}$$

$$I = R \tan \phi$$

$$\tan \phi = \frac{I}{R}.$$

Hence, knowing the angle of lag and the resistance of a circuit, the inductance can be found at once. The angle of lag, depending on the ratio of I and R , must be the same for all circuits in which this ratio is the same. Also in any circuit of given inductance, increasing the resistance diminishes the angle of lag, while of course also diminishing the current for a given value of E . In fact, since I does not represent work done, for the inductive E. M. F. represents

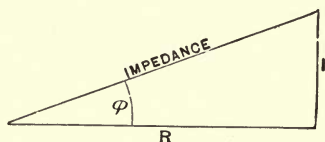

FIG. 52.

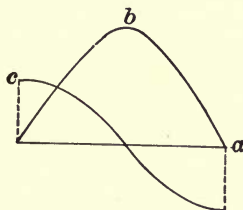

FIG. 53.

merely a certain amount subtracted from the impressed E. M. F. by the reaction of the circuit, any process which for a given value of E increases the energy actually spent in the circuit is accompanied by a diminution of the angle of lag.

This freedom of the circuit from any energy losses due to I is a fact of the greatest importance. It is fully borne out by experiment, and there is besides good physical reason for it. For since current and E. M. F. are the two factors of electrical energy, there can be no energy when the product of these factors is zero. Note now Fig. 53, developed from Fig. 50. Hence a is the line of zero E. M. F. and current, b the current curve for a single alternation, and c the corresponding curve of inductive E. M. F. 90° behind the current. When b is a maximum, c is zero, and vice versa. And since c is equally above and below the zero line during each alternation of current, the average E. M. F. is zero, and therefore the average energy throughout the alternation is zero. The

same conditions would evidently continue if instead of an alternation we took a complete cycle (*i.e.*, the whole curve from the time the current starts in a given direction until it starts in the same direction again) or any number of cycles. Thus I must be entirely dropped out of consideration in discussing the question of work done in an alternating circuit. And since E differs from E_1 , the effective E. M. F., only by a function of I , the energy value of which is zero, the energy in the circuit is exactly measured by E_1 and the corresponding current which, as we have seen, is in phase with it. But

$$E_1 = E \cos \phi.$$

Hence, multiplying both members of this equation by C to reduce to energy,

$$\text{Energy} = C E_1 = C E \cos \phi.$$

That is, the energy in an alternating circuit is equal, not to the impressed E. M. F. multiplied by the current, but to their product multiplied by the cosine of the angle of lag. The product $C E$ is sometimes called the apparent energy to distinguish it from $C E_1$, the actual energy. This apparent energy is that obtained by measuring the amperes and the impressed volts and taking their product. The real energy is that which would be obtained by putting a wattmeter in circuit. Hence

$$\frac{\text{watts}}{\text{volt-amperes}} = \cos \phi,$$

a convenient and common method of measuring the angle of lag. If in addition the value of I is wanted, it can be obtained at once from the expression for tangent ϕ already given.

We thus see that the energy in an inductive circuit is not directly proportional to the voltage as measured, but to the effective voltage, which is less by an amount depending on the inductance. This difference is sometimes referred to as the "inductive drop" in a circuit. The result is that to drive a given current through an inductive circuit the generator must give a voltage depending on the impedance of the circuit. On the other hand, if an inductive circuit be fed from

a given impressed E. M. F. the current required to represent a given amount of energy exceeds that required in a non-inductive circuit, in the ratio of 1 to the cosine of the angle of lag. The net result, then, of inductance in an alternating circuit is to increase the E. M. F. at the generator required to produce a given E. M. F. at the load, and to increase the current required to deliver a given amount of energy.

The E. M. F. and current are here supposed to be measured in the ordinary way, by properly designed voltmeters and ammeters. In power transmission work, inductance in the circuit (line or load or both) means that the dynamo has to give voltage enough to overcome the impedance of the system and still to deliver the proper number of volts at the motor, while the motor will take extra current enough to compensate for the lag between the E. M. F. at its terminals and the resulting current.

The dynamo thus has to be capable of giving a little extra voltage, and the motor must be able to stand a little extra current. In other words, both machines must have sufficient margin in capacity to take care of this matter of lagging current.

We have already seen the general relation between resistance, inductance, and impedance. Let us now look into the quantity last mentioned so as to see its numerical relation to the others. If a circuit has a certain resistance in ohms and a given inductance, what is its impedance, *i.e.*, the ratio between the measured voltage and the measured current?

The real question involved is the value of the inductive E. M. F. This, like any other E. M. F., is proportional to the rate of variation of the electro-magnetic stress which produces it. Its total magnitude depends on the rate of variation of the current and the ability of this current to set up stresses which can affect neighboring conductors as in Fig. 43. This latter property depends on the number of turns, their locality with reference to each other, and other similar conditions which depend simply on the physical nature of the circuit, and so for any given circuit are settled once for all. These properties are defined on the basis of their net effect, and the *ratio* of the rate of variation of the current to the inductive E. M. F. produced by it in a given circuit is usually known as L , the

“coefficient of self-induction” of that circuit. The total inductive E. M. F. is then equal to L , multiplied by the actual rate of current variation expressed in such units as will fit the general system by which E , R and other quantities are concordantly measured.

Expressed in this way, the rate of current variation in an alternating circuit is $2\pi n$, where n is the number of cycles per second, and π has its ordinary meaning of 3.1416. Hence the inductance of the circuit is numerically $2\pi n L$, the last factor being dependent on the nature of the circuit and denoting the inductance per unit rate of current variation. The $2\pi n$ factor gives the actual rate of current variation, which may change to any amount, while L remains fixed. L therefore may at all times in a given circuit be expressed in terms of

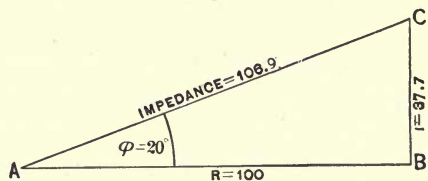

FIG. 54.

any unit that is conveniently related to other electrical units.

Such a unit inductance is the *henry*, which is the inductance corresponding to an inductive E. M. F. of 1 volt when the inducing current varies at the rate of 1 ampere per second.

If, therefore, L for any circuit is known in henrys, the total inductance I is $6.28 n L$.

We are now ready to apply a numerical value to I in Fig. 52 and the resulting equations.

For example, let us suppose that a certain alternating circuit has a resistance of 100 ohms and $L = 0.1$ henry. The impressed E. M. F. is 1,000 volts. What will be the current and its angle of lag? Lay off AB , Fig. 54, 100 units long. Then at B , to the same scale erect a perpendicular BC , $2\pi n L$ in height. If we are dealing with an alternating circuit of 60 ~ per second, such as is often used for power transmission, $2\pi n L$ will be 37.7 units high. Now join AC , and the resulting length on the same scale is the impedance in ohms. But

$A C = \sqrt{R^2 + I^2} = \sqrt{100^2 + 37.7^2} = 106.9$ nearly. And since the current equals the impressed E. M. F. divided by the impedance, the current in this case would be 9.36 amperes instead of the 10 amperes due if there had been no inductance. And since $\tan \phi = \frac{I}{R}$, it is here .377, which corresponds to an angle of $20^\circ 40'$.

Also, since $E = C \sqrt{R^2 + I^2}$, we can readily find the impressed E. M. F. required to produce in this circuit any given current. For $C = 10$ amperes, $E = 1,069$ volts, and so on.

We have seen that $\cos \phi = \frac{\text{watts}}{\text{volt-amperes}}$ so that in the case in hand where $\cos \phi = .936$ the actual energy in the circuit is 93.6 per cent of that indicated by the readings of voltmeter and ammeter.

This factor, $\cos \phi$, connecting the apparent and the real energy, is known as the "power factor" of the circuit.

As $I = R \tan \phi$, and in any given case n is known, L can readily be obtained from a measurement of lag in a circuit of known resistance. It must be remembered, however, that if the inductance is due to a coil having an iron core, the value of L will change when the magnetization of the iron changes, so that results obtained with a certain current will not hold exactly for other currents. The values of L found in practice cover a very wide range, from a few thousandths of a henry in a small bit of apparatus like an electric bell, to some hundreds of henrys in the field magnets of a big dynamo. L in fact is nearly as variable as R .

As a practical example in inductance effects we may consider the effect of alternating current in a long straightaway circuit. Suppose for example we have a circuit 50,000 ft. long composed of No. 4 B. & S. copper wires. The wires are about 1 ft. apart and about 20 ft. above the ground. What voltage will be required to deliver 10 amperes through this circuit at 130 cycles per second, and what will be the angle of lag? The resistance of this wire is 0.25 ohms per 1,000 ft. L , its coefficient of induction, is .0003 henry per 1,000 ft. The total resistance of the circuit is then 25 ohms, and its total induc-

tance, $I, = 6.28 \times 130 \times .03 = 24.5$. Plotting as before these values, in Fig. 55 we have the impedance equal to $\sqrt{25^2 + 24.5^2} = 35$ ohms. Hence E must be 350 volts instead of the 250 that would suffice in the case of continuous current. $\tan \phi = \frac{24.5}{25} = .98$. The corresponding angle is $44^\circ 25'$. The ratio of impedance to resistance in this case is 1.4:1. This ratio, often called the impedance factor, is a very convenient way of treating the matter, and tables giving its value for common cases will be given later. In case of apparatus being connected to the circuit, the computation of its effect is easy.

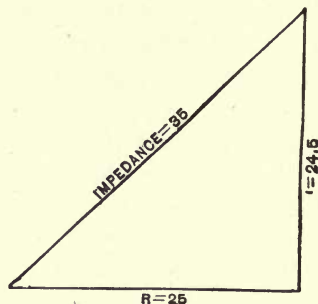

FIG. 55.

If it has resistance R^1 and inductance I^1 then the total impedance of the circuit will be $\sqrt{(R + R^1)^2 + (I + I^1)^2}$ and so on for any number of resistances and inductances, the impedance being always equal to the square root of the squared sum of the resistances plus the squared sum of the inductances. Thus an inductance added anywhere in circuit changes the total impedance and the angle of lag.

There are several ways of looking at inductance, according as one wishes to deal more particularly with inductive E. M. F., the changes in electro-magnetic stress which produce it, or the energy changes which accompany it. The first point of view is the one here taken, in accordance with the definition of the henry just given. Hence the henry may be called unit inductance, in which case the quantity I which we have been considering measures the inductive E. M. F., and since it is

the product of the inductance for unit rate of current change multiplied by $2 \pi n$, it is sometimes referred to as inductance-speed, now conventionally termed reactance.

In alternating-current working inductance may easily become quite troublesome, through the "inductive drop" in the line and the necessity of sometimes delivering a current quite out of proportion to the energy. Thus in alternating-current lighting plants during the hours of daylight when the actual load is small, the current may be of quite imposing size from the lag produced by the inductance of the unloaded transformers in circuit. The sort of thing which happens may readily be figured out. Suppose we are dealing with a transformer or other inductive apparatus having a resistance of 5 ohms and $L = 1$ henry. The impedance at 60 ϕ will then be $\sqrt{5^2 + (6.28 \times 60 \times 1)^2} = \sqrt{25 + 376.8^2} = 377.8$ ohms, substantially the same as the inductance alone, and under an impressed E. M. F. of 1,000 volts the resulting current would

be 2.65 amperes. But $\tan \phi = \frac{377.8}{5} = 75.56$. Hence $\phi = 89^\circ 15'$

and $\cos \phi = .013$. Therefore while the apparent energy is $2.65 \times 1,000 = 2,650$ watts, the real energy is only $2,650 \times .013$ watts = 34 + : really the loss due to heating the conductor. This is of course a very exaggerated case, as it takes no account of the energy that would be required to reverse the magnetization in whatever iron core the apparatus might have. It does, however, show very clearly that the current flowing depends practically on the inductance and very little on the resistance, and that the angle of lag is so great that the discrepancy between apparent and real energy may also be very great. In practice $\cos \phi$ may fall as low as 0.1 on single pieces of apparatus, and ranges up under varying conditions of load to .95 or more.

These practical considerations naturally raise a question as to the effect of impedances in parallel. The joint impedance of two impedances in series must first be discussed.

The resistance of two resistances in parallel is of course familiar. If $R = 2$ ohms and $R^1 = 4$ ohms, then their joint resistance is the reciprocal of the sum of their reciprocals,

thus,

$$(R + R^1) = \frac{1}{\frac{1}{2} + \frac{1}{4}} = 1\frac{1}{3} \text{ ohms.}$$

We have seen, however, that impedances cannot be added in the ordinary manner. If we take two impedances made up respectively of $R = 4, I = 3$, and $R^1 = 6, I^1 = 3$, we must proceed as in Fig. 56. The first impedance is 5, the second 6.70. The true impedance of the two in series is given by the dotted lines, and is 11.66, not 11.70. That is, the impedances must be added geometrically, since unless $\phi = \phi_1$ the arithmetical sum of the impedances does not represent the facts in the case.

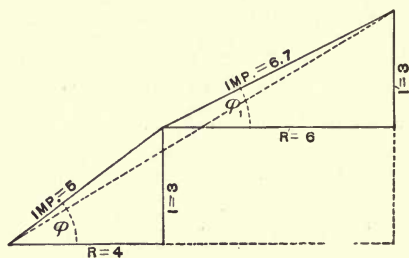

FIG. 56.

Similarly, while it is perfectly true that the joint impedance of two impedances in parallel is equal to the reciprocal of the sum of their reciprocals, the summation must be done as in Fig. 56 to take account of the difference of phase which may exist in the two branches. Taking the data just given, the reciprocals of the two impedances are .20 and .149 respectively. Drawing these on any convenient scale as in Fig. 57, preserving between them the angle due to the difference of phase as given by ϕ and ϕ_1 , we find the geometrical sum of the reciprocals to be .348, of which the reciprocal is 2.87. This is the joint impedance of the two which we have thus geometrically added.

This same process can be extended to any number of impedances in parallel. In a precisely similar way any number of directed quantities may be laid off and geometrically added, the final sum being in direction and magnitude the line from

the starting point to the finish. It is important to note that since the currents in such cases are generally not in phase with each other, it usually happens that the sum of the currents in the branches differs from the current in the main circuit, as they are ordinarily measured. It is in fact a prominent characteristic of alternating circuits that both currents and voltages are liable to vary in a way at first sight very erratic. Particularly is this the case when there is *capacity* in the circuit, a condition which we will now investigate.

By a circuit having capacity, we mean one so constituted that E. M. F. applied to it stores up energy in the form of electrostatic stress, which starts this energy back in the form of current when the constraining E. M. F. is removed.

Such a condition exists whenever two conductors are separated by an insulating medium, or dielectric, as in the ordinary condenser of Fig. 58. Here *A* and *B* are two metal

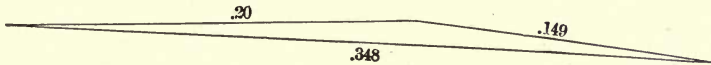

FIG. 57.

plates separated by a layer, *C*, of some insulating material. If now these plates are connected to the terminals of a dynamo they become electrostatically charged. The electrostatic stress tends to draw the plates together, and in addition sets up intense strains in the dielectric *C*, rendering potential thereby a certain amount of energy which flows into the apparatus in the form of electric current. This energy is returned as current if the original electromotive stress is removed and *A* and *B* are connected together. The medium behaves just as if it were a strained spring, and when it returns its energy to the circuit it does so spring-fashion with rapid oscillations, dying out the more slowly the less resistance they encounter.

The capacity of such a condenser is the quantity of energy which it can store up as electrostatic strains in *C*. It is proportional to the area of the plates, to the E. M. F. producing the strains, and to the "dielectric constant" of *C*, that is, the coefficient which for that particular substance measures its

power to take up electrostatic strains. Oddly enough the capacity decreases as C grows thicker, indicating that the intensity of the strain is the thing which counts rather than the volume of dielectric. Without knowing the exact character of electrostatic strain, it is difficult to get a clear mechanical idea of the state of things which causes the energy stored to increase as the thickness of C diminishes. A similar condition, however, holds for a wire held tightly at one end and twisted at the other; the shorter the wire, the more energy stored for a given angle of twist.

As in the case of inductance, for practical purposes the unit of capacity is taken in terms of unit pressure, *i.e.*, one volt. Unit capacity, then, in terms of energy, is the capacity of condenser in which one watt-second can be stored under an elec-

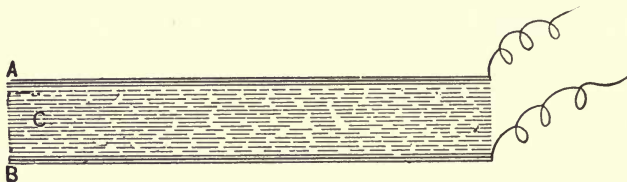

FIG. 58.

tromotive stress of one volt. This capacity is one farad, and as it is many thousand times larger than anything found in practice, $\frac{1}{1,000,000}$ of it (the microfarad) is more often used.

When a condenser is used with an alternating current, the rate at which energy is stored and delivered evidently increases with the frequency, or, what is the same thing, for a given alternating E. M. F. the greater the frequency the greater the *current* received and delivered by the condenser.

Numerically the current in a condenser of capacity k farads, supplied by an E. M. F. of e volts at n cycles per second, is

$$C = 2 \pi n e k,$$

which is simply the current due to e volts and k farads multiplied by the frequency expressed in angular measure. Thus, if we have a 2 microfarad condenser fed by an alternating

E. M. F. of 2,000 volts and 130 cycles per second, the current flowing is

$$C = \frac{2,000 \times 6.28 \times 130 \times 2}{1,000,000} = 3.26 \text{ amperes.}$$

In such an alternating circuit, then, there will be a substantial current flowing in spite of the fact that there is a break in the conductor at the condenser. In short, the circuit acts as if it

had a resistance of $\frac{2,000}{3.26} = 613$ ohms, which is the impedance of

the circuit. More exactly the impedance is $\frac{1}{2 \pi n k}$. It should

be noted here that some writers refer to this fundamental condenser function $(2 \pi n) k$ as capacity-speed. Capacity-impedance really is a *negative reactance*, often termed *condensance*.

To see the relation which this capacity-impedance bears to other impedances in the circuit, it is necessary to look into the properties of the E. M. F. of the condenser. As energy is stored in the condenser the opposing stresses in it increase until the applied E. M. F. can no longer force current into it and the condenser is fully charged. At the moment, then, when current ceases to flow, the E. M. F. of the condenser tending to discharge it is at a maximum. Hence, since the one has a maximum as the other is zero, the E. M. F. of the condenser and the charging current are 90° apart in phase.

But the inductive E. M. F. is also 90° from the current, and, as we have seen, lagging. It has its maximum when the current is *varying most rapidly*; and when the strength of current in a given direction is increasing, the inductive E. M. F. in the same direction is diminishing, as shown in Fig. 53. As regards capacity, however, the moment of maximum condenser E. M. F. in a given direction is that at which the current thereby becomes zero, so that as the current changes sign it has behind it the thrust of the full E. M. F. of the discharging condenser, while at the same moment, as we have just seen, the opposing inductive E. M. F. is at its maximum. Hence the E. M. F. of the condenser has a maximum in one direction when the inductive E. M. F. has its maximum in the other direction. The two are thus 180° apart in phase, and each

being 90° from the current, the condenser E. M. F. must be regarded as 90° ahead of the current, just as the inductive E. M. F. is 90° behind it.

The condition of affairs is shown in Fig. 59. Here aa is the line of zero current and E. M. F. All quantities above this line may be regarded as $+$, and all below it as $-$; b is a $+$

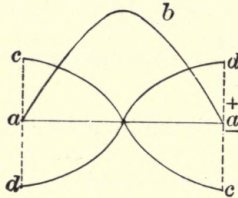

FIG. 59.

wave of current to which appertains cc the curve of inductive E. M. F. lagging 90° behind the current, and dd the condenser E. M. F., leading the current 90° .

It is evident that these two E. M. F.'s always are opposing each other — when one is retarding the current the other is accelerating it, and vice versa.

The condenser E. M. F. has no effect on the total energy

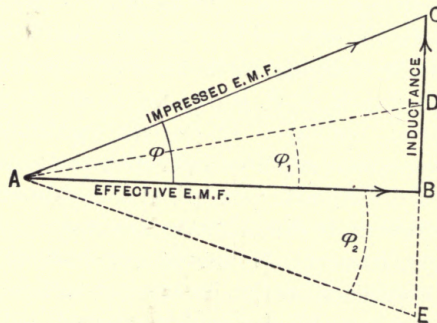

FIG. 60.

of the circuit for the same reason that held good in respect to Fig. 53; it is obviously akin to a spring, alternately receiving and giving up energy, but absorbing next to none.

Capacity may be considered as negative inductance in many of its properties. If, as in Fig. 59, it is in amount exactly

equivalent to the inductance, the total effect on the circuit is as if neither capacity nor inductance were in the circuit. In such case it is as if CB , Fig. 51, should be reduced to zero. The impressed E. M. F. then becomes equal to the effective E. M. F., the angle of lag vanishes and the circuit behaves as if it contained resistance only. If the condenser E. M. F. is not quite large enough to annul the inductance it simply reduces it.

Fig. 60 illustrates the effect of varying amounts of capacity. In the main triangle ABC , the sides have the same signification as in Fig. 51. Since the capacity E. M. F. is

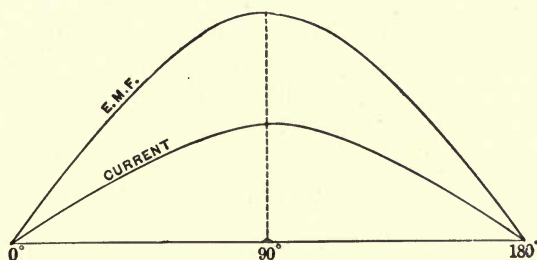

FIG. 61.

180° from, *i.e.*, directly opposite to, the inductive E. M. F., the effect of adding the capacity E. M. F. CD , is to reduce the effective inductance to BD and give as an impressed E. M. F. AD and an angle of lag ϕ_1 . Now increasing CD to equal CB , the inductance is annulled, ϕ becomes zero, and the impressed and effective E. M. F.'s are the same. Then increase CD still further so that it becomes CE . Now the inductance CB not only is neutralized but is replaced by a negative inductance BE . The angle of lag now becomes an angle of lead, ϕ_2 , the necessary impressed E. M. F. rises to AE , and the circuit behaves as regards the relations between current, E. M. F., and energy, just as it did when affected by inductance. There is the same discrepancy between real and apparent energy, the same necessity for more current to represent the same energy. But adding inductance now decreases the angle of lead. From a practical standpoint capacity by itself is objectionable, but capacity in a line containing inductance is sometimes a very material advantage.

The nature and reality of this curious phenomenon of "leading" current in an alternating circuit may be appreciated by an examination of Fig. 61. This shows the actual curves of current and E. M. F. taken from a dynamo working on a condenser in parallel with inductance. The maximum of the current wave is very obviously in advance of the maximum of the E. M. F. wave, though by a rather small amount (actually about 6°). The capacity in this case was between 2 and 3 microfarads.

Treating capacity as a negative inductance enables us to compute its effects quite easily. We have already seen how to reckon the impedance of a condenser; using the word impedance here in its proper sense of apparent resistance by whatever caused. This quantity we can add geometrically to the ohmic resistance of a circuit and obtain the net impedance just as in Fig. 54. We must bear in mind, however, that the capacity E. M. F. is 180° from the inductance E. M. F., though each is at right angles to the effective E. M. F. which is concerned with the ohmic resistance.

Instead, then, of computing the total impedance as $\sqrt{r^2 + I^2}$, it becomes $\sqrt{r^2 + \left(\frac{1}{2\pi n k}\right)^2}$, the second term under the radical being the square of the apparent resistance due to the capacity, just as I^2 expressed the square of the apparent resistance due to inductance.

Suppose, for example, we have a resistance of 100 ohms in series with a condenser of 4 microfarads capacity. The impressed E. M. F. is 2,000 volts at 130 cycles per second. What is the total impedance, the resulting current, and the angle ϕ , in this case an angle of lead? Here

$$2\pi n k = \frac{6.28 \times 130 \times 4}{1,000,000} = .003266$$

$$\frac{1}{2\pi n k} = 306.$$

Laying off the resistance AB in Fig. 62 as in Fig. 54, and drawing $\frac{1}{2\pi n k}$ to the same scale at right angles (downward to

emphasize its opposition to the inductance of Fig. 54), we have for the length of the diagonal AC , which represents the total impedance, $\sqrt{100^2 + 306^2} = 322$ ohms. The current flowing is then, 6.21 amperes. The angle ϕ is determined as before by $\tan \phi = \frac{306}{100} = 3.06$, whence $\phi = 72^\circ$, $\cos \phi = .309$, so that we are dealing with a "power factor" like that produced by a heavy inductance, although the current leads the E. M. F. instead of lagging behind it. If we consider an inductance in series with this circuit, we should have to reckon

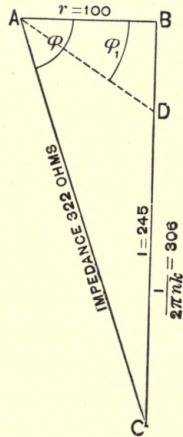

FIG. 62.

it upward in Fig. 62, thereby subtracting it from the former length BC .

Suppose for example for the given inductance $L = .3$ henry. Then $I = 2 \pi n L = 245$. If in Fig. 62 we draw 245 on the scale already taken, upward from C , we shall reach the point D . BD therefore is 61, and AD , the resulting impedance, is $\sqrt{100^2 + 61^2} = 117$ ohms. The new current is therefore $\frac{2,000}{117} = 17.09$, and as $\tan \phi_1 = .61$, $\phi_1 = 31^\circ.5$, being still an angle of lead.

It is easy to see that for a certain value of I , the capacity effect and inductance effect would exactly balance each other.

This value is obviously $2\pi nL = \frac{1}{2\pi nk}$, since then in Fig. 62, $BC - CD = 0$, and the impedance and resistance are the same thing, while ϕ becomes zero.

In actual circuits the capacity is seldom in series with the inductance. It is usually made up of the aggregated capacity of the line wires with air as the dielectric, the capacity of any underground cables that may be in circuit, and finally the capacity of the apparatus, transformers, motors, and the like, that may be in circuit. Generally the major part of the total inductance is in the apparatus rather than the line, and hence in parallel with the capacity. In many cases nearly all the inductance and capacity is due to the apparatus, and the two may be regarded as in parallel substantially at the

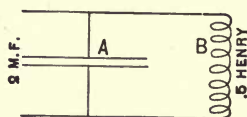

FIG. 63.

ends of the line. The inductance of generators and transformers may amount to several henrys, while their capacity is by no means small, though very variable, like the inductance. For example, the capacity of a large high-voltage generator or transformer may often amount to several tenths of a microfarad. Armored or sheathed cable has a capacity of from a quarter to a half or more, microfarad per mile. Altogether one may expect to find a capacity of several microfarads frequently, and large fractions of a microfarad very often.

Suppose now we have in parallel a capacity A , Fig. 63, of 2 microfarads, and an inductance of .5 henrys, the resistance connected with each being insignificant. Assuming as before 2,000 volts and 130 cycles, what is the total impedance of the combination, and the resulting current? We have already seen how impedances in parallel are to be treated. In the case in

hand the impedance of A is $\frac{1}{6.28 \times 130 \times .000,002} = 613$ ohms, and that of B is $6.28 \times 130 \times .5 = 408$ ohms. Now remem-

bering that in adding impedances their geometrical sum is to be taken, and that joint impedance is the reciprocal of the geometrical sum of the reciprocals of its components, we can proceed as follows: The reciprocal of 613 is .00163. This we will lay off to any convenient scale just as in Fig. 57. As it is capacity-impedance, we will draw it downward for the sake of uniformity, making $A B$, Fig. 64. Now take the inductance. The reciprocal of 408 is .00245. As the inductance and capacity E. M. F.'s are here as before at an angle of 180° , we must draw this upward from B , giving us the distance $B C$. The geometrical sum is then $A C = .00082$, of which the recip-

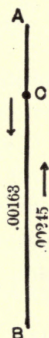

FIG. 64.

rocal gives the resultant impedance as 1,219 ohms. Hence the net current in the line under 2,000 volts is $\frac{2,000}{2,219} = 1.6$ ampere. But under the same pressure the current in A would obviously be 3.26 amperes and that in the inductance B would be 4.90 amperes. We have then the curious phenomenon of a total current in the line smaller than that through either of the two impedances in circuit. It is as if A and B formed a local circuit by themselves in which the condenser A served as a species of generator. It is quite evident that the total energy of the system, however, is that due to the current in the line, so that the phases in A and B are greatly displaced. If the resistances in the circuit were quite negligible, the net current in the line would be indefinitely small when $A = B$,

that is, when $L = \frac{1}{k}$. Of course, however, the true impedances of both A and B are modified by the resistances, however small, so that in Fig. 64 the impedances will always be at a small angle with the E. M. F.'s instead of being coincident. Hence the net current can never become zero, though when the impedances of A and B are large compared with the resistances, the line current will be very small when $L = \frac{1}{k}$.

This case is in sharp contrast to that in which condenser and inductance are in series with each other. For then the line current is increased as L approaches $\frac{1}{k}$ instead of becoming smaller relatively to the branch currents, although in each case the same relation between capacity and inductance gives the maximum "power factor" on the circuit, since whatever the current, under this condition it depends most nearly on the resistance alone. When the resistance is quite perceptible in comparison with the impedances of A and B , we should form a resultant impedance with each, and then combine the two somewhat as in Fig. 56.

If then we have an inductive load of any kind in circuit, a condenser in parallel therewith will reduce the current on the line and thereby increase the "power factor" of the system. It does this, too, without any material loss of energy and without necessarily increasing the amount of current flowing through the inductance under a given E. M. F. on the line. Were condenser and inductance in series, the power factor could likewise be improved up to a certain point, but trouble would be encountered in that the condenser would necessarily have to be large enough to let pass enough current to supply the energy required in the inductance at full load.

In all practical cases the relations between resistance, capacity, and inductance, which have just been set forth, are somewhat modified by the existence of losses of energy in the circuit quite apart from these due merely to overcoming of resistance. Energy is required to reverse the magnetization of the iron cores of inductance coils, and to reverse the electric

strains in the dielectric of condensers. It therefore happens that with a condenser in circuit its apparent current is not exactly 90° ahead of its impressed E. M. F., as shown in Fig. 59, but a trifle less, so that the current has a small component in phase with its E. M. F., thus supplying the energy in question. The deviation from 90° is generally but a small fraction of a degree. The same sort of thing happens when an inductance having an iron core is in circuit. However small the resistance, the lag still misses 90° by enough to take account of the energy required for magnetic losses. The variation from 90° in this case may amount to 30° or more. Hence

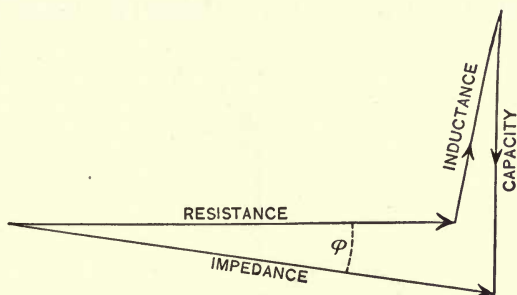

FIG. 65.

the failure to take account of these energy losses in the example given on page 141.

The result is that in adding inductance and capacity effects, one sometimes seems not to get so simple results as in Fig. 64, but something more like Fig. 65. Here it is clear that no combination of capacity and inductance can leave the circuit free from everything except resistance, for both the inductance and the capacity demand energy in the circuit beyond that expended in the resistance. Evidently, however, ϕ may be reduced to zero if the relation between capacity and inductance is just right. Thus while the lag may be reduced to zero, no combination can dodge the energy losses. Whenever all the energy losses are taken into account, the true inductance and capacity E. M. F.'s will be found 180° apart and 90° from the energy, exactly where they belong.

Closely connected with this subject is the matter of reso-

nance, which will be taken up in connection with the discussion of the line. Briefly the phenomenon is this: We have seen that the E. M. F. of a condenser is a maximum when the current is zero, so that as the current changes sign the thrust of the condenser E. M. F. is behind it. Now if the condenser E. M. F. synchronizes with this current, the impressed E. M. F. is added to it, imposes an added stress on the condenser during the next alternation, catches therefrom an additional kick as it passes through zero again, and so on. Thus the net effective E. M. F. is raised by the action of the condenser, and would increase enormously but for its being frittered away in overcoming resistance and supplying such energy

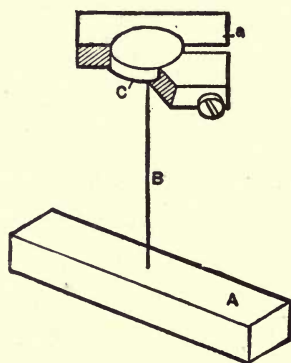

FIG. 66.

losses as we have just been considering. By avoiding these losses as far as possible, one can actually raise the voltage on an alternating circuit to twenty-five or thirty times its nominal amount by employing a condenser of the proper capacity. Even when the impressed E. M. F. and the current are not quite in phase, one has always a component of the condenser E. M. F. tending to act in a similar manner. Whether it actually produces a sensible rise of voltage depends on its relations to the frequency and resistance with which it has to deal. In fact, it is the addition of this same condenser E. M. F. to the circuit that enables one to neutralize inductive E. M. F. Whether or not the neutralization of inductance by capacity produces a real resonant rise of voltage depends on the fre-

quency and whether the energy losses are small or large. If they are small enough to let the sum of the impressed and the condenser E. M. F. accumulate during several alternations there will be a noticeable increase of voltage, otherwise not.

The dynamics of resonance may perhaps be best understood by a very pretty mechanical analogue due to Dr. Pupin. The apparatus on which it is based is shown in Fig. 66. It is a torsional pendulum composed of a heavy bar *A* suspended by a *stiff* elastic wire *B*, from a light circular bearing plate *C*. This plate rests in a recess *a*, with a frictional resistance which can be regulated by the screw shown in the cut. Such an apparatus acts much like an electric circuit, having inductance, capacity, and ohmic resistance. The moment of inertia of the bar *A* corresponds to self-induction, the elasticity of *B* to condenser capacity as we have just noted in connection with Fig. 58, and the friction of *C* to the resistance. Moreover, if *I* is the moment of inertia of the bar *A*, and *B* the reciprocal of the elastic capacity of the wire, then within certain values of the frictional resistance the oscillation period of the pendulum thus formed is, in seconds,

$$T = 2 \pi \sqrt{I B}.$$

This corresponds most beautifully to the time constant of an electric circuit, which is, if the energy losses are within certain limits,

$$T = \frac{2 \pi}{1,000} \sqrt{L C},$$

wherein *L* is in henrys, *C* the capacity in microfarads, and the denominator comes from the units being thus chosen.

Now, if this pendulum be given a twist it will oscillate at constant frequency until the friction gradually brings it to rest with oscillations of steadily decreasing amplitude. If, however, at the end of each complete swing it should receive a slight push, its oscillations would continue and would increase in amplitude up to a limit set by the frictional resistance. The condition for such permanent increase of amplitude is that the frequency of the pushes must coincide with the period of the pendulum. In the electrical case, resonance thus

occurs when the frequency and the time constant of the circuit are equal. Further, maintaining our auxiliary pushes at their original frequency, suppose I to be decreased by taking weight off A progressively. As the time constant of the pendulum thus diminished a point would be found, and that very soon, at which resonance would cease, and the same result would follow increase of I , so that when the circuit begins to get out of tune the resonance soon becomes rather trivial. If, however, the pushes were supplemented by others of 3, 5, 7, etc., times the frequency, corresponding to the harmonics found in an ordinary alternating circuit, new points of resonance would appear when the period of A assumed corresponding values.

As to the magnitude of the resonant effect, in the torsional pendulum case the amplitude evidently increases with the strength of the pushes, their absolute frequency, which measures the energy supplied, and the moment of inertia of A , which stores this energy. It decreases in virtue of the frictional resistance. Corresponding reasoning holds in the electrical case, and to a first approximation the E. M. F. in a completely resonant circuit is

$$E' = \frac{nL}{R} E,$$

in which E is the impressed E. M. F. concerned, L the inductance in henrys, R the resistance in ohms, and n the frequency. In case of resonance with harmonics, n and E refer to the frequency and magnitude of the harmonic implicated, and E' becomes a resonant component of the E. M. F. wave. This subject will be discussed more at length in Chapter XIII.

We have now glanced at the most striking characteristics of alternating currents — those concerned with the phenomena of inductance and capacity.

It remains to note very briefly some other physical properties that are of practical importance.

The most important single property of alternating current is the ease with which it can be changed inductively from one voltage to another. If a circuit carrying such a current is put in inductive relation with another circuit as in Fig. 4, Chapter

I, the electro-magnetic stresses set up by the first circuit can be utilized to produce alternating current of any desired voltage in the second circuit. The details of the operation will be taken up later; suffice it to say here that it is essentially the transformation of the electro-magnetic energy due to one circuit into electrical energy in another circuit.

Alternating currents can be regulated in amount by putting inductance in the circuit without losing more than a very trifling amount of energy. This very property, however, is troublesome when an alternating current is used for magnetizing purposes. It is very difficult to get a large current to flow around a magnet core because of the high inductance, and even then the magnetic and other losses in the core are serious unless great care is taken. These difficulties have stood in the way of getting a good alternating motor until within the past few years, and even now such motors have to be designed and constructed with the greatest care to avoid trouble from inductance and iron losses. For some classes of work, such as telegraphy and electrolytic operations, the alternating current is ill suited save under special conditions and with special apparatus. For the general purposes of electrical power transmission it is singularly well fitted, from the great ease with which transformations of voltage can be made, certain very valuable properties of the modern alternating motor, and the great simplicity and efficiency with which regulation can be effected. The only inconvenience attending transmission by alternating current is that incurred when direct current must for one reason, or another, be supplied. This is in a fair way to be greatly reduced by both increasing use of alternating current in distribution, and by improvement in apparatus for obtaining direct current from an alternating source.

CHAPTER V.

POWER TRANSMISSION BY ALTERNATING CURRENTS.

BROADLY considered, we may say that all systems of transmitting power by alternating currents are closely akin in principles and characteristics. The growth of the art, however, has proceeded along several lines, and certain conventional distinctions have come to be observed in considering the methods employed for rendering the alternating current applicable to the working conditions of power transmission.

Alternating systems are usually classified as either monophase or polyphase. By the former term is generally understood a system generating, transmitting, and utilizing a simple alternating current such as shown in diagram in Fig. 44. By the latter is meant a system generating, transmitting, and utilizing two or more such currents differing in phase and combined in various ways. As regards the systems, this distinction is sufficiently sharp, but as regards individual parts of such systems the line of demarcation is sometimes hazy, since a monophase current may be the source of derived polyphase currents, and on the other hand polyphase currents may be so combined as to give a monophase resultant. Mixed systems involving unsymmetrical phase relations may properly be called heterophase.

As regards apparatus, any device that performs all its functions in a normal manner when deriving all its energy from a simple alternating current should be classified as monophase. If its functions require the coöperation of energy received from two or more alternating currents differing in phase, the apparatus is essentially polyphase.

For certain purposes the one system is best adapted, for certain other purposes the other is most advantageous, but the underlying principles are the same, and the apparatus has much the same general properties.

The material of alternating transmission work may be classi-

fied as follows, the transmission line itself being reserved for discussion in a separate chapter in connection with other line work:

I. Generators.

III. Synchronous Motors.

II. Transformers.

IV. Induction Motors.

In addition to these, there have been recently introduced alternating series-wound motors with commutators which will be discussed in their proper place.

After a tolerably careful examination of the practical properties of this apparatus in its various forms, we shall be able to appreciate its application to the electrical transmission of power under various circumstances. Subsidiary apparatus of all kinds will be referred to elsewhere, and the divers systems that have been exploited can best be considered after we have looked into the characteristics of their component parts.

Alternating power transmission is now going through the stage of development that is inseparable from the rise of a comparatively new art — the planting time of “systems,” if one may be allowed the simile. It is sufficiently certain already that the same sort of plant will not do equally well under all circumstances.

The principles of the alternating current dynamo have already been explained, but the constructional features of such machines are sufficiently distinct from those of continuous current dynamos to warrant examination in considerable detail.

The modifications peculiar to alternators are in general due to two causes; first, the general use of a fairly high frequency, and, second, the necessities of rather high voltage.

We have already seen that, while an ordinary continuous current dynamo fitted with collecting rings will give alternating current, the frequency is rather low. To secure a higher frequency it becomes necessary to increase the number of poles, the speed, or both. Increasing the number of the poles is the usual method employed, since continuous current dynamos are generally for the sake of keeping up the output operated at speeds as high as the conditions of economical use render desirable. So we usually find that for equal outputs alternators

have many more poles. The general relation between poles, speed, and frequency is,

$$n = \frac{p}{2} \frac{N}{60}$$

where p is the number of poles, N the revolutions per minute, and n the complete cycles per second.

For example, belt-driven continuous current dynamos of 100 to 500 kilowatts usually run at speeds from 600 down to 300, and have four or six poles, thus giving 15 to 20 cycles per sec-

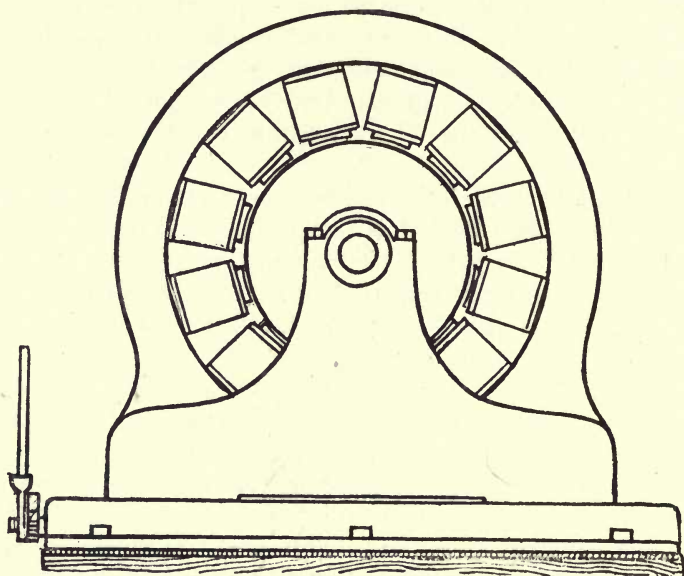

FIG. 67.

ond, while modern alternators of similar size and speed have from 12 to 24 poles, thus adapting them for a frequency of 30 ~ to 60 ~. Machines for the older frequencies of 120 ~ to 140 ~ were usually even more liberally provided with poles unless driven at speeds considerably above those mentioned. The general appearance and design of a typical belted alternator is shown in outline in Fig. 67. This is a 150 KW generator running at 600 revolutions per minute, and shows admirably the general characteristics of rather numerous poles, low

base, and massive bearings that nowadays belong in common to machines by nearly all makers. Such alternators usually have very powerful field magnets, and the projecting pole-pieces are usually built up of iron plates like the armature, for the same purpose of preventing eddy currents in the iron. The ring of field magnets is split on the level of the centre of the shaft, for convenience in removing the armature. The weight

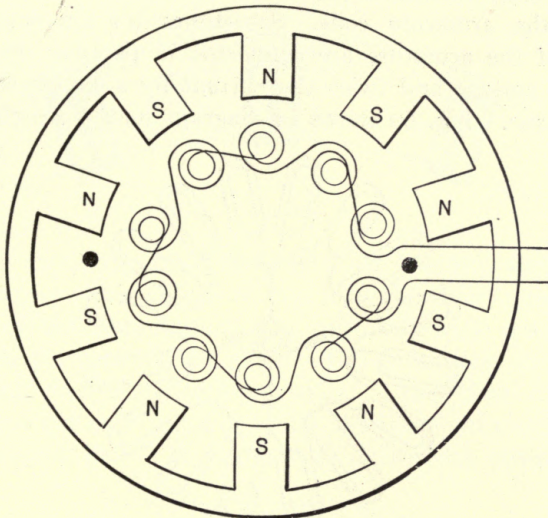

FIG. 68.

of belt-driven generators of the output named is usually six or seven tons.

This same general type is commonly adhered to whatever the nature or voltage of the armature winding, save in the case of special machines.

The winding of a modern alternator is nearly always widely different from continuous-current windings. In alternators the voltage is generally from 1,000 volts up, seldom below 500 volts, and to obtain this the windings corresponding to the numerous poles are almost universally connected in series instead of in parallel.

This necessitates connecting the numerous armature coils in a very characteristic way. For when a given armature

coil is approaching one of the north poles of the field magnet and is generating current in a given direction, the next armature coil is necessarily approaching the neighboring south pole, and if wound in the same direction as the first coil would generate a current flowing in the opposite direction. Hence if all the armature coils are to be in series, they must be wound alternately in opposite directions, as shown in Fig. 68. This arrangement throws in series the E. M. F.'s generated by all the armature coils. Sometimes for convenience the halves of the armature are connected in parallel, thus giving half the voltage and twice the current by a simple change in connections. Fig. 69 shows in diagram such a winding for a

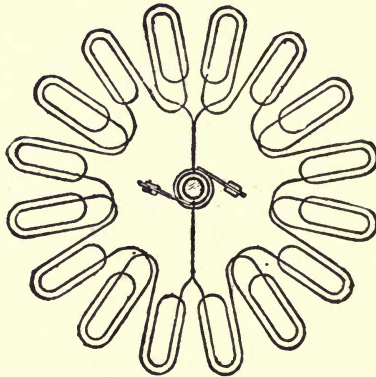

FIG. 69.

16-pole field, and its relation to the collecting rings. Note that each half of the winding preserves the characteristics shown in Fig. 68.

In practical machines as built to-day, the armature coils are nearly always bedded in slots in the armature core. The early American machines were generally built with smooth armature cores, and upon these flat coils were laid and held in place by an elaborate system of binding wires. This construction has been virtually abandoned by all the principal manufacturers in favor of the so-called "iron-clad" armature, which has the double advantage of great mechanical solidity and of permitting the armature coils to be wound in forms thoroughly insulated, and then dropped into place in their slots and

firmly wedged in position. The winding is, therefore, very little liable to damage and easily replaced if necessary.

The slotted armature cores are variously arranged in different machines, but always with the same object in view.

Fig. 70 shows one widely used arrangement of slots. Here the coils are wound in forms and thoroughly insulated. They are then pushed into place in the previously insulated slot, each coil enclosing a single armature tooth. When firmly in

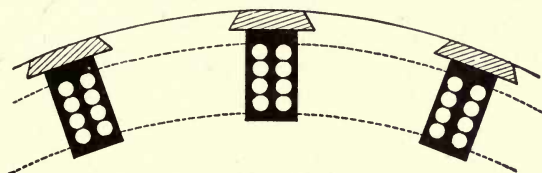

FIG. 70.

place the insulating material is put into position above them and a hard-wood wedge is driven into the dove-tailed upper portion of the slot, holding the coils and their surrounding insulation permanently in place. The coils here shown consist of only four turns of heavy wire. Often there are many more turns per coil, and frequently the round wire is replaced by rectangular bars. In generators for use with raising trans-

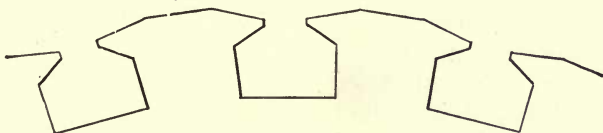

FIG. 71.

formers each coil sometimes consists of a single turn of bar copper, but whatever the nature of the coil the slots are arranged much as here shown.

Another familiar form of slotted armature is shown in Fig. 71. The coils are, as in the case just mentioned, wound in forms and solidly insulated. They are then sprung over the armature teeth into place and tightly wedged. The slots are carefully insulated also, and by the time the winding is completely assembled it is so thoroughly insulated that repairs are few and far between. The special peculiarity of

this form of core is that the outer corners of the teeth are cut away, so that the coils come more gradually into the field of the pole-pieces than if the edges were sharp. The object of this device is to obtain a curve of E. M. F. more nearly according with the sine wave form, and experience shows that the plan works successfully. Without such precautions the E. M. F. curve is very likely to be quite irregular, and even with them it is generally none too smooth. The pole-pieces of alternators are very often similarly rounded off or chamfered away for the same purpose.

Nearly all modern alternating windings are like those just indicated, of the drum type. The Gramme winding is seldom or never employed, as it is hard to wind and repair and has, for alternators, no compensating advantages. Nor has the flat coil winding without iron core found a permanent place in American practice, although it is somewhat used abroad. There is considerable likelihood of eddy currents in the armature conductors of such machines unless they are individually very thin, and for this and obvious mechanical reasons American designers have adhered to the iron-clad armature, which is admirable mechanically and magnetically, and have taken other means to escape the difficulty of its high inductance.

As in other dynamos, the theoretical E. M. F. generated by an alternator depends on the strength of the magnetic field, the number of armature conductors under induction, and the speed at which they are driven through the field. As an alternator receives load the E. M. F. at its terminals is reduced by three several causes.

First, there is a loss of voltage due to energy lost in the armature conductors. This depends simply on the current and resistance and is numerically equal to CR .

Second, there is self-induction in the armature windings, which, as we have already seen, involves an inductive E. M. F., lagging 90° behind the impressed E. M. F. The effect of this is to partly neutralize the impressed E. M. F., as in all cases of inductance. The amount of this disturbance depends on the frequency and the magnetic relation of the armature coils to each other and to the field magnets. This relation of course varies according to the relative position of the arma-

ture teeth which carry the coils. In Fig. 72, purposely shown with somewhat exaggerated teeth, the armature is in the position of minimum inductance, for the magnetic field set up by the armature coils is not here much strengthened by the presence of the pole-pieces. If, however, the armature were shifted forward or backward so that each tooth would be just opposite a pole-piece, the field from the armature coils would traverse an almost complete loop of iron and the inductance of the armature would be a maximum. In this position the armature teeth might be almost as good magnet poles as the field poles themselves; at all events, consecutive

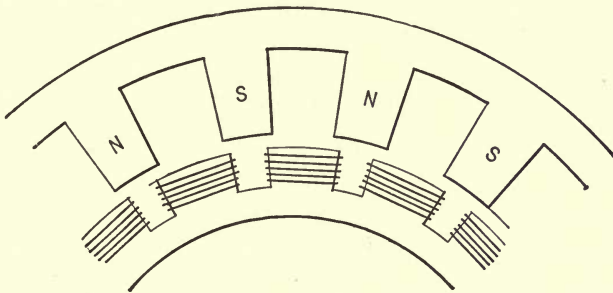

FIG. 72.

teeth would be united by an almost continuous iron core, and the armature inductance would be very high.

One of the best ways of reducing this inductance and its train of troubles is to make the magnetization due to the field magnets as strong as is practicable. This not only utilizes the iron of the field magnets and armature to the best advantage, but, so to speak, preëmpts its power of receiving magnetization so that the current about the armature teeth finds a poor field for its inductive operations. In addition, this strengthening of the field enables the required E. M. F. to be obtained with fewer turns per tooth. This of itself is a great advantage, since increasing the number of turns in an iron-cored coil runs up the inductance with appalling rapidity. A glance at Fig. 73 will show the reason why. Suppose we have a looped iron core wound with four turns of wire, *a*, *b*, *c*, *d*. If we pass a certain alternating current around two turns, *a* and

b, we shall have a certain inductance due to the reaction of the change in magnetism on these two coils. Now, pass the same current around all four coils. The magnetization will be approximately doubled and the number of turns on which it acts will also be doubled. That is, each coil is acted upon by double the force and there are twice as many total coils. Hence, the total inductance will be about four times as great as at first, and in general it will increase with the square of the number of turns. If, however, as just suggested, the core is nearly saturated already, adding the two extra turns, *c* and *d*, will not anywhere nearly double the magnetization,

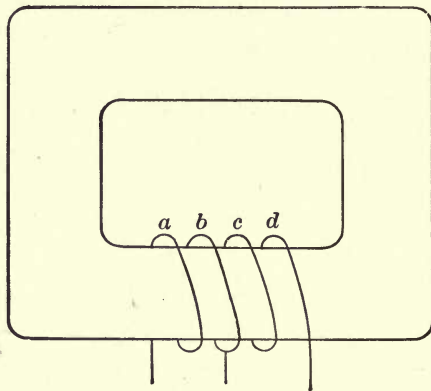

FIG. 73.

since iron already magnetized responds less and less to additional magnetizing force as this force increases.

Hence, diminishing the number of armature turns that can act conjointly in producing effective magnetization lowers the inductance very rapidly.

The third disturbing cause which tends to reduce the effective E. M. F. of an alternator is the reaction of the armature current, through the resulting magnetization, on the field magnets. We have already seen that when a closed coil is driven into and out of a magnetic field the induced current is always in such direction as to cause work to be done in driving the coil. But, since the current due to entering the field is equal and opposite to that produced in leaving

the field, the total magnetizations due to these currents are equal and opposite, and if one opposes the field due to a pole-piece the other will in an equal degree strengthen that field. Hence, provided these two actions are applied alike; *i.e.*, are symmetrical with respect to the field, the total effect of armature current will be neither to weaken nor strengthen the field.

In practice the effect of the armature reaction is two-fold. If the current be nearly in phase with the E. M. F. the main result of the magnetic field set up by the armature is to

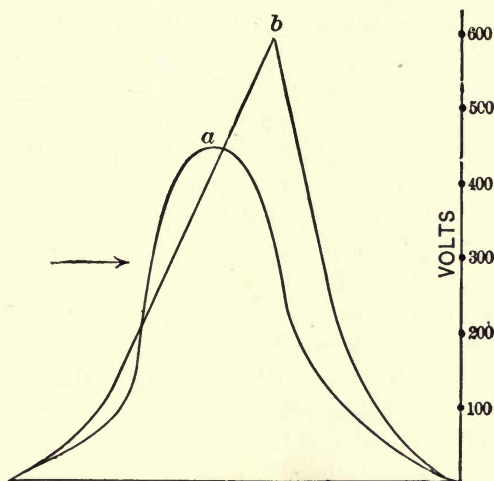

FIG. 74.

distort that due to the field without greatly weakening it as a whole. The result of this distortion is that the E. M. F. does not increase and decrease steadily following a sine wave, but becomes irregular. The working E. M. F., as measured on a voltmeter, changes but a trifle, but the maximum E. M. F. becomes subject to great variations. Fig. 74 shows in a very striking manner the result of field distortion from a purely non-inductive load. Here *a* is the E. M. F. curve on open circuit and *b* is the curve as modified by the armature reaction at nearly full load. The arrow shows the direction of rotation of the armature. In this case the maximum

voltage was increased about 30 per cent, while the measured voltage was nearly constant. Bearing in mind that the E. M. F. at any moment is due to the *rate of change* of the magnetic induction through the armature, and not to the absolute amount of that induction, it is tolerably obvious that the effect of field distortion due to armature reaction may vary widely according to the shape and position of both the pole-pieces and the armature teeth. It may increase the maximum voltage as above, or decrease it fully as much, but if it is of any considerable magnitude it always deforms the E. M. F. wave very materially.

If, however, through armature inductance or inductive load the current lags behind the E. M. F., we have a very different state of affairs. The current reaches its maximum after the armature coil has passed beyond the position of maximum E. M. F., and the net magnetization produced by it chokes back the field, at the same time greatly distorting it.

If the only effect of armature reaction and inductance were to cause a loss of voltage there would be little cause for alarm. But as shown in Fig. 74, the E. M. F. wave-shape often undergoes profound changes, which may greatly increase the chance for serious resonance. As already noted, alternating generators, monophasic and polyphasic alike, give in practice an E. M. F. wave which is not sinusoidal, but contains the odd harmonics of the fundamental frequency. These are a necessary result of the variations in magnetic reluctance and armature reactance when the armature is in various angular positions, as well as of subsidiary reactions in transformers and other apparatus. The harmonics of even order do not appear, since, unless a machine is deliberately made unsymmetrical, all the variations in E. M. F. are complete within each half period, the second half of the cycle merely showing a reversal of sign. Hence, only those harmonics appear which are themselves symmetrical with respect to a half period of the fundamental, *i.e.*, by construction all the harmonics are of odd order. These harmonics have a very real existence, and can readily be identified by testing electrically for resonance, or even by hunting for them with a telephone in some cases. By taking the wave form of the machine by the con-

tact method or photographically, the nature and magnitude of the harmonics are at once made evident.

Fig. 75 shows the wave form of a machine that was carefully studied by Steinmetz. It is from a three-phase generator having but one armature tooth per phase per pole, and giving 150 KW at 2,000 volts and 60 \sim . Curve *A* is the E. M. F. wave of one coil to the common connection, at no load, *B* is the wave as calculated from a summation of the harmonics up to the fifteenth, and *C* shows the residual traces of still higher harmonics. To reduce the vertical scale to primary volts, mul-

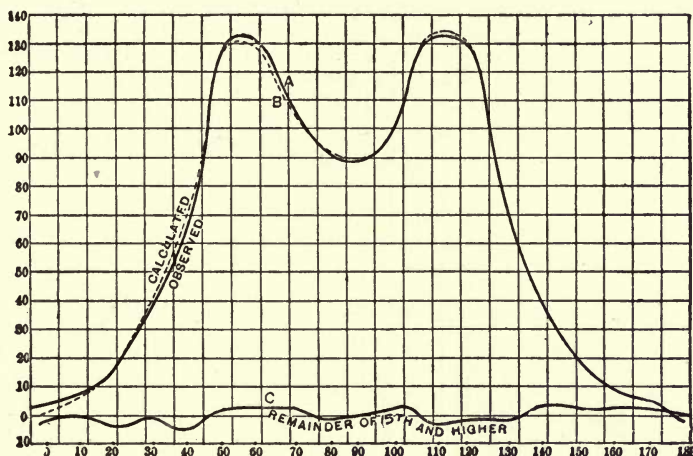

FIG. 75.

tly by 10. Analysis of this wave showed that it corresponded approximately to the following equation:

$$\begin{aligned} \sin a - .12 \sin (3a - 2.3) - .23 \sin (5a - 1.5) \\ + .134 \sin (7a - 6.2). \end{aligned}$$

In other words the third harmonic has about 12 per cent, the fifth about 23 per cent, and the seventh about 13 per cent of the amplitude of the fundamental.

At full load the shape of this wave is changed in a most singular manner. The armature reaction shifts the magnitudes and positions of the variations in the magnetic field and of the harmonics due to them. Fig. 76 shows the wave form from

this machine under load. The central depression of Fig. 75 is replaced by a slight hollow between a high peak and a shoulder, and the wave is conspicuously unsymmetrical, as might readily be predicted from the general effect of the armature reaction. The approximate equation to the wave of Fig. 76 is

$$\begin{aligned} \sin a - .176 \sin (3a + 11.7) - .085 \sin (5a - 33.8) \\ + .01 \sin (7a + 26.6). \end{aligned}$$

The effect of the armature reaction due to load has been greatly to strengthen the third harmonic, greatly to weaken the fifth, and nearly to suppress the seventh.

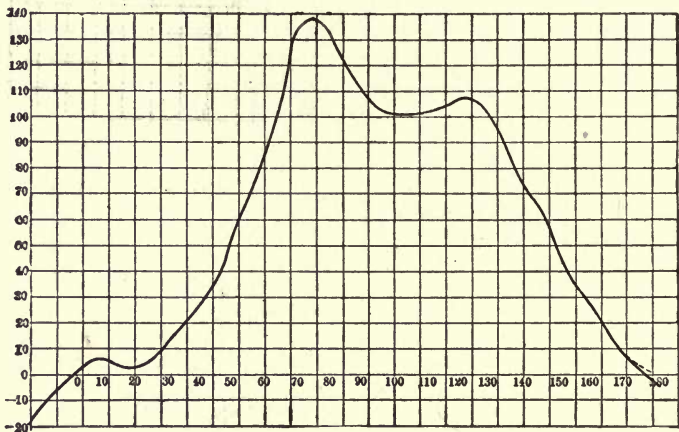

FIG. 76.

Obviously changes of this sort may have a very great effect in the matter of resonance. Suppose, for example, that the conditions on the line at light load were such as to give marked resonance with the seventh harmonic of the frequency. Now, under all ordinary working conditions this harmonic would be practically absent; but if a large part of the load were thrown off, resonance would suddenly appear, and with the lessened armature reaction the general voltage would rise sharply, so that serious results might follow. In case of a high voltage generator, say for 10,000 volts, having the curves just given, at load the seventh harmonic would only have an ampli-

tude of about 100 volts, while this amplitude would suddenly rise to 1,340 volts, increased perhaps four or five times by resonance, when the load was thrown off. Under other conditions throwing on load might produce an equally unpleasant effect.

Lest it should be supposed that these wave distortions with the presence of strong high harmonics are extraordinary and

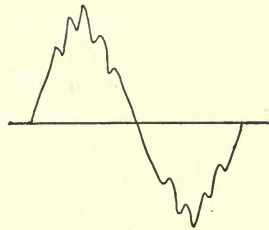

FIG. 77.

of merely theoretical importance, examples of such action from recent machines of first class make, obtained in commercial service, are here given. Fig. 77 shows the E. M. F. curve from a 750 KW, 5,500 volt engine-driven three-phaser, distorted by the presence of a strong thirteenth harmonic. The generator had a monodental winding which is prone to give lower harmonics, but these higher ones were mainly due to

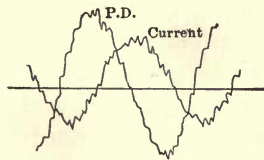

FIG. 78.

the disturbing effect of a synchronous motor load. Fig. 78 shows E. M. F. and current waves from a 1,500 KW three-phase turbo-generator, also on a synchronous motor load, and displaying conspicuous harmonics of the twenty-third order, in this case not traceable to the nature of the load, but structural and merely aggravated by the running conditions. The generator had four slots per phase per pole in this case, but the magnetic density in the teeth was rather low. Under ordinary

circumstances these harmonics are probably quite harmless, but their frequency is so great that they might easily cause serious results with but a very moderate amount of capacity in the system. The curves shown are from oscillograph curves, reported by Dr. W. M. Thornton to the British Institute Electrical Engineers, and are quite sufficient to prove the importance of the subject.

Such eccentricities can be avoided by scrupulous care in design, at least for the most part, and should be eliminated from every machine used upon circuits where by reason of unusual length, or the presence of cables, there is danger of resonant effects. At the voltages now generally used for power transmission, insulation is difficult enough without incurring the risks that come from preventable dangers of this sort.

The magnetizing and demagnetizing effects of the armature current in case of inductive load no longer can balance each other, for they are unsymmetrical with respect to the poles. If the angle of lag is large the result will be a very serious weakening of the field, and a correspondingly large drop in the effective voltage. For example, a certain alternator of 120 KW output has 40 turns of wire per armature tooth, carrying a normal full load current of 60 amperes. There is thus a possible demagnetizing force of 2,400 ampere-turns at full load. The ampere-turns per pole-piece in the same machine are 3,600, so that if the current should lag enough to give the armature reaction full play, as might happen from excessive armature inductance alone, the total net magnetizing force would be reduced to a third of its normal amount and the resulting voltage to a half or less. It is in fact common enough to find alternators that require from 50 to 100 per cent increase in the exciting ampere-turns to hold them at normal voltage under a full-load current lagging even 15° or 20° .

Between inductance and armature reaction the effective E. M. F. of alternators generally falls off rapidly under load unless special care be taken with the design. The loss from ohmic resistance is usually trivial compared with those just named. It is, in fact, perfectly practicable to build an alternator with inductance and armature reaction so exaggerated,

that a very slight increase in current will cut down the voltage so rapidly as to keep the current virtually constant. This plan was successfully carried out in the remarkable Stanley alternating arc machine of a few years ago.

In this case the current varied only about 10 per cent, while the voltage varied between a few volts and over 2,000. An automatic short-circuiting switch was provided to avert dangerous rise of voltage in case of an accidental open circuit.

In so-called constant potential alternators, as usually built, the inherent regulation is by no means good. Fig. 79 gives an excellent idea of the performance of some of the earlier machines in this respect, and it is about what one would find

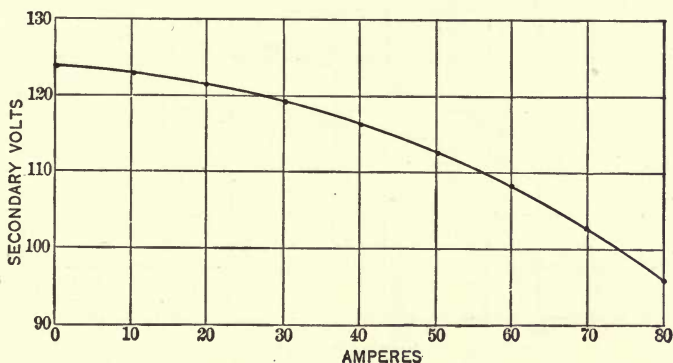

FIG. 79.

in many alternators now in service, except for their compound winding.

It has often been held that high inductance and large armature reaction are desirable in alternators in order to prevent burn-outs in case of accidental short circuits. While it is perfectly true that sufficiently crude armature design does produce this effect, by limiting the possible current, it is equally true that a machine with sufficient inductance and reaction to serve as a practical safeguard will regulate so atrociously as to be under many circumstances incapable of decent commercial service under present conditions. When it was sufficient for an alternator to give current that with sufficient hand regulation could supply house to house transformers most of the

time, high inductance machines, which are easy and cheap to build, answered the purpose.

At present, when the importance of good regulation is generally understood, and most large alternating plants must look forward to assuming a motor load, low inductance machines with small armature reaction are essential for first-class service. For power transmission plants with heavy mixed loads of lights and motors, no other class of machine should be tolerated, or can be used without incessant annoyance.

Most even of the older alternators are compound-wound to compensate for armature effects, and are thus enabled to work successfully up to outputs at which the voltage begins to

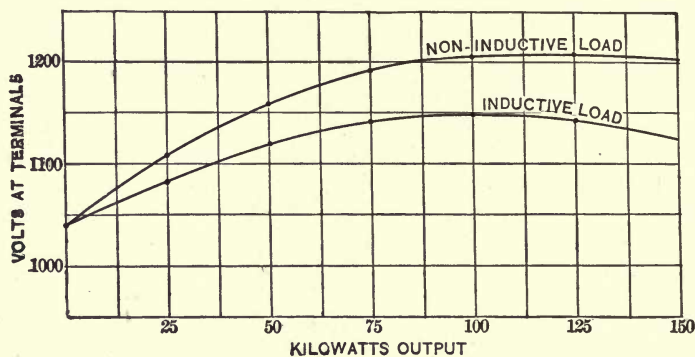

FIG. 80.

fall off too fast to be thus compensated. So long as the compounding process actually gives good regulation, it is useful and enables the generators to be worked at a high output. As a matter of fact when used with generators of the older type, even compounding left much to be desired. As alternating practice has gradually improved, compound-wound alternators have been more skillfully designed, and recent machines give on non-inductive load a very fair approximation to constant potential. Fig. 80 shows the E. M. F. of a modern over-compounded alternator at varying load. If, however, the current has even a moderate lag behind the E. M. F. owing to inductance in the machine or the load, the machine will no longer give constant potential, and the voltage may fall off rapidly as the

load comes on, as shown in the cut. The reason for this we have already found in the extra increase of field excitation necessary to compensate for the demagnetizing effect of armature reaction. Incidentally if the current commuted to supply the series field lags much, the process of commutation cannot

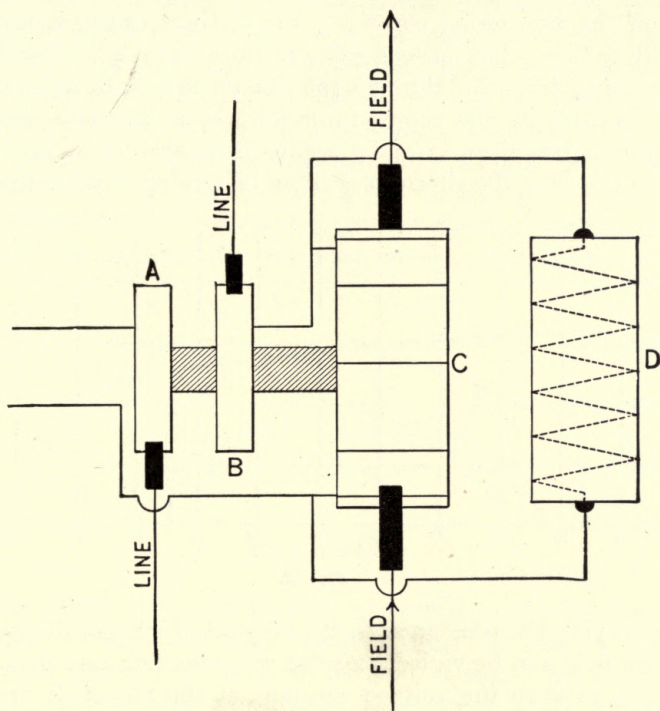

FIG. 81.

go on normally without adjusting the brushes to compensate for the lag.

Therefore, for inductive load the compounding has to be greatly increased, and even then is correct only for a particular inductance.

It must be understood that alternators are compounded on the same general principles as continuous current machines, except that instead of the current for the series winding being derived from the general commutator of the dynamo, it is

generally obtained from a simple special commutator. A shunt around this commutator diverts most of the main current, while a portion is rectified and passed around the fields. Fig. 81 shows in diagram a common compounding arrangement. The two collecting rings *A* and *B* with the commutator *C* are mounted on the armature shaft. Brushes on *A* and *B* take off the alternating current. One of these rings, *A*, leads directly to line. The current going to the other ring is divided, part passing around *C* through the resistance box *D*, and part being rectified by the commutator for use in the series field. This commutator has as many segments as there are pairs of poles in the field, the alternate sections being electrically united.

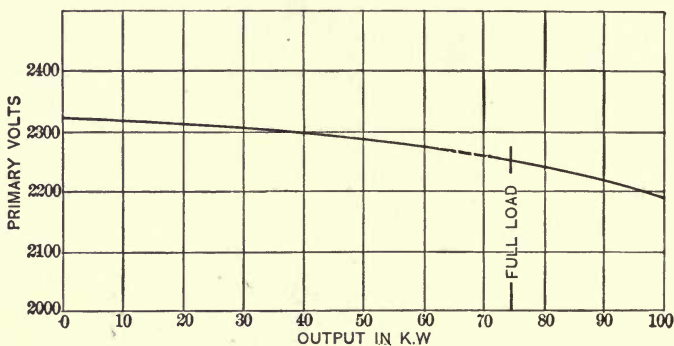

FIG. 82.

By varying the resistance *D*, the amount of current diverted into the field can be varied, and the compounding may thus be arranged to keep the voltage constant at the terminals or at any point on the line. A similar change in *D* may be made to adjust the compounding for inductive load of any given power factor.

For non-inductive loads, or for inductive loads of constant power factor, this compounding gives good results, but for a load of widely varying power factor it is nearly worthless unless supplemented by hand regulation.

If compounding is to be successfully used for keeping constant potential on a circuit of lights and motors subject to considerable variations in the power factor, it must be applied to a generator of very low inductance and armature reaction.

Otherwise no adjustment of the compounding for any particular power factor will give approximately constant potential when the power factor varies.

For example it would be hopeless to attempt to compound in the ordinary way an alternator having a characteristic like Fig. 79, so that it would be tolerable on a commercial circuit of lights and motors. On the other hand, a generator having a voltage characteristic like Fig. 82 could readily be so compounded. Here the fall in voltage at constant field excitation, from no load to full load (non-inductive), is about $3\frac{1}{2}$ per cent. Under inductive load this fall would be increased considerably, but from the usual ratio of inductive drop to armature reaction found in the best modern generators, the variation for the power factors likely to be encoun-

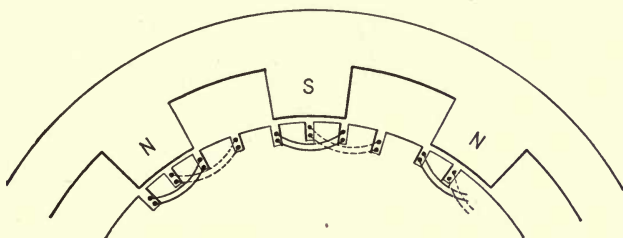

FIG. 83.

tered with a mixed load would be somewhat smaller than the original drop. The total variation from no load to full inductive load would then be between 6 and 7 per cent, and with compounding adroitly adjusted for average conditions the greatest variation from normal voltage could easily be brought within 2 per cent. A little intelligent hand regulation at certain times of the day would improve even this good result.

These considerations apply to polyphase as well as to monophas generators. The advent of polyphase work has done much to improve all alternators, and especially with respect to regulation.

The generation of polyphase alternating currents is a very simple matter. The object in view is the production of two or more similar currents differing in phase by some convenient

amount, usually 60° or 90° . To obtain two currents 90° apart in phase, it is only necessary to clamp together the shafts of two common alternators, so that, for a construction like Fig. 70, the slots of one armature would be opposite the teeth of the other armature. The armatures would then give currents 90° apart in phase. Such combination alternators were built for the Columbian Exposition by the Westinghouse Company, and were used for the principal lighting and power circuits. These structures are, however, expensive for the output obtained, and the two windings are nearly always put on a single armature core, and spaced as just described. Fig. 83 shows diagrammatically a winding of this nature. There are four times

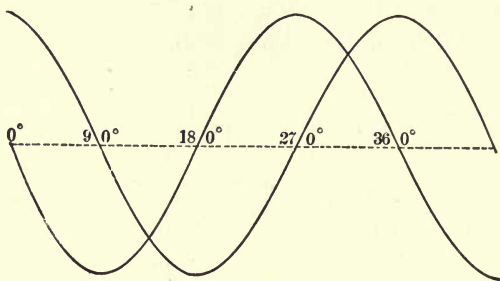

FIG. 84.

as many armature slots as there are field poles. Each coil spans two teeth. The coils shown by solid lines form one phase winding, the dotted coils the other phase winding. Each set of coils is connected as an ordinary monophasic winding, and the terminals are brought out to two pairs of collecting rings. Such a winding gives two simple alternating currents related in phase as shown in Fig. 84. The armature core is very fully occupied by the two windings, rather more advantageously than it could be by a single winding, so that the machine gives a somewhat better output as a two-phaser than would be possible with a simple alternator of the same dimensions. And, what is of more importance, the regulation of the machine as a two-phaser is much better than it would be as a single-phaser. In the first place the armature inductance is greatly reduced by the distribution of the windings and the reduction of the ampere-turns per armature tooth. Second, the same

causes act to cut down the armature reaction in case of a lagging current. Anything that improves the intrinsic regulation also means greater output for unimproved regulation. Moreover, the increased number of armature teeth gives a more uniform reluctance than in the case of fewer teeth, and hence tends to give a better approximation to a sinusoidal wave form.

So, aside from the value of polyphase currents for motor pur-

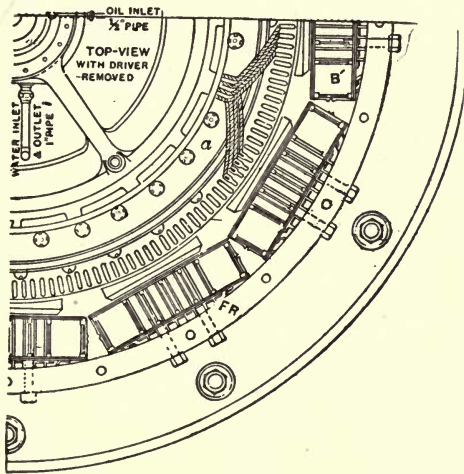

FIG. 85.

poses, which we shall presently examine, polyphase winding is valuable on its own account as increasing output and improving regulation. In fact, diphasé windings were devised for this purpose before their importance in the operation of motors became generally known.

The value of a subdivided winding in reducing inductance and armature reaction was greatly emphasized by the introduction of polyphase generators, and it was a short step from monodental windings having one coil and virtually one tooth per phase per pole, to windings in which each phase winding is split up into several sets of coils in adjacent slots, thereby still further decreasing the effective inductance and armature reaction. Such windings may be called *polydental*, from their several teeth per phase per pole, and are very generally used in

the best recent machines. A fine example of this class of winding is shown in Fig. 85. This is a quarter section of the armature of one of the original 5,000 HP Niagara generators, showing a portion of one coil belonging to a single phase. The full winding is composed of two conductors per slot, half the total slots, in alternate groups, belonging to each phase.

Such complete subdivision of the coils results in low inductance and a very low armature reaction. A similar winding could be used for a monophase generator, and will have to be employed if monophase machines come to be used extensively for power transmission purposes. The form of armature slot used for polyodontal windings is shown in Fig. 86, a single segment of one of the core plates of the armature of the Niagara two-phaser. The appearance of one of these great machines



FIG. 86.

complete is admirably shown in the frontispiece, showing the interior of the Niagara station. The field magnets are revolved instead of the armature, although they are exterior to it. A very powerful fly-wheel effect is gained by this arrangement, since the weight of the revolving structure, turning at 250 r. p. m., is about 75 tons, half of this being in the field itself. This is about 12 feet in diameter, a single forged steel ring with twelve massive pole-pieces secured to its inner face. The normal voltage of the machine is about 2,250, and the frequency is 25~. The stationary armature is provided with six ample ventilating ducts, through which air is forced by the revolving field. Fig. 87 shows a vertical section of the whole apparatus with its shaft and upper bearings. A hundred and forty feet below the generator is the turbine which supports by hydraulic pressure the weight of the revolving mass,

save a ton or two of residual weight, which may be either positive or negative, and which is taken care of by a thrust bearing.

The full load of this generator is 775 amperes on each of the two circuits, and at this load the commercial efficiency is nearly 97 per cent — a figure very close to the possible maximum. The exciting current for the fields is derived from a rotary transformer, and is led into the revolving magnets through a pair of collecting rings shown in Fig. 87 at the

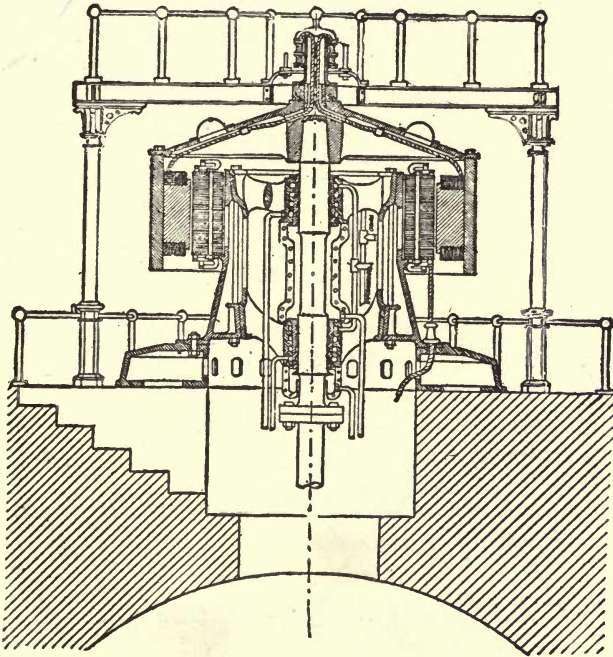

FIG. 87.

extreme top of the shaft. The armature current is of course taken from stationary binding posts. Altogether this Niagara machine was a fine specimen of polyphase construction.

When three-phase currents instead of two-phase are to be generated, separate armatures are out of the question, and a winding similar to that of Fig. 83 is frequently employed. To obtain the three currents, however, three separate windings are employed, arranged as in Fig. 88. The coils are connected

so that a, a, a , etc., form one phase winding, b, b , etc., a second, and c, c , etc., the third. The close similarity of this winding to the two-phase shown in Fig. 83 is at once apparent.

It is worth noting that these three windings are spaced 60° apart, instead of 90° , as in a winding for two phases. Naturally, therefore, the currents generated would be different in

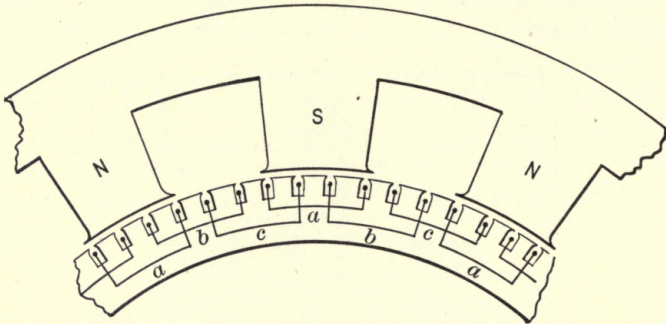

FIG. 88.

phase by only 60° , giving the arrangement of currents shown in Fig. 89. This is homologous with the two-phase current system of Fig. 84.

In practice it is necessary, however, to have the symmetrical arrangement of phases given by three similar cur-

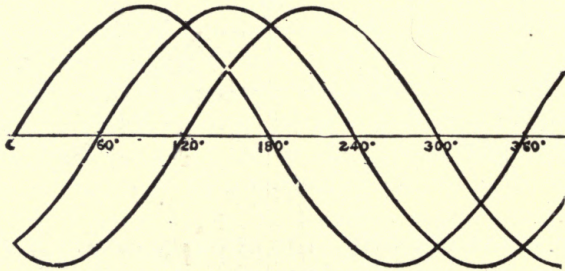

FIG. 89.

rents 120° apart. This is very easily obtained in the external circuit by winding one set of the armature coils in a direction reversed from the other two, or by merely reversing the terminals in making connections. The result of this is a true three-phase current, such as is shown in diagram in Fig. 90.

It has now the curious property that at all times the system is simultaneously carrying currents substantially equal in both directions, as will readily appear from inspection of the curves. With such a current it is usual to combine the circuits corresponding to the several armature windings. Otherwise we would be compelled to deal with circuits of six wires, and the generator would have six collecting rings.

Moreover, the distribution circuits formed by combining the circuits as just indicated have the advantage of economy in copper, as we shall presently see. Hence, the three-phase system has become the mainstay of electrical power transmission so far as the principal circuit is concerned. The genera-

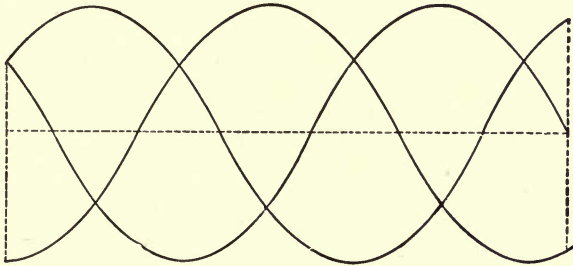

FIG. 90.

tors may be two-phase and the distributing circuits two-phase when convenience dictates, but the main line is, save in very rare instances, worked three-phase. The change from two-phase to three-phase, or the reverse, is accomplished in a beautifully simple and efficient manner, to be described later. Under certain circumstances the use of a two-phase generator has at least the theoretical advantage that the currents in the respective armature windings, being in quadrature, can have little or no mutual reaction, so that the two phases are more independent than the three phases of a three-phaser.

As might be expected, the subdivision of windings in a three-phase armature results in small inductance and armature reaction, smaller in fact than would be found in a similar two-phase winding. Nevertheless, experience shows that if the armature has only a single coil per phase per pole, the reaction is too great for first-class regulation, and the curve of E. M. F. is

rather too wide a departure from the sine wave. It is quite usual, therefore, to adopt the polyodontal construction with from two to four coils per phase per pole. A machine carefully designed on these lines can be made to give excellent regulation, with voltage not varying more than 3 or 4 per cent from no load to full non-inductive load, and is capable of giving a very close approximation to a true sinusoidal wave, a valuable characteristic for longdistance transmission. Fig. 91 shows the wave form given by one of these polyodontal three-phasers.

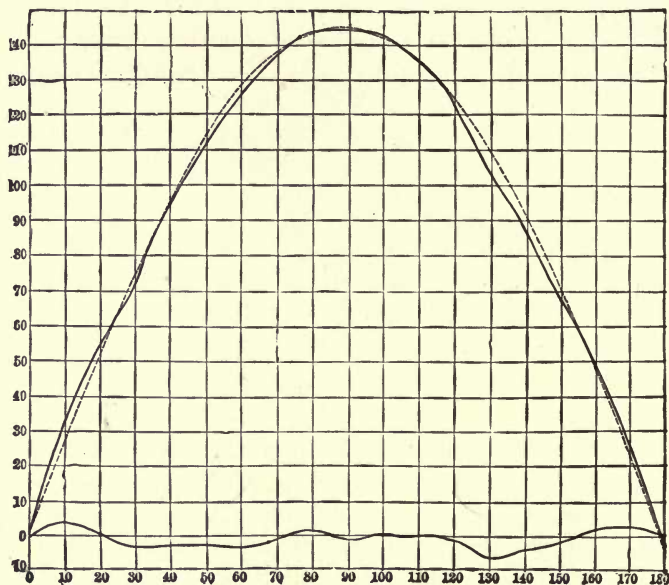

FIG. 91.

The full curve shows the actual E. M. F., the dotted line the corresponding sine curve, and the irregular line at the base of the figure the difference between the two.

There are several methods of connecting a three-phase winding to its external circuit. The two chiefly used are generally known as the "star" and "mesh" connections. In the former, one end of each of the three windings is brought to a common junction, and the three remaining ends are connected to three line wires. The three lines then serve in turn as outgoing and

return circuits, the maximum current shifting in regular rotation from one to the others in succession. The three E. M. F.'s in the three coils differ in phase by 120° , owing to the reversal of which we have spoken. We may draw the star connection diagrammatically in Fig. 92, drawing the three coils *a b c* 120° apart to show the relation of the E. M. F.'s and currents,

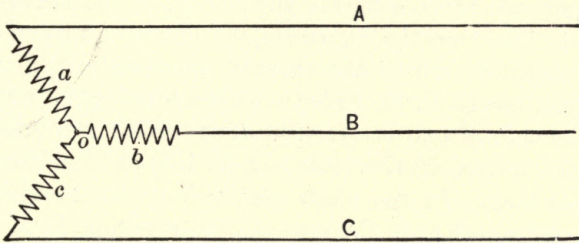

FIG. 92.

although they lie on the armature as shown in Fig. 88. Three of the terminals meet at the point *o*, the others are connected respectively to the lines *A, B, C*. As the three windings on the armature are alike, the E. M. F.'s generated by the three coils are equal. So if each winding *a, b, c*, is designed for 1,000 volts, that will be the voltage between the point *o* and each of the three lines *A, B, C*. Clearly, however, the voltage between

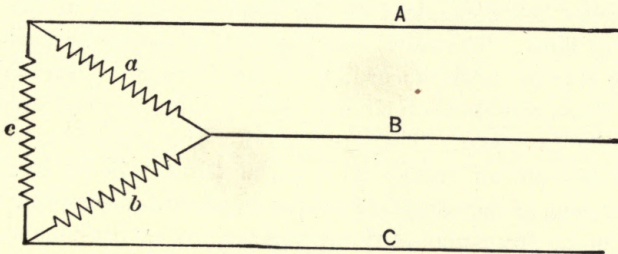

FIG. 93.

any two of these lines, as *A* and *B*, is a very different matter, since it results from the addition of the voltages of *a* and *b*, which are, however, 120° apart in phase. They must then be added geometrically. Now the chord of 120° is $\sqrt{3}$ times the radius, so that the geometrical sum of the voltages *a* and *b*, 120° apart, is 1.732 times either of them. The voltages then

between *A* and *B* in the case in hand aggregate 1,732. The same is evidently true of the other pairs of lines *B, C*, and *C, A*.

The other ordinary three-phase connection is the mesh, in which the six terminals of the three coils are united two and two, and the lines are connected to the three points of junction. This arrangement is shown diagrammatically in Fig. 93. Here each coil must generate the full E. M. F. between any two of the lines, but the current in any line, as *B*, is made up of the geometrical sum of the currents in *a* and *b*, differing in phase, just as the E. M. F. between lines in Fig. 92 was made up of the sum of two E. M. F.'s. The current in *B* being then so constituted, is $\sqrt{3}$ times the current in *a* or *b*, and so on for the other lines. In the mesh connection we deal with resultant currents just as in the star we find resultant E. M. F.'s.

An armature designed for a given working voltage, measured in the ordinary way between lines, would, if planned for star connection, have fewer turns of larger wire than if intended for mesh connection. This is sometimes convenient, and is useful in keeping the voltage between coils low. The mesh connection on the other hand has more turns of smaller wire, as the current is diminished while the E. M. F. in each coil is the full E. M. F. between lines. This property is useful under certain conditions, as it makes the E. M. F. between any two lines somewhat less dependent on the actions going on in the other pairs of lines. The same windings can of course be connected either star or mesh, according to the dictates of convenience. Both these combination circuits have in common one immensely valuable property. They require for the transmission of a given amount of energy at a given percentage of loss, only 75 per cent of the weight of copper required for the same transmission at the same working voltage, by continuous current or by any alternating system having two wires per phase. That is, if 100 tons of copper are required for a given transmission by continuous current, single-phase alternating, two-phase with two circuits, or three-phase with three circuits, 75 tons will suffice for the same transmission by the star or mesh three-phase circuit without any increased loss of energy. The proof of this saving is very simple. Assume a three-phase circuit carrying a non-inductive load at *V* volts between lines,

the current in each line being I and the resistance r . Then for a star connection, as we have already seen, the voltage in each branch to the neutral point o (Fig. 92) is $V \frac{1}{\sqrt{3}}$, the current in each branch is I , the power in each branch is $\frac{1}{\sqrt{3}} IV$, and the total power is $IV \sqrt{3}$.

The loss in each branch of the circuit is obviously I^2r , and the total loss for the above power $3I^2r$. Now let the same amount of power be transmitted by a single-phase circuit at the same voltage V . The current will evidently have to be $I\sqrt{3}$. Let r' be the resistance of one of the two monophase wires, such that the total loss shall be $3I^2r$ as before. The resistance of the complete circuit will be $2r'$, and the total loss $6I^2r'$. But since

$$6I^2r' = 3I^2r,$$

$$r' = \frac{r}{2}.$$

That is, the resistance of each of the monophase wires must be only one-half the resistance of a single three-phase wire. The cross section of each monophase wire must then be double the cross section of one three-phase wire. If the weight of the latter be w , the total weight of the three-phase copper will be $3w$, while the weight of the two monophase leads of double cross section will evidently be $4w$ for a circuit of the same length. A mesh connected three-phase system leads to exactly the same result, since the voltage in each branch is V (see Fig. 93), the current is $\frac{1}{\sqrt{3}}$, the power per branch $\frac{1}{\sqrt{3}} IV$,

the total power $IV \sqrt{3}$, and the loss $3I^2r$, as before.

The result seems so singular that in the early days of the three-phase system it was slow to be accepted by the public, until checked experimentally with the greatest precision, and by various experimenters. A similar saving can be effected by the use of some other polyphase combination circuits, but it happens that the three-phase combination is the one least open to practical objections.

In actual working the two-phase system is nearly always installed with a complete circuit per phase as regards the distribution circuits, unless for short connections to apparatus; the three-phase system is used with the star or mesh combination, except for occasional special work, and the more complicated polyphase systems are practically not used at all, save that in working rotary converters, the final connection is sometimes with four, six or even more phases to take better advantage of the armature winding.

In speaking of the voltage of an alternating circuit, it must be borne in mind that we do not mean the voltage corresponding to the extreme crest of the E. M. F. wave, but that voltage which, multiplied by the current in a non-inductive circuit, equals the energy in that circuit. This effective working voltage bears no fixed relation to the real maximum voltage, since

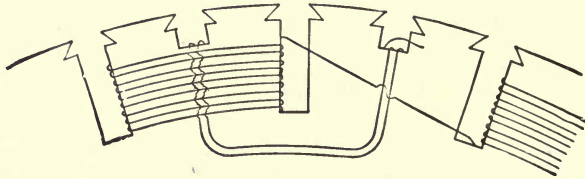

FIG. 94.

their ratio evidently varies with the shape of the E. M. F. wave. For a sine wave the ratio is 1.414, so that an alternating working pressure of 1,000 volts means a maximum voltage of 1,414. As may be judged from Fig. 91, this ratio is very nearly true for the best modern alternators.

Save in rare instances the work of power transmission is done by two-phase or three-phase currents. Abroad some pure single-phase plants are in operation with fairly good results, but the difficulty of getting good single-phase motors has so far rather checked development along this line.

In this country, a decade since, the so called "monocyclic" system, now obsolete, was introduced in a few plants where the motor load was merely incidental to lighting.

In this system there was a main armature winding to which the lighting circuit was connected as in ordinary single-phase working, while a subsidiary armature winding furnished mag-

netizing current for the motors. The general arrangement of the armature coils is shown in Fig. 94. The winding in the small intermediate slots was of the same size of wire as the main coil, but had only one-fourth as many turns, and consequently one-quarter the main E. M. F. This so-called "teaser" E. M. F. was obviously 90° in phase from the main E. M. F. The relation of the two E. M. F.'s is better shown in Fig. 95, where $A B C$ is the main E. M. F. and $B D$ the teaser E. M. F. The generator had three collecting rings, of which the middle one was connected to D . The outer rings had the full E. M. F. between them, while between D and C the E. M. F. was the geometrical sum of $B C$ and $B D$, approximately .56 of the main E. M. F. For motor service the resultant E. M. F.'s differing in phase were variously combined, usually into approximately three-phase relation, although in normal

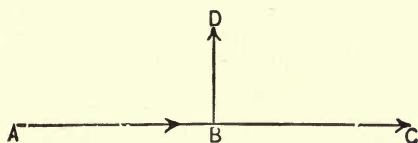

FIG. 95.

running all the *currents* in the motor remained in very nearly the same phase. The object of this system was to obtain for lighting purposes a perfectly simple circuit, the voltage of which should be quite undisturbed by actions going on in the subsidiary motor circuit, which object was attained if the generator was so arranged as to hold its voltage closely under inductive load.

A similar device for simplifying the operation of lighting circuits is a three-phase system arranged to supply the entire lighting service from two of its lines, as A and B , Fig. 92. The other two connections $B C$ and $A C$ would only be used for motor service, and if desirable the coils b and c could take up very little space on the armature. Still another of these heterophase schemes employs regular single-phase alternators for the lighting work, and a small adjunct machine in phase 90° from the others, and connected with them to form a two-phase

circuit with one common wire. This connection is used for starting ordinary two-phase motors.

In general, the heterophase systems have no substantial advantage over the ordinary polyphase systems, and are rarely employed. In the chapter on centres of distribution, the working properties of various alternating systems will be taken up in more detail.

In general construction and arrangement of parts all alternators are similar. Those specially intended for power trans-

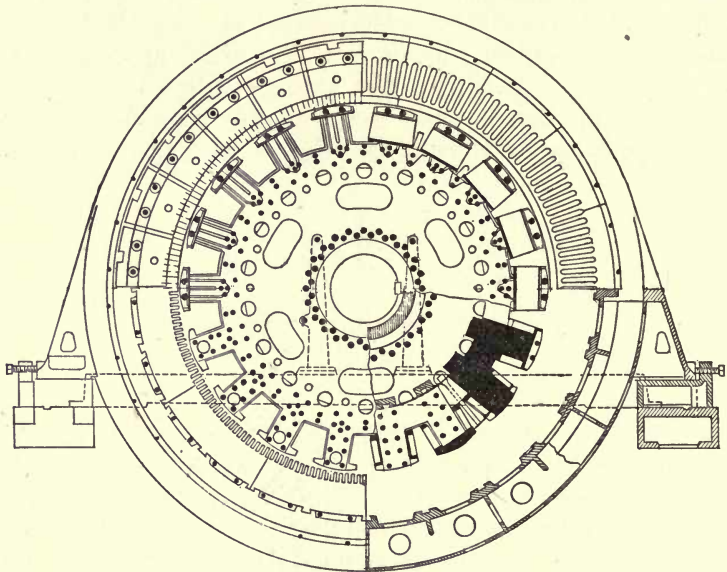

FIG. 96.

mission are sometimes, however, modified for convenience in obtaining high voltage or for direct coupling to water wheels. The vertical shaft arrangement as exemplified in the original Niagara machines is now and then used both in this country and abroad. Machines for 3,000 to 5,000 volts and upward are best constructed with stationary armatures, to avoid mechanical strains on the high voltage insulation. In following this design the armature is usually exterior to the field magnets as it is indeed in the later generators of the great Niagara plant.

It is very doubtful whether the fly-wheel effect gained by revolving an exterior magnet compensates for the great inaccessibility of the high voltage armature.

A characteristic example of the revolving field alternator is shown in section in Fig. 96.* It is a large polyphase generator for direct connection to a water-wheel, and the cut gives a good idea of its mechanical arrangement. The stationary armature is assembled on the interior of a supporting circular box girder cast in upper and lower halves. In the fourth quadrant of the cut this is seen in section, bearing dovetailed projections for supporting the laminæ of armature iron. These are curved segments as shown in the third quadrant, twelve segments to the entire circle. In assembling the armature each layer breaks joints with the next, and when the whole mass of laminæ is built up it is held firmly together by heavy end plates which are secured by bolts passing through the space left between the laminæ and the supporting girder. This stage of the construction is seen in the second quadrant. Finally after the armature coils are in place they are protected by a segmental ventilated shield as seen in the first quadrant. The revolving field magnet is likewise built up of segmental laminæ dovetailed to supporting castings, which are in turn carried by the two heavy steel plates which, bolted to the hub, form the driving spider. As in most such constructions the pole tips are of separate laminæ dovetailed or interlocked with the laminæ of the polar projections. The field coils are held in place by shoes and radial bolts to relieve the pole tips of the centrifugal stress. For lower speed machines the poles are often solid save for the dovetailed laminated tips, and are simply held to the rim of the field spider by radial bolts.

The construction of such machines is very various, but the main point is that the high voltage windings are stationary, kept well clear of each other, and singularly accessible so that damaged coils are very easily replaced. Current is led to the field by two small slip rings. Even for low voltage machines this construction is very generally preferred by reason of the greater security of the windings, and the absence of the large slip rings and their collecting devices.

* See Trans. A. I. E. E. Feb., 1904.

Still another form of alternator in which the armature, and field windings as well, are stationary, is found in the "inductor" dynamo. Of this the most familiar types are those introduced by Mr. Mordey in England and by Mr. Stanley in this country. In such machines the magnetic circuit through the armature coils established by fixed field coils is periodically closed and opened by revolving pole pieces which themselves carry no wire. The principle is illustrated in Fig. 97, a

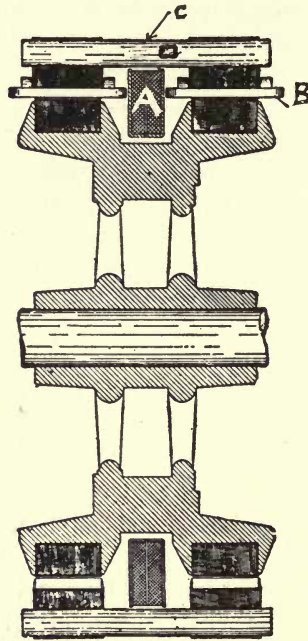

FIG. 97.

cross section of the Stanley inductor dynamo. Here the circular yoke *C* carries two rings of laminae each provided with windings, *B*, arranged much as in the alternator just described. Within these rings revolve two sets of laminated polar projections borne on a massive spider which completes the magnetic circuit. The stationary field winding *A* surrounds the spider as a whole without touching it. Evidently all the poles at one end of the spider are north poles and those at the other end south poles, and the armature coils are connected

THE
UNIVERSITY OF
CHICAGO

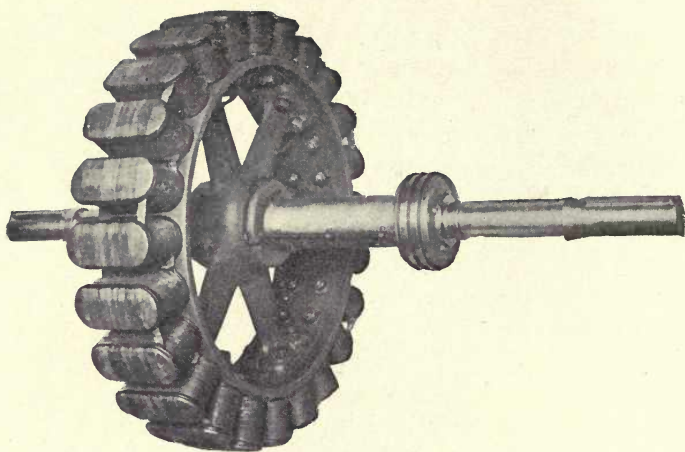

FIG. 1.

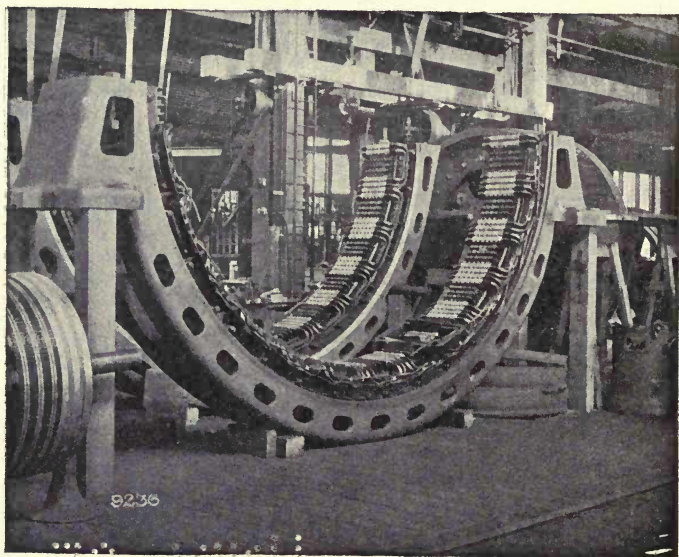

FIG. 2.

PLATE IV.

accordingly. As a rule inductor dynamos are not economical of material owing to the nature of the magnetic circuit, and their gain in security and simplicity over a revolving field alternator of the ordinary sort is hardly enough to balance the disadvantage, so that they are now less used than formerly, although in themselves excellent machines.

Plate IV shows the field and the two halves of the armature of a modern high voltage polyphase generator for direct connection to the prime mover. In this case the diameter of the armature frame is so great that it has been found desirable to design it as a hollow circular truss in order to give it the necessary rigidity against distortion by its own weight and by inequality of magnetic pull, if there were a trifling eccentricity due to wear of the bearings. In some of the early machines of large diameter, flexure from the weight alone was very troublesome. Half the armature coils are shown in place and wedged in, and a coil belonging in the second half is all ready to put in place. Four shapes of coils are necessary to complete this winding, but they can be kept well clear of each other at the ends and are easy to put in and take out, so that in case of damage a coil can be easily replaced, although it may sometimes be necessary to move several others to get at the damaged one. An injured coil, however, can readily be put out of circuit by cutting it loose at the ends, insulating them, and connecting the adjacent coils of the same phase across the dead one. A generator so temporarily repaired in a few minutes can be run until opportunity offers for permanent repairs, and can even be worked in parallel with others without material difficulty.

To facilitate repairs the armatures of large revolving pole machines are often carried on a sliding bed, so that they can be shifted by their own width along the shaft, exposing the windings of both armature and field.

The field is really a compact, massive fly-wheel with the poles bolted on its rim, the poles surfaces being shaped so as to give as nearly as may be a sinusoidal wave. The pole-pieces are generally laminated, at least near the tips, and are sometimes provided with ventilating spaces like those in the armature.

The advantage of revolving field generators is so great in point of easy insulation and ready collection of even very great currents, that this type of machine has been rapidly displacing the older form for high voltage work, and indeed for large work of every kind. In such generators voltages of 10,000 and 12,000 are now quite common, and the limit has not been reached.

Fig. 98 shows the efficiency curve of one of the huge modern high voltage three-phasers. It is from a 5,000 KW, 11,000 volt directed connected generator for the Interborough Rapid Transit Co., of New York City, and while it does not show the

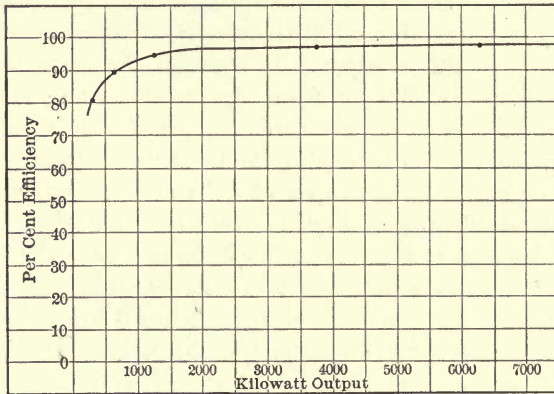

FIG. 98.

small frictional and air resistance losses, is very striking as illustrating first, the very high efficiency reached by such machines, and second, the remarkably uniform efficiency at varying loads. The curve passes 94 per cent at a little below quarter load, reaches a full load efficiency of 98 per cent, and rises even slightly higher on a 25 per cent over load. The regulation of this generator is also excellent, being upon non-inductive load in the vicinity of 5 per cent. It is built with a revolving 40 pole field 32 feet in diameter and the armature winding is distributed in four slots per phase per pole, each slot containing three bars.

In large polyphase generators the question of automatically regulating the voltage in response to changes of load is a seri-

ous one, and no final solution of it has as yet been reached. It is not economical to build generators with so small inherent variation of voltage as is in itself desirable. In small poly-phase machines compounding has been accomplished with an arrangement of parts similar to that shown in Fig. 81, the connections being so modified as not to take the commutated current from a single phase. This is troublesome in machines requiring considerable energy for the field excitation, and besides it only compounds correctly for a particular value of the power factor, which in many plants is constantly changing.

Several modern methods of compounding direct the com-

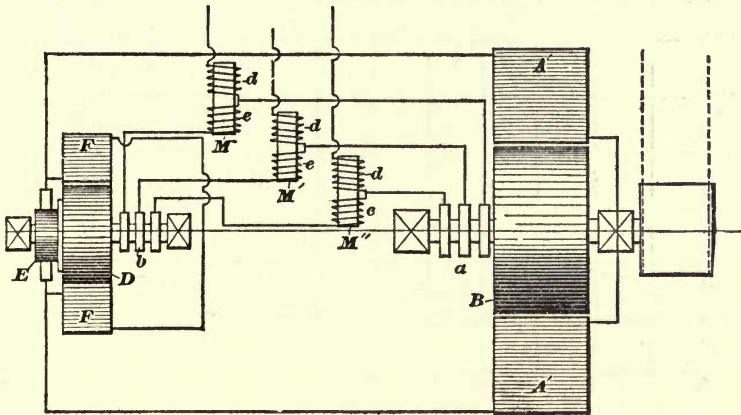

FIG. 99.

pounding at the exciter. A rotary converter is used as exciter, and the voltage at its commutator, which depends on the alternating voltage applied at the slip-rings, is modified in various ways in response to changes in the magnitude and phase of the working currents from the generator. A typical plan of this kind, successfully applied by the author some ten years ago, is shown diagrammatically in Fig. 99. Here the generator fields $A' A''$ are fed from the commutator end of a rotary converter $F F'$. Current from the main collecting rings a is led to the collecting rings b of the exciter through the reactive coils $c c c$ on the cores $M M M'$, which are also wound with series turns $d d d$ in the main leads of the generator. At

light loads the voltage at *b* is cut down by the reactance, while as the main current increases or lags the series turns *d d d* raise the voltage *a b*, and hence strengthen the generator field. By properly proportioning the coils *c c c*, *d d d*, and their cores *M M M*, the apparatus can be made to regulate the voltage very closely for all loads of the generator, inductive or non-inductive, or even may over-compound on inductive load so as to compensate for the change in the inductance of the system.

Fig. 100 shows the working of this device when arranged to show extreme over-compounding on inductive load. The generator chosen was one which uncompounded would drop its voltage about 40 per cent on a heavy inductive load. Curve

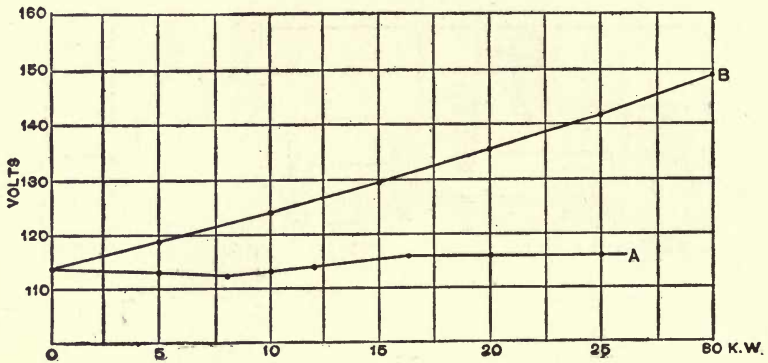

FIG. 100.

A shows the regulation of the secondary voltage on non-inductive load, curve *B* the over-compounding produced by a load of induction motors running light, having a power factor of not over 0.25.

The same general principle has been lately applied in several forms with very promising results. An interesting modification is the compensated field alternator recently brought out by the General Electric Company, and shown in Plate V. Here the exciter armature is on the shaft of the main machine, and is in a field having the same number of poles, so that it revolves synchronously pole for pole with its generator. Exciter and main fields are fed in shunt from the exciter commutator, but the exciter armature also receives through its col-

CIVIL ENGINEERING
U. of C.
ASSOCIATION LIBRARY

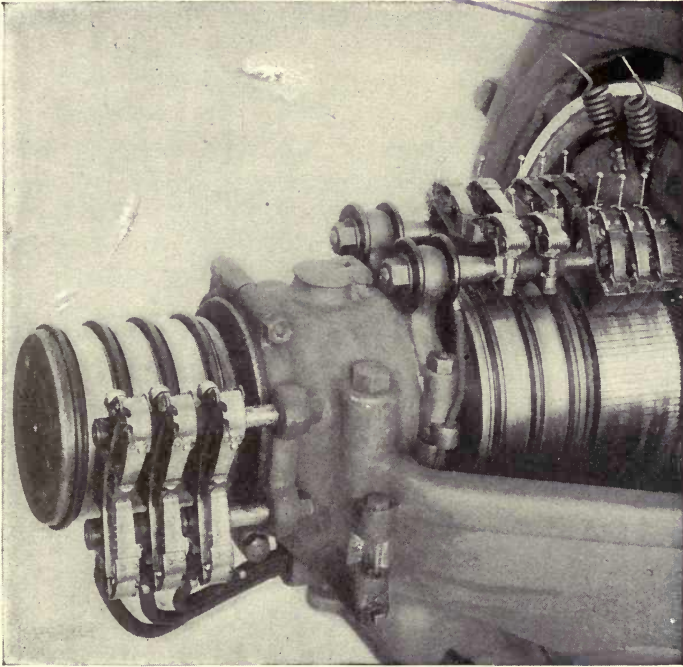

FIG. 1.

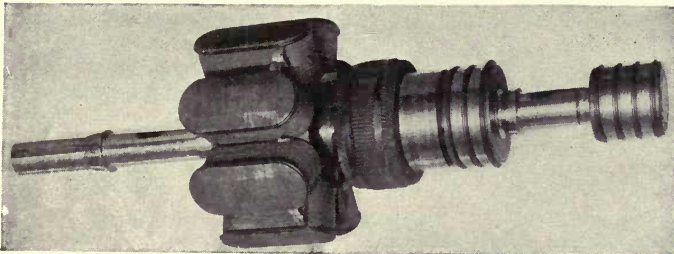

FIG. 2.

PLATE V.

lector rings an auxiliary current derived from series transformers in the main leads of the generator. This device holds the voltage with beautiful precision under ordinary changes of load and lag, but the necessity of being in mechanical synchronism is somewhat embarrassing, save in high speed machines.

Another very pretty method of regulation by compounding the exciter, is that due to Prof. F. G. Baum* and shown diagrammatically in Fig. 101. In this device a little generator of a few hundred watts capacity is mechanically driven in synchronism with the main generator *G*. Its fields *A A'* are excited by a few turns of the main generator current. The

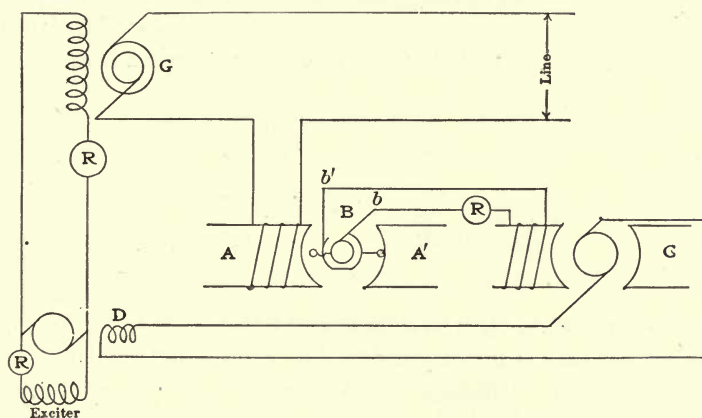

FIG. 101.

armature *B* has a very simple winding, one terminal of which goes to a solid ring connected by a brush with the lead *b*, the other goes to a pair of opposite segments about 90° wide and thence to the lead *b'*. When the fields are excited from the main current and the armature is turning in synchronism, the machine evidently gives a partially rectified current, more or less of the waves of one polarity being bitten off short, according to the position of the segments of the divided ring. The oscillograph record of the resulting pulsatory current is shown in Fig. 102. Now if the current in the main line lags the effect is precisely the same as if the segmental ring had been turned forward a little, thus increasing the amplitudes of the

* Trans. A. I. E. E. May, 1902.

peaks, and hence the effective E. M. F. of the pulsatory current. A leading current produces precisely the opposite effect. This automatically varied current excites the field of a second little machine *C* which compounds the exciter through the series coil *D*. The rheostats *R R* enable the compounding to be accurately adjusted. The effect of this apparatus is to regulate not only for varying current but for variations of power factor, in a very satisfactory manner. It may also be applied to synchronous motors and rotary converters.

Along such lines as these, good results are certainly attainable, and in addition there are several automatic devices for working a rheostat in the generator field so as to hold the voltage constant, irrespective of load or lag. These with other regulating apparatus will be described in another chapter.

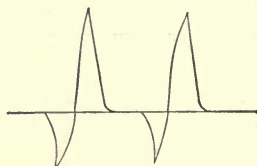

FIG. 102.

As a matter of fact, in much power transmission work compound winding is not necessary, since the machines hold their voltage closely without it if well designed, and in large plants the variations of load are usually so gradual that the voltage at the end of the transmission line can be easily kept constant by hand regulation. Again, in many transmission plants several lines are fed by one generator, so that no compounding would suit all the lines; and whenever a substation is installed, the secondary voltage has to be kept constant by special regulation in any event.

TRANSFORMERS.

The alternating current transformer is merely a glorification, as it were, of the fundamental idea shown in Fig. 4, page 12. The loops *A* and *B* are expanded into massive coils and are given a very perfect magnetic core of laminated iron, but the principle is unchanged.

In Fig. 103, *A* is a core composed of soft iron plates perhaps $\frac{1}{16}$ inch thick, stamped into the form shown, and then built up together like the leaves of a book, *B* is a coil of insulated wire wound in a spiral around one side of the core, and *C* is a single loop of heavy insulated copper bar around the other side. Now suppose an E. M. F. is suddenly applied to the terminals of the coil *B*, the loop *C* being left open. Current will flow through *B* in amount determined by its resistance and inductance, setting up a magnetic field throughout the mass of *A*. If the current is an alternating one an alternating magnetic field will be set up in *A*, and the current in *B* will settle down to that value which is determined by the resistance and inductance

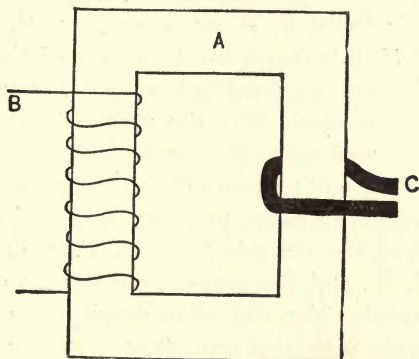

FIG. 103.

tance of the coil. The energy represented by this current is spent in heating the coil and in doing work by the reversal of magnetism in the core *A*. The current thus engaged lags behind its E. M. F. as in other cases of inductive circuit, the power factor at no load being in ordinary cases from .6 to .7.

Now close the loop *C*. Current opposing the current in *B* will be at once set up. The magnetizing effect of this reverse current opposes the magnetization due to *B*, and hence tends to cut down the inductance imposed on *B*, which is, as we have already seen, determined by the magnetic induction through its core. To this action *B* simultaneously responds with an increased current, so that any increase of the current in *C* and its consequent demagnetizing action, is automatically compen-

sated by an increased current in *B*. The increase of energy represented by this compensates for the energy due to the current in *C*. Energy is thus virtually transferred from the primary circuit *B* to the secondary circuit *C*.

Now as to the voltage of these two circuits. The energy in the two circuits is evidently equal save for losses in the iron and copper, which amount ordinarily to only a few per cent.

For any given magnetization in *A* the inductive E. M. F. in *B* is proportional to the total number of turns in the coils; so also the induced E. M. F. in the secondary is proportional to the number of turns in it. That is for a certain rate of change of the magnetic induction in *A*, the induced E. M. F. is the same *per turn* throughout *A*, whether that E. M. F. appears as inductance in *B* or secondary E. M. F. in *C*. Hence, the E. M. F.'s across the terminals of the primary and secondary coils are proportional to the respective numbers of turns in those coils. But the energy in the two is substantially equal, and hence the currents in primary and secondary must be inversely proportional to the respective E. M. F.'s. In Fig. 103 are shown seven primary turns and one secondary turn. Therefore, the secondary E. M. F. is one-seventh the primary E. M. F., and the primary current is one-seventh the secondary current. For the same density of current in amperes per square inch the secondary turn must have seven times the cross-section of the primary conductor. By simply changing the relative number of primary and secondary turns — the *ratio of transformation* — electrical energy at any voltage can be transformed to any other voltage with trifling loss if the apparatus be properly designed.

The losses which exist are of three kinds. First is the loss due to the resistance of the copper. This at light loads is very trifling, but increases with the square of the load, being numerically equal in watts to $C^2 R$, as in all cases of loss through resistance.

Second comes the loss through *hysteresis* — virtually magnetic friction — produced by the alternate reversals of magnetization in the iron core. This is nearly constant at all loads and is kept as low as possible by securing the best possible iron, and working it at rather low magnetization, since

the hysteretic loss increases very rapidly as the iron is more and more strongly magnetized.

Finally comes the loss from eddy currents in the core. This is due to the fact that the core is a fairly good conductor, and currents are induced in it for precisely the same reason that they are induced in the secondary winding. These eddy currents are largely reduced by carefully laminating the core across the natural direction of flow of these currents, and insulating the laminæ with sheets of tissue paper or with varnish. The loss from eddy currents is, generally speaking, of about the same magnitude as the hysteretic loss, and in transformer practice the two are usually lumped together and denominated core loss.

By careful construction and design these losses can be kept very small compared with the total output. The following data from a test of a 7,500 watt transformer designed for a frequency of 15,000 to 16,000 alternations per minute, about 125 to 135 ~, will give a clear idea of the results that can be reached commercially even in small transformers.

Output	7.5 KW
Transformation ratio	20 : 1
Full load amperes (primary)	3.6
Full load amperes (secondary)	72.0
Resistance (primary) ohms	6.15
Resistance (secondary) ohms012
Total C ² R loss (watts)	143.
Total core loss (watts)	78.
Primary current (no load)063
Power factor (no load)595
Total C R drop (per cent)	1.9

The efficiency curve of this transformer at various loads is given in Fig. 104. The interesting feature of this curve is the very uniform efficiency from half load to full load, with a maximum of 97.4 per cent at three-quarters load. This is the result of a relatively very small core loss. Even at one-tenth the normal load the efficiency is still good, over 90 per cent, although the curve falls more rapidly below half load.

The larger transformers, such as are used for heavy power transmission work, are even more efficient than the small one

here described, although the room for increase is now very limited. Within the last few years the improvement in commercial transformers has been very great. In practice they are seldom so simple in form as in Fig. 103, the core plates

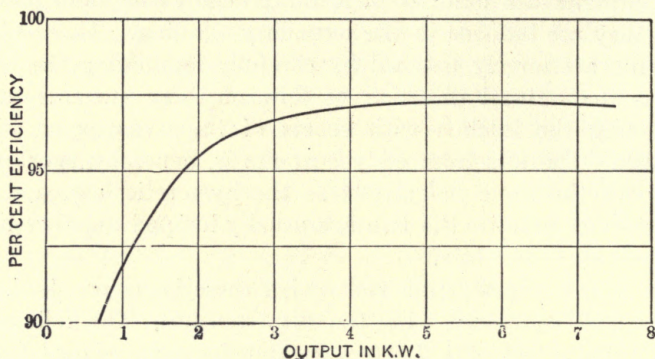

FIG. 104.

being universally built up of several pieces, so that the coils may be wound in forms and slipped into their respective places on the core. One of the forms which has been widely used is shown removed from its case in Fig. 105. The hollow rectangle *A* forms the main part of the core, while the bridge piece, *B*, is built up separately as the core of the coils, together

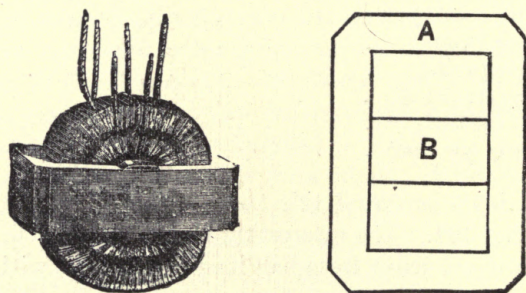

FIG. 105.

with which it is forced into the position shown. The secondary coil immediately surrounds the bridge, and outside of it is the primary coil. Both coils are of course elaborately insulated. Another familiar form of transformer is shown in

Figs. 106 and 107. Here the core is built up of straight rectangular slips of iron into a hollow rectangle upon the longer sides of which the coils are fitted, as in Fig. 106, separated by heavy sheet insulation in the manner shown. The whole assembled core and coils are shown in longitudinal section in Fig. 107. This form of construction gives the coils a large available cooling surface and simplifies their insulation some-



FIG. 106.

what, although magnetically the arrangement of Fig. 105 is to be preferred.

As transformers are usually inclosed in tight iron boxes to protect them from the weather, the heat generated in the coils and core has a rather poor chance to escape, and the temperature may therefore rise higher than is safe for the insulation. It is usual to take special precautions to prevent this overheating. One of the commonest and best devices for this

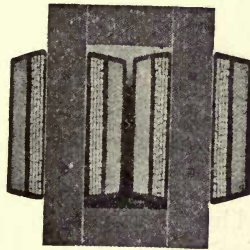

FIG. 107.

purpose is the subdivision of the core into bunches of laminae separated by air spaces.

This arrangement is well shown in Fig. 108, in which the core is provided with a dozen of these ventilating spaces. The arrangement of the coils is somewhat like that of Fig. 105. As an additional precaution against overheating, the trans-

former case is often filled with heavy mineral oil after the core is in place. This both provides additional insulation, and facilitates the transfer of heat from the core and coils to the iron case, whence it is radiated to the surrounding air. In very large transformers the primary and secondary windings are often built up of thin flat sections assembled with spaces between them.

For huge transformers such as are used for substation work, means are generally provided for artificial cooling. Two methods are at present in use for this purpose. One is the use of a blast of air from a small blower streaming through

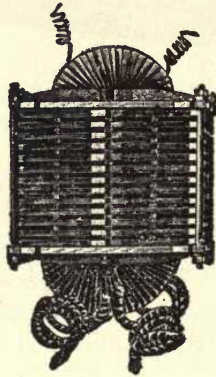

FIG. 108.

the interstices provided in core and coils, and rapidly carrying away the heat generated. The other is applied to oil-filled transformers, and consists in cooling the oil by a worm in the transformer case through which cold water is allowed to flow, or with a small pump circulating the oil itself slowly through a worm cooled by water. Either plan is very effective, and both are extensively used.

With properly designed transformers there is no difficulty in dealing with any voltage now in use, without the device of connecting transformers in series, which was formerly often employed for high voltage. Plate VI shows the latest transformer practice, the interior of a water-cooled 950 KW Westinghouse transformer. It is designed for use at 25 ~ to give 50,000 volts upon the transmission lines. Its splendid efficiency

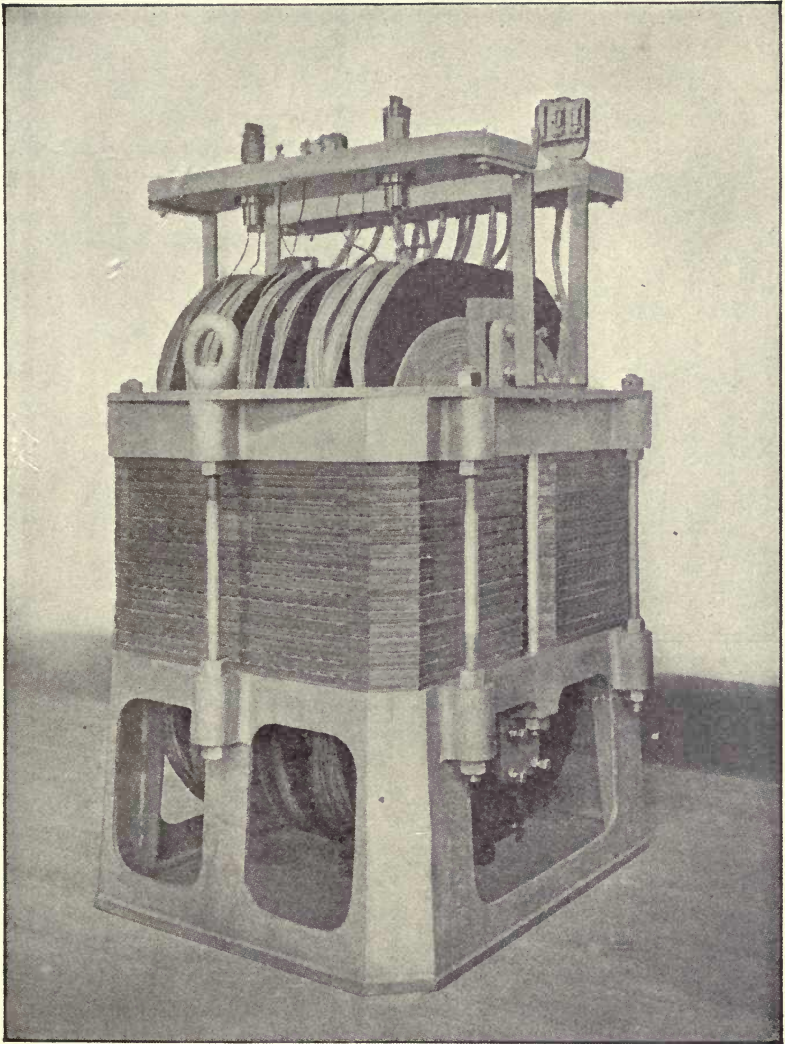
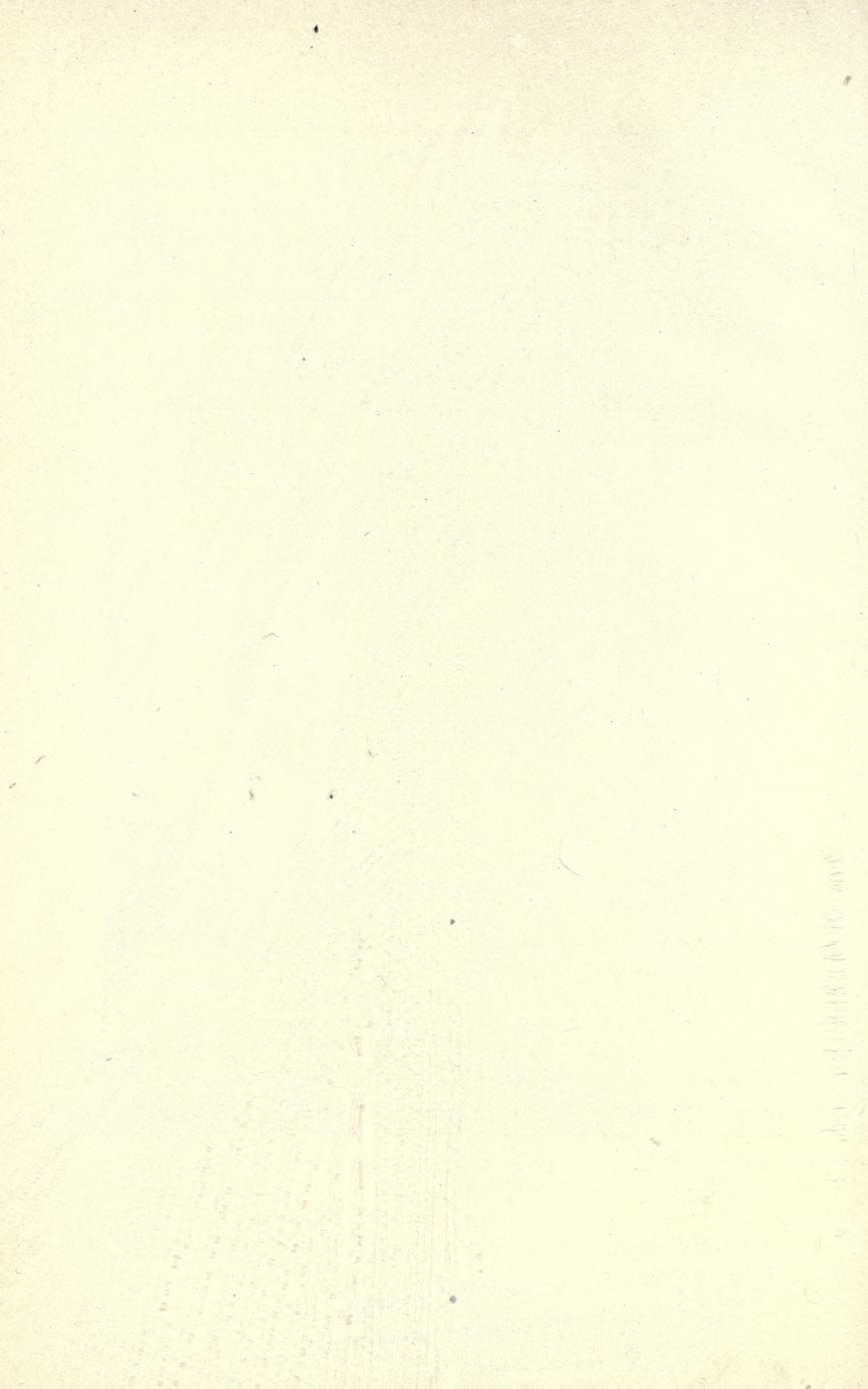

PLATE VI.

UNIVERSITY OF CALIFORNIA
DEPARTMENT OF CIVIL ENGINEERING
BERKELEY, CALIFORNIA



of a similar large transformer is shown in Fig. 109. If transformers are of similar size and design, they can be run in parallel with the utmost facility, and may very often be thus "banked" most advantageously, as with such connection it is easy to proportion the number of transformers in use to the load, so that they can be worked nearly at full load, and consequently at their best efficiency.

In general the larger the transformer the higher its efficiency, though the improvement is very slow after the output reaches 25 KW or thereabouts. The curve of Fig. 110

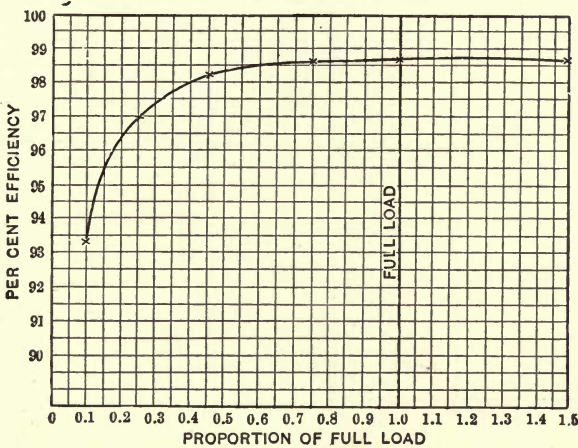

FIG. 109.

shows the change in half-load efficiency with the size of transformer as found in ordinary American practice.

The data here given relate to transformers of the kind employed for power transmission work, as now produced by the best makers. The sizes above 50 KW are frequently artificially cooled. The frequency is taken at 60 ~ to 70 ~, and the figures do not apply to transformers originally designed for higher frequencies. At lower frequencies the efficiencies are likely to be a fraction of a per cent lower, but at any frequency within the range of ordinary working a first-class transformer of 50 KW capacity or upward can be depended on for a full load efficiency of just about 98 per

cent, and a half load efficiency about one per cent lower. With care in planning a substation equipped with these large transformers, the loss under normal conditions of working should not exceed $2\frac{1}{2}$ per cent.

For polyphase work it is the almost universal custom in this country to employ simply groups of ordinary standard transformers. Abroad, composite transformers, transforming two or more phases in a single structure, are often used. The intent of this arrangement is to utilize more fully the iron core by making it common to the several phase windings. Three laminated cores, with the laminæ running vertically, are

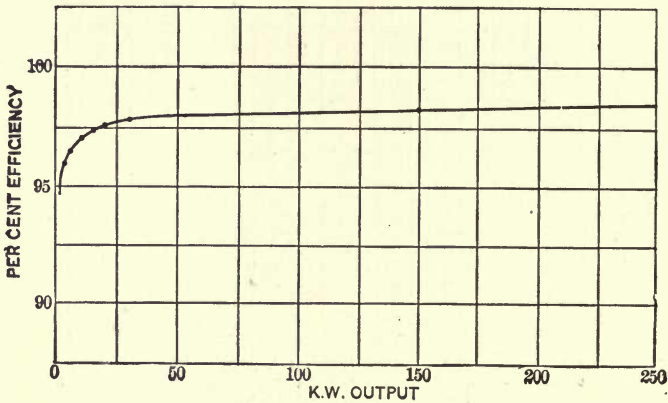

FIG. 110.

united at the ends by laminated yokes. Each core receives the primary and secondary windings belonging to a single phase, while the iron belongs to the three in common. The arrangement is akin to the mesh connection of three-phase circuits.

It is a question whether the common use of the core iron is a sufficient offset to the loss incurred in operative flexibility. Separate transformers for each phase can be readily shifted about or reconnected in case of accident, while if anything happens to a polyphase transformer it is likely to put out of action a considerably greater capacity than in the other case. Nevertheless, three-phase transformers are considerably used abroad and very recently they have come into current prac-

tice here. Fig. 111 shows, removed from its oil-filled case, a three-phase transformer of about 50 KW capacity. The arrangement of the cores is akin to that of Fig. 107, but with three wound cores instead of two. Similar transformers are now being made of several thousand kilowatts capacity, but whether they will have a permanent place in the art remains to be seen. They are at present emphatically special, and it is somewhat dubious whether they present sufficient advantages to compensate for the extra capacity jeopardized in case of trouble.



FIG. 11

Several arrangements of transformers are employed in polyphase working corresponding to the various arrangements of polyphase circuits. For example, in two-phase systems the transformers are generally connected as shown in Fig. 112. This is simply one transformer per phase connected in the ordinary manner. The two phases are kept distinct both as regards primary and secondary sides of the circuit. Fig. 113 shows the composite circuit method of connection. Both primary and secondary circuits have one wire common to both phases. In this case there is between the outside wires of the system a higher voltage than exists between either outside wire and the common wire. This voltage is of course the geometrical

sum of two separate phase-voltages. As these are 90° apart the resultant voltage is $\sqrt{2}$ times either component. Not infrequently the primary arrangement of Fig. 112 is combined with the secondary circuit of Fig. 113. This is the ordinary connection of two-phase motors, which are often built for this three-wire circuit. As a rule all lighting connections and all long circuits of any kind are made as shown in Fig. 112.

Transformers for three-phase circuits, are, like the circuits themselves, very seldom worked with the phases separated, but in nearly every case are combined in the star or mesh

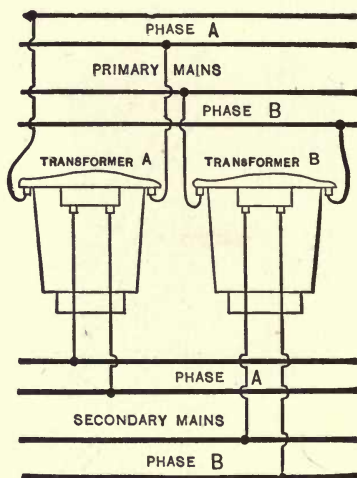

FIG. 112.

connection. The former is useful in dealing with very high voltages, since the individual transformers do not have to carry the full voltage between lines. Fig. 114 shows a diagram of the star connection and Fig. 115 the corresponding mesh. In each a, b, c , are the primary leads, and A, B, C the corresponding secondary leads. Of the two connections the mesh is rather the more in use except for high voltage work, and for secondary distribution with a connection to the common junction of the transformer system, which connection has for certain purposes very great advantages.

Whether the star or the mesh connection is employed, one

transformer per phase is required, and this condition is sometimes inconvenient as rendering necessary the use of three small transformers where a two-phase system would need but two. To obviate this difficulty, what may be called the

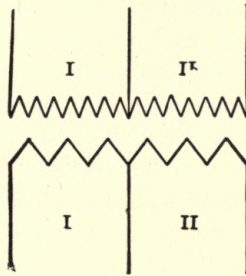

FIG. 113.

“resultant mesh” connection is extensively used, particularly for motors. The principles on which this is based have already been set forth.

Briefly, if one takes the geometrical sum of two E. M. F.'s

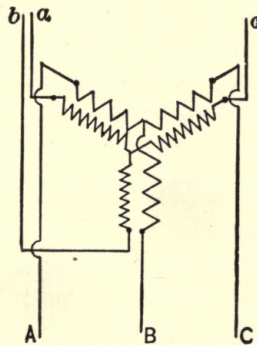

FIG. 114.

differing in phase, the resultant will be less than the arithmetical sum of the components, and not in phase with either. From the examples of geometrical summation already discussed, it is evident that by varying the magnitudes of the components and the angle between them, *i.e.*, their phase difference, the resultant may have any desired value and any direction with reference to either component.

The "resultant mesh" three-phase connection is shown in Fig. 116. It is composed of two transformers instead of three as in Fig. 115, the E. M. F. between the points *A* and *C* being the resultant derived from the two existing secondaries. Each of these secondaries contributes its part of the output in the resultant phase, and the secondary circuit behaves substantially as if it were derived from the ordinary mesh connection. This arrangement is very convenient in motor work, since it is very simple and allows the use of two transformers when desirable for the required output. Sometimes a motor is of a size that is fitted better by three standard transformers than by two, or the reverse, and with the choice

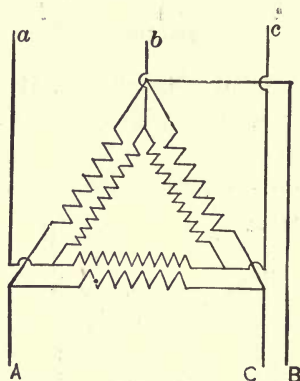

FIG. 115.

of the two mesh connections it is often possible to avoid some extra expense or to utilize transformers that are on hand.

A very beautiful application of this principle of resultant E. M. F. is the change of a two-phase system into a three-phase, or vice versa. The method of doing this is shown in Fig. 117. Suppose we have two equal E. M. F.'s 90° apart, as in the ordinary two-phase system, as the primary circuit. The secondary E. M. F.'s will still be 90° apart, but can be of any magnitude we please. Let one of these secondaries *A C* give say 100 volts, and tap it in the middle so that the halves, *A D* and *D C* will each be 50 volts; now wind the other secondary, *B D*, for $50\sqrt{3}$ volts, and connect one end of it to the middle point of the first secondary. Taking now the geometrical

sums of BD with the two halves of AC , the resultants are equal to each other and to AC , and leads connected to A , B , and C will give three equal E. M. F.'s 120° apart, forming a three-phase mesh with two resultant E. M. F.'s instead of one

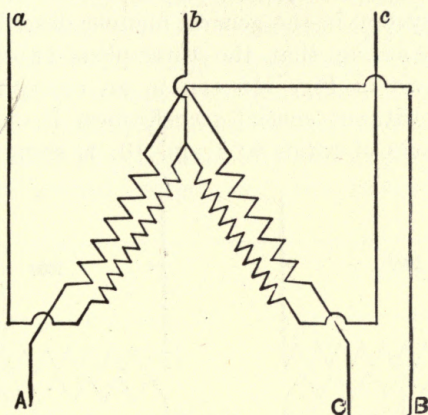

FIG. 116.

as in Fig. 116. The actual connection of a 1,000 volt two-phase system to form a 100 volt three-phase secondary system is shown in Fig. 118. Reversing the operation by supplying three-phase current to the three-phase side of the system gives a resultant two-phase circuit.

This change-over process is valuable in that it allows a

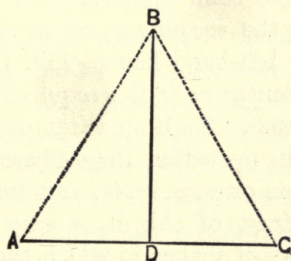

FIG. 117.

three-phase transmission circuit to be used for the saving in copper characteristic of it, in connection with two-phase generating and distributing plants, and permits two-phase and three-phase apparatus to be used interchangeably on the same

circuit, which is sometimes advantageous. A somewhat analogous arrangement permits the transformation of a monocyclic primary circuit into a three-phase or two-phase secondary form, as may be convenient, and in fact any system with two or more phases may be transformed into any other similar system in the general manner described.

It is worth noting that the three-phase-two-phase transformation shown in Fig. 118 can in an emergency be very readily made without special transformers if one has available transformers of ratios 9: 1 and 10: 1, respectively, both

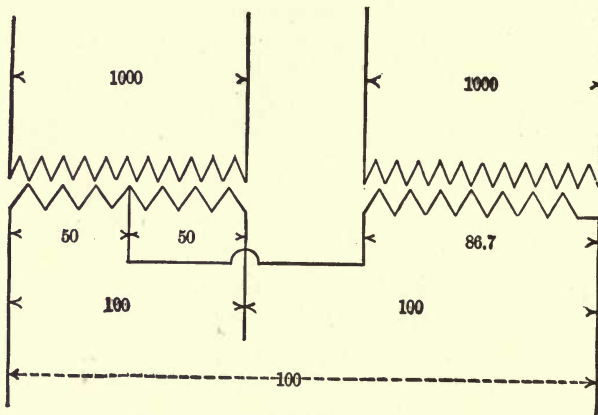

FIG. 118.

these being obtainable commercially. For the latter tapped from the middle of the secondary, as is common for three-wire work, gives the left-hand half of Fig. 118, while the 9: 1 transformer is sufficiently near the required ratio to give the rest of the combination. Such an extemporized arrangement is very serviceable in operating three-phase induction motors from two-phase mains or vice versa, and can be put together very easily. In default of this it is easy enough in using standard transformers of makes in which the secondary windings are fairly accessible, to tap the secondary winding so as to leave about 12 per cent of it dead-ended, and this forms the supplementary transformer required.

The electrician will do well to familiarize himself with the handling of transformers in all sorts of connections, for in a

sudden emergency a little deftness in this respect will often extricate him from an uncomfortable corner. For instance, one can connect transformers backwards to get high voltage for testing, or with the usual three-wire secondaries transform twice and reach half the primary voltage, or put several secondaries in series, with the corresponding primaries in multiple, or do many other things occasionally useful. The chief things to be borne in mind are that the normal currents in primaries and secondaries must not be exceeded, that the polarities must be kept straight and great care must be exercised not inadvertently to get any coils on short circuit.

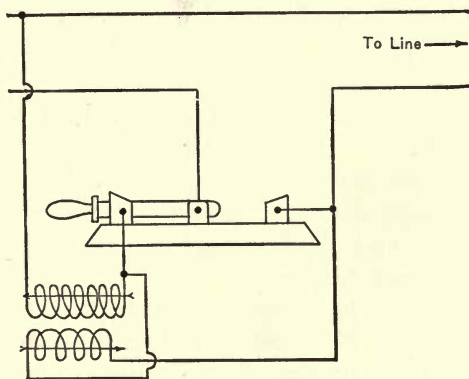

FIG. 119.

One of the most useful temporary expedients is boosting the primary voltage by means of a standard transformer to meet excessive drop in a long feeder. The process is exceedingly simple, being merely the connection of the secondary in series with the line to be boosted, while the primary is put across the mains as usual. The result is that the feeder voltage is raised by nearly the amount of the secondary voltage. Fig. 119 shows a convenient way of arranging the connections, in which one of the primary lines is so connected to a double throw single-pole switch that while boosting goes on with the switch in the position shown, on throwing the switch to the reverse position the booster is cut out and the line receives its current as usual. It must be remembered in such boosting that the

strain on the transformer insulation is more severe than usual, and in particular that the strain between secondary coils and core is the full primary voltage, for which provision is seldom made in insulating secondaries from cores. Hence, in rigging a booster transformer one of the oil-insulated type should be chosen, and it should be very carefully insulated from the ground. For the same reason the boosting transformer should be of ample capacity, so that it will not be likely to overheat, and should in general be treated rather gingerly, like any other piece of apparatus subject to unusual conditions. Nevertheless, it is capable of most effective service if properly operated.

All these systems which involve resultant E. M. F.'s are open to certain practical objections which may or may not be important according to circumstances.

In the first place, the resultant E. M. F. is less than the sum of the E. M. F.'s for which the transformers in the component circuits are wound. For instance, in Figs. 116 and 118, 100 resultant volts are derived from transformers aggregating respectively 200 and 186.7 volts, through the secondaries of which the resultant current has to flow. In the former case one-third and in the latter case two-thirds of the total current is thus derived at a disadvantage, using up more transformer capacity for a given amount of energy than if the transformers were used in the normal manner. On a small scale the disadvantage is seldom felt, but in heavy transmission work with large transformers it may be quite serious.

Second, the disturbance of any one component voltage from drop or inductance, or any shifting of phase between the components from unequal lag, disturbs all the resultant E. M. F.'s. This, again, may or may not be of importance, but it must always be borne in mind, as in every case of combined phases.

It is possible by combinations of transformers similar to those described, to obtain at some sacrifice in transformer capacity a single-phase resultant E. M. F. from polyphase components, or to split up a single-phase current, by the aid of inductance and capacity, into polyphase currents. Neither process is employed much commercially, since both encounter in aggravated form the difficulties common to resultant phase

working mentioned above, and others due to the special form of the combinations attempted. Combining polyphase currents for a single-phase resultant is a process that would be very seldom useful, but the reverse process if it were successfully carried out might be of very great importance in certain distribution problems, and especially in electric railway practice, although in working on the large scale that offers the best field for alternating motors the disadvantage of two trolleys is at a minimum. One very ingenious method of splitting an alternating current into three-phase components is the following, due to Mr. C. S. Bradley, one of the pioneers in polyphase

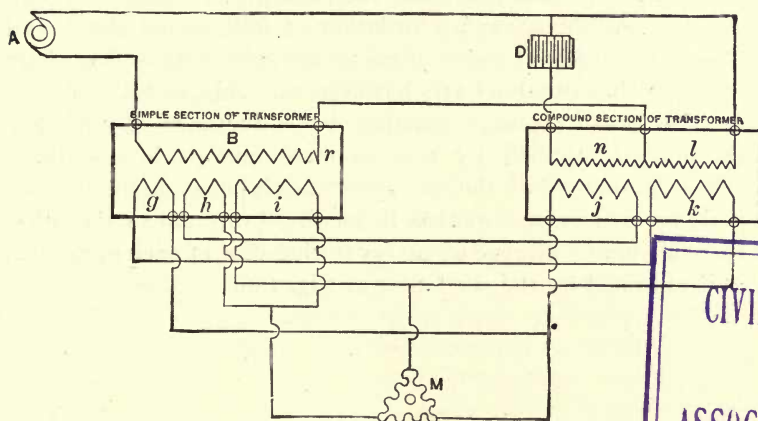

FIG. 120.

work. His process is essentially twofold, first splitting the original current into a pair of components in quadrature and then combining these somewhat as in Fig. 118. The apparatus is shown in diagram in Fig. 120. Here *A* is the generator, *B* the simple primary of one transformer element, *D* a condenser, *n* and *l* the sections of the compound transformer primary, and *g*, *h*, *i*, *j*, *k* the secondary transformer sections. The condenser *D* is so proportioned that acting in conjunction with the compound primary *n*, *l* the original current is split into two components in quadrature, in *B* and *n*, *l* respectively. Then the secondaries are so interconnected as to produce three-phase resultant currents which are fed to the

CIVIL ENGINE
U. of C
ASSOCIATION

motor M . The coil i gives one phase, the resultant of g and k another, and the resultant of h and j the third. The combination of these resultants gives a more uniform and stable phase relation under varying loads than would be obtained from two-phase secondaries fed by B and $n l$ respectively. The condenser is necessary in getting a correct two-phase relation in the primaries to start with, and even so the E. M. F.'s will not stay in quadrature under a varying load on the secondaries unless the condenser capacity be varied, but the recombination in the secondaries partially obviates this difficulty. A device brought out abroad by M. Korda for a similar purpose omits the condenser and splits the monophasic current into two components 60° apart by variation of inductance alone, and these are utilized to give three-phase resultants. The phase relations thus obtained are, however, unstable, as must always be the case in phase splitting by inductance alone. For the energy supplied by a monophasic current is essentially discontinuous, while the energy of a polyphase circuit has no periodic zero values, so that in passing from one to the other there should be storage of energy during part of each cycle such as is obtained by the condenser of Fig. 120.

CHAPTER VI.

ALTERNATING CURRENT MOTORS.

THE principles of the synchronous alternating motor are a snare for the unwary student of alternating current working, since they involve, when discussed in the usual way, rather complicated mathematical considerations. And the worst of it is that the generalized treatment of the subject often causes one to lose sight of the fundamental ideas that are at the root of alternating and continuous current motors alike. The subject is at best not very simple, and unless we are prepared to attack the general theory with all its many considerations, it is desirable not to cut loose from the common basis of all motor work.

Recurring to the rudimentary facts set forth in Chapter I, we see that an electric motor consists essentially of two working parts — a magnetic field and a movable wire carrying an electric current. The motive power — torque — is due to the reaction between the magnetic stresses set up by the current and those due to the field. The refinements of motor design are concerned with the efficient production of these two sets of stresses and their coördination in such wise that their reaction shall produce a powerful torque in a uniform direction.

In continuous current motors, for example, the field magnets are energized by a part or the whole of the working-current, and this current is passed, before entering the armature, through a commutator like that of the generator, so that in the armature the direction of the currents through the working conductors shall be reversed at the proper time, so as to react in a uniform direction with field poles which are consecutively of opposite polarity. Were it not for the commutator the armature would, on turning on the current, stick fast in one position, as may happen when there is a defect in the winding.

Now, since the function of the commutator in the generator

is to change a current normally alternating, so that it shall flow continuously in one direction, and since the object of the commutator in the motor is periodically to reverse this current in the armature coils, thus getting back to the original current again, one naturally asks the reason for going to all this trouble. Why not let the generator armature do the reversing instead of providing two commutators — the second to undo the work of the first?

The reason is not far to seek. In a generator running at uniform speed the reversals of current take place at certain fixed times — whenever an armature coil passes from pole to pole, quite irrespective of the needs of the motor. The commutator on the other hand reverses the current in the motor armature coils in certain fixed positions with respect to the field poles so as to produce a continuous pull, irrespective of what the generator is doing.

If we abolish the commutators the motor will run properly only when the alternating impulses received from the generator catch the armature coils systematically in the same positions in which reversal would be accomplished by the commutator. Hence for a fixed speed of the generator the impulses will be properly timed only when the motor armature is turning at such a speed that each coil passes its proper reversal point simultaneously with each reversal of the generator current. If generator and motor have the same number of poles, this condition will be fulfilled only when they are running at exactly the same number of revolutions per minute. In any case they must run synchronously *pole for pole*, so that if the motor has twice as many poles as the generator, it will be in synchronism at half the speed in revolutions per minute, and so on.

If we try to dispense with the commutators when starting the motor from rest, the action will obviously be as follows: The first impulse from the generator might be in either direction, according to the moment at which the switch was thrown. The reaction between this current in the armature coils and the field poles might tend to pull the armature in either direction, but long before the torque could overcome the inertia of the armature a reverse impulse would come from the gen-

erator and undo the work of the first. Consequently the motor would fail to start at all.

If the impulses from the generator came very slowly indeed, so that the first could give the armature a start before the second came, the armature would stand a chance of getting somewhere near its proper reversal point before the arrival of the reverse current, and thus might get a helping pull that would improve matters at the next reversal, but the direction of the first impulse would be quite fortuitous. Starting the armature in either direction before the current is thrown on gives it a better chance to go ahead if the first impulses in the wrong direction are not strong enough to stop it altogether.

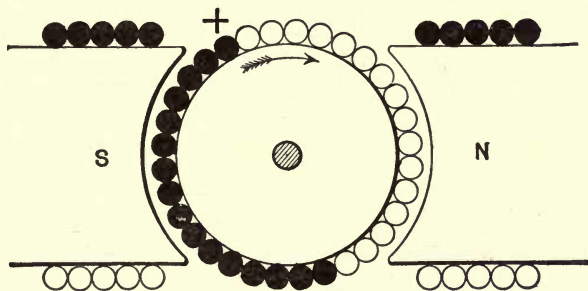

FIG. 121.

We see, then, that an alternating current derived directly from the generator does not give reversals in the motor coils that are equivalent to the action of a commutator, save at synchronous speed. Except at this speed the current from the generator does not reverse in the motor armature coils when the latter are in the proper position.

Fig. 121 will give a clear idea of the conditions of affairs in the field and armature conductors of a continuous current motor. Here *S* and *N* are the poles, and + and - mark the positions of the positive and negative brushes with reference to the armature winding. The solid black conductors carry current flowing down into the plane of the paper. The white conductors carry current upward. The armature turns in the direction of the arrow, and as each conductor passes under the brush the current in it is reversed. This distribution of

current is necessary to the proper operation of the motor, and if the brushes are moved the motor will run more and more weakly, and then stop and begin to run in the opposite direction, until when the brushes have moved 180° the motor will be running at full power in the reverse direction. This final position means that the currents in the two halves of the armature have exchanged directions, so that the conductors originally attracted toward *N* and repelled from *S*, are now repelled from *N* and attracted toward *S*. If alternating current from the generator is led into the windings, the distribution of current shown in Fig. 121 must be preserved, and since in abolishing the commutator the alternating current leads are permanently connected to two opposite armature coils through slip rings, the distribution of Fig. 121 can only

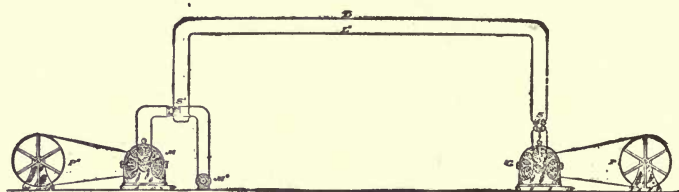

FIG. 122.

be preserved when these leads change places by making a half revolution every time the current reverses its direction. Otherwise the distribution of currents will be changed, and the motor will fail to operate, since each reversal of current will catch the armature in a wrong position, and may tend to turn it in the wrong direction as much as in the right.

Hence such a motor must run in synchronism, or not at all, and to operate properly it must either be brought to full synchronous speed before the alternating current is turned on, or nursed into action by running the generator very slowly, working the motor into synchronous running at very low speed, and then gradually speeding up the generator, thus slowly pulling the motor up to full speed. In practice the former method is uniformly employed, and the machine used as a synchronous motor is substantially a duplicate of the alternating generator as already described. In fact, it is an alternating

generator worked as a motor, just as a continuous current motor is the same thing as the corresponding generator.

Fig. 122 gives a clear idea of the way in which synchronous alternating motors may be employed for power transmission. Here G is the generator driven from the pulley P . S is a switch connecting the generator to the line wires $L L'$. At the motor end of the line is a second switch S' , which can connect the line either with the synchronous motor M , or the starting motor M' . This latter is usually some form of self-starting alternating motor to which current is first applied. M' then gradually brings M up to synchronous speed; when the switch S' is thrown over, the main current is turned on M , and then the load is thrown on the driving pulley P' by a friction clutch or some similar device.

Such a system has certain very interesting and valuable properties. We can perhaps best comprehend them by comparing them with the properties of continuous current motor systems.

In the alternating system both generator and motor are usually separately excited, which means really that the field strengths are nearly constant; as constant in fact as those in a well designed shunt-wound generator and motor for continuous current.

Now we have seen that this latter system is beautifully self-regulating. Whatever the load on the motor, the speed is nearly constant, and the current is closely proportional to the load. If the load increases, the speed falls off just that minute amount necessary to lower the counter E. M. F. enough to let through sufficient current to handle the new load. The effective E. M. F. is the difference between E , the impressed E. M. F. and E' , the counter E. M. F. The current produced by this E. M. F. is determined by Ohm's law.

$$C = \frac{E - E'}{r} \quad (1)$$

where r is the armature resistance, and since we have seen that the output of the motor is measured by the counter E. M. F.,

$$W = C E' \quad (2)$$

where W , in watts, includes frictional and other work. E' , neglecting armature reaction, is proportional to the speed of the armature, which falls under load just enough to satisfy equation (2) by letting through the necessary current.

Now we have seen that when we abandon the commutator the motor has to run at true synchronous speed, or else lose its grip entirely. How can it adjust itself to changing conditions of load? If the load increases, more current is demanded to keep up the output, but the field strength remains constant, and the counter E. M. F. of the motor cannot fall by reduction of speed. We must note that while in a continuous-current motor the counter E. M. F. of the armature is constant at uniform speed, in an alternating motor the counter E. M. F.

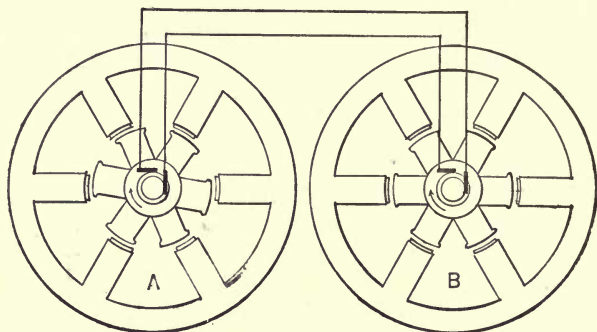

FIG. 123.

varies like that of the generator, following approximately a sinusoidal curve, as the position of the armature with respect to the field poles varies.

Hence at any given instant the counter E. M. F., the speed and field strength remaining the same, depends on the position of the motor armature. In Fig. 123 we have a pair of alternating machines, generator *A* and motor *B*. In normal running at light load, the two are nearly in opposite phase, since of course the impressed and counter E. M. F.'s are virtually in opposition.

Now, if there is an increase of load the motor armature sags backward a little under the strain, thereby lessening the component of its counter E. M. F. that is in opposition to the

impressed E. M. F. The current increases, and with it the torque, and the sagging process stops when the torque is great enough to carry the new load as synchronous speed. The change of phase in the counter E. M. F. thus takes the place of change of absolute speed in the continuous current motor, by the same general process of increasing the E. M. F. effective in forcing current through the circuit. This effective E. M. F. is generally by no means in phase with the impressed E. M. F., and in general the current and the impressed E. M. F. are not in phase in a synchronous motor. Here, as elsewhere, the input of energy is

$$C E \cos \phi,$$

while the output, which in the continuous current motor is simply the product of the current and the counter E. M. F., in the synchronous motor depends evidently on such parts of both as are in phase with each other, *i. e.*,

$$W = C E' \cos \phi' \quad (3),$$

in which ϕ is the angle between current and counter E. M. F. Likewise the current, which in the continuous current motor depends on the effective E. M. F. and the resistance, now depends on the counter E. M. F. and the impedance I . So that

$$C = \frac{E - E'}{I} \quad (4).$$

In this equation the values of all the quantities depend on their relative directions, and by combining geometrically the factors of (4) we can form a clear idea of the singular relations that may be found in synchronous motor practice.

The construction is similar to that found in Fig. 51, page 133.

In Fig. 124, we will start with an assumed impressed E. M. F. of 1,000 volts, a counter E. M. F. of 800 volts and an impedance composed of 5 ohms resistance and 10 ohms equivalent inductance.

To begin with, we will lay off the impressed E. M. F. AB , and then the counter E. M. F. BC , which as we have seen is in partial opposition to AB . In this case AC is the resultant E. M. F., which, on the scale taken, is 300 volts. This, then, is

the available E. M. F. taken up by the inductive and ohmic drops in the armature. The next step is to find C (eq. 4) from I , and the value of $E - E'$, just obtained. To obtain I , we must combine resistance and inductance, as shown in Fig. 55. Performing this operation, it appears that $I = 11.18$. Hence

in the case in hand $C = \frac{300}{11.18} = 26.8 +$ amperes. As to the

direction of this current, we know that it is at right angles to the inductive E. M. F., *i. e.*, is in phase with the resistance in Fig. 125. Solving that triangle to obtain the angle between the current and impedance, it turns out to be a little over 63° ,

being the angle whose tangent is $\frac{10}{5}$. Laying off this angle a from $A C$, the impedance in Fig. 124, we find the current to be

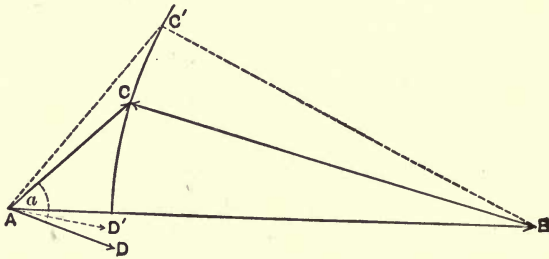

FIG. 124.

in the direction $A D$. This current then is out of phase with the impressed E. M. F. by the angle of lag $D A B$. It is also out of phase with the counter E. M. F., though by chance very slightly, and lags behind the resultant E. M. F. $A C$, by the angle a . Being nearly in phase with the counter E. M. F., the gross output of the motor is approximately $26.8 \times 800 = 21.4$ KW.

Now, what happens when the load increases? The motor armature sags back a few degrees under the added torque, and the counter E. M. F. takes the new position $B C'$. The new resultant E. M. F. is $A C'$, which on the scale taken equals 450 volts. The new value of the current is $C = \frac{450}{11.18} = 40.25$ amperes, and its phase direction, 63° from $A C'$, is $A D'$. The

new angle of lag is then $D' A B$, showing that under the larger load the power factor of the motor has improved. If $C B$ should lag still more, $A C'$, together with the current, would keep on increasing. Evidently, too, the angle of lag $D' A B$ will grow less and less until $A C' B$ becomes a right angle, when in the case shown it will be very minute, and the power factor will be almost unity. Beyond this point the angle $C' A B$ will obviously begin to decrease, and $D' A B$ will begin to open out, again lowering the power factor at very heavy loads.

Hence it appears that at a given excitation there is a particular load for which the power factor is a maximum, and it is evident from the figure that in the example taken this maximum will be higher as the inductance of the system decreases,

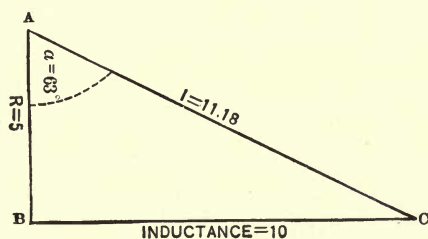

FIG. 125.

and also will pertain to a smaller output. Let us now see what happens when the excitation of the motor is varied. In Fig. 126 the conditions are the same as before, except that we assume counter E. M. F.'s of 500 volts corresponding to C and 1,100 volts corresponding to C' . Examining the former, the resultant E. M. F. is $A C = 528$ volts, the corresponding current is 47 + amperes and the angle of lag $D A B$ is much greater than before. The power factor evidently would still be rather bad under increased loads, and worse yet, when at lighter loads the angle $A B C$ decreases. Lessened inductance, however, would help the power factor by decreasing the angle $C A D$, and hence $B A D$. Now, consider the result of increasing the motor excitation to $B C' = 1,100$ volts. The resultant E. M. F. now becomes $A C'$, being shifted forward nearly 90° , its value is 280 volts and the current is 25 +

amperes. But this current is now in the direction $A D'$, a being the same as before, and hence it no longer lags, but *leads* the impressed E. M. F. by nearly 45° . The power factor is therefore still bad, but gets better instead of worse under loads greater than that shown. Inductance in the system now improves the power factor, and combined with heavy load might bring the current back into phase with the impressed E. M. F.

The counter E. M. F.'s corresponding to C and C' are rather extreme cases for the assumed conditions, but it is easy to find a value for the excitation which would annul the lag exactly for a particular value of the load. Laying off in Fig. 126, $C'' A B = C' A D'$ we find the required counter E. M. F., which is very nearly 910 volts. At the particular output cor-

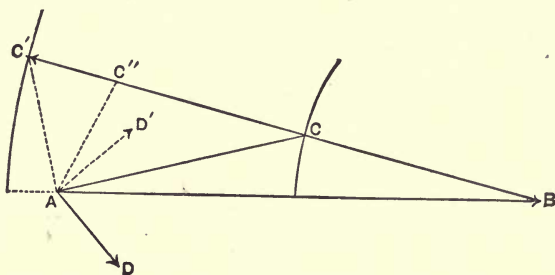

FIG. 126.

responding to this condition, the power factor is unity, the current and the impressed E. M. F. are in phase, and since the current is therefore a minimum for the output in question, the efficiency of the conducting system is a maximum. At this point, too, the energy is correctly measured by the product of volts and amperes, so that if wattmeters are not at hand the input at a synchronous motor can be closely approximated at any steady load by varying the field until the armature current is a minimum, and reading volts and amperes.

Throughout this investigation it has been assumed that the ratio of resistance and inductance has been constant. This is not accurately true, but is approximately so when the inductance is fairly low. The phenomenon of leading current in a synchronous motor system does not indicate that the current,

in some mysterious way, has been forced ahead of the E. M. F. which produces it, for the impressed E. M. F. is not responsible for the current, which is determined solely by the resultant E. M. F. behind which the current invariably lags.

The net practical result of all this is that a synchronous alternating motor, under varying excitation, is capable of increasing, diminishing, or annulling the inductance of the system with which it is connected, or can even produce the same result as a condenser in causing the current to lead the impressed E. M. F. The maximum torque of the motor, which determines the maximum output, is determined by the greatest possible value of $C E' \cos \phi'$ consistent with the given impedance and electromotive forces. The stronger the motor field, and the less the armature inductances and reactions of both generator and motor, the greater the ultimate load that can be reached without overburdening the motor and pulling it out of step.

As regards the relation in phase between current and impressed E. M. F., the three commonest cases are those for which the currents were computed for Figs. 125 and 126. The first, and commonly the most desirable, is that in which the current lags slightly at small loads, gradually lags less and less, comes into phase, or very nearly so, at about average load, and lags slightly again at heavy loads. The maximum efficiency of transmission, reached when the lag touches zero, is then at about average load. The second and commoner case is when the motor is rather under-excited, so that the lag merely reaches a rather large minimum, never touching zero. The third case is that in which the current leads at all moderate loads, passes through zero lag, and then lags more and more. The average power factor may be the same as in the first case, but more energy is required for excitation, and no advantage is gained except in carrying extreme loads, often undesirable on account of overheating, or in modifying the general lag factor.

It is highly desirable for economy in transmission that the product of current and E. M. F. should be a minimum for the required load. This condition can be fulfilled for the motor circuit at any load by changing the excitation until the current for that load becomes a minimum. Further, the field of a

uniformly loaded motor may in the same way be made to bring the entire line current of the system to a minimum if the motor be of sufficient capacity. Thus a synchronous motor load can be made very useful in improving the general conditions of transmission. By changing the motor excitation as the load on the motor of the system varies, the power factor can be kept at or near unity for all working loads.

Fig. 127 shows the power factor of a synchronous motor somewhat under-excited, and that of a similar machine with a field strong enough to produce lead at moderate loads. With

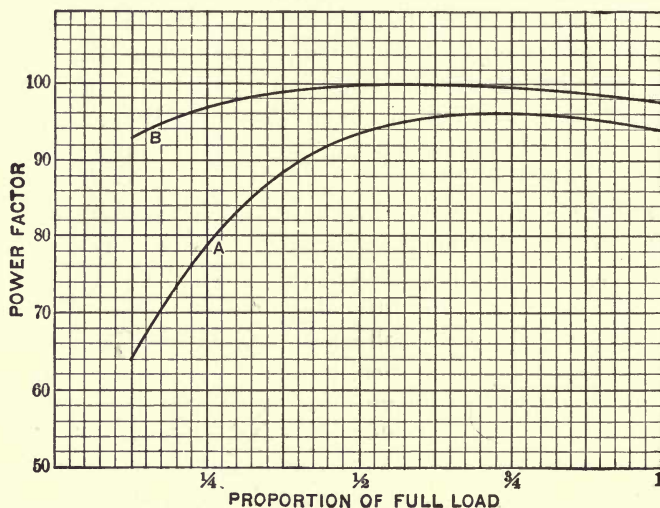

FIG. 127.

proper adjustment of its field, the effect of a synchronous motor on the general conditions of distribution is very beneficial. In curve A, Fig. 127, the indications are that the motor had rather a high inductance and armature reaction, and the excitation was decidedly too low for good results. Curve B is from a 300 HP motor, with its field adjusted for zero lag at about $\frac{1}{3}$ load. The inductance was low and the armature reaction small. The result is somewhat startling. Even at $\frac{1}{3}$ load the power factor (current leading) is about .93. At half load it has passed .99, touches unity, and then slowly diminishes

to very nearly .98 (lagging) at full load. In this case the generator was held accurately at voltage while the excitation of the motor was uniform. Both were polyphase machines wound for 2,500 volts.

When a synchronous motor is used in this manner, it obviously will show, at the same load, values of the current varying if the excitation be varied. For any load the minimum current is given by that excitation which brings the current into phase

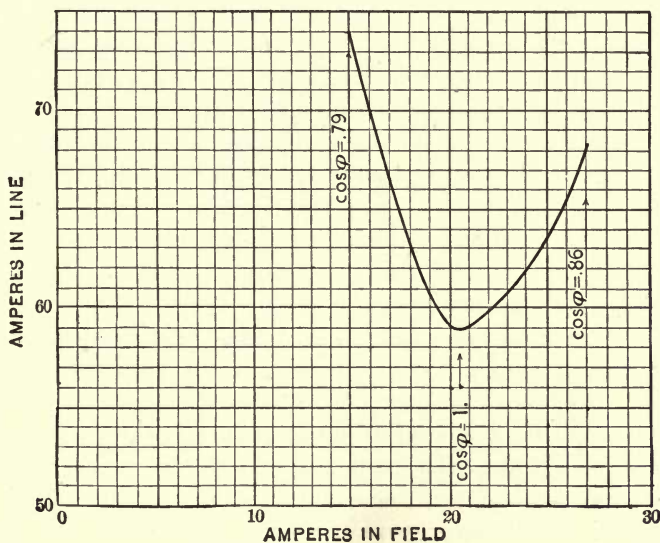

FIG. 128.

with the impressed E. M. F. This point is fairly well defined. At less excitation the current lags, with more it leads.

Fig. 128 shows for a particular instance the relations between the current and the excitation of the motor field, at full load of the motor. It is evidently easy to adjust the excitation to the proper point.

In the practical work of power transmission the synchronous motor has several salient advantages to commend it. At constant frequency it holds its speed absolutely, entirely independent of both load and voltage until, from excessive load or greatly diminished voltage, it falls out of phase and stops.

It constitutes a load that is substantially non-inductive, so that it causes no embarrassing inductive complications in the system, and takes current almost exactly in proportion to its work.

Finally it can be made to serve the same end as a condenser of gigantic capacity in compensating for inductances elsewhere in the system, and thus raising the general power factor substantially to unity.

As compensating disadvantages, it must run at one fixed uniform speed under all conditions, it is not self-starting, and it requires the constant use of a continuous-current exciter.

For many purposes the fixed speed is no objection, and in most large work the exciter can be used without inconvenience. Inability to start unaided, even when quite unloaded, is on the other hand a very serious matter, and has driven engineers to many ingenious subterfuges. The simplest of these is to provide a starting motor, which is supplied with power by any convenient means, and serves to bring the main machine up to synchronous speed. Then the main current is thrown on, the motor falls into synchronism, and the load is taken up by means of a clutch. The difficulty is to start the starting motor. In transmissions of moderate length, continuous current may be delivered over the main line from the exciter of the generator to the exciter of the motor, which is thereby driven as a motor, and brings the alternating motor up to speed. As the energy required for this work is not great, say 10 per cent of the whole power transmitted, it can often be delivered quite easily. At long distances, however, the drop becomes too great for the moderate voltages available with continuous current, and other methods have to be used.

The best known of these is that indicated in Fig. 122 in which the synchronous motor is brought up to speed by an induction motor and then clutched to its load after which the induction motor is thrown out of action.

Another method sometimes used is a special commutator to rectify the current applied to the main motor armature, thus directing the impulses so as to secure a small starting torque, enough to bring the motor to speed. Then the commutator is abandoned and the motor falls to running synchronously.

An ingenious modification of this plan is found in a type of self-starting synchronous motor built by the Fort Wayne Electric Corporation, shown in Fig. 129.

This machine has a double-wound armature. The main winding is of the kind usual in alternators, wound in slots in the armature core, and the leads belonging to it connect with the collecting rings via the brushes on the pulley end of the shaft.

The other winding is a common continuous current drum-

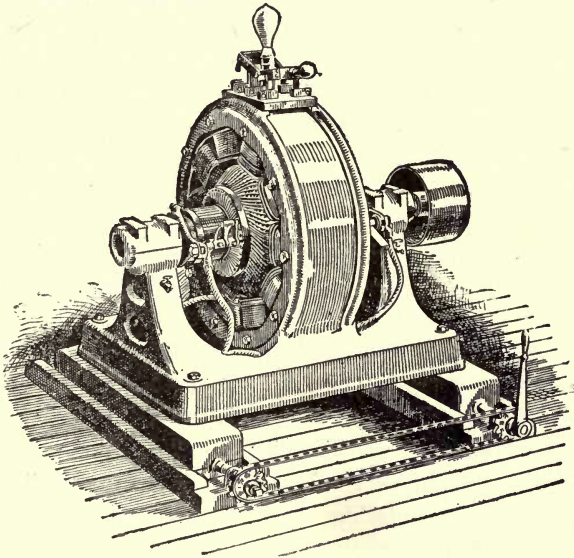

FIG. 129.

winding, laid uniformly on the exterior of the armature. It is provided with a regular commutator as shown in the figure.

The field is of laminated iron, and the field coils are in duplicate, there being a coarse wire winding which in starting is in series with the commutated armature winding, and a fine wire winding cut out in starting, but used alone when the motor is at speed.

The motor in question is started by turning the alternating current, reduced to a moderate voltage by transformation, into

the series field and the commutated winding. The machine then starts with a good torque, and when it has reached synchronous speed, indicated by the pilot lamp on the top of the motor being thrown into circuit by a small centrifugal governor, a switch is thrown over, sending the main current through the alternating winding and closing the fine wire field circuit upon the commutator, at the same time cutting out the series coils. The motor then runs synchronously, the excitation being furnished by the fine wire winding. This construction is best suited for rather small machines, as the double-winding is rather cumbersome for large motors.

At present the tendency in synchronous motor practice is wholly toward the use of polyphase machines. These will start, when properly designed, as *induction* motors, or may be started by separate motors. When at speed the field excitation is thrown on, and the machine thereafter runs in synchronism. As such motors in starting, as induction motors, take a very heavy current they are generally provided with starting motors, although at a pinch they may be brought to speed at reduced voltage independently, especially if it is practicable to drop the frequency temporarily and thus to bring generator and motor up to speed together. Synchronous polyphase motors possess the same general properties as other synchronous motors, and as most power transmission work is now done by polyphase currents, they are widely used.

In general transmission work, synchronous motors find their most useful place in rather heavy work, which can be readily done at constant speed.

They have high power factors even when used for very varying loads, and are valuable in neutralizing inductance in the line and the rest of the load. Even when not deliberately used for this purpose, they raise the general power factor, and thus have a steadying effect that is very useful. When working under steady load and excited correctly, they almost eliminate the lagging current that sometimes becomes so great a nuisance in alternating current working.

The polyphase synchronous motors will run steadily even if one of the leads be broken, working then as monophase machines, and by stiffening the excitation will generally carry

their full normal loads without falling out of synchronism; but, of course, with increased heating.

In one case that came to the author's notice, such an accident befell a three-phase synchronous motor, which went quietly on driving its load of 1,700 looms for four hours, until the mill shut down at night.

For small motor work synchronous machines are somewhat at a disadvantage, from the complication of the exciter and inability to start under load. In sizes below 100 HP they have been very generally superseded by the far simpler and more convenient induction motor, the use of which is a most characteristic feature of modern power transmission. In the use of synchronous motors, both monophase and polyphase, there has been often encountered an annoying and sometimes alarming phenomenon known as "hunting," or where several machines are involved, as "pumping." In mild cases it appears merely as a small periodic variation or pulsation of the current taken by the motor, often sufficient to cause embarrassing periodic variations in the voltage of the system. The frequency is ordinarily one or two periods per second, varying irregularly in different cases, but being nearly constant for the same machine. The amplitude may vary from a few per cent of the normal current upwards. Generally the amplitude remains nearly constant after the phenomenon is fairly established, but sometimes it sets in with great violence and the amplitude rapidly increases until the motor actually falls out of synchronism. This is usually the result of pumping between two or more motors, and seems to be especially serious in rotary converters, not only throwing them out of synchronism, but throwing load off and on the generators with dangerous violence.

Fig. 130 shows a facsimile of a record from a recording voltmeter showing the pulsation of the voltage on the system produced by the hunting of a 300-HP synchronous motor. It set in as the peak of the load came upon the system and persisted until the peak subsided, when it was gotten under control, only to break out again when the late evening load fell off. During the early evening it was so severe as to produce painful flickering in all the incandescents on the circuit.

In this case the dynamo tender was inexperienced and had

not acquired the knack of so juggling the field current as to suppress the hunting. A few months later the same system was in regular operation without the least trouble from hunting, the operators by this time having been thoroughly broken in. In the majority of cases adroit variation of the field strength abolishes hunting, which almost always starts with a

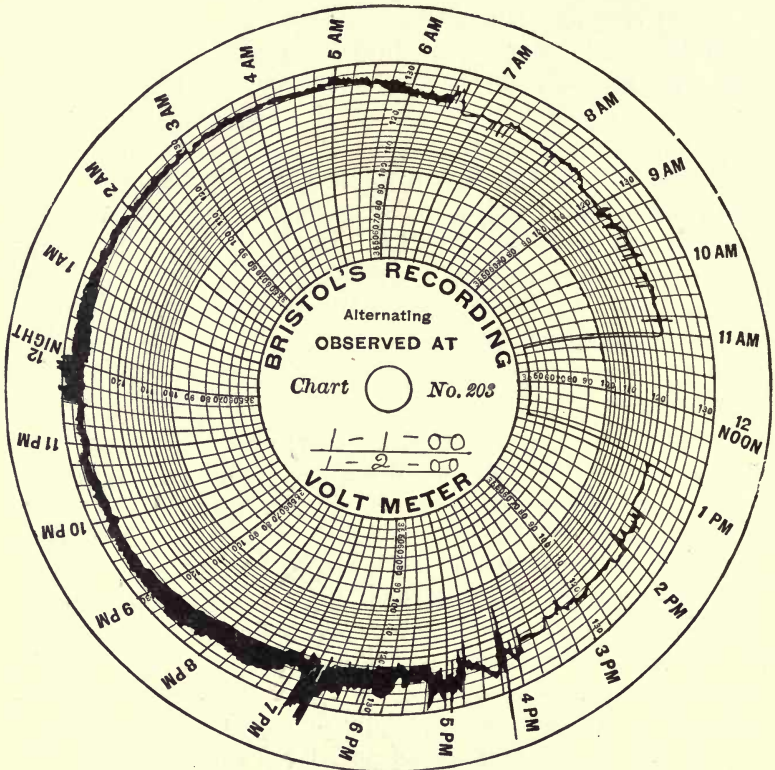

FIG. 130.

sharp change in load or power factor. Just how to handle the excitation to obtain the best results is a matter of experiment in each particular case, but except in cases of unusually serious character the knack is soon acquired. A rather strong field often steadies things, although if strong enough to produce leading current the trouble is sometimes aggravated.

But in this case, as in operating alternators in parallel, the best running conditions have to be learned by experience.

Much yet remains to be learned about the exact nature of hunting, but its general character is about as follows: A sudden change in current or phase causes the armature to seek a new position of equilibrium. In so doing the sudden change in the armature reaction momentarily changes the field strength, which aggravates the instability already existing and causes the armature under the influence of its own inertia to overreach and run beyond its normal position of equilibrium. Then the field recovers and the armature swings back, once more shifting the field and again overrunning, and so on *ad nauseam*. The pulsation of the exciting current in cases of hunting is generally very conspicuous, and the periodicity of the hunting seems to correspond in general with the time constant of the field magnetization.

A fly-wheel on the motor or direct connection to a heavy machine generally increases the trouble by increasing the mechanical momentum of the armature, while belted and flexibly connected motors suffer less. Heavy drop in the supply lines, which makes the voltage at the motor sensitive to variations of current, and low reactance in the armature, which favors large fluctuations of current, are conditions specially favorable to violent hunting. Rotary converters in which the armature current and its reactions are very heavy, compared with that component of the current which is directly concerned with the rotation of the machine as a synchronous motor, are subject to peculiarly vicious hunting, which has often risen to the point where it threw the rotary out of synchronism. They are far less stable in this particular than ordinary synchronous motors, and cannot readily be controlled by varying the excitation on account of the consequent variation of voltage on the continuous current side.

Motors and rotaries having their pole pieces not laminated, but solid, often show less tendency to hunt than machines with laminated poles. If the poles are solid any violent swaying of the armature current with reference to them is checked and damped by the resulting eddy currents, so that the hunting is

pretty effectively choked. For the same reason alternators in parallel are less likely to pump if they have solid poles, and most foreign machines are built in such wise. Here, where laminated poles are just now the rule, recourse is had to "bridges" or "shields." These are essentially heavy flanges of copper or bronze attached to the edges of the poles, so that fluctuations of armature reaction and of field are damped by heavy eddy currents whenever they arise, the bridges acting indeed like a rudimentary induction motor winding. An example of such practice is shown in Fig. 131, which shows a portion of the

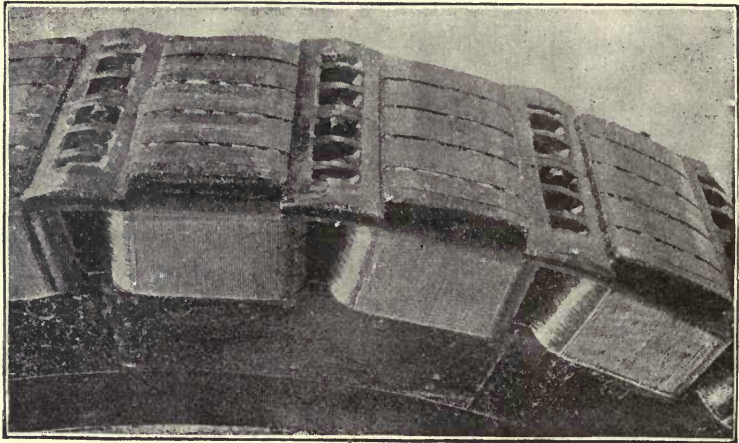

FIG. 131.

revolving field of a large polyphase machine fitted with massive castings, bridging the spaces from pole piece to pole piece and serving at once to hold the field coils rigidly wedged into place and to check pumping. A similar device is used in connection with many rotary converters with a very fair degree of success. Occasionally pumping may be traced to some definite cause like a defective engine governor having a periodic vibration, but more often the phenomenon is purely electromagnetic. The use of shields or solid pole pieces constitutes the best general remedy, for, while adjustment of the field is often effective, it is often desirable to adjust the field

for other purposes, and the necessity of varying it to suppress hunting is sometimes very embarrassing, if not impossible.*

INDUCTION MOTORS.

An induction motor is a motor into which working current is introduced by electromagnetic induction instead of by brushes. It has therefore two distinct, although coördinated, functions — transformer and motor. To understand its action we must take care not to confuse these functions, and this is best done by recurring to the fundamental principles that are at the root of all motors of whatever kind.

An electric motor consists of these essential parts, viz.: A magnetic field, a movable system of wires carrying electric

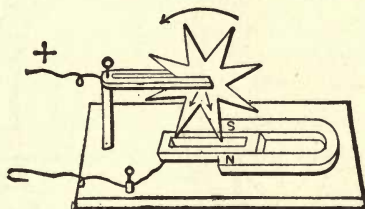

FIG. 132.

currents, and means for organizing these two elements so as to produce continuous torque.

These parts are beautifully shown in their elementary simplicity in Barlow's wheel, Fig. 132, invented some three-quarters of a century ago.

In this machine *NS* is the permanent field-magnet, the arms of the star-shaped wheel are the current-carrying conductors, and a little trough placed between the magnet poles, and partly filled with mercury, serves with the wheel as a commutator. Its function is to shift the current from one conductor to the next following one, when the first passes out of an advantageous position. In other words it keeps the current flowing so as to produce a continued torque, irrespective of the movement of the conductors. Such is precisely the func-

* For the mathematical theory of the subject see Steinmetz, Trans. A. I. E. E. May, 1902.

tion of the modern commutator, and it is interesting to note that the device of making the armature conductors themselves serve as the commutator is successfully used in some of the best modern machines.

These same fundamental parts are found alike in motors designed for continuous or for alternating currents. We have already seen that a series-wound motor can serve for use with both kinds of current, since the commutator distributes the current alike for both, and since the direction of the torque is determined by the relative direction of the main field and that due to the moving conductors, alternations which affect both symmetrically leave the torque unchanged.

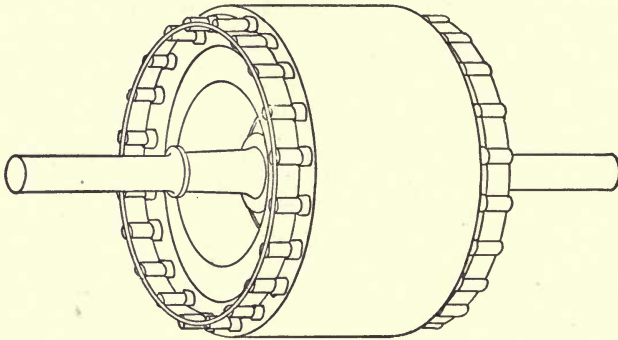

FIG. 133.

We have seen also that if the distribution of currents given by the commutator can be simulated by supplying the armature with alternating impulses timed as the commutator would time them, we can dispense with the commutator, and substitute two slip rings. In this case, however, the motor will run only when in synchronism, since then only will the alternating impulses from the generator be properly distributed in the armature, as has already been explained. Besides, the current has to be introduced into the armature through brushes bearing on a pair of slip rings, and an exciter is required to supply the field. If one could use an alternating field, and induce the currents in the armature as one would in the secondary of a common transformer, the machine would be of almost ideal simplicity.

This is what is accomplished in the induction motor. The field is supplied with alternating current, and the working current is induced directly in the armature conductors.

To this end the brushes used in the previous examples may be replaced by a pair of inducing poles, carrying the primary windings, to which the armature windings play the rôle of secondary. These armature windings are therefore closed on themselves, instead of being brought out to slip rings.

For this short-circuited winding various forms are employed, the simplest being shown in Fig. 133. It consists of a set of copper bars thrust through holes near the periphery of the

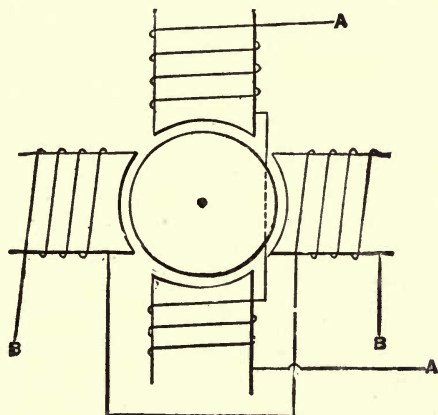

FIG. 134.

laminated armature core, and all connected together at each end by heavy copper rings.

The simplest arrangement of field and inducing poles is shown in Fig. 134. Here each pair of opposite poles is provided with a separate winding, so that the circuit *A A* supplies alternating current to one pair and *B B* to the other pair. The armature we will assume to be like Fig. 133. Now apply an alternating current to *A A*. The windings of the armature which enclose the varying electromagnetic stress will have set up in them a powerful alternating current almost 180° behind the primary current, *i.e.*, in general opposed to it in direction, as considerations of energy require. The armature will not turn,

however, for two very good reasons: first, the current in it is far out of phase with the magnetization of the poles; and second, this current is quite symmetrical with respect to the poles, so that the only effect could be a straight push or pull without the slightest tendency to attract or repel one side of the armature more than the other.

To produce rotation as a motor, there must be not only a current in the armature conductors, but there must be field poles magnetized and disposed so as to produce a torque upon these conductors.

Suppose, now, an alternating current to be sent around the circuit *B B*. If it is applied simultaneously with the current in *A A*, we shall be no better off than before, for since the two pairs of poles act together and just alike, there is no magnetization in phase with the armature current, and nothing to cause the armature to turn either way.

To obtain rotation we must arrange the two sets of poles so that one pair may furnish a magnetic field with which the current induced by the other pair is able to react. The simplest way of doing this is to supply *B B* with current 90° in phase behind the current in *A A*. Then when the current induced by *A A* rises, it finds the poles *B B* energized and ready to attract it, for the magnetization in *B B* and the current are less than 90° apart in phase. The less the lag of the armature current behind its E. M. F., the more nearly will the magnetization of these field poles be in phase with the armature current, and the more powerful will be the torque produced.

The *B B* set of poles necessarily induce secondary currents in the armature in their turn, toward which the *A A* poles serve as field during the next alternation. The directions of both armature current and field magnetization are now reversed, so that, as in the commutating motor, the torque is unchanged. The next alternation begins the cycle over again, and so the motor runs up to speed. Its direction of rotation depends evidently upon the relative directions of magnetization in the two sets of poles, for these determine the direction of the armature current and the nature of the field poles that act upon it. Reversing the current in *A A* or *B B* will therefore reverse the motor, while reversing both will not.

The speed of the armature is determined in a rather interesting manner. When the armature is in rotation the electromagnetic stresses which act upon a given set of armature conductors are subject to variation from two causes. First is the variation in magnetization, due to changes in the primary current; second, the variation due to the armature coils moving as the armature turns, so as to include more or less of the magnetic stress. The E. M. F. in the armature conductors is due to the summed effect of these two variations. And since the two are in opposition, if the armature were moving fast enough to make a half revolution for each alternation of the field, the E. M. F. produced would be zero, since the rates of change in the field and in the area of stress included by the armature coils would be equal.

This means that the armature must always run at less than synchronous speed — enough less to produce a net armature E. M. F. high enough to give sufficient armature current for the torque needed.

Under varying loads, therefore, an induction motor behaves much like a shunt-wound continuous current motor. In both, the armature current is due to the net effect of an applied and a counter E. M. F., the former being delivered from the line through brushes in the one case and by induction in the other. In neither case can the speed rise high enough to equalize these two E. M. F.'s. There is, however, a very curious and interesting form of induction motor which runs at true synchronous speed until the load upon it reaches a certain point, when it falls out of step like any other synchronous motor, or under certain circumstances falls out of synchronism and then operates like an ordinary asynchronous motor.

Its operation in synchronism seems a paradox at the first glance; but the principle involved is really simple, although the exact theory of the motor is a bit complicated. As has already been noted, if the rates of change of magnetic induction due to the pulsation of the field and to the cutting of the field by the armature coils are equal and opposite, there will be no E. M. F. in these coils, and obviously no energy can be transferred from field to armature. If, however, the E. M. F. wave due to the change of magnetization in the field

and that due to the motion of the armature coils through the field are very different in shape, there can still be a periodical resultant E. M. F., generally of a very complicated description, accompanied by a transfer of energy even at full synchronous speed. A very irregular wave shape in the E. M. F. of supply, or a distortion of it due to extraordinary armature reactions, may produce this condition. Fig. 135 shows the primary E. M. F. wave form as taken by the oscillograph across the terminals of such a synchronous induction motor, and the corresponding current wave, which emphasizes the significance of the facts just given. The condition is best reached in small motors having sharply salient field poles. The writer has never seen one which would start from rest unaided, the great

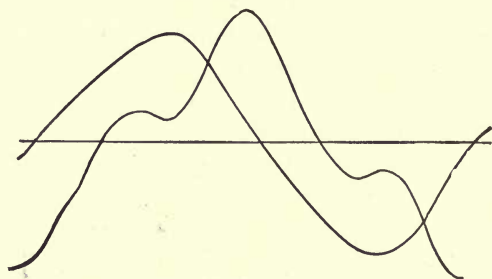

FIG. 135.

field distortion necessary being in the way, but once spun up to or near synchronism they work admirably on a small scale. The conditions of energy supply are obviously such as to be highly unfavorable in motors of any size, but for laboratory or other purposes where synchronous speed is wanted they are very convenient for an output of $\frac{1}{8}$ HP or so, and form a very striking modification of the ordinary induction motor. They have, up to the present, been made mostly by the Holtzer-Cabot Electric Co.

If the load on an induction motor increases, demanding an increased torque, the armature slows down a trifle, until the new armature E. M. F. and resulting current are just sufficient to meet the new conditions. In the continuous current motor this speed is determined by the resistance of the armature, to which the current corresponding to a given decrease of speed

is necessarily proportional. In the induction motor the armature resistance plays a precisely similar rôle. Fig. 136 shows the actual speed variation of a 100 HP induction motor in terms of its output. The maximum fall in speed under full load is a trifle less than 3 per cent, and even this result is sometimes surpassed in induction motors for especial purposes, even a 1 per cent variation having been reached. A motor with higher armature resistance would fall more in speed, like a shunt motor with a rather high armature resistance. We thus see that the induction motor, as it should, behaves much like any other motor; the torque is produced in the same way, and obeys similar laws; the motor is similarly self-starting, and works on the same general principles throughout. Obviously the magnitude of the armature current in an induction motor is

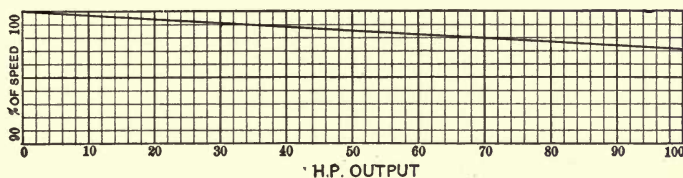

FIG. 136.

determined, not by the armature resistance alone, but by its *impedance*. As, however, the presence of reactance shifts the phase of the current, and that component of current which is effective in producing torque depends upon the resistance, the relation just explained holds good. That current is delivered to the armature by induction is a striking feature, but not one that implies any radical difference in principle.

It is not even necessary to use a polyphase circuit for working induction motors, for, under certain conditions, the same set of poles can perform the double duty of delivering current and interacting with it to produce torque.

The principles of the induction motor, as here given, thus become part of the general theory of the electric motor which applies alike to machines for continuous and alternating current, quite independent of particular methods of construction or operation.

The great pioneers in induction motor work, Tesla, Ferraris, and some others, preferred to view the matter from the special rather than the general standpoint, and hold to the theory of the rotary pole action of induction motors — very beautiful, mathematically, but unfortunately hiding the kinship of induction to other motors, and distracting attention from the transformer action, which is so prominent.

From this point of view the two pairs of poles in Fig. 134

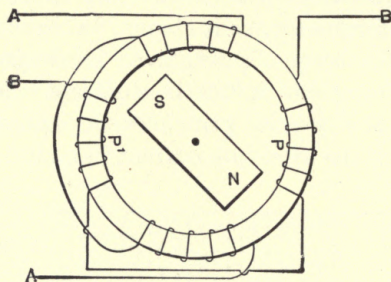

FIG. 137.

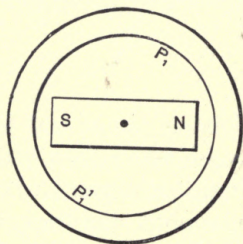

FIG. 138.

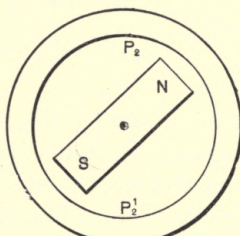

FIG. 139.

co-act to produce an oblique resultant magnetization, which shifts around the field, producing a moving system of poles, following the sequence of the current phases, and dragging around the armature after them, by virtue of the currents induced in it. Figs. 137, 138, 139 show the rudimentary principles of the rotary pole. In Fig. 137 an annular field magnet is wound with two circuits *A A* and *B B*, supplied with alternating currents 90° apart in phase. The polarity of the armature is represented diagrammatically by the rotating magnet *N S*.

Now, when the current in $A A$ is maximum (and that in $B B$ is consequently zero), the field has poles at P and P' , which exert a torque on the armature poles. As the current falls in $A A$ and rises in $B B$, the resultant poles move forward to P_1 and P_1' (Fig. 138), followed by the armature. When the current $B B$ is a maximum, and $A A$ has become zero, the poles are at P_2 and P_2' and so on. In order that the revolving poles may induce current in the armature, the latter must slip behind so as to produce relative motion and change in electromagnetic stress.

This point of view is very interesting and instructive. It deals, however, not directly with the two field magnetizations — the functions of which have just been discussed — but with a resultant rotary magnetic field, which may or may not have a concrete existence, according to circumstances. It by no means follows that because two equal energizing currents are 90° apart in phase, they must or do form a resultant rotary magnetic field, or that, if they are so organized as to give a physical resultant, their individual functions are superseded and must be neglected.

The two views of the induction motor here set forth are not in any way conflicting; they merely represent two methods of treatment of the same phenomena. As it happens, the rotary field point of view is from a mathematical standpoint the easier, for it treats the resultant instead of its components, and hence has been the oftener used, but in discussing certain classes of induction motors, it is by no means convenient, and is less general than the analytical method, which deals with the separate components. In most commercial induction motors there is undoubtedly a resultant rotary field, but however convenient it may be to consider the motors in that light, it is not well to lose sight of the general actions of which the rotary field is a special case.

As a matter of fact, the several currents in a polyphase induction motor may be so distributed that they cannot produce a resultant rotary magnetization, and in certain heterophase and monophase motors the "rotary field," in so far as one is formed by the field, may revolve in one direction while the armature starts and runs strongly in the other direction.

Hence, the view here taken of the induction motor has been generalized for the purpose of bringing out its relation to the general theory of motors, and to take account of induction motors, in explaining which the rotary pole theory would have to be, as it were, dragged in by the ears.

Salient poles, like those of Fig. 134, are seldom used, and the induction motor as generally constructed, consists of two

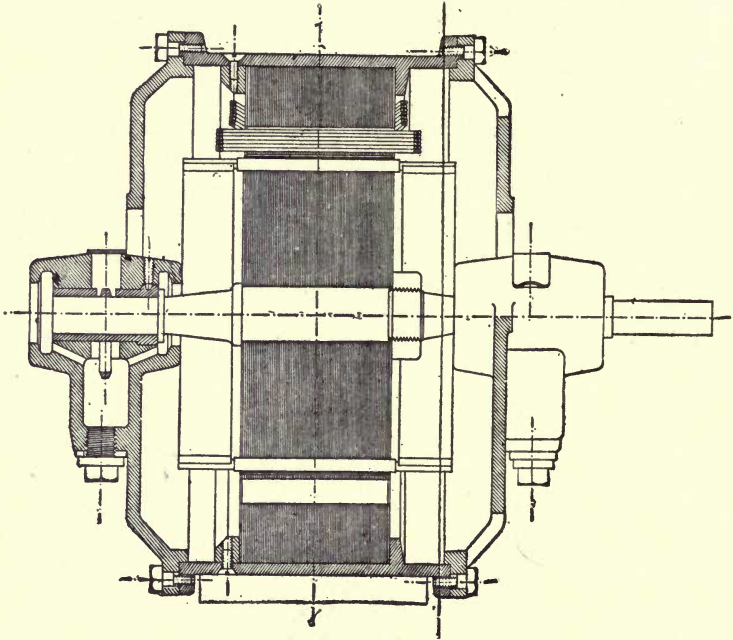

FIG. 140.

short concentric cylinders of laminated iron, slotted on their opposed faces to receive the windings. Sometimes these slots are open, and again they are simply holes close to the surface of the iron.

The relation of the parts is well shown in Fig. 140, a 6 HP two-phase motor by C. E. L. Brown.

In this case the exterior ring is the primary, and the revolving ring the secondary element of the motor. The primary winding is of coils of fine wire threaded through the core holes, while the secondary member is wound, if one may use

the term, with solid copper rods united at the ends by a broad copper ring. The clearance between primary and secondary is very small in all induction motors, almost always less than $\frac{1}{8}$ inch, sometimes less than $\frac{1}{32}$ inch. The smaller the clearance the better the machine as a transformer.

The primary of an induction motor is wound much as the armature of a polyphase generator is wound, as described already. Fig. 141 shows in diagram a two-phase winding for a 24 slot primary, and Fig. 142 a three-phase winding for the same primary. In the former there are two sets of coils, A

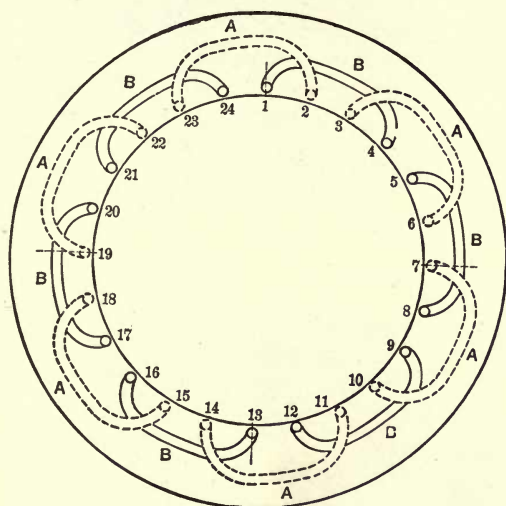

FIG. 141.

and B, each forming a separate phase winding; in the latter the three sets, A, B, C, may be united to form either a "star" or "mesh" three-phase winding. In practice the primary winding is nearly always polydental, for the same general reasons that hold for generator armatures, but especially to keep down inductance. For the same reason the secondary winding is polydental. As an example of the best usage in this respect, Fig. 145 shows the number and relation of primary and secondary slots in the motor shown in Fig. 140. There are no less than 40 primary slots for a four-pole winding, *i.e.*, 5 slots per phase per pole, while the secondary has 37 slots, this odd

number being chosen to reduce the variation in the magnetic relations of primary and secondary due to different positions of the armature.

Induction motors with fixed primary have the great advantage of having no moving contacts, and no high voltage windings exposed to the strains due to revolution. On the other hand a revolving primary makes it very easy to vary the resistance in the secondary circuit, which is often desirable. Both forms are used, the latter only rarely. Inasmuch as a large proportion of the hysteretic loss occurs in the primary, since

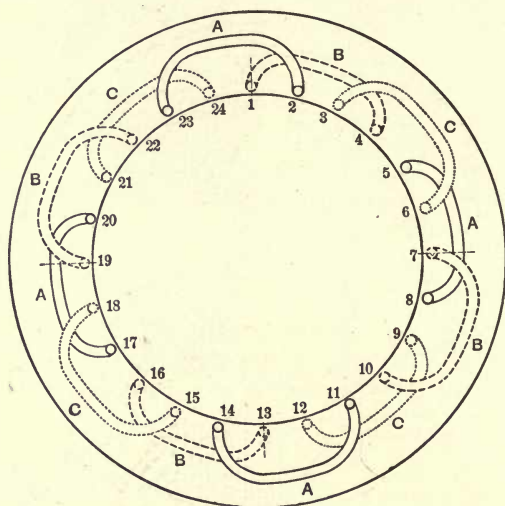

FIG. 142.

in the secondary the variation of the magnetization is small, a revolving primary, being of less dimensions than its secondary, gives a slight advantage in efficiency. There is, however, small reason to suppose that on the whole it is easier to build one form than the other for a given efficiency with the same care in designing. In recent practice it is not uncommon to wind the primaries of large induction motors for voltages up to 10,000.

Motors with revolving primary are no longer regularly manufactured, the vastly superior simplicity of the other construction being generally recognized. Plate VII shows the

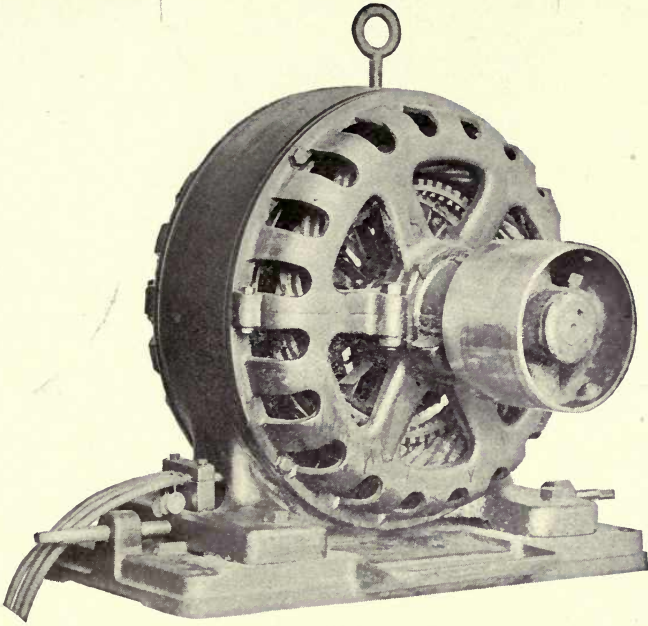

FIG. 1.

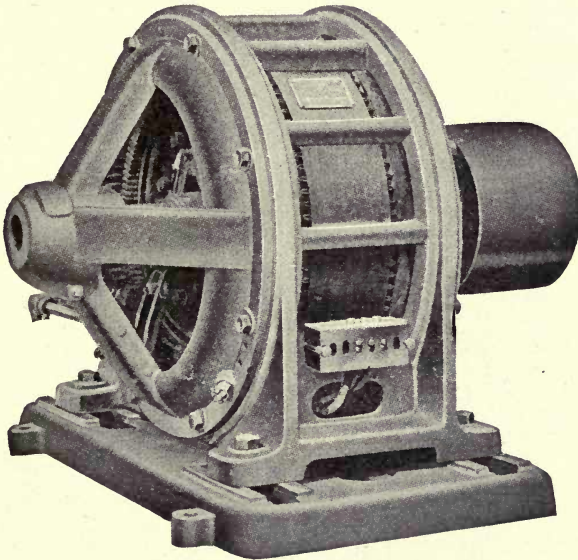

FIG. 2.

PLATE VII.

UNIVERSITY OF CALIFORNIA
DEPARTMENT OF CIVIL ENGINEERING
BERKELEY, CALIFORNIA

motors now in common use in this country. Fig. 1 is a standard Westinghouse "Type CC" motor of 10 HP. It is exceedingly simple in construction, and efficient in operation. It has a "squirrel-cage" armature similar to that of Fig. 133, but the bars are in open slots and are of rectangular section, a construction which gives a lower armature reactance than if the iron were closed over the armature bars. These motors start with a powerful torque, approximately two or three times the torque at rated full load, when the full line voltage is thrown upon the primary, but of course take, under these conditions, a very heavy current, so that in practice it is usual to start them at reduced voltage, which gives all the torque

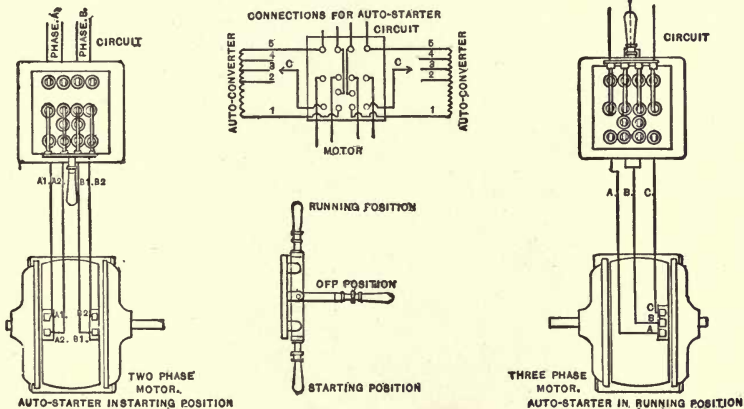

FIG. 143.

necessary without calling for excessive current. This is accomplished by means of a so-called auto-converter, of which the essential connections are shown in Fig. 143. With the switch in the starting position the applied voltage is only a quarter or a half the normal voltage, the actual amount being adjusted by means of the variable connections shown, and when the motor has come up to its full speed under the starting conditions the switch is suddenly thrown over, putting the full working voltage in circuit. The actual appearance of the latest form of auto-starter is shown in Fig. 144. The starting voltage is applied in several steps and the whole device is immersed in oil. It is necessary to let the motor reach its full

speed with the lower voltage before making this change, else there will be a needlessly severe current due to the sudden acceleration under full voltage, and the change should be made quickly, lest the armature speed should fall off during the change and produce the same unpleasant result. When intelligently handled the starting current can be kept within very reasonable limits, but the auto-converter should be adjusted when set up to give at starting merely the voltage needed to start under the required torque, an excess of voltage meaning excess of current. Fig. 2 of Plate VII is a General

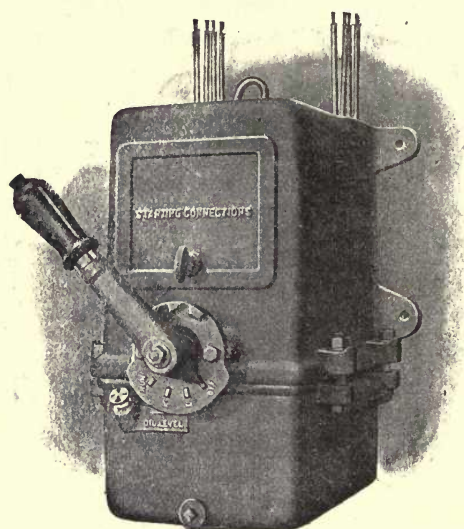

FIG. 144.

Electric "Type L" motor of 35 HP. The mechanical design is very simple, giving a light and well ventilated structure. The bearings can be shifted to compensate for wear. The winding of the armature is a regular three-phase bar winding furnished with starting resistances within the spider, which are cut out gradually by means of a ring moved by the lever seen just within the bearing spider. The starting resistances are in many sections and can be short-circuited very gradually, holding the primary current practically constant from start to full speed, even when starting under a heavy torque. The

start is made with the lever pulled out to its fullest extent, and it is gradually pushed home until full speed is reached. Such motors are peculiarly well adapted for use on lighting circuits, and in large sizes requiring heavy starting torque. The start can be made with very moderate currents, and the torque per ampere is considerably greater than in any motor starting on reduced primary voltage, which is the compensation for the rather elaborate starting device. Neither of the

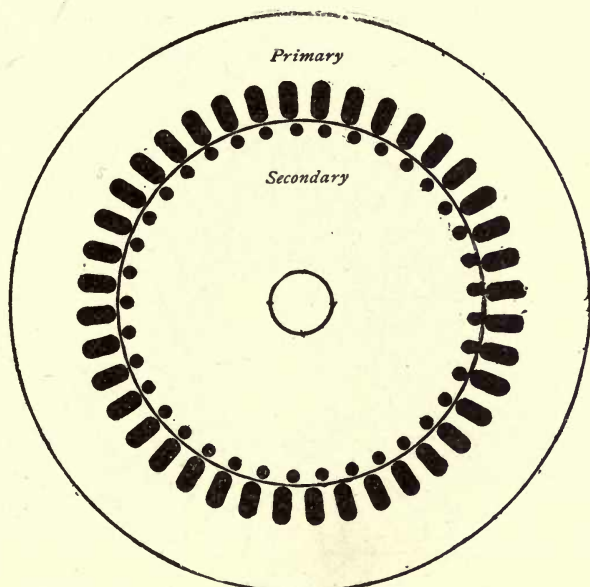

FIG. 145.

companies mentioned holds rigidly to the constructions here shown, but the cuts show their best standard practice. There is very little difference in the essential properties of the two forms, and both are very widely used.

These recent motors are nearly all made with extremely small clearance between armature and field, from $\frac{1}{8}$ to $\frac{1}{2}$ inch or less, even in large motors. This practice renders it easy to design for a good power factor, but may, and sometimes does, cause trouble mechanically, as might be anticipated. It is not difficult to make thoroughly good motors without resorting to

such extreme measures, unless the designer is hampered by troublesome specifications in other particulars. Demand for slow speed motors at a periodicity of 60~, and insistence on a uniformity of speed at various loads that would not for a moment be demanded in direct current motors, are responsible for serious and needless impediments in induction motor design.

The "Type L" motors just described have on the armature

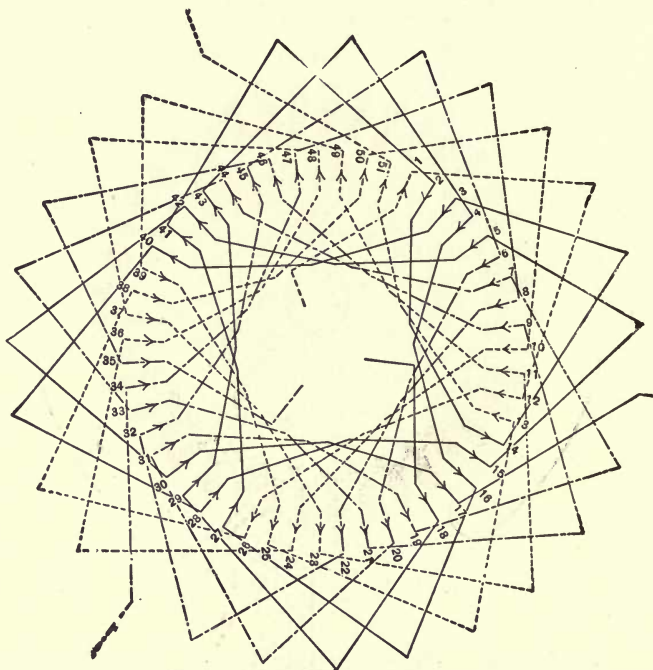

FIG. 146.

a regular three-phase winding of rectangular bars united by end connectors. A simple four-pole form of such a winding is shown in Fig. 146. It obviously is more troublesome to construct than a "squirrel cage" winding, but it possesses certain advantages. Conspicuously, it renders it possible to insert the resistance in the secondary circuit at starting, which in the "squirrel cage" would be a very difficult matter, although it has been tried.

If the field is very uniform, with a thoroughly distributed winding, there is very little difference in the actual performance of the two kinds of armatures (drum-wound and "squirrel cage") when at speed. In case of a motor with salient poles or with few winding slots in the field, the drum armature has a very considerable advantage, owing to the fact that the currents in it are directed into definite paths which they must follow at all times, while in the "squirrel cage" form the currents are only uniformly organized when there is a uniform field. In the early motors, therefore, the drum-wound arma-

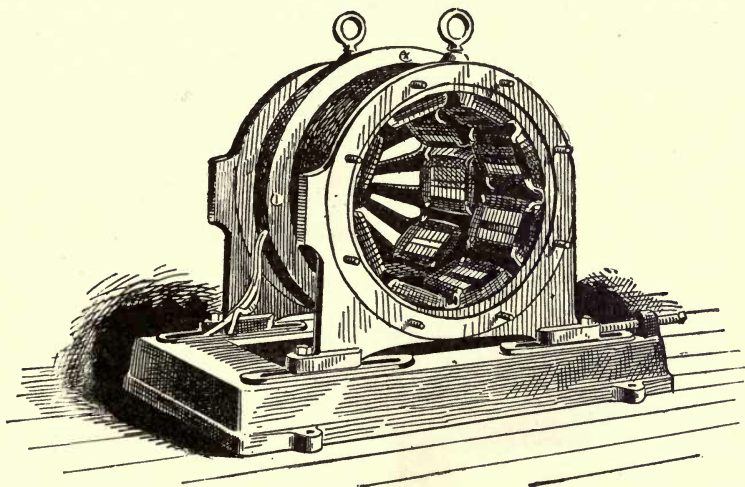

FIG. 147.

ture had a great advantage, but as the art of designing has advanced the two types have become closely approximated in their properties.

In this country the windings of induction motors are generally placed in open or nearly open slots, as in the case of the motors shown in Plate VII. Abroad the arrangement of windings in holes as shown in Fig. 145 is very common. Each procedure has its advantages. The American practice renders it very easy to place the windings, and to put a very large amount of copper upon the armature, for open slots can be made radially deep and filled true, while holes unless rather large can only be trued by reaming, which implies a round

hole, unfavorable if a great amount of copper is to be crowded upon the armature. Hence, with open slots it is easier to subdivide the winding into many slots, thus reducing the armature reactance. On the other hand, open slots are extremely unfavorable as regards power factor, since the iron surfaces opposed in armature and field are very greatly reduced, and hence the tendency to use extremely small clearances in order to make the best of a bad matter. The European practice is on the whole better as regards power factor, but does not facilitate the construction of motors of very low armature resistance, and is considerably more difficult of proper execution. The

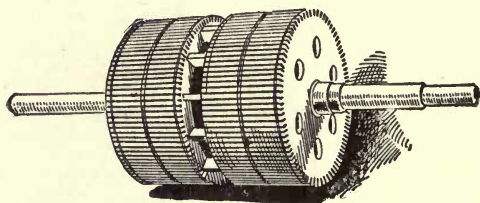

FIG. 148.

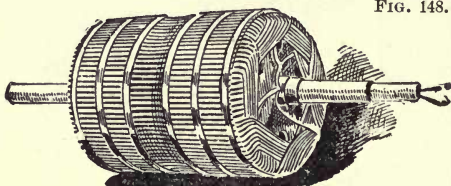

FIG. 149.

matter really hinges on the relative cost of labor here and abroad. With cheap labor the manufacturer can afford to go into little refinements if it is otherwise worth while, but at American labor-rates handwork has to be minimized. On the whole, the American motors are fully up to foreign standards in general design, although the tendency here has been to make a fetish of uniformity of speed, even at the expense of more important characteristics.

In motors such as those just described, with distributed windings and no sharply defined polar areas, the consecutive exchange of motor and transformer functions among the windings is almost lost sight of in the presence of the very apparent phenomenon of resultant revolving poles, but the appearance

of the latter is a necessary result of the persistence of the former. These induction motors are generally operated from the secondary circuits of transformers, although the large sizes (50 HP and upward) are sometimes wound for use of the full primary voltage up to 2,000 volts or more.

An early form of induction motor which possesses some interesting features is the Stanley machine, shown in Figs. 147, 148, 149. The field in Fig. 147 is composed of two separate rings of laminated iron, each having eight polar projections. These field rings are assembled side by side with the poles "staggered," as shown in the cut. Each field is energized separately, one from each branch of a two-phase circuit. The armature, Fig. 148, is composed of two separate cores assem-

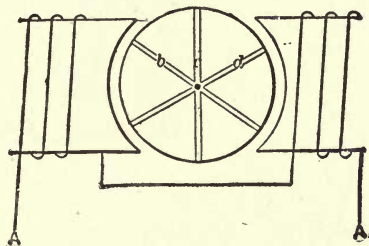

FIG. 150.

bled side by side. The secondary winding, Fig. 149, polyodontal as usual, is common to the two cores. The transformer and motor functions are here separated, for each half of the machine acts alternately as transformer and motor, each set of fields inducing current which serves for motor purposes in the other half of the machine. There is no rotary field in the ordinary sense of that term, since there is no physical resultant of the two field magnetizations, nothing but the alternation of transformer and motor functions that is a characteristic of all polyphase induction motors. These motors, now seldom seen, have been generally used in connection with condensers to improve the power factor, and to facilitate this practice have been usually wound for 500 volts.

A step further in the direction of simplicity, but generally inferior to both polyphase and heterophase forms, are the true monophase induction motors. The principle of these motors is

shown in Fig. 150. Here there is but one set of poles energized by the circuit *A*, while *b*, *c*, *d*, are portions of the armature winding, which may be a simple squirrel cage, or a complex bar winding similar to those used in polyphase motors.

If *A* be supplied with an alternating current, induced currents will be produced in the armature, out of phase with the field magnetization and symmetrical with respect to it, so that no torque is produced.

If, however, we spin the armature up to nearly synchronous speed, the armature currents will lag, from self-induction,

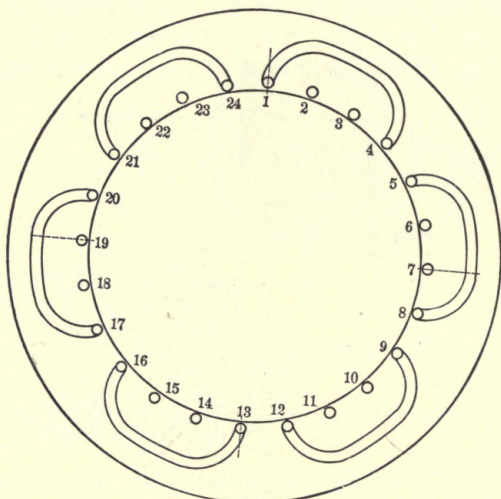

FIG. 151.

behind the E. M. F. set up by the field, so that they have an angular displacement with respect to the field at a time when the latter is still active. There is, therefore, torque between these two elements — *in the direction of the initial rotation*. The motor will thus run, when once started, equally well in either direction.

In every motor there must be not only a field magnetization and current in a movable conductor substantially in phase with each other, but there must be a stable angular displacement between the two in order to ensure continuous torque. In continuous current motors this displacement is secured by

the position of the brushes. In polyphase induction motors it is obtained by the space relation of the sets of poles combined with the time relation of the two or more currents.

In the monophase motor this angular displacement is due to the displacement of the armature currents by inductance. Hence, there is a particular value of the inductance corresponding to the best condition of torque, more or less than this being especially injurious in this type of motor.

In practice monophase induction motors are built in very

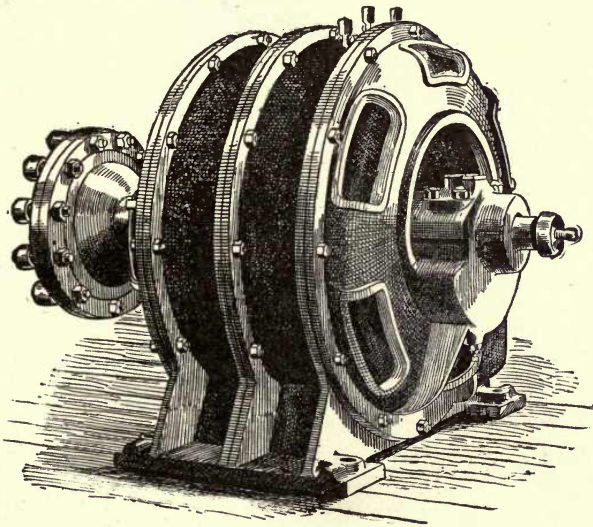

FIG. 152.

much the same form as polyphase motors, and for the same reason, *i.e.*, to make the structure good as a transformer. In fact, the same motor structures are often used for both types. Fig. 151 shows the manner of winding a six-pole monophase primary, homologous with Figs. 141, 142. A monophase induction motor of 120 HP by Brown, Boveri & Co., is shown in Fig. 152. Monophase induction motors are not yet used to any large extent in this country, and abroad their use is generally confined to motors much smaller than the example shown.

A moment's reflection will show that while the supply of

energy to a polyphase motor is substantially continuous, in monophase motors it is essentially intermittent, so that the latter give less output for the same structure, while the dependence of the torque on the armature inductance generally leads to low power factors.

Nevertheless, cases arise in which it is extremely convenient to use single phase motors. There are still many small light-

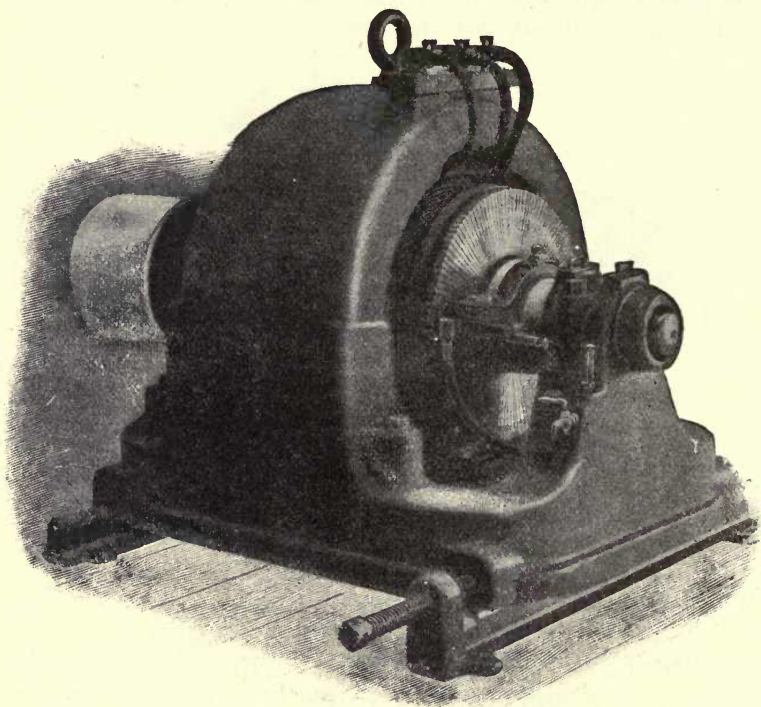

FIG. 153.

ing plants equipped only with single phase generators, the extreme simplicity of the circuits out-weighing the advantage of polyphase service in economy of copper and ready availability of motor service. For the occasional motors desirable on such systems some form of monophase machine is important. There are also some large lighting plants that serve their territory both by continuous current and in the

remoter districts by alternating current for which such motors are useful, and even on polyphase systems there are isolated demands for motors which can best be filled by a circuit run from a single phase.

Monophase motors are, too, rather more cheaply installed on account of the simpler circuits and lower cost of transformers, so that there is a genuine though at present rather limited demand for them. As a result there have been determined and measurably successful efforts to produce practical monophase motors capable of use at least in small sizes, without the impairment of general regulation likely to come from low power factor and large current at starting. Abroad the ordinary monophase type just described is used, generally

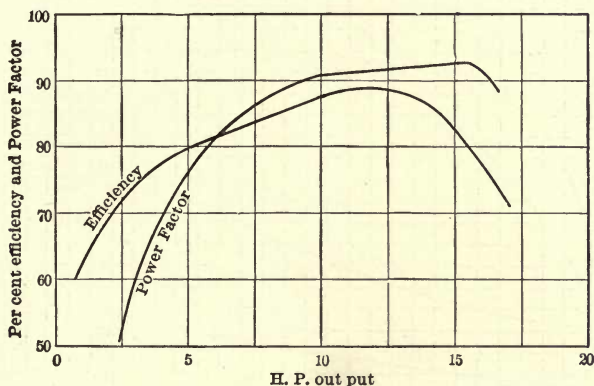

FIG. 154.

started light and taking up its load with a clutch, but here a self-starting motor is universally demanded.

One of the recent American contributions to the list of monophase motors is somewhat out of the ordinary in that it starts as an induction motor by the aid of a commutator. This is the Wagner motor shown in Fig. 153. In its general construction it is a pure monophase motor with an armature winding the coils of which are at one end connected with a commutator. This has bearing on it a pair of brushes which close upon themselves those armature coils which are in such angular relation with the field magnetization as to give a strong motor reaction with it. By thus keeping in action

only coils giving an efficient torque in one direction, the necessary directed torque at starting is secured, and when the motor reaches a predetermined speed a compact little centrifugal governor throws over a short-circuiting ring, converting the motor into an ordinary monophase induction motor. It is possible to start under load with this device by drawing rather heavily on the mains for current, but in any except the smallest sizes it is better to start light.

Fig. 155 shows the characteristic curves of a recent 4 HP Wagner motor, which gave a highly creditable performance for a monophase motor of so small size. It comes much nearer

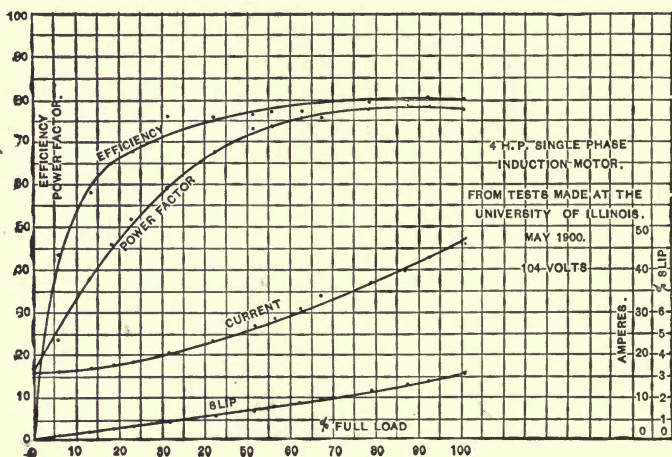

FIG. 155.

representing real commercial conditions than the curves of Fig. 154, and, as we shall presently see, does not make a bad showing as compared with the polyphase motors ordinarily found upon the market.

Although monophase motors as a class start at a great disadvantage compared with polyphase motors, they can be made to give pretty good results at load by extraordinary care in designing. Fig. 154 shows the curves obtained from a certain Brown motor by Professor Arno. The motor was nominally of 15 HP, but was evidently overrated at that load. Nevertheless, within a certain range of load the performance of this

Law of
California

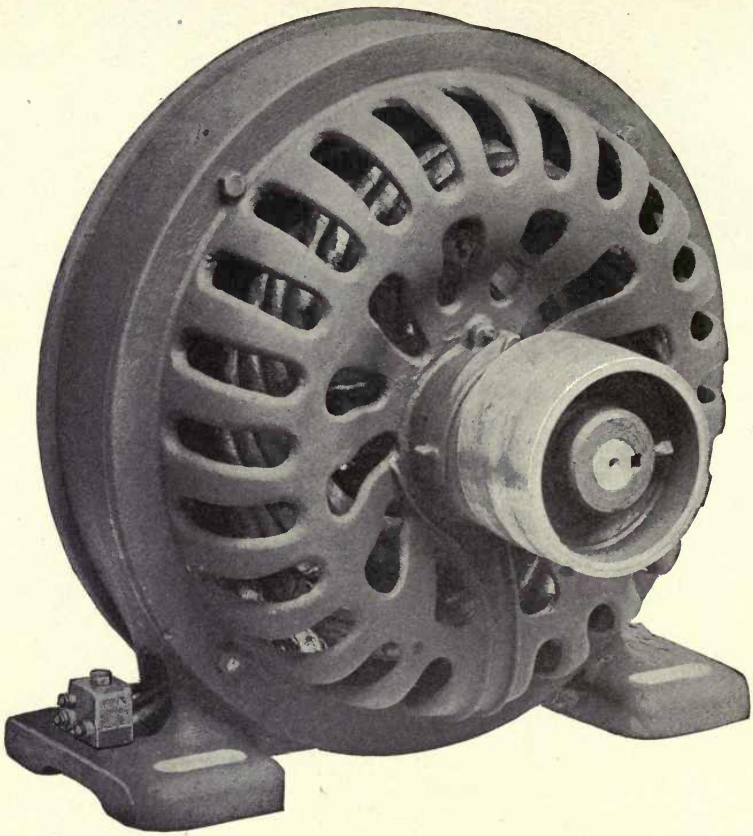

FIG. 1.

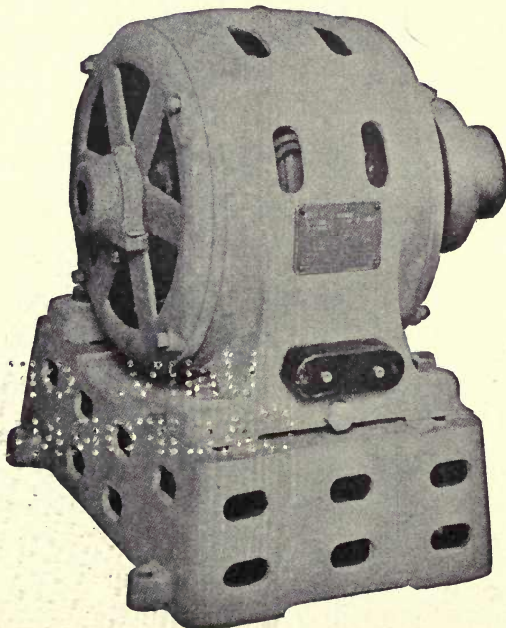

FIG. 2.

motor compares well with that of the best polyphase motors of similar size. This motor had an extremely small air gap, and shows doubtless a record performance in several respects, but it proves that barring the matter of starting it would be possible to turn out a pretty useful machine of the monophase type if anybody desired it, although it is certain that at anything like equal cost of construction the polyphase motor must retain the advantage. Fig. 1, Plate VIII, shows a recent monophase motor of Westinghouse make. It is in appearance hardly distinguishable from the polyphase motors, and its operative qualities are said to be excellent. Speed regulation, never any too easy in induction motors, is almost out of the question in the monophase form. Still, within its limitations it has its uses.

A very ingenious flank movement was made by the General Electric Co., upon the monophase problem in a monophase induction motor with condensers. In polyphase motors the usefulness of condensers had been shown by the Stanley type previously mentioned, and the same device seems specially useful in overcoming the low power factor to which the monophase form is especially prone. Plate VIII, Fig. 2, shows the 2 HP monophase motor of this type, mounted upon a base which contains the condenser. Its weight is 295 lbs., its nominal speed 1,800 r.p.m. at 60~ and its slip at full load 2.75 per cent. Its full load efficiency is 75 per cent. and power factor 92 per cent. The condenser is hermetically sealed in a tin case and is connected not as a shunt to the whole field, but is closed upon an independent phase winding, so that the motor belongs rather to the split-phase class than to the strictly monophase. The armature likewise is given a winding akin to that of the ordinary polyphase motors and is provided with a starting resistance, in series with the armature windings at starting and cut out automatically as the armature nears speed, by a centrifugal switch. An automatic clutch pulley is also provided on these motors to further facilitate starting with moderate current.

As might be expected from these features the motor is singularly free from starting and power factor difficulties, and, at the cost of some complication to be sure, meets the end for larly free from starting and power factor difficulties. The cost and complication of the condensers has seemingly proved com-

mercially disadvantageous, so that this very interesting machine appears in use very seldom, and is apparently unlikely to retain a place in the art.

Fig. 156 shows the characteristic curves from a 5 HP motor of this class. It will be observed that the full load power factor is .95 and the real efficiency at the same point .80, which is certainly an excellent showing. Obviously the power factor is a matter of proportioning the condensers, and in motors of this class of 10 HP, and upwards the power factor is raised to unity, or the current is even made to lead at certain loads.

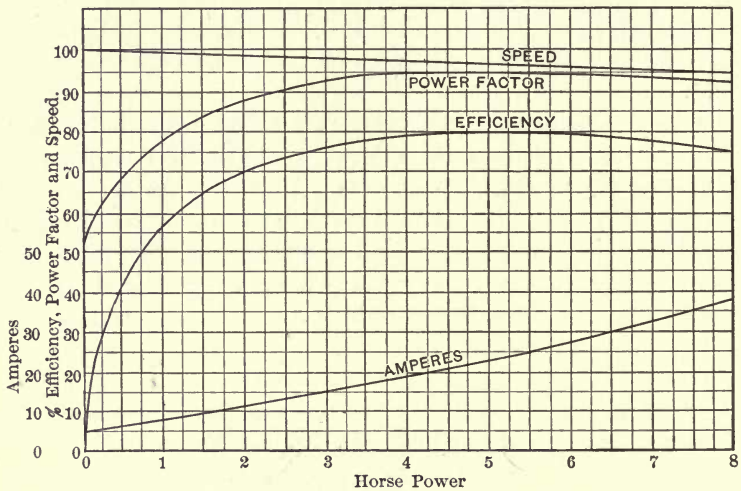

FIG. 156.

The various recent forms of monophasic motor have come into somewhat considerable, though scattered use, mostly in sizes below 10 HP, although now and then motors of several times this power have been installed. When judiciously installed they can undoubtedly be made to give good service.

There has also very recently been introduced a most interesting type of single phase alternating current motor derived from and closely resembling in its properties the ordinary direct current series motor. It is in fact a series motor specialized for alternating current working.

The direction of rotation of a series motor depends entirely

on the direction of the magnetizations produced by the field and armature respectively. Consequently it does not change if the direction of the current be reversed at the motor terminals, but only if it be reversed as between field and armature. Hence, such a motor would run even if supplied at its terminals with alternating current, provided enough such current could be forced through in spite of the high inductance of the machine. The first step toward this end would evidently be to reduce the frequency, but evidently even at low frequency the losses from eddy currents in the solid iron would be serious, and the next obvious step is to construct the field as well as the armature of iron laminated like a transformer core. In fact it has been known for a long time that a series-wound motor with a laminated field would operate after a fashion when fed with low frequency alternating currents, say at 8 or 10 periods per second. The recent work has been in the direction of so specializing this machine as to keep down the inductance and to reduce the sparking to reasonable limits when operating at the lower commercial frequencies.

The chief electrical feature of the a.c. series motor is that its total counter E. M. F. is the geometrical sum of the E. M. F.'s induced by the motion of the armature conductors and those due to reactance in the armature and field respectively. Now the apparent watts supplied are measured by the product $C E_0$, where E_0 is the impressed E. M. F. while the useful energy is determined by E , the motor E. M. F. as in any other motor. Hence, in order that an a.c. series motor should have a good power factor and apparent efficiency, it is necessary to make E large compared with the reactances of armature and field. To do this the number and the speed of the armature wires may be increased on the one hand and the reactances kept down upon the other. The first condition points to a motor having a relatively simple field and a very powerful high speed armature, while the second condition calls for low frequency and very careful designing against reactance.

To reduce the field reactance the turns on the field must be kept low, since one cannot reduce the effective field magnetization without reducing that in the armature also, and to maintain the field with few turns, requires a small air gap of

large area. Since one cannot reduce the air gap beyond a certain point without mechanical difficulties, and cannot increase its area much without increasing the general dimensions of the motor, the saving of reactance in the field is necessarily rather limited.

One can, however, considerably reduce the armature reactance by winding a neutralizing coil so as to surround the revolving armature in a plane approximately perpendicular to the line joining the brushes. This is known as a compensating coil and the motor fitted with it as a compensated series motor. Fig. 157 shows this arrangement in diagram. The result is to very greatly diminish the net armature reactance

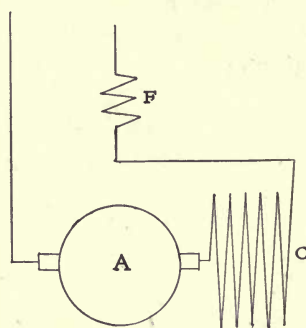

FIG. 157.

so that the power factor may be carried to .90 or even more. Here *A* is the armature, *F* the field, and *C* the compensating coil.

The recently introduced single-phase motors for electric traction generally belong to this type, and in certain cases these machines may be useful for variable speed work on commercial circuits, for they behave under supply at varied voltage quite like d.c. series motors

and indeed can be worked on d.c. circuits. Fig. 158 shows a Westinghouse single-phase railway motor with the armature removed, showing the field coils and the compensating coils.

A modification of the same idea is shown in Fig. 159, where the compensating coil is short circuited, the motor being otherwise arranged as before. Still another commutating type of a.c. motor is that shown diagrammatically in Fig. 160 in which there are field and compensating coils in series, but the armature is short circuited upon itself. This is substantially like Prof. Elihu Thomson's repulsion motor in the original form of which, however, the coils *F* and *C* were replaced by a small resultant coil in an intermediate position with respect to the brush line. This motor too has been developed for railway work, and has much the same properties as the regular series compensated type.

All these alternating motors have good power factors when working near their normal speeds, often rising to .90 and

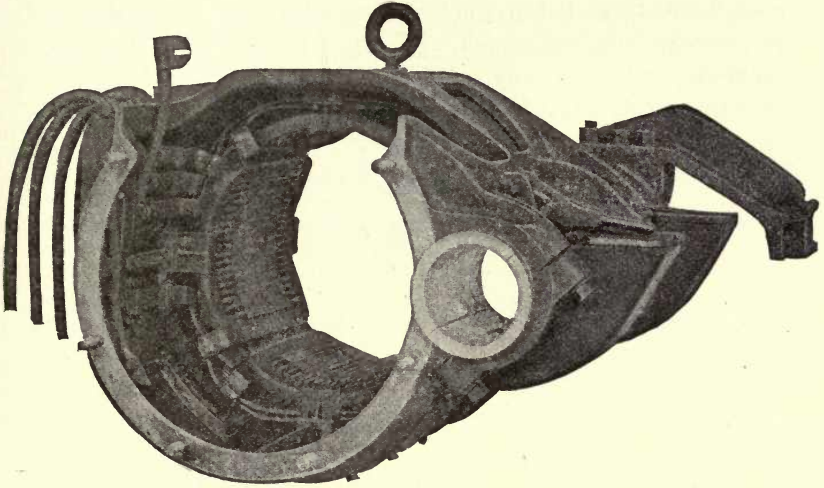

FIG. 158.

more, but their efficiency is generally materially less than that of d.c. motors, or polyphase induction motors of similar output. The losses from the more complex windings, from eddy

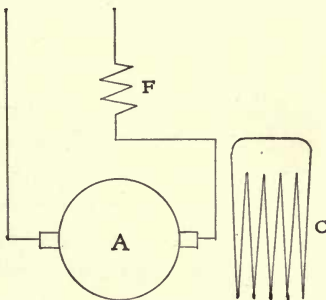

FIG. 159.

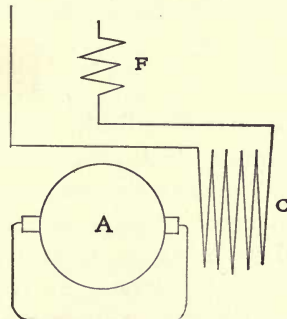

FIG. 160.

currents and from hysteresis are enough to cut down efficiency generally 5 to 10 per cent, more often near the latter figure.

By careful design of the commutation sparking can be kept within reasonable bounds, at least within a moderate range

of speed, although the conditions for sparkless operations can never be as favorable as in d.c. motors.

Several other modifications of the commutating a.c. motor have been devised, but they all depend on principles similar to those already mentioned, and may be expected to perform in about the same way. None of them can reasonably be expected to do materially better than the series compensated

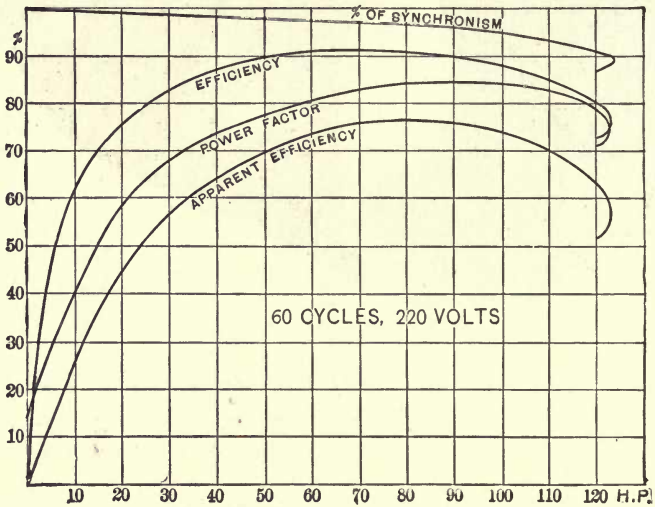

FIG. 161.

type first described. They are one and all intended for low frequency work generally 25 ~ as a maximum. The higher the frequency the harder to build a good commutating motor. Hence, whatever place such motors may find in traction, they will probably be of rather limited applicability on ordinary commercial circuits of the present usual frequency of 60~, although they may be occasionally useful.

The practical properties of good modern induction motors are strikingly similar to those of shunt-wound or separately excited continuous current motors.

For the same output, the induction motor generally has the advantage in weight, owing to the fine quality of iron which has

to be employed, but its laminated structure and rather complicated primary winding make it fully as expensive to build, in spite of the absence of a commutator.

In point of commercial efficiency there is but little difference. It is not difficult to build an induction motor which is fully up to the average efficiency of other motors of similar output and speed. And what is of greater importance, the question of sparking being eliminated, the point of maximum efficiency can quite easily be brought somewhere near the aver-

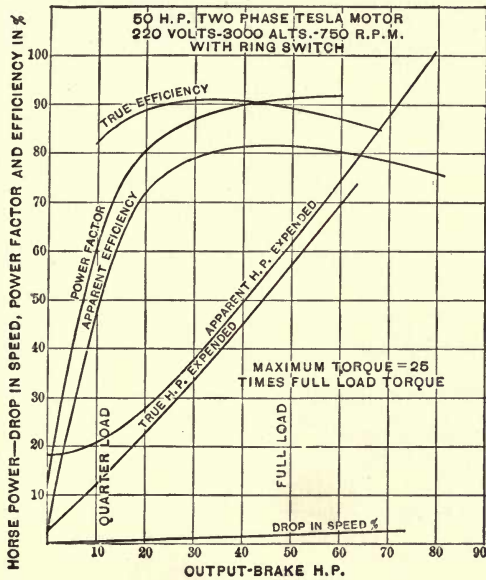

FIG. 162.

age load. It must be remembered that here, as elsewhere, the last few per cent of efficiency are somewhat costly, and not always found in the rank and file of commercial machines.

The weak point of commercial induction motors is apt to be the power factor. Of course low power factor means demand for current quite out of proportion to the output, and hence greater loss in the lines and greater station capacity. In addition, a heavy lagging current makes regulation of voltage on the system anything but easy.

CIVIL ENGINEER
U. of C.
ASSOCIATION L.

Now, it is perfectly feasible to build induction motors with power factors so high as to avoid these practical difficulties almost entirely. But this result is somewhat expensive, whether reached by *finesse* in design, or by the addition of condensers, and it is therefore not always attained.

Slow speed induction motors, large and small, are subject to bad power factors, and so in fact are all induction motors having many poles. The best results, however, are very good indeed. A power factor of .9 or thereabouts at normal load

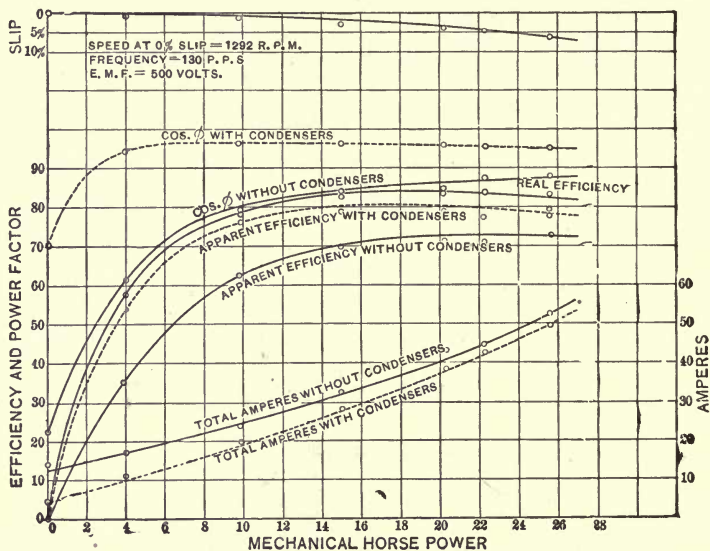

FIG. 163.

is quite unobjectionable in practice, and this figure can be reached or closely approximated by careful design.

In point of efficiency there is little difficulty in reaching satisfactory figures. The actual properties of polyphase induction motors can be best appreciated by the examination of their characteristic curves, showing the variations of efficiency, power factor, and speed under varying loads. Fig. 161 shows these curves for a 75 HP three-phase motor built by the General Electric Company. It is a 60~ motor, intended for severe service, and hence is arranged to carry considerable overload at a

good efficiency. The fall in speed from no load to full load is but 3 per cent, and the starting torque is 80 per cent greater than full running torque, with an expenditure of current closely proportional to the torque. The commercial efficiency reaches 91.1 per cent, and the power factor 84.3 per cent, which is not bad for so large a motor intended for considerable overloads.

Fig. 162 shows the characteristics of a Westinghouse two-phase induction motor of 50 HP for 25~. Its properties, as might be expected of a well-designed motor for so low a fre-

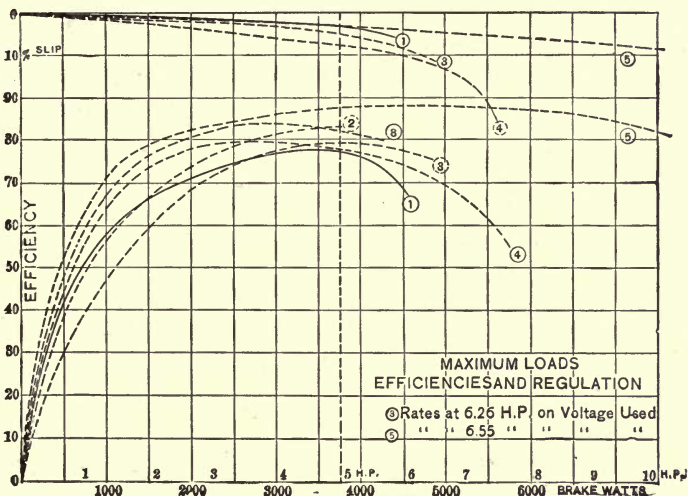

FIG. 164.

quency, are admirable, particularly the great efficiency at small loads.

Fig. 163 shows the properties of a polyphase motor of 20 HP at 130~, used with Stanley condensers to keep down the results of the inductance encountered at so high a frequency. The effect of this device, particularly at moderate loads, is very striking indeed. Without condensers one could not obtain such a power factor even at full load. While the condenser does not perfectly compensate for inductance, it does so sufficiently well for all practical purposes. In other properties the motor is not so especially remarkable.

These curves are from the manufacturers' tests, and the

author believes them to be entirely trustworthy, although they probably represent good results. Better curves than these are occasionally obtained, generally for some individual reason. Now and then a "freak" motor is produced, with enormously high efficiency or power factor, like a certain 5 HP three-phase motor designed and tested by the author, which gave at full load a power factor of .94.

On the other hand, it is unfortunately true that many commercial induction motors are not as good in point of efficiency and power factor as they ought to be. A series of tests of induction motors under the direction of Professor D. C. Jackson was published a few years since, which gives data so instructive and impartial as to be well worth reproduction here. The motors tested were, except for a 10 HP Westinghouse two-phase, all of 5 HP nominal capacity, and by the following makers: Westinghouse, Fort Wayne Electric Corporation (synchronous self-starting monophase), Stanley, Allgemeines Electricitäts Gesellschaft, General Electric Company. In addition, results of tests on Oerlikon and Brown motors are included in the results. Fig. 164 shows the efficiency curves and regulation of the several machines, and the table gives a general view of their respective properties.

COMPARATIVE QUALITIES OF INDUCTION MOTORS.

Number.	Rated Capacity, HP.		Torque, in Per Cent of Full Load.			Starting Current in Per Cent of Full Load.		Efficiencies, Per Cent.				Power Factors, Per Cent.						
	Rated Capacity, HP.	Rating at Voltage Used, HP.	Max. Running.	Static.	Starting.	Starting Current in Per Cent of Full Load.	Drop in Speed at Full Load, Per Cent.	Max. Eff.	$\frac{1}{2}$ Load.	$\frac{2}{3}$ Load.	$\frac{3}{4}$ Load.	Full Load.	Max. P. F.	0 Load.	$\frac{1}{2}$ Load.	$\frac{2}{3}$ Load.	$\frac{3}{4}$ Load.	Full Load.
1	5	5	140	131	77	157	3	77.8	55.2	70.6	77	76.6	76.4	13				
2	5	5	100	45	44	153		83.8	54.5	72.5	80.5	83.8	67.5	10.5	37.5	50	62.3	71.5
3	5	6.26	104	90	83	114	9.7	79	52	71.9	78.9	77	84	74	51.6	58	67.3	84
4	5	5	186.5	136	39.4	262		79.5	62.2	77.2	79.5	77.8	82.6	15.5	44.7	62.5	73.7	80.3
5	5	6.55	171	138.5	86.6	156	3.7	88	75.2	85	87.7	88	78.5	6.8	27.5	45.5	59.8	70.3
6	10	10	147	142	137	194	4.5	82	67	78.4	81.9	81.1	80.5	15	40.4	59.1	69	73.4
7	4.5	4.5	163	232		357	3.7	79.1	61	73.8	78.4	79.1	88.4	22.2	51.3	69.4	80.3	85.2
8	5	5					4.6	83.8	65.5	80.2	83.8	82	89		52	71.5	81.7	87.2

NOTE.—6, 7, and 8 were not run up to maximum load, on test.

Looking over these results, Nos. 3, 5, and 8 are decidedly the best of the lot. Of these, No. 3 is possessed of a fairly high and very uniform power factor, but rather moderate efficiency. It starts well, and with a moderate current has sufficient margin of capacity for all ordinary work, but its speed falls considerably under load. No. 5 has extraordinary efficiency at all loads, starts admirably, and can carry a tremendous overload — more than double its rated capacity. Moreover, it regulates very closely. The power factor, however, is so bad as to be a curiosity, having apparently been sacrificed to obtain great maximum output, which is for many purposes useless. No. 8 is a far better all-round machine than any of the others, has a good maximum efficiency at a little below full load, and an excellent power factor. Professor Jackson notes that since, at an output of $3\frac{1}{2}$ HP, No. 3 has an efficiency of 75.5, and a power factor of $83\frac{1}{2}$, while No. 5 shows respectively 85 and 59, the station capacity for the latter must be considerably greater than for the former. That is, the apparent efficiency of No. 3, which determines the necessary station capacity, is 64 per cent, while that of No. 5 is 50 per cent. Hence, to supply one brake HP with No. 5 motors, there must be a station capacity of 2 HP, while with No. 3 motors 1.56 HP is sufficient. But with No. 8 the efficiency is about .83, and the power factor about .80, giving an apparent efficiency of .66, which is better than either No. 3 or No. 5. Motors like No. 3 are excellent for the power station, but hard on the customer, while No. 5 is admirable for the customer, but bad for the station. No. 8 is fair to both parties.

Most of the motors shown start quite well enough for ordinary purposes. Neither heavy starting torque nor ability to carry large overloads is needed in ordinary motor work. Large torque per ampere is, however, desirable. It is best secured by using at starting a non-inductive resistance in the secondary circuit as found in many existing motors. The actual effect of this resistance is as follows: It reduces the current drawn from the mains so that the motor will not seriously disturb the voltage on the lines at starting; by diminishing the current flowing in the armature it limits the armature reaction so that it may not beat back the field so as to

interfere with proper starting, nor distort it so as to produce dead points; and, finally, it largely increases the torque per ampere, which greatly aids in starting under load.

The function first mentioned is very important where lights and motors are to be operated, since if a motor is capable of starting under heavy load it is likely to take at starting a pretty large current, which may pull down the voltage in the neighborhood merely in virtue of ohmic drop. Besides, the power factor of an induction motor at starting is only about .7, so that the heavy current lags severely and still further interferes with proper regulation.

The heavy lagging current set up in the armature is likely to distort the field seriously, sometimes so much as to block the starting of the motor, sometimes merely producing dead points, *i.e.*, points of no torque, or greatly weakening the torque in certain positions of the armature. The introduction of resistance in the secondary circuit both diminishes the current and its angle of lag, and thus keeps down the armature reaction. In some motors the reluctance of the magnetic circuits is sensibly the same in all angular positions of the armature, so that there are no points of noticeably weak torque either with or without a starting resistance. But some motors otherwise excellent have sufficient variations of reluctance to produce bad dead points when the armature reactance is severe, while these nearly or quite disappear by adding resistance in the secondary circuits.

The use of resistance in the secondary at starting obviously throws forward the phase of the secondary current so that it is in better relation to the field magnetization, and hence although the numerical value of the current is reduced, its effective component is increased. The considerations which affect the relations between torque and current in the armatures of induction motors are in reality quite simple. The absolute value of the current, other things being equal, is determined by the armature impedance, and is the same for the same impedance whatever the relation between the reactance and resistance components of that impedance. The ratio between these components, however, determines the phase angle of the armature current, so that for a given value

of the current the torque depends on the ratio between resistance and reactance in the armature.

By lessening either the resistance or reactance of the armature a motor is obtained in which a very large current flows at starting, but reducing the impedance by cutting down reactance gives the resulting current a better phase angle than that obtained by reducing resistance alone. For a given motor the maximum torque is obtained when the ratio of resistance and reactance is unity, *i.e.*, when

$$I = R.$$

Now, one can cut down the resistance by increasing the allowance of armature copper, and can diminish the reactance by subdividing the winding so that there shall be many slots in the armature, and the minimum possible number of turns per slot. Also the better the mutual induction between field and armature the less the reactance of either member is likely to be, so that by close attention to design it is possible greatly to reduce the armature reactance. In commercial motors the relation between resistance and reactance in the armature is generally from

$$I = 3 R \text{ to } I = 10 R.$$

Hence, when large torque per ampere is desired the simplest thing to do is to insert non-inductive resistance in the secondary, and when

$$I = R$$

the given motor will be at its best with respect to starting torque. With

$$I = R$$

the maximum torque will be obtained when both are as small as possible. Hence, if very great starting torque is desired, the motor should be designed with very low armature resistance and reactance.

The slip of the motor below synchronous speed depends upon the armature resistance in induction motors, just as in continuous current motors the slip below the speed at which the armature would give the impressed E. M. F. is determined

by armature resistance. In each case the slip measures the percentage of energy lost in the armature, so that if an induction motor, for example, runs loaded at 5 per cent slip the loss of efficiency in the armature is 5 per cent.

Commercial induction motors vary widely in slip — from as little as 1 per cent to 8 or 10 per cent, according to design. It must not for a moment be supposed, however, that small slip implies high efficiency of the motor. One can put, in designing a motor, most of the loss into the armature or into the field, as one pleases, and it is pretty safe to say that if there is remarkably little in the armature there will be an unusual amount in the field, unless cost is utterly disregarded. Probably the best all-around results can be obtained by dividing the permissible loss nearly equally between armature and field.

There is a very simple relation between the static and running torques of an induction motor, the static and running currents, and the slip, as follows:

$$\frac{T}{T_s} = S \frac{C^2}{C_s^2}.$$

In this equation T_s is the static torque, C_s the static current, T and C torque and current of the slip S , and S that slip expressed as a percentage. As an example of the application of this formula, suppose the full load current of a certain motor is 60 amperes per phase, the current with the armature at rest 400 amperes, and the slip at full load is 5 per cent. Then

$$\frac{T}{T_s} = .05 \times \frac{160,000}{3600} = 2.22,$$

i.e., the static torque will be 2.22 times the full load running torque. Of course, if a motor is to have a powerful starting torque it must take a pretty heavy current, but the extra resistance at starting helps very materially in keeping the current within bounds. An adjustable secondary resistance makes it easy to bring to speed any load that the motor will carry continuously, without demanding excessive current.

As to overload, an ability to carry 25 per cent more than

the rated capacity is ample, save in rare cases, and greater margin than this usually means some sacrifice in efficiency or power factor at normal loads. For most work an efficiency curve like that of No. 8 is preferable to one like that of No. 5. When great margin of capacity is needed, it is best to use a motor deliberately adjusted to such use, and not to expect it of a motor properly designed for ordinary service.

The speed of induction motors is best regulated by inserting

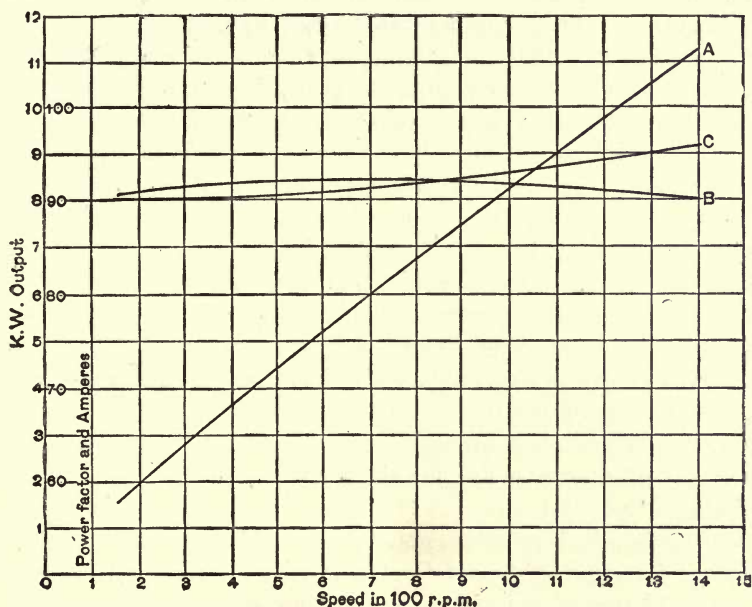

FIG. 165.

a non-inductive resistance in the secondary circuit. Under these circumstances the motor can be made to run at constant torque over a very wide range of speeds by varying the resistance, just as one would regulate a street-car motor. Fig. 165 shows the variation in speed, current, and power factor in a 15 HP three-phase motor fitted with rheostatic control. The speed was varied at constant torque from about 1,400 r. p. m. down to 150 r. p. m. Curve B shows the variation of the power factor, in this case high at all speeds, and curve

C shows the slight variation in input. Operated in this way, the motor behaved almost exactly like a series-wound direct current motor with rheostatic control. Such a rheostat is used in operating hoists and the like with induction motors. Regulation by varying the primary voltage is highly unsatisfactory, since the torque falls off nearly in proportion to the square of the voltage, so that at low speeds the output is enormously reduced. Regulation by any method involving resistance is of course inefficient, not materially more so, however, than in the case of continuous current motors. It should be understood that all these remarks concerning torque, regulation, and the like apply to polyphase induction motors and do not hold true in general of monophase motors.

The weak point of induction motor practice is in the heavy inductance likely to be encountered unless motors with first-class power factors are used. It is depressing to find the current capacity of your generator exhausted long before it has reached its rated output in kilowatts, and if the motor service is part of a general system, the effect of a bad power factor on regulation is disastrous.

With generators of moderate inductance and good motors, general distribution by polyphase currents gives admirable results. The station manager should see to it that his motors are not of excessive size for their work, and are good in the matter of power factor. A few motors for very variable loads can be handled readily enough, but no motor with a bad power factor should be tolerated simply because it is cheap. Power factors of at least .85 at full load, and .80 at two-thirds load, are quite obtainable except in case of some special motors, and should be insisted upon rigorously.

One polyphase station operating more than fifty induction motors showed, when tested by the author, about .65 as average power factor when carrying all the motors. Rigorous inspection of the motors installed would have raised this figure to .75, although the existing power factor actually gave no trouble, there being ample generator capacity.

So much for polyphase induction motors. Monophase motors generally fail to give so uniformly good results. Occasional extraordinary results have been reported from the

latter, but in the author's opinion they concern motors which belong to the "freak" class alluded to, and cannot be expected in commercial practice. Monophase motors are usually weak in power factor save at certain loads, and start badly, most of those in use abroad being started without load. Even so, the starting current is large, as may be safely concluded from the discreet silence preserved on this topic in all descriptions of monophase motor installations. In general power transmission work the incandescent lamp and the induction motor are the chief factors. Synchronous motors are valuable in their proper place, and arc lighting and continuous current work are sometimes relatively important. The alternating current systems are now far enough developed to be entirely workable and trustworthy for incandescents and motors. The alternating arc lamp is, however, not quite in condition to replace the continuous current arcs for all purposes and under all circumstances, and for work specially suited to continuous currents reliance has at present to be placed in various current reorganizing devices, which are, so far, of rather indeterminate ultimate value. Whether they are to have a large permanent place in the art, or whether their sphere will gradually be much contracted, is uncertain. At all events it is sufficiently clear that the main body of power transmission will have to depend on alternating currents, at least for a long while to come.

Even if continuous current should be obtained somewhat directly from coal in the near or far future, the result would be not to increase power transmission by continuous currents, but to render the transportation of coal by far the cheapest method of transmitting energy.

The relative importance of polyphase, heterophase, and monophase systems is a question often raised. The present indications are that the polyphase systems, in virtue of increased output of generators, possible economy in copper and general convenience, have come to stay. The monophase motor problem has not yet been satisfactorily solved in any general way, and until it has been solved, the monophase system must remain subordinate, like the heterophase systems, which are special rather than general in their applicability.

The much mooted question of frequency will be referred to in its different bearings in connection with other topics. The frequencies once common, 120~ to 135~, are rapidly passing out of use for all important work. They are inconveniently high for long lines by reason of inductance, are troublesome for large units, lead to high inductance in the system, and have for their only compensating advantage, lessened cost of transformers. Both here and abroad lower frequencies have come into use. In this country 60~ seems to be the favorite frequency, except for work with rotary converters, when 25~ to 35~ is usual. Both these last are too low for general practice, since the cost of transformers is greatly increased; the former is unsuitable for incandescent service, unless with extremely low voltage lamps, and both are unsuitable for alternating arcs. It is now pretty generally recognized for the above reason, that the adoption of so low a frequency as 25~ in the great Niagara plant was an error of judgment, perhaps brought about by an overestimate of the importance of rotary converters in general distribution. The only apparatus which at present demands low frequency is the single-phase commutating motor. Should it come into great use plants of 25~ or less may be necessary, but for general distribution it is always preferable to keep the frequency high enough for incandescent lamps, which are the most profitable kind of load.

On the other hand, abroad a compromise frequency of 40~ to 50~ is in general use. In the author's opinion there are very few cases in which lower frequencies than these are desirable, and none in which less than 30~ should be tolerated for general distribution work; 50~ or 60~ meets general requirements admirably, and only in rare cases is the use of rotary converters of sufficiently commanding importance to call for a lower frequency.

In connection with this topic we may consider a verbose controversy which has raged of late, respecting the advantages of certain irregular forms of alternating current waves *vs.* a true sine wave. The facts in a nutshell are as follows: Certain complex current waves, whose irregularity is due to the presence of harmonics of higher frequency, have been found

to give slightly better efficiency in transformers than sine waves of the same nominal frequency. Such waves, however, do not hold their form under varying conditions of load, and by reason of their harmonics of higher frequency raise the inductance of the line and apparatus, increase the probability of resonance on the line, hamper all attempts to balance the inductance of the system by condensers or synchronous motors, and finally sometimes interfere with the proper performance of induction motors. The use of such wave forms, then, is likely to lead to very embarrassing complications in a power transmission system, and their sole advantage is far better secured by using a sine wave of slightly increased frequency, than by interpolating a set of worse than useless harmonics.

It is needless to say that all cases of power transmission cannot be treated alike — there is no system that will meet all conditions in the best possible manner. The best results will be obtained by treating, in the preliminary investigation, each problem as an unique and independent case of power transmission, and afterward boiling down the conclusions to meet practical conditions. Avoid, when you can, apparatus of peculiar sizes and speeds — remember that you are after results, not electrical curios. See to it that what is done is done thoroughly, and for general guiding principles keep your voltage up and your inductance down, and watch the line.

CHAPTER VII.

CURRENT REORGANIZERS.

WHATEVER method may be employed for the transmission of power in any given case, it will often be found that the current delivered at the receiving station is not of the character needed. Sometimes in transmissions for special purposes no difficulty will be met, but frequently, especially in the transmission of power for general distribution, both continuous and alternating currents are needed, whereas only one is at hand. For all electrolytic operations, for most railway work at present, for telegraphy, and sometimes for arc lighting, continuous current is necessary, while alternating current is necessary for convenient application to electric furnaces, electric welding, electro-cautery and other minor purposes. So whichever kind of current is transmitted the other must be derived from it for certain uses.

All devices for thus changing alternating to direct currents, or vice versa, with or without accompanying change of voltage, may properly be called *current reorganizers*.

Three classes of such apparatus have come into considerable use: 1. Commutators; 2. Motor dynamos; 3. Rotary converters. These classes are quite distinct from each other; each has advantages and faults peculiar to itself, and all three, especially the last named, are in every-day practical use to a greater extent than would seem probable at first thought.

We have already looked into the matter of commutation in Chapter I, and have seen how the naturally alternating currents in a continuous current dynamo are rectified and smoothed. Given, then, an alternating current received from a distant generator, and it would seem an easy matter to receive this current upon a commutator and deliver it as continuous current. In point of fact there are very serious difficulties in this apparently simple process.

The current received is a set of simple alternations shown

diagrammatically in Fig. 166. The figure shows three complete periods. Now, if such a current be sent into a simple two-part commutator, such as is shown in Fig. 9, Chapter I, revolving at such a speed that the brushes will be just passing from one segment to the other every time the current received changes direction, the result will be a rectified current, shown in Fig. 167, unidirectional, it is true, but far from continuous. Vari-

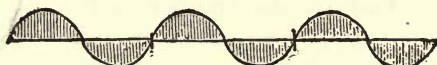

FIG. 166.

ous modifications of this simple rectifying apparatus have been and are in extensive use for supplying current to the field magnets of alternating generators. As these machines are generally multipolar, the two-part commutator has been modified so as to reverse the current at each alternation. Fig. 168 shows one of the simple forms of commutator arranged for self-exciting alternators. It consists of a pair of metal cylinders mounted on and insulated from the dynamo shaft. Each cylinder is cut away into teeth, and the two are mounted so that the teeth interlock with insulation between them. Each pair of consecutive teeth acts like the ordinary two-part commutator, and there are of course a pair of teeth for every pair of poles, so that the commutator acts at each alternation.

The resulting rectified current is then led around the field magnets of the generator, furnishing either the whole excitation, or enough to compound the machine. Such a current,



FIG. 167.

however, is so fluctuating that it is by no means the equivalent of an ordinary continuous current for magnetizing purposes, hence in most modern machines the main exciting current is furnished by a small exciting dynamo, driven from the alternator shaft or by separate means, while the rectified current is used only now and then for compounding.

This simple current reorganizer is very successful for the purpose described. But it must be remembered that the

amount of energy concerned is trifling, only a very few kilowatts being required to compound even the largest alternators. And despite this, there is often trouble from sparking, such commutators being notoriously hard to keep in good order.

In applying the same process to rectifying currents on a larger scale, the difficulties from sparking are very serious, in fact generally prohibitive. And the worst of it is that they are inherent. The root of the trouble is that the alternating current on a line used for general purposes cannot be kept accurately in step with the motion of the commutator. To ensure sparkless commutation the conditions must be as shown in Fig. 169.

The alternations of the current and E. M. F. are shown by the

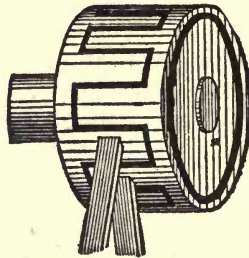

FIG. 168.

solid line, while the brushes at the moment of passing from one commutator segment to the next must take the position *b b*, with respect to the current. That is, they must pass from one segment to the next at the moment when the current, just reversing, is practically zero. So long as the electromotive force and the current are in phase with each other, as shown in the solid line, the current will be rectified without troublesome sparking. But when the current lags behind the E. M. F., as shown by the dotted line of Fig. 169, there is trouble at once. The brushes, as can be seen from the dotted prolongations of *b b*, must break a considerable current, and there is certain to be sparking. Nor can any point be found for the brushes at which they will not have either to break this current or to pass from one segment to the next while there is considerable E. M. F. between segments. The case is bad

enough in a compounding commutator having a position fixed with reference to the E. M. F. of the machine and dealing with low voltage and moderate current. The inevitable result is sparking that can be only mitigated by shifting the brushes, and more or less demoralization of the compounding. If the current be received from a distant generator on a commutator driven by a synchronous motor, the condition of things is much worse. When the current lags (or leads), not only are the brushes generally thrown out of step with it, but if there is a sudden change of phase the inertia of the commutating apparatus will put it at serious variance for the time with both current and E. M. F. Add to this the disturbances of phase produced by armature reaction in both generator and motor, and one has a set of conditions that renders sparking

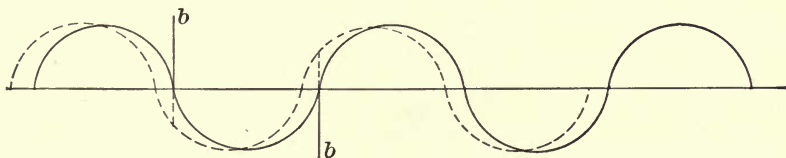

FIG. 169.

absolutely certain. The most that can be done to help matters is to employ palliative measures to delay the destruction of the commutator. Aside from this sparking, it is nearly out of the question to hold the voltage of the rectified current steady if the phase is shifting, as it often is likely to be.

Incidentally may be mentioned the fact that in working such a commutating apparatus, just as in rotary converters, the direction of the rectified current will be uncertain; the brush which happens to be on a positive segment when the brush circuit is closed, will stay positive, as can readily be seen by tracing out the rectifying process in Fig. 168. In ordinary compounding commutators this uncertainty is absent, for with the brushes in a fixed position the positive segments will always be under the same brush, since the segments are fixed with reference to the armature coils.

No small amount of time and money has been spent in trying to work out a successful synchronizing commutator. The main trouble is, of course, sparking, and the exasperating part

of the problem is that while on a small scale, as in compounding alternators, fair results can be obtained, the difficulties increase enormously with the output, so that every attempt on a scale really worthy of serious consideration has ended in discouragement and the scrap heap.

The great usefulness of such apparatus if of reasonably good qualities, has made this field of experimentation very interesting, and a vast amount of ingenuity has been expended in elaborately devised plans for reducing sparking and minimizing the evil results of shifting phase. An example of such work, of more than usual merit, was shown at the International Congress of 1893 at Chicago. This was the current reorganizer

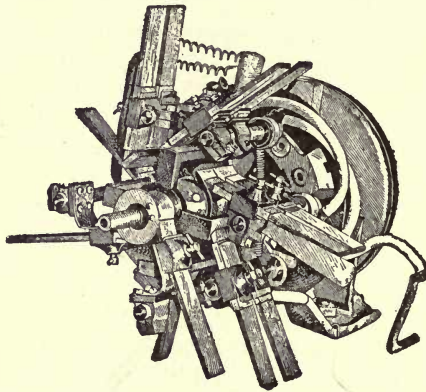

FIG. 170.

devised by C. Pollak, for use in connection with accumulator installations. It was intended specifically for charging accumulators, and is very ingeniously adapted to that use. Its general appearance is shown by Fig. 170. The apparatus consists of a small synchronous motor driving a commutator, which has, in the example shown, eight segments coupled alternately in parallel so as to produce the effect of Fig. 168. The Pollak commutator is, however, peculiar in that the spaces between segments are of nearly the same width as the segments themselves, while the collecting brushes are set in pairs, so that by setting one of each pair ahead of, or behind the other, the ratio of segment width to space width can be changed. In

charging accumulators the E. M. F. of the charging current must always, to prevent waste of energy, exceed the counter E. M. F. of the battery. Hence a current rectified as in Figs. 167 and 168 cannot successfully be used. The arrangement of segments just described enables the brushes to be so set that contact with a segment is made at the moment when the rising E. M. F. of the alternating side is exactly equal to the counter E. M. F. of the battery, and broken when the falling E. M. F. reaches the same value. Only that part of the current wave of which the E. M. F. exceeds the counter E. M. F. of the battery is used, the charging circuit being open during the remainder of the period. When well adjusted and used on a circuit nearly non-inductive, the machine in question is almost sparkless and very well adapted for the particular purpose intended. It is also highly efficient, the only losses being those in the motor, *plus* brush friction. The total amount of these need be but trifling, probably less than 5 per cent of the output.

But such apparatus cannot be considered as a general solution of the problem, for while quite successful for an output of 10 KW or so, it has not been tested in large sizes, nor under the conditions of inductance ordinarily to be expected on a power transmission circuit. For the reasons already adduced the chances for success are not good, particularly since all questions of sparking become very grave when large currents must be dealt with. This difficulty is well known in dynamo working. For instance, in an arc machine there may be frequent recurrence of the long, wicked-looking blue sparks familiar to every dynamo tender, without noticeable damage to the commutator, while in a low voltage generator sparking of much less formidable appearance may put the machine out of business in a very short time.

Bearing all this in mind, it is but natural to expect that another particular solution of the reorganizing problem might be found for arc lighting. Here the irregularity of a "rectified" current is of small consequence, while the small amount of current cannot cause really destructive sparking if other conditions are fairly favorable. So it is that we find commutating apparatus in quite successful use for arc lighting in connection

with alternating stations. The form of apparatus shown in Fig. 171, designed by Ferranti, has been introduced in several British stations with good results. The commutating mechanism is of course used in connection with a "constant current" transformer, arranged so as automatically to hold the current closely uniform under all variations of load. Each commutating unit supplies two separate arc circuits of moderate capacity — twelve lights in each. How well the same device works at several times the E. M. F. necessary to supply so small a series, is now being demonstrated. The present tendency in central station practice is to employ very high

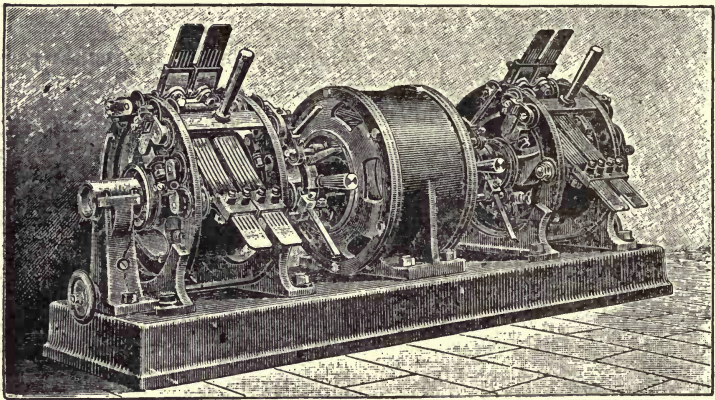

FIG. 171.

voltages for arc lighting — 50 to 100 or 125 lamps in series, thus greatly simplifying both the station equipment and the circuits. The rectifier should at least be able to replace the smaller generators now in use, and such machines are now built for as many as sixty lights. This is probably practical — in fact there seems to be no good reason why the rectifier should not be entirely available wherever it is desirable to work series arc circuits in connection with a transmission plant. Although not in use sufficiently long to enable one to pass a final judgment, the machine is at least promising and worth careful investigation. There seems to be some doubt as to the successful working of these rectifiers at anything except rather low frequencies, 30 to 40~ or less, but such a difficulty would

appear to be constructional rather than inherent. It is possible that the alternating arc lamp will be developed far enough to render continuous current arcs entirely unnecessary, but this remains yet to be proved, although the inclosed alternating arc now gives highly successful results, particularly in street lighting.

All rectifying commutators now in practical service are of very limited output — not much exceeding 10 to 20 KW, an amount merely trivial so far as large enterprises are concerned. For railway work or incandescent lighting, these very interesting machines cannot be considered in the race at present. The general problem is as yet unsolved by such means, useful as they may be for special purposes.

The current delivered by rectifiers is in a measure discontinuous, and, hence, is not the full equivalent of an ordinary continuous current. The Pollak machine, however, which is intended to be used with a somewhat flat-topped alternating current wave, has been successfully employed for working motors as well as for charging accumulators. It is not impossible that such apparatus may yet be constructed of sufficient capacity to be of much practical service, although the difficulties, as has already been pointed out, are very considerable, and of a kind very hard to overcome. Of course, polyphase currents can be rectified by following the same process as with monophase current, and a successful apparatus would often find some place in transmission plants.

The advantages of the rectifying commutator are simplicity, efficiency, and cheapness, particularly the last. The working parts are a small synchronous motor, made self-exciting (and self-starting) by a commutator, and one or more rectifying commutators driven by this motor. To obtain 100 KW output, it is not necessary, as in other forms of current reorganizers, to have a machine nearly as large and costly as a 100 KW dynamo. On the contrary, a one or two horse-power motor would be amply powerful to drive the commutator, and the whole affair could hardly cost a quarter as much as a dynamo of the same capacity, besides being of greater efficiency, particularly at partial loads. But a hundred kilowatts is far beyond the output of any rectifier that has yet been

put to commercial service, and even a hundred kilowatts is but a fraction of the output that is often desirable in a single unit.

On the other hand, a rectifier must require at least the same care as a dynamo, and must in every practical case be employed in connection with reducing transformers to bring the alternating current to the right voltage. The regulation too, is somewhat dubious, since compound winding is out of the question. And the current is at best disjointed, likely to produce needless hysteresis, and of a character rather hard to measure conveniently.

To sum up, the rectifying commutator, while quite good enough for certain particular purposes, has so far given no definite promise of general usefulness. All of the serious attempts to develop it on a considerable scale have ended in failure. It is not effectively reversible, so that the task of converting continuous to alternating currents is quite beyond it. While the cheapness, lightness, and efficiency of such apparatus puts it in these particulars far ahead of any other type of current reorganizer, the verdict of experience has so far been adverse in spite of these advantages, and engineers have been driven to other and more cumbersome devices.

The most obvious method of deriving continuous from alternating currents, is to employ an alternating current motor in driving a continuous current dynamo. The two machines may be connected in any convenient way, by belting, clutching the shafts together, or by putting them in even more intimate connection by placing two armatures on the same shaft or two windings on the same core.

The procedure first mentioned is not infrequent, particularly when a transmission of power plant is installed in connection with an existing lighting or power station. A synchronous motor is installed in place of the previously used engines, belted in any convenient way to the existing generators, and the operation of the station goes on as before. Further description is unnecessary, as the apparatus is in no way out of the ordinary, and not at all specialized for the conversion of alternating to continuous currents. As a rule such installations have temporary, and have been replaced later by special apparatus worked directly from the transmission system.

A more interesting way of accomplishing the same result is by the use of a twin machine comprising motor and generator on the same bed plate, or even on the same shaft. In this way the reorganizing apparatus is formed into a compact unit, convenient to install and to operate, and possessing an efficiency higher than that of two belted machines, by the belt losses and more or less of the bearing friction. The total increase of efficiency is perhaps 5 per cent, when the comparison is between a pair of coupled machines and a pair directly belted, or more if the belting be indirect. Moreover,

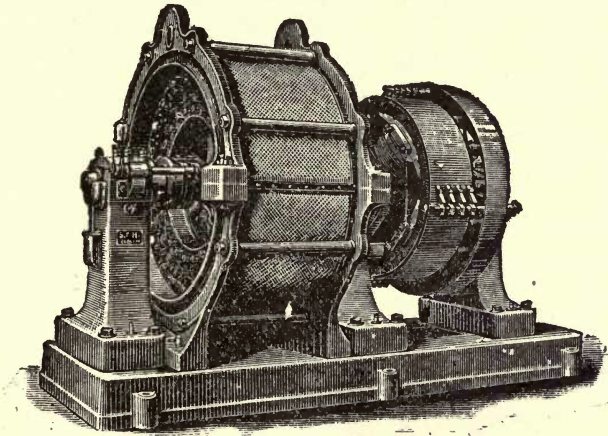

FIG. 172.

the motor and dynamo parts of the machine can each be designed so as to give the best efficiency and economy of construction possible at the given mutual speed. A unit of this class is shown in Fig. 172 — an early Siemens continuous alternating transformer. The motor part is wound for 2,000 volts, monophasic, and the dynamo part, of the well-known Siemens internal pole-type, with overhung armature and brushes directly on the windings, delivers continuous current at 150 volts. In this case the machine has three bearings, although in many cases it would be quite possible to get along with two. The main advantage of this duplex form of machine is the complete independence of the two component parts in

their electrical relations. The motor part can be designed for any desired voltage or number of alternations. It can often, except in very long transmissions, take the line voltage directly without need for reducing transformers, while the number of alternations can be chosen solely with reference to general conditions and without considering the direct current end of the machine at all. This, as will be seen when we have considered some other types of current reorganizers, is a very valuable property, since it gives the power of obtaining continuous current in a thoroughly practical way from alternating currents of any frequency. Other reorganizers can be worked to advantage only within a somewhat limited range of frequency. Again, the motor dynamo can be compounded on the continuous current side without in any way reacting upon the alternating circuit, and the two circuits can be regulated independently in any desired manner. All difficulties due to lagging current can be eliminated, and the continuous current side can be kept at constant pressure irrespective of loss in the main line or any variations of voltage or phase occurring in it.

Finally, the apparatus can as readily give alternating current from continuous, as the reverse, and with the same independence in each case.

The compensating disadvantages are high first cost and rather large loss of energy in the double transformation. As to the former count, it may be said that the advantages gained in possible range of frequency and flexibility in the matter of voltage go far to offset the increase of cost. Often such a motor dynamo is the only possible way of securing the necessary current. For example, if one wished continuous current for heavy motor service, such as hoists and the like, where the only current available was monophasic alternating of 125~, or even of 60~ for that matter, the motor dynamo would be the only practical way of solving the problem.

As regards efficiency the motor dynamo should be, and is, a little better than motor and dynamo separately, owing to lessened friction of the bearings. Its efficiency should be as great as 85 per cent at full load, and might easily be 2 or 3 per cent higher, in large machines. At half load it should

THE
CANTON

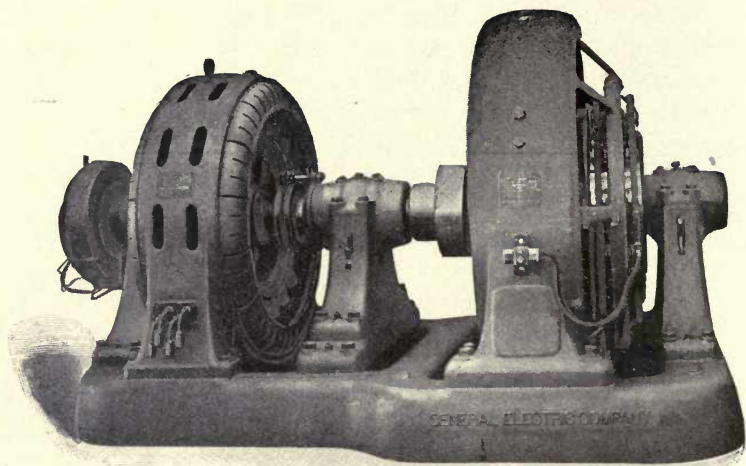

FIG. 1.

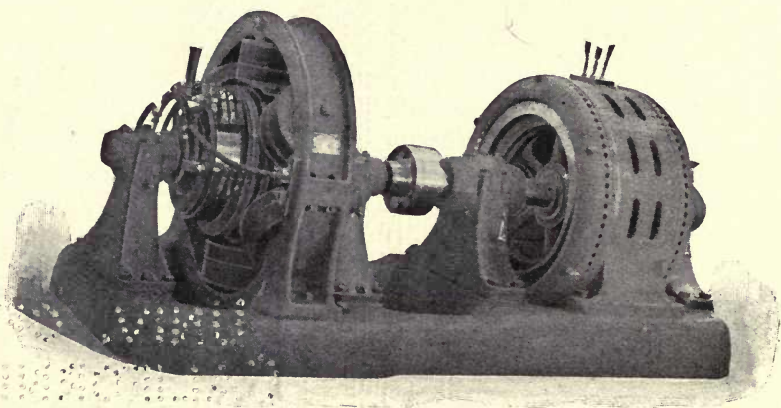

FIG. 2.

be say 82 to 85 per cent. Practice too often shows results several per cent below those mentioned, but this is because motor dynamos have usually been of very small size and sometimes have been made up from any machines of the right speed that were at hand.

The usual synchronous motor may in small motor generators be replaced to advantage by an induction motor, which is simpler than the synchronous form and requires no brushes. Such a combination is shown in Fig. 173. This machine is

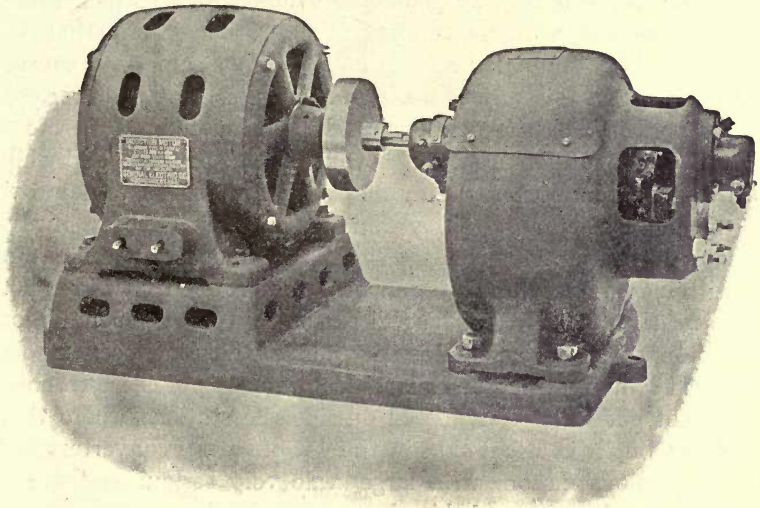

FIG. 173.

specially designed for furnishing charging current for automobile batteries. Through most residence districts only alternating current is available, and the convenience of such an apparatus is very great.

The motor is a monophasic induction machine of the class shown in Plate VIII, Fig. 2, suited to ordinary lighting circuits. Of late such machines have assumed considerable importance, and many large units have been produced. Plate IX shows in Fig. 1 a 500 KW quarter-phase set running at 400 r. p. m. It consists of an 8 pole 500 KW railway generator coupled directly to a 20 pole 2,200 volt synchronous motor, the two machines

having a common bearing between them. An interesting feature of this set is the exciter mounted on the same shaft, an 8 KW multipolar generator, so that the whole outfit is self-contained. The frequency in this case is 66~, a periodicity at which such motor generators have a material advantage over other apparatus for a like purpose.

Fig. 2 is out of the ordinary in that the motor is of the induction type, instead of the ordinary synchronous machine. The set shown is of 100 KW output, and comprises an ordinary 6 pole 600 volt railway generator coupled to a 12 pole three-phase induction motor, running at 600 r. p. m., the periodicity being 60~. Induction motors have recently come into considerable use in this sort of work, in spite of somewhat lower efficiency than the corresponding synchronous motors. It is safe to say that the difference in efficiency is 2 or 3 per cent, and while the synchronous motor may be overexcited so as to improve the power factor of the system, the induction motor always introduces lagging current. Yet a number of motor generators with induction motors are now being built of capacity from 500 to nearly 1,000 KW. The real reason for the use of induction motors on so large a scale is the trouble which has been experienced at many times and places from hunting. These troubles do not get widely advertised outside the stations where they occur, but it is a fact that in the use of rotary converters and synchronous motors on a large scale very serious and formidable developments of this phenomenon have occurred, so that in spite of the use of shields it has under certain conditions, especially when incandescent lighting circuits were to be fed, seemed wise to have recourse to induction motors. It is, however, probably best to regard this as a temporary expedient, as synchronous motors, at least, can be practically freed from hunting by proper design and construction, and possess very considerable advantages. The demand for machines of extreme multipolar construction, a demand based largely on fashion, and the use of laminated pole pieces, are responsible for a good share of the trouble. Rotary converters, as we shall presently see, present even more serious problems.

In these large motor dynamos it is possible to reach full load efficiencies in the neighborhood of 90 per cent, and figures

fully up to that point have actually been obtained. As large synchronous motors can readily be wound for 10,000 or 12,000 volts, under favorable conditions motor dynamos can be used without reducing transformers, which averts a loss of 2.5 or 3 per cent, that would otherwise be incurred.

From the duplex machines just described it is but a short step to the composite dynamotor, so called, of which the armature is double wound. The primary or high voltage winding may of course be either alternating or continuous.

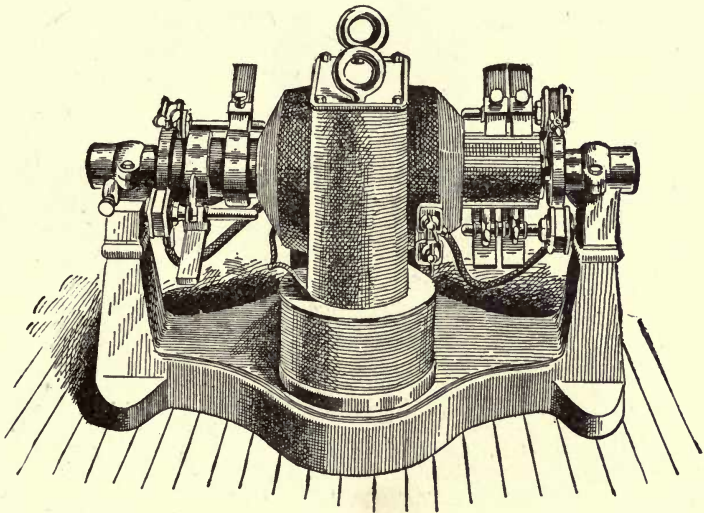

FIG. 174.

The secondary winding is likewise for either current, and may well be fitted with both commutator and collecting rings. A favorite arrangement of the windings is to place the secondary coils in slots in the armature core, apply a sheathing of insulation, and then to wind the primary coils on the smooth surface thus formed. The commutators or rings are placed one at each end of the armature, as in the continuous current transformer shown in Fig. 37, Chapter III.

A typical dynamotor of this sort is shown in Fig. 174. This is specifically intended to derive a high voltage alternating current for testing purposes from a low voltage continuous current. The output is small, only a fraction of a kilowatt

and the armature is in the ordinary bipolar field used for small motors. The motor or primary winding is for 110 volts, continuous, and the secondary for 5,000 volts, alternating. Of course these voltages might be anything desirable, since in so small a machine there are no difficulties in the way.

Another excellent specimen of the same type is Fig. 175, a Lahmeyer "*umformer*" of about 30 KW output. It is primarily a continuous current transformer, with 675 volts primary and 115 volts secondary. It is fitted, however, as shown in

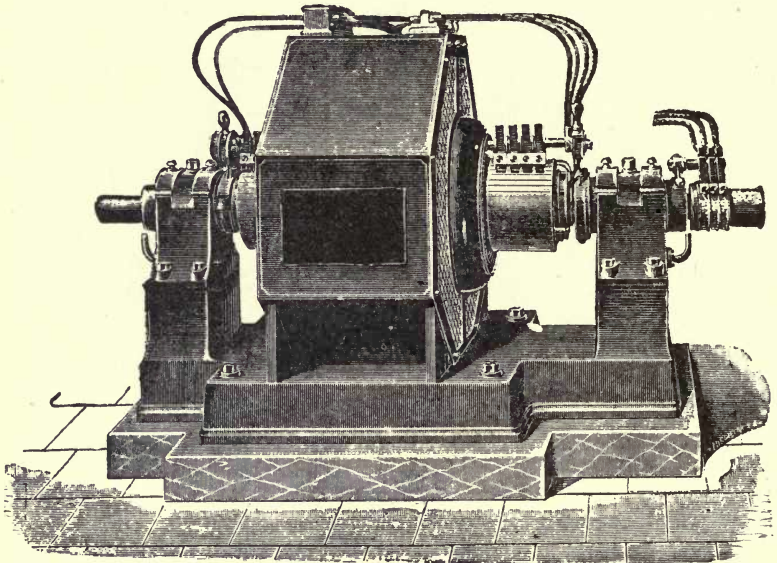

FIG. 175.

the cut, with collector rings outside one of the bearings, from which three-phase current at about 70 volts can be taken. There are four field poles, and as the normal speed is 850 revolutions per minute, the three-phase current is at a frequency of a little less than 30~ per second.

This was one of the machines exhibited at the Frankfort Exposition of 1891, and fortunately an efficiency test of it is available, dealing, however, only with continuous currents. From the nature of the case the efficiency with a three-phase secondary would not differ substantially from that found, so

that the curve, Fig. 176, gives a closely approximate idea of the general efficiency of such apparatus in the smaller sizes. At full load the commercial efficiency is very nearly 85 per cent, while at half load it has dwindled to 77 per cent. This is not bad for a small machine, and in a unit of 100 KW or more could undoubtedly be raised several per cent. It should be at least as high as can be obtained from a duplex motor dynamo, in fact rather higher, since the bearing friction and core losses are diminished. The composite machine is also cheaper, since but one field is used, and it has a certain advantage in that the armature reactance due to the motor and dynamo windings tend to

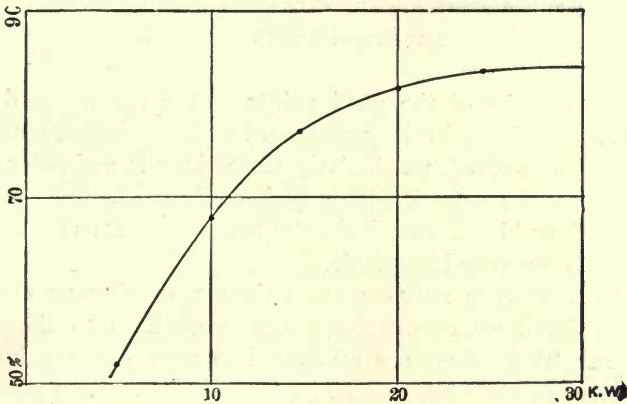

FIG. 176.

oppose each other, and hence to diminish possible sparking and disturbance of the field. It has the same independence of primary and secondary voltage as the duplex motor dynamo. On the other hand, by reason of a common field, the periodicity of the currents in both windings must be the same. It must be remembered that a continuous current armature has a periodicity just as truly as an alternating armature. The current as generated in each is alternating, but in the former it is commuted before leaving the generator. Now, the frequency of these alternations depends directly on the number of poles and the revolutions per minute, being in fact the numerical product of the two. So if one of these composite dynamotors be used with the continuous current winding as primary, the

frequency of the alternating secondary is fixed, since the speed of the machine cannot be changed without involving both primary and secondary voltages. If the alternating current side be used as the primary, the speed of the machine is fixed by the number of alternations, and whatever the voltage of the secondary, the frequency must be the same as that of the primary. Now it is a fact well known to dynamo designers, that continuous current dynamos generating a high frequency current prior to its commutation are troublesome and costly to build. Most continuous current dynamos have an intrinsic frequency of 15 to 25~ per second. To increase these figures to 40~ involves some difficulty, particularly in large machines, while 50 to 60~ are rather hard to reach, unless in sizes of 100 KW and below.

Hence, in spite of the good points of the composite dynamotor, it is of limited utility compared with the duplex machine previously described, particularly since there is a simpler way of doing the same work with a higher efficiency.

This is found in the so-called rotary or synchronous converter, now used on a very large scale.

This machine is nothing more than a continuous current dynamo fitted with collecting rings in addition to the commutator. These rings are connected to appropriate points of the armature winding, and supplied with alternating currents of the same frequency which would be generated by the armature if the machine were used as a dynamo. The brushes being raised, the machine is nothing but a synchronous motor running without load at its normal speed. Now, when the brushes are put down, the alternating current simply flows through the armature much as if it were generated therein, is commuted and passes out upon the line. This commutation takes place under just the same general conditions as if the machine were used as a generator. Meanwhile a portion of the current supplied is passing as before, not through the brushes but through the winding to the collecting rings, keeping up the action as a motor. Of the total current then, a small part forces its way against the E. M. F. set up in the windings by the field, and supplies the motor function; a far greater part, in amount determined by the resistance and

inductance of the armature, flows as if urged by this E. M. F., to the brushes, and supplies the generator function of the machine. But a single armature winding serves to drive the armature and to furnish a large output of commutated current. And this current is not simply rectified, but is of exactly the same character as if generated in the armature.

Inasmuch as the armature is revolving in a magnetic field, the transfer of energy through the rotary converter is not in the last analysis a case of pure conduction and commutation. A part of the energy spent in the motor part of the armature goes into dynamical increase of output in the part which for the moment acts as generator. There is thus a motor

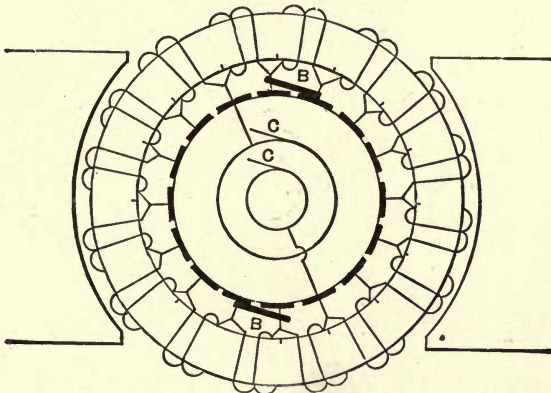

FIG. 177.

generator action in the same armature. Of the total energy delivered from the d.c. side in a monophasic converter like Fig. 177, a little more than 40 per cent of the energy is dynamically transferred, in the polyphasic forms much less, say 12 to 24 per cent according to the number of armature taps. The required motor activity in the converter is thus considerably in excess of that required merely to spin the armature at synchronous speed.

The character of the winding in a rotary converter is generally precisely the same as in a continuous current generator, the only addition being two or more leads from symmetrically placed points in the winding to the collecting rings. These leads

can be so arranged as to form a monophasic system for the alternating current or, if desired, a two- or three-phase system. The latter forms are generally preferred, since like the corresponding synchronous motors they can be made self-starting, while the monophasic machine has to be brought to speed by special and by no means simple methods. Fig. 177 shows the character of the armature in a simple bipolar rotary converter (monophasic). Here the continuous current winding is a Gramme ring in 16 sections. From the brushes *B, B*, continuous current may be applied or withdrawn, while the brushes on the col-

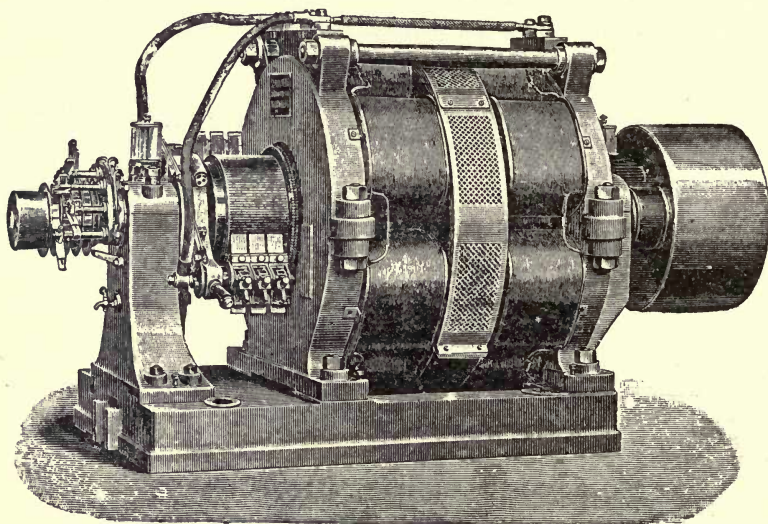

FIG. 173.

lecting rings *C, C*, perform the same office for the alternating current. Such a machine may serve a variety of purposes as follows: 1. Continuous current dynamo. 2. Alternating current dynamo. 3. Continuous current motor. 4. Synchronous alternating motor. 5. Continuous alternating converter. 6. Alternating continuous converter.

Diphase rotary converters are usually supplied with four collecting rings connected to form two circuits, each one joining the windings in two opposite quadrants of the armature. Triphase transformers generally have three collecting rings,

LIBRARY OF
COLUMBIA

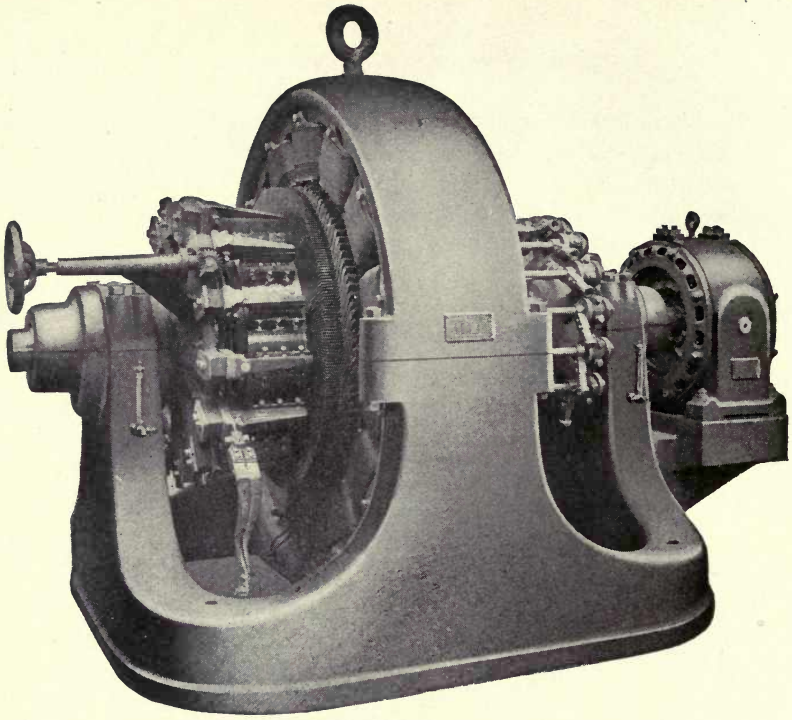

FIG. 1.

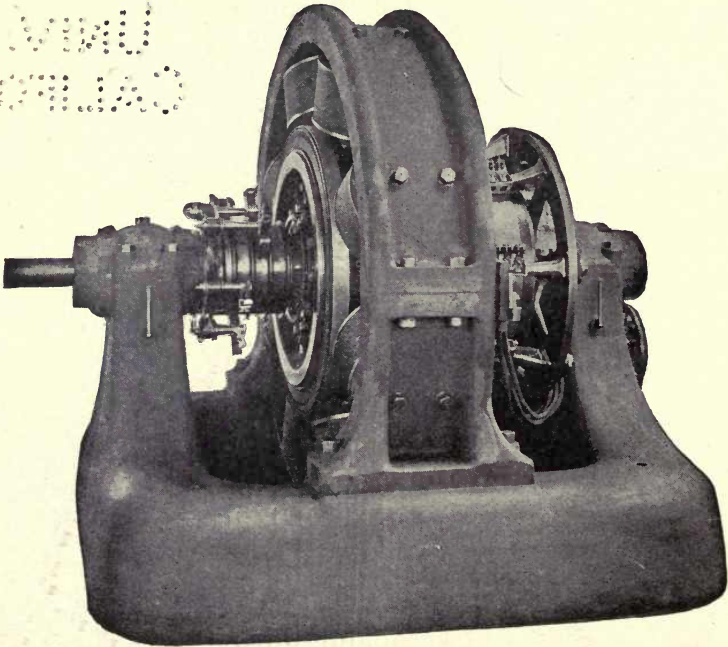

FIG. 2.

with their respective leads tapped into the windings 120° apart. The connections vary somewhat for different kinds of armature windings, but are the same in effect as those just indicated. One of the early practical machines of this sort exhibited at the Frankfort Exposition of 1891 is shown in Fig. 178. It is of the flat ring type usual to dynamos of Schuckert make, and is fitted with four collecting rings outside the bearing at the commutator end. The rings were arranged for either monophasic or diphasic connection. The rotary converter thus organized attracted great attention, and was successfully operated in its manifold and diverse functions. It should be noted that if driven as a dynamo, such a machine can furnish continuous and alternating current simultaneously, a property sometimes convenient, and now not infrequently utilized.

These rotary converters in the diphasic and triphasic forms are playing a very important part in electric railway operations involving considerable distances, and a large number of them are in highly successful use. A good idea of the modern type of rotary converter is shown in Fig. 2, Plate X. This is one of the 400 KW machines installed in 1894 to operate the electric railways in the city of Portland, Ore. It is designed to deliver continuous current at nearly 600 volts, and receives its energy from Oregon City, about fourteen miles away, where is installed a triphasic transmission plant. The motive power is derived from the great falls of the Willamette River. Current is generated at 6,000 volts, with a frequency of $33\sim$ per second, and is given to the rotary converters at about 400 volts, from the secondaries of the reducing transformers. Fig. 1, Plate X, shows a 250 KW Westinghouse diphasic machine, adapted for use on a $60\sim$ circuit and giving continuous current at 250 volts. An interesting feature of this machine is the diphasic induction motor with its armature on an extension of the main shaft. This serves to bring the machine to speed without calling for the excessive current that would be required if the main lines were closed upon the converter armature itself. The monophasic form of this very interesting apparatus has not yet come into much practical use, not through any inherent faults, but because most of the power transmission has so far been accomplished with diphasic and triphasic currents.

The efficiency of these machines is, as might be expected from their character, practically the same as ordinary continuous current dynamos of the same output, or rather better on account of the shorter average path for the current in the armature. In fact, so far as general properties go, they are dynamos. They furnish at present by far the most available means of deriving continuous from alternating currents, for they are simple, of great efficiency, and of about the same price as other generators of the same capacity. In point of fact, a well-designed polyphase rotary converter has rather better output and efficiency than the corresponding generator, since for the reason just noted the armature losses are diminished. Bearing this in mind, it is apparent that increasing the number of points at which the armature is tapped for the alternating current supply, thus shortening the average path to the brushes, will, other things being equal, lessen the armature loss. In practice it is found that a three-phase converter with three armature taps is considerably better than a monophaser converter with two; a quarter-phase converter with four is somewhat better still, while a three-phase connection with separate phases and six taps gives even a higher output and efficiency. The net result is that while a monophaser converter is rather inferior to the corresponding dynamo the two- and three-phase converters are considerably better than the corresponding dynamos. Quarter-phase converters are always connected for four collecting rings, and large three-phase converters not infrequently have six, to gain the advantage just mentioned.

Efficiencies as great as 96 per cent at full load have been obtained from large rotary converters, with 93.6 per cent at half load. These figures are from a three-phase, six collecting ring converter of nearly 1,000 KW output.

As already indicated, there is a strong tendency toward the use of low periodicity, 25~ to 30~ in rotary converters. This is partially due to the complication of the commutator in high frequency converters, partly to the current fashion for extremely low rotative speeds, and partly to lack of *finesse* on the part of the average designer. That converters for a frequency as high as 60~ are entirely feasible even in capacities

up to several hundred kilowatts admits of no discussion, as the machine put in evidence in Plate X, of which a number are in successful operation, plainly shows. It is undoubtedly easier and cheaper to build them for somewhat lower periodicities, but there seems very little reason for going so low as is the current custom, and it tends needlessly to multiply special types of apparatus.

And yet the simplicity of the rotary converter is attained at the cost of certain practical inconveniences that cannot lightly be passed by. Their source is the employment of a single field and armature winding for all the purposes of the apparatus. The results are, first, complete interdependence of the alternating and continuous voltages, and, second, consequent difficulties of regulation that are occasionally very troublesome.

The immediate result of a single winding is that there is an approximately fixed ratio between the alternating and the continuous voltage. The former is always the less, and, while varied by changes in the number of phases determined by the connections, is approximately the alternating voltage that would be yielded by the machine driven as a generator. This is, for monophase or diphas connections, about seven-tenths of the continuous current voltage, and for three-phase connections about six-tenths. The proportions would approximate to

$\frac{1}{\sqrt{2}}$ and $\frac{\sqrt{3}}{2\sqrt{2}}$ respectively, if the alternating E. M. F.'s were

sine waves, which they never are when derived from an ordinary continuous current armature. In service the real proportions may, and generally do, vary by several per cent, according to the excitation. In a particular two-phase case the actual ratio was .68, and in a three-phase case .65. If, therefore, a rotary converter be used for supplying continuous current, the applied alternating current must be of lower pressure than the derived continuous, in about the proportion above noted. This compels the use of reducing transformers in every case of power transmission involving this apparatus. Further, any cause that affects the alternating pressure affects the continuous as well. Line loss, inductance, resonance effects, as well as changes at the generators, all influence the vol-

tage at the continuous current end of the rotary transformer. Nor can this voltage be freely altered by changing the field strength, since, as we have already seen, this may profoundly change the inductance of the alternating circuit, which is for many reasons undesirable. The field windings of rotaries are either shunt from the d.c. side or compound. The former winding gives much the steadier power factor and, hence, is rather desirable for close regulation of a steady load, while the latter is advantageously used for railway loads and the like. The best results are obtained by carefully adjusting the generator, line, and rotary converters to work together. Otherwise there is likely to be trouble in regulation.

For these reasons in cases where close regulation is necessary, as for incandescent lighting, preference has frequently been given to the motor generator with double field and armature, as in the large Budapest system installed by Schuckert & Co., who were among the pioneers in developing the rotary converter. In this case the transmission is at 2,000 volts diphasé, at which pressure current is delivered to the motor end of the motor generators placed in substations at convenient points. In such a plant the increased cost of the duplex machines is not so great as might be supposed, for reducing transformers are needless, and the output of both generators and motors can be forced to the utmost limit of efficient operation, without fear of injuring the regulation, which is reduced to the easy problem of accurately compounding a continuous current generator. The net efficiency of the Budapest transformation is said to be 85 per cent. Some recent experiments on the relative efficiency and cost of motor generators and rotary converters are as follows: The sets compared were of 200 KW capacity for changing triphase current from the Niagara circuits at 11,000 volts, 25~ into continuous current at 120 to 150 volts. The efficiencies given are net, including the necessary provisions for obtaining a variation of 25 per cent in the finally resulting voltage:

	Motor- Generator.	Transformers and Rotaries.	Difference.
Full load	87.40	89.87	2.47%
$\frac{3}{4}$ load	85.54	88.70	3.16%
$\frac{1}{2}$ load	81.42	84.90	3.48%

The extra apparatus required with the rotaries brought the two methods to substantially the same cost, but for lighting work the motor generators gave the better results.

From the foregoing it is sufficiently evident that every case of current reorganization cannot be successfully met by the same apparatus. For certain small work the rotating commutator seems to be fairly well suited, and for occasional purposes it is somewhat cheaper and more efficient than any of its rivals. Next in point of efficiency and cheapness comes the rotary converter, infinitely better for heavy work than any commutating device, and finding very extensive application to electric railway work. Finally, for work requiring very close regulation, the motor generator is specially well suited, closer to the rotary transformer in cost and efficiency than would be supposed off-hand, and unique in the complete independence of its working circuits.

Practice in this line of operations has not yet settled into fixed directions, and is not likely so to do just at present. Each plant must therefore be considered by itself and treated symptomatically.

American usage is at present tending strongly toward the rotary converter, on account of its ready adaptation to railway service, but, in view of the work that has been done on alternating motors for such service, it is an open question how far current reorganization will be generally necessary in the future, although just now it is of very great practical importance.

As the price of copper rises, the use of current reorganizers becomes more and more important in railway work, and for this particular use the rotary converter is generally chosen.

There should be mentioned here some curious and valuable devices for obtaining rectified alternating currents, based upon the phenomena of polarization.

Obviously, if one could find a conductor which would let pass currents in one direction, and block those in the other, the result of putting it in an alternating circuit would be that all the current impulses in one direction would be suppressed, so that the resulting current would be a series of separated half-waves of the same polarity. It would be as if in Fig. 166 all the half-waves above the base line were erased. Now such a

conductor is actually obtainable in certain electrolytic cells in which a counter electromotive force or severe polarization resistance impedes current flowing in a particular direction. Under favorable circumstances the selective action is quite complete, so that the alternating current becomes unidirectional. Fig. 179 shows the current curve for a complete cycle as modified by electrolytic rectification. The positive half of the wave is practically wiped out of existence. The efficiency of these electrolytic devices as regards the energy rectified is quite low, and most of the apparatus constructed has been upon a very small scale, but there are certain purposes, like energizing induction coils, for which it may occasionally be of service. It is given place here more on account of its

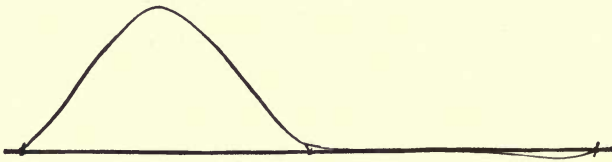

FIG. 179.

general interest than for any practical value. It works best, like most other rectifying devices, at low frequencies.

The latest and in some respects the most interesting device for obtaining continuous currents from an alternating source, is the vapor, or mercury arc converter. Its action depends on the mechanism of current flow in the electric arc. As is well known, the current is carried across the space between the terminals of an electric arc by a blast of vapor streaming from the negative to the positive electrode. An arc cannot start until this stream has been established, for which reason arcs are generally started by touching the electrodes momentarily together. For the same reason on a low frequency alternating circuit, or generally unless a considerable mass of conducting vapor lingers between the poles, the arc readily goes out, since, granted that the arc is struck at all, the negative stream dies with the pulse of current that produced it, and the following alternation can only get through by starting a new stream from the other electrode as negative.

Now, the arc formed about a mercury negative pole in vacuo

has this remarkable property, that, while once started the stream can be maintained by a few volts, it takes many thousand volts to initiate or to reestablish the stream over any material gap. Hence, if the stream is once started it can be kept in action continuously by a rather low voltage current, but can be reversed only by an enormous E. M. F. in the opposite direction.

If, however, the original negative stream can be kept going

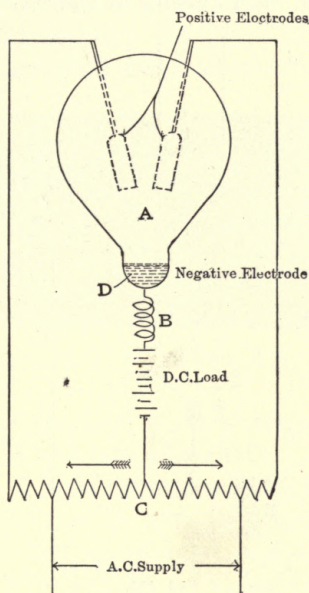

FIG. 180.

it will transmit freely current impulses in the original direction while reverse impulses will lack the potential required to reverse the stream. Upon this property of the mercury arc the vapor converter is based, and the essential feature of its operation is the preservation of the negative stream by sending overlapping impulses, so that once started the original stream shall not die out. The extremely ingenious method of doing this is shown in Fig. 180. Here A is an exhausted bulb 8 or 10 inches in diameter, containing two positive electrodes side by side, and a mercury negative electrode D.

At *B* is a fairly stiff reactance. The two positives are connected to the terminals of an auto-converter *C* and its middle point is connected to *B* through the proposed d. c. circuit.

The apparatus is started by tipping the bulb until a supplementary mercury positive touches the negative and as the bulb is tipped back the negative stream starts.

Let us say that the current let through is via the right hand electrode. Owing to the reactance *B* the current, lagging, persists until the E. M. F. rising in the left hand connections

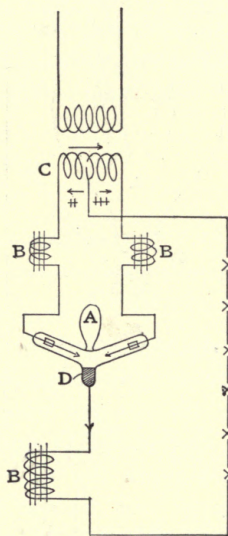

FIG. 181.

has had time to start via the same negative stream, a current through the other positive electrode. Positive electrodes virtually in the same negative vapor blast can thus exchange work freely, provided the blast be not interrupted.

The two sides of the circuits thus keep up the interchange, working alternately, but utilizing as will be seen from the consecutive directions of flow, both sets of alternations. By this same cause the effective E. M. F. of the rectified current is something less than half the nominal a. c. voltage applied to the apparatus as a whole. By a stroboscopic examination the sequence of the operations can be very beautifully seen.

Two-phase or three-phase currents can be made operative in a very similar manner so that the process is a general one. It can be made operative at any commercial frequency.

Fig. 181 shows the constant current form of the same device. The letters have the same significance although the electrode tube is of different shape, and the coil *C* is here the secondary of a constant current transformer. The resulting current from the vapor converter is evidently not uniform but somewhat pulsatory as if received from a dynamo having very few segments in the commutator.

Fig. 182 from an oscillograph record* of the current form

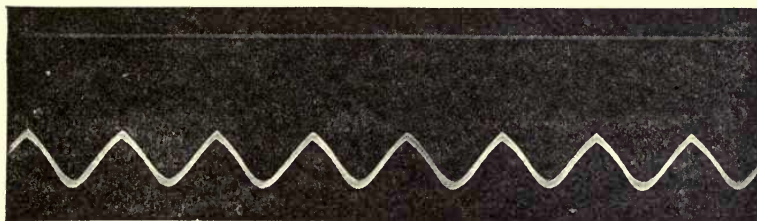

FIG. 182.

derived from the constant current converter like Fig. 181, shows the facts in the case admirably.

The efficiency of such apparatus is high. There is a small back E. M. F. of about 15 volts to overcome, the ohmic and hysteric loss in the transformer and reactance, and some heating of the converter tube. The higher the voltage applied to the tube the less current for a given energy and the better the efficiency, and the voltage may be anything that will not strike a reverse arc in the tube. At current of a few amperes the working a. c. voltage may even be 25,000 volts. At moderate voltages the back E. M. F. is more important and the current rises for the same energy so as to sooner reach the heat endurance of the tube.

The constant potential form is now commercially available in moderate capacities, say up to 25 or 30 KW at 115 to 120 volts, the efficiency being about 75 to 80 per cent. These converters are designed for charging storage batteries and

* Steinmetz, tr. A. I. E. E. June, 1905.

similar light work. The constant current form is beginning to be used for arc lights, giving d. c. arcs off an a. c. circuit, using d. c. voltages up to 4,000 or 5,000 volts. The efficiency of such sets is probably between 80 and 90 per cent, and the power factor is reported to be .90 or better.

The apparatus is very beautiful in principle, and has thus far developed no serious operative defects. Its life is somewhat uncertain and a good deal of experimenting is still needed to bring it into standard form, but it is altogether very promising. Whether it is to be available for large powers remains to be seen, but it is certain to find a wide commercial use so soon as it has been far enough standardized to enable the price to be brought down to a manufacturing basis. At present the figures are too near those charged for motor generators to encourage any widespread enthusiasm.

Of late two very interesting converting devices have come into use abroad. The first is the "cascade converter" of which the

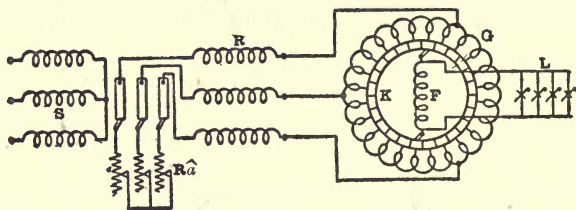

FIG. 183. CIRCUITS OF CASCADE CONVERTER.

circuits are shown in diagram in Fig. 183. The machine consists virtually of an induction motor directly coupled to a rotary converter, each being of about half the total rated output. In the figure S is the stator winding of the motor end, R the rotor winding, R_a the starting resistance. On the generator end G is the armature winding, K the commutator, F the shunt field, and L the load. Both ends have ordinarily the same number of poles. The rotor and the converter armature being in series the normal counter E. M. F. is reached at half synchronous speed, and commutation takes place at half the initial frequency, which is a great advantage. Similarly half the energy is delivered to the output end of the machine by the rotor as frequency changing transformer, and the rest by torque on the shaft. These cascade converters have admirable operative qualities, and have come

into use with excellent results in several foreign railway plants in preference to ordinary motor generators or rotary converters.

The second device for the same purpose is known as the "permutator." As at present made it is a vertical axis machine

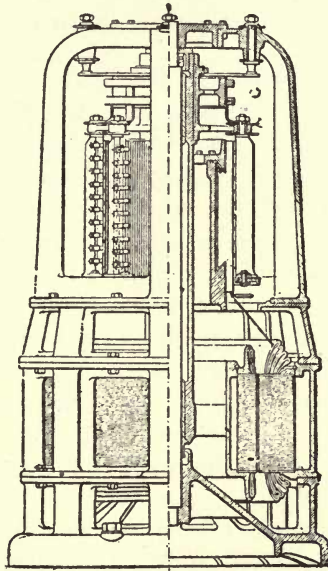

FIG. 184. VERTICAL SECTION OF PERMUTATOR.

shown in section in Fig. 184. It is, in effect, much like an induction motor, with the rotor fixed and provided with a commutator around which the brushes are moved in synchronism. The rotary field is substituted for the physical rotation of an armature while the brushes follow it, synchronously driven by a motor armature requiring but a modest input. The efficiency of these permutators is said to be very high, materially greater than that of an ordinary rotary converter, and the space required and the weights involved are very moderate. The preliminary reports from the permutator are good, but it has not yet come into sufficient use to give a fair basis for a final judgment. The conditions for commutation do not look altogether favorable, and rotating brushes are somewhat objectionable from a practical standpoint, so that one would expect the machine to be of special rather than of general usefulness.

CHAPTER VIII.

ENGINES AND BOILERS.

MECHANISMS that constitute the link between natural sources of energy and mechanical power are called prime movers. So far as the electrical transmission of energy is concerned, but two classes of prime movers, steam engines and water-wheels, have to be seriously considered. All others sink into insignificance or are limited to special and rarely-occurring cases. When power is transmitted electrically over considerable distances the prime mover is usually a water-wheel, since, as yet, the transmission of power from coal fields has been hardly more than begun, although when long electrical lines become somewhat more familiar, coal may become a frequent source of energy. Where the distribution of power from a central point is to be accomplished, the prime mover is frequently a steam engine.

The general principle of the steam engine may be fairly supposed to be somewhat familiar to the reader, but the conditions of economy are not always so clearly understood. The source of power in an engine is the pressure of the steam, which must be utilized as fully as possible to get anything like efficient working. Since the pressure is in direct proportion to the temperature in any gas, the proportion of the total pressure which can be used depends on the original temperature at which its use is begun, and the temperature at which one ceases to use it and rejects it together with all the energy it then possesses. These temperatures are not to be reckoned from the ordinary zero of a thermometer, but from the so-called absolute zero. This is that point from which, if the temperature of a gas be reckoned, its pressure will be directly proportional to the temperature. It is 461° below zero, Fahrenheit, that is, 493° below the melting point of ice. It is determined by the consideration that any gas at this melting point loses $\frac{1}{473}$ of its pressure for a change in temperature of

one degree, hence, if it could be cooled down 493° , would lose its pressure and would have given up all of its energy. Counting from this absolute zero, then, one can utilize that part of the whole energy of a gas which lies between the temperature at which the gas begins to work and that at which it ceases to do work. In other words the efficiency of any engine operated by gaseous pressure is:

$$\frac{T_1 - T_2}{T_1},$$

in which T_1 is the absolute temperature of the gas when it begins to do work in the engine, and T_2 the absolute temperature at which its work ends. In practice, T_1 is the temperature of the steam when it enters the cylinder, and T_2 the temperature of exhaust or condensation. Steam permits the use of but a limited range of temperature on account of the temperature at which it liquefies, and bothers us by condensing as it expands, even in the cylinder. It must be remembered that while we are limited by our possible range of temperature to a low total efficiency in any heat engine, of the energy that can possibly be obtained within this limitation, a very good proportion is recovered in the best modern engines — from one-half to three-fourths. The remainder is lost in various ways, largely through radiation of heat and cylinder condensation. Besides these thermal losses a portion of the energy utilized is wasted in friction of the mechanism.

From these considerations we may derive the following general principles of engine efficiency:

I. The steam should be admitted at the highest pressure feasible and exhausted at the lowest pressure possible.

This indicates that high boiler pressure should be used, and that it is better to condense the steam than to expel it into the air, as by condensing most of the atmospheric pressure can be added to the working range of pressure in the engine. In the next place it is evident that the steam should be sent into the engine at full boiler pressure, and finally condensed after expanding and yielding up its pressure as completely as possible.

II. Waste of heat in the engine should be stopped as far

as possible. This means checking losses from the cylinder by radiation and conduction, and internal loss from cylinder condensation. The first principle laid down has for its object the increase of the possible efficiency, while this second principle bears on the securing of as large a proportion as possible of this possible efficiency. It requires the prevention of escape of heat externally by protecting the cylinder, and incidentally shows the advantage of high pressure and high piston speed in securing as much work as possible without increasing the size of the working parts, and hence their chance for radiation. On the other hand, it indicates the danger of working with too great a range of temperature in the cylinder thus producing cylinder condensation.

III. The work of the engine should be the maximum practicable for its dimensions and use. This secures high mechanical efficiency as the previous principles secure high thermal efficiency. To fulfill this condition high steam pressure and high piston speed are necessary, and the latter usually means also rather high rotative speed. The importance, too, of fine workmanship in the moving parts is evident.

It will be realized that some of the conditions just pointed out are mutually incompatible to a certain extent. Everything points, however, to the great desirability of a condensing engine, worked with a high initial steam pressure and great piston speed. The tendency of the best modern practice is all in this direction, and the efficiency of engines is constantly improving. The greatest advances of the past decade or two have been in the introduction of compound engines. The principle here involved is the lessening of thermal losses in the cylinder by avoiding extremes of temperature between the initial and the final temperature of the steam expanded into it. Compound engines simply divide the expansion of the steam between two or more cylinders, so that the temperature range in each is limited, without limiting the total amount of expansion.

Following the same line of improvement, triple and quadruple expansion engines are becoming rather common, although the value of the last mentioned is somewhat problematical at present.

For practical purposes steam engines may be classified in terms of their properties, somewhat as follows :

First, there is the broad distinction between condensing and non-condensing engines. The former condense the exhausted steam and gain thereby a large proportion of the atmospheric pressure against which the latter class is obliged to do work in exhausting the steam. Where economy of operation is seriously considered, the non-condensing engine has no place, if water for condensation is obtainable.

Each of these classes falls naturally into subclasses, depending on the number of steps into which the expansion is divided — simple, compound, triple expansion, etc. Of these the first may now and then be desirable, where the size is small and coal very cheap, but for the general distribution of energy the last two are more generally useful. Furthermore, each of the subclasses mentioned may be divided into two genera, depending on the nature of the valve motions that control the admission and rejection of the steam. To follow out the first principle of economy laid down, the steam must be admitted at a uniform pressure as near that of the boiler as possible, the admission should be stopped short after entrance of enough steam for the work of the stroke, the steam allowed to expand the required amount, and then rejected completely at the lowest possible pressure. The admission valves should therefore open wide and very rapidly, let in the steam for such part of the stroke as is necessary, and then as promptly close. The exhaust valves should open quickly and wide when the expansion is complete, and stay open until nearly the end of the stroke, closing just soon enough to cushion the piston at the end of its stroke. In proportion to the completeness with which these conditions are met, the use of the steam will be economical or wasteful. The two genera of engines referred to are those in which the motions of the admission and exhaust valves are independent of each other or dependent. Fig. 185 shows in section the cylinder and valves of an independent valve engine, Corliss type. The arrows show the flow of the steam. The admission valve on the head end of the cylinder has just been opened, as also has the exhaust valve on the crank end.

The essential point of the mechanism is that the admission valves open and close at whatever time is determined by the action of the governor without in the least affecting the working of the exhaust valves. In the Corliss valve gear the steam valves are closed by gravity, or by a vacuum pot, and are opened by catches moved by an eccentric rod, and released at a point determined by the governor, which thus varies the point of cut-off according to the load. Ordinarily the admission of steam is thus cut off in a simple engine at full load after the piston has traversed from one-fifth to one-quarter of its stroke, according to the pressure of the steam. If the cut-off is too late in the stroke, there is not sufficient expansion of

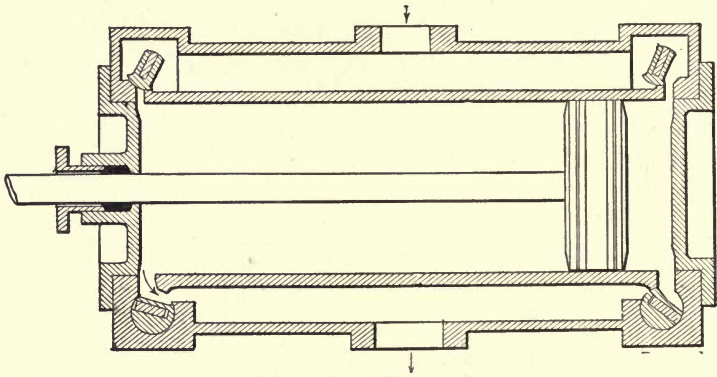

FIG. 185.

the steam; if too early the steam is partially condensed by too great expansion. For every initial pressure of steam there is a particular degree of expansion which gives the best results in a given engine.

Fig. 186 shows the valve motion of one of the best of the dependent valve genus. Steam is just being admitted at the head end both around the shoulder of the hollow piston valve and through the ports at the other end of the valve via the interior space. At the crank end the exhaust port has just been fully opened. It will be seen that any change in the conditions of admission also involves a change in the conditions of exhaust, and although some variation may take place in the latter without serious result on the economy, simplicity

in the valve gear has been gained at a certain sacrifice of efficiency in using the steam. Both independent and dependent valve engines have many species differing widely in mechanism, but retaining the same fundamental difference. Of the two genera, the independent valve engine has the material advantage in efficiency, and under similar conditions of pressure, capacity, and piston speed consumes from 10 to 20 per cent less steam for the same effective power. It there-

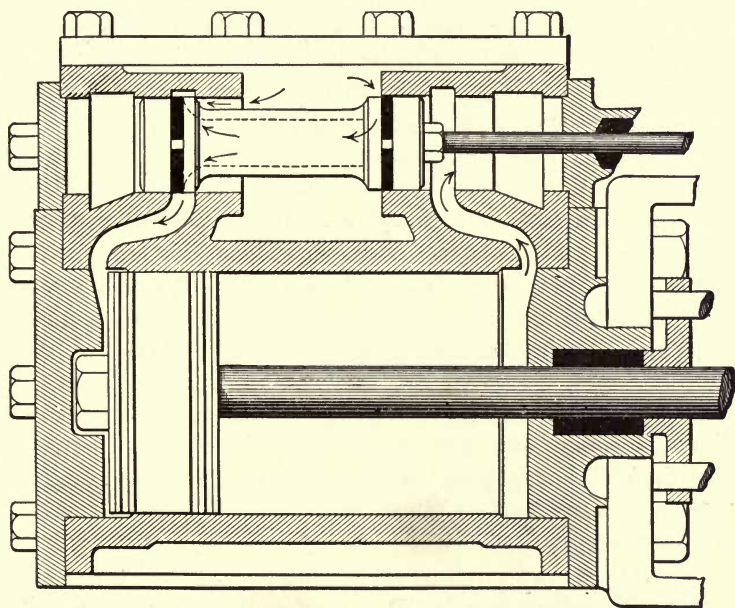

FIG. 186.

fore is generally employed, in spite of somewhat greater first cost, for all large work, often in the compound or triple expansion form. Except in small powers, or for exceptionally high speed, the dependent valve engine has few advantages, and in the generation of power on a large scale, such as for the most part concerns us in electrical transmission work, it hardly has an important place.

It must not be supposed that between the various sorts of engines mentioned there are hard and fast lines. In the economical use of steam a very large non-condensing engine

may surpass a smaller condensing one, or a fast running dependent valve engine, a very slow running one with independent valves. Broadly, however, we may lay down the following propositions concerning engines of similar capacity:

I. Condensing engines will always furnish power more economically than non-condensing ones. This is particularly true at less than full load, since the loss of the atmospheric pressure may be taken as a constant source of inefficiency, which, like mechanical friction, is very serious at low loads. For example, a triple expansion engine working at one-quarter load in indicated HP, will be likely to have its consumption of steam per IHP, increased from 15 to 25 per cent above the consumption per IHP at full load; while worked non-condensing, the increase would be from 50 to 100 per cent. Hence, for electrical working where light loads are frequent, condensing engines are an enormous advantage. With simple or compound engines the same general rule holds good as for triple-expansion engines, with the additional point that light loads affect their economy even more, when worked non-condensing. It must be borne in mind that if any engine is to do its best under varying loads, its valve gear and working pressure must be arranged with this in mind, else the advantage of high expansion and condensing may be thrown away. It is frequently said that triple expansion engines do not give good results in electric railway work. When this is the case there has been improper adjustment of engine to load.

II. Among engines having the same class of valve gear, compound engines give better economy than simple ones, and triple expansion better than compound. This is true irrespective of the nature of the load, supposing each engine to be suitably adjusted to the work it has to do. In rare cases, owing to exceedingly cheap fuel and short working hours, it may happen that the advantage of a triple expansion engine over a compound in economy of coal may be more than offset by increased interest on investment, but at the present cost of engines and boilers, this could not well occur unless in the case of burning culm or poor coal obtained at a nominal price.

III. As regards speed of engines, there is always advantage

in high piston speed both as respects first cost and mechanical efficiency. So far as the economical use of steam goes, speed makes little difference save as it sometimes involves a change in the valve gear. Most high-speed engines have valve gear of the dependent sort, which puts them at a disadvantage except in so far as lessened cylinder condensation and friction may offset the losses due to less efficient distribution of the steam. But the best dependent valve engine is uniformly less economical than the best independent valve engine of the same class and subclass. Even the lessened friction of the small high-speed pistons does not offset this difference in intrinsic economy.

As regards actual economy in the steam consumption, the size of engine has a powerful though somewhat indeterminate influence. Even at full load, simple non-condensing dependent valve engines of moderate size require from 30 to 40 lbs. of steam per indicated horse-power hour. Only in very large engines, such as locomotives, and specially fast running engines such as the Willans, does the steam consumption of these dependent valve engines fall below 30 lbs., and not very often even in these cases. Worked condensing the same machines use from 20 lbs., in exceedingly favorable cases, to 25 or 30 lbs. more commonly.

Independent valve engines, simple and non-condensing, will give the indicated HPH on 25 to 30 lbs. of steam, occasionally on as little as 22 to 23 lbs. With the advantage of condensation these figures may be reduced to say 18 to 25 lbs., the former figure being somewhat exceptional and probably very rarely attained in practice.

Passing now to compound non-condensing engines, the effect of compounding on efficiency is about the same as that of condensing. Ordinary dependent valve engines of compound construction require from 20 to 25 or 30 lbs. of steam per IHP hour. The former result is very exceptional, and seldom or never reached in practice, while the last mentioned would be considered rather high. Independent valve compound engines are so seldom worked non-condensing, that the data of their performance are rather meagre; 18 to 25 lbs. of steam is about the usual amount, however.

When condensation is employed, on the other hand, the dependent valve engines are in rather infrequent use. When the need for economy is so felt as to lead to the use of compound engines, it also leads to the use of economical valve gear. The steam consumption of dependent valve compound condensing engines is quite well known, however, and is usually from 16 to 24 lbs. per IHP hour. The first mentioned figure is rarely reached, and only in special types of engines.

Plenty of tests on compound condensing engines with independent valves are available; 14 to 20 lbs. of steam covers the majority of results. Occasional tests run down to and even below 12 and as high as 22 lbs.

It is noticeable that in compound engines the difference between dependent and independent valve gear is less than with simple engines. This is due to a variety of causes. The larger range of expansion used in compound engines tends to lessen the deleterious effects of moderate variations in the distribution of the steam, and besides, the valve gear of compound engines is not infrequently composite, the high-pressure cylinder having independent valves and the low-pressure cylinder dependent ones.

The same arrangement is often used in triple expansion engines, so that, in conjunction with the condition before mentioned, it is usually true that the economy of dependent valve triple expansion engines is much nearer that of independent valve ones than would be at first supposed. Without condensing, a dependent valve triple expansion engine may be expected to require from 19 to 27 lbs. of steam per IHP hour. With condensation such engines perform much better, the steam consumption being reduced to 14 to 20 lbs.

Nearly all triple expansion engines, however, are built with independent valves, at least in part, the intention being to secure the most economical performance possible. Under favorable conditions their steam consumption runs as low as 12 lbs. per IHP hour, and seldom rises above 18 lbs. In a few exceptional cases the record has been reduced below 12 lbs., but such results cannot often be expected. Anything under 13 lbs. of steam per HP is good practice for running conditions.

All the figures given refer in the main to good sized engines of at least 200 HP and over, operated at full load and at favorable ratios of expansion. It must be clearly understood that there is for each steam pressure a particular ratio of expansion which will give the most economical result — less expansion than this rejects the steam at too high a temperature; more, causes loss by condensation, etc. Compound and triple expansion engines permit greater expansion of the steam without loss of economy, hence allow higher steam pressure and a greater temperature range — hence higher thermal efficiency. Good practice indicates that for simple engines the boiler pressure should be not less than 90 to 100 lbs. per square inch, for compound engines not less than 120 to 150, and for triple expansion engines not less than 140 to 150, and thence up to 175 or 200 lbs.

We may gather the facts regarding steam consumption into tabular form somewhat as follows:

Kind of Engine.	Steam per IHP. General Range.	Steam per IHP. Working Average.
Simple, non-condensing dep. v.	30-40	33
Simple, non-condensing indep. v.	25-30	28
Simple, condensing dep. v.	20-30	25
Simple, condensing indep. v.	18-25	21
Compound, non-condensing, dep. v.	20-28	24
Compound, non-condensing indep. v.	18-25	22
Compound, condensing dep. v.	16-24	20
Compound, condensing indep. v.	14-20	17
Triple, condensing dep. v.	14-20	17
Triple, condensing indep. v.	12-18	14
Triple large, condensing indep. v.	12-14	13

The engines considered are supposed to be of good size — say 200 to 500 HP, and to be worked steadily at or near full load. The figures given as working average are such as may be safely counted on with good engines, kept in the best working condition, and operated at at least the boiler pressures indicated. The steam is supposed to be practically dry and the piping so protected as to lose little by condensation. These results are such as may regularly be obtained in practice, and indeed it is not uncommon to find them excelled. Compound condensing engines of large size not infrequently

work down to 13 lbs. of steam, and triple expansion condensing engines down to 12 lbs., which result will be guaranteed by most responsible builders.

Unfortunately, engines employed for electrical work are comparatively seldom kept at uniform full load. Furthermore, they are subject to all sorts of variations of load. In electric railway service there are sudden changes from light loads to very heavy ones, while in electric lighting there is generally a gradual increase to the maximum load, which continues an hour or two, followed by a rather gradual decrease. These variations affect the economy of the engines unfavorably — at certain loads there is not enough expansion, at others decidedly too much. The variations in economy are largely controlled by the proportioning of the engine to its work. To say that an engine is of 500 HP means little unless the statement be coupled with a definite explanation of the circumstances. If that output is obtained by admitting steam for half the stroke, the engine will work at 500 HP very uneconomically, supposing a simple engine to be under consideration. Its point of maximum economy may be perhaps 300 HP. On the other hand, 500 HP may be given when cutting off the steam at one-fifth stroke. In this case the engine will be working near its point of maximum economy, and at 300 HP will require much more steam per IHP. It could give probably 600 to 700 HP at a longer cut-off, and is really a much more powerful engine than the first. For uniformity it is better to rate an engine at the HP of maximum economy, whatever the real load may be. The relation of load to economy is well shown in the curves of Fig. 187.

Curves 1, 2, 4, and 5, are of engines so rated as to have their maximum economy near full load. Curve 3, on the other hand, is from an engine intended to give its highest economy at about three-quarters load. For very variable output this is the preferable arrangement, while for large central station work, when the number of units is large enough to permit loading fully all that are running at any one time, it is better to have each unit give its very best economy near full load and to vary the number of units according to the requirements of total load.

For electric railway service under ordinary conditions, it is best to employ an engine which at full load is worked to a high capacity, and hence somewhat uneconomically, while at lesser loads, which more nearly correspond with the average conditions, its economy will be at a maximum. For electric lighting service it is preferable to have the point of maximum

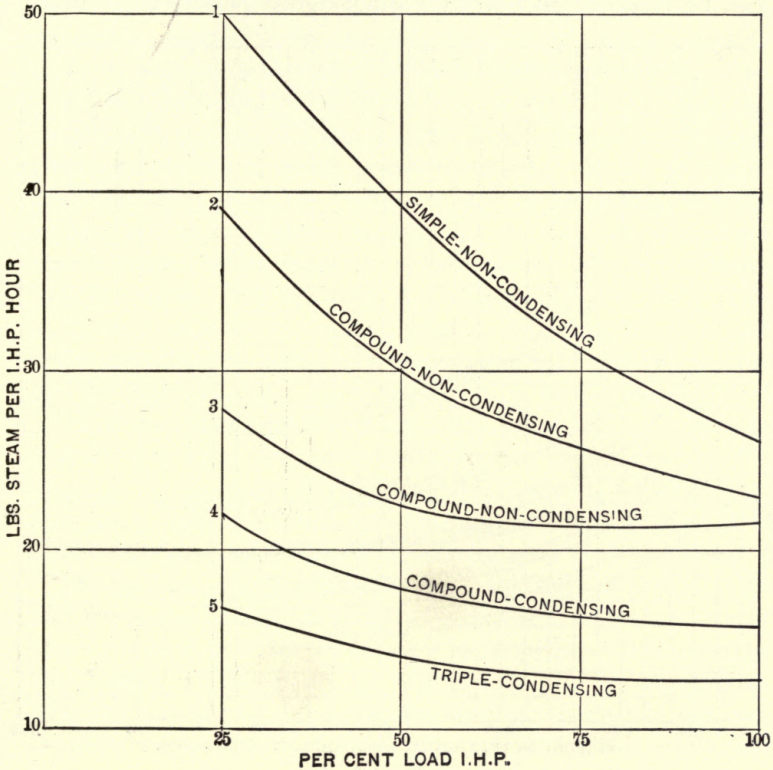

FIG. 187.

economy fall more nearly at full load. For power service, which is on the one hand more uniform than railway service, and less uniform than electric lighting work, it is probably best to employ an engine having characteristics between those just mentioned. In every case attention must be paid to the character of the load as regards average amount and constancy in the choice of an appropriate engine for the work.

In cases where the variations of load are likely to be very sudden, great mechanical strength of all the moving parts is absolutely necessary, and an attempt should be made in planning the power station to arrange the engine for its best economy at average load as nearly as this can be predicted.

With care in planning an electric power station the engines can be made to give an exceedingly good performance, much

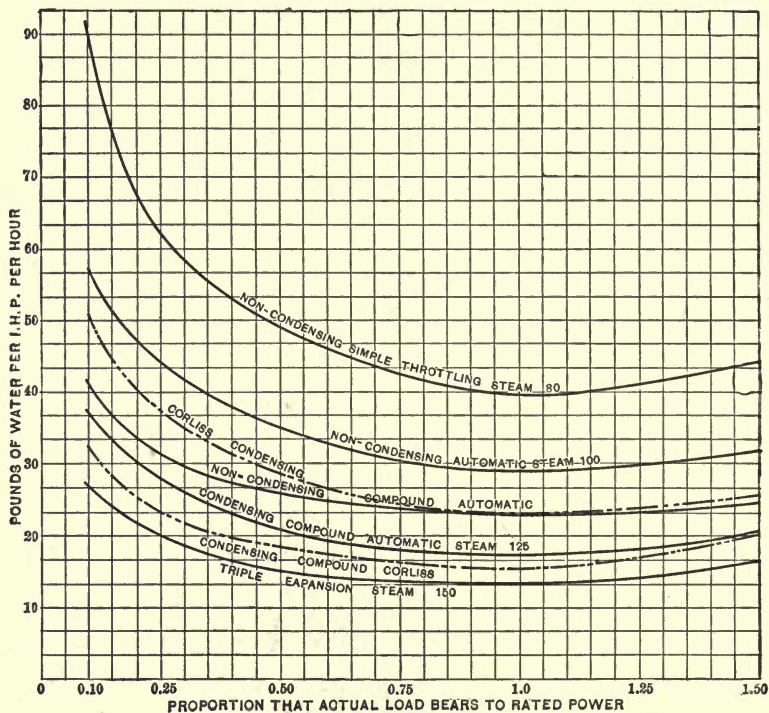

FIG. 188.

better than was considered possible a few years ago. Fig. 188 shows a set of curves from the experiments of Prof. R. C. Carpenter giving the performance of engines of different kinds over a wide range of loads, from mere friction load up to 50 per cent overload. The results are in pounds of water evaporated per indicated HPH. The immense advantage to be gained by using compound and triple expansion condensing

engines appears plainly from the curves. Another conspicuous fact is the great economy attained by such engines over a wide range of load. It is a common fallacy to suppose that while compound or triple expansion condensing engines are all well enough at steady load, simple engines have the advantage if the load varies over a wide range. The facts in the case as shown in Fig. 188 are exactly the reverse: not only do the high expansion engines have the advantage of the simple engines at their rated loads, but at all loads, and particularly light ones. And their advantage is so great that under any ordinary circumstances the use of a simple or a non-condensing engine for power generation is wilful waste of money. If the saving in first cost were great the mistake might be excusable, but the greater amount of steam required for running simple engines means larger boiler capacity, which nearly offsets the lower cost of engine. For example, a glance at Fig. 188 shows that a triple expansion condensing engine requires only half the boiler capacity demanded by a non-condensing automatic engine for the same output. In other words, if the former requires 500 HP in boilers, the latter will need 1,000 HP in boilers for exactly the same service. And the same holds true of the capacity of the stack, feed-pumps, steam-piping, water-piping, and, to a certain extent, even of the building, so that it is almost always poor economy to buy a cheap type of engine.

The greatest improvement in economy made in recent years has been the introduction of superheating which American engineers have been somewhat slow in adopting. This is simply the heating of the steam as such on its way to the engine. The steam prior to use is passed through a special reheater, frequently with an independent furnace, and given additional heat energy, the working temperature being thus raised sometimes to 600° or 700° F. This largely increases the range of working temperature possible to the engine, and hence the efficiency, at a relatively small expense for extra fuel.

The very high temperature of the steam compels extra precautions in the lubrication, and for some years this lubrication bug-a-boo stood in the way of substantial progress. At present it is entirely practicable to lubricate the cylinders successfully even up to the figures mentioned above, and

it is being done abroad though the prejudice in this country still persists. The results are startling, the steam consumption under test having repeatedly run down near and even below 10 lbs. of steam per IHP hour in compound condensing engines. The result of a recent test of a $21 \times 36 \times 36$ -inch mill engine are given in Fig. 189 and represent the highest efficiency yet attained. It will be noted that under the test conditions with steam superheated to $720^\circ - 750^\circ$ F. the steam consumption increased for the heavy loads just as it rises for overloads in the curves of Fig. 188. The fact in each instance merely implies that a certain amount of expansion corresponds to

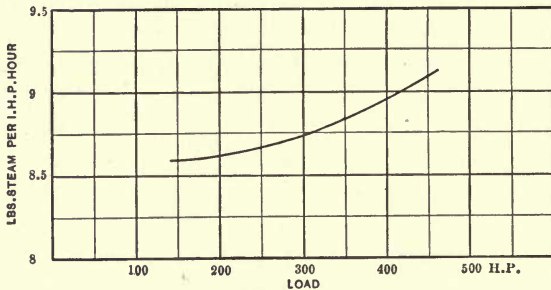

FIG. 189.

maximum economy, and less than this amount injures economy although it increases the possible output.

Fig. 189 is merely an extreme instance of the general principle, due to starting the expansion at a relatively very high temperature. There is no doubt whatever of the practicability of reducing steam expenditure 20 to 30 per cent below that found in the best current practice by an amount of superheating applicable without any considerable difficulty. Superheaters have already been introduced here as auxiliaries to steam turbines with pretty good effect, but have not yet come into more than occasional use for general purposes, and even so are very rarely worked for what they are really worth.

Large gas engines are beginning to come into use as prime movers for electrical purposes, and one such plant of 12,000 KW capacity is just being installed in San Francisco. The gas engine in large sizes shows very great thermal efficiency, giving the brake HP hour on the thermal equivalent of 1 lb.

of coal or even less, and is to-day becoming a formidable competitor of steam engines for many purposes. Working as it does from a very high initial temperature, its theoretical claim to efficiency is valid enough, and the difficulties of lubrication at the temperature involved have proved less serious than was first supposed. The main trouble is the fact that ordinarily only every fourth stroke is a working stroke, so that for a given number of impulses per revolution of the fly-wheel the gas engine becomes far more heavy and complex than the steam engine. Nevertheless, the gain in fuel economy is so valuable that the incentive to use gas engines is great. They are usually worked in the large sizes with natural or "producer" gas, sometimes with gas from the blast furnaces of the steel industry, in other words with cheap gas unsuited for illuminating purposes, and have the merit of being very quickly brought into action when required. Difficulties of governing, once serious, have now been in great measure eliminated.

Many blunders are made by being too hasty in buying engines for electric service, and not sufficiently studying the problem. For uniform loads the selection of the engines can be made easily. For variable loads it requires great astuteness and experience, nor is it safe to argue from experience based on other kinds of variable service. No engines can be subject to greater variations of load than are met in marine engines driving a ship in a high sea. If the screw rises from the water the whole load is thrown off, and resumed again with terrible violence when the screw is submerged. Nevertheless an engine, which is so arranged as to perform well under these trying circumstances, might perform badly when put on electric railway or power service, not because of its inability to stand the far less severe changes of load, but for the reason that the average load would be much further from its full capacity than in the case of marine practice. For large railway and power service it is best to use direct connected units, for the sake of compactness and economy. If a station is of sufficient magnitude to employ four or five 500 HP engines, direct connecting is advisable in nearly every case.

It has been said that such a plant has a lack of flexibility that is dangerous in case of sudden and great variations of

load. This is not true if the engines have been intelligently proportioned for the work they have to do, although in some cases there has been trouble due to the fact that the engines were ill-fitted to operate successfully under the changes of load to which they were subjected. As a matter of economy both in engines and dynamos, it is desirable to work direct coupled plants at a fairly high speed. There is no need of exaggerating the size of both engine and dynamo for the sake of running at 50 to 70 revolutions per minute, when equally good engines and dynamos of smaller size and less weight can be obtained by running at 90 to 120 revolutions or more. Much of the unwieldiness charged against large direct coupled units has been the result of yielding to the importunities of some engine builder who wanted to sell a very large machine, and putting in an engine and dynamo working at absurdly and unnecessarily low speed.

Electric power transmission, with a steam engine as the prime mover, is most likely to be developed in the direction of very large plants, to which these remarks apply most forcibly, particularly as in order to make transmission of power from a steam-operated station profitable, it is necessary to seek the very highest efficiency. Apart from the cost and inconvenience of very low speed units, it must be borne in mind that the mechanical efficiency of large low speed engines with heavy pistons and enormous fly-wheels, is lower than that of those designed for more reasonable speeds, which gives added reason for moderation in planning direct coupled units.

Throughout the design of a power station the probability of light loads must be considered. Not only does this have an important bearing on the economy of the engines, but it influences that of the boilers as well. The cost of operation depends on the coal consumption, and this in turn not only on the amount of steam that must be produced, but on the efficiency of its production.

There is, however, no classification of boilers on which one can safely rest in judging of their economy. There is much more difference in economy between a carefully fired and a badly fired boiler of the same kind, than there is between the best and the worst type of boiler in ordinary use. Boilers may

be generally divided into three classes: Shell boilers, in which the water is contained in a plain cylindrical tank heated on the outside; tubular boilers, in which there are one or many tubes running lengthwise of the boiler shell, and serving as channels for the heated gases from the fire; and water-tube boilers, in which the water is contained in a group of metallic tubes, around which the heat of the fire freely plays. In some tubular boilers the structure is vertical, with a furnace at the bottom, and the tubes are numerous and rather small, giving a large heating surface. Tubular boilers are also very often arranged horizontally, and in one very excellent and common type (return tubular), the flame and heated gasses pass horizontally under the boiler shell and then back through the tubes to the furnace end and thence upward into the stack. A typical water-tube boiler is shown in Fig. 190. Here the furnace is at the left of the cut and the stack at the right. The tubes are inclined as is usual in water-tube boilers, and steam space is secured by the drum above. Each class of boiler has nearly as many modifications as there are makers, most of them being with relation to the arrangement of the fire with respect to the boiler proper. Boilers are not altogether easy to compare on account of differences in rating. The usual HP rating is very vague, and does not in the least correspond with the performance, being based on steam pressure lower than is now normal. Specifications should demand actual evaporative capacity under the exact conditions of the proposed use, including, if the boilers are to be at times forced, the conditions then to be fulfilled.

As to the merits of the different classes, opinions differ very widely. It is clear from experience that the simple shell boiler is decidedly inferior to either of the others in economy, in spite of its simplicity and cheapness. Of late years it has been the fashion to employ water-tube boilers under all sorts of conditions, on account of their supposed great efficiency as steam producers, safety, and compactness. Purely experimental runs with such boilers often show phenomenal efficiency, but tests under working conditions sometimes re-

sult otherwise. It is important to note that not only does skill in firing produce a great improvement in boiler economy, but that by influencing the firing different kinds of coal give very different results quite independent of their theoretical value as fuel. The thermal value of coal, or other solid fuel, is almost directly as the proportion of carbon contained in it, and for comparative purposes boiler tests are generally reduced to evaporation of water from and at 212° F. per pound of combustible used, *i.e.*, per pound of carbon. However, the firing in different furnaces is differently affected by changes in

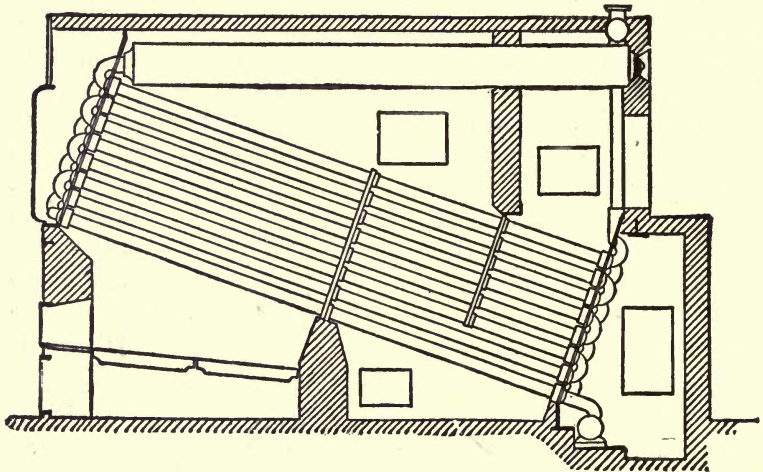

FIG. 190.

fuel, so that it is impossible to predict by tests on one boiler what a similar one will do under other conditions.

Altogether, the subject of boiler efficiency is a difficult and tangled one, since the conditions are constantly changing, and the best guide is found in the general result of a long series of tests rather than in theories of combustion. Forcing the output of a boiler usually injures its efficiency by compelling the combustion of an abnormal amount of coal for the grate surface of the furnace. It follows that a boiler is apt to be more efficient at moderate loads than at very high ones. In marine practice, boilers may sometimes have to be forced to a high output to save weight and space. In electric stations

it is sometimes better to force the boilers at the hours of heavy load, than to keep a relay of boilers banked in readiness for use, but except for this, the boilers, like the rest of the plant, should be worked as near their maximum efficiency as possible,

The best fuel to use is not at all invariably that of the highest thermal value, in fact with the proper furnace a grade of coal only moderately good is very often the most economical. In starting a steam plant of any kind comparative tests of various coals should generally be made, and are more than likely to pay for themselves many times over. In absolute heating value various kinds of fuel compare about as follows:

Kind of Fuel.	Heat of Combustion.	Evaporation.
Best anthracite.....	15,250	15.8
Welsh steam coal.....	14,500	15.0
Pocahontas.....	14,375	14.9
Cumberland.....	13,750	14.2
Coke, ordinary.....	12,750	13.2
Cape Breton.....	12,500	13.0
Lignite.....	11,750	12.2
Peat, dry.....	9,650	10.0
Wood, dry.....	7,250	7.5

The heat of combustion is per pound of fuel, and is given in thermal units, this unit being the heat required to raise 1 lb. of water 1° F.

The evaporation gives the pounds of water which can be evaporated from and at 212° F. by the complete utilization of the annexed heats of combustion. In other words, no more than 15 lbs. of water can possibly be evaporated by 1 lb. of coal of the thermal value of 14,500. Extravagant claims are sometimes made for patented boilers of strange and unusual kinds, so it is well to bear these figures in mind and to remember that you cannot evaporate more water than the figures indicate, any more than you can draw a gallon out of a quart bottle. In practice coal is likely to fall perhaps 10 per cent below the thermal values given above. Good boilers with careful firing will utilize from 70 to 75 per cent of the thermal value of the coal. Occasional experimental runs may give slightly higher figures, but only under very exceptional circumstances.

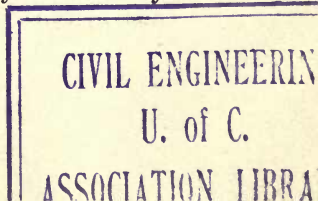

Now as to actual tests under boilers. Examinations of more than a hundred carefully conducted tests by various authorities show from 8 to 13 lbs. of water evaporated from and at 212° per pound of combustible. As average good steam coal contains from 8 to 15 per cent of ash and moisture, these results correspond to from 7 to 11½ lbs. of water per pound of coal. Now and then a single test gives a result a few hundredths of a pound better than 13 lbs. per pound of combustible, and an occasional poor boiler shows less than 8 lbs. Generally from 10 to 15 lbs. of coal are consumed per hour per square foot of grate surface. The following table gives a general idea of the results of boiler tests, good, bad, and indifferent.

Kind of Boiler.	Kind of Coal.	Evaporation.
Return tubular.....	Welsh steam.....	13.12
Water-tube.....	{ Bituminous, 3 parts } { pea and dust, 1 part }	13.01
Return tubular.....	Cumberland.....	12.47
Vertical tubular.....	Cumberland.....	12.29
Return tubular.....	Cumberland.....	12.07
Return tubular.....	Cumberland.....	12.03
Return tubular.....	Anthracite.....	11.63
Marine.....	Newcastle.....	11.44
Water-tube.....	Anthracite.....	11.31
Water-tube.....	Cumberland.....	10.98
Plain tubular.....	Anthracite.....	10.88
Water-tube.....	Cumberland.....	10.79
Marine.....	Welsh steam.....	10.44
Return tubular.....	Anthracite.....	10.43
Locomotive.....	Coke.....	10.39
Water-tube.....	Anthracite.....	10.00
Return tubular.....	Anthracite.....	9.55
Cylinder.....	Anthracite.....	9.22
Cylinder.....	Cumberland.....	8.74
Cylinder.....	Anthracite.....	8.44

The evaporation is per pound of combustible. The most striking feature of this table is the small difference in efficiency between the various kinds of boiler. Putting aside the cylindrical shell boilers, which are distinctly inferior to the others, it appears that in other types of boiler there is little to choose on the score of economy alone. The difference between the better and worse boilers of each class, due to difference of design, condition, and firing, is much greater than the differ-

ence between any two classes. Even the same boiler with different fuels, firing, or when in different condition, may give evaporative results varying by 30 per cent. Economy depends vastly more on careful firing and proper proportioning of the grate and heating surfaces to the fuel used, than upon the kind of boiler. In fact, judging from all the available tests, the differences between various types of boiler when properly proportioned are quite small.

The most that can be said is that plain shell boilers are decidedly inferior to the other forms, of which the horizontal return tubular and the water-tube have given slightly higher results than the others. Water-tube boilers are generally rather compact and stand forcing better than ordinary tubular boilers. They also are less likely to produce disastrous results if they explode. On the other hand, they are more expensive, and are as a class hard to keep in good condition, particularly if the water supply is not of good quality.

Probably under average conditions a well-designed horizontal return tubular boiler will give as great evaporative efficiency as can regularly be attained in service, and the choice between it and a water-tube boiler is chiefly in economy of space and capacity for forcing. There is no excuse for the explosion of any properly cared for boiler.

The actual evaporation secured per pound of total fuel is something quite different from the figures in the table just given. In the first place, allowance must be made for ash and fuel used for banking the fires. In the second place, in regular running the firing is seldom as careful as in tests.

On account of these the evaporations per pound of combustible given in the table must be reduced from 15 to 20 per cent to correct the result to pounds of coal used in actual service.

Ten pounds of water or over, evaporated from and at 212° per pound of total fuel may be regarded as exceptionally good practice in every-day work. Nine to 10 lbs. under the same conditions represents fine average results, and 8 to 9 lbs. is much more common. In fact, 8 lbs. is an unpleasantly frequent figure, particularly in boilers operated under variable load, such as is generally found in electric plants of moderate size. All these

facts point out the necessity of thorough and careful work in every part of a power plant. Bad design or careless operation anywhere plays havoc with economy. In most instances far too little attention is paid to the adaptation of the furnace to the particular fuel used. In case of attempting power transmission from cheap coal at or near the mines, the furnace and firing problem is of fundamental importance. Most furnaces are constructed to meet the requirements of high grade fuel and are quite likely to work badly with anything else. In transmitting power from cheap coal the grate surface, draft, and so forth must be carefully arranged with reference to the grade of fuel to be used and not with reference to standard coals used elsewhere. The methods of firing, too, require careful attention.

At the present time mechanical stokers are in very extensive use in some parts of the country. The reports from them are of varying nature, but the consensus of opinion seems to be that they are very advantageous in working medium and low grade coals, but of less utility in the case of high grade coals. They are somewhat expensive and require intelligent care now and then like all other machinery, but when it comes to firing large amounts of cheap fuel at a fairly regular rate they do most excellent work. When coal is dear, careful hand firing is probably more economical than any mechanical method. With first-class coal and boilers one good fireman and a coal-passer can take care of 2,000 KW in modern apparatus, so that the total cost of firing is not a very serious matter. A poor fireman is dear at any price, and quite as disadvantageous to the station as a poor engineer.

Kind of Engine.	Coal per IHP Hour.	
	Condensing.	Non-Condensing.
Simple, dependent valve.....	2.77	3.66
Simple, independent valve.....	2.33	3.11
Compound, dependent valve.....	2.22	2.66
Compound, independent valve.....	2.00	2.44
Triple, dependent valve.....	1.88	
Triple, independent valve.....	1.66	
Triple, independent valve large.....	1.44	

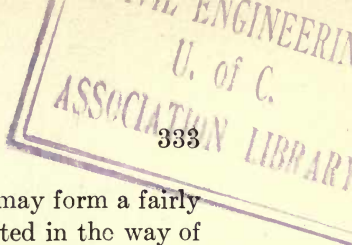

Reverting now to engine performances, we may form a fairly definite idea of what may ordinarily be expected in the way of coal consumption per indicated horse-power hour.

The foregoing table shows the coal consumption of the various kinds of engines, based on the burning of 1 lb. of coal for each 9 lbs. of feed water used. Although greater evaporation can often be obtained, 9 lbs. of water per pound of coal is a very good performance indeed, decidedly better than is found in general experience. It presupposes good boilers, good coal, and skilful firing, such as one has a right to expect in a large power plant.

The figures apply only to engines of several hundred HP, at or near their points of maximum economy, and operated from a first-class boiler plant.

They can be and are reached in regular working, and are sometimes exceeded. A combination of great efficiency at the boilers and small steam consumption in the engine sometimes gives remarkable results. The best triple expansion condensing engines worked under favorable conditions can be counted on to do a little better than 1.5 lbs. of coal per IHP hour, occasionally even in the neighborhood of 1.25 lbs. Even with compound condensing engines, tests are now and then recorded, showing below 1.5 lbs. of coal per IHP hour. But these very low figures are the result of the concurrence of divers very favorable conditions, and those just tabulated are as good as one should ordinarily expect. It must not be supposed that the weight of coal used per HP hour necessarily determines the economy of the plant. The cost of fuel of course varies greatly, and its price in the market is by no means proportional to its thermal value. As a rule, the coals which give the best economic results are not those of the greatest intrinsic heating power. On the contrary, dollar for dollar, the best results are very frequently obtained from cheap coal, or mixtures of inferior coal with a portion of a better grade. Hence, the boilers of a plant which is a model of economy may show an evaporation of only 7 or 8 lbs. of water per pound of coal. Boiler tests with the conditions of economy in view are of great importance, and are likely to pay for themselves tenfold in even a few months of operation.

A word here about fuel oil. Petroleum has, weight for weight, much greater heating power than coal. Its heat of combustion is about 20,000 to 21,000 thermal units, it costs little to handle and fire, leaves no ash and refuse to be taken care of, produces little smoke, and is generally cleanly and convenient.

It has been thoroughly tried by some of the largest electrical companies in this country, and at moderate prices, a dollar a barrel or less, is capable of competing on fairly even terms with coal. But experience has shown some curious facts about its performance. The amount of steam or equivalent power required to inject and vaporize the oil in one of the most skilfully handled plants in existence amounts to no less than $7\frac{1}{2}$ per cent of the total steam produced. And curiously enough, the cost of oil for firing up a fresh boiler, and the time consumed, compare unfavorably with the results obtained from coal. In spite of the great amount of heat evolved from fuel oil, it appears to be less effective than coal in giving up this heat to the boiler by radiation and convection. There is good reason to believe that more than half the total heat of combustion of incandescent fuel is given off as radiant heat, and most of the remainder is of course transferred by convection both of heated particles of carbon and of molecules of gas.

It is not unlikely, therefore, that a petroleum fire with its small radiating power and comparative absence of incandescent particles, fails in economy through inability to give up its heat readily. This view of the case is borne out by the facts above cited and by the abnormally high temperature of the escaping gases often found in boiler tests with petroleum fuel. At all events it is clear from such tests that the evaporation obtained from fuel oil is not so great as would be expected from its immense heat of combustion, and unless at an exceptionally low price, its use is less economical than that of coal.

The most striking innovation of recent years in the generation of mechanical power by steam is the development of the steam turbine. Year by year during the past decade it has slowly grown from experiment to realization, until at the pres-

ent time it has reached a position that demands for it most serious consideration. It looks very much as if, for many purposes, the reciprocating steam engine might be hard pushed.

Strangely enough the steam turbine or impulse wheel is the earliest recorded form of steam engine, dating clear back to Hero of Alexandria, who flourished about 130 B.C. The engine which Hero suggested was merely a philosophical toy, and it took nineteen centuries beyond his day to produce any engine that was not a toy, but now after two thousand years Hero's idea has borne fruit.

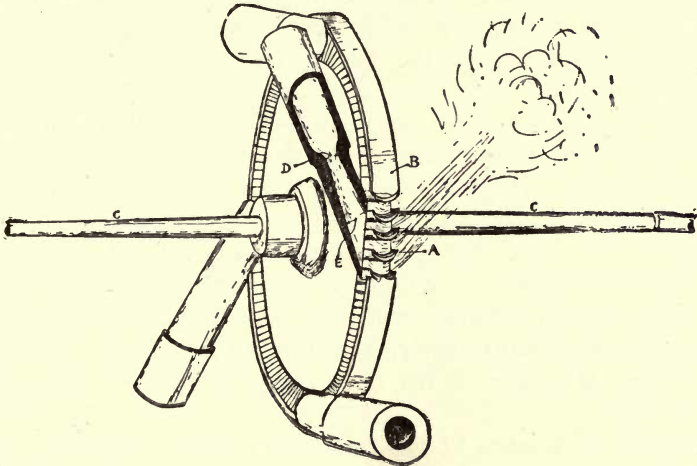

FIG. 191.

The fundamental principle of the steam turbine is just that of the water turbine — directing fluid pressure against a series of rotating buckets. The first practical steam turbine, devised by De Laval, is very closely akin to the Pelton water-wheel and to the little water-motors sometimes attached to faucets for furnishing a small amount of power. The essential features of his apparatus are well shown in Fig. 191. It consists of a narrow wheel *A* with buckets around its periphery, revolving within a housing *B* and supported by a rather long and slender shaft. Bearing upon the buckets at an acute lateral angle is the steam jet *E*, in this case one of three equidistant jets playing on the same wheel. To obtain the most efficient

working of the jet the steam nozzle is somewhat contracted at *D*, a little way back from the buckets. The steam is discharged on the other side of the wheel as shown. It strikes the buckets as a jet at great velocity, and should, if the conditions were just right, expend nearly all its energy in driving the wheel and should itself leave it at or near zero velocity. Of course this condition does not hold in practice, but still a steam turbine of this De Laval construction is capable of doing marvellously well. The main objection to this form is the enormously high rotative speeds necessary for efficient running. Here, as in hydraulic impulse wheels, the peripheral velocity should be about one-half the spouting velocity of the fluid. With high pressure steam this is, when one works the turbine condensing, 3,000 to 5,000 feet per second. In practice these De Laval wheels have usually been geared to a driving shaft, but the wheel itself has run at 10,000 to 30,000 r.p.m., seldom below the former figure even in large sizes. But the economy reached has sometimes been very high, as in some tests a few years ago in France, when, with an initial pressure of 192 lbs., a 300 HP turbine showed a steam consumption of only 13.92 lbs. per *effective* HPH — a figure seldom reached with engines. The governing is by throttling the steam supply in response to the movement of a fly-ball governor of the kind generally familiar in steam engineering.

The inconvenience of the very high rotative speed of such turbines has led to the development of forms working more along the lines of hydraulic turbines, of which by far the best known is the Parsons turbine, which has recently made so striking a record in marine work, having been applied to several British torpedo-boats and even to larger vessels. In this remarkable machine the passage of the steam is parallel to the axis of rotation instead of tangential, and its hydraulic prototype is the parallel-flow pressure turbine, shown in diagram in Fig. 200. In fact the steam is passed successively through a large number of such parallel-flow turbines, gradually expanding and giving up its energy to the successive runners located, of course, on the same shaft. The course of the expanding steam is well shown in Fig. 192, which gives in diagram its progression through four sets of vanes, two, 1 and 3, being

rings of guide blades, and the others, 2 and 4, rings of runner blades. The steam, starting at pressure P , expands successively to P_i , P_{ii} , P_{iii} , P_{iv} , expanding sharply against the runner blades and giving them a reactive kick as it leaves. In this case the steam velocity against, say the runner blades 2, is not, as in the De Laval form, the full spouting velocity due to the initial head of steam, but merely that corresponding to the differential pressure $P - P_i$. This enables the peripheral speed of the runner to be kept within reasonable limits without violating the conditions of economy, but the turbine at best is not a slow-speed machine.

Fig. 193 is a longitudinal section through the Parsons type of steam turbine as developed in this country by the

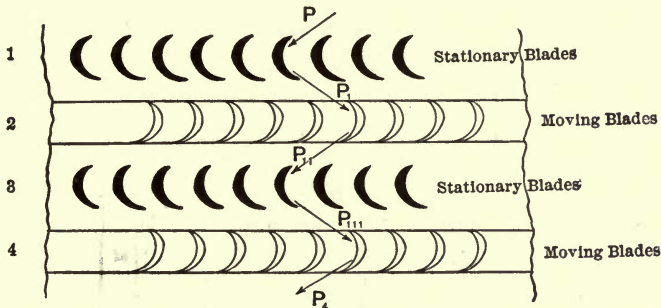

FIG. 192.

Westinghouse Machine Co. The steam enters from the supply pipe controlled by the governor and comes first into the annular chamber A at the extreme left-hand end of the runner. The runner blades are graduated in size so that the expanding steam may give nearly a uniform useful pressure per blade, and to this end the diameter of the runner hub is twice increased as the steam expands towards the exhaust chamber B . The endwise thrust of the steam entering the turbine from A is balanced by its equal pressure on the balancing piston C , which revolves with the runner. To the left of this is an annular steam space and a second balance piston C . Now, when the expanding steam has passed the first section of the runner into the steam space E , it can flow back through the channel F and the post D against this second balance piston.

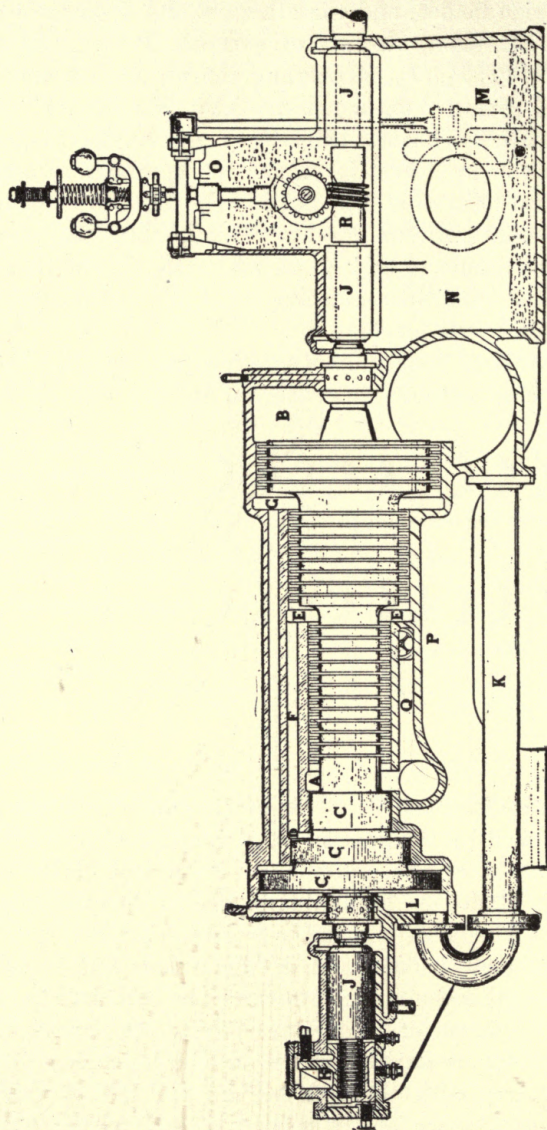

FIG. 193.

Still further to the left is a second steam space and a third piston *C*, which is similarly exposed to the pressure from *G*, where the third stage of expansion begins. The effect of this

balancing system is to render the end thrust negligible whatever may be the ratio of expansion in the turbine. A thrust bearing at *H* keeps the working parts positioned and takes up the trivial thrusts which may incidentally be present. *J, J, J* are the bearings, which are out of the ordinary in that within the gun-metal sleeve that forms the bearing proper are three concentric sleeves fitting loosely. The clearance between them fills with oil, cushioning the bearings. Now if the runner is not absolutely in balance there is a certain flexibility in the bearings so that the runner can rotate about its centre of gravity instead of its geometrical centre, thus stopping vibration. An equivalent expedient is found in the De Laval turbine, the shaft of which is deliberately made slightly flexible so that it may take up rotation about its centre of gravity. *K* is a pipe which again takes up the work of keeping the pressure balanced by connecting the exhaust chamber *B* with the steam space behind the last balance piston. At *M* is a simple oil pump taking oil from the drip tank *N* and lifting it to the tank *O*, whence it is distributed to the bearings. A by pass valve *P* turns high pressure steam directly into the steam space *E*, in case a very heavy load must be carried, or a condensing turbine temporarily run non-condensing. *R* is a flexible coupling for the driving shaft, and at that point too is the worm gear that drives the governor. The governor in its operation is somewhat peculiar. Instead of throttling the steam supply so as to reduce the effective pressure, the steam is always sent to the turbine at full boiler pressure, but discontinuously. The main steam valve is controlled by a little steam relay valve which is given a regular oscillatory motion by a lever driven from an eccentric. The steam is thus admitted to the turbine in a series of periodic puffs. Now the fulcrum of this valve lever is movable and is positioned by the fly-ball governor, so that the position of the valve with relation to the port is varied without changing the rate or amplitude of the valve motion. Hence the length of the puffs is changed so that while at full load steam is on during most of the period, at light load it is on for only a small part of each period. This is well shown graphically by Fig. 194, which is self-explanatory.

The governor balls are so arranged that they work both ways, their mid-position corresponding to full admission of steam, so that a violent overload can be made to shut off steam, and a break in the governor driving gear will do the same instead of letting the turbine run away.

These turbines are capable of operating with really remarkable efficiency. Fig. 195, from the makers' tests, gives the performance, both condensing and non-condensing, of a Westinghouse-Parsons turbine directly coupled to a 300 KW quarter-phase alternator giving 440 volts at 60~, the speed being 3,600 r.p.m. Operated condensing, the steam consumption

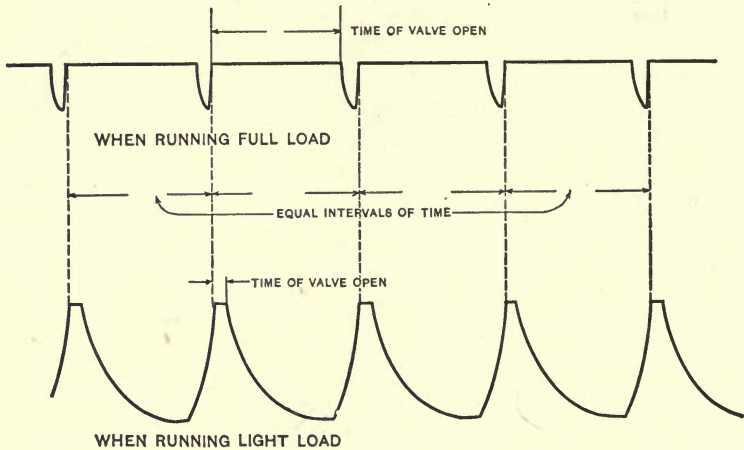

FIG. 194.

at full load falls to about 16.4 lbs. per *electrical* HPH, and is below 20 lbs. from 125 HP up. This extraordinary uniformity of performance at large and small loads is mainly due to the very small frictional losses in the turbine, although it is helped, perhaps, by the load curve of the generator. The results when working non-condensing are very much inferior to these, relatively worse than in an ordinary steam engine.

Altogether it is an admirable showing for the steam turbine. The writer believes Fig. 195 to be entirely trustworthy, as it corresponds very closely with certain independent tests now in his possession, from another turbine of the same capacity and speed, in which tests the makers of the turbine had no

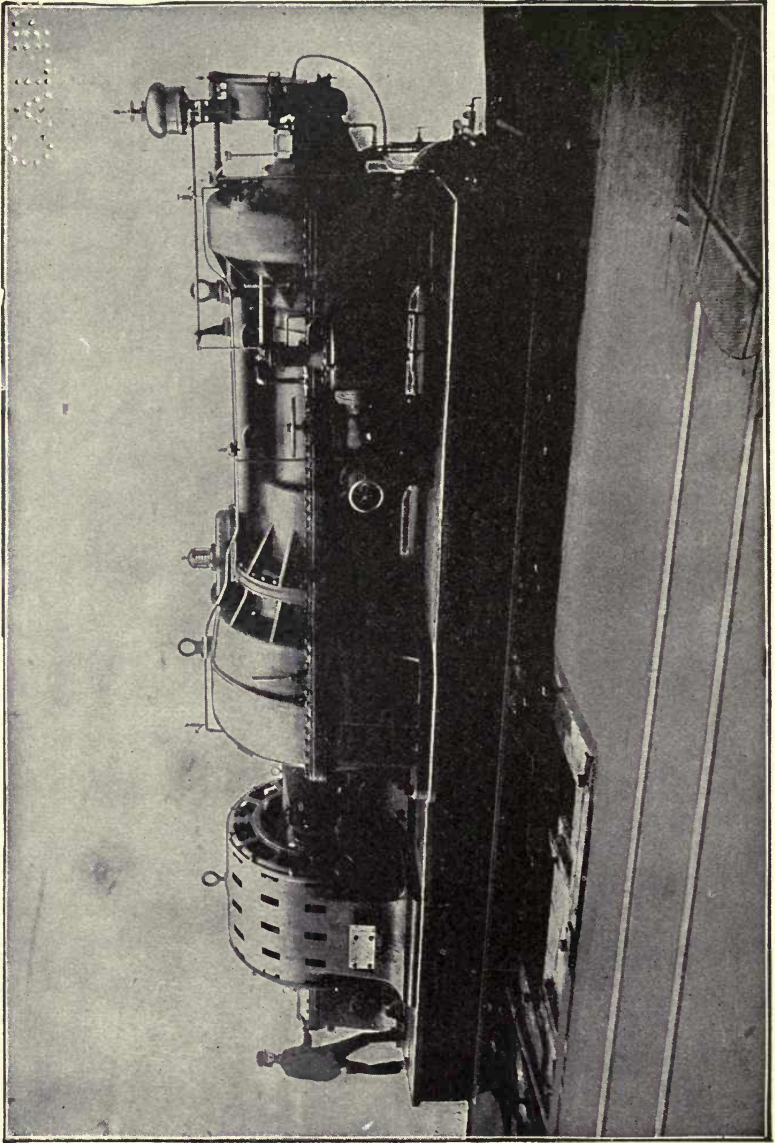

PLATE XI.

part. The substance of the matter is that the steam turbine will work just about as efficiently as a first-class compound condensing engine, and can not only be more cheaply made, but takes up much less room. In the same way, for electrical purposes a directly connected generating set with steam turbine is, or ought to be, much cheaper and smaller than those now in use, while retaining equally high efficiency. High rotative speed is by far the cheapest way of getting out-

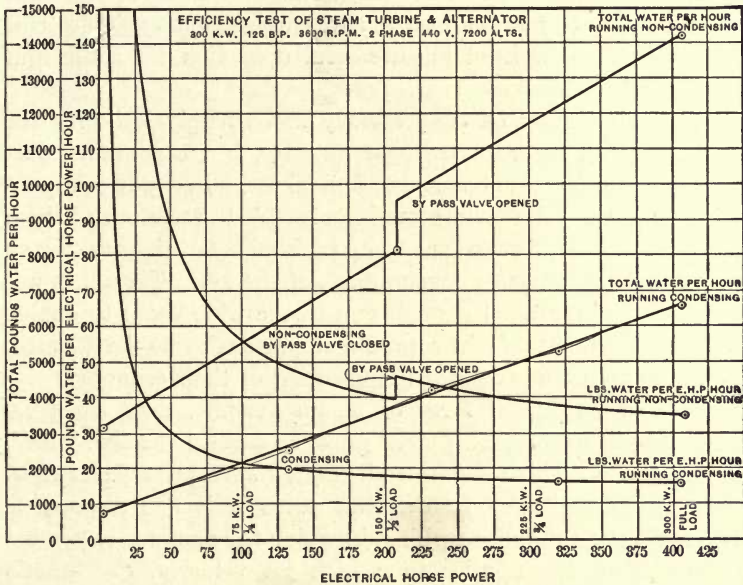

FIG. 195.

put, and when, as in this case, no heavy reciprocating parts are involved, there is no good reason for objecting to high speed. The present fashion for low speed dynamos is largely a fad, having its origin in direct coupling to Corliss engines, and with the modern stationary armature construction there is no reason why high rotative speed should not be used, at least in alternators.

In Plate XI is shown the first large turbine-driven generator installed for regular commercial service in this country. Smaller ones had been in use in isolated plants for some time, but

this 1,500 KW set, installed for the Hartford Electric Light Co., was the first important installation of this kind. The turbine is designed for a maximum output of 3,000 HP at a speed of 1,200 r.p.m., and the complete set, weighing only 175,000 lbs., takes a floor space of but 33' 3" \times 8' 9". The generator is a quarter-phase machine at 60~ frequency. This outfit should be capable of giving an efficiency rather better than that shown in Fig. 195 — probably less than 15 lbs. of steam per electrical HPH at steady full load; in other words, it should do nearly as well as a triple expansion engine. This machine has now been in successful operation for some four years.

Alternators may be conveniently and cheaply built for the speed implied in steam turbine practice, but continuous current generators involve some difficulties. For power transmission work turbo-generators have much to recommend them as auxiliaries, and there is a strong probability of their taking an important place in the development of the art. There has not yet been accumulated enough experience with them to enable a final judgment of their practical properties to be formed, or to justify an unqualified indorsement of their economy.

Another successful form of steam turbine, now considerably used in units of output as great as several thousand KW, is the Curtis, which differs radically in several respects from that just described. In the first place it is not a pressure turbine but an impulse turbine, in which the steam is expanded in the admission nozzles to a high jet velocity, the kinetic energy of which is then utilized in the runner buckets. It is thus dynamically more akin to the De Laval than to the Parsons turbine, but differs from it much as a true impulse turbine differs from a Pelton wheel.

In the second place it is regularly built in all the larger sizes as a vertical shaft machine carrying the generator armature on its upper end and being supported below by an ingeniously contrived water step kept afloat by a pressure pump. In the Curtis turbine, however, the expansion takes place not in a single nozzle as in the De Laval type but in several successive stages so that the jet velocity and with it the necessary peripheral speed is very considerably reduced. Fig. 196

shows the course of the steam and is almost self-explanatory. The upper section is the first stage, the lower the second stage, and in some of the larger units three or four stages are used. Their effect is akin to that of compounding an engine in the better temperature distribution and proportioning of parts.

The governing in this turbine is exactly in line with the prin-

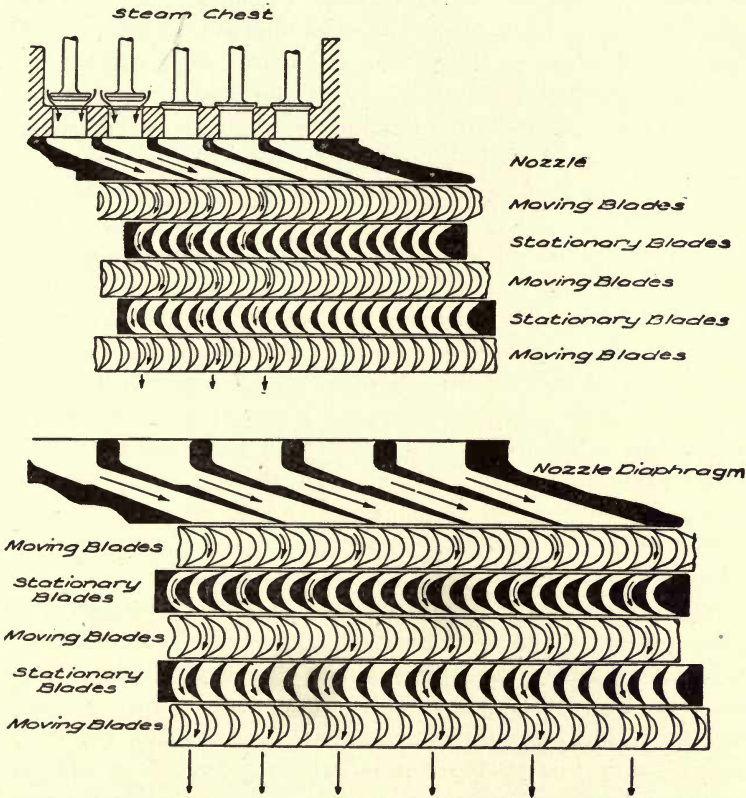

FIG. 196.

ciples of hydraulic impulse turbines; the numerous admission nozzles being fitted with independent valves as shown in the cut. These are in succession opened or closed in accordance with the requirements of the load, by the action of a sensitive fly-ball governor which controls a series of relay valves, in turn working the admission valves. In the earlier and some of

the later turbines these relay valves have been electrically actuated, but at present both this and purely mechanical control are used. As each admission valve is either fully open or closed there is no throttling of the steam, which gives a material gain in efficiency.

Plate XII shows a 500 KW Curtis turbo-generator which is peculiarly interesting as being a direct current machine designed for railway purposes. The rotative speed is 1,800 r.p.m., but in spite of this, the problem of commutation has been successfully met. In this, as in all the large Curtis turbines, there is but one supporting bearing on which the moving parts spin top fashion kept in line by a pair of small guide bearings. The structure is thus wonderfully compact, but it is still an open question among engineers as to the advisability of a vertical shaft. It gains a little in friction and a certain amount in space together with immunity from flexure of shaft, while on the other hand it loses greatly in accessibility, and exposes the generator portion to certain risks from heat, steam, and oil that are not altogether negligible. From a practical standpoint the Curtis turbine has made a good record, and many large units, even up to 5,000 KW, are in successful use, to no small extent in large stations designed for railway service, polyphase current being generated and transmitted to converter stations. The large polyphase turbo-generators are all of the vertical type closely resembling Plate XII.

The strong points of steam turbines are cheapness for a given output, economy of floor space, freedom from vibration, uniform efficiency at various loads, and light friction. Of these the first is the direct result of high speed both in turbine and generator. For some years there was a strong tendency toward very low engine speeds, which produced generating units of needlessly great weight and cost. The turbine goes to the other extreme of speed, and while it runs at speed too high for the most economical construction, can be built including the generator at a cost probably below that of any other direct connected unit. The current price is relatively high, being adjusted to that determined by engines, but this condition is of course temporary. Economy of floor space is very marked, especially in the vertical shaft type, but it

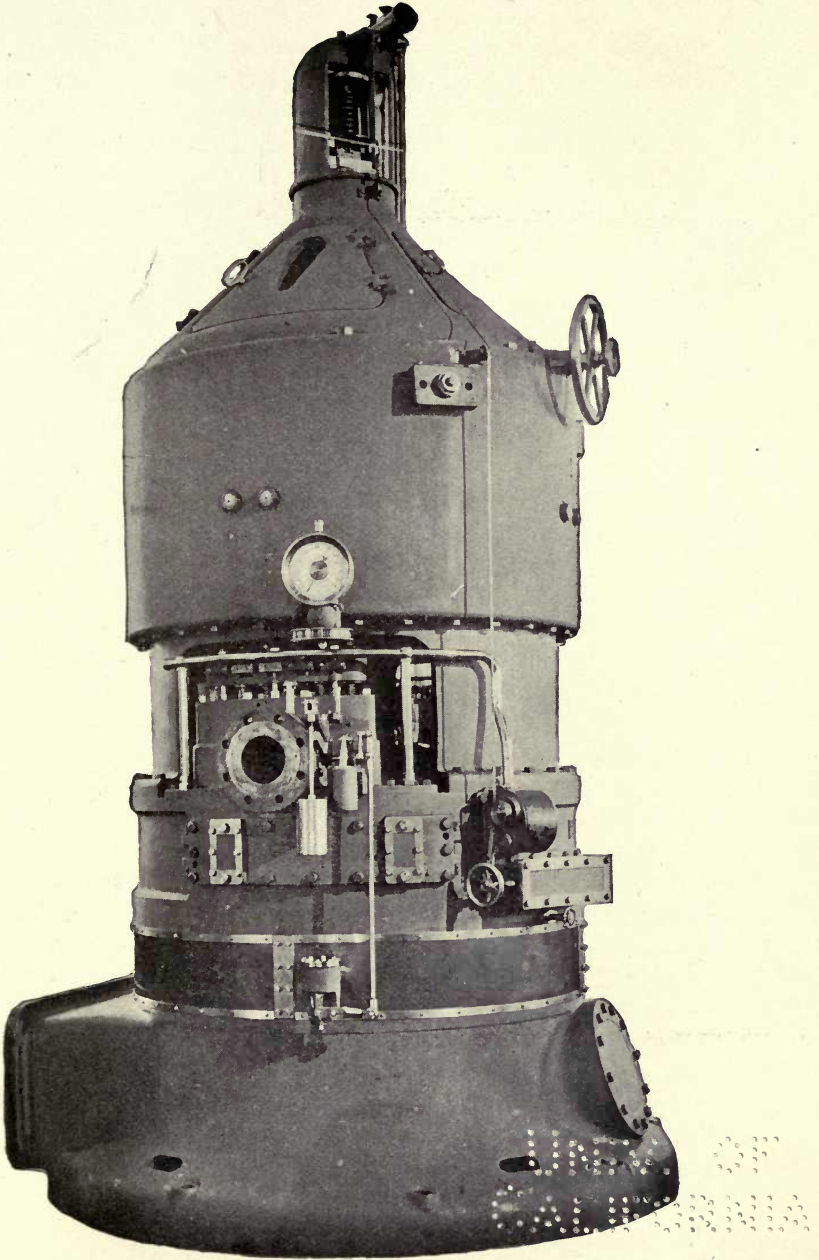

PLATE XII.

Small, faint, illegible markings or text located in the lower-left quadrant of the page.

Small, faint, illegible markings or text located in the lower-right quadrant of the page.

actually is much less than at first appears, since the location of the boilers generally determines the area of the plant, and turbines cannot conveniently be huddled into the space which their dimensions would suggest. They are remarkably free from vibration, due to the necessity of avoiding centrifugal strains by extremely careful balancing, and their friction is very light indeed. The uniform economy at various loads is partly due to small friction and partly to the fact that the expansion of the steam is substantially fixed by the construction and does not vary materially with the load. Nevertheless, as has already been shown, an engine properly designed for varying load will show at least equally good practical results. Compare in this the lowest curve of Fig. 186, and Fig. 195, to say nothing of Fig. 187.

The actual efficiency of the steam turbine is good without being in any way phenomenal. At equal steam pressure, superheat, and vacuum, the steam turbine, in its present stage of development, is as a rule slightly less efficient per brake horsepower than a first-class compound condensing engine. Turbines, however, suffer extremely, like other engines in which there is very great expansion, from diminished vacuum and only by using a vacuum of 28" and 100° to 150° F. superheating, can they be brought up to a performance equivalent to a compound condensing engine.

Very recently turbines carrying the expansion to as many as five stages have been introduced, and from large units of this construction it has been possible to secure economy comparable with that of first-class triple expansion engines and far surpassing that shown by the earlier turbines here described.

As a practical matter, however, one can very comfortably stand some loss in efficiency if thereby the fixed charges and maintenance can be kept down. The greater the necessary proportion of such items, the more complacently can one stand a slight loss in steam economy. In the case of engines which from the conditions of their use give a rather small annual output for their capacity, reduction of fixed charges and maintenance is of great importance. Hence for auxiliary plants in power transmission which are idle a large part of the time, there is a great deal to be said for the turbo-generator if

it can be had at a reasonable figure. It can also be put into action more quickly than ordinary engines, and handles heavy overloads well beside running easily in parallel by reason of the uniform rotative effort.

Considerable space has here been given to describing some of the details of steam turbines, in the belief that they are of

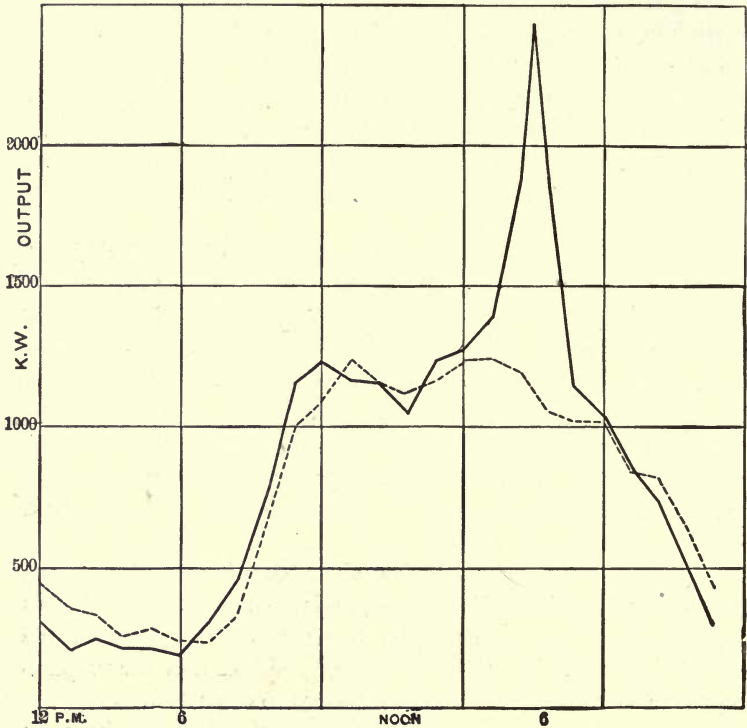

FIG. 197.

sufficient importance to warrant it even in a chapter not intended to be in the least a compendium of steam practice, but a mere outline of the essential facts. They certainly have already proved their right to a place, and the question is now merely that of the probable limitations of their usefulness, which only protracted experience can disclose.

For an electrical power station operated by steam power the vital economical question is the cost of fuel per kilowatt hour,

rather than the performance of engines and boilers alone. This final result involves the performance of the station apparatus under varying loads, too frequently rather light, and, implicitly, the skill of the operator in keeping his apparatus actually running as near its point of maximum economy as possible, in spite of changes in the electrical output. This personal element forbids a reduction of the facts to general laws, but a concrete example will be of service in showing what may be expected in a well-designed and well-operated power plant. Fig. 197 shows a pair of "load lines," from a large and particularly well-operated power plant. The solid line shows

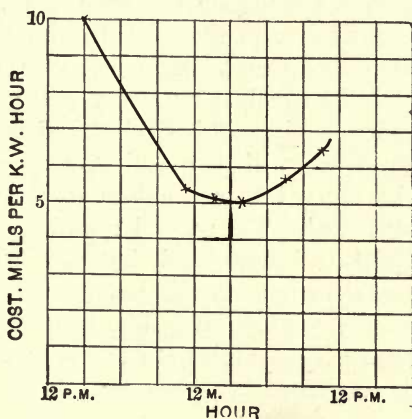

FIG. 198.

the variations of load throughout a day in the latter end of January, and the broken line the variations of load during a day early in April.

The early darkness of a winter's day is very obvious in the former line. The station carries in addition to lights a heavy motor service that keeps up a fairly uniform load throughout the day, until the sudden call for lights in the early evening. The load factor shown by the solid line is .35 (*i.e.*, this is the ratio between maximum and average load). The second load line gives a much better relation between these quantities, the load factor being .64, which is quite usual in this station during the spring and summer. Of course every effort is exerted to keep the machines which are in use as fully

loaded as possible. In spite of this the small output during the early morning hours, coupled with the losses due to circulating pumps and other minor machinery, and the fuel used for banking and starting fires, brings the cost of fuel during this period far above the average for the day. The curve in Fig. 198 shows roughly the variation in the cost of fuel per KW-hour throughout the day, taken from the average of a number of tests. As the fuel cost in a large central station is a considerable portion of the total expense, it is evident that the result is an excellent one. During all the hours of heavy load the cost of fuel is less than six-tenths of a cent per KW-hour, and the total cost of production but little more. This result will give an excellent idea of the cost of generating power on a large scale with cheap coal. It is, however, exceptionally good, and can only be equalled by a very well managed plant with the best modern equipment both electrical and mechanical.

Of course the expenses of distribution, administration, and the like must be taken into account in considering the cost per KW hour delivered. The general question of station expenses cannot be here investigated, but this brief digression gives some idea of the necessary relation between the character of the work and the commercial results in generating electric power on a large scale, so far as the use of steam engines as prime movers is concerned.

CHAPTER IX.

WATER-WHEELS.

THE importance of the development of water-powers for electrical purposes we have already come fully to realize. The lessons of the last few years have been exceedingly valuable ones, and it is safe to say that the utilization of water-powers for electrical transmission will be kept up until every one which is capable of commercially successful development is worked to its utmost capacity. In spite of the length of time that water-wheels of various sorts have been used, it is only very recently that these prime movers have been brought to a stage of development that renders them satisfactory for electrical purposes. The old water-wheel was even more troublesome as a source of electrical power than the old slide valve steam engine.

The customary classification of water-wheels for many years has been into overshot, undershot, and breast-wheels, and finally turbines. Various modifications of all these have, of course, been proposed and used. Of these classes, the first three may be passed over completely as having no importance whatever in electrical matters, save in certain modifications so different from the original wheel as to be scarcely recognizable. To all intents and purposes they are never used for the purpose of driving dynamos, although occasionally an isolated instance appears on a very small scale.

It is the turbine water-wheel which has made modern hydraulic developments possible, and more particularly electrical developments. The turbine practically dates from 1827, when Fourneyron installed the first examples in France, although it is interesting to know that a United States patent of 1804 shows a wheel of somewhat similar description, never so far as is known used. The modern turbine consists of two distinct parts, the system of guide blades and the runner. The runner is the working part of the wheel, and consists of a

series of curved buckets so shaped as to receive the water with as little shock as practicable, and to reject it only after having utilized substantially all of its energy. These buckets are arranged in almost every imaginable way around the axis of the runner, but always symmetrically.

Sometimes the curvature of the buckets is such that the water after having passed through them leaves the wheel parallel to its axis; sometimes so that the water flows inward and is discharged at the centre of the runner; sometimes so that it passes outward and is discharged at the periphery.

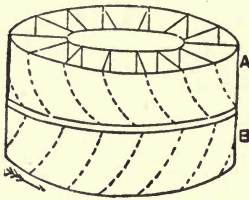

FIG. 199.

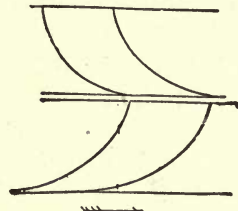

FIG. 200.

More often the buckets have a double curvature so that the water flows along the axis and at the same time either inwardly or outwardly. It is not unusual, moreover, to have two sets of buckets on the same shaft for various purposes. The growth of the art of turbine building has made any classification of turbines depending on the direction of the flow of the water very uncertain, as in nearly every American turbine this flow takes place in more than one general direction, usually inward and downward. Aside from the runner the essential feature of the modern turbine is the set of guide blades which surround the runner, and which are so curved as to deliver the water fairly to the buckets in such direction as will enable it to do the most good. Accordingly these blades are curved in all sorts of ways, according to the way in which the water is intended to be utilized.

Fig. 199, taken from Rankine, shows a species of idealized turbine which discloses the principles very clearly. In this figure *A* is the guide blade system and *B* the runner. The flow is entirely along the axis, forming the so-called parallel flow turbine, a form not in general use in America.

Fig. 200 shows the sort of curvature which is given to the guide blades and to the buckets of the runner. The axis of this or any other kind of turbine may be horizontal or vertical, as convenience dictates. As may be judged from the illustration, the water acts on the runner with a steady pressure, and the buckets of the runner are always filled with the water which drives them forward. Working in this way by water pressure due to the weight of the water column, it is not necessary that the turbine should be placed at the extreme bottom of the fall, provided an air-tight casing is continued below the runner so as to take advantage of the solid water column below the turbine. Such an arrangement is called a draft tube, and may be of any length up to the full column which may be supported by atmospheric pressure, provided the body of water shall be continuous so that there shall be no loss of head due to the drop of the water from the wheel to the level of the water in the tail-race. It is as if the column below were pulling and the column above pushing, the runner being in a solid stream extending from the highest to the lowest level of water used. As a matter of practice the draft tube is generally made considerably shorter than the column of water which might be supported by atmospheric pressure, generally less than 20 feet, depending somewhat on the size of the wheel. With longer tubes it is difficult to preserve a continuous column, which is necessary in order to utilize the full power of the water.

Nearly all American turbines are of this so-called "pressure" type. There is, however, another type of turbine wheel used somewhat extensively abroad, and occasionally manufactured in this country, which without any very great change in character of the structure operates on an entirely different principle. There are present, as before, guide blades delivering the water to the buckets of the runner, but the spaces between these blades are so shaped and contracted as to deliver the water to the runner as a powerful jet. The energy of water pressure is converted into the kinetic energy of the spouting jet, and the buckets of the runner are not filled solidly and smoothly with the water, but serve to absorb the kinetic energy of the jets, and discharge the water below at a very

low velocity. Such turbines are known as impulse turbines, from the character of their action. In the pressure turbines the full water pressure acts in the runner and in the space between the guides and the runner. In the pressure turbine each space between the guide blades acts so as to form a water jet, which impinges fairly on the bucket of the runner without causing a uniform pressure either throughout the bucket spaces or in the space between runner and guides. It is not intended that the passages of the wheel should be, as in the pressure turbine, entirely filled with the water, nor is it best that they should be. Fig. 201 gives a sectional view from Unwin showing the arrangement of the guide blades and buckets of an impulse

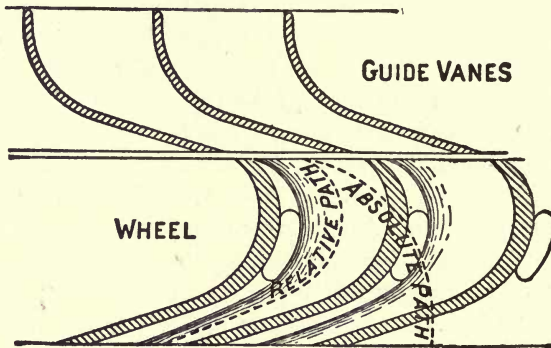

FIG. 201.

turbine, in which the flow is, as in the pressure turbine previously shown, in general along the axis of the wheel. An impulse turbine necessarily loses all the head below the wheel and cannot be used with a draft tube.

Occasionally an attempt is made, in the so-called limit turbines, so to design the guides and buckets that the jets may completely fill the buckets, which are adapted exactly to the shape of the issuing stream. In such case the turbine works as an impulse wheel or as a pressure wheel, according as the draft tube is or is not used.

A modified impulse turbine, largely used for very high heads of water, is found in the Pelton and similar wheels, in which the impulse principle is used through a single nozzle acting in succession on the buckets of a wheel which revolves in the

same plane with the issuing jet. Such a Pelton wheel is shown in Fig. 202. Occasionally two or more nozzles are used, delivering water to the same wheel. Impulse wheels of this class are exceedingly simple and efficient, and work admirably on high heads of water. They are, moreover, very flexible in the matter of obtaining efficiently various speeds of rotation from the same head of water, as the whole structure is so simple and cheap that it can be modified easily to suit varying conditions.

It is obvious that the operation of such an impulse wheel is similar to that of a true impulse turbine, in which only one,

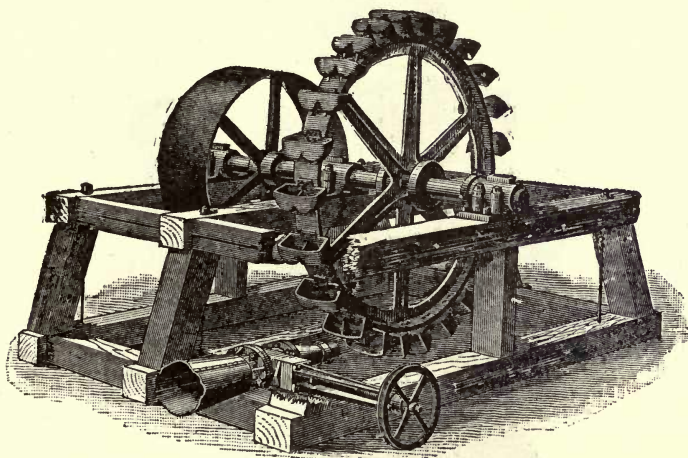
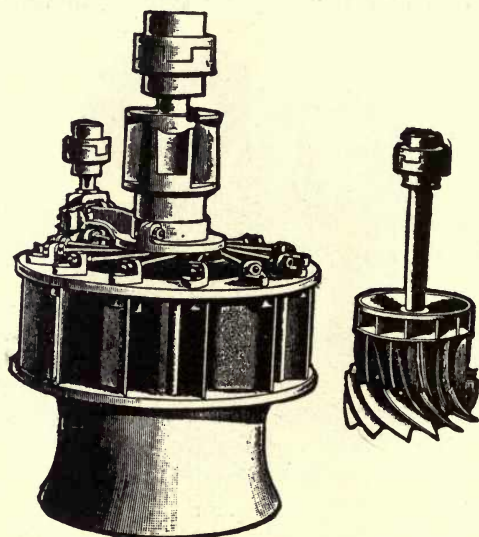

FIG. 202.

or at the most three or four jets from the guide blades are utilized. Most of the hydraulic work done in this country is accomplished with pressure turbines, which are worthy, therefore, of some further description. A small but important portion is accomplished by Pelton and other impulse wheels, and in a very few instances the impulse turbine proper has been used.

There are manufactured in this country more than a score of varieties of pressure turbines. They differ widely in design and general arrangement, but speaking broadly it is safe to say that most of them are of the mixed discharge type, in

which the water passes away from the buckets of the runner inward and downward with reference to the axis of the wheel. It would be impossible to describe even a considerable part of them without making a long and useless catalogue. The essential points of difference are generally in the construction of the runner and in the mechanism of the guide blades. In a good many turbines regulation is accomplished by shifting the guide blades so as to deliver more or less water to the runner. A few types will serve to illustrate the general character of some of the best-known American wheels. Fig.



FIGS. 203 AND 204.

203 shows the so-called Samson turbine of James Leffel & Co., and Fig. 204, the runner belonging to it. This wheel is of the class which regulates by shifting the guide blades, which are balanced and connected to the governor by the rods at the top of the casing shown. The water enters the guide blades inwardly, and the runner is provided as shown with two sets of buckets; the upper set discharging inwardly, the lower and larger set downwardly. The action of the wheel is almost equivalent to two wheels on the same shaft, the intention being to secure an unusually large power and speed from a given

head of water on a single wheel structure. This result is, as might be anticipated, accomplished, and for a given diameter the Samson turbine has a speed and power considerably greater for a given head than found in the usual standard single wheels. As before remarked, however, it is almost, mechanically speaking, equivalent to two wheels through its peculiar feature of double discharge through independent buckets.

Another very excellent and well-known wheel is the Victor turbine, shown in Fig. 205. In this wheel the gate is of the so-

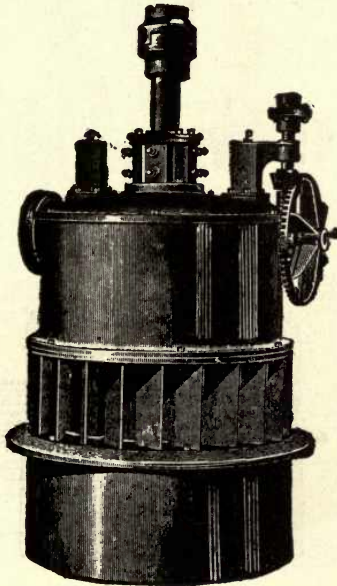

FIG. 205.

called cylinder type, which lengthens or shortens the apertures admitting water to the guide blades. The runner of this wheel is so shaped that the water is discharged inwardly and downwardly. The area of the runner blades exposed to the full water pressure is notably great. The cylinder form of gate is rather a favorite with American wheel manufacturers, and is intended to secure a somewhat uniform efficiency of the wheel, both at full and part load, although

how completely it does this is a matter which, of course, is still in dispute. The wheel shown, however, is an exceptionally good and efficient one, so far as can be judged from general practice. The same makers also manufacture a wheel with shifting guide blades.

Another excellent wheel of the cylinder gate type, the McCormick, is shown in Fig. 206. The runner of this wheel has its main discharge downward. It has a rather large power for its diameter, owing to the proportion of the runners, and is

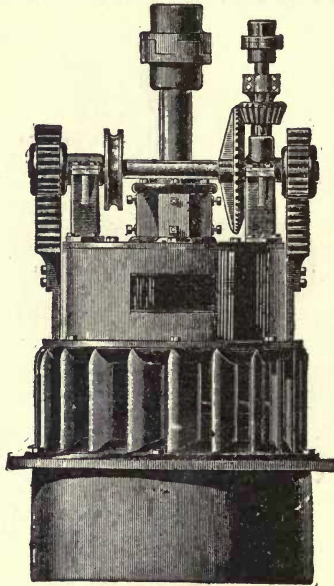

FIG. 206.

well known as a successful wheel considerably used in driving electrical machinery.

These turbines are typical of the construction and arrangement used by first-class American manufacturers. They are all arranged for either horizontal or vertical axes, and for purposes of driving electrical machinery are whenever possible used in the horizontal form. All of them, particularly the two first mentioned, have been widely used for electrical purposes. They are all practically pure pressure turbines and are installed

usually with draft tubes of appropriate length. They are often, too, installed in pairs, two wheels being placed on the same shaft, fed from a common pipe but discharging through separate draft tubes. The arrangement of these draft tubes is very various, as they can be placed in any position convenient for the particular work in hand. Fig. 207 shows a common arrangement where a single wheel is to be driven. The water

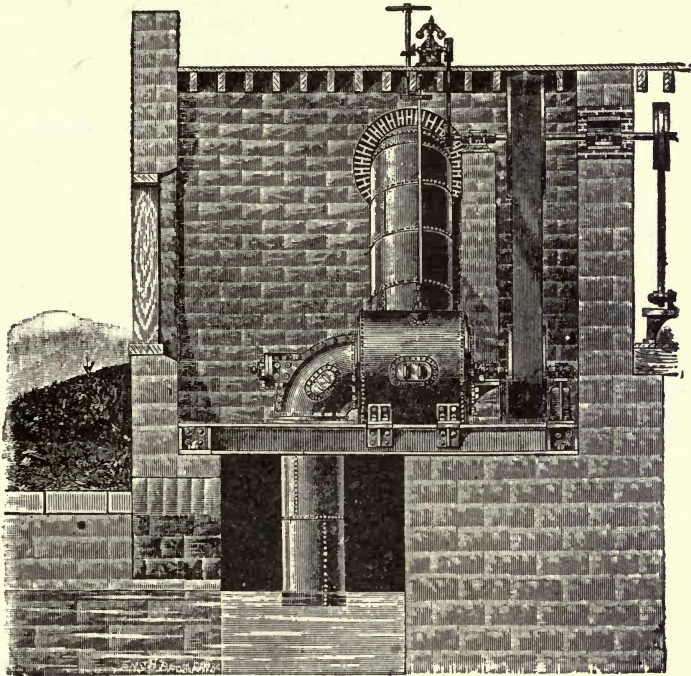

FIG. 207.

enters through the penstock, passing into the wheel case, through the wheel, which has, as is generally the case except with very low heads, a horizontal axis, and thence passes into the tail-race through the draft tube, shown in the lower part of the cut. The full head in the particular case shown is 43 feet, so that the draft tube is fairly long. Where double wheels are employed, there is no longer any necessity of taking up the longitudinal thrust of the wheel shaft, and an arrangement

frequently followed is shown in Fig. 208, which gives a very good idea of the general arrangement of the pair of horizontal turbines, which may be directly coupled to the load or, as in the case just mentioned, drive it through the medium of belts. In many instances it is found cheaper and simpler to mount the two wheels together in a single flume or wheel-case, so as to discharge into the same draft tube. Fig. 209 shows an arrangement which is thoroughly typical of this practice, applied in this case to a low head. The pair of wheels are here arranged so as to discharge into a common draft tube

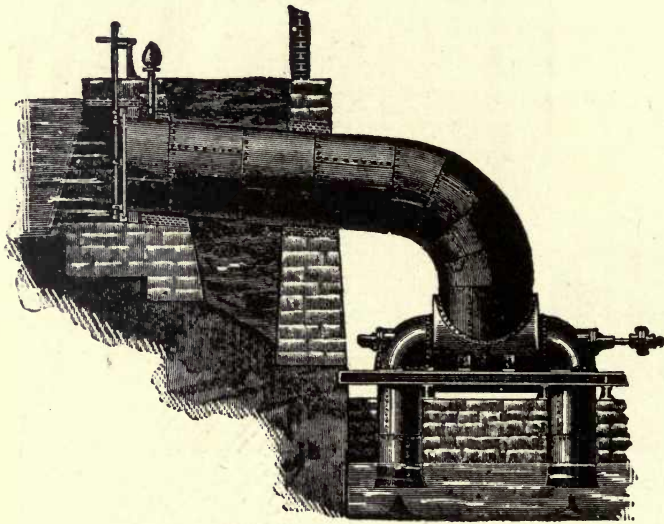

FIG. 208

between them, while they receive their water from the timber penstock in which they are inclosed. Such wooden penstocks are generally very much cheaper than iron ones and for low heads have been extensively used.

The central draft tube here shown need not go vertically downwards, but may take any direction that the arrangement of the tail-race requires. Whether the draft tube is single or double is determined mainly by convenience in arranging the wheel and its foundations, and the tail-race. The use of a pair of turbines coupled together is not only important in avoiding

end thrust, but it also enables a fair rotative speed to be obtained from moderate heads, which is sometimes very important in driving electrical machinery.

For example, suppose one desired to drive a 500 KW generator by turbines from a 25 foot head. Allowing a little margin for overload the turbine capacity should be in the neighborhood of 750 HP. Now turning to a wheel table applying, for instance, to the "Victor" wheel, one finds that a single 54" wheel would do the work, but at the inconveniently low speed of 128 r.p.m. But under the same head a pair of 39" wheels

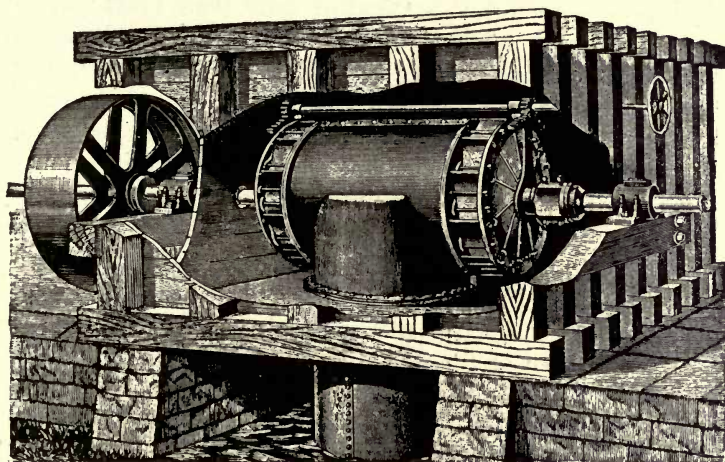

FIG. 209.

would give a little larger margin of power at 180 r.p.m., and hence would probably enable one to get his dynamo at lower cost, as well as to avoid a thrust bearing. Often such a change of plan will allow the use of a standard generator where a special one would otherwise be necessary.

Wherever possible it is highly desirable to employ these horizontal wheels for electrical purposes, inasmuch as power has, in most cases, to be transferred to a horizontal axis, and the use of a vertical shaft wheel necessitates some complication and loss of power in changing the direction of the motion. Occasionally a vertical shaft wheel is used for electrical purposes, driving a dynamo having a vertical armature shaft. This prac-

tice is not generally to be recommended, as it involves special dynamos, and a somewhat troublesome mechanical problem in supporting the weight of the armature, which is generally carried by hydraulic pressure. A fine example of this arrangement is to be found in the great Niagara Falls plant.

The use of pressure turbines for driving electrical machinery is exceedingly convenient on low or moderate heads, say up to 50 or 100 feet. With higher heads frequently the rotative speed becomes inconveniently great; for example, under 100 feet head, 150 HP can be obtained from a wheel a little more than 15 inches in diameter, at a speed of more than 1,000 revolutions per minute. At 200 feet head, the power for the same wheel will have risen to about 400 HP and the speed to nearly 1,300. This is a rather inconvenient speed for so large a power, and it is necessitated by the fact that a pressure turbine to work under its best conditions as to efficiency, must run at a peripheral speed of very nearly three-quarters the full velocity of water due to the head in question. If, therefore, turbines are used for high heads, either the dynamos to which they are coupled must be of decidedly abnormal design, or the dynamo must be run at less speed than the wheels.

The former horn of the dilemma was taken in the Niagara plant, and involved some very embarrassing mechanical questions in the construction of the dynamos. Where belts are permissible the other practice is the more usual, of which a good example is found in the large lighting plant at Spokane Falls, Wash., where the wheels were belted to the dynamos for a reduction in speed instead of an increase, as is usually the case.

Impulse turbines are little used, although manufactured to some extent by the Girard Water Wheel Co., of San Francisco, Cal. The wheel manufactured by them is one with a well-known foreign reputation. Its general arrangement is well shown by the diagram, Fig. 210. The Girard impulse turbine is of the outward flow type, a form rather rare in pressure turbines. The water enters the wheel centrally through a set of guide blades, which form a series of nozzles from which the water issues with its full spouting velocity and impinges on the buckets of the runner, which surrounds the guide blades.

The discharge is virtually radially outward. Regulation is secured by a governor which either cuts off one or more of the nozzles or may be arranged by swinging guide blades to contract all or a part of the nozzles. In either case, there is no water wasted, and the wheel works efficiently at practically all loads.

Like others of the impulse type, the peripheral speed of the wheel when worked under its best conditions for efficiency, is very nearly one-half the spouting velocity of the water as it

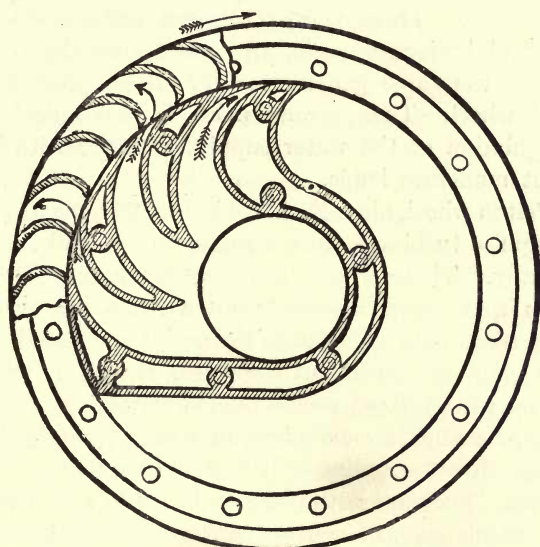

FIG. 210.

issues from the nozzle. This produces for a wheel of given diameter a lower speed for the same head than in the case of pressure turbines, while the use of a larger number of nozzles working simultaneously on the runner gives a higher power for the same diameter than in the case of the Pelton or similar wheels, which use only a few nozzles with jets applied tangentially; hence, such impulse turbines occupy a useful place in the matter of speed, aside from all questions of efficiency.

Under moderately high heads, from 100 up to 300 or 400 feet, they give a much greater power for a given rotative

speed than impulse wheels employing only two or three nozzles. On the other hand they do not run inconveniently fast, as is the case with pressure turbines under such heads. At extremely high heads they give, unless operated with only one or a few nozzles, so great power as to be inconvenient for the high speed attained, so far at least as the operation of dynamos is concerned. At very low heads there is material loss from the fact that the wheel cannot be used with the draft tube, and consequently a certain amount of the head must be sacrificed to secure free space from the wheel to the tail-water. These Girard turbines are made with both vertical and horizontal axes, and are applicable to electrical work with the same general facility which applies to other types of wheel. Their strong point is economical and efficient regulation of the water supply, together with high efficiency at moderate loads.

The Pelton wheel, already shown in Fig. 202, may be regarded as an impulse turbine having a single nozzle, and that applied tangentially. These wheels have proved immensely effective for heads from several hundred up to a couple of thousand feet. Like the true impulse turbines, the peripheral speed should be half the spouting velocity of the water, hence, by varying the dimensions of the wheel a wide range of speed can be obtained, which is exceedingly convenient in power transmission work, permitting direct coupling of the dynamos under all sorts of conditions. They are not infrequently made with two or three nozzles, which give, of course, correspondingly greater power for the same speed. At heads of only 100 or 200 feet these wheels with their few nozzles give an inconveniently low rotative speed for the power developed, and are at their best in this respect between 300 and 1,000 feet. The Pelton wheel is usually regulated by deflecting the nozzles away from the buckets of the wheel, a very effective but most inefficient method, so far as economy of water is concerned. The wheel has, however, under favorable conditions, a very high efficiency, certainly as high as can be reached with any other form of hydraulic prime mover. The practical results given by this class of wheel are admirable under circumstances favorable to their use, and the Pelton and Doble wheels have played a very

important part in the great power transmission works which have placed the Pacific coast in the van of modern engineering.

A recent improvement in impulse wheel practice is the development of a successful "needle valve" for the nozzles, which obviates the waste of water due to the use of deflecting nozzles. The needle valve is simply a nozzle which can be closed at will by a central plunger, moving axially in the stream just behind the nozzle. The plunger and its seat are given surfaces curved in such wise that in all positions of the plunger a smooth emergent stream is produced, and the efficiency of the wheel is very little changed.

This is upon the whole, a better method of regulation than the deflecting nozzle in that it is economical of water, but shutting off the stream quickly produces very severe strains in the pipe line and in most instances some form of relief valve is desirable to reduce the pressure. To use any form of nozzle valve, too, the water must be thoroughly freed from sand, which at the stream velocities often used, cuts even the toughest metal with great rapidity.

Another wheel of this class is the Leffel "Cascade" water-wheel. Two complete rings of buckets are employed for this wheel, and the wheels are arranged to be supplied from several nozzles, of which one or more are put into use according to the necessities of regulation. The cascade wheel therefore occupies a place, as it were, between the ordinary impulse wheel and the impulse turbine, resembling the former in the arrangement of its multiple jets, and the latter in the method of regulation by cutting off completely some of the nozzles.

From the foregoing it will be appreciated that each of the three general classes of wheels described, pressure turbines, impulse turbines, and tangential impulse wheels, has a sphere of usefulness in which it can hardly be approached by either of the others. It is worth while, therefore, to examine somewhat in detail the conditions of economy under various circumstances.

The pressure turbine has its best field under relatively low and uniform heads. By means of the draft tube no head is lost, as is the case with that portion of the head which lies between the turbine and the tail-water in the use of impulse

wheels of any description. Further, the pressure turbine under all heads gives a higher relative speed than the impulse wheels, whether of the tangential or turbine variety, and under low heads is apt to be of less bulk and cost and to give a more convenient speed for electric work; hence, these pressure turbines have been more extensively used than any other variety of water-wheels in the enormous hydraulic developments of the last quarter of a century. Furthermore, the pressure turbine has, under favorable conditions, as high efficiency as any known

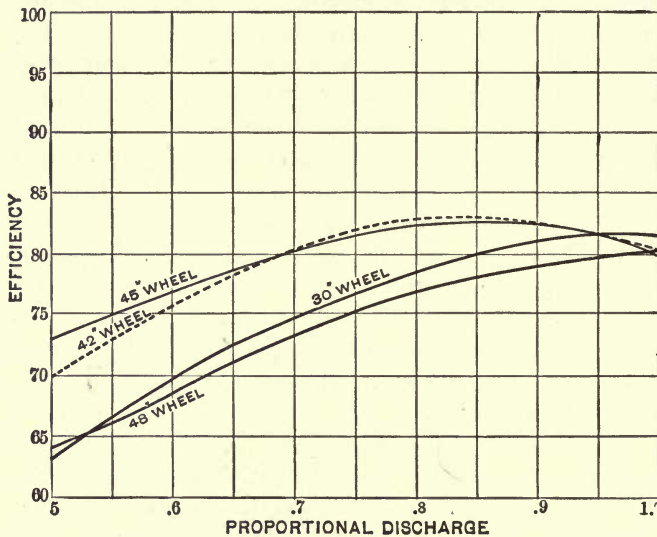

FIG. 211.

variety of water-wheel. The losses of energy are mainly of four kinds.

1. Friction of bearings, usually small.
2. Friction and eddying in the wheel and guide passages.
3. Leakage, and
4. Unutilized energy of other kinds, largely owing to imperfect shaping of the working parts, or loss of head.

With the best construction these losses aggregate 15 to 20 per cent. Of them the shaft friction is the smallest and the loss from friction and eddies in the wheel the largest, probably fully half of the total loss, particularly under high

heads. This efficiency is approximately true of the better class of turbines, whether of the pressure or impulse variety. Under low and uniform heads the pressure turbine probably is capable of a little better work than the impulse variety, but both suffer if the head varies. The curves, Fig. 211, show efficiency tests made with the greatest care on four first-class pressure turbines at the Holyoke testing flume, probably the best equipped place in the world for making such tests. It should be noted that the efficiency of all the wheels shown is good; over 80 per cent at full admission of water; at partial admission the efficiencies vary more between the individual wheels. This variation is largely due to the methods of regulating the flow employed. These are in general three:

1. Varying the number of guide passages in use.
2. Varying the area of these guide passages by moving the guide blades.
3. Varying the admission to the guide passages by a gate covering the entrance to all of them.

The first method is particularly bad, as the buckets are at one moment exposed to full water pressure and then come opposite a closed passage, setting up a good deal of unnecessary shock and eddying. It is a method that is scarcely ever used in this country. Between the other two it is not so easy to choose. Both have strong advocates among wheel makers; some companies building both types, and the others only one of them. The curves shown represent both these methods of regulation.

The truth probably is that the relative efficiency of the two depends more on the design of the wheel with reference to its particular form of regulation, than on the intrinsic advantages of either form. Turbines are generally constructed so that the point of maximum efficiency is rather below the maximum output, as a little leeway is desired for purposes of regulation under varying heads, so that the design is arranged to give the best efficiency of which the wheel is capable at a point a little below full admission. These efficiency curves were taken at heads of from 15 to 18 feet and show what can be regularly accomplished by good wheel design. They are neither phenomenally high nor unusually low. Occasionally efficiencies are recorded slightly better than those shown. In this connec-

tion it is desirable to state in the way of warning, that there was obtained at the Holyoke flume some years ago a series of tests of turbines of more than one make, which showed enormously high efficiency, afterward traced to a constant error in the experiments. As the fact of the error was not so generally known as the result of the tests, occasionally reports are heard of phenomenal turbine efficiencies which are given in entire good faith, but based on errors of experiment. It is only fair to say that the tests now made at the Holyoke flume are worthy of entire confidence.

As regards impulse turbines, data are hard to obtain. Those which are available indicate, however, that with an efficiency probably a little less at full load than that of pressure turbines under moderate heads, the half-load efficiency is generally considerably higher. This is owing to the fact that the buckets of the runner work entirely independently of each other, and the water acts in precisely the same way on each bucket whether it is received from all the nozzles formed by the guide blades, or from a part of them. The impulse turbines are generally regulated by cutting off more or less of the nozzles. The shaping of the surfaces in the runner and guide blades, and the smoothness of the finish, are of more importance in these wheels than in the ordinary pressure turbines. The impulse turbines are, as has already been stated, peculiarly adapted in point of speed and general characteristics for use on moderately high heads, and in this work they give a better average efficiency and more economical use of water than any of the pressure turbines. For low heads their advantages are far less marked, and the pressure turbines are generally preferred.

The tangential impulse wheels are, at full admission of water, of an efficiency quite equal to that of the best turbines. At partial admission they cannot be expected to give the same results as do the best impulse turbines, inasmuch as they regulate generally by deflecting the nozzle away from the buckets, and hence wasting water. The variation of the stream by a needle valve considerably relieves this difficulty in cases where it can be successfully applied. For very high heads, however, the tangential wheels are preferable to any turbines, as they

give a better relation between power and speed, so far as driving electrical machinery is concerned, and their extreme simplicity is favorable to good continuous working under the enormous strains produced by the impact of water at great spouting velocities.

To summarize, pressure turbines are admirable for low and uniform heads, particularly where the load is steady. The impulse turbines give more efficient use of water at part load, and a more convenient speed on moderately high heads. The tangential impulse wheels do relatively the best work under very high heads, and where water does not have to be rigidly economized. Each of the three classes has decided advantages over the others in particular situations, and the full load efficiency of all three is approximately equal. The choice of either one of these types should be made in each individual case in accordance with the hydraulic conditions which are to be met. The choice between particular forms of each type is largely a commercial matter, in which price, guarantees, facility of getting at the makers in case of repairs, standard sizes fitting the particular case in hand, and similar considerations are likely to determine the particular make employed, rather than any broad difference in construction or operation.

The success of a power transmission plant depends quite as much on careful hydraulic work as on proper electrical installation. The two should go hand in hand, and any attempt, such as is often made, to contract for the two parts of the plant independently of each other, or to engineer them independently, generally results in a combination of electrical and hydraulic machinery that is far from being the best possible under the conditions, and is quite likely to be anything but satisfactory.

The hydraulic and electrical engineers should go over the arrangement of the plant together with a view to adapting each class of machinery to the other as perfectly as possible, in order to get a symmetrical whole. Many troublesome questions have to be encountered, and only the closest study will lead to perfectly successful results.

One of the commonest and most serious difficulties met with in laying out an electrical and hydraulic plant for transmission

work, lies in the variability of the head of water. There are comparatively few streams from which can be obtained an invariable head practically independent of low water or freshets. The usual condition of things is to find a fairly uniform head for nine or ten months in the year, and rather wide variations during the remainder of the time. It is not at all uncommon to meet a water-power which, even when very skilfully developed, will still entail upon the user a variation of 25 or 30 per cent in the available head.

At the time of high water this appears as a rise of water level in the tail-race, so as to diminish the head available for the wheels. In times of low water, the head might be normal, but the quantity of water altogether insufficient. Any variations of this kind are of a very serious character, because they not only vary the amount of power which is available, but they change the speed of the wheels so that the dynamos no longer will operate at their proper speed and hence will change in voltage, and if alternating apparatus is used, in frequency also, which is even more serious. For example: Under 24 feet head one of the well-known standard wheels gives nearly 650 HP at 100 revolutions per minute. Under 16 feet head the same wheel would give only 352 HP at 82 revolutions.

The lack of power occurring at the time of high water is serious. The change of speed, although not great, is very annoying, and should be avoided if possible. Changes much greater than this are common enough. The season of reduced head is generally short, not over a couple of months, often only a week or two, and this renders the situation doubly embarrassing, because during a large part of the year the same wheel must be able to operate economically. The methods taken to get out of this difficulty of varying head are various; most of them bad. One of the commonest is to arrange the wheels to operate normally at partial gate, then on the low heads to throw the gate wide open and obtain increased power. On the high heads the wheel is throttled still more. Such an arrangement works the dynamo in a fairly efficient fashion, but the wheel, as a rule, quite inefficiently a large portion of the time, as may be seen by reference to the efficiency curves of the wheels just given. It is a practice similar to that which

one would find in working an engine at part load. For moderate variations of head, not exceeding 10 per cent, the loss of efficiency is not so serious as to bar this very simple plan, but under conditions too frequently encountered, these variations of efficiency would be so great as to make the method exceedingly undesirable.

Hydraulic plants are occasionally operated without any reference to economy of water, and in such cases the practice of operating normally at part gate is frequently followed, but it must be remembered that as water powers are more and more developed, economy of water becomes more and more necessary, and in every case should be borne in mind even if it is not rendered necessary by conditions actually existing. In thoroughly developed streams it is generally important to waste no water.

Another method of overcoming the difficulties due to variations of head, is the installation of two wheels on the same shaft, one intended to give normal power and speed at the ordinary head, the other at the emergency head. This practice is carried out in various forms. Sometimes two wheels may be mounted on the same horizontal or vertical axis, and one of them is disconnected or permitted to run idle except when actually needed. Another modification of the same general idea is the use of a duplex wheel with the runner and guides arranged in two or three concentric sets of buckets, which can be used singly or together according to the head which is available.

A fine example of this practice is found in the great power plant at Geneva, to which reference has already been made, where the head varies from $5\frac{1}{2}$ to 12 feet. Here the turbines have buckets arranged in three concentric rings, the outermost being used at the highest head and all three at the lowest head. Under the latter condition, the average radius at which the water acts upon the wheel is diminished and the speed is therefore increased, while the greater volume of water keeps up the power. The various combinations possible with the rings of buckets are so effective in keeping the speed uniform that the extreme variation of speed under the maximum variation of head is only about 10 per cent. Such a triplex turbine

is of high first cost, but is decidedly economical of water at normal load. Still another variation of the double turbine idea consists of installing two turbines for each unit of power, one acting directly, the second through the medium of belts. The direct-acting turbine is intended for normal load, the belted turbine of larger dimensions for use during the periods of low head.

This arrangement is used in the large power transmission plant at Oregon City, Ore. It is economical of water, but is mechanically somewhat complicated. It is probably on the whole less desirable than the installation of two turbines on the same shaft, and much less desirable than the duplex or triplex arrangement just referred to. Where two turbines are operated on the same shaft, it is generally possible to arrange the turbine designed to operate on the lower head so as to run at a disproportionately high velocity with some loss of efficiency, and so to hold the speed fairly uniform.

Still another method of counteracting the variation of head is applicable only where the power is transmitted from the turbine by gears or belts. In this case it is always possible to operate the machinery under the reduced head with some loss of output, but still at or near the proper speed. Whatever way out of the difficulty is chosen, it should be borne in mind that the most desirable, on the whole, is the one which will work the wheels during the generally long period of fairly steady head at their best efficiency. If there is to be any sacrifice of efficiency, it should by all means be for as short a time as possible, and, therefore, should be at the periods of extreme low head. At such times water is generally plenty, while at the higher heads economy in its use is more necessary.

REGULATION OF WATER-WHEELS.

For many years there have been bad water-wheel governors and worse water-wheel governors, but only recently have there appeared governors which may be classified as good from the standpoint of the electrical engineer. It has been necessary to go through the same tedious period of waiting and experi-

mentation that was encountered before dynamo builders could find engines which would hold their speed at varying loads. Until the advent of electrical transmission work, water-wheels were most generally employed for certain classes of manufacturing, such as textile mills, where the speed must be quite uniform, but where at the same time the load is almost uniform; or, on the other hand, for saw mills and the like, where constant speed is of no particular importance.

The action of water-wheel governors as regards the way in which they vary the supply of water is very different; some merely act to open or close the head gates; others to work a cylinder gate immediately around the wheel, and still others to vary the area of the guide passages, as in the so-called register gate turbines.

In whatever way the governing action takes place, its result is too often unsatisfactory, due to the great difficulty that has to be encountered in the great inertia of the water and of the moving parts of the wheel. Both water and wheel are sluggish in their action, and as a result some time elapses after the governor has produced a change of gate, before that change becomes effective. Meanwhile, the speed has fallen or risen to a very considerable extent, and perhaps in addition the load has again changed so that by the time the speed of the wheel has been sensibly affected by the governor, the direction of the governing action may be exactly opposite to that which at the moment is desirable. Even if this is not the case, the governing is usually carried too far, being continued up to the time at which the wheel is affected and reacts on the governing apparatus, hence another motion of the governor becomes necessary to counteract the excess of diligence on the part of the first action. In other words, the governor "hunts," causing a slow oscillation of the speed about the desired point, an oscillation of decreasing amplitude only if the new load on the wheel be steady.

This sluggishness of reaction to changes indicated by the governor is the most formidable obstacle to the proper control of the water-wheels. To overcome it, even in part, it is necessary that the movement of the gates be comparatively active, if the changes of load are frequent, and this entails still

further difficulty by causing severe strains on the mechanism and the gates, particularly if the water is led to the turbine through a long penstock. In the latter case, the variations in pressure produced by rapid governing are often dangerous, and have to be counteracted by air chambers, stand pipes, or the like, and aside from all this there is a still further difficulty in the considerable weight of the gate and the pressure against which they have to be operated, so that the amount of mechanical power controlled by the governor must be very considerable.

A very large variety of governors have been designed to meet the serious difficulties just set forth. Most of them have been abject failures, and those that may be really reckoned of some considerable value for electrical work may be counted on the fingers of one hand.

Water-wheel governors may be roughly divided into two classes. First, come those regulators in which the wheel itself supplies power to the gate-shifting mechanism, which is controlled by a fly ball governor through more or less direct mechanical means. Second, comes the relay class of governors, wherein all the work possible is taken off the centrifugal governor, and its function is reduced to throwing into action a mechanism for moving the gates which may be quite independent of any power transmitted from the wheel to the governing mechanism. The various classes of hydraulic, pneumatic, and electric governors are worked in this way. Their general characteristic is that their sole function in governing is to work the devices which control the secondary mechanism, which consists, in various cases, of hydraulic cylinders operating the gates, pneumatic cylinders serving the same purpose, or electric motors which open or close the gates by power derived from the machines operated by the turbines.

A vast amount of ingenuity has been spent in trying to work out regulators of the first mentioned class. Almost every possible variety of mechanism has been employed to enable the governor to apply the necessary power to the mechanism operating the gates. The general form of most of these governors is as follows: Power is taken from the wheel shaft by a belt to the governor mechanism, where it serves at

once to drive the governor balls, and to work the gates when the governor connects the gate-controlling gears to the pulley which supplies the power. This is generally done by friction cones or their equivalent, thrown into action in one direction when the governor balls rise, and in the other direction when they fall.

Sometimes this mechanism is varied by employing a pair of oscillating dogs, one or the other of which is thrown into appropriate gearing by the governors. There are many governors of this kind on the market, and where the load is fairly steady and no particular accuracy of regulation is necessary, they have given good satisfaction. The fault with all governors of this sort is that the centrifugal balls either lack sensitiveness or lack power. If the governor works at all rapidly in moving the gates, too heavy a load is thrown on the governor for any but a massive mechanism, and the centrifugal device becomes insensitive; or, on the other hand, if the gates are worked slowly, the governor in itself is sluggish and ineffectual.

In most cases the gates are made to move quite slowly. In the attempt to get sensitiveness, the friction wheels or dogs are often adjusted so closely that the governor is in a constant slight oscillatory motion, but when its action is really needed, as in the case of a sudden change of load, response generally does not come quickly enough. It is of course possible to construct a mechanical relay which would possess both power and sensitiveness, but nearly all the governors made on this principle lack one or the other, and sometimes both.

The second type of governor, as mentioned, is not open to the objections noted, if properly designed, inasmuch as it is a comparatively easy matter to make a balanced hydraulic or pneumatic valve which can be worked even by the most sensitive of governors, and yet can apply power enough to move heavy gates as rapidly as is consistent with safety. In addition, such governors can be made to work with a rapidity depending on the amount of change in speed, so that if a heavy load is thrown on the wheel, the relay valve would be thrown wide open, and consequently bring a great and

immediate pressure to bear upon the gates. In the so-called electric governors, the function of the governor balls is merely to make in one direction or the other the electrical connections to a reversible motor which handles the gates. This relay class of governors has been recently worked out with considerable care, and is capable of giving surprisingly close regulation even under widely varying loads, results comparable even with those obtained from a steam engine governor.

A third type of water-wheel governor is independent of any centrifugal device and operates by a differential speed mechanism, so that wherever the speed of the wheel varies from a certain fixed speed maintained by an independent motor, the gates are opened or closed as occasion demands. The difficulty here is to get a constant speed which will not be sensibly altered when the load of working the gates is thrown on the governor mechanism. Some species of relay device is almost necessary to the successful operation of a differential governor, but with such an adjunct very close regulation can be and is obtained.

Up to the past few years almost all hydraulic governing has been by mechanisms of the first class, and it is only recently that the relay idea has been worked out carefully, both for centrifugal and differential mechanisms, so as to obtain anything like satisfactory results for electrical work where close regulation of speed over a wide variation of load is very necessary.

For electrical purposes, several rather interesting governing mechanisms have been tried, which do not fall into any of these classes, inasmuch as their function is to keep the load constant and prevent variations of speed instead of checking these variations after they have been set up. Such governors (load governors they may properly be called) operate by electric means, throwing into circuit a heavy rheostat or a storage battery when the electrical load falls off, and cutting these devices out again when the load in the main circuit increases. These governors have in several instances been applied with success to controlling the variable loads found in electric railway stations operated by water-wheels. But they waste energy in a very objectionable manner, and at best can only

be regarded as bad makeshifts, out of the question when there must be any regard for economy of water, and only to be tolerated in the lack of an efficient speed regulator.

Occasionally electric governors operated by the variations in the voltage of the circuit supplied have been tried, but these are open to two serious objections: In the first place, they do not hold the voltage steady for the same reasons that most speed regulators do not hold the speed steady. Secondly, they regulate the wrong thing. In transmission plants, most of which are and will be operated by alternating currents, it

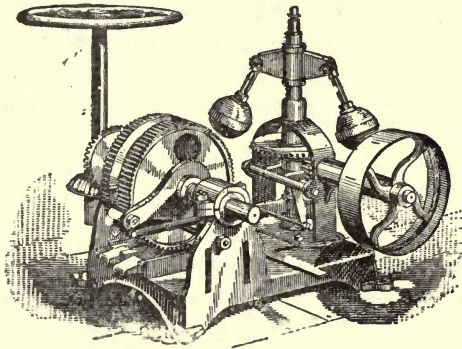

FIG. 212.

is important that the frequency be kept uniform. If the voltage is kept constant by varying the speed, the frequency is subject to enough variation to be very annoying in the operation of motors. Automatic voltage regulators, working through variation of the field excitation of the generator, belong in a different category and have come into considerable and successful use.

To pass from the general to the special, Fig. 212 shows a typical water-wheel governor of the first class, that is, of the kind operated directly by the wheel through a system of dogs worked by a fly ball governor. There is here no attempt at delicate relay work, and the resulting mechanism, while quite good enough for rough-and-ready work, is of little use for any case where a variable load must be held to its speed with even a fair degree of accuracy. The cut shows the construction

well enough to render further description superfluous. Governors like these were practically the best available for many years, and proved to be cheap and durable, but they seldom governed much more than to keep the wheels from racing dangerously when the load was thrown off, or from slowing down permanently when it came on. It is not too much to say that they never should be used in connection with an electrical station, unless combined with intelligent hand regulation — which at a pinch is not to be despised.

Of the indirect acting and relay governors there are many species, most of which had better be consigned to the oblivion of the scrap heap. But out of the manifold inventions and experiments good has come, so that at the present time there are a few delicate relay governors capable of holding the wheel speed constant within a very narrow margin indeed. Others of similar excellence will probably be evolved, but just now three, the Lombard, Replogle, and the Faesch-Piccard, together with one or two electrical governors, are decidedly the best known. The first named has given very remarkable results in many transmission plants in which it has been employed — results quite comparable with those obtained from a well-governed steam engine. The second has given excellent results in the Oregon City transmission and elsewhere, while the last was adopted for the original transmission at Niagara Falls and has done its work well, although in the extension of the plant an hydraulic relay governor designed by Escher, Wyss & Co., was installed. They are suitable types of the hydraulic, electric, and mechanical relay governors.

The Lombard governor, Plate XIII, is an hydraulic relay in principle. The gate-actuating mechanism is a rack gearing into a pinion, and driven to and fro by the piston of a pressure cylinder. The working fluid is thin oil, kept under a pressure of about 200 lbs. per square inch. This pressure is supplied by a pump driven by the pulley shown in the figure and operating to keep up a 200 lb. air pressure in the pressure chamber at the base of the governor, above the oil that partially fills it. This chamber is divided into two sections, the one holding the oil under pressure, the other being a vacuum space kept at reduced pressure by the pump system.

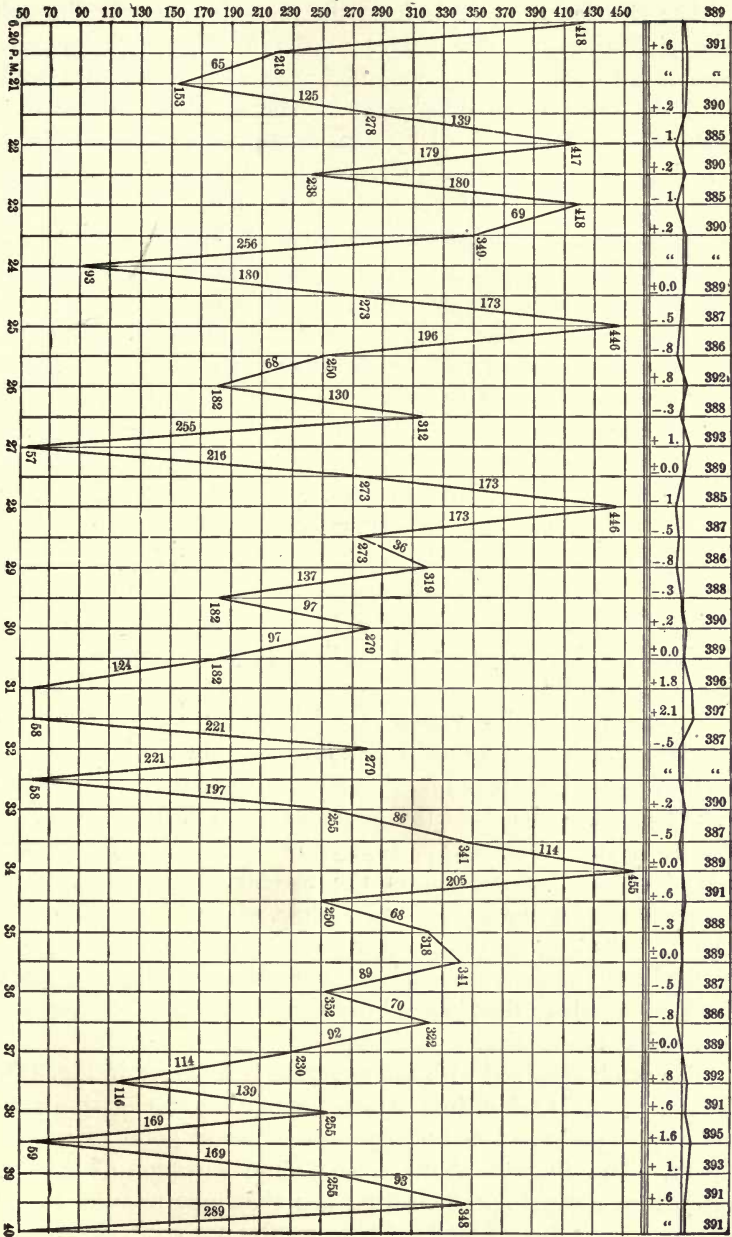

The circulation of oil is from the pressure chamber through the piping system and valves to the working cylinder, and thence into the vacuum chamber, whence it is pumped back into the pressure chamber again. The governor proper consists of a sensitive pair of fly balls operating a balanced piston valve in the path of the pressure oil. A motion of $\frac{1}{84}$ of an inch at the valve is sufficient to put the piston into full action and open or close the gates. Sensitive as this mechanism is, it would not govern properly without the addition of an ingenious device, peculiar to this governor, to take account of the inertia of the system. The weakest point of all such governing mechanisms has been their helplessness in the matter of inertia. If a governor even of the sensitive relay class be set to regulate a wheel, we encounter the following unpleasant dilemma: If the mechanism moves the gates quite slowly, it will not be able to follow the changes of load. If it moves them rapidly the governing overruns on account of the inertia of the whole wheel system, so that the apparatus "hunts," perhaps the worst vice a governor can have when dynamos are to be governed. Hence most governors have either been unable to follow a quickly varying load at all, or they have made matters worse by hunting.

In the Lombard governor, special means are provided to obviate hunting. The bell-crank lever seen in the background of Plate XIII is actuated by the same movement that works the wheel gates, and moves the governor valve independently of the fly balls. Its office is promptly to close the valve far enough ahead of the termination of the regular gate movement to compensate for inertia. For example, if the speed falls and the fly balls operate to open the gate wider, the lever in question closes the governor valve before the fly balls are quite back to speed, so that instead of overrunning and hunting, the governing is practically dead beat.

The result obtained with this governor is well seen in Fig. 213. This diagram is taken from a plant operating an electric street railway — perhaps the worst possible load in point of irregularity. The diagram shows a maximum variation of 2.1 per cent from normal speed, lasting less than one minute, under extreme variation of load. These results are entirely authen-

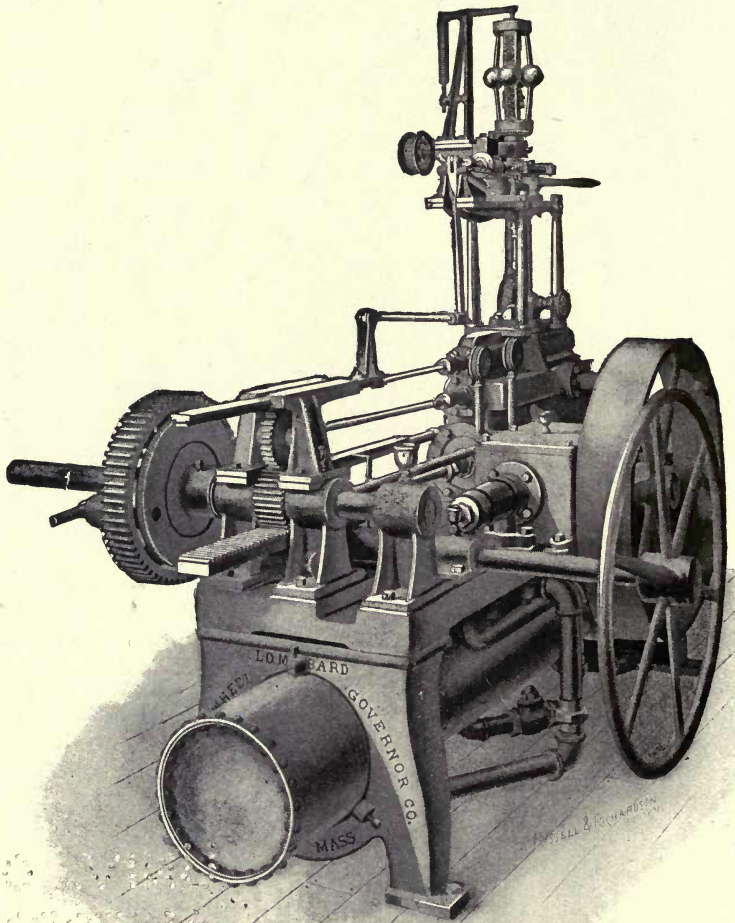

PLATE XIII.

tic, the readings having been taken jointly by the representatives of the governor company and the local company. Speed was taken by direct reading tachometer and load from the station instruments.

Fig. 214 shows a small governor of the same make intended for use with impulse wheels, and for similar light work under high

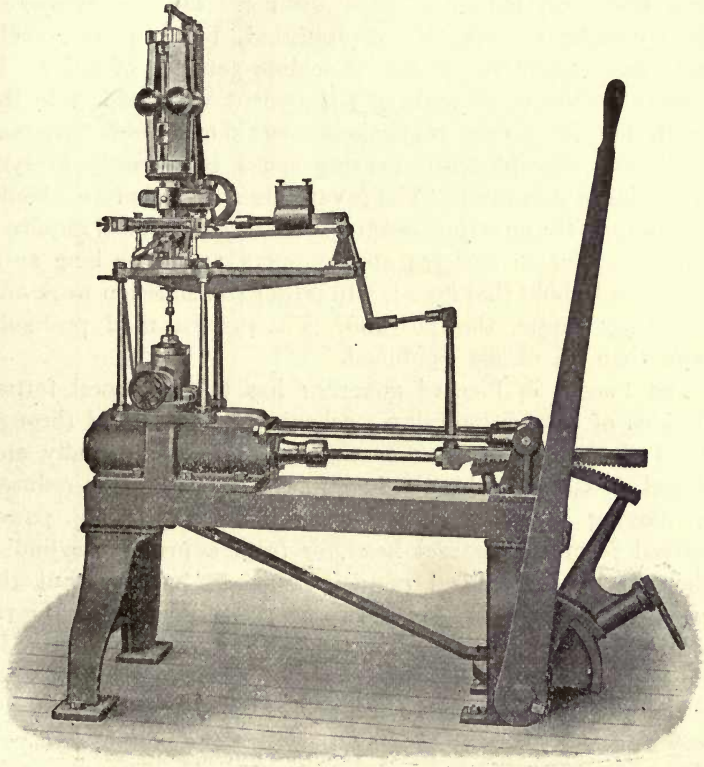

FIG 214.

heads. It works on precisely the same principle as the larger governor, save that the power is derived from a water cylinder taking water from the full head of the plant. The work of this little governor is 5.4 foot-pounds for each foot of working head, quite enough to handle the deflecting nozzles or needle valves used for regulating impulse wheels. The larger governor of Plate XIII has a very different task in moving the heavy

gates of turbine wheels and is designed to develop more than 10,000 foot-pounds. For still heavier duty a vertical cylinder type of Lombard governor, somewhat simplified from the forms here shown, has recently been introduced.

A gate gauge is generally attached to the bed plate of the Lombard governor, so that the excursions of the piston plainly show the exact extent of gate opening. The mechanism of the governor is decidedly complicated, but it is extremely well made and fitted, so that it seldom gets out of order. It permits readily of all sorts of adjustment with respect to the speed, but for power transmission work one needs constant speed only, except when varying speed temporarily in synchronizing a generator. The invariable rule, therefore, should be to adjust the governor carefully for the exact speed required, and thereafter to LET ITS ADJUSTMENTS ALONE as long as it continues to hold that speed. In power transmission work and in railway plants, this governor is at present used probably more than all others combined.

The Faesch & Piccard governor has taken several forms, the idea of a sensitive relay mechanism being carried through all of them. An hydraulic relay has been successfully employed abroad. In this the function of the fly balls is reduced to moving a balanced valve controlling hydraulic power derived from the natural head, or from a pressure cylinder. There is no mechanical provision against hunting, but the speed of governing is adjusted as nearly as possible to the requirements of the load, and the results are generally good. In the great Niagara plant the governor is situated on the floor of the power house, nearly 140 feet above the wheel. It is a very sensitive mechanical relay, in which the motion of a pair of fast running fly balls puts into operation through a system of oscillating dogs a brake-tightening mechanism, which in its turn permits power to be transferred from pulleys driven from the turbine shaft through a pair of dynamometer gears, to the system of gearing that works the balanced gate at the end of the lever system 140 feet below the governor. This governor was guaranteed to hold the speed constant within 2 per cent under ordinary changes of load, and to limit the speed variation to 4 per

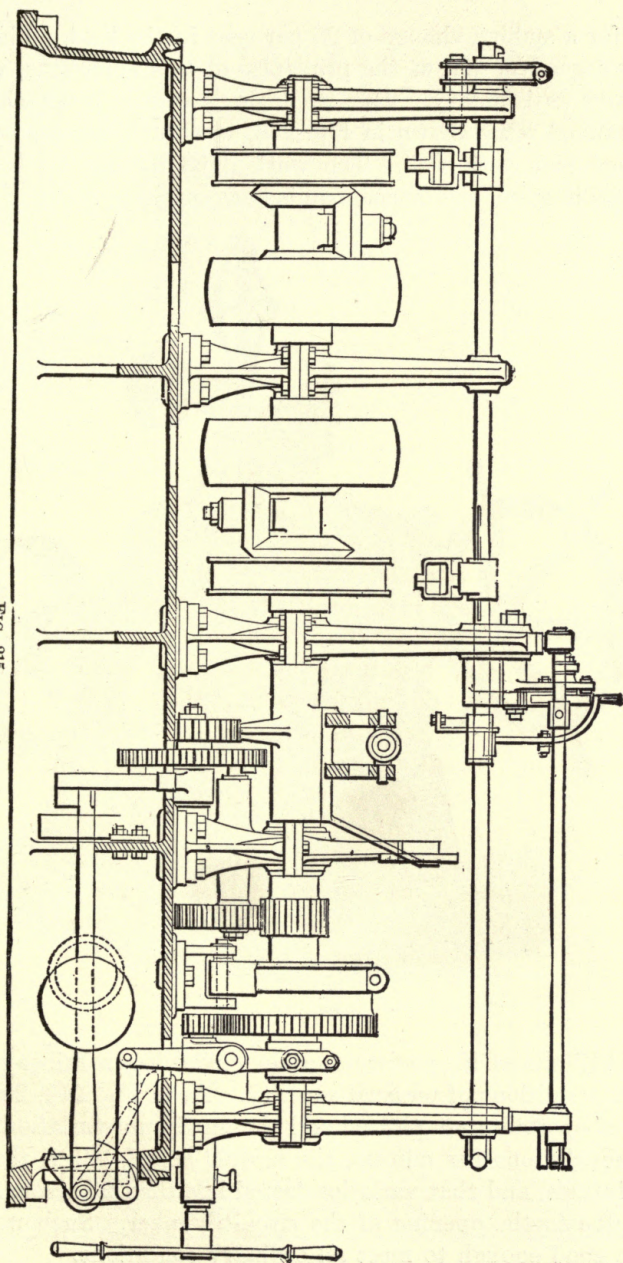

FIG. 215.

cent for a sudden change of 25 per cent in the load. Fig. 215 gives a good notion of the principles of this apparatus, which is fairly satisfactory. The Replogle governor is an electro-mechanical relay shown in Fig. 216, which exhibits its general arrangement very well. The work done by the fly balls is very trifling and the mechanism is both sensitive and powerful.

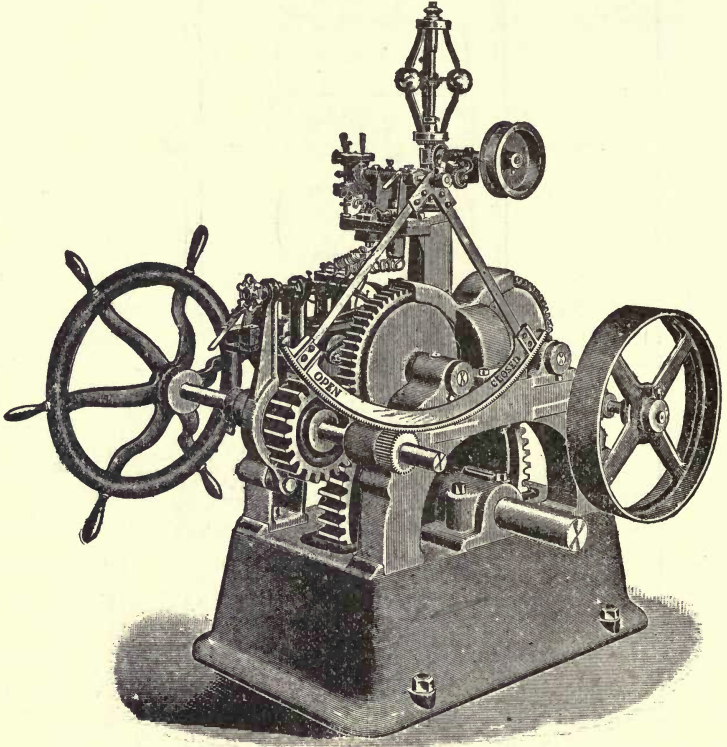

FIG. 216.

Fig. 217 shows its performance in governing a railway load under conditions of unusual severity. As in Fig. 213, 20 minutes of operation are plotted and the maximum variation from 105 revolutions per minute, the normal speed, is less than 10 revolutions, and that variation lasted less than 20 seconds and was due to the opening of the circuit-breaker. Such work is quite good enough to meet all ordinary conditions.

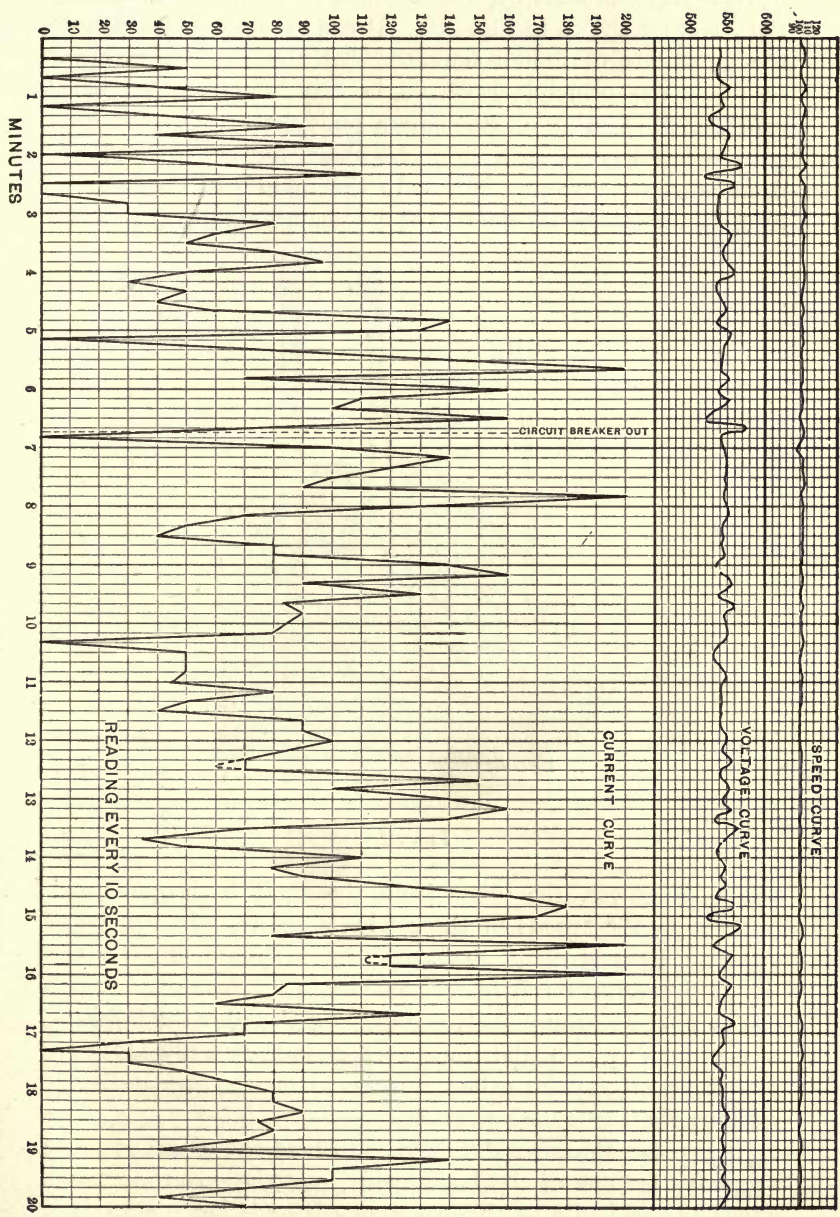

FIG. 217.

To a very different type of mechanism belongs the differential governor shown in Fig. 218. It has been applied widely to the governing of Pelton impulse wheels, with very excellent results. The principle involved is very simple. Two bevel gears, each carrying on its shaft a pulley, are connected by a pair of bevel gears on a crosswise shaft, forming a species of dynamometer gearing. Normally the main gears are driven in opposite directions, the one at a constant speed by a special

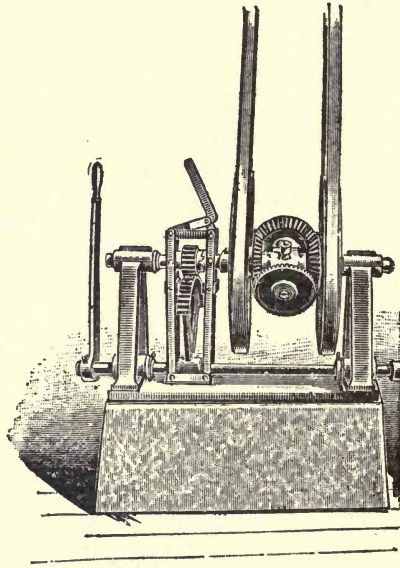

FIG. 218.

source of power, the other from the shaft to be governed. So long as the speeds of these wheels are exactly equal and opposite, the transverse shaft remains stationary in space and the gate moving mechanism attached to it is at rest. When, however, the working shaft changes speed under the influence of a change in load, the transverse shaft necessarily moves in one direction or the other and keeps on moving until the working shaft gets back to speed.

In practice the main difficulty is to hold the constant speed necessary for one of the bevel gears, and the governor works admirably or badly as this constancy is or is not maintained.

A heavy fly wheel on the constant speed side is desirable, and its motive power should be quite independent of the main drive. Perhaps the best result is obtained by using a second, small, differential governor to hold the speed uniform at the main governor. With the high heads and balanced deflecting nozzles usual in Pelton wheel practice, this form of governor is very sensitive and does not hunt noticeably, owing to the small inertia of the moving parts. It gives good regulation under all conditions except extreme variations of load where the wheel is loaded beyond the power of the jet to enforce prompt recovery of speed, and is well suited to the conditions under which Pelton wheels are generally used.

The greatest difficulty in hydraulic governing is that of hydraulic inertia. Water moves sluggishly through long and level pipes, and its velocity does not change promptly enough for good governing, unless the waterways are planned with that in view. If a wheel is at the end of a long and gently sloping penstock it takes a certain definite amount of time to get that water column under way or checked in response to the movement of the gates. And the longer this time constant of the water column the more difficult it is to get accurate governing, however good the governing mechanism may be. For by the time the water gets fairly into action the load conditions may have changed, and the governor may be again actively at work trying to readjust the speed.

In order to get accurate governing it is absolutely necessary to keep the time constant of the waterways as small as possible. To accomplish this the regulating gate should obviously be right at the wheel and the penstock should be as short and as nearly vertical as possible. The most favorable condition for governing is when the wheel is practically in an open flume. If steel penstocks are used they should pitch as sharply down upon the wheels as conditions permit, something after the manner of Fig. 208. If long head pipes must be used governing will become difficult, although much help can be obtained from an open vertical standpipe connected with the penstock close to the wheel. The contents of this pipe serve as a pressure column if the gate is suddenly opened and as a relief valve if the gate suddenly closes, averting the some-

times serious pressure due to the violently checked stream. Plate XIV shows such a standpipe in action just after a heavy electric load had been thrown off. The water normally stands very near the top of the pipe, which begins to overflow with a slight increase of the hydraulic pressure.

Under high heads such a standpipe is of course impracticable, and although some forms of relief valve are of use, the conditions of governing are not easy until one comes to the impulse wheel with a deflecting nozzle.

Not all water-wheels are governed with equal ease. If the gates are properly balanced a comparatively small amount of power will manage them promptly, and the wheel is governed without trouble. But there are some wheels on the market with gates under so much unbalanced pressure that proper governing is difficult or impossible. There is no excuse for the existence of such wheels, for they do not have compensating advantages, and they should be shunned. All the typical wheels which have been described in this chapter govern easily, however, as do many others. It is worth while to remember that good governing is absolutely indispensable for good service, and although one finds cases in which the load is so steady that the wheels can almost go without governing, such are rare exceptions to the general rule.

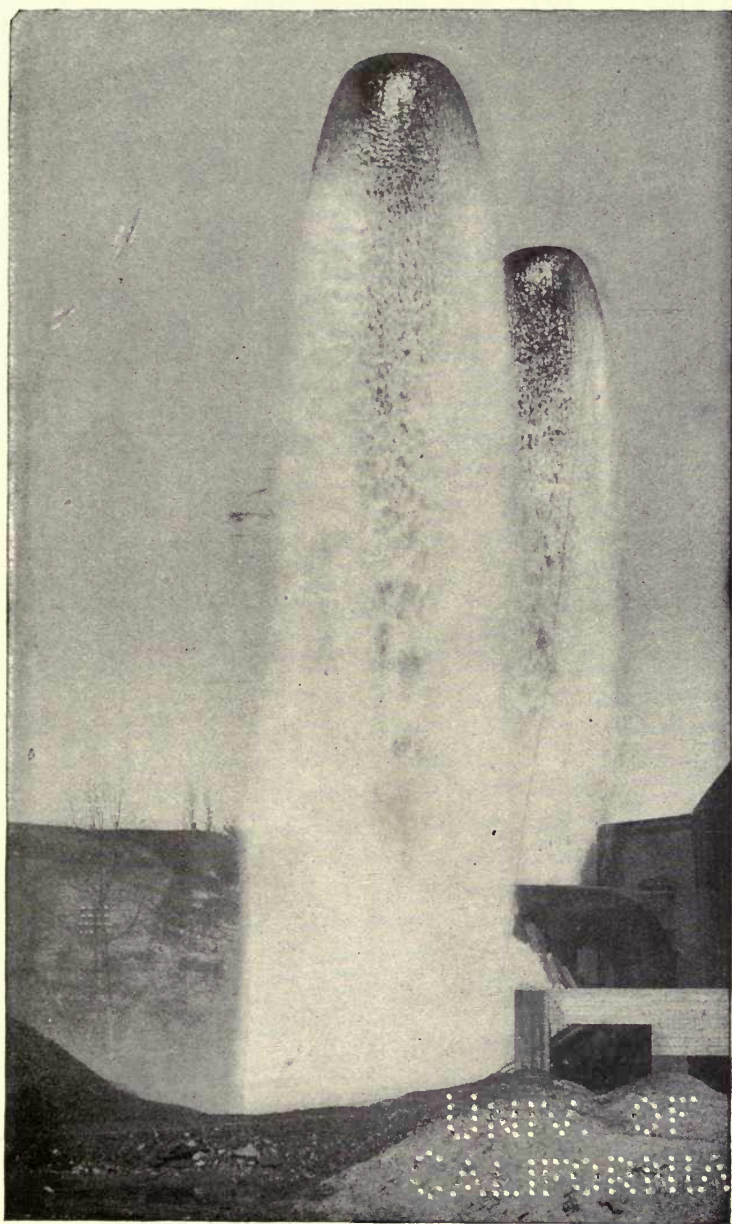

PLATE XIV.

CHAPTER X.

HYDRAULIC DEVELOPMENT.

So much electrical transmission work depends on the utilization of water-powers that it is worth while briefly to consider the subject of developing natural falls for such use. The subject is a large one, quite enough to fill a volume by itself, and the most that can be done here is to point out the salient facts and put the reader in possession of such information as will enable him to avoid serious blunders and to take up the subject intelligently.

Natural water-powers of course vary enormously in their characteristics. In our own country, where water-power is very widely distributed, we find three general classes of powers, often running into each other but still sufficiently distinct to cause the methods of developing them to be quite well defined.

By far the best known class of powers are those derived from the swift rivers that are found in New England and other regions in which the general level of the country changes rather rapidly. They flow through a country of rocky and hilly character, and large or small, are still swift, powerful streams, with frequent rapids and now and then a cascade. Such rivers are generally fed to no small extent by springs and lakes far up toward the mountains, and catch in addition the aggregated drainage of the irregular hill country through which they flow. Types of this class are the Merrimac and the Androscoggin among the New England rivers, the upper Hudson, and many others. Another and quite different class of powers are those derived from the slow streams that flow through a flat or rolling alluvial country — the Mississippi valley and the lowlands of the Southern Atlantic States. Although possessed of many tributaries that spring from among the mountains, the great basins which they drain form the main reliance of rivers of this kind — immense areas of fertile country the aggregated rainfall of which supports the streams.

Finally, there are many fine water-powers that come from mountain streams, fed from little springs among the rocks, from the melting of the winter snows and the drainage of heights which the snow never deserts, and from the rain gathered by desolate gorges.

These mountain rivers often furnish magnificent powers, easy and cheap to develop, but very variable. In summer the stream may dwindle to a mere brook, while in spring, from the combined effect of rains and melting snow, it may suddenly increase even many thousand fold, becoming a tremendous torrent that no works built by man can withstand. The available heads are often prodigious, from a few hundred to more than a thousand feet, and the volume of water may seem at first sight absurdly small, but when, as in the Fresno (Cal.) plant to be described later, each cubic foot flowing per second means 140 mechanical HP delivered by the wheels, large volume is needless.

Upland rivers like those common in New England, seldom give opportunity for securing high heads. Most of the powers developed show available falls ranging from 20 to 40 feet. Unless the stream has considerable volume, such low heads do not yield power enough to serve anything but trivial purposes — only two or three HP per cubic foot per second. Upland rivers, however, furnish the great bulk of the water-power now utilized, for they furnish fairly steady and cheap power under favorable conditions. Although subject to considerable, sometimes formidable, freshets, when the snow is melting or during heavy rains, they are generally controllable without serious difficulty.

Lowland streams seldom offer anything better than very low heads, rarely more than 10 to 15 feet, and consequently demand an immense flow to produce any considerable power. They are, however, as a class rather reliable. The size and character of the drainage basin makes extremely low or extremely high water rare, and only to be caused by very great extremes in the rainfall. Such streams furnish a vast number of very useful powers of moderate size, forming a large aggregate but seldom giving opportunity for any striking feats of hydraulic engineering, at least in our own country, where fuel is generally cheap.

In taking up any hydraulic work with reference to electrical power transmission, or any other purpose in fact, the first necessary step is to make a sort of *reconnaissance*, to ascertain the general topography of the region, the available head, and the probable flow. The first two points are generally easy to determine from existing surveys or by a brief series of levels, the last named requires a combination of educated judgment and careful engineering. The U. S. Geological Survey maps are invaluable, when available, for getting a preliminary idea of the topography and the probable drainage basin. The facts are not really very difficult to get at, but guesswork is emphatically out of order and heresay evidence even more worthless than usual. The author has seen more than one mighty torrent dwindle into a trout brook when looked at through untinted spectacles.

The only way to find out how much flow is available is to measure it carefully, if it has not already been measured in a thorough and trustworthy manner — not once or twice or a dozen times, but weekly or, better, daily, for an entire season at least; the more thoroughly the better. A knowledge of the absolute flow at one particular time is interesting, but of little value compared with a knowledge of the variations of flow from month to month, or from year to year.

Such a series of measurements tells two very important things — first, the minimum flow, which represents the maximum power available continuously without artificial storage of water; and second, the aggregate flow during any specified period, which shows the possibilities of eking out the water supply by storage.

The methods of measurement are comparatively simple. For small streams the easiest way is to construct a weir across the stream and measure the flow over a notch of known dimensions in this weir. Such a temporary dam should be tight and firmly set, and high enough to back up the water into a quiet pool free from noticeable flow except close to the edge of the weir. There should be sufficient fall below the bottom of the notch in the weir to give a clear and free fall for the issuing water — say two or three times the depth of the flow over the weir itself.

Fig. 219 shows clearly the general arrangement of a measuring weir. Here *A* shows the end supports of the weir, here composed of a single plank, while *B* is the lower edge of the notch through which the water flows. This edge *B*, as well as the sides of the notch, should be chamfered away to a rather sharp edge on the upstream side, which must be vertical. Back some feet from the weir so as to be in still water, should be set firmly a post *E*, the top of which is on exactly the same level as the bottom of the weir notch *B*. *D* shows this level, while the line *C* shows the level of the still water. The quantities to be exactly measured are the length of the notch *B*

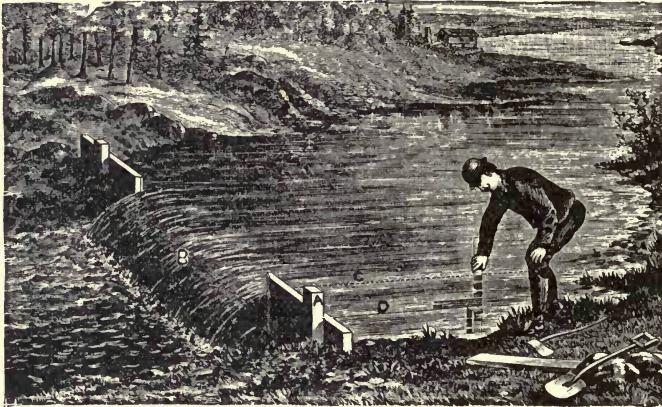

FIG. 219.

and the height from the level of the edge of *B* to the normal level surface of the water in the pool. This can be done generally with sufficient accuracy by holding or fixing a scale on the top of the post *E*. If we call the breadth of the notch *b*, and this height *h*, both measured in feet, the flow in cubic feet per minute is

$$Q = 40 c b h \sqrt{2 g h}.$$

Here *g* is 32.2 and *c* is the "coefficient of contraction," which defines the ratio of the actual minimum area of the flowing jet to the nominal area *b h*.

This coefficient varies slightly with the width of the notch

as compared with the whole width of the weir dam. Calling this w , the value of c is approximately

$$c = 0.57 + 10 \frac{b}{w}.$$

This gives $c = .62$ for a notch half the width of the weir and $c = .67$ for the full width of the weir. For notches below one-quarter the width of the weir the values of c become somewhat uncertain, and as a rule b should be over half of w . Further, the notch should not be so wide as to reduce the water flowing over it to a very thin sheet. It is best to arrange the notch so that the depth of water h may be anywhere a tenth to a half of b . For purposes of approximation weir tables are sometimes convenient. These give usually the flow in cubic feet per minute corresponding to each inch in width b , for various values of h . Such a table, condensed from one used by one of the prominent turbine makers, is given below. Where quite exact measurement is required the constant c should be determined from the actual dimensions and a working table deduced from it.

TABLE OF WEIRS.

Inches and Fractions Depth on Weir.	0	$\frac{1}{4}$	$\frac{1}{2}$	$\frac{3}{4}$
1.....	0.40	0.56	0.74	0.97
2.....	1.14	1.36	1.59	1.84
3.....	2.09	2.36	2.64	2.93
4.....	3.22	3.53	3.85	4.17
5.....	4.51	4.85	5.25	5.56
6.....	5.92	6.30	6.68	7.07
7.....	7.46	7.87	8.28	8.70
8.....	9.12	9.55	9.99	10.43
9.....	10.88	11.34	11.80	12.27
10.....	12.75	13.23	13.72	14.21
11.....	14.71	15.21	15.72	16.24
12.....	16.76	17.28	17.82	18.35
13.....	18.89	19.44	20.00	20.56
14.....	21.12	21.68	22.26	22.83
15.....	23.42	24.01	24.60	25.19
16.....	25.80	26.41	27.02	27.63
17.....	28.26	28.88	29.51	30.14
18.....	30.78	31.43	32.07	32.73

Cubic feet per minute per inch of width.

West of the Rocky Mountains a special system of measuring water by "miner's inches" has come into very extensive use.

It originated in the artificial distribution of water for mining and irrigating purposes, and has since extended to a conventional measurement for streams. The miner's inch is a unit of constant flow, and varies somewhat from State to State, its amount being regulated by statute in various States. It is the flow through an aperture 1 inch square under a specified head, frequently 6 inches. The method of measurement is shown in Fig. 220. The water is led into a measuring box closed at the end except for an aperture controlled by a slide. The end board is $1\frac{1}{4}$ inch thick, and the aperture is 2 inches

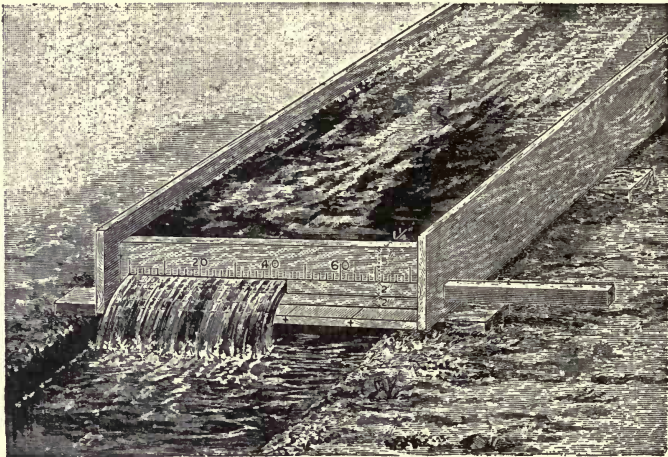

FIG. 220.

wide, its bottom is 2 inches above the bottom of the box, and its centre 6 inches below the level of the water. Each inch of length of the aperture then represents 2 miner's inches. Under these conditions the flow is 1.55 cubic feet per minute for each miner's inch. Under a $4\frac{1}{2}$ inch effective head, which is extensively used in southern California and the adjacent regions, the miner's inch is about 1.2 cubic feet (9 gallons) per minute.

For streams too large to be readily measured by the means already described, a method of approximation is applied as follows:

Select a place where the bed of the stream is fairly regular and take a set of soundings at equal intervals, *a, b, c, d*, Fig. 221, perpendicular to the direction of flow, using a staff rather than a sounding line, as it can more easily be kept perpendicular. Ascertain thus the area of flow. Then establish two lines across the stream, say 100 feet apart and nearly equidistant from the line of soundings. Then throw floats into the stream near the centre and time their passage across the two reference lines. This establishes the velocity of the flow across the measured cross section. As the water at the bottom and sides of the channel is somewhat retarded, the average velocity is generally assumed to be 80 per cent of that measured as above in the middle of the stream.

The more complete the data on variations of flow, the

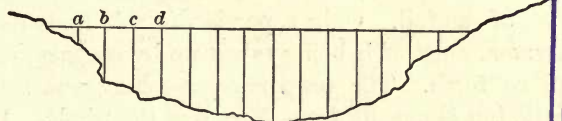

FIG. 221.

CIVIL ENGINEER
U. of C.
ASSOCIATION LIBRARY

better. The most important point to be fixed is the flow at extreme low water, both in ordinary seasons and seasons of unusual drought. Except on very well-known streams previous data on this point are generally not available. The flow should therefore be measured carefully through the usual period of low water during at least one season. From the minimum flow thus obtained there are various ways of judging the minimum flow in a very dry year. Sometimes certain riparian marks are known to have been uncovered in some particular year, and the relative flow can be computed from the difference thus established. Again, the records of a series of years may be obtained from a neighboring stream of similar character, and the ratio between ordinary and extraordinary minima assumed to be the same for both. This assumption must be made cautiously, for neighboring streams often are fed from sources of very different stability.

Failing in these more direct methods, recourse may be taken to rainfall observations. For this purpose the rainfall in the basin of the stream should be measured during the continuance of the observations on flow. By noting the effect of known rainfall on the flow of the stream, one can make a fairly close estimate of the flow in a very dry year in which the rainfall is known by months, or for an assumed minimum rainfall. In a similar way can be ascertained the probable high water mark, record of which is often left by *débris* on the banks.

In a fairly well-known country the conditions of flow can be approximated by reference to rainfall alone. The area drained by the stream down to the point of utilization can be closely estimated. If rainfall observations in this district are available, or can be closely estimated from the results at neighboring stations, one may proceed as follows: The total water falling into the basin is 2,323,200 cubic feet per square mile for each inch of rainfall. Only a portion of this finds its way into the streams, most of it being taken up by seepage, evaporation, and so forth. The proportion reaching the streams varies greatly, but is usually from .3 to .6 of the whole. If this proportion is known from observations on closely similar basins and streams the total yearly flow can be approximated, and if the distribution of flow on a similar stream is known, one can make a tolerable estimate of the amount and conditions of flow in the stream under investigation.

This process is far from exact, since the proportion of the total water which is found in the streams varies greatly from place to place, and with the total rainfall in any given week or day. The sources of loss do not increase with the total precipitation, and the only really safe guide is regular observation of the rainfall and the flow during the same period. At times, however, rainfall estimates are about the only source of information available and when made with judgment are decidedly valuable. In a well investigated country they are sometimes surprisingly accurate.

A good idea of the uncertainties of hydraulic power can be gathered from the recorded facts as regards the Merrimac, one of the most completely and carefully utilized American

streams, which has been under close observation for half a century. The area of its watershed above Lowell, Mass., is 4,093 square miles and the mean annual rainfall of the region is about 42 inches. The observations of many years indicate that the maximum, minimum, and mean flows are on approximately the following basis:

(Spring).....	Maximum, 90 cubic feet per minute per square mile
(June)	Mean, 55 cubic feet per minute per square mile
(August, September) ..	Minimum, 30 cubic feet per minute per square mile

The annual rainfall, if it all could be reckoned as in the stream and uniformly distributed, would amount to very nearly 180 cubic feet per minute per square mile of watershed. In fact, this flow is reached or passed only on occasional days of heavy freshets during the spring rains, when the snow is melting rapidly. The normal maximum flow is just 50 per cent of the conventional average, while the real average falls to about 30 per cent and the minimum to less than 17 per cent. Of late years this minimum has sometimes been still smaller, little over 10 per cent instead of 17, a state of things due to the destruction of the forests on the upper watershed. In a heavily wooded country the rainfall is long retained and finds its way to the streams slowly and gradually. When the forests are cut off the water runs quickly to the streams, and the result is heavy seasons of freshets when the snow is melting — all the more rapidly because of lack of forest shade — and extreme low water during the dry months. In a bare country the variations of flow are often prodigious, and without storage one can safely reckon only upon the minimum flow of the driest year. As the denudation of the uplands goes on hydraulic development will steadily grow more expensive.

One cubic foot per second per square mile of drainage area is a figure often used to determine the average flow for which development should be planned and in streams like those of New England this estimate is not far from the truth.

In some streams, generally in hot climates, no small part of the flow is during the dry season in the strata underlying the apparent bed of the stream, and can be in part, at least, captured by carrying down the foundations of the permanent works.

When the flow has been ascertained the available HP is easily computed. The practicable head can be easily determined by a little leveling. If H is this head in feet and Q the flow in cubic feet per minute, then the theoretical HP of the stream is

$$\text{HP} = \frac{62.4 H Q}{33,000}.$$

The mechanical HP obtained by utilizing the stream in water-wheels is this total amount multiplied by the efficiency of the wheels, usually between .75 and .85. At 80 per cent efficiency the proceeding formula reduces to

$$\text{HP} = \frac{H Q}{650},$$

which gives the available mechanical horse-power directly. In many streams the available head is limited by the permissible overflow of the banks as determined by the rights of other owners, or by danger of backing up the stream to the detriment of powers higher up. These conditions must be determined by a careful survey.

Before taking up seriously the development of a water-power it is advisable to enter into an examination of the legal status of the matter, which is sometimes very involved. The general principle of property in streams is that the water belongs in common to the riparian owners, and cannot be employed by one to the detriment of another. But each State has a set of statutes of its own governing the use of water for power and other purposes, often of a very complicated character, involved with special charters to storage and irrigation companies and other ancient rights, so that the real rights of the purchaser of a water privilege are often limited in curious and troublesome ways, especially when the stream has been long utilized elsewhere.

Generally the riparian owners have full rights to the natural flow of the stream, which is often by no means easy to determine. The laws of various States regarding the matter of flowage vary widely, and altogether the intending purchaser will find it desirable to investigate carefully not only the title

to the property, but the limitations of the rights which he would acquire.

In streams of small volume carried through pipe lines the effective head is diminished by friction in the pipes. This loss has already been discussed in Chapter II. In any case where water is carried in canals or open flumes there will be, too, a slight loss of head, generally trivial.

It often happens that there is so great a difference between the normal flow of the stream during most of the year and its minimum flow during a few weeks as to make it highly desirable to store water by impounding it, so as to help out the sometimes scanty natural supply. With mountain streams under high head this is frequently quite easy. Even when it is impracticable to impound enough to help out during the whole low water period, it is sometimes very useful to impound enough to last for a day or two in case of necessary repairs.

A certain reservoir capacity is quite necessary, so as to permit the storage of water at times of light load for utilization at times of heavy load. This process is carried out on a vast scale on the New England rivers, where the water, used during the day in textile manufacturing, is stored in the ponds at night as far as possible. While electric transmission plants do not offer the same facilities for storage, since they generally run day and night, the application of the same process would often greatly increase their working capacity and greatly lower the fixed charges per hydraulic HP. Such storage is especially valuable in cases where the water supply is limited, as it often is in plants working under high heads. Every cubic foot of water is then valuable and should be saved whenever possible. Regulation by deflecting nozzles, which is very generally employed in this class of plants, is particularly objectionable on the score of economy, and ought to be replaced by some more efficient method.

As an example of what can be done with storage under high heads, it happens that at 650 feet effective head one mechanical HP requires almost exactly one cubic foot of water per minute at 80 per cent wheel efficiency. For a 500 HP plant, then, the water required is 30,000 cubic feet per hour.

One can store 43,560 cubic feet per acre per foot of depth,

so that a single acre 10 feet deep would store water enough to operate the plant at full load for $14\frac{1}{2}$ hours, or under ordinary conditions of load for a full day. If the flow in the stream were only 15,000 cubic feet per hour in time of drought, the acre would yield two days supply and 15 acres would carry the plant for a month. Such storage is common enough in irrigation work, and is capable of enormously increasing the working capacity of a transmission plant, even at a head much less than that mentioned.

With even 100 feet available head, it is comparatively easy to impound water enough to assist very materially in tiding over times of heavy load and in increasing the available capacity.

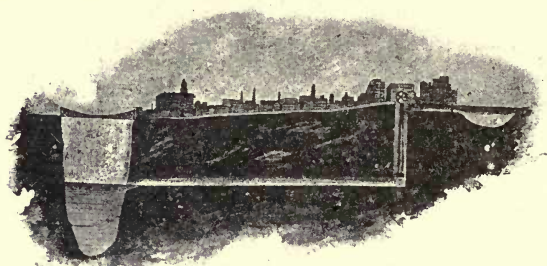

FIG. 222.

A survey with storage capacity in view should be made whenever storage is possible, and the approximate cost of storage determined. A little calculation will show in how far it can be made to pay.

In general the utilization of a water-power consists in leading the whole or a part of a stream into an artificial channel, conducting it in this channel to a convenient point of utilization, and then dropping it back through the water-wheels into the channel again, usually via a tail-race of greater or less length.

Except where there is a very rapid natural fall a substantial dam is necessary, which backs up the water into a pond, usually gaining thus a certain amount of head, whence the water is led in an open canal to some favorable spot from which it can be dropped back into the channel at a lower level.

The canal may vary in length from a few rods to several miles, according to the topography of the country. The tail-race leading the water from the wheels back to the stream is short, except in rare instances like the great Niagara plant. In this case, shown somewhat roughly in Fig. 222, the usual construction was reversed. To obtain ample clear space for manufacturing sites and the like, the water was utilized by constructing above the cataract an artificial fall at the bottom of which the wheels were placed. From the bottom of this huge shaft, cut 178 feet deep into the solid rock, the water is taken back into the

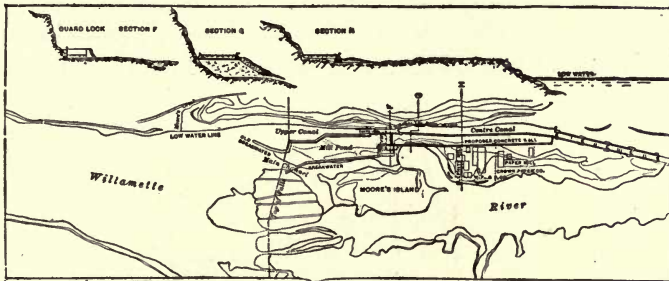

FIG. 223.

river through a tunnel 7,000 feet long, which constitutes the tail-race.

In the case of mountain streams having a very rapid fall, the dam is often quite insignificant, serving merely to back up the water into a pool from which it may be conveniently drawn, and in which the water may be freed of any sand that it carries, or even to deflect a portion of the water for the same purpose. In such cases the water is usually carried in an iron or steel pipe, following any convenient grade to the bottom of the fall chosen, at which point its full pressure becomes available.

In ordinary practice at moderate heads the volume of water has to be so considerable for any large power as to make a long canal very expensive. Further, it usually happens that the topography of the country is such as to make it very difficult to gain much head by extending the canal. Thus the points chosen for power development must be those where there is a rather rapid descent for a short distance — falls or considerable rapids. Then a dam of moderate height gives a

fair head by simply carrying the canal to a point where the water can be readily returned to the stream below the natural fall. The more considerable this fall the less need for an elaborate dam, which may become simply a means of regulating the flow of water without noticeably raising the head.

A fine example of this sort of practice is shown in Fig. 223, which shows a plan of the hydraulic development of the falls of the Willamette River at Oregon City, Ore. The river at this point gives an estimated available HP of 50,000 under 40 feet head. The stream plunges downward over a precipitous slope of rough basalt, and the low dam which follows the somewhat irregular shape of the natural fall, is hardly more than an artificial crest to guide the water toward the canal on the west

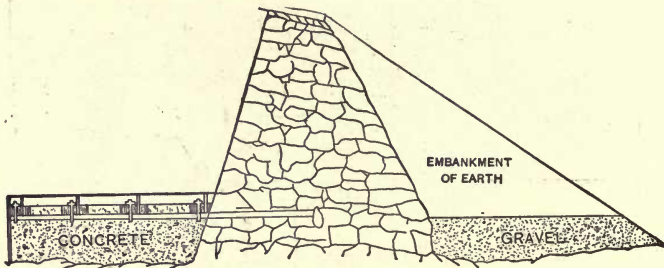

FIG. 224.

bank of the stream. This canal has recently been widened, and both constructions are shown in the figure. The fine three-phase transmission plant of the Portland General Electric Company now faces on the new canal wall near the section G. At the end of the canal downstream a series of locks lead down to the lower river, making the falls passable for river craft. Only a small part of the available power is as yet used.

Almost every river presents peculiarities of its own to the hydraulic engineer. Generally the dam is a far more prominent part of the work than at Oregon City, and adds very materially to the head. Choosing a proper site for the dam, and erecting a suitable structure, requires the best skill of the hydraulic engineer. Bearing in mind that the function of a dam is to merely retain and back up the flowing water, it is evident that it may be composed of a vast variety of materials

put together in all sorts of ways. Stone, logs, steel, all come into play combined with each other and with earth.

The character of the river bed which furnishes the foundation is a very important factor in determining the material and shape of the dam used. When the bed is of rock or of that hard packed rubble which is nearly as solid, a well-built stone dam is the best, as it is also the costliest, construction. For such work the way is cleared by a coffer dam and the masonry is

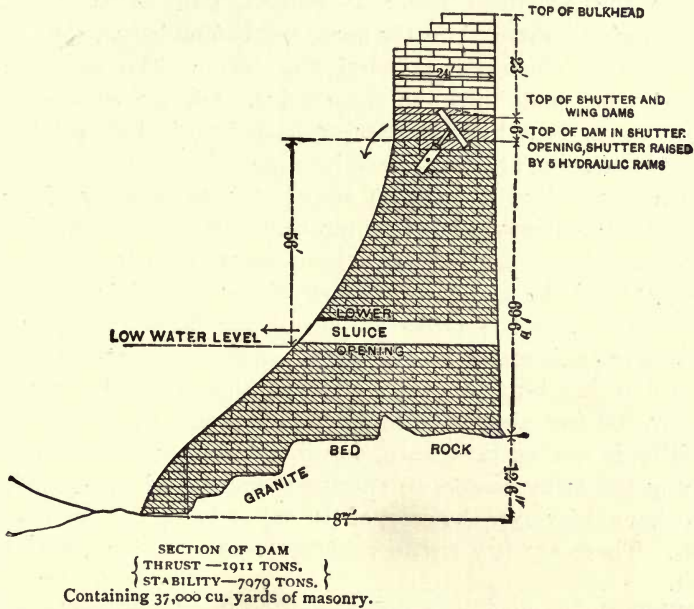

FIG. 225.

laid, if possible, directly upon the bedrock. When the bottom is hard pan a deep foundation for the masonry is almost as good as the ledge itself, while on a gravel bottom sheet piling is sometimes driven and the stone work built around it. The ground plan is very frequently convex upstream, giving the effect of an arch in resisting the pressure of the water. Fig. 224 shows a section of a typical masonry dam, built over sheet piling in heavy gravel. This particular dam is 22 feet 6 inches high and nearly 300 yards long. The coping is of solid granite slabs a foot thick. Below the dam lies the usual apron of

timber and concrete, with timber sills anchored into the dam itself. The flooring of the apron, of 12×12 inch timbers laid side by side, is bolted to the foundation timbers laid in the concrete. The purpose of this apron, as of such structures in general, is to prevent undermining of the dam by the eddies below the fall.

A still finer example of the masonry dam is shown in Fig. 225 — the great dam of the Folsom Water Power Company across the American River at Folsom, Cal. It is built of hewn granite quarried on the spot, and is founded on the same ledge from which the material was taken. The abutments likewise are built into the same ledge. On the crest of the dam proper is a huge shutter or flash board, 185 feet long, capable of being swung upward into place by hydraulic power. When thus raised it gives an added storage capacity of over 13,000,000 cubic yards of water in the basin above. This dam furnishes power for the Folsom-Sacramento transmission, now part of the immense network of the California Gas and Electric Co., and it ranks as one of the finest examples of hydraulic engineering in existence. Including the abutments it is 470 feet long, and the crest of the abutments towers nearly 100 feet above the foundation stones. Its magnificent solidity is not extravagance, for the American River carries during the rainy season an enormous volume of water, filling the channel far over the crest of the dam when at its maximum flow. There are few streams where greater strains would be met.

While these masonry dams are splendidly strong and enduring, they are also very expensive, and hence unless actually demanded for some great permanent work are less used than cheaper forms of construction. In many situations these are not only cheaper in first cost, but even including depreciation. There are divers forms of timber dam which have given good service for many years at comparatively small expense. Of such dams, timber cribs ballasted with stone are probably under average conditions the best substitute for solid masonry. These crib dams when well built of good materials, are very durable and need few and infrequent repairs. Some such dams, replaced after twenty-five or thirty years in the course of

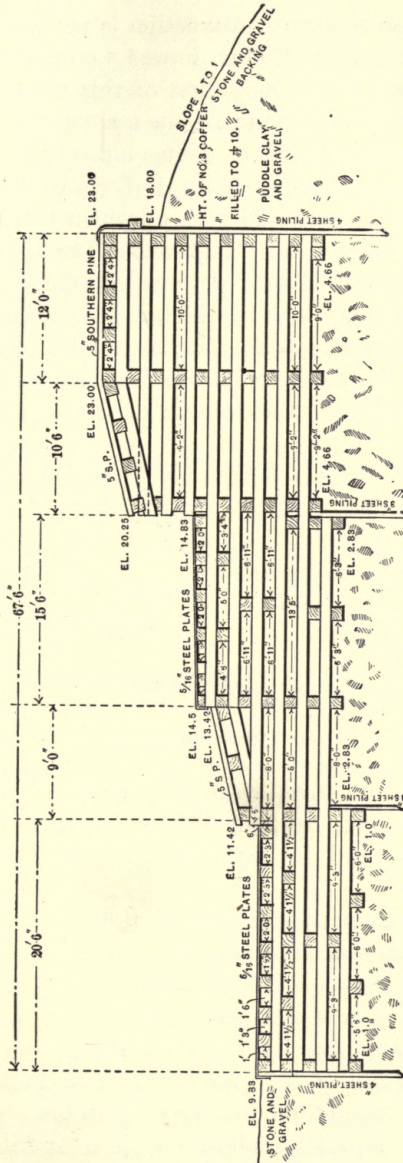

changing the general hydraulic conditions, have shown timbers as solid as the day they were put down, and capable of many years' further service.

A fine example of such construction is the dam of the Concord (N. H.) Land & Water Power Company, at Sewall's Falls on the Merrimac. A section of this structure is shown in Fig. 226. The foundation is in the main gravel, in which the dam is made secure by sheet piling and stone ballast. The structure is essentially a very solid timber crib with a very long apron. The total head is 23 feet, of which more than half is due to the dam, as shown in the levels. The apron is armored with five-sixteenths inch steel plate, the better to withstand the bombardment of stray logs to which it is sometimes subjected. The abutments are of granite. It has proved very serviceable, having successfully withstood several tremendous freshets with no damage save some undermining of one of the abutments,

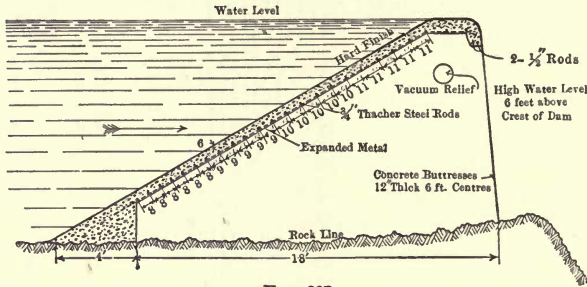

FIG. 227.

which has been repaired with crib work. Considering the character of the river bed, this dam is probably as reliable as one of masonry, and its cost was little over half that of a masonry dam.

For small streams these ballasted timber dams are admirable, and little more is needed in most cases.

Another very convenient and useful form of dam, of which many examples have of late been erected, is shown in Fig. 227. It is a concrete and steel dam of the gravity type in which the dam is given stability far above that due to its structural weight, by the weight of the superincumbent water. It is unusual in that it really follows modern architectural lines instead of conventional hydraulic construction, and the form here shown, devised by Mr. Ambursen, of Watertown, N. Y., involves a good many novel features. Fig. 228 gives a section

of the dam which is essentially an inclined concrete and steel floor supported by concrete buttresses. The dam here shown is about 12 feet high and the supporting buttresses are of the section indicated in the figure, 12 inches thick and spaced 6 feet between centres. Along the upstream slope of these buttresses there are set in the concrete, connecting the buttresses, a series of $\frac{3}{4}$ inch twisted steel rods about 8 inches between centres, and just below them covering the whole slope are sheets of heavy "expanded metal." Over and about this steel substructure is laid a tight concrete floor about 6 inches thick, merging at the toe of the dam into a massive concrete shoe filling the space between the buttresses and built upon the foundation ledge. Near the top of the dam the slope is made with a hard finish of rich concrete and the top itself is made extra heavy to resist the rush of the water.

These dams are sometimes built with concrete downstream faces and aprons, and in fact may take any form that occasion requires. They are tight and strong, and ought to prove durable, while the cost is usually little more than that of a timber crib. They are, like concrete work generally, quickly erected, and seem specially adapted to long runs of moderate height, although they are being used for heights of 30 feet and more, and when properly designed would appear to be as generally applicable as any other construction. A similar construction can sometimes be advantageously used for flumes and canal walls, since concrete work can be done with material easily available, and with a very small proportion of skilled labor, and when well done is both strong and durable.

The type of dam selected for any particular case is governed by the hydraulic requirements and the conditions at the proposed site, and the relative costs can only be settled by close estimates. Sometimes massive rubble masonry is about as cheap as anything else, while in other circumstances concrete or timber would show the minimum cost.

The canals leading the water to the wheels are of construction as varied as the dams, depending largely on the nature of the ground. Sometimes they are merely earthwork, oftener they are lined with timber, concrete, or masonry. Canal construction is a matter to be decided on its merits by the

hydraulic engineer, and very little general advice can be given. For low heads wooden pipes made of staves like a barrel and hooped with iron every 3 or 4 feet are sometimes used. In many situations this construction is cheaper than steel pipe and answers admirably. Such wooden pipes are considerably employed in the West, the material being generally redwood, and have proved remarkably durable, some having been in use



FIG. 228.

for more than twenty years. Open timber flumes are also widely used.

For very high heads, canals and flumes are almost universally replaced by iron or steel riveted pipe taken by the nearest route to the wheels below. This practice has been general on the Pacific coast and has given admirable results. The pipes are asphalted inside and out to prevent corrosion, and some pipe lines have been in service for a quarter of a century without marked deterioration. Large pipes and those for very heavy pressures are usually made of mild steel. The

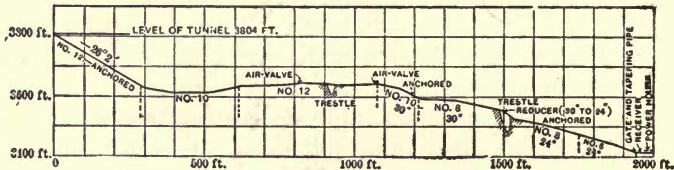

FIG. 229.

pipes are customarily made in sections for shipment, from 20 to 30 feet long, and the slip joints are riveted or packed on the ground. For transportation over very rough country and for very large pipes, the sections may be no more than 2 or 3 feet long. The joints are then asphalted on the ground. Fig. 228 shows several of these short sections joined together, exhibiting the nature of the riveting and the terminal slip joint.

In running such a pipe line it is usually taken in as straight a course as possible, and is laid over, on, or under the ground as occasion requires, usually on the surface, conforming to its general contour. In long lines the upper end is somewhat larger and thinner than the lower, which has to withstand the heavy pressure. Fig. 229, which is a profile to scale of the pipe line of the noted San Antonio Cañon plant in southern California, gives an excellent idea of good modern practice in this sort of work. There is here a total fall of about 400 feet in a distance of 2,000 feet. The main pipe is 30 inches in diameter, and the steel is of the gauges indicated on the various sections. At

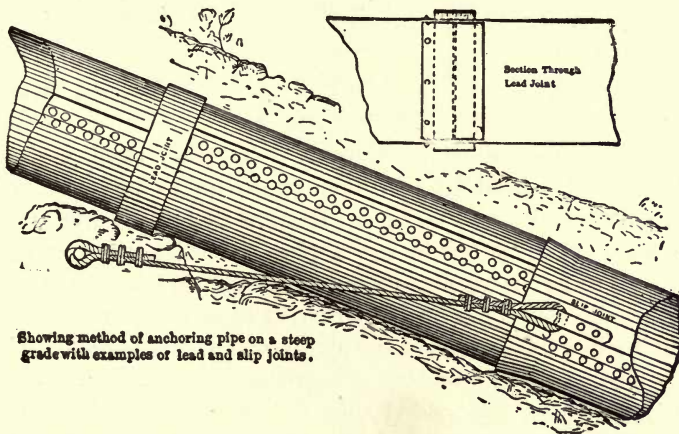

FIG. 230.

the crests of two undulations, air valves are placed to ensure a solid and continuous column of water in the pipe. The last 540 feet of pipe is reduced to 24 inches and the gauge of steel is somewhat heavier. The total length of the pipe line is 2,370 feet. To protect the pipe against great changes of temperature it was loosely covered with earth, rock, and brush whenever possible. At two sharp declivities the pipe was anchored to the rock.

The general method of anchoring on a steep incline is shown in Fig. 230. In this case the slip joint is simply calked, and where consecutive sections are at an angle, a short sleeve is fitted over the joint and lead is run in as shown in the cut.

Often a packed slip joint is used very freely, thereby gaining in flexibility, and riveted joints may be only used occasionally. The line is generally started from the lower end and the joints or the whole interiors of the sections asphalted as they are laid. The following table gives the properties of steel hydraulic pipe of the sizes in common use, and double riveted:

Diameter in inches....	10	12	14	16	18	20	24	30	36	42
Area in square inches.	78	113	153	201	254	314	452	706	1,017	1,385
Cubic feet per minute at three foot per second	100	142	200	255	320	400	570	890	1,300	1,760
Weight in pounds per foot	19.25	22.75	26	29.5	34	36.5	43.5	54	67	74.5
Safe head in feet.....	900	750	650	560	500	450	375	300	150	135
Change in safe head for each gauge number..	100	90	80	70	60	55	45	35	20	20

The pipe is assumed to be of No. 10 gauge steel, and the changes in safe head are of course approximate only, but hold with sufficient exactness for a variation of four or five gauge numbers. It is better to use a pipe too thick than one too thin, and to use extra heavy pipe at bends. Where the ground permits, the water can often be carried to advantage in a flume or ditch, and then dropped through a comparatively short pipe line. For heads approaching or surpassing 1,000 feet it is probably safer to use lap-welded tube for the lower portion of the run. In every case suspended sand must be kept out of the water, else it will cut the wheels and nozzles like a sand blast. When one remembers that under 400 feet head the spouting velocity of the water is about 160 feet per second, the need of this precaution is evident. A large settling tank is usually provided at the head works, spacious and deep enough to let the pipe draw from the clear surface water. At its lower end the pipe line terminates in a receiver — a heavy cylindrical steel tank of considerably larger diameter than the pipe proper, from which water is distributed to the wheels.

On very high heads a relief valve is attached at or near the receiver to avert danger from a sudden increase in pressure in the pipe, such as might be caused by some sudden obstruction at the gate.

This pipe line method of supply is considerably used for turbines of moderate size on heads as low as 75 to 100 feet, in cases where the natural fall of the stream is rather sudden. It really amounts to a considerable elongation of the iron penstock which is in common use. Whenever there is a sharp declivity in difficult country, piping is often easier and cheaper than constructing a sinuous flume or canal. In such situations the pipes may be 5 or 6 feet in diameter or even more, and being under very moderate pressure, may be comparatively light and cheap.

In cold climates ice is one of the difficulties most to be dreaded in hydraulic work. In high-pressure pipe lines there is little to fear, for fast-running water does not freeze easily and the pipes can generally be readily covered, as in the San Antonio Cañon plant, enough to prevent freezing. Large canals simply freeze over and the interior water is thus protected. But in cold climates there is considerable danger of the so-called anchor-ice. This is, in extremely cold weather, formed on the bed and banks of rapid and shallow streams. The surface does not freeze, but the water is continually on the point of freezing and flows surcharged with fine fragments of ice that pack and freeze into a solid mass with the freezing water rapidly solidifying about it. When in this condition it rapidly clogs the racks that protect the penstocks, and even the wheel passages themselves. In extremely cold climates under similar circumstances the water becomes charged with spicular ice crystals known as *frazil* in Canada, far worse to contend with than ordinary anchor-ice.

The best protection against ice is a deep, quiet pond above the dam, in which no anchor-ice can form, and which will attach to its own icy covering any fragments that drift down from above. In case of trouble from anchor-ice, about the only thing to do is to keep men working at the racks with long rakes, preserving a clear passage for the water. If the wheel passages begin to clog there is no effective remedy.

The most dangerous foe of hydraulic work is flood. The precautions that can be taken are, first, to have the dam and head-works very solid, and second, so to locate them if possible as to have an adequate spillway over which even a very large

amount of surplus water can flow without endangering the main works. If a pipe line is used it must be laid above high water mark, else the first freshet will probably carry it away. The power station must likewise be out of reach even of the highest water.

Closely connected with the subject of floods is that of variable head, which in many streams is a constant source of difficulty. In times of flood the extra height of the water above the dam is generally useless, while the tail-water rises and backs up into the wheels, cutting down their power and speed, often very seriously. This matter has already been discussed in Chapter IX, in so far as it is connected with the arrangement of the turbines. At very high heads this trouble vanishes, as no possible variation of the water level can be a considerable fraction of the total head.

The most delicate questions involved in hydraulic development are those connected with variable water supply. Having ascertained as nearly as possible the minimum flow, the minimum natural continuous supply of power is fixed, but it remains to be determined how the water in excess of this shall be utilized, if at all.

Three courses are open for increasing the available merchantable power. First, water can be stored to tide over the times of small natural supply. Second, a plant can be installed to utilize what water is available for most of the year and can be curtailed in its operation during the season of low water. Third, the service can be made continuous by an auxiliary steam plant in the power station. Storage of water can obviously be used in connection with either of the other methods.

Under very high heads storage is always worth undertaking if the lay of the land is favorable. This of course means a dam, but not necessarily a very high or costly one. If possible the storage reservoir should be a little off the main flow of the stream so as to escape damage from freshets. Reverting to our previous example of storage, suppose we have 500 HP available easily for nine months of the year, but a strong probability of not over 250 HP for the remaining three months. We have already seen that under these circumstances 15

acres flooded 10 feet deep will keep up the full supply for a month. If say 50 acres can be thus flooded, the all-the-year-round capacity of the plant will be doubled. In the mountainous localities where such heads are to be found, land has usually only a nominal value, and impounding the equivalent of this amount of water is frequently practicable. If it can be done at say a cost of \$75,000, the annual charge per HP stored, counting interest and sinking fund at 8 per cent, will be \$24, and the investment would generally be a profitable one. If the storage cost \$100,000, the annual charge would be \$32, and this would not infrequently be well worth the while, when power could be sold for a good price.

At lower heads the annual charge per HP stored would be considerably greater for the same total expenditure. Sometimes, however, storage capacity can be much more cheaply gained for both high and low heads, at for instance not more than half the charge just mentioned. The matter is always worth investigating thoroughly when there is doubt about supplying the power market with the natural flow. The points to be looked into are the nature and extent of the low water period, and the cost of developing various amounts of storage capacity. Sometimes the period of extreme low water is much shorter than that assumed, and storage is correspondingly cheaper.

There are some cases in which it is possible to supply customers with power for nine or ten months in the year, falling back on the individual steam plants in the interim. When transmitted power can be cheaply had, it is worth while for the power user who is paying say \$100 per HP per year for steam power, to take electric power at \$50 per HP per year for nine months, and to use steam the other three months. Certain industries, too, are likely to be comparatively inactive in mid-summer, or may find it worth while to force their output during the months when cheap power is obtainable, and shut down or run at reduced capacity when the power is unavailable. This is a matter very dependent on local conditions, and while the demand for such partial power supply is generally limited, there are many cases in which it would be advantageous for all parties concerned. In some mountainous

regions, winter is the season of low water owing to freezing, and various industries are suspended which may be profitably supplied with power when the winter unlocks its gates.

Eking out the water supply by an auxiliary steam power station is likewise not of general applicability, but sometimes may prove advantageous. It is most likely to prove useful in localities where a steam power plant would pay by virtue of the economy due to production on a large scale and distribution to small users. Cheap water-power a large part of the year then abundantly justifies adjunct steam-power when necessary. The moral effect of continuous power supply is valuable in securing a market. Whether such a supply is profitable depends on the ratio between the cost of water-power and the cost of steam-power. And it must not be forgotten that steam-power for two or three months in the year is relatively much more costly than continuous power.

The general charges are the same, although labor, coal, and miscellaneous supplies decrease nearly as the period of operation. Consequently, since there is this large fixed item, amounting to from 20 to 40 per cent of the total annual cost, the cost of power in a plant operated only three months will be relatively at least 50 per cent greater than if it were in constant operation. There must be a large margin in favor of water-power to justify this auxiliary use of steam, unless the latter would pay on its own account, as for instance in a plant used largely for lighting, which would be the most profitable kind of electric service were there a sufficiently large market. A large lighting load increases the peak considerably, but, as compensation, drops the peak notably during summer when low water generally comes. Particularly is this the case with public lighting which in summer does not overlap the motor load.

The fundamental questions to be asked in taking up the supplementary steam plant are first, how large a plant is it advisable to install, and second, how much energy will it have to contribute to the common stock. To determine the answers, the distribution of flow must be pretty closely known. The hydraulic power may fail either by drought or by flood. If the former, there is likely to be a period of a couple of months

in which the power will be subnormal, perhaps half to two-thirds of the average supply. To carry a full load over this period, implies a steam plant of say half the full capacity of the hydraulic plant, in operation during a portion of the time for two months. To put things on a concrete basis, suppose a 2,000 HP hydraulic plant, with a 1,000 HP supplementary steam plant. As stations ordinarily run, the load for a considerable part of the day is much less than the maximum load. Fig. 231 shows the actual load curve for three successive days on a high voltage transmission plant doing a mixed power and

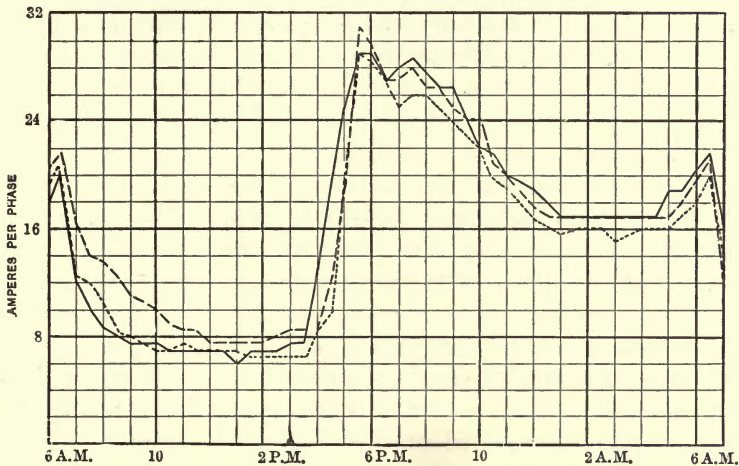

FIG. 231.

lighting business. It shows a load factor of very nearly 50 per cent, and if the peak of the load corresponded to the full capacity of the hydraulic plant, during the period of low water under our assumed conditions, the steam plant would have to furnish, not one-half the full capacity of the plant, but merely the energy above the half load ordinate of the load diagram. Considering this portion of Fig. 231, it will be seen that while at the peak of the load the steam plant would be working at full capacity, it would have to be in use only about half the time at a load factor again of about 50 per cent. So it appears that for about two months the 1,000 HP steam plant will be called upon for only about one-fourth of the actual energy

delivered by the plant, say between four and five per cent of the year's output.

Therefore, the economic question is the cost of furnishing 5 per cent of the yearly output of a steam plant of half the total hydraulic capacity worked at about half load. This is a very different case from any ordinary estimate on the cost of steam-power.

Taking the cost of the supplementary steam and electric plant in this case at \$60,000 and counting interest, depreciation, and other fixed charges at 10 per cent, there is an annual charge of \$6,000 against the plant even if it be not run at all. At the assumed load conditions it will cost at least \$25 per day for fuel, supplies, and extra labor during the two months of low water so that the upshot of the matter is, that it will cost not less than \$7,500 yearly to raise the limit of capacity of the plant from 1,000 HP to 2,000 HP.

But since the plant load factor is 50 per cent, the average output is raised only from 500 to 1,000 HP. Even on this basis the supplementary plant evidently will pay at the ordinary prices of fuel and of electric energy, but it is equally clear that as the required supplementary plant grows relatively larger, and the proportion of steam generated output increases, a point will soon be reached at which the added annual cost cannot be compensated by increased possible sales of power; provided of course, that the price of power sold is below that at which it could profitably be generated by steam alone on a similar scale.

To look at the matter from another side, in the case we have been considering, the total effect of supplying part of the output by steam would probably be to increase the cost of the year's output by less than 15 per cent, and the supplementary plant would pay handsomely. Probably in most cases it would still be profitable even if 10 per cent of the total output were due to steam. As this proportion increases, the advantage diminishes, and finally a point is reached at which any further use of steam cuts down profits rapidly. Each case must be worked out by itself, as the result depends upon local conditions, and generalizations are therefore unsafe. It is usually the fact however that a stream can be developed

for its flow in early summer with entire safety, leaving the minimum flow to be cared for by a supplementary plant.

In a few instances it is practicable to connect the power station generators so as to be operated either by steam or by water-power, thus saving the cost of extra generators. But it is generally better to place the supplementary plant in a substation at the receiving end of the line, thus allowing it to serve as an auxiliary plant in case of accident to the line or needed repairs to the hydraulic works. Turbo generators from their economy of space and their readiness for operation are well adapted for use in supplementary plants, and for such use it does not pay to install a costly boiler plant.

Steam-power on a 12 hour basis at steady full load varies according to the size and kind of plant, cost of fuel, and so forth, from a little under \$20 per HP year to \$125 or more, with an increase of one-third to one-half in case of variable loads. Water-power fully developed rents for from \$5 to \$50 or more per HP year, and may cost to develop anywhere from \$20 to \$150 per HP. At the former price it is cheaper than steam under any circumstances; at the latter it is dearer than steam unless the fuel cost is abnormally high.

If the cost of hydraulic development can be kept below \$100 per HP, water-power can nearly always drive steam-power out of business.

With respect to the prime movers to be employed in a hydraulic development, one must be governed largely by circumstances. The choice in general lies between turbines and impulse wheels, the properties of which have been fully discussed in Chapter IX. Without attempting to draw any hard and fast lines, turbines are preferable up to about 100 feet head, unless very low rotative speed is desirable, or very little power is to be developed. Above that, the impulse wheels grow more and more desirable, and above 200 feet head the field is practically their own. It is generally practicable and desirable to use wheels with a horizontal axis. Only in a few instances is it necessary to resort to a vertical axis, as when there is considerable danger of the tail-water rising clear up to the wheels, or when, as at Niagara, a very deep wheel pit is employed.

The line of operations in developing a water-power subse-

quent to the *reconnaissance* has already been indicated. After the more general considerations have been determined, comes the question of utilization.

It may seem needless to suggest that the first thing necessary is an actually available market, but the author has more than once had imparted to him, under solemn pledge of secrecy, the location of "magnificent" water-powers which could be developed for a mere song, located a hundred miles from nowhere—out of effective range even of electrical transmission.

Having a possible market, the next thing is to investigate it thoroughly. The actual amount of steam-power must be found, together with its approximate cost in large and in small units. This information ought to be extended to at least an approximate list of every engine used and the nature of its use, whether for constant or variable load, whether in use throughout the year or only at certain seasons. These more minute data are not immediately necessary, but are immensely useful later. If it is proposed to include electric lighting in the scheme, an estimate of the probable demand for lights should be carefully made. A fair guess at this can be made from the number of inhabitants in the city or town supplied. Where there is competition only with gas, experience shows that the total number of incandescent lights installed is likely to be, roughly, from one-fourth to one-sixth of the population, occasionally as many as one-third, or as few as one-eighth. In cities of moderate size it is usually found that even with competition from gas, the annual sales of electricity for all purposes can with proper exploitation be brought up to from \$1.50 to \$2.00 *per capita*. This amount may be increased by 50 per cent under favorable conditions.

From the data thus obtained one can estimate the general size of the market, and hence the approximate possible demand for electrical energy. With this in mind, further plans for the hydraulic development can be made. It may be that the water-power is obviously too small to fill the market, if so, it should be developed completely. If not, much judgment is necessary in determining the desirable extent of the development. Probable growth must be taken into account, but it cannot safely be counted upon. If steam-power is very

expensive most of the engines can probably be replaced by motors. The replacement of one-half of them is, under average circumstances, a sufficiently good tentative estimate.

With this as a basis, approximate estimates of the hydraulic development can be made. This should be done by a competent hydraulic engineer. If the developemnt is easy it is well to make estimates for a liberal surplus power also. At this stage it is best to have the hydraulic and the electrical engineer work hand in hand to estimate on the delivery of the assumed amount of power. From these estimates the general outlook for returns can be reckoned.

Before actually beginning work it is advisable to make a pretty thorough preliminary canvass of the market, to see what can be done immediately in the sale of power and light. With the certain and the probable consumption ascertained, the hydraulic and electrical engineers can work their plans into final shape and prepare final estimates.

All this preliminary work may at first sight seem rather unnecessarily exhaustive, but mistakes on paper are corrected more easily than any others, and the investigation is likely to save many times its cost in the final result.

Whatever is done should be done thoroughly. Poor work seldom pays anywhere, least of all in a permanent installation, and it should be conscientiously avoided.

Above all, continuity of service has a commercial value that cannot be estimated from price lists. If it anywhere pays to be extravagant, it is in taking extreme precautions against breakdowns and in facilities for quick and easy repairs in case of unavoidable accident. This applies alike to the hydraulic and the electrical work. If the first severe freshet demoralizes the hydraulic arrangements, or the plant runs short of water at the first severe drought, a damage is done that it takes long to repair in the public mind. On the other hand, careful, thorough work, coupled with intelligent foresight, insures that complete reliability that is the mint mark of honest and substantial enterprises.

CHAPTER XI.

THE ORGANIZATION OF A POWER STATION.

THE first thing to be determined in planning a power station is the proper site, which should, if steam be the motive power, be settled by convenience with respect to the supply of coal and water. In using water-power the position of the station should be determined in connection with the hydraulic development. Near the foot of the working fall is the natural site, but, particularly in mountainous regions, it may be quite impracticable on account of lack of available space, unsuitable ground for foundations, inaccessibility, or more often danger of flood. Under high heads where a pipe line is used, one has a considerable amount of freedom in determining the site, since the pipe can be extended and led around to convenient locations at moderate expense, say not more than \$3 or \$4 per foot. A relatively small sacrifice of head, too, may enable one to secure an admirable location.

On low heads there is far less latitude permissible, since the canal and tail-race are relatively costly, and a change of level is a serious matter.

The proper location and design of a power house calls for great tact and judgment. Often hampered by the topographical conditions, the site selected must be such as to secure good operative conditions at minimum cost. It is well in approaching the subject to put aside all preconceived notions as to how a plant should look, and to remember that it is a strictly utilitarian structure. On the hydraulic side it should have easy access and exit of the water with the minimum loss of head, the shortest feasible penstocks, and the greatest security from variations of head. On the electrical side it must be dry and clear of floods, conveniently arranged for all the apparatus, and with an easy entrance for the transmission lines. Withal it must have solid foundations, must often be capable of easy future extensions and must meet all these requirements at the minimum expense.

Some of these conditions tend to be mutually exclusive. When a plant is built at once to the full capacity of the hydraulic privilege, the conditions are considerably simplified, but this is not the usual case. The plants incidentally described in this chapter have been chosen as illustrative of some of the problems of power-house organization rather than as models of any recognized canons of design. There are no such, save in the very general way already indicated, and few of the plants erected are not in some particular open to severe criticism.

But their design has been necessarily a compromise, and more often than not, the objectionable features have resulted from following some fashion set by some conspicuous plant working under different conditions. The best watchwords in power-house design are, safety, operative simplicity, and accessibility. Heeding these, with a keen eye to local peculiarities one is not likely to go far astray.

If possible, the power station should be placed well off the main line of flow, or with the main floor well above high water mark. The foundations must be of the best to secure safety from floods and a proper support for the moving machinery. To meet these conditions is not always easy, particularly when the available head is low, and sometimes extreme artificial precautions have to be taken against flood. Such a case is found in the Oregon City plant already mentioned, of which a sectional view is given in Fig. 232, showing the foundations, a single generator, its wheels, and their appurtenances. The inner wall of the station is here the outer wall of the canal, and both walls and foundations are built very solidly of masonry and concrete. In the cut *A* and *B* are the draft tubes belonging respectively to the wheel cases *D* and *F*, which are supplied by the penstocks *C* and *E*. *F* contains the regular service turbine, a 42 inches Victor wheel coupled direct to the generator at *P*. On the pedestals *G* above this wheel is a ring thrust bearing at *I* and an hydraulic thrust bearing *K*. Above this is a pulley *Y*, 6 feet in diameter, and still above this the upper bearing support, the bearings *N* and *O*, the coupling *M*, and pedestals *Q*.

The wheel case *D* contains a 60 inch wheel with bearings, pul-

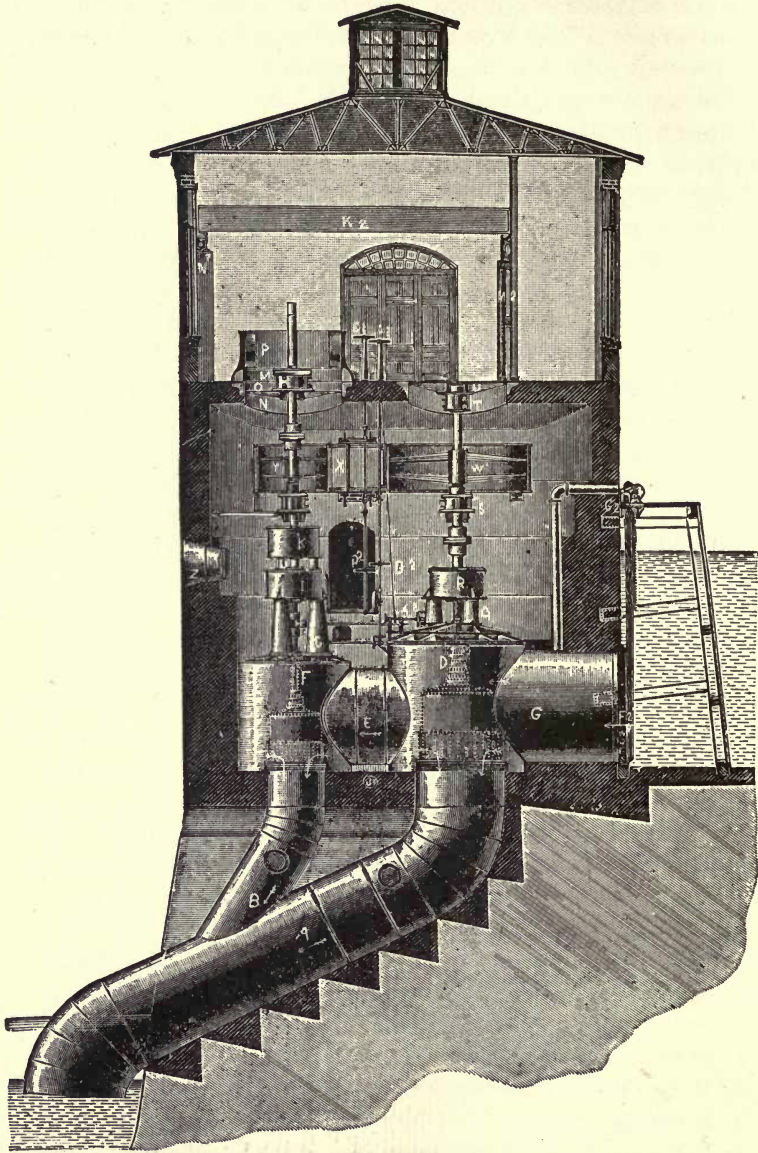

FIG. 232.

ley, and so forth, *R, S, W, T, U*. The function of this wheel and its attachments is to supply power at the seasons of very high water, sometimes several years apart. When the tail-water backs up so far that the smaller wheel is no longer equal to the work, the generator shaft is arranged to be uncoupled just above the wheel. Then the belt tightener *X* can be brought into use, the large wheel started, and the generator driven by the horizontal belt. The belt tightener is operated by hand wheels at *E₂* and *D₂*, while similar hand wheels at *C₂* and *B₂* enable the wheels to be regulated by hand when desirable. The governing is normally accomplished by the automatic regulator *A₂*. *F₂* is one of the main race gates, lifted by the mechanism at *G₂*. The wheel room is lighted by water-tight heavy glass bulls eyes at *Z*, each three feet in diameter. The dynamo room is lighted by side windows and monitor roof, and is fitted with a twelve ton travelling crane *K₂*, carried on the supporting column *M₂* and *N₂*. The penstocks pass through the heavy cement floor of the wheel room, *J₂*, with water-tight joints. The main point of interest in this station for our present purpose is not the very complicated and cumbersome hydraulic plant but the structure of the wheel room, which forms a massive permanent coffer dam securing the motive power against all direct interference by even the fiercest floods. Such a construction is somewhat inconvenient, but in some instances is almost absolutely necessary. The design of this plant is unique, in some respects uniquely bad from the standpoint of general practice, but many of its peculiarities are the result of its situation and of unusual conditions of water supply which forced the use of uncommon remedies. Generally such extreme measures need not be taken, although since it is usually desirable to have the dynamos on a level with the wheels, and coupled to them, a water-tight wall between the dynamo room and the wheel room is rather common. Quite as often, however, full reliance is placed on the strength and tightness of the penstocks and wheel cases, and wheels and dynamos are placed in the same room. A plant so arranged is cheap and simple, and where there is no unusual danger of flood is sufficiently secure. Fig. 233 shows a good typical plant of this sort, consisting of three double horizontal tur-

bins under 50 feet head, each directly coupled to its generator. Each pair of wheels gives 560 HP at about 430 revolutions per minute. This represents construction as straightforward and simple as that of Fig. 232 was difficult and intricate. It is specially interesting in the arrangement of several wheels to discharge into a common tail-race, instead of into several

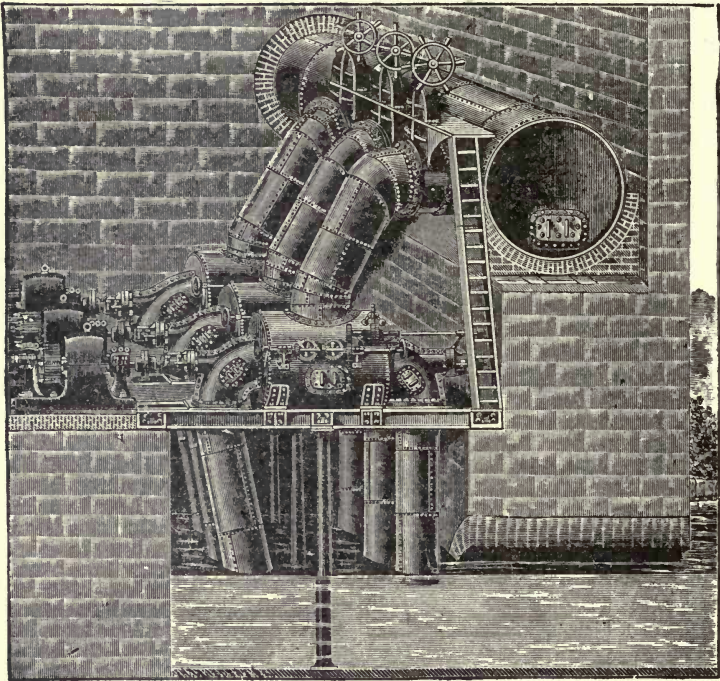

FIG. 233.

costly arched tail-races extending under the dynamo room, a construction sometimes quite unnecessarily employed.

The hydraulic conditions may drive the engineer to all sorts of expedients, but the main points are security against being drowned out, and good foundations. If the dynamos and wheels can be given direct foundations of masonry and concrete, such as the former have in Fig. 233 and the latter in Fig. 232, so much the better. If moving machinery must be carried

on beams, support these beams as in Fig. 233, directly under the load, by iron pillars or masonry piers. For direct coupling it is preferable to have foundations entirely secure from vibration. If such cannot be had one may resort successfully to a flexible coupling, very often desirable in driving from water-wheels, and sometimes rope or belt driving is advisable.

The proper site having been selected, the next consideration is the form of the structure itself. As a rule, whatever the

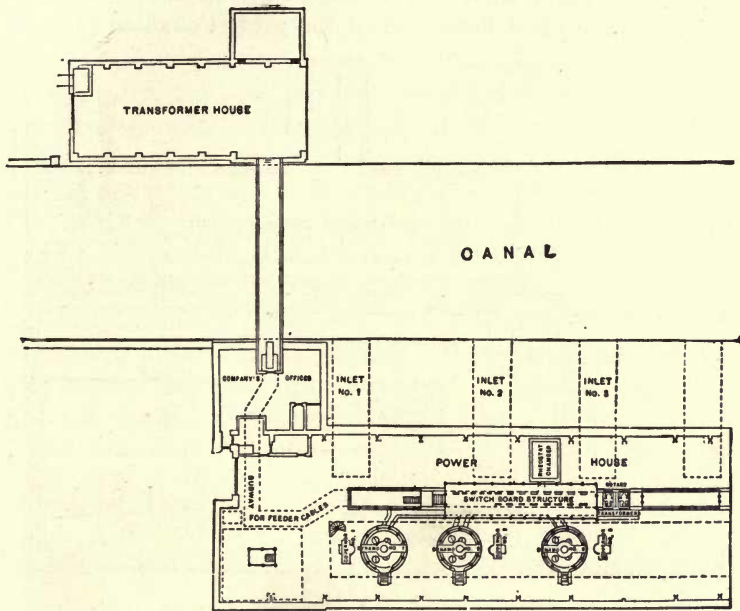

FIG. 234.

nature of the power units, they are most conveniently put, in a water-power plant, side by side in a single row with their shafts parallel. This placing enables the hydraulic plant to be simply and conveniently arranged, and enables the operator to take in the whole plant at a glance and watch all the apparatus simultaneously. Fig. 234 shows the original ground plan of the great Niagara station, well exemplifying this arrangement. In stations employing horizontal turbines such a distribution of units has even greater advantage in avoiding long and

crooked penstocks. Fig. 233 forcibly suggests the difficulty of setting the generators otherwise than in a single row.

There are, however, not infrequent cases in which the generators can be more conveniently placed otherwise. Sometimes the site desirable for hydraulic reasons is cramped so that a power house cannot readily be lengthened enough to place the machines in a single row, and even when there is space enough considerations of speed may compel a greater number of units than can readily thus be accommodated. Fig. 235 which is a floor plan of the great Canadian plant at

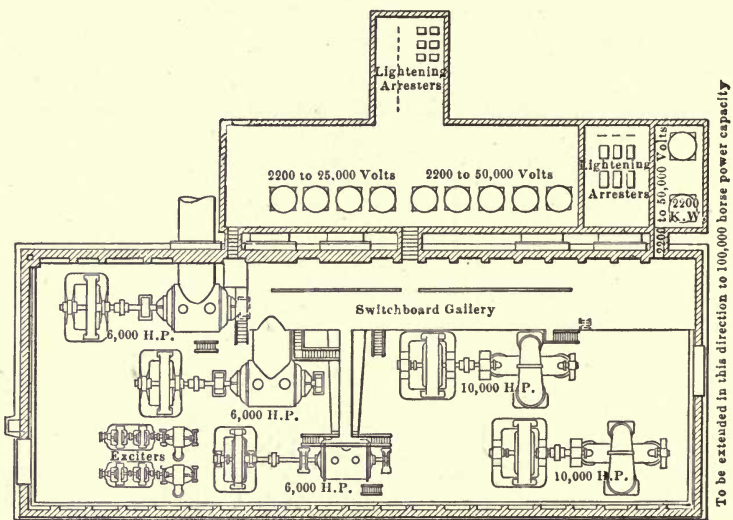

FIG. 235.

Shawinigan Falls is a case in point. Here the units are disposed in *échelon*, which gives a shorter and wider power house than usual, and room for extension lengthwise. It should be noted here that the switchboard is in a raised gallery overlooking the station as in the Niagara plant, and that the raising transformers are in a separate adjacent building, together with the lightning arresters.

In some cases the generators may well be put in two short rows facing each other, an arrangement sometimes giving a far more compact power house than the single line, which is inconveniently long when many machines are installed.

The main thing is to get the generators so placed as to be easily watched when in operation and extremely accessible in case of accident or of necessary repairs, while the hydraulic arrangements are still as simple as possible. Sometimes the power house can be greatly cheapened by avoiding the common arrangement which calls for tail-races, usually of arched masonry extending clear under the building. It is not uncommon to find the foundation masonry in such cases costing very much more than the superstructure, and involving much expense really needless.

In general the building erected for a power station should be light, dry, fireproof, and well ventilated. Dynamos usually run hot enough, without boxing them up in a close room. There should be plenty of space back of the row of dynamos, so that if machinery has to be moved there will be ample room. On the other hand the row of dynamos should be fairly compact, as a needless amount of scattering of the machines makes them hard to look after. In very many cases one story in height is quite sufficient, and in all cases it is preferable to more, so far as working apparatus is concerned. Sometimes a second story can be well utilized for store rooms, transformer room, and quarters for the operating force, but as a rule a single story allows more complete accessibility — one of the most important features in station design. As land is seldom dear around a station for power transmission ample floor space is easily obtained, except in occasional cramped localities. A brick structure with iron roof is perhaps the most satisfactory kind of station. In some situations rubble masonry or concrete and steel constructions are convenient. Avoid wood as far as is practicable, at least in every place near dynamos, or wiring of any kind. A second story, if used at all, should have a fireproof floor. Sometimes from temporary necessity a frame building is used, but even this can be made fairly safe by keeping the machines and wiring clear of wood. In any case the floor is the most troublesome part of a station to fireproof. Probably the best material is hard finished concrete, or artificial stone with only so much wood covered space as is needed to keep it from being too cold, or slippery, or to protect it temporarily in moving about machines. Window space

should be large and arranged so as to avoid leaving dark corners around the apparatus. There should be, too, ample door space to facilitate replacing apparatus — nothing is more annoying than to be short of elbow room when moving heavy machinery.

For the same reason a good permanent road should be built to the power station if one is not already in existence. In mountainous regions this is sometimes impracticable, but money spent in improving the road is better invested than when put into special sectionalized apparatus. It is quite possible so to sectionalize a generator of several hundred KW that the parts can all be carried on mule back, but the expense is considerably increased, and the great advantage of having a standard type of apparatus has to be abandoned. Hence, unless the cost of improving the road to admit of transporting ordinary apparatus is decidedly greater than the difference in cost between regular and sectionalized machinery, the former procedure is advisable. Of course when it comes to a question of long mountain trails, sectionalized machinery sometimes has to be employed. The armature of a polyphase machine for use with transformers can very easily be sectionalized, but if for high voltage or of very large size it is better to send in core plates and other material in bundles and wind the armature on the spot.

Having determined the general location and nature of the power station, one may take up further arrangements as follows:

- I. Motive Power.
- II. Dynamos.
- III. Transformers.
- IV. Accessories.

The fundamental question is the proper size and character of power units. In direct coupled work, prime mover and generator must be considered together. In steamdriven stations for power transmission the boiler plant may be determined by itself, but dynamos and engines should be taken up conjointly.

There is at present rather too strong a general inclination to use direct coupled units at any cost. Direct driving is

beautifully simple and efficient when conditions are favorable, and for large units is necessary, but belt and rope driving gives singularly little trouble, and when well engineered wastes very little energy — not over 3 to 5 per cent for a single direct drive, which can almost invariably be used. It is very easy to lose far more than this in using a dynamo designed for a speed unsuited for its output, or wheels working under disadvantageous conditions. Cases of such misfit combinations are not uncommon, and while the workmanship and results are often good the engineering is faulty. A very characteristic example is shown in Fig. 236, from the power plant of an early single phase transmission for mining purposes. The generator selected was a 120 KW Westinghouse machine of standard form and excellently adapted for its purpose. Its speed was 860 revolutions per minute, and to obtain this from a working head of 340 feet a battery of four 21 inch Pelton wheels was required. Now the Pelton wheel under favorable conditions is unexcelled as a prime mover in convenience and efficiency, but these conditions were distinctly unfavorable. The same work could have been done by a single wheel four or five feet in diameter at not over one-third the initial expense for wheels and fittings, and at enough higher efficiency to more than compensate for the slight loss of energy in a simple belt drive. In this case wheel efficiency was sacrificed to the speed of the generator. An error quite as common is to sacrifice generator efficiency to the speed of the prime mover.

The most flagrant case of this kind that has come to the author's notice, was a polyphase machine of less than a hundred KW output direct coupled to a vertical shaft turbine at 20 revolutions per minute. This was of course a low frequency machine, but an instance nearly as bad may be found in the case of a 75 KW alternator for 15,000 alternations per minute direct coupled to an engine at a little less than 100 revolutions per minute. These are extreme examples, of course, such machines costing several times more than normal generators of the same capacity, and having probably fully 10 per cent less efficiency. It is, however, not rare to find costly direct coupled units which gain no efficiency over belted combina-

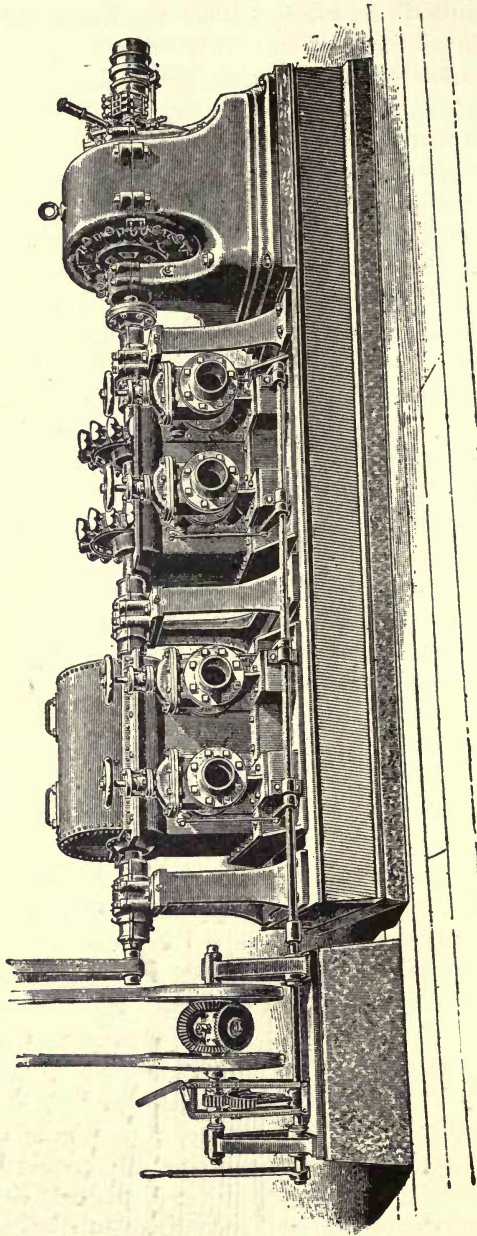

FIG. 236.

tions, have little to recommend them save appearance, and pay dearly for that.

The best way to avoid such mistakes is to put aside prejudice and let the makers of generators and prime movers put their heads together in consultation and work out the problem together. Both are usually anxious to do good work, and will arrive at a judicious conclusion.

Alternating work is sometimes difficult in this respect on account of the requirements of frequency, but at the present time all the large makers of hydraulic and electrical machinery have a sufficient line of patterns to meet most cases easily without involving special work to any considerable extent.

In deciding on the number of units to be employed several things must be taken into account. The number should not be so small that the temporary crippling of a single unit will interfere seriously with the work of the plant. This determines the maximum permissible size of each unit. The nearer one can come to this without involving difficulties in the way of proper speed or serious specialization, the better. It is seldom advisable to install less than three units, while in some cases a considerably larger number must be used to suit the hydraulic conditions.

To illustrate this point, suppose we are considering a transmission of 3,000 KW from a water-power with 16 feet available head. One would naturally like to install three 1,000 KW generators or four of 750 KW. But trouble is encountered at once in the wheels. The 1,000 KW machine should have, say 1,500 HP available at the wheel, and the 750 KW about 1,100. Even assuming at once the use of double turbines the highest available speed for an output of 1,500 HP would be about 75 to 80 revolutions per minute, too low for advantageous direct coupling at any ordinary frequency; 1,100 HP can be obtained at a speed perhaps 10 revolutions per minute higher — not enough to be of much service. It is a choice between evils at best, either generators of speed so low as to be both expensive and difficult to get up to normal efficiency, or belting, when one would much prefer to couple direct. At lower heads, say 12 feet, one would be driven from direct connection; at 30 to 40 feet head it would be comparatively easy. In the case in hand

we are near the dividing line, and it would require very close figuring to get at the real facts, figuring which would have to be guided by local conditions. The chances are that six 500 KW generators at about 125 r. p. m., would give a good combination of efficiency and cost. As an alternative, one might use 750 KW generators either coupled to 3 water wheels or rope driven. Each case of this kind has to be worked out on its merits. Since the dynamos cost far more than water-wheels for the same capacity, if there is any specializing to be done it is cheaper to do it at the wheels. If, however, it proves convenient to change the dynamo speed a trifle, most generators can be varied 5 per cent either way without encountering any difficulties.

Now and then it becomes necessary to plan for vertical wheel shafts. This, unhappily, is apt to confront one at very low heads, and leads to immediate difficulty. Direct coupling is usually impracticable since the speed is very low, double wheels being out of the question, and even if the dynamo could be economically built the support of the revolving element would be very troublesome. The usual arrangement is to use bevel gears, and this is generally the only practicable course.

It is desirable in any case to operate each dynamo by its own special wheels, to avoid complication. Hence the considerations which determine the number of dynamos also define the number of wheels. It is very seldom expedient to use more than a single pair of wheels for driving a single generator, on account of difficulties in alignment and regulation and consequent tendency to work inharmoniously. This tendency is stronger in impulse wheels than in turbines, on account of the very small volume of water generally employed, and consequent hypersensitiveness to small changes in the amount, pressure, and direction of the stream. So, usually, a single wheel or pair of wheels, equal to the task of handling a single generator, may be taken as the hydraulic unit.

For simplicity and economy one should keep down the number of generators to the limit already imposed, except as special cases may call for an increase. If the plant is to feed several transmission lines it is sometimes best to assign separate dynamos to each line for one purpose or another, and this

may make it necessary to increase the total number. The requisite security from accident can be in such cases obtained by one or two spare units, or by shifting a generator from a lightly loaded line to a heavily loaded one. In point of fact the modern generator is a wonderfully reliable machine,

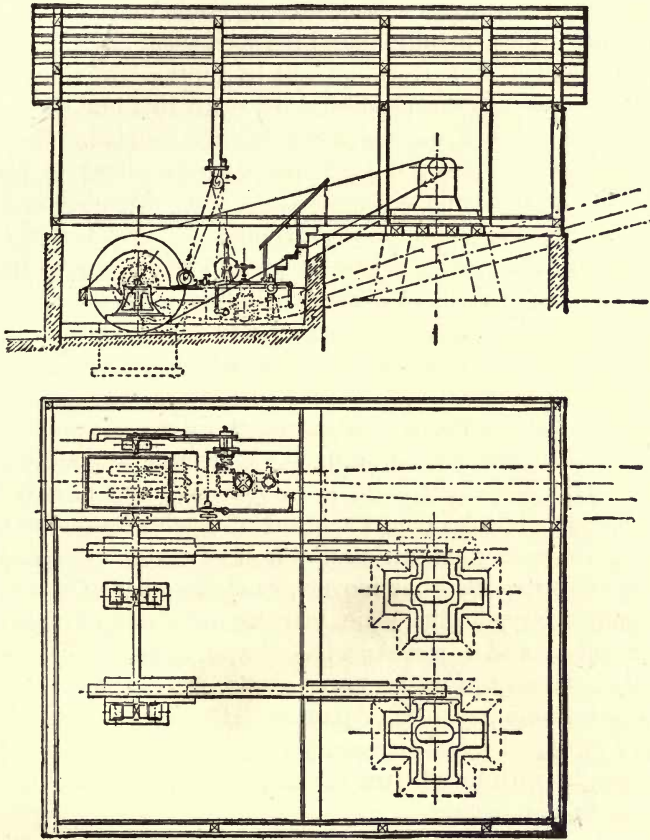

FIG. 237.

and it is not unusual to find a machine that has run day and night, save for a few hours in the week, for many months without any reserve behind it. The author saw recently a small incandescent machine which had run some hours per day in an isolated plant, for fourteen consecutive years without a failure

of any kind. During that time the armature had been out of its bearings but once, to have the commutator turned down.

In steam driven plants, as in water-power works, the most convenient arrangement of generators is generally side by side in a single line. So placed they are easy to take care of, and the spare room is more available than when it is irregularly disposed. In case water-wheels are the prime movers a water-tight bulkhead is generally placed between them and the dynamos, so that leaks or overflows will be confined to the wheel pit, where they can do no harm. Through this bulkhead the shafts should pass if the units are directly coupled. In case of a belt or rope drive it is frequently convenient to place wheels and dynamos on different levels, thus obtaining similar security. Fig. 237 shows a well-arranged small plant of this sort, driven by a pair of Pelton wheels. The plant is so small that both dynamos can be conveniently driven by pulleys on a very short extension of the wheel shaft.

In a larger plant each wheel unit would drive a single dynamo, and the receiver and wheels with their fittings would occupy one-half of the station, while the dynamos would be placed in the other half, following the same general plan shown in Fig. 237. The main point is to get good foundations for the dynamos while keeping them out of reach of stray water.

In an alternating current station it is advisable to drive the exciters from special prime movers, so that a change of speed, even momentary, in the main machine may not change the exciter voltage and thus make a bad matter worse. This is particularly necessary in water-power plants, where the governing is apt to be none too close or prompt. It is a good thing also to have plenty of reserve capacity in the exciters, so as never to be caught with insufficient exciting power, even in case of accident to one exciter.

Both wheels and dynamos should be thoroughly accessible, and wheel and dynamo rooms must be well lighted, naturally and artificially. A dark and slippery wheel pit, without sufficient space around the wheels, is sure to prove a source of annoyance and sometimes of serious delays. It should be possible to get at every wheel and its fittings and to work around them freely when all the other wheels are in full use.

Sometimes it is useful to separate wheels by bulkheads, preferably movable, and there should always be floor space enough to stand and work on without putting up temporary stagings and loose boards. There should always be electric lights ready for use around all the working machinery, arc lamps or incandescents as may be most convenient, but plenty of them. Around the wheels it may sometimes be necessary to use incandescents in marine globes to protect them from the water, and to install waterproof flexible cable for the movable lights.

As an example of good practice in a plant for heavy power transmission, operated by turbines under a moderate head, the Folsom, Cal., installation shown in Plate XV is worth studying. Fig. 1 shows the general character of the power house and its relation to the forebay, penstocks, and tail-race. The forebay itself is double, being divided lengthwise by a wall, on each side of which are the gates and penstocks for two double turbines. The tail-races are four masonry arches under the power house, uniting then into a single channel. The tubular steel penstocks are 8 feet in diameter, and the relief pipes above them, 4 feet in diameter. The gates are handled by hydraulic cylinders, like the head gates at the dam. It will be observed that the wheel pit is not in the power house, but in the clear space between the rear wall of the power house and the end wall of the forebay, which like the other masonry work in this plant, is of granite blocks. The power house itself is a spacious two-story brick structure on granite foundations. The lower floor is the dynamo room while the upper floor contains the transformer room, storage space, and so forth, together with the high tension switch-board, the lines from which are shown running out from the end of the building. The wheels are 30 inch double horizontal turbines of the McCormick type, giving about 1,250 HP per pair at 300 revolutions per minute under the available normal head of 55 feet. There are, besides, two small single horizontal wheels for driving the exciters. Each of the main wheel units carries on its shaft a 15,000 lb. fly-wheel to steady its operation under varying loads.

The arrangement of the wheels and generators is admirably

shown in Fig. 2, Plate XV, from a photograph taken during the process of construction.

This gives a view of one complete unit: generator, coupling, governor, turbines, and fly-wheel, and includes also an exciter and its wheel, not yet aligned and coupled. Four such main units and the two exciters, all placed side by side in a single row, make up the plant.

The generators are three-phase machines, of 750 KW capacity, at 60~. Each has 24 poles, runs at 300 revolutions per minute, and weighs about 30 tons. They are of very low inductance, with polyodontal bar-wound armatures designed to give normally 800 volts between lines, and to produce a very close approximation to a true sinusoidal wave form. They are normally intended to run in parallel, although there is actually a complete circuit per machine available when wanted. The wheels were originally installed with Faesch-Piccard governors, which functioned fairly well but were not strong enough for the heavy service, and have now been replaced.

When the heavy apparatus was all in place and connected, the arched spaces shown in Fig. 2 were walled up except for shaft holes, and the wheel pit permanently separated from the dynamo room. From the dynamos the current is taken to the low tension switchboard facing the row of generators. Thence it passes to the transformer room on the second floor of the station. Here is a bank of twelve raising transformers, of the air blast substation type largely used in the practice of the General Electric Company. These raise the working pressure to 11,000 volts. At this potential the current passes to the high tension switchboard and thence to the line. A second switchboard in the transformer room serves to distribute the low tension current received from the dynamos.

The general arrangement of this station is excellent, for the installation as made. Were the plant to be worked at higher voltage for which the air blast transformers would be inadvisable, it would be wise not to put the transformer room in a second story, but to locate the oil transformers in a fireproof space by themselves.

The line consists of four complete three-phase circuits each of No. 0 B. & S. wire. There are two independent pole lines

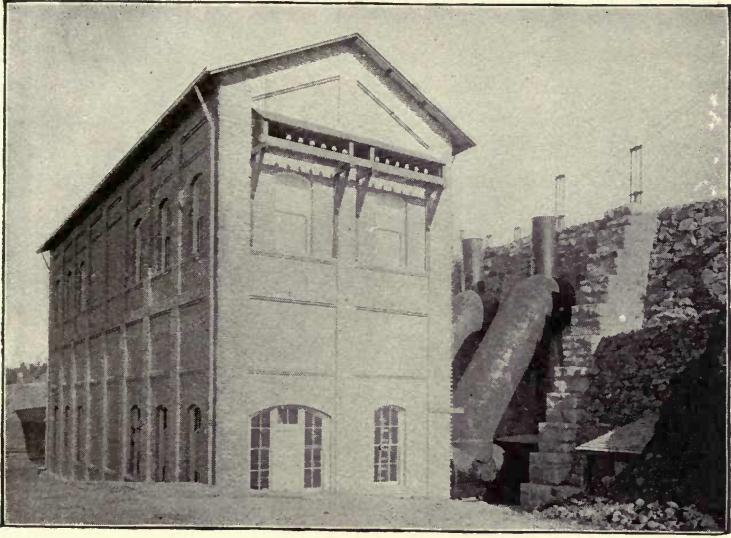

FIG. 1.

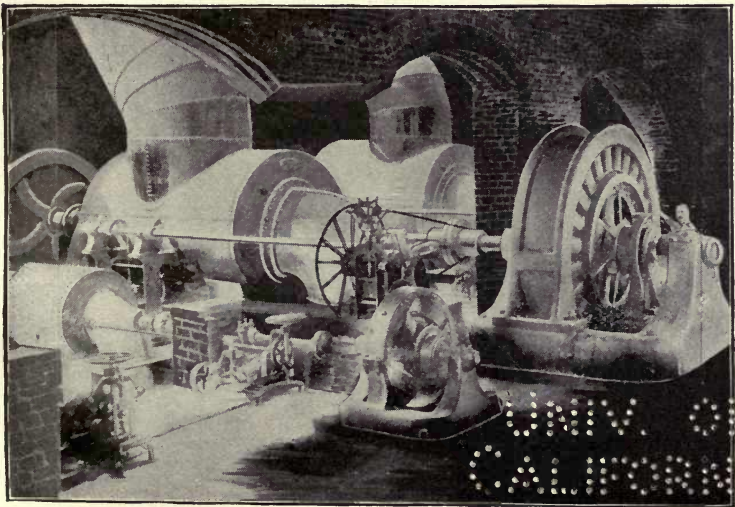

FIG. 2.

1 2 3 4 5 6 7 8 9 10 11 12 13 14 15 16 17 18 19 20 21 22 23 24 25 26 27 28 29 30 31 32 33 34 35 36 37 38 39 40 41 42 43 44 45 46 47 48 49 50 51 52 53 54 55 56 57 58 59 60 61 62 63 64 65 66 67 68 69 70 71 72 73 74 75 76 77 78 79 80 81 82 83 84 85 86 87 88 89 90 91 92 93 94 95 96 97 98 99 100

running side by side a few rods apart, constructed of red-wood poles 40 feet long. Each pole line carries two circuits symmetrically arranged on two cross arms, one circuit being on each side of the pole, the wires arranged so as to form an equilateral triangle, with an angle downward. One of the pole lines carries an extra cross arm a few feet below the main circuits, to accommodate the telephone circuit. All wires are transposed at frequent intervals to lessen induction. The pole line is on the southern side of the American River and follows in the main the country roads clear into Sacramento, the two lines being on opposite sides of the road. The route thus followed is a trifle longer than the actual linear distance, but the gain in accessibility more than counterbalances the extra mile or so of line. The high tension line is carried along the river through the northern edge of the city fairly into the district of load, and is then terminated in a handsome brick substation containing the transformer and dynamo rooms and the offices of the company. The distribution system is mixed in character owing to the operation of the existing railway and lighting loads.

The main distribution circuit is a three-phase four-wire circuit worked at 125 volts between the active wires and the neutral. This gives an admirable network for lighting and motor work, very economical of copper, easy to wire and to operate. All the transformers in the substation are arranged for a secondary voltage of 125, 250, or 500 as may be desired, so as to be ready for any kind of service.

This plant first went into operation in July, 1895, and has since then been in continuous service day and night. No serious trouble has been encountered, the high voltage line has performed admirably, and there has been no difficulty due to inductance, lack of balance, resonance, or any of the other things that used to be feared in connection with long distance polyphase work. Furthermore the plant is a success financially as well as electrically. Apart from Niagara, which even now is only beginning long distance work, it has been one of the most valuable of the pioneer plants in establishing confidence in power transmission, and in putting the art upon a substantial basis.

Another fine example of three-phase work, of especial interest as being operated under a very exceptionally high head, is the plant utilized at Fresno, Cal. Fresno is a flourishing city of 15,000 inhabitants at the head of the magnificent San Joaquin valley in central California. Like other Californian cities, it has been hampered in its development by the very high cost of coal — \$8 to \$10 per ton in carload lots, and some of its active citizens cast about for an available water-power to develop electrically. Such a one was found on the north fork of the San Joaquin River very nearly 35 miles from the city. At a point where this stream flows through a narrow cañon it was diverted, and the stream was carried in a series of flumes and canals winding along the hillsides for seven miles to a point where it could be dropped back into the river bed, 1,600 feet below.

At this point an emergency reservoir was formed in a natural basin, which by an expenditure of less than \$3,000 was developed into a pond capable of holding enough reserve water for several days' run at full load.

The minimum flow of the stream is 3,000 cubic feet per minute, capable of giving between 6,000 and 7,000 HP off the shafts of the water-wheels when fully utilized. In the initial plant only a small portion of this power is employed. From the head works at the reservoir a pipe line is taken down the hillside to the power house. The pipe is 4,100 feet long. At the upper end for 400 feet a 24 inch riveted steel pipe is used, then lap-welded steel pipe is employed diminishing in diameter and increasing in thickness toward the lower end, where it is 18 inches in diameter, of five-eighths inch mild steel, and terminating in a tubular receiver 30 inches in diameter, of three-fourths inch steel. The vertical head is 1,410 feet. This corresponds to a pressure of 613 lbs. per square inch, while the emergent jet has a spouting velocity of 300 feet per second.

To withstand and utilize this tremendous velocity unusual precautions were necessary. The main Pelton wheels, designed for 500 HP at 600 revolutions per minute, have solid steel plate centres with hard bronze buckets. Each carries on its shaft a steel fly-wheel weighing 3 tons, and 5 feet in diameter. With their enormous peripheral speed of over 9,000 feet per minute,

Law of
California



FIG. 1.

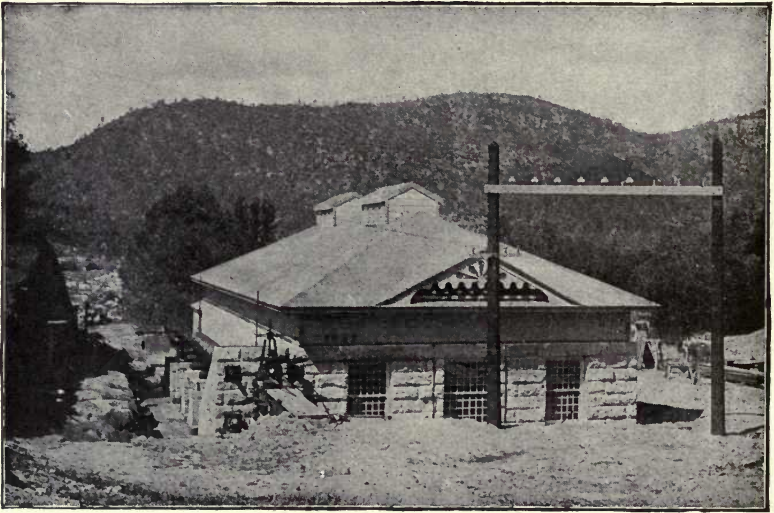

FIG. 2.

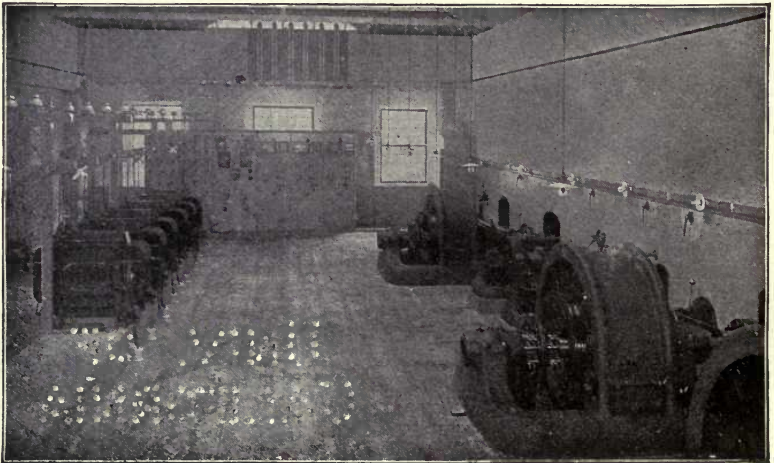

FIG. 3.

these have a powerful steadying effect on the speed of the generators. There are four of these wheels, each directly coupled to a 350 KW General Electric three-phase generator, giving 700 volts at 60~. There are also two 20 HP Pelton wheels, each 20 inches in diameter, and each direct coupled to a multipolar exciter. All the wheels are controlled independently by Pelton differential governors.

On the main floor of the power house opposite the generators, is the bank of raising transformers. These are of 125 KW capacity each, of the ordinary air blast type. Space is provided for additional transformers more when the load demands them.

These transformers raise the pressure to 19,000 volts between lines and from the high tension section of the switchboard the current passes to the transmission line. This consists of two complete three-phase circuits which can be worked together or independently. They are of No. 00 bare copper wire carried on special double petticoat porcelain insulators, all tested at 27,000 volts alternating pressure.

The pole line is of 35 foot squared redwood poles set 6 feet deep. Each pole carries four cross arms. Three of these at the top of the pole are for the transmission circuits. These are at present confined to the two upper cross arms, leaving space for additional circuits below. A fourth short cross arm about 4 feet below the others carries the telephone wires.

Plate XVI gives a good idea of the general arrangement of the Fresno plant. Fig. 1 gives a glimpse of the storage reservoir at the upper end of the pipe line. Fig. 2 shows the situation of the power house below, which is built of native granite on a solid rock foundation, with a wooden roof. It is 75 x 30 feet in size. The wheel pit is seen running along one side of the station just outside the wall, through which pass the wheel shafts driving the dynamos inside. In the foreground appears the beginning of the transmission line.

Fig. 3 shows the interior of the power house with the dynamos and transformers in place and the switchboard at the further end of the room.

In the city of Fresno the transmission lines are taken to a substantial brick substation in the centre of the city. Here

are situated the reducing transformers and accessory apparatus, including two 80-light arc dynamos direct coupled to 60 HP induction motors.

The distribution system is threefold. In the central district of the city a three-phase four-wire network is employed, supplied from three 125 KW reducing transformers, and worked at 115 volts between active wires and neutral. For the outlying residence region three 75 KW transformers supply current at 1,000 volts for use with secondary transformers. Finally, for reaching neighboring towns, three 40 KW transformers feed a 3,000 volt subtransmission system. The operation of this plant, like that of the Folsom plant, has been highly successful from the start, and the electrical troubles that have often been feared on long lines at high voltage have been conspicuous by their absence.

Both these plants represent even to-day, first-class practice in general equipment and arrangement, save that the voltages of transmission have now become ultra conservative, and while differing conditions bring their own necessary modifications, these examples may be regarded as thoroughly typical. They have incidentally demonstrated the thorough practicability of general distribution of energy for lighting and power by polyphase currents under large commercial conditions, and at distances great enough to involve all the electrical difficulties likely to be met at the voltage employed. A more recent plant of peculiar interest in some of its engineering features is that of the Truckee River General Electric Company near Floriston, Cal., shown in Plates XVII and XVIII. This plant was erected to supply power to the mines of the famous Comstock Lode, where it is used for mining hoists, milling and pumping, which had formerly been done almost entirely by steam provided by burning pine at \$8.50 to \$15 per cord.

The source of the water-power is the Truckee River, an unusually steady stream rising among the snows of the Sierra Nevada. At the head works is a timber crib dam about 50 yards long and only 7 feet in height, serving mainly to back the water into a wide, slow running canal a couple of hundred yards long, which serves also as a settling pond. Thence the

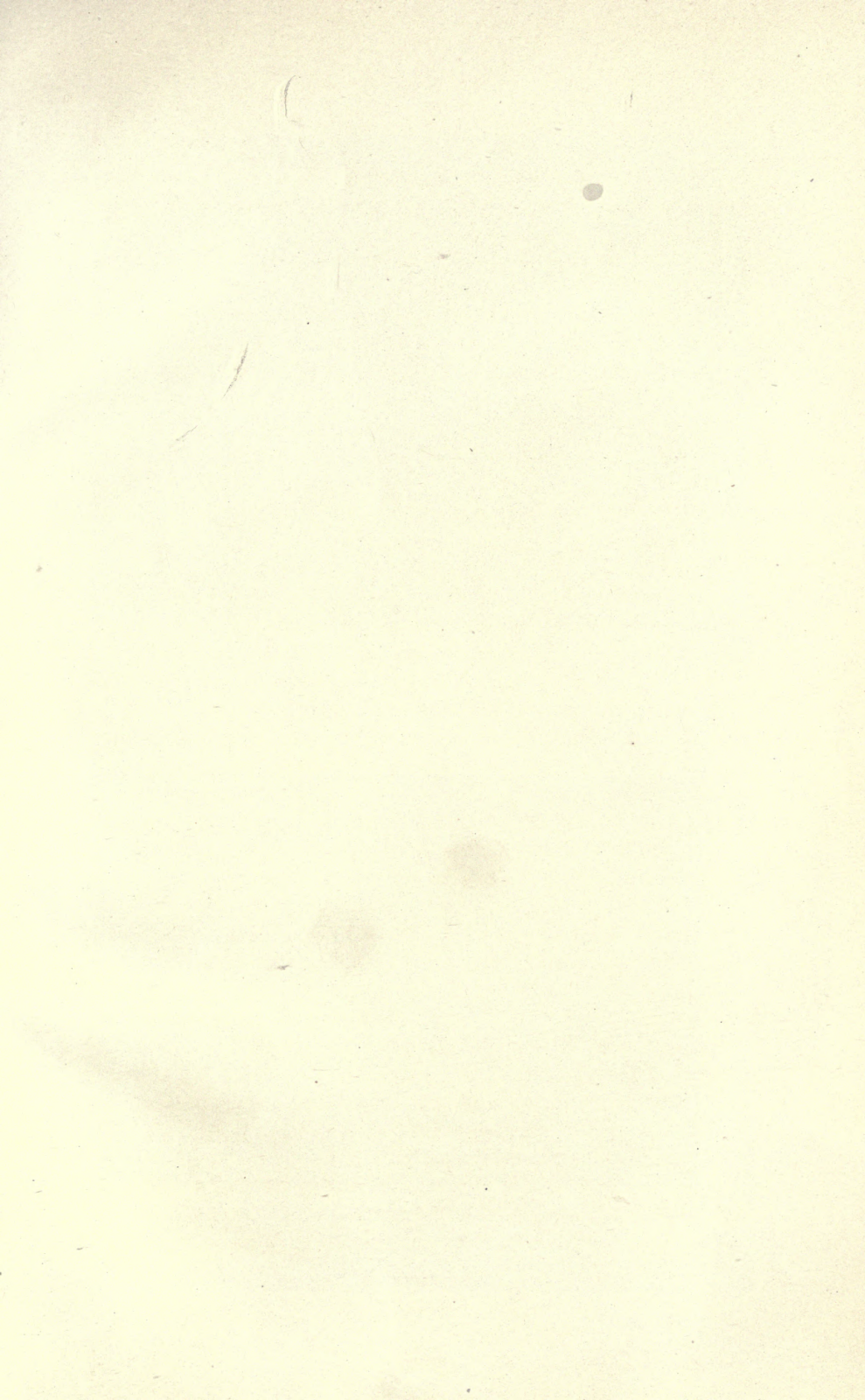

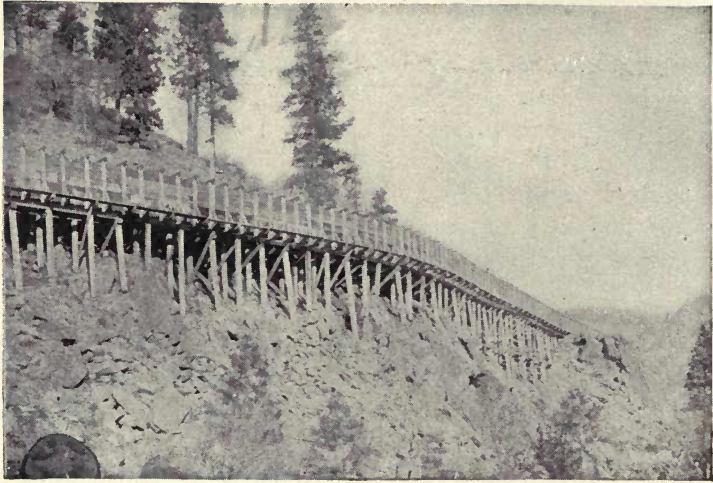

FIG. 1.

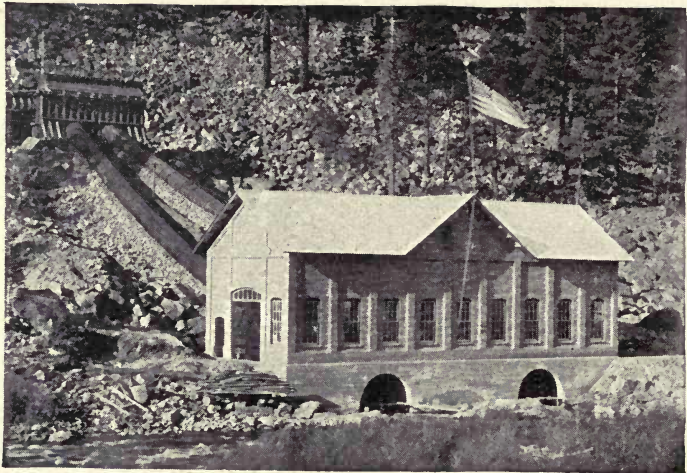

FIG. 2.

PLATE XVII.

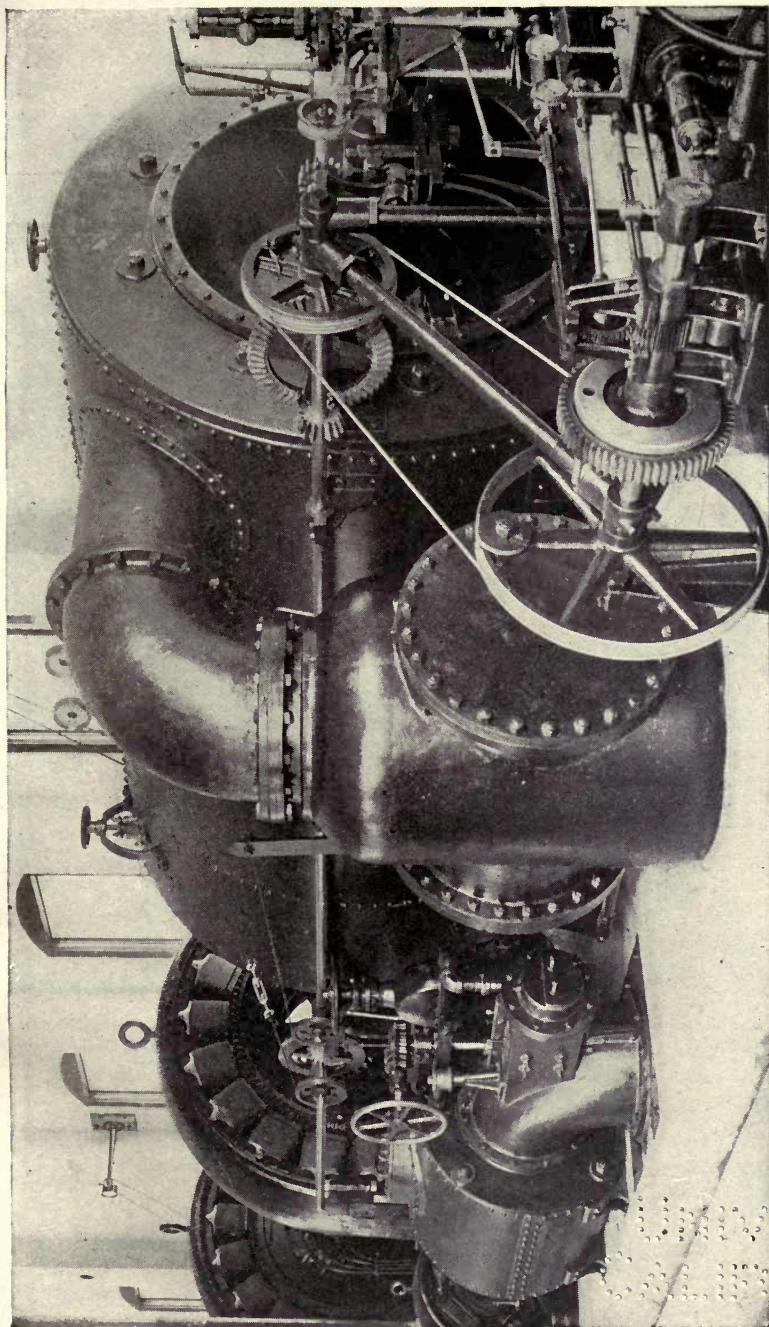

PLATE XVIII.

water passes through the racks into a timber flume, 10 feet deep and 6 feet 8 inches wide inside, the entrance being widened to 28 feet at the racks and tapered to the normal width in a run of 40 feet.

This timber flume, a portion of which is well shown in Plate XVII, Fig. 1, winds along the hillsides for a distance of a little more than a mile and a half. It carries 300 cubic feet of water per second at a depth of 6 feet in the flume, the corresponding velocity being 7.5 feet per second. This flume is carried on heavy timber frames 16 feet between centres, with two intermediate sets of four posts each. Along the line of the flume are two spill gates each in the side of a sand box dropped below the bottom of the flume.

This flume terminates in a timber penstock 36 feet long and 21 feet wide, furnished with a central bulkhead and strongly stayed with iron rods. Back of the penstock a spill flume is carried for 200 feet alongside the main flume. From the penstock two pipes, taking their water through head gates, run to the wheels.

These pipes are of redwood staves, hooped with $\frac{3}{8}$ -inch round steel, 6 feet in diameter inside, and 160 feet long. The working head is 84.5 feet, and a few feet from the power house the wooden pipes are wedged into the steel pipes that lead to the wheel-cases. Plate XVII, Fig. 2, shows the power house, penstocks, pipes, and tail-races. The power house itself is 88 × 31 feet, of brick, with roof of corrugated galvanized iron, and has concrete foundations.

Plate XVIII shows the arrangement of the wheels and generators. The wheel plant consists of two pairs of 27-inch McCormick horizontal turbines, each pair giving 1,400 HP at 400 r. p. m. Each pair discharges into a central cast-iron draught box continued by a 20-foot draught tube. Each pair of wheels is directly coupled to a 750 KW, 500 volt three-phase Westinghouse generator. But instead of the arrangement shown in Plates XV and XVI the shafts of both sets of wheels and of the generators are in one straight line, with the wheels at its extremities. This gives space for a very solid foundation for the generators between the arched tail-races, and if need be the generators can be directly coupled together so as to run both from a single wheel or as a single unit. Arrangements of this

kind may be very freely adopted where the units are few, and the plant is not built with probable extensions in mind. Each generator has a separate multipolar exciter driven by a small separate turbine, and each of these receives the water from the case of its main wheel and discharges into the corresponding tail-race. Each exciter is of sufficient capacity for both generators.

Each main pair of wheels is regulated by a Lombard governor, one of which appears in the foreground. But to insure close regulation an unusual device is installed in connection with the governors. The supply pipes are too long and the head too high to permit the installation of efficient relief pipes, as in the Folsom plant, and the enormous inertia of the water in the supply pipes was consequently both an inconvenience and a menace. Hence relief was provided by a huge balanced Ludlow valve connected with the wheel-case and the tail-race. This valve is operated by wire ropes and sheaves, so connected with the gate shaft of the wheel that when the governor closes the wheel gate it opens the relief valve and vice versa, thus keeping the velocity of the water nearly constant. The effect is closely similar to that obtained with the deflecting nozzle used with Pelton wheels, and while it wastes water, that is of small moment compared with the necessity for regulation.

The 500-volt current from the generators is raised by oil insulated transformers to 22,000 volts for the 33-mile transmission to Virginia City, Nev., which is the centre of utilization. The pole line is of square sawed redwood poles 30 feet long, 11 inches square at the butt and 7 inches square at the top. These poles carry two cross arms on which the two three-phase circuits of bare No. 4 B. & S. wire are arranged as usual, forming an equilateral triangle on each side of the poles. The insulators are porcelain on oil-treated eucalyptus pins. The poles are spaced about 40 to the mile, and carry a couple of brackets for the telephone line below the cross arms. The three-phase lines are transposed every 144 poles.

The distribution in Virginia City is at 2,250 volts three-phase over a maximum radius of about 2 miles. This plant is a good example of recent practice in dealing with moderately high heads. The timber flume in particular strikes Eastern

engineers unfavorably at first, but the irrigation companies of the Pacific slope have had many years of experience in that sort of construction, and have learned that it is easy, cheap, and durable when properly cared for. There are hundreds of miles of it used for various purposes in California, and in many instances it is the only practicable means of water delivery. Altogether this particular plant teaches a useful lesson in hydraulic construction, and like those just described is a very good example of modern engineering.

At present long-distance plants are rather the exception, and in the natural course of events there must be developed a great number of power transmissions at quite moderate distances, under ten miles or so. Such plants as regards general organization do not possess any special peculiarities. The dynamos, however, may often be wound for exceptionally high voltage. Dynamos for use with raising transformers should be of moderate voltage, not much over 2,000 volts unless the units are of immense size, or must furnish local power in addition to their regular function.

At moderate voltage the generators gain in cost per unit of output, in simplicity, and in comparative immunity from accidents. They are also likely to be designed for lower armature reaction. Nevertheless, there are many cases in which it is advisable to install generators for 5,000 to 12,000 volts for the sake of economy and simplicity of plant. In fact, it is questionable whether it is ever worth while to use raising transformers in work at these very moderate transmission voltages. As already indicated, such generators should always have stationary armatures, and should, and do, have extraordinarily good insulation. When installed they are sometimes insulated from the foundations with scrupulous care, and if direct coupled they may be provided with insulating couplings. Small high-voltage machines have been supported on porcelain insulators. Large generators may be carried on hardwood timbers thoroughly treated with insulating material, and bolted to the foundation cap stone. As the art of insulation has progressed, such precautions have become less and less necessary, and at the present time generators for 10,000 volts and more are often installed and successfully used

without any such general insulation at all. It is desirable to surround such machines with an insulated platform a few inches above the floor, and to protect the leads with vulcanite tubes. It is well also to shield the terminals so that only one can be manipulated at a time when the machine is in action. These high-voltage generators have proved to be entirely reliable, do not seem to be more subject to accident than other generators, and if injured are rather more easily repaired than transformers.

In all plants employing more than a single generator,—and this means nearly all power transmission plants of every kind,—the generators should be arranged to run in parallel, and in most instances should be so operated regularly. Now and then generators may advantageously be operated on separate lines, as when these lines must be run under different conditions of regulation, or when a line must be isolated for the purpose of carrying a very severe fluctuating load, but for the vast majority of plants these expedients are totally unnecessary, and only complicate the operation of the system without any material compensating advantage.

Plants operated for lighting alone can get along after a fashion by shifting load quickly from one machine to another, an operation quite familiar to most people who have been customers of such a system; but for the general distribution of lights and power this procedure is inadmissible, for it usually means stopping some or all of the motors. Moreover, it is a clumsy method at best, abandoned long ago by continuous current stations, and without any excuse for existence save villainously bad generator equipment or incompetence in the operation of the station.

All modern generators of good design are capable of running in parallel without the slightest difficulty, provided they have somewhere nearly similar magnetic characteristics and are intelligently operated.

It is inadvisable to attempt running a smooth-core and an iron-clad armature in parallel, or two machines which are very different in regulation or which give very different wave shape, but on the other hand such machines ought not to be installed together on general principles. The nearer alike the machines, the better they will run in parallel.

No subject has been oftener a topic of fruitless discussion than the paralleling of alternators. As a matter of fact, any two similar alternators will go into parallel and stay there with very little difficulty, at least if driven from water-wheels, as is nearly always the case in transmission plants.

High-inductance machines have been supposed to be somewhat easier to put and work in parallel than those of low inductance. They certainly can be thrown together carelessly with less likelihood of a large synchronizing current flowing between them, but with low-inductance machines a little more care, or an inductance temporarily inserted between the machines, leads to the same end.

In throwing two alternators of any kind in parallel, they should be in the same phase, running at the same speed and at approximately the same voltage. The more nearly these conditions are fulfilled, the less synchronizing current will flow between the machines, and hence the more smoothly will they drop together.

The ordinary arrangement of phase lamps shows the relation of both speed and phase with ample exactness. When the indicator lamp is pulsating at the rate of one period in four or five seconds, it is evident that the relative speeds of the machines are very nearly right, and it is quite easy to cut in the new machine when its phase is very nearly right. One soon gets the swing of the slow pulsations, and can catch the middle point of the interval of darkness with great accuracy. The pulsations can in fact be easily reduced to a ten-second period or even longer. It is, on the whole, best to reverse the phase lamp connections so that concordance of phase will be marked by the lighting up of the phase lamps. The lamps should be of such voltage that they will come merely to a bright red when the machines are in phase. This arrangement averts the possibility of a lamp burning out during phasing and giving apparent concordance of phase. This accident has actually happened — with spectacular results. In large stations special synchronism indicators, of which more in the next chapter, frequently replace phase lamps to good purpose. It is not a bad idea to provide both as a safety precaution.

It is obviously necessary that the speeds of the two machines should be normally alike, and that the speeds should have a certain slight flexibility. When belt-driven from the same shaft, the various generators to be put in parallel must be run very accurately at the same speed, else one of the belts will constantly slip and there will be considerable synchronizing current. When properly adjusted, the machines should be so closely at speed that the phase lamps will have a period of from 20 to 30 seconds. This is not a difficult matter when driving from the same shaft. In direct-coupled units, or in general those driven from independent prime movers, it is best to let one governor do the fine adjustment of speed, the others being a little more insensitive. Otherwise the governors are likely to fight among themselves and be perpetually see-sawing.

With respect to equality of voltage, the better the regulation of the generators in themselves, the more necessary it is to have them closely at the same voltage when put into, or when running in, parallel. Two generators with bad inherent regulation will divide the load with approximate equality, even if put in parallel with a noticeable difference in voltage, since the machine that tends to take the heavier current will promptly have its voltage battered down and the tendency corrected — at the expense, however, of accurate regulation in the plant.

With machines of low inductance and good regulation, the voltages should be very closely the same before putting into parallel, to avoid heavy synchronizing current, and they will then divide the load correctly with a very slight adjustment of the voltage. If the characteristics of the machines are known, as they should be, the voltages can be arranged so that they will fall together as accurately as if the added machine had been put on an artificial load before parallelizing.

If these precautions are observed, no difficulty will be experienced in parallel running, and machines in stations many miles apart will work together in perfect harmony. This is sometimes necessary in large central station work, when a portion of the power is transmitted from a distance and a portion generated on the spot. It sometimes happens, too, that to obtain the amount of water-power that is desired, it must be taken from a group of falls. In point of fact, it is a

perfectly simple matter to operate a number of transmission plants in parallel, rather easier than so to operate the machines in a single station. The inductance in a long line acts as an electro dynamic buffer.

The magnitude of the transformer units, when transformers are used, should be determined by the same considerations that apply to generators, except that questions of speed do not have to be considered. The smallest number of transformers that it is desirable to use is that number which will permit the disuse of a single unit without inconvenience. Above this number one must be guided by convenience, but in general the fewer units the better, since transformers such as are used in large transmission work vary very little in efficiency under varying load, and hence there is no considerable gain in using small units so as to keep them fully loaded. When using large transformers the difference in efficiency between full load and half load should be no more than two or three-tenths of a per cent, and as a rule the general efficiency cannot be sensibly improved by using smaller units.

In polyphase transmission the transformer unit must be taken to include all the phases, so that this unit will usually consist of two or three allied transformers. In three-phase work the circuit can be operated either with two or three transformers, so that in a measure each transformer group contains a reserve of capacity, since, if a transformer fails, the remaining pair can be connected to do nearly two-thirds of the work. It is inadvisable, however, to try the resultant mesh on a large scale save as an emergency expedient, and the raising and reducing transformers should regularly be in groups of three for three-phase work, connected star or mesh as occasion requires. Very recently combined three-phase transformers have begun to come into use, but there has not yet been experience enough with them to give them a definite place in the art. For very high voltage each phase may have several transformers in series, although, since single transformers are now made for 60,000 volts, such a step is needless unless as an emergency measure.

It is advisable in arranging the transformer plant, to bear contingencies in mind. Spare transformers are a good form

of insurance. In the station raising transformers alone are concerned. These are likely to be of large capacity and high voltage. The individual transformers will very seldom be as small as 50 KW, and the voltage is sure to be from 5,000 volts upward to 10,000, 20,000, or 30,000 volts, and sometimes even more up to 60,000.

For large transformers, both the air-cooled and the oil-insulated types are in common use. The former depend wholly on solid insulating material and are cooled by a forced blast through the ventilating spaces. The heat is so effectively carried off by this means that the output can be readily forced without any material loss of efficiency, and these transformers are therefore somewhat less expensive than others. For work up to 10,000 volts or so they are much used and prove very satisfactory. For the higher transmission voltages, the oil insulation gives a much larger factor of safety, and is therefore usually preferred. The smaller sizes are often merely enclosed in a sheet-iron or cast-iron tank with very deep corrugations to gain radiating surface, and which is filled with petroleum oil carefully freed from the least residual traces of acid and water.

It is a curious fact that such oil seems sometimes to absorb moisture from the air, and may even have to be given a supplemental drying by blowing air through it. Generally, however, the oil furnished for this purpose by the manufacturing companies is in good condition if kept in closed tanks or barrels, but it is advisable to test for moisture in undertaking any large use of it.

In the "self-cooled" transformers just referred to, the radiation from the case is enough to keep the oil from getting too hot, and for sizes up to two or three hundred kilowatts this form of cooling is very generally used. For larger units the natural circulation of the oil as it is warmed by the coils and core is hardly sufficient, and forced cooling has to be employed.

This is generally accomplished by putting just inside the boiler iron case of the transformer a coil of brass pipe through which cool water is pumped or allowed to flow. This furnishes excellent facilities for cooling, and is the plan very generally followed in all the larger station transformers.

Plate VI shows the general appearance of these artificially cooled transformers, while Plate XVI, Fig. 3, shows a bank of the air-cooled type, installed above a common ventilating flue which receives air from a motor blower. Fig. 238 shows the appearance of a self-cooled oil transformer for three combined phases.

Although transformer oil has so high a flashing point as to be practically non-inflammable under any ordinary provocation, it may still be a source of danger when in considerable quantity, and exposed to great and continued heat. It is



FIG. 238.

therefore wise to install oil transformers in such wise as to prevent the spread of burning oil in case of serious fire. They should, therefore, be isolated from inflammable material, and provision should be made for draining off the oil in case of necessity. The cases are usually provided with heavy cast-iron covers through which the terminals come and which protect the oil from access of flames or of air in case of short circuits, which, by the way, very rarely ignite the oil.

It is a good plan to locate the transformers with drainage spaces around them and exits through which the oil can harmlessly flow if, from a combination of accidents, it escapes from

the transformer case. A sloping concrete floor recessed or with low barriers to prevent spreading of oil, and a drainage flue opening outside the building, is effective, as is also a large drainage flue from the bottom of the case, capable of being opened without going too near the transformer, which, of course, should be cut out of circuit before attempting to drain it.

Another plan carried out in the Shawinigan Falls plant is to make the transformer cover oil-tight, and to provide it with a large pipe extending to a sewer. At the bottom of the case is another large pipe connected with the water supply, so that, in case of combustion inside, the water may be turned on and force out the oil through the top. This avoids access of air, and the temporary presence of water is not likely to do much additional damage. In fact, transformers have been through such fires with astonishingly small injury.

Air blast transformers also involve some risk, as the blast fans any burning insulation, and once started combustion may go slowly on long after the blast is shut off. They should therefore always be installed on a non-combustible floor.

In several recent plants the transformers have been placed on tracks leading from the individual transformer cells to a convenient stationary crane, so that if injured they can be rolled out and taken down without the necessity of a travelling crane, which is objectionable as interfering with the free installation of high-voltage wires overhead. With the stationary crane safe wiring is much facilitated.

It is well to surround high-voltage transformers, unless the outer cases are grounded, as in the water-cooled type, with an insulated platform, and in general high-voltage transformers should be treated with extreme respect. The high-voltage leads in particular are likely to require pretty close watching where they emerge from the case, and should be taken out of the transformer house by a simple and direct route. High-voltage transformers are generally given a room by themselves, sometimes a separate building as in Figs. 234 and 235, but even if, as in many small stations, they are located in the general apparatus room, they should be scrupulously railed off and given the place where they will do the least mischief in case of accident. As regards the connections employed for the transformers, most American

plants employ three-phase transmission with a separate transformer for each phase. Whether these or combined three-phase transformers are used, there are obviously many possible methods of connection, since the primaries and secondaries of each group may be either in star or in mesh, and the generator may also be in star or in mesh.

In the star connection the voltage between either wire and the neutral point is $\frac{1}{\sqrt{3}}$ or about 58 per cent of the working voltage between wires, and if the neutral point be grounded the maximum voltage between a wire and the ground is limited to this amount. The voltage demanded of each transformer is therefore reduced, and the strain upon the insulators likewise. Operating with a grounded neutral, however, implies a more or less serious short circuit of one phase in case of a ground elsewhere upon the line, together with a flow of current through the earth which may and sometimes does cause seri-

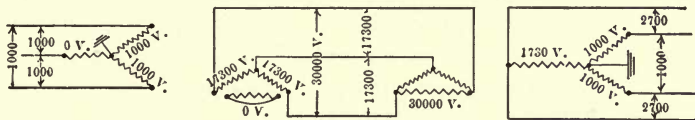

FIG. 239.

ous trouble to any grounded telegraph or telephone wires in the vicinity.

With the mesh connection the strains upon the insulation of transformers and line are higher in the proportion of

$\frac{1}{\sqrt{3}} : 1$, but no single ground causes a short circuit or heavy

earth currents, and if one transformer of the trio is crippled the other two can be connected in resultant mesh so as to deliver somewhat more than half the original capacity of the bank.

An ungrounded star connection is very sensitive to grounds and other faults, and the neutral point easily drifts so as to greatly disturb the phase relations and voltages. This disturbance affects the whole system, and may cause dangerous rise of potential if the conditions are favorable.

The sort of thing which may happen is well exemplified in

Fig. 239. Here a generator voltage nominally 1,000 is raised to 10,000 volts by a star-mesh combination, and lowered by a mesh-star to a nominal 1,000 volts for distribution. The raising and lowering star neutral points are grounded, but the generator neutral is not. The diagram gives the distribution of voltages when there is a ground on the low-tension side of one raising transformer of which the high-tension coil is open. The result evidently might be disastrous, even as it is, and such an electro dynamic wrench would very possibly provoke resonance or start formidable surging. On the face of things such an accident would seem to be very improbable, but it might easily happen if one undertook to cut out the high-tension side of a damaged transformer during the progress of a burn-out in the coils.*

On account of such possibilities all three phases should be opened and closed simultaneously and never by single switches, unless in changing connections when all the lines are dead. As regards the possible abnormalities of voltage due to accident, the whole matter may be summed up by saying that the regular mesh system is safe from them, and star connections are also safe when grounded at the neutrals throughout the system *including the generator*. Mixed connections of star and mesh are likewise safe when grounded at the neutrals of every star. The following combinations are commonly found in practice.

CONNECTIONS THROUGH SYSTEM.

Generator.	Raising Transmission. (Low tension.)	Raising Transmission. (High tension.)	Reducing Transmission. (High tension.)	Reducing Transmission. (Low tension.)
Mesh	Mesh	Mesh	Mesh	Mesh
Mesh	Mesh	Mesh	Mesh	Star
Star	Star	Star	Star	Star
Mesh	Mesh	Star	Star	Mesh
Mesh	Mesh	Star	Star	Star

All these can be made thoroughly operative if all the neutrals indicated are grounded. The first and fourth on the list are perhaps rather more used than the others. The last three

* For valuable information along this line, see Peck. Trans. A. I. E. E., Vol. XX, p. 1248.

have a star connection on the main transmission circuit, which considerably lessens the strain on the insulation, and somewhat simplifies protection against lightning and static disturbances, but at the cost of heavy short-circuiting in case of a ground. Choice of a system depends very much on the particular kind of risks likely to be locally met, and in many plants the various connections are used just as occasion dictates. The real question involved is the desirability of working with a grounded neutral, which varies very much according to circumstances. In many cases it is advantageously used on a large scale, while now and then the conditions seem decidedly adverse.

It should of course be understood that transformers in power transmission work can be, and very often are, worked in parallel with the greatest facility. Transformers to be so used must have closely similar magnetic characteristics, and particularly must regulate alike under varying loads. They must also have independent fuses or other safety devices, so that each can take care of itself. In all cases it is highly desirable to have one or more spare transformers, ready to be cut in at a moment's notice anywhere that may be necessary.

Where transportation is difficult, the installation of transformers is rather a serious problem. Generally speaking, it is best to sectionalize the coils, each section being independent and fully insulated. The core plates can then be taken in in bundles and the transformers built up on the spot, with whatever additional insulation may be necessary. Of course means must be at hand for the final testing, including a small testing transformer to obtain the necessary voltage.

The most important accessories of a plant pertain to the switchboard, which in high-voltage transmission work has to be planned and constructed with extraordinary care. The component apparatus will be considered in the next chapter.

The location of the board involves some troublesome considerations. In small plants by far the best place for it is at the general level of the generators and midway the powerhouse wall opposite them. In plants with only three or four generators it can sometimes well be placed at one end of the building, as in Plate XVI, Fig. 3. Generally speaking, the best

location is the most accessible, for in case of trouble it is usually necessary to reach the switchboard on the instant. Hence it should be close to and easily visible from the line of generators. It should also be set so as to have good light both before and behind, with plenty of room in the rear. All combustible material should be eliminated from its vicinity.

The modern board is generally built up of marble panels, each containing the apparatus for a single generator, with supplementary panels for the apparatus pertaining to feeders and to the plant as a whole. Behind the board are the necessary transformers for the instruments, all the wiring, and all the high-voltage connections. This arrangement implies ample room, which is not always allowed for in designing the power house.

In large plants it is now common to install the switchboard in an elevated gallery overlooking the generator room, as in Fig. 235. This, of course, necessitates a special attendant constantly on the watch and alert. It is a very pretty arrangement when everything is going well, but in case of extremity the switchman cannot either see or hear as well as if he were nearer the seat of trouble, and it necessitates a great deal of heavy wiring, and high-voltage concealed wiring at that, which is a source of some danger. On the whole, it seems inadvisable to use the gallery switchboard unless one is prepared at the same time to use a complete system of remote control switches, reducing the elevated board to a mere control desk overlooking and facing the generators. If the switches are also arranged for manual control in emergencies, such an arrangement has much to commend it, but as a rule a board of the moderate degree of complexity usual to power transmission plants is none the better for being in a relatively inaccessible gallery.

Whether the board is an elevated control board or a manual board on the floor, there are certain often neglected precautions which should be insisted upon. Whatever other switches are installed, each generator should be equipped with a switch between it and the general connections of the board, as near the generator as possible in fact, and able to break the circuit under the severest conditions. This should have both

manual and remote control, if for large output. There have been a great many costly accidents in power houses because somebody wanted a compact and handsome board, which eventually short-circuited inside the switches.

The present tendency is to do as much of the switching work as possible on the low-tension wiring, and to leave the high-tension side of the transformers pretty much to itself. The tendency is a healthy one, but in many cases there must be provision for opening the high-tension circuits under load. Switches for such work are readily available at least up to 50,000 or 60,000 volts. The wiring of a transmission plant should be kept as simple as feasible. In so far as is possible, all the main leads should be kept in full view, and when they must pass out of view they should be insulated with extreme care, and preferably carried in separate ducts which can be kept dry and clean. One of the very common sources of trouble is found in the cables, which some one with an obsession of neatness has stored away too compactly. The worst shut-down which has occurred in the great Niagara plant since it went into operation was due to this cause. Cables running under the floor to the switchboard are fertile sources of trouble and should be avoided when possible.

In any event, the high-voltage wires should be in plain sight all the way from the transformers to the exit from the building. It is far better to do without a permanent travelling crane in handling the transformers, than to take the chances that come with concealed high-voltage wires. In the Shawinigan Falls plant already referred to, the transformers are arranged so that they can be slid upon rails under a fixed tackle, and a little ingenuity will usually make it possible to locate the high-voltage wires and preferably the generator leads also where they shall be in full sight.

All these things must be taken into account in building a power station, since afterthoughts are apt to be costly and ineffective. In designing a power transmission plant, everything about the station should give way to utility, and the aim of the designer should be to produce a building that shall be convenient, accessible in every part, well lighted, and fire-proof. If at the same time it is cheap to construct and of

pleasing exterior, so much the better, but stations are not intended for decorative purposes.

In the way of mechanical fittings, the first place is generally given to a travelling crane, capacious enough to move everything which is likely to need moving about the plant. Not only is it exceedingly useful in installation, but it may be needed for repairs, and in such case may save much valuable time. It need not be of the most elaborate construction, being only intended for occasional use, and, in view of possible interference with the wiring, may sometimes well be reduced to the simplest possible terms, merely a bridge to which tackle can be affixed when needful.

It is very important to have at least one man about the plant who is a good practical mechanic, and to provide a work-room and tool equipment enough to enable small repairs to be made on the spot. In most cases material and tools for minor electrical repairs are necessary, and they are always desirable, for they make it possible to forestall further repairs, and often will tide over an emergency, even if outside help has finally to be called in. The more isolated the station, the more necessary it is to make such provisions, and the more spare parts must be at hand. Of line material there should always be plenty in stock to repair breaks, and this stock should never be allowed to get low.

Finally, as regards attendance, incompetent men are dear at any price. It pays to employ skilled men and to make it worth their while to settle down to permanent work. They are valuable all the time, and can be depended upon in an emergency when less competent ones would fail. In this as in other things, avoid the fault stigmatized in the vernacular as "saving at the tap and spilling at the bung-hole."

CHAPTER XII.

AUXILIARY AND SWITCHBOARD APPARATUS.

IN this category one may properly place a wide variety of apparatus employed in generating and substations for all sorts of purposes. A station implies far more than generators and prime movers, although the choice and placing of these with relation to the work to be done is the chief consideration in station design.

After the generators the most important items in station design are the exciter equipment and switchboard, subjects merely outlined in the previous chapter. As regards the first, certainty in operation is the main requisite. In some of the earlier plants it was the custom to provide each generator with an individual exciter generally belted to a pulley on the generator shaft. This plan is objectionable in that any trivial failure in the exciter may put the generator out of service, unless an additional source of excitation is provided. Granting the necessity of such other source, one naturally falls into the judicious present practice of providing two or more exciters driven from independent prime movers, and each large enough to supply, if occasion requires, exciting current for all the generators or for a considerable group of them.

Speaking in general terms, the exciting energy required is from 1 to 3 per cent of the full generator output, and as it is good policy never to work an exciter very hard, a considerable margin of capacity is desirable.

As a rule, it is well to install exciters of moderate speed, directly coupled to independent water-wheels in case of hydraulic stations. The wheels should be provided with first-class regulators and installed in such wise that they will not be interfered with by any ordinary hydraulic difficulties. Of late it is not unusual to find one or more motor-driven exciters, a motor generator set or sets being installed in addition to the wheel-driven equipment. The motors are induction mo-

tors designed for very small variation of speed with load, and supplied with current from the general bus bars of the system.

This practice has both good and bad features. Its strong point is that in case of hydraulic troubles, anchor ice for instance, the small wheels may be considerably affected, making it very difficult to hold up the voltage. On the other hand, in case of trouble on the lines, one is better off with an independent drive for the exciter. In any case, the exciter fields should be given a liberal margin of capacity, so that in case of reduced speed the voltage can be easily kept up.

In steam-driven stations the motor-driven exciter is a source of some economy, since small steam engines are generally uneconomical, while the losses in the motor are comparatively small. However driven, the exciters should be so connected as to allow them to be interchanged at a moment's notice. To facilitate this, one should never rely on a single exciter in operation, but should keep a spare exciter ready for action, even if it is not actually at speed and running in parallel with the one in use.

The exciter panels on the switchboard should occupy a prominent and accessible position, since, if anything goes wrong with the exciting circuits, it must be remedied at once. The location of the exciters themselves is immaterial, save as they should be placed where they can be easily inspected and cared for.

The subject of exciters naturally leads to that of voltage regulation. The division of the total regulation between the generating plant and the substations is always a somewhat dubious matter. On long lines in which the total loss is considerable, the work is generally divided, the coarse regulation of the plant as a whole being done at the power plant, and the feeder regulation at the substation. If the power station can hold constant voltage at the secondary bus bars of the reducing transformers, a long step toward good regulation will have been taken. This can be done by hand regulation, but at the present time there are several automatic regulators quite capable of doing the work with sufficient precision. Several forms of automatic compounding have already been considered, but the regulators proper are instruments responsive to varia-

tions of voltage from whatever cause, and operating to compensate for variations of speed as well as of load and power factor. They may be worked by pressure wires coming back from the load, or by the station secondary voltage compensated for variations in load.

They are essentially voltmeter relays acting on the excitation of the generators or exciters. One of the best known forms is the Chapman regulator, of which the typical connections are shown in Fig. 240. The relay, it will be noted, is

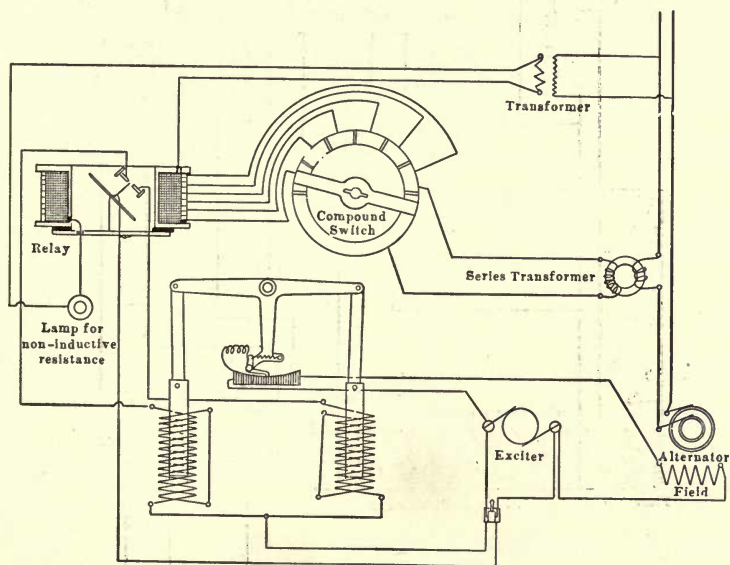

FIG. 240.

compensated by a variable winding carrying current from a series transformer, which enables the voltage to be held constant, through to the end of the line, and to, or even beyond, the reducing secondaries if necessary. The main automatic rheostat is controlled by this relay, and is placed ordinarily in the field circuit of the generator, or in the field of the exciter if the load variations are not likely to be extreme. It is very prompt in action, and nearly dead beat.

The relay is ordinarily adjusted to hold the equivalent secondary voltage constant to about one-half of one per cent,

or closer if necessary, and the whole arrangement is simple and effective.

Another excellent and very ingenious voltage regulator is made by the General Electric Co. Its connections are shown in diagram in Fig. 241 as applied to a single generator and its exciter. The fundamental method employed is the opening

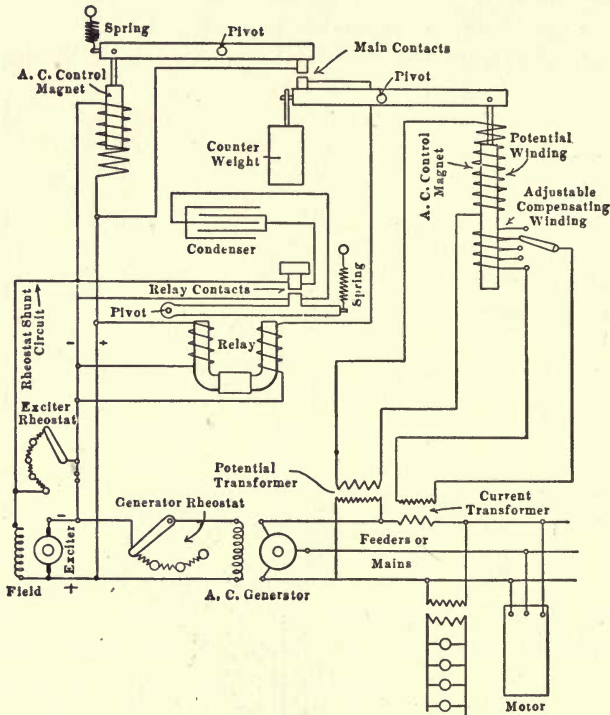

FIG. 241.

and closing of a fixed shunt around the field of the exciter. At first thought, this would seem to vary the excitation by leaps, but the play of the relays keeps the magnetization steady by catching it before it has gone further than needful, the natural inertia of the magnetic changes giving the requisite amount of stability to the process. The d.c. control magnet checks too extensive changes without throwing the work on the voltage relay proper, which is provided with an adjust-

able compensating winding derived from a series transformer. The office of the condenser is to relieve sparking at the main contacts.

Both these regulators give excellent results in practice and have proved thoroughly reliable. They take care of both variations in speed and in load, but under extreme variations of power factor the series windings on the relays may require some readjustment. They can be applied to many problems of automatic regulation with admirable results. In somewhat simpler forms they have been considerably used in regulating direct current generators, particularly when driven from water-wheels, in which case the effect of small changes of speed may have to be guarded against. Their use is extending, although many large plants depend entirely upon hand regulation, which, if carefully carried out, gives first-class results when the load does not vary too erratically.

Some general suggestions on switchboards have already been given, in addition to which it is worth while to examine the principles which underlie switchboard design.

The whole purpose of a switchboard is to make easy the changes in connections necessary in the practical operation of a station. It is not to supply architectural effects in polished brass and marble, or to furnish employment for extra attendants. The fundamental switching operations are comparatively simple, and beyond these there are some which are desirable and others which are of more or less fanciful value. Likewise, in the matter of switchboard instruments, some are necessary, others desirable, and still others mere casual conveniences. In the interest of economy and easy operation, it is well to keep the design simple, for it is a perfectly easy matter to double the necessary cost of a board without making any compensating gains.

The first thing for which provision must be made is the connection of the several generators to the bus bars. The next is for the connection of these to the lines or to the low-tension sides of the several transformers. If the latter, the third requisite is the connection of the high-tension sides of the transformers to the several lines. As a general rule, the less switching done at high tension the better, but it is at times

necessary. Beyond this, provision must be made for the excitation of the generators, their operation in parallel, and the measurement of their output to guard against overloads. Then, in addition, there may be an almost endless array of accessories and provisions against more or less remote contingencies. Fig. 242 gives diagrammatically the elementary switching connections for a transmission power station feeding

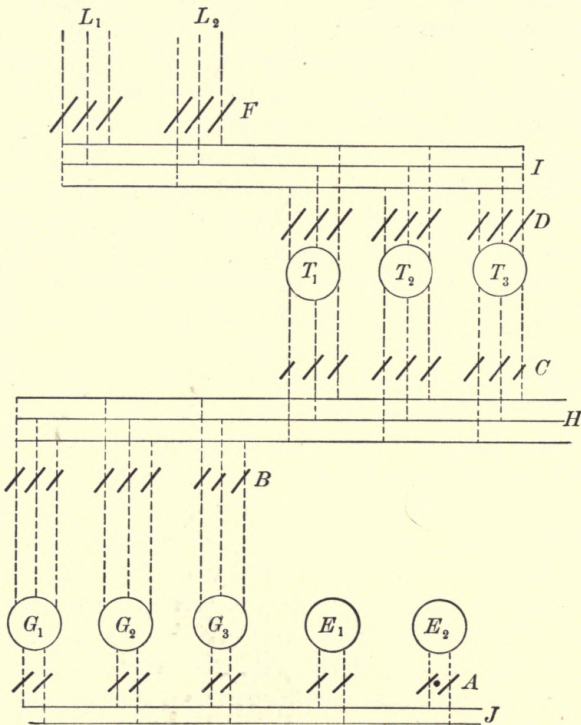

FIG. 242.

duplicate lines. Here E_1, E_2 are exciters, G_1, G_2, G_3 the generators, T_1, T_2, T_3 banks of transformers, and L_1, L_2 the lines.

A is the row of excitation switches, *B* the generator switches, *C* the low-tension transformer switches, *D* the high-tension transformer switches, and *F* the high-tension line switches. *H, I, J*, are the generator, transformer, and exciter bus bars respectively.

The plant is operated in parallel throughout, and the switching requirements are of the simplest kind. The moment parallel operation is abandoned and separate generators are assigned to separate duties, switchboard complication begins. Thus, if one introduces the requirement that the lines $L_1 L_2$ shall be operated entirely independently of each other, in order that the service shall be interchangeable in the station the bus bars H, I , must be in duplicate, the switches B, C, D , must be double-throw or in duplicate, and the switches F must be in duplicate. If still more lines are to be entirely independent, the complication increases at a frightful rate, and can only be avoided at the cost of lessened interchangeability. As high-tension switching devices are expensive, the expense incurred for complete interchangeability may run up to a good many thousand dollars, and the case is generally compromised.

When there are many transformers located at some distance from the generators, the connections are often made by duplicate cables from H to a low-tension distributing bus bar at the transformer board. The main thing is to make the switching connections as simple as is consistent with security of operation under the required conditions.

Even in Fig. 242 there are required 11 heavy switches, 5 of them being for the full line voltage, and in theory any one of the 11 may have to open its circuit on an overload.

In most transmission plants, switching at the high voltage under load is avoided as far as possible, and the switches at D , and also sometimes at F , are merely disconnecting switches often with fuses as a protection against overloads. Such disconnecting switches should always for polyphase circuits make a complete break of all phases to lessen danger from surging, single-pole switches being reserved for cases safe from the necessity of opening under load.

Fuses for transmission circuits are somewhat troublesome at the higher voltages, but serve a useful purpose in an emergency, by cutting off severe overloads. They are disadvantageous in that they may open but a single leg of the circuit, and that in a way to provoke surging, but they only come into play in extreme cases when there is trouble ahead, anyhow.

The types used most are expulsion fuses, enclosed powder fuses, and very long wire fuses often enclosed in glass tubes. Moderate voltage plants, say up to 20,000 volts, are readily safe-guarded by fuses, but at higher pressures more caution is necessary. But fuses are so much cheaper than any form of high-voltage overload switch yet devised — a few dollars

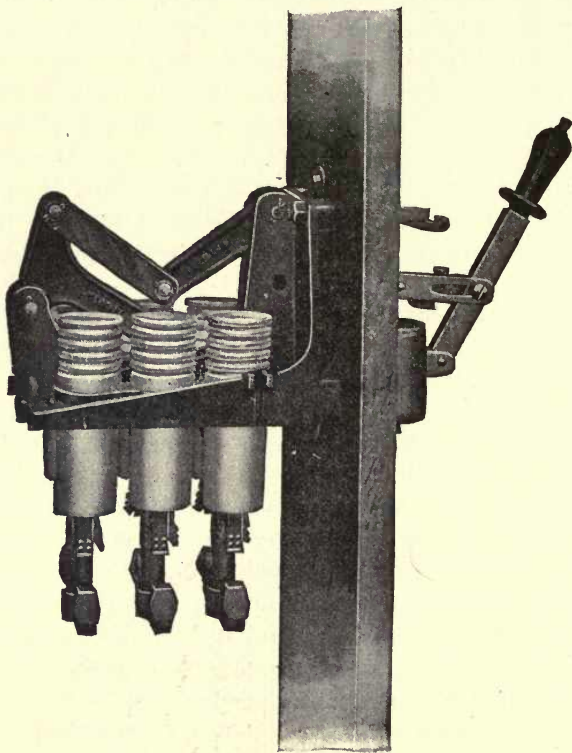

FIG. 243.

as against a few hundred — that they cannot be lightly put aside.

As to switches, the oil break type is by far the most reliable for breaking considerable currents at high voltage. The arcing power of a high-pressure alternating circuit is so tremendous that in air switches the gaps must be very long, even to a good many feet, to entirely prevent any chance of the arc

holding. Now and then the opening switch may catch the circuit nearly at zero current and open with very little disturbance, although as a rule the effects are somewhat pyrotechnic in appearance. The switch breaking under oil on the contrary very rarely makes any noticeable disturbance and seldom starts severe surging. It is the best means of opening a high-voltage circuit, and is almost universally used for the principal work of the power house.

Fig. 243 is a typical oil switch for voltages of 13,000 and below. It is a three-pole double break switch of the plunger form, shown in the cut with the oil tank in which the contacts

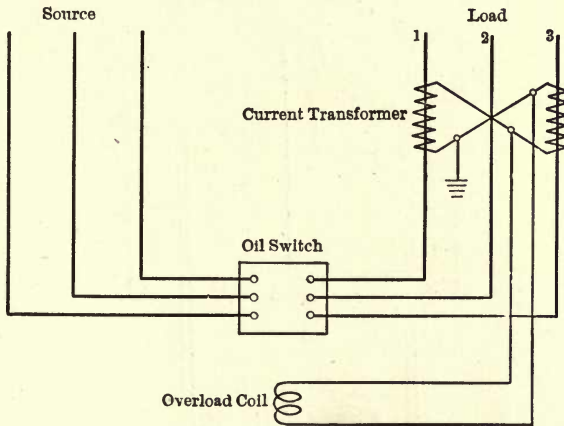

FIG. 244.

are submerged, removed for inspection. The plunger is operated by means of a toggle-joint from a hand lever on the front of the board, and the example here shown is also fitted with an electro-magnetic release which can be operated from a remote point, or which, if energized by series transformers in the main circuit controlled, can convert the switch into an automatic circuit breaker for overloads. Such switches are very prompt and certain in their action, and serve admirably for the main generator switches, or for line switches at moderate voltage. As generator switches the automatic overload device is not needed in most instances, as station operators ordinarily prefer to keep the generators in action through any but very severe and prolonged overloads.

Not infrequently, time limit relays are applied to such automatic switches, arranged with an adjustable dash pot so that an overload lasting less than a predetermined number of seconds will not cause the opening of the switch. In still another modification, this limit is automatically shortened in case of very severe overloads. The ordinary connections of Fig. 243 as an automatic switch are given by Fig. 244.

At the present time there is a rather strong tendency, often carried to an extreme, to arrange these important switches for remote control, the switches being located back of or otherwise away from the board and operated by a small actuating switch

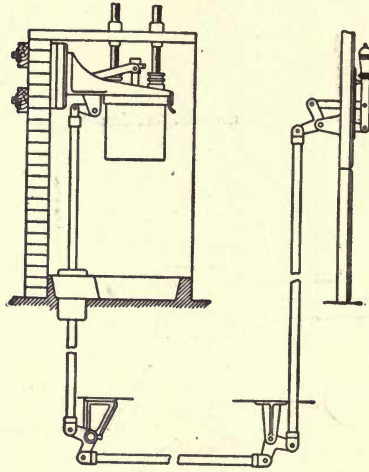

FIG. 245.

on the board. This has been a natural outcome of placing large and complicated boards in a gallery with limited room at the immediate back of the board. It is often inconvenient to place large oil switches on the board itself, and it is not a bad plan to connect them to the board by operating levers which will allow the switches to be placed where they have ample room, as in Fig. 245.

Less commonly, the conditions call for a switch entirely operated by electric power. Such switches are generally those for very high voltage or very large output, which are bulky and require elaborate insulation. They are intended to be

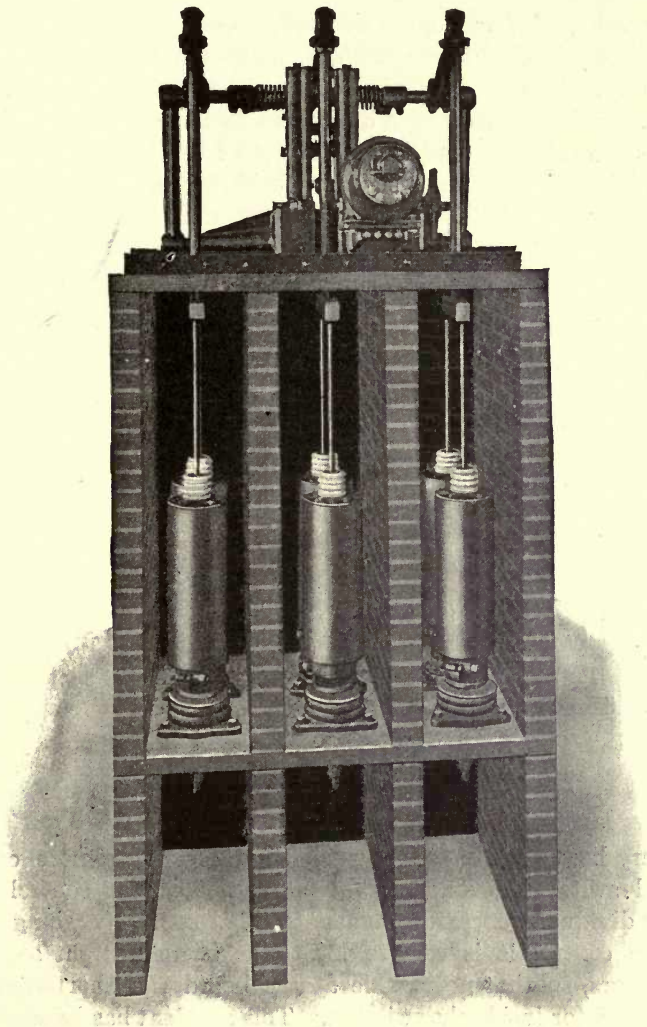

FIG. 246.

operated from the board or by hand if necessary, and are placed in a safe and convenient position quite irrespective of the board.

Such a remotely controlled switch as made by the General Electric Company, for voltages even up to 60,000 and at

lower voltage for very large outputs, is shown in Fig. 246. It is a three-pole double break affair, with each break in a separate oil tank, and each phase in a separate brick compartment. It is operated by a d.c. series motor generally worked from the exciting circuit and controlled from the switchboard to which its operation is signalled back. Fig. 247 shows the connections of this form of apparatus, which is used chiefly

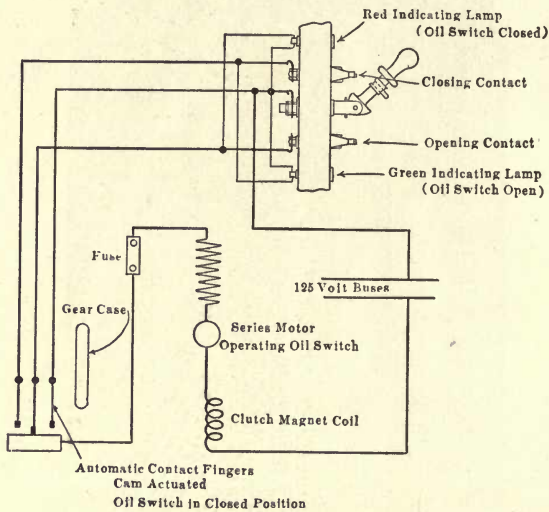

FIG. 247.

for very heavy work. One great advantage of remote controlled switches, seldom, however, realized, is for control of the individual generators as at *B*, Fig. 242. By going to remote control it is easy to locate the switches right at the generators, so that no trouble at the board can short-circuit the generator inside the switches. This accident has happened a good many times with disastrous results, for the switchboard and its connecting cables are by no means an insignificant source of danger.

In Plate XIX is shown a Westinghouse remote control switch for large work at 60,000 volts. It is operated not by a motor as in Fig. 246, but by powerful solenoids actuating the switch mechanism directly. Switches for such high voltage should

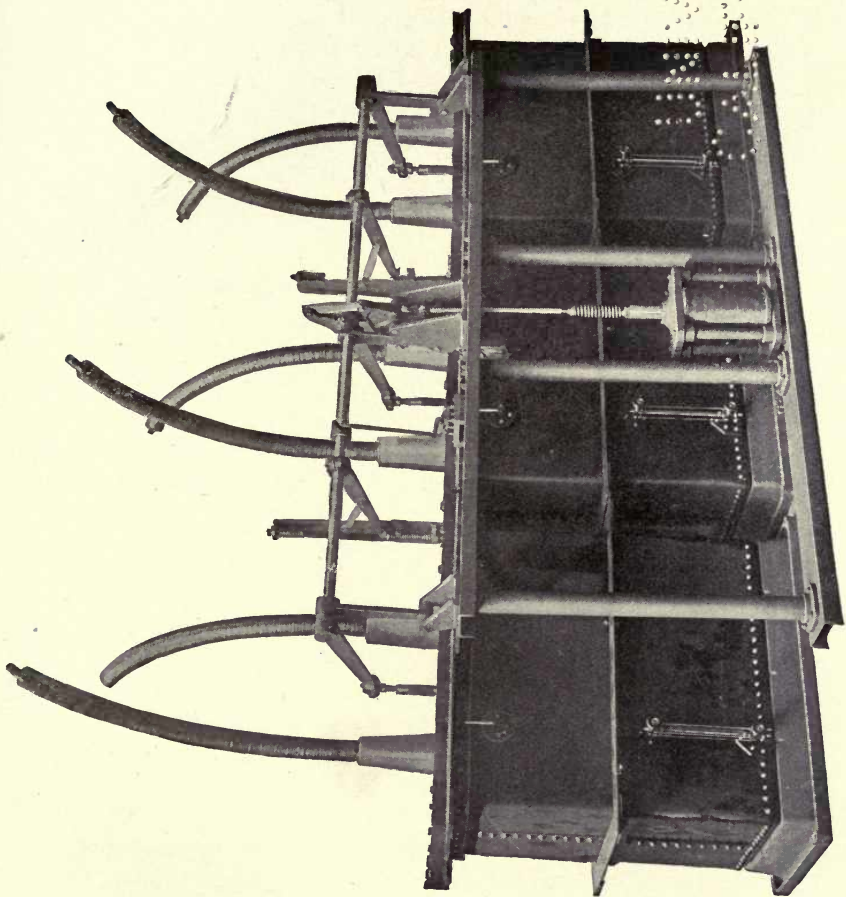

PLATE XIX.

be operated very carefully, and the leads to and from them must on account of the voltage be elaborately insulated and located with extreme caution. By the use of electrically operated switches, it is sometimes possible to simplify the high-tension wiring very considerably. They can obviously be made automatic if necessary or desirable. They are, however, very expensive, and on this account should be used only where there is very good cause for choosing them as against hand-operated switches. Electric actuation in itself is an additional complication, rendering switching easier but somewhat less direct and certain, and should be resorted to only when the

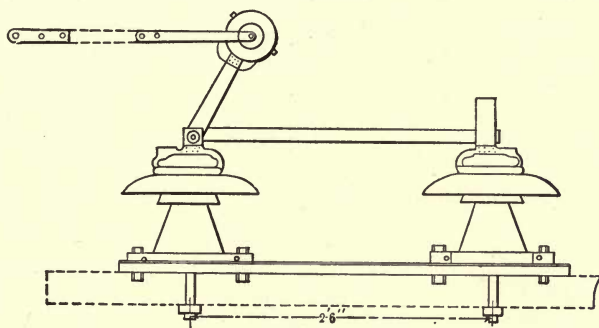

FIG. 248.

total complication is thereby materially diminished. In installing high-voltage oil switches, they should be provided at some point with disconnecting switches to facilitate inspection and repairs by cutting them clear from the circuits.

A capital air switch for disconnecting duty and for opening lines under moderate load was described recently by Professor Baum, as in successful use up to 60,000 volts by the California Gas and Electric Co. It is a three-blade switch mounted on high-tension insulators and arranged for operation by a lever and long connecting rods. Fig. 248 shows the detail of a single blade. An outdoor switch of similar construction, made double break, is shown in Fig. 249. This is used for disconnecting load up to say 1,000 K.W, while the former pattern is used for connecting the high-tension side of transformers to the bus bars. The main thing in designing such switches is

to give them ample insulation and a long, quick break. In the practice of The California Gas and Electric Co., no fuses or circuit-breakers are used at the power plant, but the transformers are fused at the substations.

In the operation of important stations the tendency is to hold on as long as practicable in case of a short circuit on the lines, on the chance of the line clearing itself without compelling a shut-down. Hence automatic safety devices are rather sparingly employed. In many respects the working of long-distance power transmission plants is peculiar. With many miles of lines in circuit, a fault, even if it could be quickly located, cannot often be quickly reached. The lines are few in

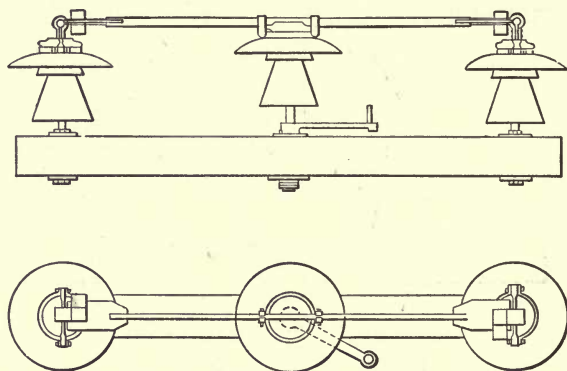

FIG. 249.

number and heavily loaded, each supplying energy over a great area. From the consumer's standpoint it is quite as bad to have a line switch opened as to have a line burned off by keeping the switch shut. There is a chance of burning off a short-circuiting twig, for instance, before the line itself fails, and that chance is usually taken — and wisely.

The instruments used in power transmission stations are kept almost entirely on the low-voltage side of the equipment. Those needed for each generator are customarily located on a standard panel, and these panels are united into a complete section of the switchboard. As the generators are in plants using raising transformers seldom for higher voltage than 2,000 to 2,500, the provision of instruments involves no difficulties,

and the equipment of each panel is about as follows in case of a three-phase machine:

- 3 Ammeters.
- 1 Voltmeter.
- 1 Plug for connecting voltmeter to any phase.
- 1 Main Switch.
- 1 Plug for connecting synchronizing device.
- 1 Disconnecting Switch for isolating main switch.
- 1 Field Rheostat.
- 1 Field Switch.
- 1 Field Ammeter.

To this list is sometimes added a wattmeter, either indicating or integrating, as the case may be. In assembling these into a generator board, there are added the exciter panels, each carrying a voltmeter, ammeter, field rheostat, and main switch, and in case of motor-driven exciters extra motor panels with the appropriate instruments. The necessary potential transformers, current transformers, oil switches, and heavy accessories are located behind the board, no high-voltage parts being allowed upon the front of it.

For the whole plant there is provided a suitable synchronizing device, and to this may be added a frequency indicator and a power factor indicator, both of which are convenient, although neither is necessary. Besides the panel carrying these, there may be others in large systems providing for switching groups of generators upon a general main set of bus bars, perhaps itself sectionalized. These latter complications, however, are seldom found in power transmission plants engaged in ordinary general service.

At present, the once universal phase lamps are commonly used only as auxiliaries, the real work falling upon the "synchronoscope" or "synchronism indicator" which is far more convenient. Such a device is manufactured both by the Westinghouse and General Electric companies. The latter form is shown in Fig. 250. Externally it consists of a case with a dial and pointer. When connected to the bus bars and to the incoming machine, the direction of rotation of the pointer shows whether the incoming machine is running too fast or too slow, a complete revolution meaning the gain or loss of one cycle.

The amount of displacement therefore indicates the phase angle of the incoming machine, and when the pointer is steady at zero the machines may be thrown together. Internally the device is essentially a pair of rudimentary induction motor fields, each energized from one of the machines to be parallelized, and acting in opposite directions upon a common armature attached to the pointer. In polyphase circuits the arrangement is very simple. For application to single phases the fields are con-

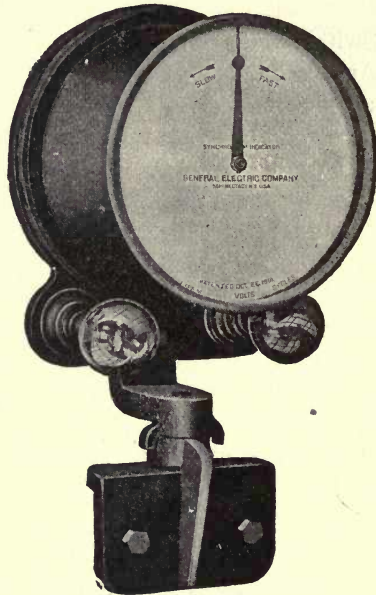

FIG. 250.

nected as split-phase motors by means of a combination of resistance and reactance. Obviously the device can then be used with either single-phase or polyphase circuits, and such is the usual form of the instrument, which is often mounted adjacent to a pair of voltmeters, one on the main circuit and the other capable of connection to any machine by means of a system of potential plugs.

In the practice of the Westinghouse Co., a very ingenious scheme of automatic synchronization has been worked out, whereby at the proper moment a relay closes the actuating

circuit of an electrically operated main switch. The arrangement is shown diagrammatically in Fig. 251 as applied to synchronizing a rotary converter. The relay scheme is very ingenious, being a balanced and slightly damped lever actuated by opposed coils from the synchronizing circuits. As synchronism is approached, the resulting pulls alternate at lower and lower frequency and are more effective against the damping, until finally, when synchronism is reached, the relay circuit closes and the machines are thrown together with the utmost precision. In many cases a refinement of this sort is

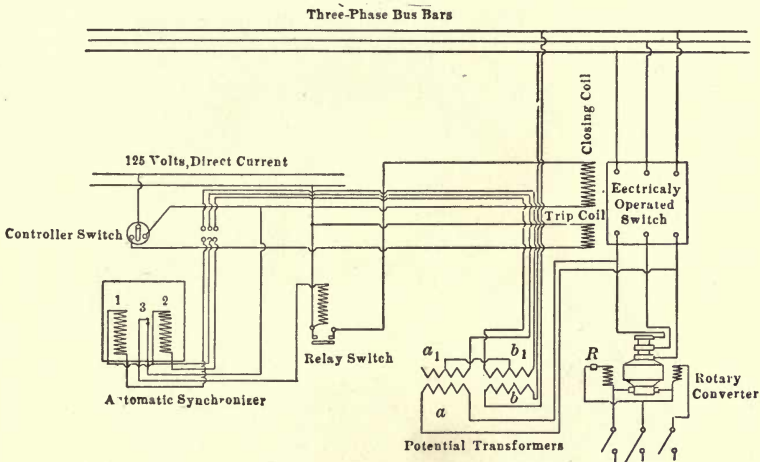

FIG. 251.

quite unnecessary, in others it is likely to prove exceedingly convenient.

The power factor indicator is a comparatively recent addition to station equipment, but one that is most serviceable in station operation. In particular it gives a very valuable check on the regulation which we have seen varies greatly with the power factor. It also enables one very readily to adjust rotary converters and synchronous motors for minimum input. It is essentially an instrument for balanced circuits, and is graduated to read power factors directly on such circuits. It is essentially a differential combination of wattmeter and volt-ampere meter.

The frequency indicator is very convenient in detecting any

tendency to vary from the normal periodicity. In principle it is a voltmeter specialized so as to be hypersensitive to variations of frequency, and with a scale graduated to these variations while being relatively insensitive as a voltmeter when near its rated normal voltage by reason of relatively great reactance. It might well be given an extra scale, in stations having uniform generators, fitted to read generator speed directly.

Ground detectors used to be a regular part of station equipment, but as transmission voltages have risen these instruments

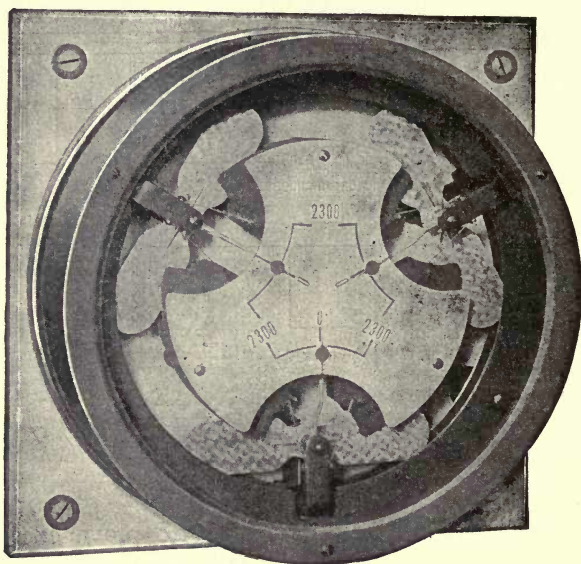

FIG. 252.

have become more and more difficult safely to apply, so that as regards high-voltage circuits they are little used, grounds making themselves all too obvious without special instruments. Up to 10,000 volts or so, and especially on cable circuits, they may be of considerable service. Fig. 252 is one of the common forms for a three-phase circuit. It, like most of its class, is an electrostatic instrument with an electrometer leaf and pointer for each phase.

Most station instruments are now made with illuminated

dials, and are very frequently put up in edgewise form so as to economize space on the switchboards. They should be checked by standard instruments at frequent intervals, as even the best of them are liable to get out of order occasionally.

The lighting of a station is a simple enough matter, the main consideration being to leave no dark corners. It is good policy, whatever the ordinary source of current, to have independent means of throwing part at least of the lights upon an exciter circuit so that an accident will not leave the station in darkness.

As already intimated, there is a wide range of possibility in supplying stations with instruments, switches, and auxiliary equipment generally. With respect to automatic devices of various kinds especially there is much room for difference of opinion. If too liberally supplied, there may be reached a point where the care of them is more onerous than the functions which they assume. There is also some danger that the station staff in depending upon them will lose something of alertness. And in any case, it must be remembered that even the best automatic devices may go wrong, and that manual means of control should always be ready for use if necessary, and that without delay.

CHAPTER XIII.

THE LINE.

THE line is a very important part of a power transmission system, for on its integrity depends the continuity of service without which even the most perfect apparatus is commercially useless. In most cases the customer who uses electrical power neither knows the efficiency of his motor nor cares much about it, so long as the machine goes steadily along without the annoyance and expense of frequent repairs. But if the service frequently fails, suspending the operation of all his machinery while repairs are being executed, the electric motor, so far as he is concerned, is a commercial failure, and a nuisance to boot, and no representations of cheap power can be of much avail when a single stoppage may cause more loss than could be recompensed by free power for a month.

Modern dynamos and motors of almost every class are reasonably efficient and reliable, so that as a rule the line is the weakest portion of the system. More particularly is this the case when the distance of transmission is great and many miles of line must be guarded, inspected, and kept in perfect working order. In such long lines, not only is the actual labor of maintenance great, but the principal engineering difficulties will there be encountered. With apparatus of the character even now available, the future of electrical power transmission depends in very large measure on the development that takes place in the construction, insulation, and maintenance of the line, together with the solution of certain electrical problems that arise as the line grows longer. It is therefore important to go into the matter very carefully, as regards not only the general arrangements and the electrical details of the work, but with respect to methods of construction.

We may then with advantage divide our consideration of the line into three heads. First, the line in its general relations to the plant, considering it merely as a conductor. Second, the line as a special problem in engineering. Third, the line

as a mechanical structure. Of these heads the first has to do with such questions as the proper proportioning of the line as a part of the system, its function as a distributing conductor, and its bearing on the general efficiency of the plant of which it is a part. Next come up for examination the electrical difficulties that appear in the line, and finally the materials of construction and the methods of applying them.

One of the first questions that arises in designing a plant for the transmission of power, is the character and dimensions of the conducting system in their relation to the rest of the plant. Efficiency is generally the first thing considered — cost comes as a gloomy afterthought; and between these two, good service is only too frequently neglected. In taking up a transmission problem, the layman's first query generally is, "How much power will be lost in the line?" and when the engineer answers, "As much or as little as you please," the subject of line design is opened up in its broadest aspect.

Whenever an electrical current traverses a conductor, there is a necessary loss of energy due to the fact that all substances have an electrical resistance which has to be overcome. The energy so lost is substantially all transformed into heat, which goes to raising the temperature of the conductor, and indirectly that of surrounding bodies. The facts in the case are put in their clearest and most compact form by Ohm's law, $C = \frac{E}{R}$.

This states that the current is numerically equal to the electromotive force between the points where the current flows, divided by the resistance. Hence, this E. M. F. equals the current multiplied by the resistance between these points.

$$E = CR.$$

This tells us at once the loss in E. M. F. between the ends of any line, provided we know the current flowing and the resistance of the line. And inasmuch as the energy transmitted by the same current varies directly with the working E. M. F., a comparison of the loss in volts determined as above, with the initial E. M. F. applied to the circuit, shows the percentage of energy lost in the line. Obviously its absolute amount in watts is equal to the volts lost, multiplied by the

current; *i.e.*, CE , or from the last equation C^2R if we prefer to reckon in terms of resistance. As the loss of energy varies with the square of the current, halving the current would divide the absolute loss by four, and the percentage loss by two, since the total energy is proportional to the current, the *E. M. F.* being fixed.

A glance shows that the voltage employed is the determining factor in the cost of the lines. For a fixed percentage of voltage loss, doubling the working voltage will evidently divide the amount of copper required by four, since the current for a given amount of energy will be reduced by one-half, while the actual volts lost will be doubled in maintaining the fixed percentage.

So in general the amount of copper required for transmitting a given amount of energy a given distance at a fixed efficiency, will vary inversely as the square of the voltage.

If the distance of transmission is doubled, the area of the conductor will evidently have to be doubled also; consequently, since the length is doubled, the weight of copper will be increased four times. That is, for the same energy transmitted at the same per cent efficiency and the same voltage, the weight of copper will increase directly as the square of the distance. The advantage and, indeed, necessity of employing high voltages for transmissions over any considerable distance is obvious. In fact, it will be seen that by increasing the voltage in direct proportion to the distance, the weight of copper required for a given percentage of loss will be made a constant quantity independent of the distance.

If one were free to go on increasing the voltage indefinitely without enormously enhancing the electrical difficulties, power transmission would be a simple task, but unfortunately such is not the case. With very high voltages we meet difficulties both in establishing and maintaining the insulation of the line, and in utilizing the power after it is successfully transmitted. The specific character of these limitations will be discussed later, but enough has been said to render it evident that in establishing a power transmission system, both the working voltage and the volts lost in the line must be determined with great judgment.

In the matter of economy in the line, high voltage is desirable — first, last, and always. In systems where the voltage undergoes no transformation, its magnitude is somewhat arbitrarily fixed by the practicable voltage which can be employed in the various translating devices, motors, lamps, and the like. For example, in a system at constant potential wherein incandescent lamps are an important item, 125 volts, or 250 volts as an extreme figure, would be the highest pressure advisable for the receiving system in the present state of the art; or in certain cases where cheap power can be had, these voltages might be doubled, and 220 to 250 volt lamps used on a three-wire system. For a direct-current-motor system the corresponding figure would be 500 to 600 volts or 1,000 to 1,200 worked three-wire. Similar limitations indicated elsewhere will hold for other classes of apparatus.

When there is a transformation of voltage in the system, whether direct or alternating current, so that the line voltage is not fixed by that of the translating devices, it is advisable to raise the voltage of transmission as high as the existing state of the art permits. It must be borne in mind, however, that this general rule is subject to modification by circumstances. It would be bad economy, for instance, to use very high pressures and costly insulation for a transmission of moderate length and trifling magnitude. Such practice would result in sending perhaps 100 KW over a line or through a conduit which could as easily serve for ten times the power without great additional cost for copper. It is well, however, not to stop at half-way measures, but, if transforming devices are to be used at all, to go boldly to the highest voltage which experience has shown to be safe on the line, or in the generators, if only reducing transformers are used.

For example, in most cases of alternating current work, 1,000 volts is entirely obsolete; if the line voltage has to be reduced at all, it is better to get the advantage of 2,000 to 12,000 volts on the line; if raising and reducing transformers are employed, the latter figure might as well be increased to 20,000 or 40,000, unless climatic or other special conditions are unfavorable.

It will be seen that, quite aside from engineering details,

CIVIL ENGINEERING
U. of C.

divers really commercial factors must enter into any final decision regarding the voltage to be used. And these commercial factors are the final arbiters as to the working voltage, and even more completely as to the proportion of energy which it is desirable to lose in the line. Power transmission systems are installed to earn money, not to establish engineering theses.

It is evident, to start with, that whatever the voltage, high efficiency of the line and low first cost are in a measure mutually exclusive. The former means large conductors, the latter small ones; the former delivers a large percentage of salable energy, with a high charge for interest on line investment; the latter a smaller amount of energy, with a lessened interest account against it. At first sight it would seem easy to establish a relation between the cost of energy lost on the line and the investment in copper which would be required to save it, so that one could comfortably figure out the conditions of maximum economy.

In 1881, Lord Kelvin, then Sir William Thomson, attacked the problem and propounded a law, known often by his name, which put the general principles of the matter in a very clear light, but which indirectly has been responsible for not a little downright bad engineering.

He stated, in effect, that the most economical area of conductor will be that for which the annual interest charge equals the annual cost of energy lost in it.

While it is true that for a given current and line, Kelvin's law correctly indicates the condition of minimum cost in transmitting said current, this law has often caused trouble when misapplied to concrete cases of power transmission, in that it omits many of the practical considerations. It involves neither the absolute value of the working voltage nor the distance of transmission, and for long transmissions at moderate voltage often gives absurd values for the energy lost. Indeed, as it deals directly only with the most economical condition for *transmitting* energy, it quite neglects the amount of energy delivered. In fact, one may apply Kelvin's law rigidly to a concrete and not impossible case, and find that no energy to speak of will be obtained at the end of the line.

In other words, Kelvin's law, while a beautifully correct solution of a particular problem, is in its original form totally inapplicable to most power transmission work.

Various investigators, notably Forbes, Kapp, and Perrine, have made careful and praiseworthy attempts so to modify Kelvin's law as to take account of all the facts; indeed, nearly every writer on power transmission has had a shy at the problem.

Perhaps the commonest attempt at improvement is to follow the general line of the original law, but to equate the interest charge on copper to the annual *value* of the power lost; in other words, to proportion the line by increasing the copper until the annual net value of a horse-power saved in the line would be balanced by the interest charge on the copper required to save it. This proposition sounds specious enough at first hearing. Practically, it produces a line of greater first cost than is usually justified. It is evident that the possession of a little extra power thus saved brings no profit unless it can be sold, and in few cases is a plant worked close enough to its maximum capacity during the earlier years of its existence to render a trifling increase in output of any commercial value, especially in the case of transmission from water-power. When the plant is worked at a very high cost for power, or soon reaches its full capacity, a few horse-power saved in the line will be valuable; but far oftener, particularly in water-power plants, it would be cheaper to let the additional copper wait until the necessity for it actually arises. Furthermore, it evidently does not pay to so increase the line investment that the last increment of efficiency will bring no profit.

As an example, let us suppose the case of a 1,000 HP transmission so constituted that the line copper costs \$10,000 with 10 per cent loss of energy in the line, and suppose in addition that the net value of 1 HP at the receiving end is \$50 per annum. It is evident that by decreasing the loss in the line to $2\frac{1}{2}$ per cent there would be available 75 additional HP worth \$3,750 per annum. The cost of this addition to the line would be \$30,000, on which interest at 6 per cent would be \$1,800. So long as the plant is not worked up to 90 per cent of its maximum capacity of 1,000 HP, there will be a

steady charge of \$1,800 plus depreciation, if the additional copper be installed at the start. A few months' loss at this rate would more than cover the labor of reinforcing the line when needed, even supposing that installing the additional copper at the start would not have involved extra labor in construction.

Various formulæ for designing the line so as to secure the minimum cost of transmission have been published, derived more or less directly from Kelvin's law, and attempting to take into account all the various factors involved in line efficiency. They all contain quantities of very uncertain value, and hence are likely to give correspondingly inexact results. More than this, they are founded on two serious misconceptions.

First, they generally give the minimum cost of transmission, which is not at all the same thing as the maximum earning power on the total investment. Second, however fully they take account of existing conditions, the data on which they are founded refer to a particular epoch, and are very unreliable guides in designing a permanent plant.

A few years or even months, may and often do so change the conditions as to lead to a totally different result. In the vast majority of cases it is impossible to predict with any accuracy the average load on a proposed plant, the average price to be obtained for power, or the average efficiency of the translating devices which will be used. So probable and natural a thing as competition from any cause, or adverse legislation, will totally change the conditions of economy.

For these reasons neither Kelvin's law nor any modification thereof, is a safe general guide in determining the proper allowance for loss of energy in the line. Only in some specific cases is such a law conveniently applicable. Each plant has to be considered on its merits, and very various conditions are likely to determine the line loss in different cases. The commonest cases which arise are as follows, arranged in order of their frequency as occurring in American practice. Each case requires a somewhat different treatment in the matter of line loss, and the whole classification is the result not of *a priori* reasoning, but of the study of a very large number of concrete cases, embracing a wide range of circumstances and covering

a large proportion of all the power transmission work that has been accomplished or proposed in this country.

CASE I. General distribution of power and light from water-power. This includes something like two-thirds of all the power transmission enterprises. The cases which have been investigated by the author have ranged from 100 to 20,000 HP, to be transmitted all the way from one to one hundred and fifty miles. The market for power and light is usually uncertain, the proportion of power to light unknown within wide limits, and the total amount required only to be determined by future conditions. The average load defies even approximate estimation, and as a rule even when the general character of the market is most carefully investigated little certainty is gained.

For one without the gift of prophecy the attempt to figure the line for such a transmission by following any canonical rules for maximum economy is merely the wildest sort of guesswork. The safest process is as follows: Assume an amount of power to be transmitted which can certainly be disposed of. Figure the line for an assumed loss of energy at full load small enough to insure good and easy regulation, which determines the quality of the service, and hence, in large measure, its growth. Arrange both power station and line with reference to subsequent increase if needed. The exact line loss assumed is more a result of trained judgment than of formal calculation. It will be in general between 5 and 15 per cent, for which losses generators can be conveniently regulated. If raising and reducing transformers are used the losses of energy in them should be included in the estimate for total loss in the line. In this case the loss in the line proper should seldom exceed 10 per cent. A loss of less than 5 per cent is seldom advisable.

It should not be forgotten that in an alternating circuit two small conductors are generally better than one large one, so that the labor of installation often will not be increased by waiting for developments before adding to the line. It frequently happens, too, that it is very necessary to keep down the first cost of installation, to lessen the financial burden during the early stages of a plant's development.

CASE II. Delivery of a known amount of power from ample

water-power. This condition frequently arises in connection with manufacturing establishments. A water-power is bought or leased *in toto*, and the problem consists of transmitting sufficient power for the comparatively fixed needs of the works. The total amount is generally not large, seldom more than a few hundred horse-power. Under these circumstances the plant should be designed for minimum first cost, and any loss in the line is permissible that does not lower the efficiency enough to force the use of larger sizes of dynamos and water-wheels. These sizes almost invariably are near enough together to involve no trouble in regulation if the line be thus designed. The operating expense becomes practically a fixed charge, so that the first cost only need be considered.

Such plants are increasingly common. A brief trial calculation will show at once the conditions of economy and the way to meet them.

CASE III. Delivery of a known power from a closely limited source. This case resembles the last, except that there is a definite limit set for the losses in the system. Instead, then, of fixing a loss in the line based on regulation and first cost alone, the first necessity is to deliver the required power. This may call for a line more expensive than would be indicated by any of the formulæ for maximum economy, since it is far more important to avoid a supplementary steam plant entirely than to escape a considerable increase in cost of line. The data to be seriously considered are the cost of maintaining such a supplementary plant properly capitalized, and the price of the additional copper that render it unnecessary. Maximum efficiency is here the governing factor. In cases where the motive power is rented or derived from steam, formulæ like Kelvin's may sometimes be convenient. Losses in the line will often be as low as 5 per cent, sometimes only 2 or 3.

CASE IV. Distribution of power in known amount and units, with or without long-distance transmission, with motive-power which, like steam or rented water-power, costs a certain amount per horse-power. Here the desideratum is minimum cost per HP, and design for this purpose may be carried out with fair accuracy. Small line loss is generally desirable unless the system is complicated by a long transmission.

Such problems usually or often appear as distributions only. Where electric motors are in competition with distribution by shafting, rope transmission, and the like, 2 to 5 per cent line loss may advantageously be used in a trial computation.

The problem of power transmission may arise in still other forms than those just mentioned. Those are, however, the commonest types, and are instanced to show how completely the point of view has to change when designing plants under various circumstances. The controlling element may be minimum first cost, maximum efficiency, minimum cost of transmission, or combinations of any one of these, with locally fixed requirements as to one or more of the others, or as to special conditions quite apart from any of them.

In very many cases it is absolutely necessary to keep down the initial cost, even at a considerable sacrifice in other respects. Or economy in a certain direction must be sought, even at a considerable expense in some other direction. For these reasons no rigid system can be followed, and there is constant necessity for individual skill and judgment. It is no uncommon thing to find two plants for transmitting equal powers over the same distance under very similar conditions, which must, however, be installed on totally different plans in order to best meet the requirements.

As regards the general character of transmission lines the most usual arrangement is to employ bare copper wire supported on wooden or iron poles by suitable insulators. Now and then underground construction becomes necessary owing to special conditions. Not infrequently an aerial transmission line must be coupled with underground distribution, owing to municipal regulations. Occasionally insulated line wire is used. It is frequently employed in cases where the transmission lines are continued for purposes of distribution through the streets of a town, in fact, is usually required. As such lines are generally of moderate voltage, very seldom exceeding 3,000 volts, good standard insulation may often be effective in lessening the danger to life in case of accidental contacts, and in reducing the trouble from crossing of the lines with other lines, branches of trees, and the like. In case of really high voltages, 10,000 and upward, no practicable insulation

can be trusted for the former purpose, and may in fact create a false sense of security, while it is far better practice to endeavor to avert the danger of short circuits than to take extraordinary precautions to mitigate their momentary severity. Hence bare copper is to be preferred both on the score of safety and of economy. Now and then at some particular point a high grade of insulation may minimize local difficulties.

Much can be said in favor of placing a transmission line underground, but there are also very strong reasons against it. Such a line is eminently safe, and free from danger of accidental injury. At the same time it is very difficult to insulate properly, and if trouble does arise it is exceedingly hard to locate and difficult to remedy. In addition, there are serious electrical difficulties to be encountered, which often can be reduced only by very costly construction. The chief objection aside from these is the expense, which in very many cases would be simply prohibitive.

In cities there is an increasing tendency on the part of the authorities to demand underground construction. Overhead wires are objectionable on account of their appearance, danger to persons and property, and their great inconvenience in cases of fire, and these objections apply with almost equal total force to all such wires, whether used for electric light or power, or for telegraphic and telephonic purposes, the latter more than making up by their number for any intrinsic advantage in the matter of safety. The future city will have its electric service completely underground, at least in the more densely inhabited portions. It must be said, however, that it is far more important for a city to have electric light and power than to insist on having it in a particular way, and unless the service is very dense, so as to abundantly justify the very great added cost of underground work, private capital will hesitate to embark in an enterprise so financially overloaded.

Fortunately, for city distribution moderate voltages must be employed on account of the intrinsic limits of direct current circuits employed for general distribution, and the undesirability of distributing transformers of moderate size on very high pressure alternating circuits. More than 2,000 to 2,500

volts, save on arc circuits, can seldom be used advantageously in general distribution, and such voltages can be and are successfully insulated without prohibitive expense. They work well in practice, and have stood the test of considerable experience. Moreover, with proper care the cables employed as conductors, when thoroughly protected and inspected, probably have a slightly less rate of depreciation than overhead insulated lines, and are much less liable to interruption. As the district within which underground service is necessary is usually of no great extent, the electrical difficulties that are to be dreaded in attempting long underground transmissions are not here of so serious magnitude.

For this limited service, then, in districts where both population and service are dense, there is no serious objection to underground lines, and many who have used them are decided in commending them as on the whole more convenient and reliable than aerial lines. Besides, a large proportion of underground work is done at low voltages, less than 250 volts, with which the difficulties of insulation except at joints are really trivial. Such work does not belong so much to power transmission proper as to distribution from centres after the transmission is accomplished.

With high voltages and long distances the case is very different. Not only are the difficulties of insulation great, but electrical troubles are introduced of so severe a character as to make success very problematical, even in cases where the cost alone is not prohibitive. The feat of cable insulation for pressures as great as 25,000 volts has been accomplished, and this limit could probably be exceeded, but the cost of such work is necessarily extremely high, and the location and repair of faults is troublesome. An overhead line is so much easier to insulate and to maintain that nearly all power transmission will probably continue to be carried on by this method for some time to come, until, indeed, there are revolutionary changes in underground work of which we now have no suggestion. The possibility of a long interruption of service while a fault is found and repaired is too unpleasant a contingency to be incurred. Duplicate lines are a natural recourse in such case, effective, but very costly. Aerial lines are much cheaper to

duplicate, and the labor of finding and repairing faults is comparatively light. Finally, when it comes to the question of really high voltages like those now coming into frequent use, say 40,000 volts to 60,000 volts, it must be admitted that in the present state of the art of insulation underground cables, if possible at all, are absolutely prohibitive in cost.

For these reasons underground transmission lines should be avoided, certainly until we have had a long experience with high voltages overhead.

Throughout the foregoing it has been assumed that the conducting line is composed of the best quality of commercial copper wire. Inasmuch as other materials are occasionally proposed, it is worth while saying something about the relative properties of certain metals and alloys as conductors. Aside from silver, pure copper is intrinsically the best conductor among the metals. In fact, it is hard to say that it is not the equal of silver. Commercial copper wire is of somewhat variable conductivity, since this property is profoundly affected by very small proportions of certain other substances. An admixture, for instance of one-tenth of one per cent of iron reduces the conductivity by about 17 per cent. It used to be a most difficult matter to procure commercial wire of good quality, and in the early days of telegraphy much annoyance was experienced on this score. At present the best grades of standard copper wire have a conductivity of fully 98 per cent that of chemically pure metal, and even this figure is not

Material.	Conductivity.	Strength, Lbs.
Commercial copper wire.....	98-99	35,000
Good hard-drawn copper.....	97-98	60,000-65,000
(1) Silicon bronze.....	97	63,200
Magnesium bronze.....	95	73,000
(2) Silicon bronze.....	80	76,000
Aluminium.....	59-60	32,900
(3) Silicon bronze.....	45	110,000
Phosphor bronze.....	26	101,000
Iron annealed wire.....	14	55,000
High carbon steel wire.....	10-12	120,000-130,000

infrequently exceeded. On account of the comparatively low tensile strength of copper, ordinarily about 35,000 lbs. per

square inch, very vigorous efforts have been made to exploit various alloys of copper on the theory that their greater strength would more than overbalance the lessened conductivity and increased cost, by enabling less frequent supports to be employed. Aluminium bronze, silicon bronze, and phosphor bronze have been tried, together with some other alloys of a similar character exploited under various trade names. The whole matter of high conductivity bronzes has been so saturated with humbug that it is very hard indeed to get at the facts in the case. Most of them are tin bronzes carrying less than 1 per cent of tin, of which even one-tenth per cent will raise the tensile strength by more than 40 per cent, lowering the conductivity, however, more than hard drawing to the same tensile strength. Copper which is hard-drawn probably has greater tensile strength than any so-called bronze of similar conductivity, from 60,000 to 65,000 lbs. per square inch, with an elastic limit of about 40,000 lbs. per square inch and a resistance less than 3 per cent in excess of that of ordinary copper. The foregoing table gives the conductivities and tensile strengths of some of the various materials used or proposed for line wire, pure copper being taken as the standard at 100 per cent conductivity.

It is sufficiently evident from this table that where the best combination of strength and conductivity is wanted, hard-drawn copper is unexcelled. For all ordinary line work good annealed copper wire is amply strong, and is, besides, easier to manipulate than wire of greater hardness. Occasionally, where it is desirable to use extra long spans, or excessive wind pressure is to be encountered, the hard-drawn wire is preferable. Not uncommonly a medium hard-drawn copper is used having a tensile strength of about 50,000 lbs. per square inch and a conductivity of about 98 per cent. Now and then, in crossing rivers or ravines, spans of great length are desirable — several hundred yards — and in these cases one may advantageously employ silicon or other bronze of great tensile strength, or as an alternative, a bearer wire, preferably a steel wire cable, carrying the copper conducting wire or itself serving as the conductor. Where mechanical strains are frequent and severe, bronzes are somewhat more

reliable than hard-drawn copper of equal tensile strength, since they are homogeneous, while the hard-drawn copper owes its increase in tenacity to a hard exterior shell, the core of it being substantially like ordinary copper. If the properties of this skin may be judged by its proportion of the total area of the wire, the tensile strength must rise to nearly 150,000 lbs. per square inch, with a conductivity lowered 10 to 15 per cent.

Compound wires have now and then been used, consisting of a steel core with a copper covering, but these are costly and no better than hard-drawn copper for line use. Iron alone replaces copper to any extent. It is cheaper for equal conductivity, but in wire is far less durable, and in rods cannot be strung overhead conveniently, while, even were this possible, the difficulty of making and maintaining joints is most serious. Very recently aluminium has been successfully used as a line conductor. At present prices (1905) it is materially cheaper than copper for equal conductivity, but its bulk and the difficulty of making joints are sometimes objectionable. Aluminium has about six-tenths the conductivity of copper, the resistance of one *mil-foot* of pure aluminium wire being 17.6 ohms at 25° C. Owing to its very low specific gravity its conductivity is very high when compared on the basis of weight. It has very nearly one-half the weight of copper for the same conductivity, to be exact 47 per cent, so that as a conductor aluminium wire at 30 cents per pound is a little cheaper than copper wire at 15 cents per pound. The tensile strength of the aluminium is slightly less than that of copper, being a little less than 33,000 lbs. per square inch as a maximum, and in commercial wire usually between 25,000 and 30,000, while soft-drawn copper is about 34,000 lbs. Like soft copper, the aluminium wire takes permanent set very easily, having a very low elastic limit, about 14,000 lbs. per square inch, so that at about half its ultimate strength it is apt to stretch seriously. Comparing wires of equal conductivity the aluminium has absolutely greater strength, since its cross section is about 1.64 times that of the corresponding copper wire. If, however, the copper be hard drawn, the aluminium wire of the same conductivity has only about 60

per cent of the strength, but having only half the weight of the copper, still retains a slight advantage in relation of weight to strength.

Being somewhat larger, the aluminium wire has a trifle greater inductance and capacity than the copper and is more exposed to the effect of storms. It has about 1.4 times the linear coefficient of expansion of copper, so that there is more tendency to sag in hot weather and to draw dangerously taut in cold weather. This property has caused some practical trouble in aluminium lines, and has to be met by great attention to temperature and uniform tension in stringing the wire. In practical line construction, aluminium is always now used in the form of cables laid up of wire, generally No. 8 to No. 12. Such cables show somewhat more tensile strength than solid wires of similar area and are very much more reliable. They have come to be rather widely used and have given excellent results.

Joints in aluminium wire are, as already indicated, a very serious problem. In contact with other metals aluminium is attacked electrolytically by almost everything, even zinc. A successful soldered joint for aluminium has not yet been produced, and in line construction recourse has to be taken to mechanical joints. One of the most successful of these is that used in several California lines. It consists of an oval aluminium sleeve, large enough to slip in the two wire ends side by side, and for No. 1 wires about 9 inches long. In making the joint the ends of the wires were filed rough, the wires were slipped side by side through the sleeve, and then by a special tool, sleeve and wires were twisted through two or three complete turns. The result was a joint practically as strong as the original wire, and electrically good. There is considerable danger of electrolytic corrosion in any such mechanical joint, and lines exposed to salt fogs would probably suffer rather severely in this way, but with care in making, and regular inspection, these joints serve the purpose well. Very recently a process of cold welding a sleeve joint under great pressure has given excellent results.

Altogether it seems clear that aluminium is a most useful substitute for copper for transmission lines, and it will cer-

tainly be used extensively whenever copper rises to a price above 15 to 16 cents per pound for bare wire. Not only is the aluminum cheaper in first cost, but its lesser weight means a great decrease in cost of freights as well. It certainly makes an excellent line when carefully put up, and there is no good reason why it should not be freely used whenever the price of copper throws the balance of economy in favor of aluminium. There have been attempts to improve the strength of aluminium wire by alloying it, but as in the case of bronzes the gain in strength is at the expense of conductivity. Such alloy wire should be very cautiously investigated before use.

Before taking up the practical task of line calculation it is necessary to consider somewhat at length the electrical difficulties that must be encountered, and which impose limitations on our practically achieving many things that in themselves are desirable and useful. We have seen already that the secret of long distance transmission lies in the successful employment of very high voltages, and whatever the character of the current employed, the difficulties of insulation constantly confront us. These are of various sorts, for the most part, however, those that have to do with supporting the conducting line so that there may not be a serious loss of current via the earth. Next in practical importance come those involved in insulating the conductor as a whole against, first, direct earth connections or short circuits in underground service, and second, grounds or short circuits, if the line is an aerial one.

In a very large number of cases no attempt is made to insulate the wire itself by a continuous covering, and reliance is placed entirely on well-insulated supports. In most high voltage lines this is the method employed, partly for economy but chiefly because there is well-grounded distrust in the durability of any practicable continuous covering under varying climatic conditions and the constant strain imposed by high voltage currents.

So far as supports go, it is evident that while the individual resistance of any particular one may be very great, the total resistance of all those throughout the extent of a long line to which they are connected in parallel to the earth, may be low enough to entail a very considerable total loss of energy. The

possibility of such loss increases directly with the number of supports throughout the line. The most obvious way of reducing such losses would be to considerably increase the distance between supports as in some recent constructions. This process evidently cannot go on indefinitely, from mechanical considerations, and hence the greatest advance can be made in reducing the chance of loss in individual supports.

Most of the present practice consists merely of an extension of the methods that were devised for telegraphic work. These were quite sufficient for the purpose intended, but are inadequate when applied to modern high voltage work.

The ordinary line consists, then, of poles, bearing on pins of wood or metal secured to cross arms, bell-shaped glass or porcelain insulators. To grooves on or near the top of these the line wire is secured by binding wire. Loss of current to earth in a line so constituted takes place in two ways. First, the current may pass over the outer surface of the insulator, up over the interior surface, thence to the supporting pin and so to earth. Second, it may actually puncture the substance of the insulator and pass directly to the supporting structure.

The first source of trouble is the commoner, and depends on the nature and extent of the insulating surface, and even more on climatic conditions. The second depends on the thickness and quality of the insulating wall which separates the wire from the pin. To avoid leakage an insulator should be so designed that the extent of surface shall be as long and narrow as practicable; also, this surface must be both initially and continuously highly insulating. The first condition is met by making an insulator of comparatively small diameter, and adding to the length of the path over which leakage must take place by placing within the outer bell of the insulator one or more similar bells (usually called petticoats). These not only help in the way mentioned, but they are likely to stay tolerably dry even when the exterior surface is wet, and thus help to maintain the insulation.

A good glass or porcelain insulator made on these general lines gives excellent results with ordinarily moderate voltages, say up to 5,000 volts. When the insulators are new and clean they will quite prevent perceptible leakage, and for the vol-

tages mentioned are satisfactory under all ordinary conditions. When higher voltages are employed the results may be at first good, but they are unlikely to stay so unless the climatic conditions are exceptionally favorable. Most glass permits a certain amount of surface leakage, even when new, although generally not enough to be of practical importance, but even the best commercial glass weathers when exposed to the elements, so that in time the surface becomes slightly roughened and retains a film of dirt and moisture that is a very tolerable conductor. Even while perfectly free from this deterioration at first, it is generally hygroscopic, because it is in a trifling degree soluble even in rain water, and tends to retain a slight amount of moisture. Thus in damp climates glass is likely to give trouble when used on a high voltage line. As regards temporary fall in insulating properties, a searching fog or drizzling rain is much worse in its effects on insulators than a sharp shower or even a heavy rain, which tends to wash the outer surface free of dirt, and affects the comparatively clean interior but little.

Much cheap porcelain is also hygroscopic owing to the poor quality of the glaze, and it has the considerable added disadvantage of depending on this glaze for much of its insulating value.* Glass is homogeneous throughout its thickness, while porcelain inside the glaze is often porous and practically without insulating value. Nevertheless, porcelain which is thoroughly vitrified, the ordinary glaze being replaced by an actual fusing of the surface of the material itself, is decidedly preferable to ordinary glass, being tough and strong, quite non-hygroscopic, and of very high insulating properties. The surface does not weather, and the insulation is well kept up under all sorts of conditions. If the vitrification extends, as it should, considerably below the surface, the insulator will resist not only leakage, but puncture, better than any glass. The process of making this quality of porcelain is somewhat costly, since the baking has to be at an enormous temperature

* Much American porcelain will absorb 1 to 2 per cent of its weight of water, a sign of poor insulating properties. The best porcelain should absorb no water and should show a brilliant vitreous fracture which will take no flowing stain from ink.

UNIVERSITY OF
COLUMBIA

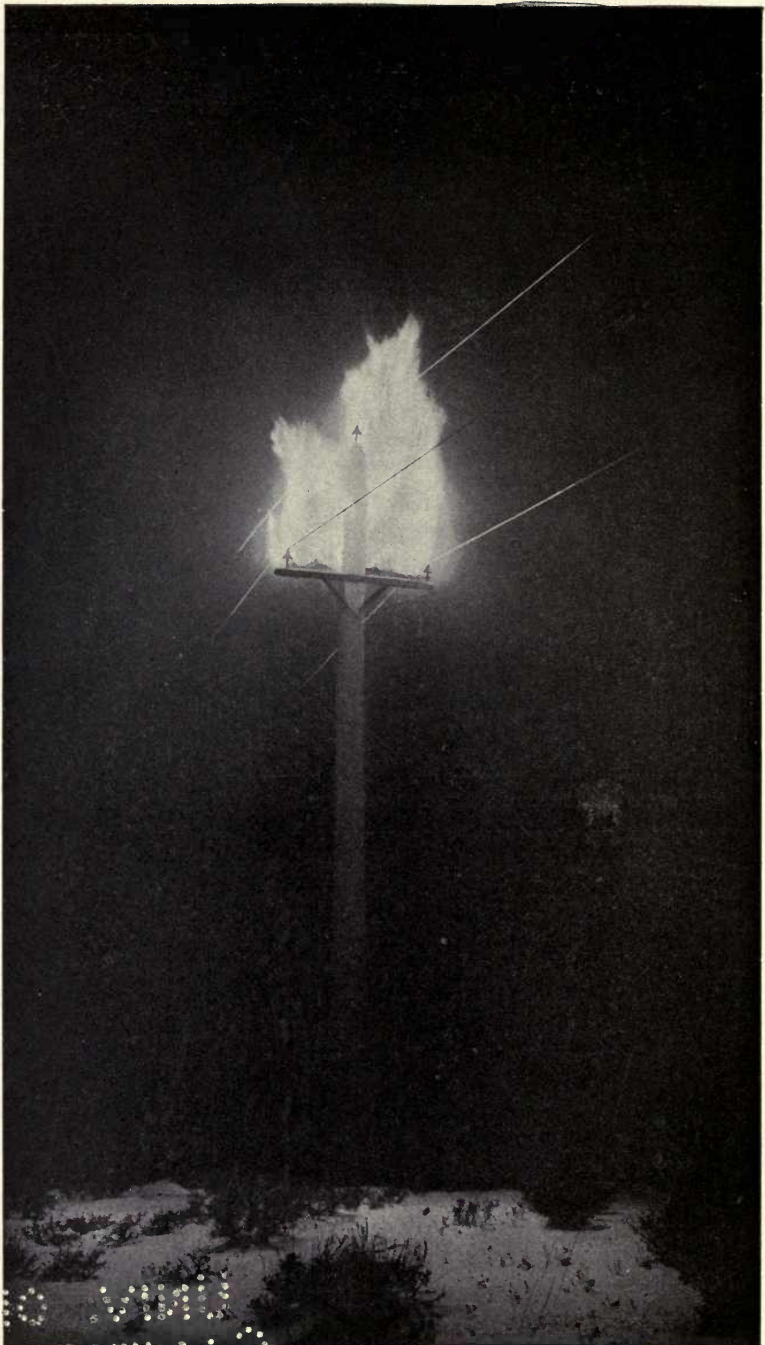

PLATE XX

and long continued, but the result is the most efficient insulating substance in use. Glass, however, is better than ordinary grades of porcelain.

Surface discharge is more to be feared than puncture at all voltages, since the absolute insulation strength of the material can be made high enough, by careful attention to quality and sufficient thickness, to withstand any practical voltage continuously, barring mechanical injury. But leakage is a function of moisture, drifting dust, and things meteorological generally, besides which, it may take place in serious amount at voltages which otherwise would be very easy to work with.

Up to about 20,000 volts the familiar types of insulator of good material and size prove adequate. At higher pressures, however, a different state of affairs is encountered, since the pressures become sufficient to break down the air as a dielectric over distances great enough to be inconvenient.

At about 20,000 volts the lines begin to show a quite perceptible luminous coating of faint blue at night, little brushes spring from the tie wires and sometimes stream from the insulators, and as the pressure rises still further these phenomena become more and more marked. The appearance is quite similar to that presented by the high tension leads from a large induction coil in a darkened room.

At 50,000 volts or so the effect is somewhat menacing, and unless the lines are well separated there may be considerable loss of energy, and it is possible for arcs to strike from wire to wire, producing temporary short circuits of most formidable appearance. Plate XX is from a photograph of this phenomenon, taken on the lines of the Provo transmission where they run through the old basin of the Great Salt Lake. A heavy wind will raise clouds of saline dust which is very trying to the insulation of the pole tops, and it was during such a "salt-storm" that the picture was taken. Since the wires were some six feet between centres, the arc must have flamed ten feet high, having been coaxed into action by brush discharges over the saline coating of the cross arms. The conditions were of course unusual, but at voltages exceeding 20,000 or 25,000 volts the failure of the air as a dielectric introduces an element of difficulty which must be reckoned

with in trying to maintain the insulation of the lines. As a preliminary to the design of high voltage lines, therefore, it is necessary to know approximately the dielectric strength of air under practical conditions. This is practically measured by the striking distance over which various voltages will leap in ordinarily dry air, between sharp points. The strik-

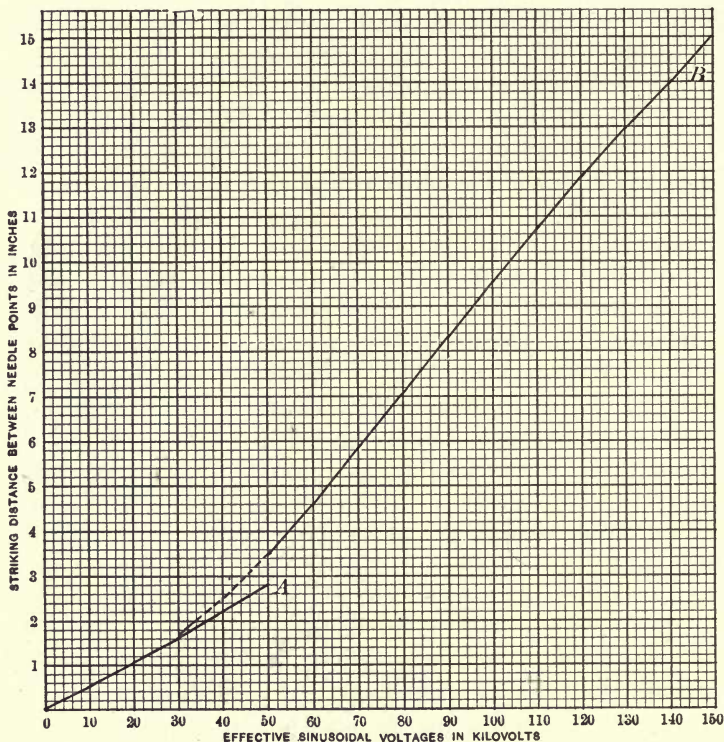

FIG. 253.

ing distances thus taken are greater than between rounded surfaces but since the presence of sharp edges and burrs upon the line wires or tie wires must be taken into account the point distances form a safer guide.

Fig. 253 shows graphically the relation between effective voltage and striking distance, the points used being sharp sewing needles. Curve A is from the recent experiments of

Fisher*, which were particularly directed to the measurement of high voltages by their striking distance, while curve *B* is from the researches of Steinmetz. Below 30,000 volts the two are in sufficiently close agreement, but above this point large divergences appear in these, and in fact all other experiments, not too large, however, to make these curves a valuable guide for general purposes.

In wet air, or at high elevations, and at high temperatures to a lesser degree, the striking distances are increased considerably. Experiments on insulators tested wet by a spray and also dry, show that under practical conditions the increase due to moisture may be twenty-five or thirty per cent.

There is, however, sufficient loss of energy and liability to trouble on high tension lines to make necessary a considerable factor of safety in the aërial insulation strength. The brushes and the hissing sound at the insulators at very high pressures speak heavy static discharges and impending trouble, even when the air insulation is very thick. In a closed space these discharges would quickly so ionize the air as to cause discharges, but in the open there is much less danger of this occurrence.

In ordinary practice the diameter of the line wire produces very little effect upon the matter of a break down of the air although under test conditions in a confined space the size is a very important factor. The reason for this discrepancy is very simple — in actual lines the weakest point as regards breaking down is at the insulators, and the transmission wires on lines long enough to require very high voltage are usually for commercial reasons $\frac{1}{4}$ inch or more in diameter, and never over $\frac{1}{2}$ inch except in the case of cables built up of smaller wires.

In other words the practical variation in the radius of the wires used is not great, and if they can be made safe at the poles there will be little chance of trouble elsewhere.

The general leakage of a line is the summation of the brush leakages at every point. So far as the line wires are concerned they are customarily kept far enough apart to avoid direct leakage in any amount. The effect of increasing the distance

* Trans. Int. Elec. Cong. St. Louis, II, 294.

and also the magnitude of the practical energy losses is well shown in Fig. 254, which gives the result of tests by Mr. Mershon on one of the early lines at Telluride, Colo., 2.25

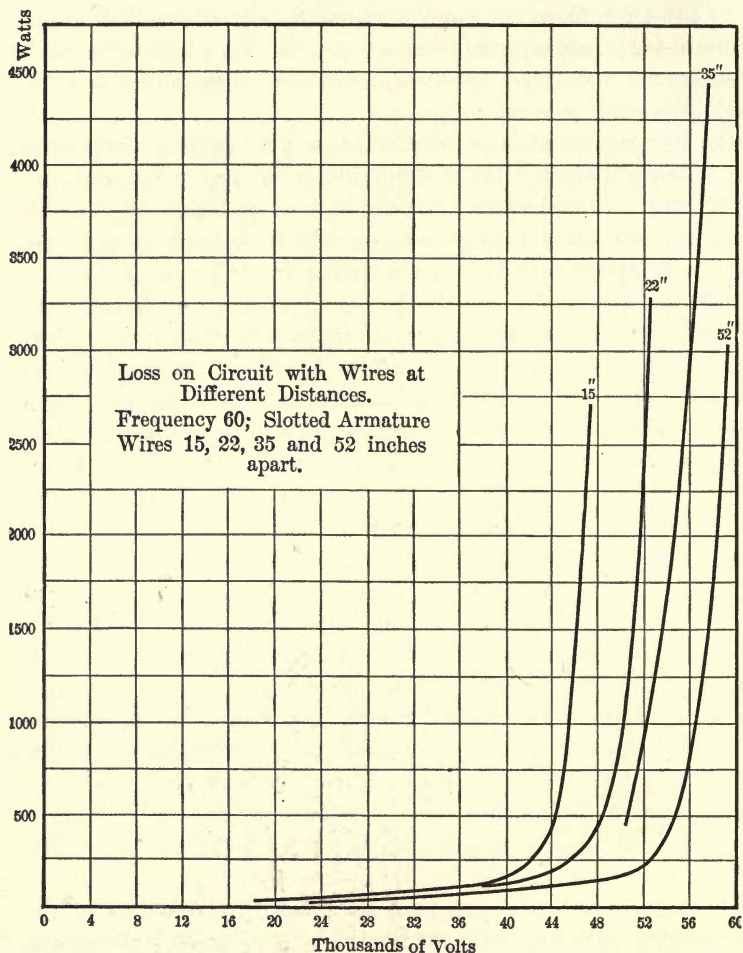

FIG. 254.

miles long. The conspicuous thing is, that after the energy loss exceeds say 100 watts per mile, the breaking down of the insulation resistance is very rapid indeed. The breaking down point is determined by the height of the peak of the

voltage wave, so that in further experiments at Telluride it was found that sinusoidal voltages showed less tendency to break down the line than indicated in these curves.

If the pole tops are kept safe from flashing across, the free wires will take care of themselves and the weakest point in the line insulation is at the insulators themselves, granting as we may, that one can get glass or porcelain to resist puncture at pressures far above the highest now practically used. It should be added that Mershon's tests were on No. 6 wire and with air somewhat rarified by the elevation, the barometer reading in the neighborhood of 20 inches. It has been shown by Ryan* that the barometric height and the temperature greatly influence the point at which the air gives way and a coronal discharge sets in. From a considerable series of tests Ryan has deduced the following formula for the voltage E required to start a coronal discharge between two wires of radius r in inches, spaced s inches, when the barometer reads b inches and the temperature is t° F.

$$E = \frac{17.94 b}{459 + t} \times 350,000 \log_{10} \left(\frac{s}{r} \right) (r + .07).$$

This agrees fairly with experimental results on lines and applies to wires from No. 4 B & S up. For smaller wires Ryan found values of E much lower than the formula indicates, possibly for reasons connected with his method of experimentation, but the cause of the aberrancies is of small practical importance since wires smaller than No. 4 are very rarely used in transmission work. E it must be remembered is not the rated voltage but the peak of the voltage wave, and for sinusoidal waves must be divided by $\sqrt{2}$ to reduce it to rated voltage.

Moisture seems to produce small effect on the critical voltage which corresponds with the sharp upward turn in the curves of Fig. 254, and the main thing practically is to space the lines sufficiently to give a liberal factor of safety between E and the working voltage. It would hardly be wise to allow a value of E less than double the working pressure,

*Trans. A. I. E. E., Feb. 26, 1904.

but even so it would certainly be safe so far as coronal discharge is concerned to work wires of ordinary size up to 100,000 volts when spaced six feet or so. Stranded cable should give slightly lower values for E than solid wire of similar size, but whether materially lower is dubious, and so far as practical values of s are concerned, the main problem is to resist flashing over the insulator surface in one way or another to the cross arm.

As a matter of fact it is found that when such discharges take place they do not follow the insulator surfaces, but jump

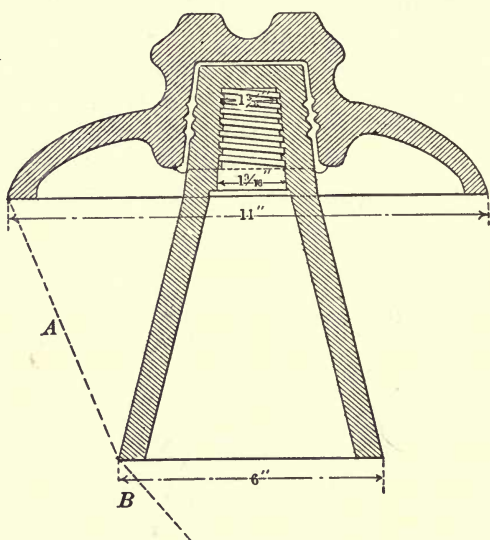

FIG. 255.

the spaces from petticoat to petticoat. For instance in Fig. 255 which shows in section a glass insulator designed for use at 40,000 volts, the air space which serves as a defence against break down is the distance A from upper to lower petticoat, plus a small distance B to the pin. Insulators fail by this direct discharge and not by a creeping discharge along the surface. High voltage insulators do not much tend to accumulate moisture which is either repelled or dried off pretty effectively, and in a rather open construction which favors keeping the surfaces free from dirt and moisture, the upper surfaces of

petticoats must be regarded in damp weather at least as fairly conducting, leaving the sparking distances as shown.

In Fig. 255 the sparking distance neglecting *B* is about 6.5 inches, so that turning to Fig. 253 it appears that if there is a difference of 40,000 volts from wire to ground, the given insulator has a factor of safety of about 2.5.

Now considering the fact that in wet weather all pole tops may be regarded as giving fair surface conduction, it is clear that the working air insulation between two wires of a circuit carried on insulators like Fig. 255, has an aggregate thickness of only 13 inches or so, and that this and not the spacing of the wires is the real limitation upon the voltage. The insulators are always the weakest points of the line both as regards general insulation, and danger of arcing. Without going into details of insulator construction which will be taken up in the next chapter, it may be said that insulators of first-class material and of dimensions that should give a factor of safety of not less than 2.5 on a working voltage of 60,000 are now commercially obtainable.

This factor of safety is none too large, and when one considers that very high voltage renders a line particularly liable to interruption from accidents which at moderate voltages would be trivial, it is a wonder that transmission lines perform as well as they do.

As to voltages for such lines great progress has been made. 10,000 to 15,000 volts is a conservative pressure now used only for short distances. A common rough and ready rule for voltage is a thousand volts per mile or as near it as you dare on the longer distances. The present tendency is to use not less than 20,000 to 30,000 volts for all serious transmission projects. Such pressures have now been in regular service with excellent results for half a dozen years past, and that in many cases. It may be fairly said that they may be regarded as not only completely reliable, but rather conservative. They are in operation in all parts of the country, under all sorts of climatic conditions, without experiencing any difficulties which would not be equally in evidence at half the voltage.

In other words, a line can be built and operated at 20,000

to 30,000 volts, without trespassing on entirely safe values of the factors of safety in the various parts.

From 30,000 to 45,000 volts there are now in operation more than a score of plants and the reports from them are uniformly rather favorable. There is no doubt that certain classes of line troubles become more prominent, especially in reaching the neighborhood of 40,000 volts and above. The root of these troubles is the relatively low factor of safety at the insulating supports. All may go well under normal conditions but there is always danger that deterioration or abnormal pressures arising from one cause or another may break down the air gap. If insulators are worked at a voltage which is near the sparking distance voltage, dirt, and moisture particularly from sea fogs, may so much reduce the surface resistance as to lead a discharge over and start an arc. It sometimes happens that insulators individually tested with a good factor of safety will later break down without any adequate electrical cause, probably from the starting of cracks from mechanical strain. Pins may break or bend thus letting the wire down upon or near the cross arm, and many minor faults not conspicuous at 25,000 volts may become serious as the voltage nears that at which current will jump the insulators.

Nevertheless, a good many plants have been working at these high pressures with relatively small trouble. Now and then temporary shut downs occur, as upon plants at lower voltage, but on the whole accidents are few and even these are seldom fairly chargeable to the unusual voltage.

Transmission plants working at 45,000 to 60,000 volts are few in number, but are generally of considerable magnitude, and have probably been as reliable as those in the class just considered. They have had at times trouble with insulators, but as they have not temporized with the problem, and have used the very best insulators obtainable, they are working upon a factor of safety quite as large as that found in many plants of much lower voltage, and consequently have not experienced unusual difficulties. Certainly several plants are doing good commercial work at voltages of at least 60,000.

Let us now sum up our present knowledge of the transmis-

sion of electrical energy over high voltage lines. From a considerable amount of experience, we are sure that there is no real difficulty whatever in establishing and maintaining adequate insulation up to an effective pressure of 25,000 volts. Above this the plants are less numerous, but it is quite certain that satisfactory results can regularly be reached up to 30,000 without very extraordinary precautions. With good climatic conditions 40,000 or 50,000 may be considered entirely practicable, with reasonable precautions, and 60,000 has now been passed without any signs of impending failure.

At still higher voltages the difficulties are likely to multiply more rapidly, and a point will ultimately be reached at which the cost of insulating devices will overbalance the saving of copper due to increased voltage. This point is at present indeterminate, and will always depend on the amount of power to be transmitted, the permissible loss in the line, and unknown variables involving repairs and depreciation, cost and depreciation of transformers and so on. It is quite impossible from present data to set such a limit even approximately, for we know as yet nothing of the relative difficulty of insulating voltages considerably above the range of our experience.

In cases where continuous insulation is employed, it is for one of two purposes, chiefly to prevent interference with the circuit by such accidents as twigs or wires falling across the line, and either short circuiting the lines or grounding them. Aside from this, the only other object in insulation is to lessen the danger to persons accidentally touching the wires and to prevent the current straying to other circuits.

With moderate voltages both these ends can be reached with a fair degree of success. With high voltages it is very difficult, and in many cases well-nigh impossible.

Nearly all materials which are available for insulation deteriorate to a very marked extent when exposed to the weather. Those substances which are the best insulators, such as porcelain, glass, mica, and the like, cannot be used for continuous insulation, and, in fact, our best insulators are mechanically so bad as to be impracticable. There is a large class of insulators complicated in chemical constitution, but mechanically excellent; these are the plastic or

semi-plastic substances like gutta-percha, India rubber, bitumen, paraffin, and the like. All of these are subject to more or less decomposition, more particularly those which are, through good mechanical qualities, desirable for insulation. All which have been mentioned are sufficiently good insulators to answer every practical requirement, if they do not deteriorate.

Gutta-percha and India rubber are decidedly the best of these; but gutta-percha is too plastic at anything excepting low temperatures to be mechanically good. Gutta-percha fills, however, an unique place on account of its remarkable ability to withstand the action of salt water, and it is the most reliable insulator for submarine work. For overhead work it is nearly useless, as the heat of the sun softens it so as to endanger its continuity, and even a moderate increase in temperature may decrease its specific resistance to a tenth of its ordinary value.

India rubber is, by all odds, the best all around insulator for overhead lines. In its pure state it deteriorates with very great rapidity; but when vulcanized by the addition of a small amount of sulphur, its chemical character is so changed as to resist both spontaneous changes and those due to the atmosphere to a very considerable extent, without injury to its insulating properties. It is, however, costly, and is eventually affected by the weather. To cheapen the manufacture of insulated wire a large variety of rubber compounds are employed, consisting of mixtures of rubber with various other substances intended to give the material good mechanical and insulating qualities at less expense. These rubber compounds are much inferior to pure vulcanized rubber in point of specific resistance, but make a good and substantial covering for ordinary purposes, sometimes more durable than the purer material. They are very generally employed for commercial work.

Insulated wires for overhead work may be divided into two classes. First, those which are so prepared as to withstand the weather to a considerable extent and to retain high insulating properties even in bad weather. Such wires are usually covered with compound fairly rich in vulcanized rubber, commonly protected outside with a braiding of cotton saturated

with some insulating compound, and serving to protect the main insulation from mechanical injury.

The second class of wires includes those in which no solid insulating material is used, but which are thoroughly protected by a covering of fibrous material saturated with compounds of rubber, bitumen, or the like. These wires are most extensively used; the insulation is good in dry weather, and fair under most ordinary circumstances, but generally greatly inferior to those wires which are given a coating of rubber.

So far as protection of the wire from accidental contacts is concerned, either class of insulation is tolerably effective at moderate voltages until the covering becomes worn or weathered by long or hard usage.

As regards danger in touching such wires, at moderate voltages both kinds of insulation afford a fair degree of protection. At high voltages neither can be trusted, in spite of the apparently high insulation resistance. There is good reason to believe that any insulation employed on wires is greatly affected by the strain of high voltage. Tests made with the ordinary Wheatstone bridge give us no useful information as to the action of the same insulation under continued stresses of 5,000 or 10,000 volts. Tests made with pressures ranging up to even 500 volts show generally a noticeable, although very irregular, falling off in resistance, and the higher the voltage is carried the more likelihood of complete breaking down of the insulation and the more irregular the results.

It is improbable that even the most careful insulation with vulcanized rubber of any reasonable thickness would give a wire which, under a pressure of 10,000 volts, could be long depended on to remove all danger to persons from accidental contact. Even if entirely safe at first, it would be unlikely to remain so for any great length of time. A rubber covered lead sheathed cable with the sheath thoroughly grounded is probably the nearest approximation to safety. So serious is the difficulty of continuous insulation of high pressures, that it is best not seriously to attempt it; but either to fall back upon bare wire with very complete insulation at the supports, or, if insulated wire be employed at all, to use an insulator

intended only to lessen the danger of short circuits from falling objects, and always to treat the line, so far as personal contact goes, precisely as though it were bare wire.

Information regarding the insulation of lines, whether of bare or insulated wire, under high voltage, is very scarce; but all such lines should be treated at all times as if they were grounded, in spite of any tests of the insulation that may have been made. Theoretically, one should be able to touch a completely insulated circuit without danger save from static charge; but, practically, it is suicidal so to treat any high voltage circuit.

The writer calls to mind one case in which a man was instantly killed, while standing on a dry concrete floor, by contact with a 10,000 volt circuit. He probably touched a bare portion of the wire, but so far from the general insulation of the circuit saving him, the current which he received was sufficient to burn into the concrete floor the print of the nails in one of his shoes. The ordinary tests on the line made shortly afterward showed no particular ground, nor was there any reason to believe that one existed at the time of the accident. Other accidents, under similar conditions, have occurred with arc light circuits of lesser voltage, on which there was a similar absence of perceptible ground. It is advisable, therefore, that all high voltage circuits should be treated as uninsulated, so far as contact is concerned, at all times, and if insulation tests are to be made upon them to determine the resistance to ground, these tests should be made with, at least, the full voltage of the circuit. It is quite as well not to place too much reliance on insulation of any kind; but to regard a high voltage electrical circuit as dangerous, and to be treated with the same respect as is due to other useful, but dangerous, agents, like high pressure steam and dynamite, neither of which is likely to be abandoned on account of the danger that comes from careless use. The precautions taken, either with these or with high voltage currents, should be in the direction of preventing such carelessness as might result disastrously.

An electrical circuit should be so installed that no material risk can be run by any person who is not indulging in wilful interference with the line, and in such case, if an accident

occurs, the victim is deserving of no more sympathy than one who deliberately stands in front of an express train.

If the circuit is of bare wire, there can be no doubt in the mind of any one as to its dangerous character, whereas, if insulated wire is employed, there is likely to be established a certain false sense of security. There is no good reason, therefore, for advising the extensive use of insulated wire for high voltage lines.

The ideal overhead circuit is one in which the conductor is thoroughly insulated as regards leakage, carefully protected from danger of wires or branches falling across it, and placed out of the reach of anything except deliberate interference of human beings. There may be places at various points along the line where insulation would be desirable, in order to avoid extensive cutting away of trees, branches of which might fall upon the line, or where local regulations require the use of insulated wire. Except under these circumstances continuous insulation increases the cost and maintenance of the line without giving any adequate returns in security. On rare occasions, portions of the high voltage circuit may have to be placed underground. Here only the very best quality of insulation should be employed, thoroughly protected by an outside sheathing of lead against the effects of moisture, and installed in smooth, clean, dry, and accessible conduits with especial attention to insulation at the joints. Of this, more in Chapter XIV.

From what has been said, it should be understood that while the problem of installing high voltage lines is unquestionably a difficult one, we have not yet had sufficient experience to be able to say definitely how difficult it may be. It is very certain that much more can be done than has been accomplished. It seems probable that so far as overhead work is concerned, it will before long be practical to employ voltages considerably greater than those now in use. Before any limit can be set to the progress in this direction, we need ample experimental data, not only on the behavior of insulation at a very high pressure, but on the maximum voltage which is likely to be encountered when a certain effective voltage is to be employed. This opens up a wide field for investigation, involving con-

ditions of unknown seriousness, connected especially with the electrical peculiarities of alternating currents, which there is every reason to believe will be employed almost exclusively on high voltage work.

The special difficulties to be met in working with alternating currents are two — inductance in the line and apparatus, and electrostatic capacity, accompanied by the very serious phenomena of electrical resonance. In addition to these, whatever the character of the current used for transmission purposes, there is danger of getting accidentally upon the line a voltage much higher than the normal. Inductance is met with to a very considerable extent in all alternating circuits; resonance in a small degree is probably much commoner than is generally supposed, and abnormal voltage, due to the generators themselves, must always be guarded against.

Passing at once to the practical side of the question, we find that when an alternating current is sent through any



FIGS. 256 AND 257.

Elec. World

conductor, it has to deal not only with the electrical resistance of that wire, but with a virtual resistance due to the fact that the electro-magnetic stresses set up at any point of the conductor set up electromotive forces at other points in the same conductor, which oppose and retard the passage of the current.

These matters have been fully discussed theoretically in Chapter IV, and hence will be here but briefly mentioned.

For example, if a wire be bent into a couple of spiral coils like Fig. 256, the electro-magnetic field of one coil will affect the other, just as we have induction from one separate ring to another in Fig. 4, page 13. If such a spiral has an iron core, this *self-inductance* will be much increased. Even if only a straight wire be concerned in the carrying of current, there will be a similar inductive relation between the inner and outer

portions of the wire at any point, since the electro-magnetic stresses exist inside the wire as well as outside.

Let Fig. 257 represent a circuit carrying an alternating current, which at a given moment is flowing as shown by the arrows. The electro-magnetic field set up by this current in the loop has a direction perpendicular to the plane of the paper, and sets up an E. M. F. opposing that of the wire. The greater the area of the loop, *i.e.*, the farther apart the two wires, the greater proportion of the electro-magnetic field will pass *within* the loop and produce self-induction.

Similarly, the larger the wires for a given distance between them, the less effective field within the loop to set up inductance. In fact, the amount of inductance in the circuit depends directly on the ratio between the radii of the wires and the distance between them. So if the diameter of the wire is decreased to one-half the original amount, the wires must be strung only half as far apart in order to retain the same inductance.

The practical effect of inductance in the line is to necessitate the use of an initial E. M. F. large enough to overcome the inductive loss of voltage, as well as that due to resistance, and so keep the E. M. F. at the receiving end of the line up to its proper value. To undertake in an orderly way the design of a power transmission line we may consider seriatim the effects of resistance, inductance, and capacity as determining the losses and the precision of regulation and as related to the abnormal values of the voltage which determine the real factor of safety in the insulation.

To begin with, Ohm's law is the basis of all computations regarding the line, and lies behind all the formulæ used for this purpose. The most obvious way of applying it would be to find the resistance of the whole line corresponding to the required current and loss in voltage, and then to look up in a wire table the wire which taken of the required length would give this resistance.

As a matter of convenience in computation, various formulæ have been devised to include in simple form the factors of distance, voltage, power transmitted and loss in the line, and giving the area weight or cost of the conductors.

The area of wires is in English speaking countries expressed in terms of the circular mil (c.m.), which is the area of a circle 0.001 inch in diameter, a barbarous unit, which, however, by merest chance leads to formulæ numerically simple.

The following formulæ are perhaps the most convenient of those in use. They are derived as follows. Starting with

Ohm's law $R = \frac{E}{C}$ and remembering that for any wire

$$R = \frac{\text{Total length in ft.} \times \text{resistance of 1 ft. of wire 1 mil in diameter}}{\text{Area in circular mils}}$$

we obtain since the resistance of 1 mil-foot of copper wire is very nearly 11 ohms,

$$R = \frac{11 L}{\text{c.m.}},$$

or taking the total length of wire as twice the distance of transmission in feet, since this distance is the thing immediately concerned we have

$$R = \frac{2 D \times 11}{\text{c.m.}},$$

Now substituting this value of R in the expression for Ohm's law we have

$$\text{c.m.} = \frac{2 D \times 11 \times C}{E} \quad (1)$$

This gives the area of the wire for delivering any current over any distance with any loss, E in volts. The corresponding sizes and weights of wire can be looked up in any wire table.

As a matter of convenience the following table gives for the sizes of wire likely to be used in power transmission the area in circular mils, the diameter, resistance per thousand feet, weight per thousand feet bare, and weight also with insulation of the so-called weather-proof grade, commonly used on distributing circuits. The diameters are given to the nearest mil, the areas to the nearest 10 c.m. and weights to the nearest pound. No wires larger than 0000 are here considered, since even this size of copper is seldom used, and

Circular Mils.	Gauge No. B. & S.	Diameter in Mils.	Ohms per M ft. at 70° F. and 98% Conductivity.	Ohms per mil.	Wt. per M feet Bare.	Wt. per M ft. We' th'r proof.
211,600	0000	460	.05026	.26537	640	725
167,800	000	410	.06337	.33459	508	580
133,100	00	365	.07991	.42182	403	480
105,600	0	325	.10077	.53196	320	375
83,690	1	289	.12707	.67093	253	307
66,370	2	258	.16024	.84606	201	245
52,630	3	229	.20206	1.06687	159	195
41,740	4	204	.25479	1.34529	126	147
33,100	5	182	.32129	1.69651	100	121
26,250	6	162	.40516	2.13924	79	99

on the other hand wires smaller than No. 6 are mechanically weak and rarely would be advantageous. In fact the sizes No. 00 to No. 2 inclusive include the wires commonly used.

The actual value of the mil-foot constant at ordinary temperatures is approximately 10.8, but is here taken as 11 ohms to take account of the ordinary contingencies of irregular diameter, slight variation in conductivity, and the effect of hard drawing.

The next step in simplifying the computations, is to find a simple expression for the weight of the wire required. Now it chanced that a copper wire 1,000 c.m. in area, weighs very nearly 3 lbs. per thousand feet, and hence we can get a very simple formula giving directly the weight in pounds per thousand feet. Taking D in thousands of feet and expressing this fact by writing it D_m we have

$$W_m = \frac{2 D_m \times 33 \times C}{E}, \quad (2)$$

or for the total weight of the wire

$$W = \frac{4 D_m^2 \times 33 \times C}{E}. \quad (3)$$

This applies to ordinary direct current or single-phase circuits. Now we have already seen that each conductor of a three-phase line has one-half the area of one wire of the equivalent single-phase line, so that by dropping the factor 2 in (1) we have for the required area of one wire

$$\text{c.m.} = \frac{D \times 11 \times \frac{w}{V}}{E}. \quad (4)$$

Herein $\frac{w}{V}$ is taken to avoid any possible confusion as to the value of C , w being the watts at either end of the line and V the working voltage at the same end, while E as before is the loss in volts. Then proceeding as before we get for the total weight of the three-phase lines,

$$W = \frac{100 D_m^2 \frac{w}{V}}{E} \quad (5)$$

the constant being taken as 100, instead of 99, to compensate for a minute deficit, in the assumption of 3 lbs. per thousand feet for a wire of 1,000 c.m.

This particular simplification lends itself very readily to a cost formula in which P is the total price in dollars when p is the price of copper wire taken in cents per pound; as follows:

$$P = \frac{p D_m^2 \frac{w}{V}}{E} \quad (6)$$

Finally, since a power factor less than unity implies the delivery of increased current for the same energy and voltage, we can take account of this factor of increase by writing

$$P = \frac{p D_m^2 \frac{w}{V}}{E \cos \phi} \quad (7)$$

with analogous expressions in the case of the previous formulæ. For aluminium wire, insert the factor 2 in the denominators of the weight formulæ.

Another convenient empirical formula for the total weight of copper in a three-phase circuit is the following

$$W = 300,000,000 \frac{M^2 K w}{a V^2}.$$

In which M is the distance of transmission in miles, $K w$ the kilowatts of energy transmitted at voltage V , and a is the

percentage of loss expressed as a whole number. This formula gives results a few per cent larger than (5) and like it, can be made to take account of lagging current so far as ohmic drop is concerned by putting $\cos \phi$ in the denominator. For aluminium wire, put 2 in the denominator as in the other formulæ.

It frequently happens in using these formulæ that the wire indicated by the assumed data, falls between two of the ordinary sizes. In large work one can have wire or cable made very nearly to the desired size without increased expense, but ordinarily one chooses the nearest standard size, preferably the next larger.

So far then as computing the copper required for transmitting the energy goes, it is a very simple matter to figure a transmission line. But inductance is another matter. The simplest way of treating it is to deal with it as an additional resistance, causing no increased loss of energy for the same current, but demanding increased E. M. F. at the generator, and affecting consequently the regulation. The resistance of the line determines the energy loss, the impedance the limits within which the impressed E. M. F. must be regulable.

For any system of given size and distance of wires worked at a given frequency, the inductance like the resistance increases directly with the length of circuit so that the ratio between them is constant, and one can express the impedance in terms of resistance by multiplying the resistance by the proper *impedance* factor, when once this ratio is ascertained. The same factor converts the ohmic drop into the impedance drop which is the quantity here sought.

In a circuit with wires spaced δ inches between centres, and each r inches in radius, the self-induction in henrys per mile is

$$L = 0.000322 \left[2.303 \log \frac{\delta}{r} + .25 \right]$$

which results from translation of the C. G. S. formula

$$l = 2 \left[\log_e \left(\frac{\delta}{r} \right) + \frac{1}{4} \right]$$

into English measure and common logarithms. From this as a basis and from the known resistances, is constructed the curves of Fig. 258. They give graphically the impedance factors at 60~ for wires from No. 0000 to No. 4 string 24, 48, and 72 inches between centres.

The impedance factor increases with the size of wire at any

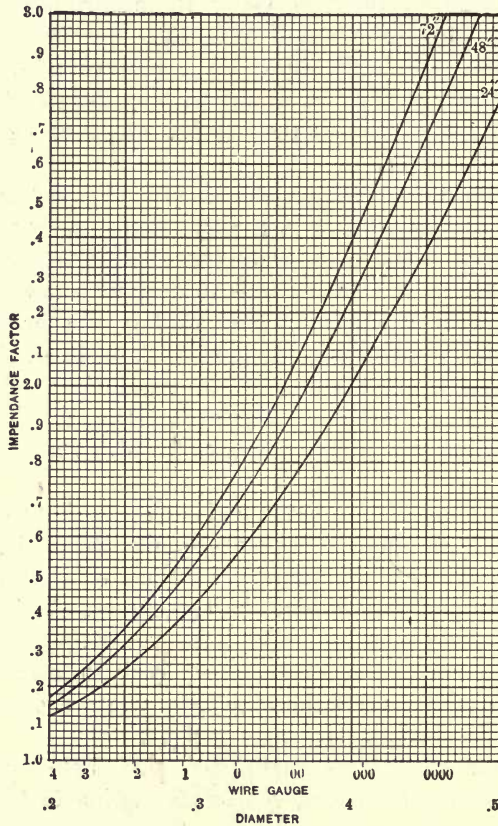

FIG. 258.

given spacing because the resistance decreases in proportion to the area, and the length of the circuit is not concerned since both resistance and inductance increase directly with the length so that they remain proportional. For the most part the value of the factor ranges from 1.5 to 2.5 so that

considering only this matter, the total drop is seldom much above twice the ohmic drop. To compensate for the inductive drop, then, the generator must have a margin of voltage correspondingly greater than that required by the ohmic loss alone.

It cannot be too strongly impressed upon the reader, however, that in actual practice these line constants are greatly modified by the character and amount of the translating devices at the receiving end of the line. To determine the actual drop in the line, and the regulation required, one must take into account both the line and the load. As a rule the inductances and capacities of high voltage apparatus are rather large compared with those of lines of moderate length, but large or small they modify the regulation, for the final impedance of the system is the geometrical sum of its components.

As a practical matter it is the constant effort of the engineer to keep the power factor of the transmission circuit high, so as to avoid the loss due to generating and transmitting a large useless component of the current chargeable to lag. In working at a bad power factor, not only does the impedance ratio rise, but the resistance drop increases for the same energy, so that the regulation quickly goes from bad to worse.

As a general rule the impedance due to the line and load is likely to introduce a total line drop two to three times the ohmic drop for the same line current, unless helped out by capacity. If then the full load drop due to resistance be 10 per cent, one must be prepared at the station to furnish 10 to 20 per cent extra voltage to compensate for inductive drop. It is therefore especially desirable to obtain a high power factor at and near full load, to avoid using generators of abnormal capacity. The light load power factors cause little trouble. The fundamental requirement is that the station should be able to hold uniform voltage at the receiving end of the line under all circumstances of load. To give good commercial results the service voltage should be kept within 2 per cent of normal if lighting by incandescents is important, and within 4 or 5 per cent for satisfactory motor service.

This means that the conditions of regulation must be thor-

oughly investigated. At any state of load the regulation is determined by the vector sum of the impedances in circuit, which for regulation at the receiving substation means sum-

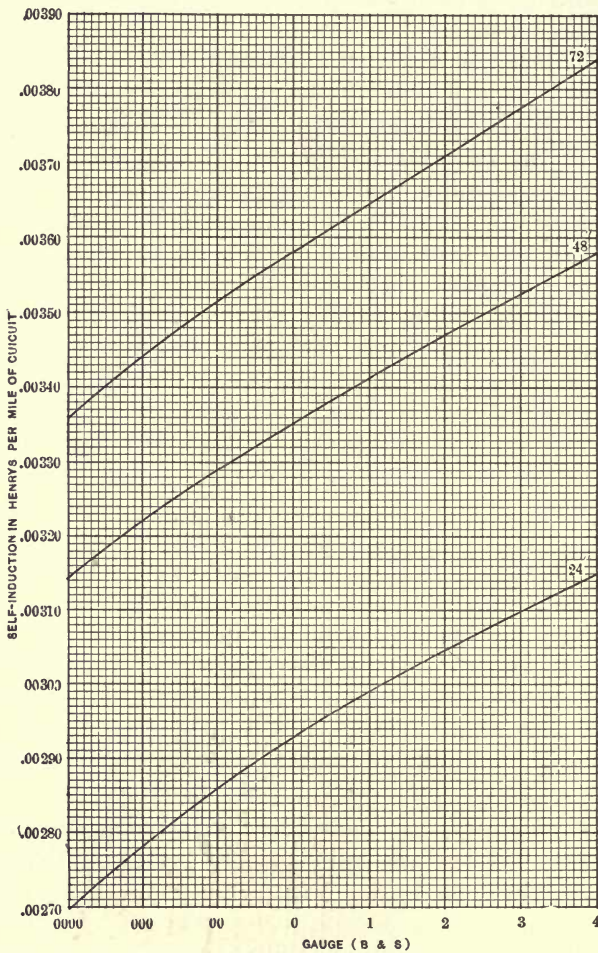

FIG. 259.

ming the impedances of the line and of the receiving circuit under various conditions of load.

First in order comes the actual inductance of the line wires. Here as elsewhere in this discussion, the line is assumed to be

three-phase with the wires symmetrically arranged at the corners of an equilateral triangle. The formula for the coefficient of self-induction, L , which depends entirely on the dimensions of the system, has been given, but for convenience the values per mile of complete circuit for wires from No. 0000 to No. 4, strung 24, 48, and 72 inches apart are shown graphically in Fig. 259. To reduce to self-induction per wire divide by $\sqrt{3}$. Multiply by $2\pi n$ to obtain the inductance in ohms from the values of L given by the curves. For 60~, $2\pi n = 377$.

The curves show that for the wires in common use in transmission work, L does not vary over a wide range, being commonly 3 to 3.5 milli-henrys per mile of circuit.

There is another cause of increased drop of voltage in alternating current circuits quite apart from ordinary inductance. Some years ago Lord Kelvin pointed out that in the case of alternating and other impulsive currents the ohmic resistance of conductors is slightly increased. This is for the reason that in such cases the current density ceases to be uniform throughout the cross section of the conductor. The instantaneous propagation of any current is primarily along the surface of the conductor, and only after a measurable, though short, time is the condition of steady flow reached.

When the current rapidly alternates in direction the interior of the conductor is thus comparatively unutilized, for before the flow has settled into uniformity its direction is changed, and the original surface flow is resumed. The larger the wire and the greater the frequency the more marked this effect. Fortunately, with the common sizes of wire and the frequencies ordinarily employed for power transmission work, it is quite negligible. At 60 periods the increase of resistance due to this cause, in a conductor even half an inch in diameter, is less than one-half of 1 per cent. Any line wire that is allowable on the score of its impedance factor will be unobjectionable on this account as well. Only occasionally, as in bus bars for low voltage switchboards, is it worth considering, and in such cases the use of flat bars, half an inch or less thick, or tubular conductors, will obviate the difficulty.

In computing the sum of the impedances, it is sometimes

convenient to include with the line the impedances of raising and reducing transformers reduced to terms of the full line pressure, the primary resistance being increased by the secondary resistance multiplied by the square of the transformation ratio to form the equivalent total resistance, usually not far from twice the primary resistance; and the inductance being determined from the inductive drop when loaded.

At the receiving secondary terminals, the measured angle of lag due to the load at once tells the story of the relation between the power and the idle component of the current. For the purpose of determining regulation the items of the load need not be considered, if we know the lag angle which determines the current components which have been furnished over the line. For short lines overhead, the line impedance and the lag angle determine the regulation, but on very long overhead lines, and in underground cables, capacity plays an important part.

The capacity of overhead circuits like the self-induction is determined by the dimensions of the system, except as there may be localized capacity. For the customary three-phase overhead circuits the situation has been simplified by Perrine and Baum,* who showed that for such circuits the capacity acted as if concentrated in three condensers at the middle of the line, and star connected to a common neutral point. Upon this hypothesis, which leads to sufficiently precise results for all cases now practical, the capacity C in microfarads reckoned between one wire and neutral point for wires r inches in radius and spaced d inches apart becomes, per mile,

$$C = \frac{.0776}{2 \log_{10} \left(\frac{d}{r} \right)}.$$

Fig. 260 shows graphically the values of C for wires of the usual sizes spaced respectively 24, 48, and 72 inches between centres. Here again there is a considerable degree of uniformity, C ranging ordinarily between .014 and .018.

The corresponding current equivalent, or charging current,

* Trans. A. I. E. E. May, 1900.

i , depends like the inductance on the frequency, but also, unlike the inductance, upon the voltage; and in general

$$i = p C n V.$$

Here, for one wire of a three-phase line, p has the value

$$p = .000,003,627.$$

For a 60 cycle line, multiply the values from the curve by

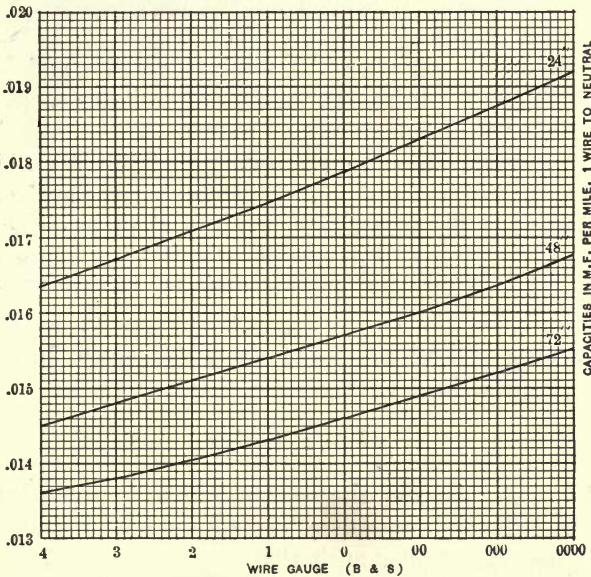

FIG. 260.

2.18 for 10,000 volts line pressure and proportionately more for higher pressures.

As for our purpose the capacity is taken as if localized at the centre of the line, i must be regarded as flowing through one-half the line impedance. If there is localized capacity elsewhere, as in case of cables, its charging current, determined from the capacity of the cable as above, must be taken as flowing over the actual length up to the capacity and forms a geometrical addition to the capacity just considered.

We now have in hand the data for figuring the terminal voltage of a transmission line from the impressed voltage by

summing the several impedances, and computing their resultant in view of the current and energy values disclosed by the lag (or lead) angle ϕ at the terminus.

For the present purpose the most simple and elegant method of making this summation is that of Perrine and Baum (*loc. cit*)* which takes as a starting point the receiver voltage which is to be held steady, and treats the power component and the idle component of the receiver current as if they flowed independently through all the impedances up to the receiver as, in effect, they do.

Let us start then with the receiver voltage and lay out Oa , Fig. 261, equal to this voltage on any suitable scale. Here the receiver voltage is taken at 10,000. The ohmic drop at full non-inductive load we will take as 2,000 volts which lay off as an extension of Oa to b . The total current in the system is composed of the true energy current, the idle current, and the charging current, if any, each of which consumes voltage in being forced through the line impedance. Taking them up successively, the energy current is $I \cos \phi$, ϕ being the angle of lag or lead at the receiver, and since we are here considering full load energy

$$ab = IR \cos \phi$$

i.e., the ohmic drop of the energy current. Now proceed to form the ordinary impedance triangle abc as follows. From b erect a perpendicular such that

$$bc = I(L\omega) \cos \phi$$

on the same scale as ab , $L\omega$ being the inductance in ohms. This can be done by computing the actual inductance from the data assumed. Then ac , on the working scale, gives in magnitude and direction the total volts consumed over the line by the energy-current. If transformers or other apparatus are included in this estimate for the line, this fundamental triangle abc must be built of its components geometrically as shown in Fig. 56. If the line only is concerned, the point

* See also Baum, *Elec. World & Eng.*, May 18, 1901, and *Trans. Int. Elec. Cong.*, 1904, Vol. II, p. 243.

c is at once located by striking from a as a centre an arc with a radius equal to the impedance factor on the scale of $a b$, and erecting a perpendicular from b to meet it.

The next step is to determine the magnitude and direction of the pressure consumed over the line by the idle component of the current. This is at right angles to $a c$, hence draw a line perpendicular to $a c$, as $g c d$. Then lay off the angle ϕ from a as a centre to the right if lagging, to the left if leading. The intercept $c d$ is the pressure required; for dropping the perpendicular $d e$ upon $c b$, the triangles $a b c$ and $c d e$ are similar, with their corresponding sides by construction respectively proportional to $\cos \phi$ and $\sin \phi$. Thus

$$\begin{aligned} c e &= I R \sin \phi \\ e d &= I (L_{\omega}) \sin \phi \\ c d &= I \sin \phi \sqrt{R^2 + (L_{\omega})^2} \end{aligned}$$

Now draw $O d$ which is the geometrical sum of $O a$, $a c$, $c d$ and we have E , the impressed E. M. F. necessary to give 10,000 volts at the receiver under the assumed conditions. With E as radius, draw the arc $d f$ and E is at once seen to be 14,200 volts. The point d corresponds to $\cos \phi = .90$. For other values lay off the appropriate angles and treat as before. For angles of lead lay off the angles on the other side of $a c$, as $a g$ for $\cos \phi = .90$. This gives E_2 which thrown down upon the voltage axis gives 11,200 volts at the point b . This shows less than the normal drop, since a leading current at the load can only exist concurrently with condenser effects.

And capacity in the line remains to be considered. From d lay off $o k = \frac{i R}{2}$ and $k j = \frac{i (L_{\omega})}{2}$, when $j d$ becomes the impedance for the charging current and $O j$ the new impressed E. M. F.

If capacity is an important item, it is easier, since it is constant for all values of the load, to lay out $d k$ and $k j$ at the start, making d coincide with a and then starting the fundamental power triangle from the new position of j as in Fig. 262.

As a matter of fact, line capacity is not an important factor

in transmission, save in rather long lines at high voltage. For example, in a 20-mile line at 20,000 volts, of No. 00 wire spaced 24 inches, the charging current is about 1.6 amperes per wire, the impedance factor of the line nearly 1.7, the resistance of half a wire a little over 4 ohms, and the resulting E. M. F. for capacity impedance only some ten or a dozen volts.

For partial load regulation note that abc , Fig. 261, holds its shape for all loads and merely changes in magnitude. For half load therefore, go half-way up along ac to the point l , which corresponds to c of the full-load diagram. Draw the perpendicular corresponding to cd through l . Then for any power factor, as .8, the intersection m gives the end of the corresponding impressed E. M. F. as before. A system of

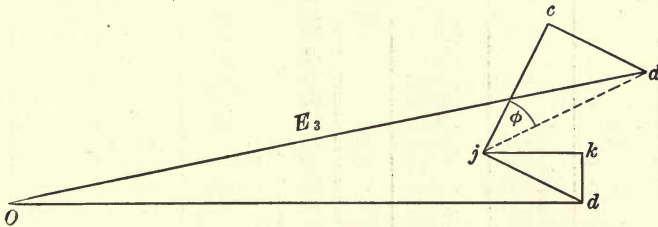

FIG. 262.

lines parallel with lm and for every tenth of ac , intersecting all the power factor lines, makes it easy to determine the regulation for almost any sort of load.

The rise of E. M. F. at the end of a line containing capacity is one of the most striking features of alternating current working, and while the constructions just given show its amount, they do not at first sight disclose its physical significance. The fact is, however, that a condenser is a device for storing electrical energy, which is returned to the line in such wise that its voltage is added (geometrically of course) to the line voltage. It simply amounts to an electrostatic booster of enormous efficiency, close upon 100 per cent, taking energy from the line and utilizing it in raising the voltage. If the capacity is distributed along the line, it takes a very long line to do much boosting. If it is concentrated and considerable, as in a cable, the effect may be very striking.

An over-excited synchronous motor, as we have already seen, can be made to act like a condenser in the system, although

TABLE OF NATURAL TANGENTS, SINES AND COSINES.

Angle.	Tan.	Sin.	Cos.	Diff. Sin. 10'	Angle.	Tan.	Sin.	Cos.	Diff. Sin. 10'
0°	.0000	.0000	1.0000						
1	.0175	.0175	.9998	29	46°	11.0355	1.7193	.6947	20
2	.0349	.0349	.9994	29	47	1.0724	.7314	.6820	20
3	.0524	.0523	.9986	29	48	1.1106	.7431	.6691	20
4	.0699	.0698	.9976	29	49	1.1504	.7547	.6561	19
5	.0875	.0872	.9962	29	50	1.1918	.7660	.6428	19
6	.1051	.1045	.9945	29	51	1.2349	.7771	.6293	18
7	.1228	.1219	.9925	29	52	1.2799	.7880	.6157	18
8	.1405	.1392	.9903	29	53	1.3270	.7986	.6018	18
9	.1584	.1564	.9877	29	54	1.3764	.8090	.5878	17
10	.1763	.1736	.9848	29	55	1.4281	.8192	.5736	17
11	.1944	.1908	.9816	29	56	1.4826	.8290	.5592	17
12	.2126	.2079	.9781	28	57	1.5399	.8387	.5446	16
13	.2309	.2250	.9744	28	58	1.6003	.8480	.5299	16
14	.2493	.2419	.9703	28	59	1.6643	.8572	.5150	15
15	.2679	.2588	.9659	28	60	1.7321	.8660	.5000	15
16	.2867	.2756	.9613	28	61	1.8040	.8746	.4848	14
17	.3057	.2924	.9563	28	62	1.8807	.8829	.4695	14
18	.3249	.3090	.9511	28	63	1.9626	.8910	.4540	13
19	.3443	.3256	.9455	27	64	2.0503	.8988	.4384	13
20	.3640	.3420	.9397	27	65	2.1445	.9063	.4226	12
21	.3839	.3584	.9336	27	66	2.2460	.9135	.4067	12
22	.4040	.3746	.9272	27	67	2.3559	.9205	.3907	12
23	.4245	.3907	.9205	27	68	2.4751	.9272	.3746	11
24	.4452	.4067	.9135	27	69	2.6051	.9336	.3584	11
25	.4663	.4226	.9063	26	70	2.7475	.9397	.3420	10
26	.4877	.4384	.8988	26	71	2.9042	.9455	.3256	10
27	.5095	.4540	.8910	26	72	3.0777	.9511	.3090	9
28	.5317	.4695	.8829	26	73	3.2709	.9563	.2924	9
29	.5543	.4848	.8746	25	74	3.4874	.9613	.2756	8
30	.5774	.5000	.8660	25	75	3.7321	.9659	.2588	8
31	.6000	.5150	.8572	25	76	4.0108	.9703	.2419	7
32	.6249	.5299	.8480	25	77	4.3315	.9744	.2250	7
33	.6494	.5446	.8387	24	78	4.7046	.9781	.2079	6
34	.6745	.5592	.8290	24	79	5.1446	.9816	.1908	6
35	.7002	.5736	.8192	24	80	5.6713	.9848	.1736	5
36	.7265	.5878	.8090	24	81	6.3138	.9877	.1564	5
37	.7536	.6018	.7986	23	82	7.1154	.9903	.1392	4
38	.7813	.6157	.7880	23	83	8.1443	.9925	.1219	4
39	.8098	.6293	.7771	22	84	9.5144	.9945	.1045	3
40	.8391	.6428	.7660	22	85	11.430	.9962	.0872	2
41	.8693	.6561	.7547	22	86	14.300	.9976	.0698	2
42	.9004	.6691	.7431	21	87	19.081	.9986	.0523	1
43	.9325	.6820	.7314	21	88	28.636	.9994	.0349	1
44	.9657	.6947	.7193	21	89	57.290	.9998	.0175	0.5
45	1.0000	.7071	.7071	20	90	∞	1.0000	.0000	

at less efficiency, and the angle of lead which it must give to the receiver current in order to produce any desired effect on the voltage can be deduced from the construction of Fig. 261. Practically, therefore, synchronous machines are very valuable adjuncts in regulation. If rotary converters are used, as in handling a railway load, they can be so compound wound from the direct current side as to compensate for the effect of their own changing load upon the receiver voltage. The same thing can be even more easily done with a motor generator. Now and then on very long high voltage lines it is desirable to add inductance at light loads to preserve the regulation. For if one lays out the light load conditions in Fig. 261 the capacity triangle, dkj becomes relatively important. For convenience in computations a table of natural sines, cosines, and tangents is annexed. The column of differences for the sines holds good for cosines of the same *numerical* values.

Really the most serious practical difficulties in an ordinary alternating plant are those in which the generator is involved by inductances in the system. These are often of far greater moment than the impedance factor of the line. An inductance in the system produces two effects on the generator — first, as just noted, it demands a larger current to deliver the same energy; second, it tends to beat down the E. M. F. of the machine. This effect is analogous to that produced by shifting the brushes of a continuous current generator away from the position of maximum E. M. F. (See Chapter V.)

This reaction of the armature is serious in that it not only demands a considerable increase in the exciting current, but causes a severe strain on the insulation when it suddenly ceases. It is not uncommon to find an alternator that requires on a heavy inductive load double the light-load excitation of the field. For instance, if the voltage be 2,000 on open circuit, the excitation may have to be increased on inductive load to a point that on open circuit would give 4,000 volts. If, now, this load is cut off, or the line is broken, the insulation will be exposed, momentarily, at least, to double the normal voltage.

Such generators should not be used on inductive loads or

in any case where the extra strain on the insulation is important. It is perfectly easy to build a generator which requires only 10 to 15 per cent more excitation at full and inductive load than at no load, and such machines should be used in all cases where a steady voltage under all working conditions is needed. The other type has its uses, but the general work of power transmission is not one of them. With a properly designed machine, inductive load is little to be feared.

Another possible source of danger is that under certain conditions of inductive load, the reaction of the load on the generator, without materially lowering its effective voltage, may so change the shape of the E. M. F. wave as to give to it an abnormally high maximum, and thereby greatly to increase the strain on the insulation. This effect may readily occur, but usually in so small a degree as to be of little moment. Occasionally, owing to a combination of severe inductive load and badly designed generator, the results may be somewhat formidable, the more so as the change takes place under heavy load and not, as in the case just treated, only on open circuit or a sudden light load. The rise in pressure thus produced may amount to several times the nominal voltage. The same sound principles of design that insure good regulation under changes of load will obviate any danger of this kind. In fact, most of the possible disturbing factors in alternating current work become negligible in an installation carried out with regard for the general principles of good engineering.

These abnormalities of voltage lead naturally to the consideration of another far more serious, due to the static capacity of the system. Of course, the fact that under certain circumstances capacity in the system will cause a lessening of the apparent "drop" on the line, or even overcome it altogether and show a higher voltage at the receiving end than at the generator, is already well known to the reader. Under certain conditions, however, this rise may become cumulative, producing electrical resonance, the fundamental principles of which have already been described.

Every electrical system has as we have already seen, a definite period of oscillation determined by its particular properties. If we could apply an instantaneous electromotive

stress to any point of it, the effect would be that the resulting strain would travel back and forth with a definite frequency until its energy would be completely exhausted by doing work on various parts of the system. The action resembles that which takes place when we strike the end of a long rod with a hammer. An impulse is sent out at a rate depending on elasticity, density, and so forth, travels to the end of the rod, is reflected, and so goes on swinging back and forth until the energy is frittered away. This corresponds to electric oscillations on open circuit.

The two properties of an electrical system which determine its vibration period are its self-induction, which is analogous to inertia, and its capacity, which resembles elasticity in the dielectric, capable of taking up and returning energy. Resistance, like intermolecular friction in the rod just referred to, determines the rate at which the vibrations will die out by yielding up their energy to the system, but has ordinarily a negligible effect on the vibration period.

This period in an electric circuit is given by the formula:

$$T = .00629 \sqrt{LC} = \frac{2\pi}{1,000} \sqrt{LC}.$$

In this T is the natural time period of the circuit expressed in seconds, L is the coefficient of self-induction in henrys, and C the capacity in microfarads. For example, suppose we are dealing with a circuit of which the capacity is two micro-

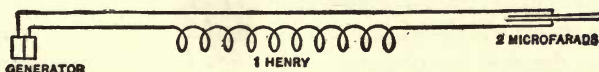

FIG. 263.

farads and the self-induction one henry. Let it be arranged as in Fig. 263. For simplicity the inductance and capacity are shown localized and in series as would happen if a line ran through a group of series transformers and thence into a cable. If the line were open-circuited beyond the cable, we might find a very severe strain on the cable insulation. The period of this line would be .00887 second — about 113 cycles per second. If this should chance to be the frequency of the generator it

would be in resonance with the line, and each wave of E. M. F. sent out by the generator would add itself to another wave just starting out in the same direction. A period later these two added E. M. F.'s would be reinforced by the next generator wave, and so on indefinitely.

The only thing which prevents the resultant voltage from rising indefinitely is the effect of energy losses in causing each wave to die out gradually as it continues its oscillations, so that only a limited number of waves can add materially to the resultant E. M. F. across the terminals of the capacity.

In a given circuit the relation between the initial voltage and the voltage of resonance can be easily determined to a fair degree of approximation. It is, neglecting minor reactions, as we have already seen,

$$E' = \frac{nL}{R}E.$$

In this equation E' is the rise of E. M. F. due to resonance, n the frequency, L the self-induction in henrys, R the ohmic resistance, and E the initial voltage. Applying this formula to the case just discussed, and assuming the resistance of the line to be 15 ohms and the initial voltage to be 2,000, we find

$$E' = \frac{113 \times 1 \times 2,000}{15} = 15,066 \text{ volts.}$$

A very moderate line voltage might thus, in a resonant line, give rise to a pressure quite capable of rupturing any ordinary cable, or causing serious trouble on an overhead line, to say nothing of greatly increasing the danger to persons and property. If the working pressure were 10,000 or 15,000 volts, the E. M. F. of resonance might theoretically rise to an appalling amount.

Fortunately the theoretical value is in practice much reduced by hysteretic losses and Foucault currents in any iron-cored coils in circuit, waste of energy in the dielectric, and other minor causes of damping the electrical oscillations, even when resonance is complete. Still, dangerous rises in voltage are very possible. When the frequency of the applied E. M. F. differs somewhat from the natural period of the line, resonant effects can evidently still take place, but in a rapidly lessen-

ing degree; when the oscillations are strongly damped by the presence of iron, the total resonant rise is considerably diminished, but it varies less rapidly as the resonant frequency is departed from.

A resonance curve for various capacities shows that the rise of voltage extends over quite a wide range of variation of capacity, but is large over but a small range. The shape of such a curve necessarily varies widely, as the resonance is more or less damped by resistance, iron-cored coils and so forth; but we may be quite sure that the maximum resonance will occur at not far from the point indicated by our equation for the vibration period of the circuit, and that the maximum E. M. F. of resonance will usually be considerably less than that given by the theoretical equation.

In practical alternating circuits the current wave is never truly sinusoidal, but consists of a main or fundamental wave with the odd (*i.e.*, 3d, 5th, 7th, etc.) harmonics of various amplitudes superimposed upon it. In nearly every case the third harmonic is the most prominent and is quite capable of causing resonance, even to a dangerous degree, if it happens to fall in with the frequency of the system. The point at which resonance occurs and the rise of E. M. F. are found for the harmonics by the formulæ already given.

So far as the line is concerned, the facts regarding resonance can be easily computed with tolerable accuracy. From well-established data it is evident that the line capacities and inductances are generally so small as to make the oscillation period so short as not to correspond with the frequencies in ordinary use except in the upper harmonics, which are generally of small moment, although one case of severe resonance from a higher harmonic (probably the 7th) has come to the author's notice. For example, with a 7th harmonic of 1,000 volts amplitude on a 10,000 volt line at 60~, having an inductance of .2 henry and a resistance of 20ω , the rise due to resonance might be some 40 per cent of the line voltage.

It must be remembered that not only the line capacity, but the capacity of the sending and receiving apparatus, must be considered. The former is but small, except in the case of underground or submarine cables, for which the capacities are

likely to be from $\frac{1}{4}$ to $\frac{1}{2}$ microfarad per mile, as ordinarily manufactured. High-voltage devices, like synchronous motors, generators, and transformers, often may have static capacities of several tenths of a microfarad, and inductances of several hundredths of a henry. Resonance may involve the whole system, or may at times be started in a minor degree in some branch in which the natural oscillation period happens to be just right.

As a matter of fact, experience seems to show that one is not likely to stumble upon very serious resonance in overhead lines, although in cables it is easily possible. On the other hand, it is more than likely that resonance of a minor kind, mostly from harmonics, is far commoner than is generally supposed. It will be noted from the data given that L and C on simple overhead lines do not vary over a wide range in different sizes of wire at the ordinary spacings. Both increase directly with the length of the line, and so of course does \sqrt{LC} on which the natural frequency of the line depends. Bearing this in mind, one can get a roughly approximate idea of the natural frequency on which resonance depends. For fairly long lines, say between 50 and 100 miles, N , the frequency in question is likely to fall between 300~ and 500~, being proportionately less for longer lines and greater for shorter lines.

Obviously this value makes resonance with the fundamental generally out of the question, but gives a good chance for the 5th and 7th harmonics.

Pure resonance with a periodic E. M. F. due to the generator is therefore practically confined to harmonics, but there are other sources of abnormal pressure on a transmission line.

Chief among these is *surging*, which is due to the oscillations of energy when a circuit which contains inductance and capacity is broken. It is a resonant phenomenon, depending as it does on the line period, but ordinarily it falls in with no source of cumulative impulses, which separates it from resonance, ordinarily so called.

The theory of surging is comparatively simple. When a circuit containing inductance and capacity is broken when carrying a current I , a certain amount of energy is left momen-

tarily stored in the form of the electro-magnetic stresses in the system. The energy thus cut off in transit, as it were, is

$$\frac{LI^2}{2}.$$

This, for lack of other outlet, is thrown into the capacity, and then, thrown back by it spring-wise, goes on thus oscillating with decreasing amplitude until it is frittered away by ohmic and other sources of loss.

But the energy stored in a condenser is

$$\frac{E_1^2 C}{2},$$

where E_1 is the voltage across its terminals. And since in surging, the energy in the condenser is that received from the electro-magnetic storage in the line,

$$\frac{LI^2}{2} = \frac{E_1^2 C}{2}.$$

C is here taken in farads. The frequency of the oscillation is evidently that naturally belonging to the system. Now this frequency involves a relation between L and C , being $2\pi N = \frac{1}{\sqrt{LC}}$; and now solving the energy equation just given for E_1 , the E. M. F. of the surge, one obtains two correlated expressions for E , one involving L and the other C , and both in terms of the frequency and current, as follows:

$$E_1 = 2\pi N L I, \quad (1)$$

$$E_1 = \frac{I}{2\pi N C}. \quad (2)$$

Knowing I the current broken, L and C , the value of E is obtained at once by substitution in either above equation (1) or (2).

The E_1 thus obtained is the alternating voltage as ordinarily reckoned. Its crest is approximately $E_1 \sqrt{2}$ volts, more if the wave be peaked, and the maximum strain tending to

break down insulation is this plus the crest of the impressed E. M. F. It is not uncommon to find waves sufficiently peaked to give $E_{\max} = 1.6 E$.

Based on somewhat rough approximations to the average line constants, Baum has given an approximate equation $E_1 = 200 I$ which is sufficient to give a working relation between the current in amperes broken and the voltage rise of the surge. This of course does not hold with cables in circuit or when the inductance and capacity of apparatus are taken into account.

In any case there is a good chance of opening the circuit at some other instant than that of maximum current. When ordinary switching is going on, especially with oil switches, there is rarely much surging, but a short circuit, particularly in a line containing cables, is likely to make mischief.

Still apart from surging, is the group of impulsive disturbances loosely classified as "static." They are exceedingly common, since they result from all sorts of sudden changes of load, switching on feeders, cutting in transformers, and so forth.

Suppose, for example, a long line is thrown on. There is a sudden rush of current sending an impulse along the line. This wave may be very abrupt, and, at the end of an open line or at any electrical obstacle like inductance or a sudden reduction in capacity, is wholly (for open circuit) or partially reflected, and as the phase changes suddenly during reflection there is an impulsive rise in pressure, up to double the wave voltage for total reflection with its phase change of a quarter cycle.

The reflected wave in running back may coincide with the crest of a secondary disturbance, or in very extreme cases may fall into resonance; but as a general rule, the effect is merely a sharp rise of pressure at the reflecting point, amounting to an increase of perhaps 50 to 100 per cent in the nominal pressure. In one particular the results may be serious, for the wave front in thus charging a line may be so abrupt as to be equivalent with respect to self-induction to a current of enormous frequency. Reaching an obstacle like the primary of a high-tension transformer, the full crest of the wave is upon it before the front has had time to penetrate far into the coil, and there may thus result a dangerous concentration

of potential in the outer layers of the coils, sufficient to cause punctures of the insulation. Grounds, short circuits, induced or direct lightning discharges, or any sudden and violent change of potential from any cause, may start a potential wave abrupt enough to produce breaking down of insulation. In practice "static" comes thus from a wide variety of causes, and, being impulsive, seldom is so much a source of danger as a heavy surge or true resonance. Yet it sometimes produces punctures that are followed by the line current with serious results. A very good account of "static" may be found in two papers by Thomas.* In point of fact, resonance, surging, and static may coöperate in the same phenomenon, and it is generally difficult to analyze the result on the available evidence. The moral of all this is that, in the insulation of high-voltage apparatus and lines, a considerable factor of safety must be allowed, since the insulation may be subjected to strains considerably greater than those due to the rated voltage. Probably the most dangerous condition is a surge following the breaking of a short circuit. With the relations existing on overhead lines, between LC and R one is not likely to get more than 3 to 4 times normal voltage. It is well to estimate the surge for a short circuit midway the line, and use the factor of safety thus indicated, bearing in mind, as a favoring factor, the fact that the arc from a short circuit softens the suddenness of the break, and lets down the current. The worst cases will be met on underground systems, and it is worth noticing that for a given amount of energy transmitted the higher the voltage the less the current, and the less the voltage rise due to interrupting that current. On the other hand, near the highest voltages now in use there is a tendency to trench on the factors of safety in insulation.

We have now investigated all the important factors that enter into the design of a transmission line, whether for direct or alternating currents. Let us review them with the idea of seeing how they enter into practical cases. First comes the all-important question of initial voltage, involving the choice between the direct generation of the working pressure or its derivation from transformers, if alternating currents are used.

* Trans. A. I. E. E., March, 1902, and June, 1905.

We have already seen the practical limitations of voltage for direct currents. With alternators the commutator troubles are absent, and the limitations are those imposed by generator design. The higher the voltage of a dynamo, the more space on the armature must be allowed for insulation, thereby cutting down the output of the machine. Hence the practicable voltage depends on the size of the generator.

In a general discussion it is difficult to make exact statements as to what can or cannot be done, but experience seems to show that at present 10,000 to 13,500 volts are the greatest pressures that can economically be derived from the generator, even in very large units, while in units of 100 or 200 KW it is seldom advisable to go above 3,000 to 5,000. Higher voltage than this has been attempted, but there is good reason to believe that, except in very large machines, the loss due to increased space required for insulation outweighs the possible gains.

As to loss in the line, much has been said already, and the best advice that can be given is to make a few trial computations along the general lines indicated. Almost every case will require special treatment in certain particulars, depending on the conditions of service. For example, a common complication is the supply of power or light, or both, at a point perhaps half-way along the line. Then, according to the amount and kind of service, it may be desirable simply to tap the line for power and use a motor generator for lights, to establish a substation with regulating apparatus, to compound the generator for the point in question and use either of the above methods at the end of the line, to install rotary transformers, or to run a separate line with regulators at the generating station. Such details will be treated at length later.

The line structure is generally of bare copper wire carried on strong wooden poles. Do not put it underground unless you have to do so for reasons now obvious. It may be necessary to insulate portions of the wire, but it is best not to put much faith in an insulating covering. Instead, it is desirable to make a very thorough job of insulation at the supports, and provide for the easy inspection of the line.

In using alternating currents, inductance in the line must always be considered. Practically it means raising the voltage of the generator or raising transformers, unless a fair part of the load is in synchronous motors which can be employed to counteract the inductive drop. In nearly every case its real importance is small, in spite of its scaring the uninitiated now and then.

So, too, with the inductive load. Its real effect is merely to increase the current in the line by a small amount, usually less than 20 per cent, and to demand increase of excitation at the dynamo. If this is so designed as to regulate badly, an inductive load will render it difficult or impossible to keep a uniform voltage. On the other hand, a generator capable of holding its voltage from no load to a full and inductive load with an increase of only 10 or 15 per cent in the exciting current, will usually give no trouble whatever with reasonable attention to the regulators.

The total net result of inductance in line and load is to call for a well-designed generator with good inherent regulation and a reasonable margin of capacity. One who knowingly installs anything else deserves all the troubles that inductance can produce.

Rise in voltage, on throwing off the load or through distortion of the current wave by an inductive load, can be reduced to insignificance by employing a proper generator, as just noted. Aside from this, a mixed load, particularly if it consists in part of synchronous motors, seldom has a bad power factor or great and sudden changes in its amount. Exception must here be made with respect to the constant current transformer systems exploited of late in connection with series alternating arc lamps. These, unless fully loaded, give a severely inductive load, and must be thrown upon the circuit very carefully to avoid serious fluctuations of voltage.

As regards static disturbances, few overhead systems have capacity enough to give cause for alarm. Difficulties are to be looked for chiefly on very long lines, and those composed in part of underground or submarine cables. In these cases one may sometimes know the conditions well enough to calculate the actual result in rise of voltage. More often the

data are incomplete, and the simplest way out of the difficulty is to try the effect of varying the capacity of the system before it goes into regular operation. If the addition of a condenser, say of one-third microfarad, makes a sharp variation in the voltage, look out for resonance and investigate the capacity of the system, step by step. A change of capacity or inductance can be made sufficient to avert any serious danger of resonance under ordinary conditions. Resonance chargeable to the variation of harmonics under changes of load and to changes in inductance and capacity due to apparatus used on the system, is hard to foresee, and must be treated symptomatically when it chances to appear.

In the practical computation of a line, the question of allowable drop is generally settled by the regulation desired. Too much loss makes it impossible to give good service, and a loss at full load of 10 to 15 per cent in the line and transformers is about as much as can be endured, save on very long lines where one has to make a virtue of necessity. Eight or ten per cent loss in the line proper is a common figure unless power commands a very high price, or a limited source must be fully utilized. As to voltage, 2,000 to 3,000 is the maximum which can conveniently be used in a general distribution without step-down transformers. Hence many little plants sending power only two or three miles use such voltage.

For serious transmission work, nothing less than 10,000 volts is worth considering. For 10,000 to 14,000 volts excellent high-voltage generators are available, and save something in cost and efficiency. Roughly one can say that the use of the high-voltage generator saves about \$6 per kilowatt transmitted. On going to a higher voltage with transformers then one must be able to save \$6 per KW in the line out of the cost for the line at 10,000 to 12,000 volts, in order to make the change worth the while. For any proposed voltage and distance one can readily settle the economics of the question. The nominal saving of \$6 should, however, be verified for the machines and equipment considered, since prices of generators sometimes vary very irregularly. Let us suppose, for example, that we are investigating the advisability of using 12,500 volts

from the generator or 25,000 from raising transformers. The latter will save 75 per cent of the copper required by the former, which for equality should cost \$6. The two schemes will then be equal in cost at a distance for which the lower voltage demands \$8 per KW for copper, the percentage losses being taken as the same. Now reduce the total copper cost to pounds, insert in equation (5), page 510, and solve for D_m , or put the total cost in (6) and solve for D_m .

With 15 cent copper, 1,000 KW, and 10 per cent loss, the critical distance is just over 5 miles. With copper at 20 to 25 cents this distance is still further reduced, and most plants demand high voltage. In general, there will be few transmissions of half a dozen miles in which it will not pay to raise the voltage and install transformers. But in any case where one for any reason does not wish to go to the neighborhood of 20,000 volts on the line, the high-voltage generator is preferable.

In leaving generator voltage, therefore, go to at least 20,000 volts and preferably to 30,000. Above that there should be more caution in examining adverse conditions; but with a reasonably good climate and topography, 40,000 to 60,000 volts are entirely practicable pressures, and in a few years we shall probably be working at 80,000 to 100,000.

Voltage and loss being settled, the next thing is to lay out the line conductors, following the copper formulæ already given. Then with the approximate dimensions found, construct the regulation diagram, and plan in so far as may be the load to aid the regulation. It is seldom that you cannot find at least one big synchronous machine, the excitation of which can be controlled. On very long lines look out especially for the effects of capacity at light loads. Sometimes a few large induction motors steadily loaded prove good counter irritants. With the load roughly blocked out, look into the conditions of resonance, surging, and so forth, and plan the insulation precautions, keeping a special eye on cables and their junctions to aerial lines.

CHAPTER XIV.

LINE CONSTRUCTION.

THE first consideration is the general question of location. Other things being equal, it is obvious that a direct line is the best, but as a matter of fact it is seldom altogether practicable. A line must above all things be secure against interruptions, and with this in view, both the location and the constructional features should be determined.

In smooth and easy country, a nearly straight line can usually be laid out. For large plants carrying large amounts of power at high voltages, it is often desirable to buy the right of way outright. Such has mainly been the policy pursued in the transmission from Niagara to Buffalo, and, while expensive, it gives an absolute command of the situation. In some States electric light and power companies are given the right of eminent domain to make such ownership possible.

In cases wherein the purchase of such a location is impracticable or would, as often happens, involve very serious expense, the best thing is to secure right of way along the public roads, so far as they can be conveniently utilized, and right of way for the pole line through such private property as may be in the contemplated route. Rights along the public roads are very desirable, as giving capital facilities for line inspection and repair without added expense. It is well, in addition to securing rights from the local governing body, to establish friendly relations with the abutters and to secure a definite understanding as to interference with trees, proximity to buildings, and the like. Right of way merely for the line across private lands, with proper facilities for access, can generally be cheaply secured. Many owners are public-spirited enough to give it for the asking, or for very reasonable compensation, when a strip of land has to be taken for a roadway.

In small transmissions the public roads are most desirable as a route, using private lands only for occasional shorts cuts.

Since a good road along the pole line is highly desirable, the route should be taken through clear and accessible country, so far as is possible.

Places to be avoided when possible, even by a detour, are marshes, where poles are always hard to set and maintain, and roads are difficult to construct; heavily wooded country, where there is constant danger to the line from falling branches and the like; and rough rocky slopes, where construction is difficult, and the line, when constructed, is highly inaccessible. Sometimes the topographical conditions are such that these difficulties have to be met, but they are always serious.

In a wooded region the only proper plan is to secure right of way broad enough to permit clearing away the trees so that they cannot interfere with the line wires, even were branches to be blown off in a storm. Nothing short of a hurricane sufficient to blow down large trees should possibly be able to cause trouble; and when the neighboring trees are dangerously high, careful watch should be kept, and any weak or decaying tree at once cut down. The right of way may be somewhat expensive, but the service must not be liable to interruption by so probable a thing as the breaking of a branch. It must be remembered that in high-voltage transmissions a twig as big as a lead-pencil may, by falling across the line, start an arc that will shut down the plant. Sometimes the use of extra long poles may enable one to carry the wires clear of possible obstructions of this sort.

In mountainous regions poles may have to be set in very bad locations, and sometimes for long stretches every hole may have to be blasted at a cost of \$5 to \$10 per hole, but such contingencies are not very common, and may often be avoided by a moderate detour. It is better to go around a mountain than over it, unless the distance is considerably greater. When these questions arise they should be answered by preliminary estimates. The country should be carefully inspected and the relative costs of various routes looked into. For a uniform country the cost of poles and construction is directly as the distance, and the cost of copper directly as the square of the distance.

In case the direct line leads into difficult country — over, for example, a rocky hill where the poles would be hard to place and much blasting would have to be done — a detour often may cheapen construction. A brief computation will give the facts. Suppose a 10-mile transmission of about 500 KW at 10,000 volts, for simplicity assumed to be on the monophase system. The line would have to be about No. 0 wire for, say, 6 per cent loss, and the total weight of copper would be about 33,000 lbs. Suppose the average cost of poles and insulators in position to be \$5 in the open country, but that the direct route lies for a mile over a rough hill, where holes would have to be blasted and poles would be difficult to place. The extra cost of this mile might readily be \$500 to \$600. Now if a deviation of a mile would clear this hill, it would probably pay to abandon the direct route. By taking the shortest available course, the actual increase in the length of the route would probably not exceed half a mile. This would increase the weight of copper for the same loss by about 10 per cent, \$495 at 15c. per lb., and would increase the cost of the pole line by about \$250 more. In such a case the increased accessibility of the line, and the lessened cost of providing a road for inspection and repairs, would more than compensate for the small difference in expense.

The same reasoning holds with respect to avoiding other obstacles by making detours. It often pays to go somewhat out of the way to utilize the public roads, to cross rivers on existing bridges, and so forth. A few experiments on the route constructed on paper, after careful inspection of the country, will usually show the most advantageous line to follow. The old and simple process of sticking pins in the map and following up the line with thread is generally the easiest way of getting the approximate distances.

In mountainous country a direct line is often out of the question, and the line has to conform to existing trails with such shorts cuts as may be possible. An occasional long span will sometimes lessen the cost of the line materially. Rivers and lakes often form very serious obstacles to line construction and call for much skilful engineering. The former can often be crossed on existing bridges or by long spans, which

will be discussed later, but the latter usually have to be gone around, although sometimes cables may have to be carried under water, or long suspension spans erected carrying the conductors clear across. The latter plan is preferable in most cases, and a cable should be taken only as a last resort, unless in the rare case of the obstacle being near one end of the line, so that the cable may be for the originating or the receiving voltage.

Nearly all long lines have to encounter more or less serious obstacles of the sorts mentioned, and as a rule they cause considerable deflections from a straight course. Sometimes deviations are desirable merely as the cheapest way of reaching *en route* localities where power is to be distributed, a matter which a few trial computations will settle.

LINE WIRE.

As already mentioned, copper is the best and most usual material for conductors; soft-drawn copper under ordinary circumstances, hard-drawn when extra strength is desirable. No other material gives so advantageous a combination of conductivity and tensile strength for nearly all purposes. The tensile strength of the copper is raised by hard drawing from about 34,000 to 35,000 lbs. per square inch to 60,000 or even 70,000, and the resistance is only raised 2 to 4 per cent, the latter amount only in small sizes. Often a medium hard-drawn

Gauge B. & S.	Diameter Mils.	Area Circu- lar Mils.	Wt., Lbs., per 1,000 Feet.	Tensile Strength (Ultimate) Based on 34,000 Lbs. per Sq. In.	Permissible Tension with Factor of Safety 5.
0000	460,000	211,600	640.73	5,640	1,128
000	409,640	167,805	508.12	4,480	896
00	364,800	133,079	402.97	3,553	711
0	324,950	105,592	319.74	2,819	564
1	289,300	83,684	253.43	2,235	447
2	257,630	66,373	200.88	1,772	344
3	229,420	52,633	159.38	1,405	281
4	204,310	41,742	126.40	1,114	223
5	181,940	33,102	100.23	884	177
6	162,020	26,250	79.49	700	140
7	144,280	20,816	63.03	556	111
8	128,490	16,509	49.99	440	88

wire is used having a tensile strength of, say, 45,000 to 50,000 lbs. per square inch. Such wire is materially stronger than the annealed wire, and yet is much easier to handle than such hard-drawn wire as is used for trolley wires.

For line copper the wire should be free from scale, flaws, seams, and other mechanical imperfections. It should be very close to its nominal gauge, variations of 1 to 2 mils being the largest which should be tolerated, and should be within 2 per cent or less of standard conductivity, as given for pure copper in tables of wire.

The foregoing table gives the standard mechanical constants of the sizes of wire commonly used in power transmission work.

The various constants should none of them fall short of these tabulated values by more than 2 per cent.

For hard-drawn copper wire the tensile strength should not fall short of 1.75 times the values given for annealed wire, save in case of wires intentionally drawn only to medium hardness, in which case the factor is generally about 1.5. Medium hard-drawn copper is strongly to be recommended for transmission work, and has to a great extent replaced ordinary soft-drawn copper. The elastic limit of hard-drawn copper wire ranges from 30,000 to 40,000 lbs. per square inch according to the nature of the drawing.

When in use, wire is subject to serious mechanical strains, due in the first place to its weight and normal tension, second to variations in tension by change of temperature, and third to extraneous loads like ice and wind pressure, separately or combined. These last-mentioned strains are sometimes formidable and must be carefully taken into account, particularly in cold climates.

When a wire is suspended freely between supports, it takes a curve known technically as the catenary. The exact solution

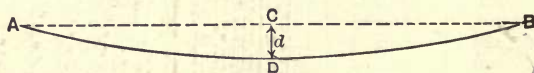

FIG. 264.

of its properties is very difficult, but for the case in hand the catenary comes very close to the parabola, a much simpler curve to compute; and based on this approximation the follow-

ing simple deductions can be made: If a wire be stretched between points *A* and *B*, Fig. 264, it assumes the curve *A D B*. The thing to be determined is the relation between the length *A B* (which we may call *L*, the length of span), the vertical deflection *d*, at the middle point of the span, and the tension on the wire at *A* or *B* as a function of its weight. This relation is as follows:

$$T = \frac{L^2 w}{8 d};$$

or transposing,

$$d = \frac{L^2 w}{8 T}.$$

Here *L* is the length of the span in feet, *d* the central deflection in feet, *w* the weight of the wire in pounds per foot, and *T* the maximum tension on the wire in pounds.

These equations show that with a given wire the tension varies inversely as the deflection for a given span, and that for a given tension and wire, the deflection must increase with the square of the span. Obviously, shortening the span and increasing the deflection eases the strain on wire and renders the construction more secure, but shortening the span adds considerably to the cost, and increasing the deflection increases the danger of the wires swinging in the wind and touching each other. To prevent this, the deflection should not much exceed twice the horizontal distance between wires.

The application of the formulæ can be shown by an example. Suppose we are stringing No. 00 wire on poles 100 ft. apart. What is the least deflection allowable with a factor of safety of 4? This means that *T* must not exceed one-fourth the breaking strain of the wire, which fraction from the table is 888 lbs. The weight per foot from the table is .4 lb. Substituting in equation (2) we have:

$$d = \frac{(100)^2 \times .4}{8 \times 888} = .57 \text{ foot} = 6.8 \text{ inches.}$$

This minimum deflection should not be exceeded in this case, and hence must be applicable to the lowest temperature to which the line is to be exposed. At whatever temperature the wire is strung, enough deflection should be allowed so that,

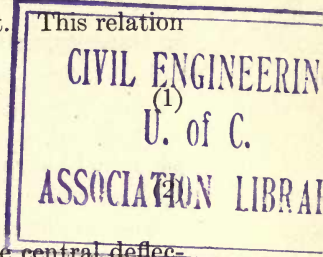

as the wire contracts in cold weather, the above minimum should not be passed.

The total length of wire in the catenary is approximately

$$L^1 = L + \frac{8d^2}{3L}; \quad (3)$$

or transposing for the value of d ,

$$d = \sqrt{\frac{3L(L^1 - L)}{8}}, \quad (4)$$

wherein L^1 is the actual length of wire, and L the span.

From these formulæ we can figure d for any temperature.

The coefficient of expansion of copper is .0000095 of its length per degree Fahrenheit, so that we can get at once the length for any temperature.

If the wire we are considering is strung at 75° F. and is to encounter a minimum temperature of - 5° F., enough deflection must be allowed at the former temperature to bring the deflection at - 5° F. to the value just obtained. The length of wire at the lower temperature is from (3),

$$L^1 = 100 + \frac{8(.57)^2}{300} = 100.0096.$$

At 75° F. this length would be increased by $100.0086 \times .0000095 \times 80$ ft., and hence the new value of L^1 would be 100.076 ft. The deflection corresponding to this is found from (4) as follows:

$$d = \sqrt{\frac{300 \times .076}{8}} = 1.69 \text{ ft.} = 20.28 \text{ inches.}$$

A large allowance in deflection must, therefore, be made for such variations in temperature as are likely to be encountered in northern climates.

The changes in deflection due to changes of temperature are found in practice to be somewhat lessened by the fact that the wire as strung is under tension due to its weight, which modifies its expansion and contraction. The actual coefficient for copper wire under various tensions has never been properly investigated. It undoubtedly is subject to considerable variations, and .000005 is perhaps a fair approximation.

This matter of temperature is unfortunately not all that must be looked out for. We have fully taken care of the weight of the wire itself, but it is exposed to other and sometimes dangerous forces in the weight of the ice coating that is to be feared in winter, and the strain of wind pressure on the wire either bare or ice-coated.

Taking up these in order, let us suppose the wire to become coated with ice to the thickness of half an inch, quite a possible contingency in severe winter storms. A layer of ice of this thickness would weigh 0.54 lb. per linear foot, thus loading the wire with more than its own weight. Assuming this load at the minimum temperature of -5° for which the assumed deflection was 0.57 ft., the tension of the ice-loaded wire becomes from (1),

$$T = \frac{(100)^2 \times .94}{8 \times .57} = 2,051 \text{ lbs.}$$

This is dangerously large, far beyond the elastic limit of the wire, and more than likely to bring down weak joints.

And beyond this the wind pressure must be considered. This may be taken as acting at right angles to the weight of the wire and adding materially to the resulting total stress. The total pressure P on a wire is, per foot, approximately $P = .05 p D$, where p is the normal pressure of the wind per square foot, and D is the diameter of the wire in inches. p varies from a few ounces per square foot in light breezes to 40 or 50 lbs. in a hurricane.

Assuming 40 lbs. as the greatest pressure likely to be encountered, we can at once find its effect on the line under consideration. For our No. 00 wire,

$$P = .05 \times 40 \times .364 = .728 \text{ lbs.}$$

This pressure is combined with the weight of the wire as a force acting at right angles; hence the resultant stress, which we may call W , is

$$W = \sqrt{w^2 + P^2} = \sqrt{(.4)^2 + (.728)^2} = .83.$$

This, from the example given, is obviously a dangerous strain on the wire. But the combination of even half the normal wind pressure just assumed with an ice-coated wire would be

disastrous. Taking the ice as half an inch thick as before,

$$D = 1.36 \quad P = .05 \times 20 \times 1.36 = 1.36,$$

and

$$W = \sqrt{(.94)^2 + (1.36)^2} = 1.65.$$

Substituting in (1),

$$T = \frac{(100)^2 \times 1.65}{8 \times .57} = 3,618 \text{ lbs.}$$

This is over the breaking weight of the wire, which must consequently give way, and would almost infallibly wreck the line in so doing. This means that the factor of safety of 4, assumed at the start, is too small for due security. It is sufficient for a moderate climate, where high winds are rare, but 5 is generally preferable, while 7 or 8 should be used in cold and exposed regions. It must be remembered that joints are weak points in the wire; a carefully soldered Western Union joint has only about 85 per cent the strength of the wire. Fortunately, transmission lines seldom accumulate half an inch of ice. One-quarter of an inch is an unusually thick coating, and with very high-tension lines there seems to be a tendency to check the formation of a sleety covering. For extreme tensions a stranded conductor of hard-drawn copper is advisable as being more reliable than a single wire, and possessing a much higher available elastic limit.

The same process that served to take account of an ice coating, *i.e.*, adding the distributed load to the weight of the wire, can be readily applied to finding conditions of safety in the use of bearer wires carrying the conductor suspended from them.

An interesting corollary to these computations is finding the maximum length of span which can safely be used in an emergency such as crossing a river or cañon. Suppose we use simply hard-drawn copper wire of the same size as before. Its ultimate tenacity is about 6,270 lbs. Using it with a factor of safety of 6, the permissible value of T becomes 1,045 lbs. W is as before 0.4 lb., and we will assume that for the purpose in hand the wires are spread and the deflection is permitted to be 10 ft. From (1) we have for the permissible length of span

$$L = \sqrt{\frac{8Td}{W}}. \quad (5)$$

Substituting the above values of the known quantities, we have

$$L = \sqrt{\frac{8 \times 1045 \times 10}{.4}} = 457 + \text{feet.}$$

Ten, however, is a preferable factor of safety, which corresponds to a length of span of 354 ft. In extreme cases a bearer of steel cable may be used, of the highest available tenacity, and carrying the copper line wire to secure the requisite conductivity, or a steel or silicon bronze wire may be used alone; the conductivity being made up elsewhere in the line to the desired general average. The steel is rather the more reliable of the two, but is more likely to deteriorate through rusting. An ultimate tenacity of 150,000 lbs. per square inch is the limit for either material, with factor of safety of 10 for practical working.

Now assuming No. 00 silicon bronze or its equivalent in steel cable and the same factor of safety as before, the working tension rises to 2,612 lbs., and allowing 20 ft. deflection, the possible length of span is

$$L = \sqrt{\frac{8 \times 2612 \times 20}{.4}} = 1,022 + \text{feet.}$$

Spans of even this length can be managed without any very elaborate terminal supports. When the line wires are heavy and numerous, or longer spans must be used, it may be necessary to use stout bearer cables, arranged like a rudimentary suspension bridge with a footpath, to facilitate inspection and care of the conductors. The expense of such a structure is sometimes justified by enabling one to avoid long and expensive detours. When a simple long span of conductors is used, the support of the ends and the proper insulation of the tense wires require care. A timber truss well guyed will answer in most cases, and the strain may be distributed among several stout insulators. The conductors should always be in duplicate across such a span. Increasing the deflection is the simplest and most effective way of securing a proper factor of safety in the conductors. Line construction for power transmission was originally patterned after the construction usual with telephone and telegraph wires, and followed with little modification in early electric light plants. The spacing of the poles

follows the precedent established for poles loaded with cross arms and wires strung so close that it was necessary to pull the wires taut to avoid fouling them. There is no reason for using anything but very moderate tensions on lines with the wires spaced 3 to 6 ft. apart.

Of course, to the eye of the old telephone constructor, a line with large deflections looks very slipshod, but actually it is far safer and more desirable than a taut line. From

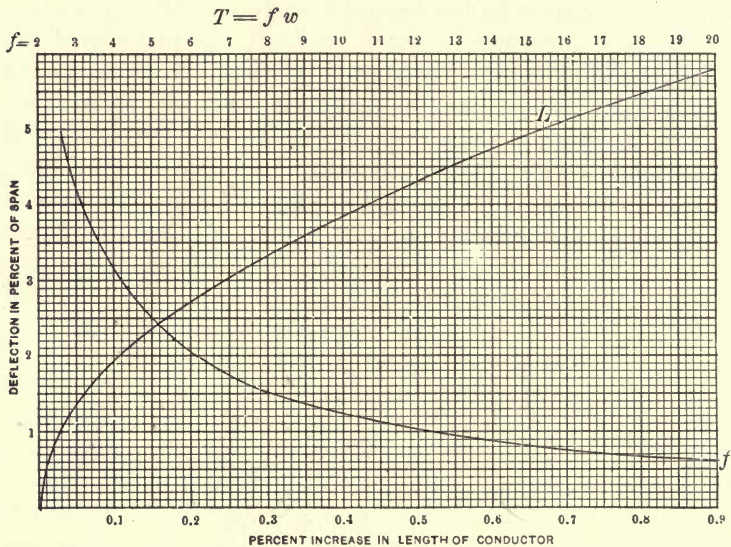

FIG. 265.

the properties of the catenary, it follows that tension increases very rapidly as the deflection decreases, while the length of the conductor between supports changes very little. Fig. 265 shows graphically the relations between the deflection as a fraction of the span, tension in terms of the weight of conductor in the span, and variation in the length of the catenary. It will at once be seen that in reducing the deflection below about 2 per cent of the span length, the tensions increase very rapidly, while the change in the length of the conductor is very trifling, hardly more than a few tenths of a per cent.

It pays, therefore, to use fairly large deflections in all cases

LIBRARY OF
COLUMBIA

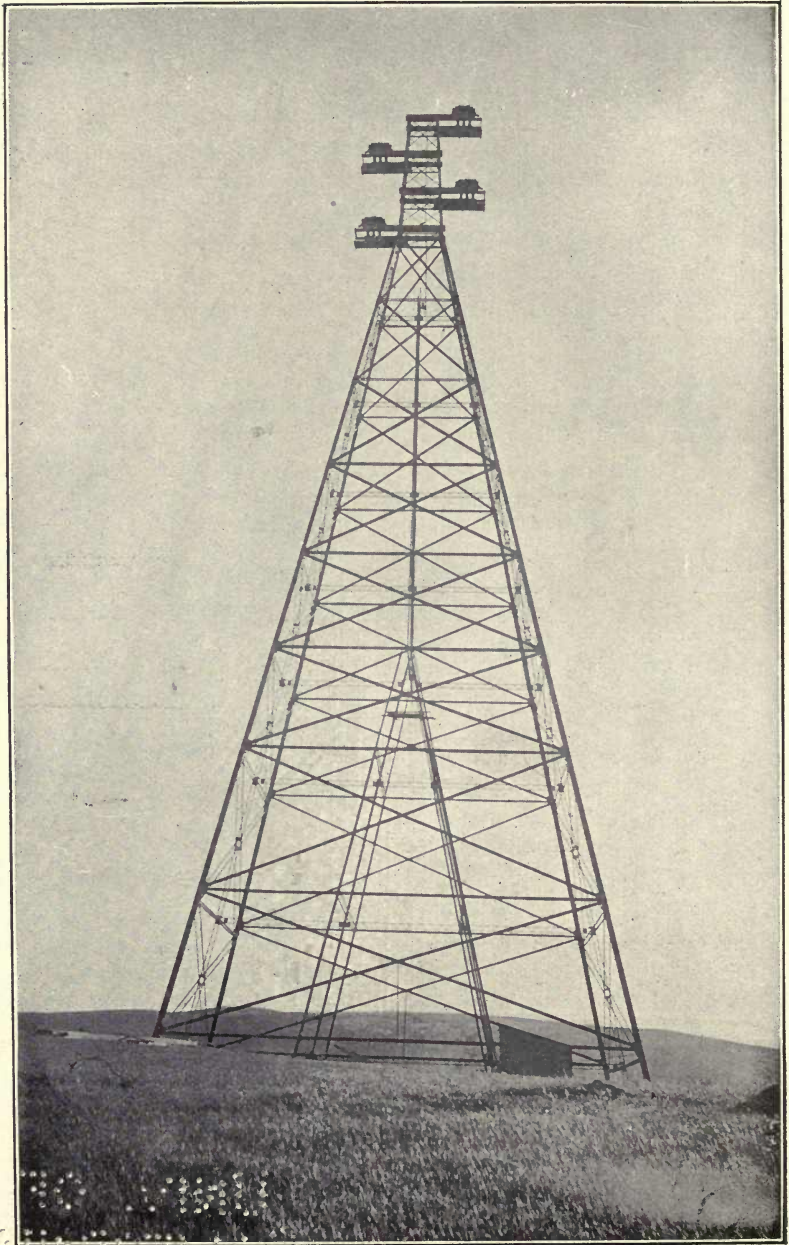

PLATE XXI.

where the line is exposed to severe strains. The curves of Fig. 265 give sufficient data for the solution of most line problems, save in the case of very long spans in which generally copper would not be used, and which demand precise calculation.

One need merely make the span tight enough to avert risk of swinging together, and to keep the wires from being too near the ground at the centre of the catenary. Any more than this is a concession to appearances, harmless enough if not carried too far. Deflections of 2 to 3 per cent of the span at normal temperatures are none too great for most situations.

Bearing in mind that the variation in the length of conductor between supports changes with the temperature to the extent of probably about one one-hundredth per cent for each 20° F. when under strain, one can quickly approximate the variations in the factor of safety from Fig. 265. Of course there are small variations in the strength and elasticity of the wire which might be taken into consideration, but there is so much uncertainty about the actual coefficient of copper wire when changing temperature under strain, that the most one can do is to keep on the safe side, perhaps even to the extent of using the coefficient unreduced for strain, which then amounts to about one-hundredth per cent elongation for 11° F. In the 140-mile transmission of the Bay Counties Power Co. to Oakland, Cal., an extremely long span became necessary in crossing the Straits of Carquinez. The problem was to cross a deep, swift, navigable waterway, 3,200 ft. wide at the narrowest point. Submarine cables were out of the question, and the United States Government required 200 ft. above high-water mark for the lowest point of any suspended structure.

On the north shore, on a point 160 ft. above high water, was erected the skeleton steel tower shown in Plate XXI. On the south shore there was higher land, and a similar tower 65 ft. high sufficed. The construction adopted was that generally used for steel tower work; and each tower bore near its top, four massive wooden out-riggers surmounted by the insulated saddles that carried the weight of the cable spans.

As in suspension bridge work, the cables rest upon rollers upon the saddles, and then extend far shoreward to the anchor-

ages, where the strain is taken. From anchorage to anchorage the span is 6,200 ft. Each cable consists of nineteen strands of steel, galvanized, is seven-eighths of an inch in diameter over all, and has the electrical conductivity of No. 2 copper. The breaking strain of the cable is 98,000 lbs., each span weighs 7,080 lbs., and, as suspended with 100 ft. dip, has a factor of safety of 4.

Two difficult problems of insulation were presented. First, the great weight of the cable must be supported at the saddle

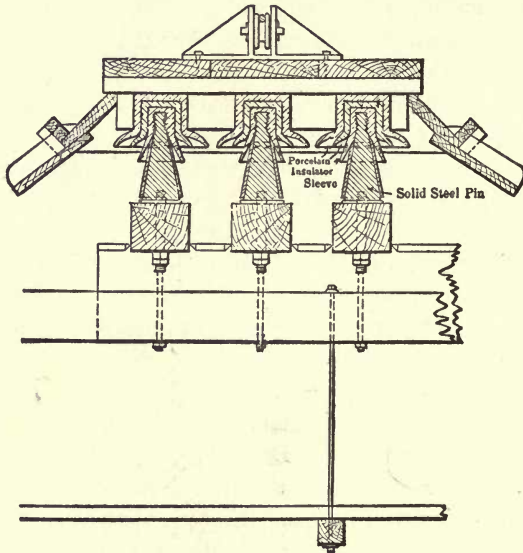

FIG. 266.

with insulation adequate for 60,000 volts. Second, the pull must be taken at the anchorage with equally high insulation. The pull of the cable being 12 tons, the task at the anchorage was by far the more difficult of the two.

At the saddle the weight is taken upon huge triple petticoat porcelain insulators, each built up of four great nested porcelain cups, the inner being filled with sulphur, securing a large steel pin. Six such insulators, each 17 in. in diameter over the outer petticoat, cooperate to sustain the pressure at each saddle. Fig. 266 shows a cross section through insulators, supports, frame, and saddle. The heads of the insulators are

built into a timber platform which serves at once as a rain shed and a base for the cast-iron saddle proper. This carries in line five steel grooved sheaves over which the cable passes. Fig. 267 shows the structure in longitudinal section, together with the suspended platform beneath it, for ease of access.

The strain insulators for the anchorage are of highly ingenious construction. Micanite seemed to be the only insulating substance possessing the necessary mechanical strength, and to prevent surface leakage across it the surface exposed to

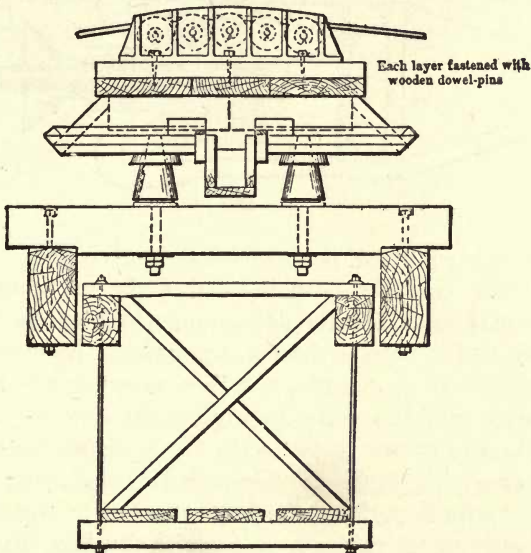

FIG. 267.

leakage was enclosed in an oil tank. Fig. 268 shows the structure of the completed insulator more plainly than description. Two of these insulators are put in series and enclosed in a shelter shed to keep off water, for each cable, the pair being secured to a long tie rod anchored in a massive bed of concrete.

Great care was taken in all the details of the structure to secure all the insulation practicable, even the timber outriggers carrying the saddle insulators being filled and varnished, and the foundation timbers proper being boiled in paraffin. The use of four cables gives one reserve conductor in case of accident. The total length of the span from tower to tower

is 4,427 ft., $2\frac{3}{4}$ times the span of the Brooklyn Bridge. It is one of the most striking engineering feats in the records of electrical power transmission, and has withstood successfully very severe tests.

Such structures are necessarily costly, but they are more reliable than submarine cables and cheaper than long detours. It should be noted that the deflection of the cables is over 2 per cent of the span length, and that even so the factor of

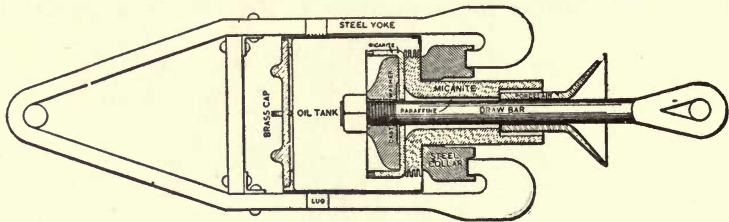

FIG. 268.

safety is not so great as is generally advisable. But this merely means that the span is nearing the maximum length advisable without a greater deflection, which could well have been given had it been necessary, by making the towers somewhat higher. It represents a rather extreme but necessary construction, and has done its work admirably.

When bodies of water too wide for a suspended structure must be crossed, there is trouble ahead. In marshy shallows a timber trestle is perhaps the best way out of the difficulty, but in deeper water cables may occasionally have to be used, although rarely in view of the possibilities of very long spans like the one just mentioned.

Cables can be obtained that will stand 5,000 to 10,000 volts alternating current under water with a fair factor of safety. Above this pressure success is problematical. Near the ends of the line before the raising or after the reducing transformers, cables may be successfully used; but when the obstacle is in the middle of a long line, the choice is between evils, reducing the pressure locally by an extra transformation, or going the long way around. Either expedient is costly and to be avoided if possible. It is almost needless to say that when cables are used they should be in duplicate.

POLES.

As a rule, all aerial lines in this country are carried on wooden poles. Iron poles are used much for railroad work, and abroad considerably for miscellaneous work, including power transmission.

GENERAL DIMENSIONS OF POLES.

Total Length in Feet.	Diameter at Top—Inches.	Diameter 6' from Butt, in Inches.	Depth of Setting	Approximate Weight, in Pounds.	Number that Can Be Loaded on a Pair of Cars.
35	7½	12½	5' 6"	650	90
40	7½	13	6'	900	75
45	8	14	6' 6"	1,000	65
50	8	16	7'	1,300	50

In the eastern and central parts of the United States, white Northern cedar, chestnut, and Northern pine are the most desirable woods for poles, in the order named. West of the Rocky Mountains, redwood is a favorite, and stands even ahead of cedar in estimation. Abroad, Norway fir is highly valued.

For power transmission work the poles should be both long and strong—long to carry the wires well out of reach and often above other circuits; strong to stand the pressure of the often heavy wires and the wind. In open country the length is less important, and it is sometimes well to use rather stubby poles, say not over 35 ft., but extra stout. The poles should be straight and free from knots, of sound, live wood, and the bark should be peeled and the poles trimmed and shaved.

The foregoing table gives the size and other characteristics of the poles most likely to be used on power transmission work. This is based on cedar poles, and the dimensions given are the minimum to be permitted in first-class line construction. Pine and redwood and chestnut are somewhat lighter than poles of the weight given. For the best utilization of the lumber, the top diameter of the pole should be about $\frac{2}{3}$ of the diameter at the ground. Natural cedar poles commonly show rather more taper than this, natural chestnut poles rather less.

It will be noted that poles of these lengths have generally to be carried on two cars, one being too short. Various preservative processes are used to increase the life of wooden poles. Of these, "creosoting" is generally preferred. The process consists of stowing the poles in an air-tight iron retort, treating with dry steam for several hours, and then forcing in the preservative fluid, preferably tar oil from coke ovens, under heavy hydraulic pressure. Creosoting is more effective on open-grained timber than on harder woods, and when properly performed will give a pole life three or four times longer than if untreated. The process does not weaken the wood unless the preliminary steaming is at too high temperature or too long continued. Cross arms, pins, and the like are best treated by the vacuum process at a moderate temperature.

When not specially treated, the poles should be coated heavily with pitch, tar, or asphalt on the portion to be buried up to and fairly above the ground level.

The pole top is usually wedge-shaped or pyramidal, and this roof should be painted or tarred. Before the pole is erected, the gains for the cross arms are cut, and the cross arms themselves should be bolted in place and the pins set for the insulators. The upper cross arm centre should be 10 to 18 inches below the extreme apex of the pole, and the lower cross arms 18 to 36 inches further down. In power transmission work employing heavy wires, the spacing of the cross arms should be guided by the arrangement of the circuits, there being no standard practice.

The cross arms themselves are of wood, having the same characteristics of strength and durability as the poles; hard yellow pine being rather a favorite. They are, of course, of such length as the work demands; in power work, generally from 4 to 8 ft. There are two sectional dimensions in common use, $4\frac{1}{2} \times 3\frac{3}{4}$ in., and $4\frac{3}{4} \times 3\frac{3}{4}$ in., also a 4×5 in. section for heavy work. The latter should be used for the longer cross arms and those carrying heavy cables or the like, while the former serve for 4 or 5 ft. arms not heavily loaded. The cross arms are best secured in their gains by a strong iron bolt passing through both the pole and the cross arms in a hole bored to fit, and set up hard with wide washers under head and nut. This construc-

tion makes a cleaner job than the practice of fastening the cross arm with two lag screws, and permits of easier changes and repairs. The bolt should be about three-quarters of an inch in diameter, and the gain is from 1 to 2 in. deep, according to the size of the pole. Lag screws are cheaper, however, and are, as a rule, employed in ordinary work. Cross arms 6 ft. long or more should be braced.

In ordinary transmission circuits about 50 poles per mile are used, 110 ft. apart, or 48 per mile, being a common spacing. The setting should be carefully done. The earth should not be disturbed more than enough to make easy room for the pole, and the earth and gravel filled in around the pole should be heavily tamped. When setting poles in soft ground, it is sometimes impossible to give them stability enough merely by tamping, and the best procedure is to fill in concrete about the pole, using one part of Portland cement to three or four parts of sand and heavy gravel or broken stone.

The stresses to which a pole line is exposed may be classified as follows: 1. The direct weight of the wire and the downward component of the wire tension. 2. Bending moment due to the pull of the wires at turns in the line. 3. Wind pressure on poles and wires. 4. Wind pressure plus ice.

1. In power transmission lines built as has been indicated, the crushing stress is completely negligible. The ultimate resistance against crushing amounts in the woods used for poles to at least 5,000 lbs. per square inch. The ordinary pole, therefore, has a factor of safety of several hundred, and the danger of crushing, even from tense and ice-laden wires, has no real existence.

2. Bending moment is more serious, since the forces acting have a long lever arm. The ultimate effect of this stress is to break the pole, generally near to the surface of the ground, by crushing the fibres on the side next the stress and pulling apart those on the other side. The pull or push necessary to break a round pole by bending is approximately

$$P = \frac{ASR}{4D}, \quad (6)$$

where A is the area of the pole section at the ground, S the

strength per unit area, R the radius at the ground, and D the distance between the ground and the centre of pressure.

For example, take a 40 ft. pole, 13 in. in diameter at the ground. Taking $S = 7,500$ lbs. per square inch and the centre of pressure as 32 ft. above the ground, (6) becomes

$$P = \frac{132 \times 7,500 \times 6.5}{4 \times 12 \times 32} = 4,189 \text{ lbs.}$$

The factor of safety allowed should be never less than 5, and up to 8 or 10 in cases where high winds are to be expected. Square sawed poles are relatively weaker than natural poles, and may be approximately figured by the same formula, taking R as half the side at the ground. The values of S are rather uncertain, but the figure given is about right for the woods customarily used in large sticks. Small samples run relatively higher from being of selected material.

The following table gives the commonly received tensile strengths for the American woods generally used in electric construction, the figures being derived from small samples, and hence to be taken with reservations in the case of poles, while fairly applicable to cross arms and pins.

Wood.	Value of S per square inch.
Cedar	11,000
Chestnut	10,000
Yellow Pine	12,000
Hickory	14,000
Redwood	11,000
White Oak	14,000
Locust	20,000

Practically, poles at angles should always be guyed, like terminal poles. This is best done with a steel rope one-quarter to one-half an inch in diameter, taken from as near the centre of the stress on the pole top as the position of the circuits permits. The guy rope should extend downward at an angle of from 45° to 60° with the pole, directly back from the direction of the pull on the pole, and should be drawn taut and securely fastened to a tree or a firmly set post. Where there are three or

four cross arms, what is known as a *Y* guy is often used, consisting of a guy rope attached near the pole top and another just below the cross arms. These divide the tension and are moored by a single guy rope in the ordinary manner. This arrangement is not commonly needed in transmission work save when the circuits are numerous or the strain exceptionally severe, and in any case great care should be taken to keep the guy wires well clear of the high-voltage lines. Sometimes two or more light guys in different directions are valuable in securing a pole, when proper setting is very difficult, and may save expensive blasting.

The bending moment due to an angle is normally $2 T \cos \frac{\alpha}{2}$ where T is the tension as already determined and α is the angle made between the wires at the turn. For the simple circuit of No. 00 wire already discussed and a turn with 120° between the wires, taking a factor of safety of 7 on the wire, the tension per wire is 507 lbs. The total pull for the two wires forming the circuit is then $2,028 \text{ lbs.} \times \cos 60^\circ = 1,014 \text{ lbs.}$, a pressure rather greater than would be permissible without guying.

3. The wind pressure on the wires has already been computed, and the same formula serves for figuring the pressure on the poles, using the mean diameter in inches, and for the total pressure, multiplying by the feet of pole exposed. For example, assuming a pole of 34 ft. out of ground, 7 in. diameter at the top and 13 in. at the ground, the average diameter is 10 in., and for a storm giving a normal wind pressure of 40 lbs. per square foot,

$$P = .05 \times 40 \times 10 \times 34 = 680 \text{ lbs.}$$

This acts virtually at the middle point of the pole, hence it is equivalent to 340 lbs. at the pole top, to which must be added the pressure on the wire itself, which for the circuit in question amounts to about 145 lbs. more, making a total of 485 lbs. This is well within the safety limit, and would remain so even if there were half a dozen wires instead of two. As 40 lbs. per square foot is an extreme wind pressure, never met in most localities at all, it is safe to say that a well-set line of the poles

assumed, loaded with any power transmission circuit likely to be met in practice, is perfectly secure so far as wind pressure alone is concerned, unless the line is literally struck by a cyclone.

4. The most dangerous stresses on an aërial line come from sleet storms that load the wires with ice, increasing the weight and the lateral thrust due to wind pressure. On rare occasions ice may be formed on wires to the depth of a couple of inches. Such a coating on a No. 00 wire would weigh about 5.9 lbs. per lineal foot. The mere weight of this would produce a tension, assuming $d = 2$ ft., and No. 00 wire as before,

$$T = \frac{(100)^2 \times 6.3}{8 \times 2} = 4,000 \text{ (very nearly),}$$

which is well above the tensile strength of the wire if soft-drawn. Allowing a wind pressure of 20 lbs. per square foot, the pressure on a single span of 100 ft. would be

$$P = .05 \times 20 \times 4 \times 100 = 400 \text{ lbs.}$$

Adding to this 170 lbs. pressure on the pole itself, the total for a single circuit of 2 wires would be 970 lbs. total thrust, which, while high, is not likely to carry down the pole. Even 6 No. 00 wires would give a total thrust of only 2,570 lbs., which is still below the ultimate strength of the pole. The pole line is therefore stronger than the wires. If a line is to stand such extreme stresses, which are far beyond really practical requirements, the only safe plan would be to string hard-drawn wire, shorten the poles and increase the diameter, and guy frequently. As a matter of fact, the insulators and their pins are quite sure to give way before the wires or poles under these extreme stresses, and in most transmission lines are the greatest source of anxiety.

The insulators themselves can be made strong enough to stand the greatest stresses to which they will be subjected, but it is not easy to so support them as to give ample strength without endangering the insulation. The ordinary wooden pin answers well if the circuits are not very heavy or likely to be weighted with ice.

By common consent, locust is the wood best suited for pins,

which for general line work are about 12 ft. long and 2 in. in extreme diameter at the shoulder, below which the pin is cylindrical and $1\frac{1}{2}$ in. in diameter. This fits a hole bored in the cross arm and is secured by a nail driven through arm and pin. The top of the pin is threaded for the insulator to be used. Under extreme forces these pins are liable to break at the shoulder; and for transmission circuits carrying very heavy wire, for long spans, and for cases where special insulators demand extra long pins, a variation of this construction

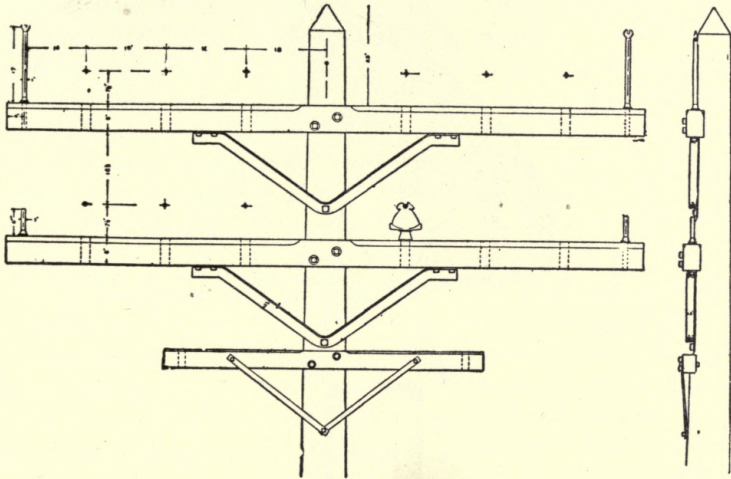

FIG. 269.

is desirable. On the Pacific coast excellent results have been obtained from eucalyptus pins, which are even tougher and stronger than locust, but unfortunately not readily obtainable in the East. Lacking both locust and eucalyptus, a fair pin may be made from seasoned oak. Pins for heavy transmission work may with advantage be made much heavier than ordinary up to $2\frac{1}{2}$ in. at the shoulder and up to 2 in. in the cylindrical base, the standard pin-hole in the corresponding insulators being $1\frac{3}{8}$ in.

In ordinary line work, the pins are set 12 to 14 in. between centres. With heavy wires this distance may advantageously be increased to 18 to 24 in. At very high voltage these distances must be increased farther, perhaps up to 48, 60, or

sometimes to 72 inches and more in dealing with voltages in the uncertain region beyond 50,000 volts.

When the lines have to be transposed, as in long parallel alternating power circuits, this transposition involves some careful work, for the wires must be kept well clear of each other. Heavy strain pins will generally answer the purpose and allow the transposition to be safely made. Such transposition should not be made at an angle or elsewhere where the tension on the insulators is unusually great.

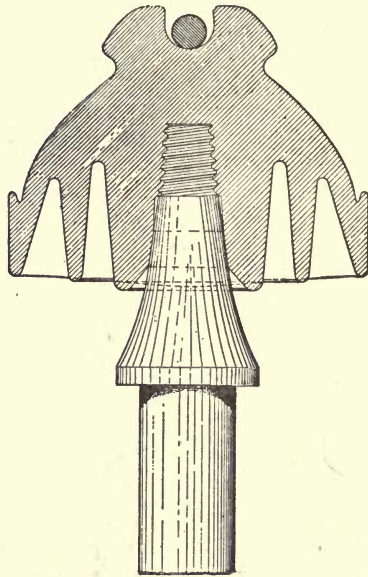

FIG. 270.

A good example of line construction for heavy transmission work is found in the line constructed a few years ago for the Niagara-Buffalo power circuit. Fig. 269 shows the pole head. The cedar poles, intended ultimately to carry 12 cables each of 350,000 c.m., are extra heavy, varying from 35 to 50 feet in length with tops 9 and 10 in. in diameter. The two main cross arms are of yellow pine, 12 ft. long and 4 × 6 in. in section, fastened to the pole with long lag screws, and braced by an angle iron diagonal $\frac{1}{4} \times 2\frac{1}{2}$ in., bolted to the pole and to the bottom of the cross arm at each side. Each side of each

arm is bored for three pins spaced 18 in. apart. The transmission is three-phase, and one complete circuit is on each side of each cross arm. The cross arms themselves are 2 ft. apart.

The pins and insulators, Fig. 270, are special, the pins being much heavier than usual, and the insulators of dense porcelain formed in the usual double petticoat design. They have one peculiar feature: a gutter is formed on the external surface, leading to diametrically opposite lips so placed as to shed dripping water clear of the cross arm, thus lessening the danger of ice formations. Each of the main circuits is designed to transmit 5,000 HP. A short cross arm below the others carries a private telephone line. The right of way is in part owned by the operating company and fenced in, and in part along the Erie Canal. The line is elaborately transposed every five poles to annul induction. So frequent transposition is unusual and generally needless. Transposition every 20 to 40 poles is ample for ordinary cases, and on long lines in open country it is enough to transpose once in a couple of miles.

This line is admirably constructed, but it is a grave question whether all the circuits should be carried on a single pole line on account of the difficulty of executing repairs, and the insulators are rather closer to the cross arms than seems safe in view of the climate and the high voltage to be employed. Certainly at voltages above 10,000 a duplicate pole line is preferable to running two circuits on one pole line. It is, however, entirely feasible to execute repairs on one side of a pole like Fig. 269 while the circuit on the other side is in use, although it is a careful job, and should not be attempted unless, as in this case, the cross arms are unusually long.

Another admirable type of high-tension line construction is found in the lines of the Missouri River Power Co., of which Fig. 271 shows the pole head and detail of pin and insulator construction. This line, it should be said, is 65 miles long, and has been in regular service for four years at 57,000 volts with unusual immunity from interruptions of service.

The poles are of cedar, varying from 35 to 75 ft. according to the necessities of the case, with tops from 9 to 12 in. Poles are normally spaced 110 ft. The cross arms are of Oregon fir, and the pins of oak boiled in paraffin. The insulators are glass,

with an additional glass sleeve surrounding the pin almost down to the cross arm. An especial feature of this system is the use of white oak braces for the cross arms instead of the usual metal, the change being in the interest of insulation between wire and wire.

This principle has been carried still further in the long transmission line from Logan to Ogden and Salt Lake City, Utah, in which case the entire pole construction is wood, the cross arms being mortised through the pole. Locust pins, paraffin-treated, are used of extra length so as to carry the insulators

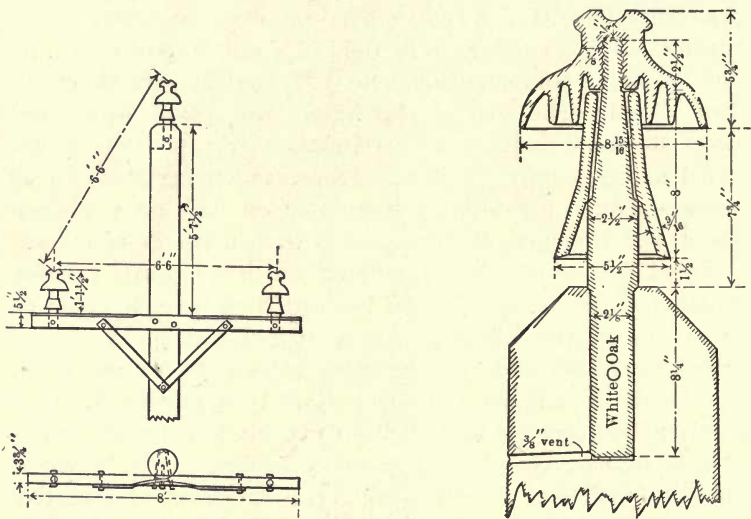

FIG. 271.

well above the cross arm. The change from metal braces and cross arms was made as the result of bitter experience, it having been found that in wet weather these metal parts became the seat of trouble by burning the adjacent wood, especially in case of a broken insulator producing considerable leakage to the cross arm. On the other hand, iron braces and iron or steel pins are in common use on some very large high-voltage systems with apparently excellent results.

At times wooden pins have given much trouble from burning, owing to leaky insulators, and show a strong tendency to "mould" and soften in the thread and at the cross arm. This

has been traced to the action of the brush discharge at high tension, probably setting free nitric acid from the moisture present. In certain localities a combination of moisture and dirty insulators has been very destructive of wooden pins, in one plant causing 26 shut-downs from burning, in a single month. The truth seems to be that untreated or imperfectly treated wood may be rapidly attacked in a moist atmosphere by the discharge at high voltage over dirty insulators. With thoroughly treated wood this difficulty disappears. On the Logan line referred to, the pins are treated as follows. The locust pins are heated with stirring in vats of hot paraffin at 150° C. for 6 to 12 hours, and then are kept submerged during gradual cooling. Thus treated, the paraffin saturates the pins

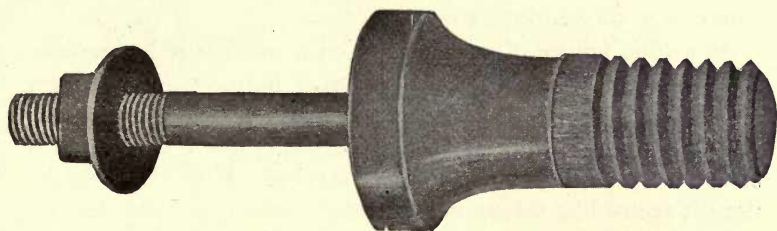

FIG. 272.

clear to the core, and they give practically no trouble from burning or "moulding." There seems to be no good reason why a pin thus treated should not stand up well in almost any climate.

Steel or iron pins, however, are very advantageous in the matter of strength, and give admirable service. They are subject to the difficulty of putting severe strain on the insulator thread if used alone, so that it is desirable to use a lead bushing around the steel pin to furnish the thread, or otherwise to interpose soft material. Steel pins are now made with sleeves of treated wood for the thread portion, and with porcelain sleeves covering the shaft of the pin clear down to the cross arm after the idea of Fig. 271. Such a composite pin is shown in Fig. 272. The wood, of course, may be replaced by lead if anybody objects to wood, and the porcelain sleeve retained.

As between wooden and steel pins, the mechanical advantage when the strains are severe is with the latter, both on account

of intrinsic strength and less weakening of the cross arm on account of smaller diameter. Electrically, the advantage lies on the side of well-treated wood. Either can and does give good service at the highest voltages yet employed.

Much the same sort of question arises as between wooden and iron poles and cross arms. Iron poles are considerably used abroad, although not on such high voltage as is used in the large American systems. They are excellent mechanically, and have a very long life. On the other hand, they cost several times as much as wooden poles and when used with iron cross arms as usual, carry the earth potential squarely up into the interior of the insulator itself. Any failure of the latter means an instantaneous and complete shut-down of the line, which is a very serious contingency.

As a rule, failure of an insulator on a wooden pole line does not do this. It may cause progressive burning and leakage, which gives warning of trouble and eventually may become serious, but often gives ample opportunity for temporary repairs before it puts the line out of service. With these conditions it seems like taking unwarrantable chances in the present state of insulator construction, to replace wooden poles by iron in the ordinary form of line construction.

An altogether different question is raised by the introduction of the tower construction which has been in successful use for a year or so in the Guanajuato transmission plant in Mexico. The plan here followed was to employ steel towers of sufficient height and stability, not only to replace wooden poles but to admit the use of very long spans, thus greatly reducing the number of insulating supports which are by common experience, the weakest points in the line. The tower and tower head is shown in Fig. 273. The structure is a standard 45 ft. galvanized steel windmill tower anchored at each corner to a concrete foundation. The span employed is about 440 ft., the conductors being of hard-drawn copper cable equivalent to No. 1 *B & S*. The deflection in the centre of the span is variously stated at from $7\frac{1}{2}$ to 18 ft. At the former figure, the factor of safety would be less than 3 as regards the ultimate strength of the cable, and less than 2 on the elastic limit. At the latter figure the conductors would be less than 20 ft. above the ground

at the centre of the span. The actual deflection is probably intermediate between the reputed figures.

These towers cost laid down from Chicago between \$60 and \$70 each, and from 9 to 12 would be required per mile. Assembling and erecting amounted to about \$7 each, bringing a con-

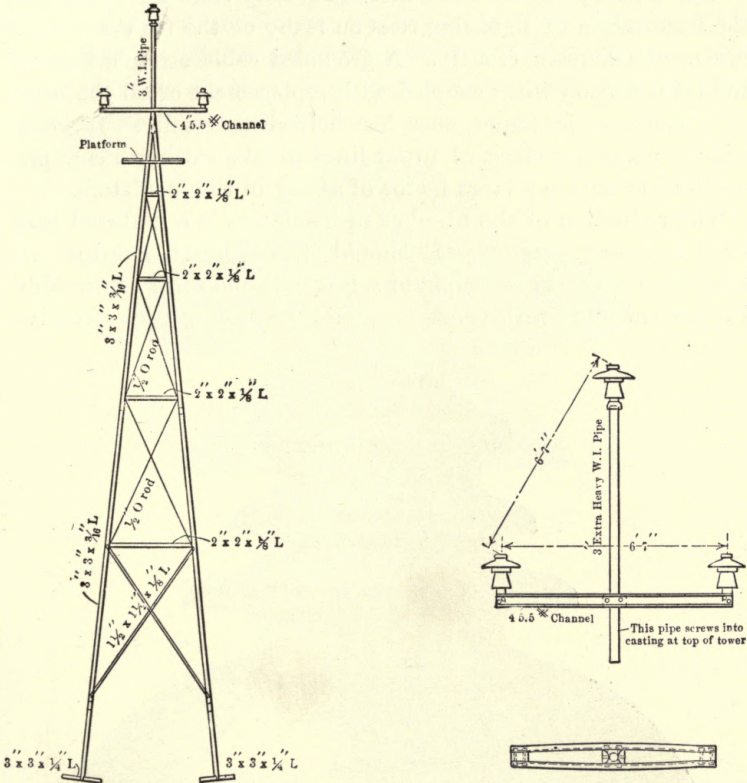

FIG. 273.

servative estimate of the line structure to about \$750 per mile, including insulators.

The construction is a very ingenious one, and possesses great convenience for regions where poles are scarce or where the ravages of insects are to be feared. If constructed, however, with the factors of safety generally to be recommended in overhead lines, the cost would run materially higher than that just

stated, by reason of the use of more or higher towers, to allow shorter spans or more deflection. Employed with caution the plan is mechanically good. Electrically, it is open to the objection to all metal structures of complete dependence on the insulators, in this case subject to more than usual strain.

The Guanajato line has suffered severely from lightning, and the installation of lightning rods on many of the towers did not prove an adequate remedy. A grounded cable stretched above the transmission wires coupled with replacement of all the original insulators by larger ones has helped materially. It would appear necessary on steel tower lines to take extraordinary precautions to ensure a large factor of safety in the insulators.

The reduction of the number of insulators is a material gain over ordinary practice. It should, however, be pointed out that the long-span principle in a less extreme form can readily be carried out with wooden poles, employing conservative

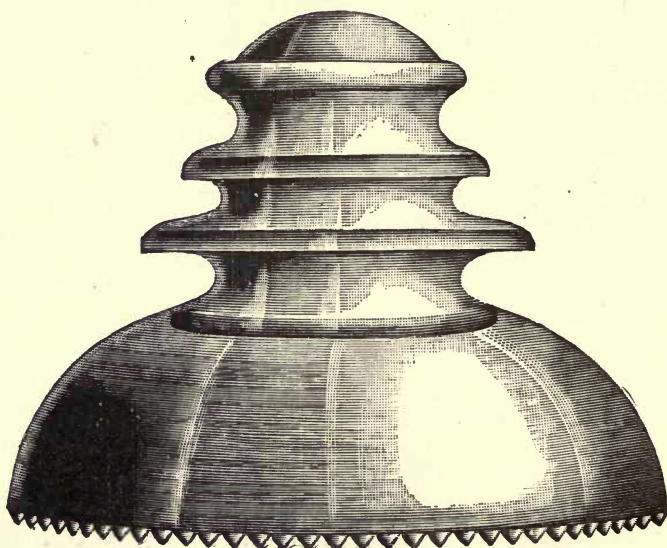

FIG. 274.

factors of safety and still giving a material gain in cost and in the number of insulating supports.

A stout 40 or 45 ft. pole will carry 3 cables, such as are used at

Guanajuato, on a spacing of, say, 20 poles to the mile with a considerable improvement in the factor of safety and at about half the cost of construction under ordinary conditions. The difference in annual charges on the cost is great enough to provide for the replacement of wooden construction every dozen years, even assuming eternal life for the steel.

Barring local conditions, modifying considerably the relative costs, or affording special reasons for discrimination, expense is about a stand-off between the two, save as a low first cost is sometimes important.

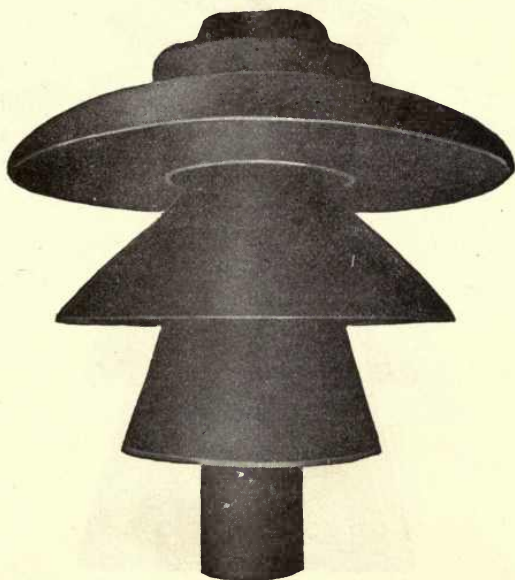

FIG. 275.

Insulators for high-tension work are now generally of porcelain, although glass is being successfully used, as in the Missouri River Power Co. plant just referred to, and in the great Utah system. The form of insulator used in the latter case is shown in Fig. 274. It is only 7 in. in diameter, but with the long paraffined pins and wooden construction there used, it has given good service for half a dozen years past at 40,000 volts.

Porcelain insulators, although more costly than glass and

requiring individual testing, are mechanically stronger, and probably stand weathering more successfully. As has already been indicated, the path of the discharge when an insulator "spills over" is from edge to edge of petticoats and thence to pin or cross arm by the nearest course, so that, irrespective of other things, the insulator must have a long sparking distance if it is to be successful at high voltage. With either glass or first-class well-vitrified porcelain the insulation strength of the material is ample, and insulators rarely fail by puncture unless

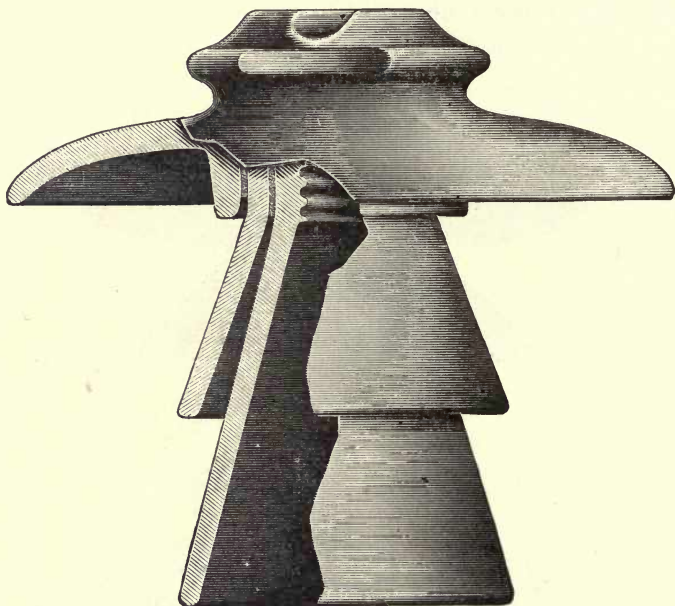

FIG. 276.

mechanically defective.

Fig. 275 shows a typical insulator of the kind used for very high-voltage. It is made in three pieces to insure proper baking of the porcelain, which is difficult in large masses. The diameter of the upper petticoat is 14 in., and the sparking distance is $8\frac{1}{2}$ in. The test voltage is about 150,000 and the line voltage 60,000.

Fig. 276 shows a somewhat different design of about the same dimensions, but with a sparking distance increased to $9\frac{1}{4}$ in. These big insulators are shipped in pieces and cemented when

one is ready to test them prior to installation. Fig. 277 is a somewhat smaller design, intended for 50,000 volt work, with an upper petticoat $11\frac{1}{8}$ in. in diameter and a sparking distance of $6\frac{3}{4}$ in. All these have pin holes $1\frac{3}{8}$ in. in diameter to take an extra heavy pin, either steel with bushing, or wooden. An excellent example of glass insulator for medium voltages, say up to 20,000, is shown in Fig. 278. This is 7 in. in extreme diameter, with a sparking distance of 3 in., and a $1\frac{3}{8}$ in. pin hole like the others. All have top grooves, which are preferable for high voltage.

Now, all these insulators are well made and pretty well de-

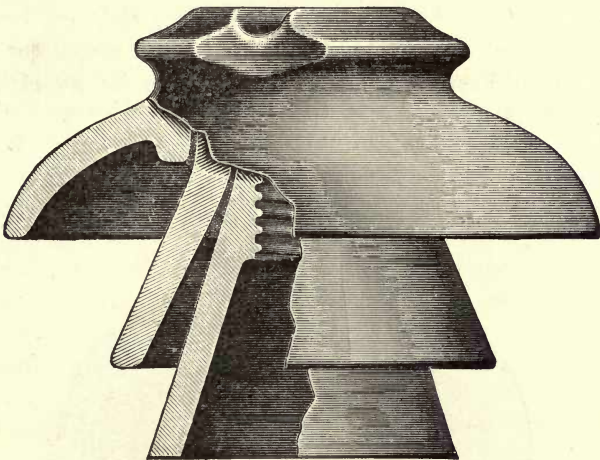

FIG. 277.

signed, and have been used with success, but none of them has a high factor of safety. If one glances at the curve of striking distances already given, it is apparent that the sparking distances for the insulators are for the higher voltage barely twice the possible striking distance of the normal voltage. This is not enough, considering the possible rises of potential due to surging, resonance, and static effects. To increase the size of the insulators means increased difficulty of supporting them, increased cost, and greatly increased difficulty in getting first-class porcelain. A porcelain or glass sleeve over the pin seems a very desirable safety precaution.

The factor of safety, as regards both dielectric strength and sparking distance, should be raised to not less than 3 and preferably higher.

One of the undetermined points in power transmission is the degree of immunity from line troubles which may fairly be called successful operation. All systems suffer more or less, but it seems to be impossible to give actually continuous service at the higher voltages without duplicate lines. One experienced engineer regards the conditions as very good if one per cent of the insulators do not have to be replaced yearly. If the line were of steel poles, cross arms, and pins, this would insure an abundant supply of shut-downs not to be averted unless by a complete duplicate pole line, and not certainly then. In case of a wooden construction, complete failure from broken insulators can nearly always be avoided if a spare line is available.

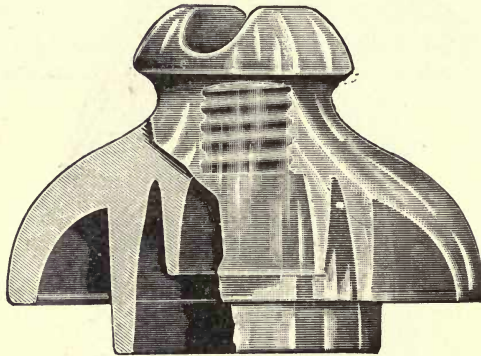

FIG. 273.

All lines alike are liable to be the victims of casual accidents, like branches falling or being blown across the circuit, large birds flying into the wires, lightning, and all sorts of curious and apparently trivial causes.

The chief trouble, however, is in the failure of insulators from one cause or another, and next to that stands lightning.

Lightning, although fortunately not a continuous risk like insulators, is a very dangerous contingency, the more so since no system of defence has proved entirely effective. Lightning,

so far as transmission systems are concerned, is of two sorts. First in danger comes the lightning discharge, which actually strikes, fully or by a branch discharge, the line structure itself. This is, luckily, an unusual happening, but a very serious one. Second comes the induced discharge along the circuit, due to the tremendous effect of a lightning discharge at a greater or less distance. These induced discharges constitute the vast majority of all so-called cases of lightning upon the circuits. They are in effect surges of potential of sometimes very great violence, but never comparable with even a minor direct stroke.

These surges seem to be enormously abrupt, and when checked as by an inductance, their sparking power is somewhat formidable. It is very difficult to form any proper idea of the potentials concerned in an actual lightning stroke, but they run to many millions of volts, probably several hundred millions at times. The induced discharges which make up probably 99 per cent of so-called lightning, are of a very different order of magnitude, but they certainly give rise to sparks having striking distances corresponding to voltages up to considerably above 100,000 volts. The majority of such discharges, however, are of minor violence, but quite sufficient to puncture insulation and cause serious damage to apparatus.

An actual stroke of lightning upon a line is to be dreaded. It frequently shatters insulators and poles, and may break down apparatus as well, especially if near the station. It will sometimes distribute its effect for a quarter mile or so from the striking point, doing more or less damage at every pole. It does not, upon a wooden pole line, necessarily shut down the line, although of course it may do so. A duplicate pole line is the best safeguard against lightning, since it is highly improbable that in a single storm both lines will be hit hard enough to put them out of action.

That component of a direct stroke which follows the lines to the station is like an unusually severe induced surge, and must be dealt with as best one can.

Lightning arresters, so called, are merely devices for giving induced or other discharges an easy path to ground, while checking the tendency of the line current to follow them. They consist essentially of spark gaps connecting the line with a

ground wire and means for checking the following rush of current from the line. In addition, reactive coils are usually placed between the machines and the arresters to check the surge, and throw it over the gaps to earth.

As now generally arranged, lightning arresters consist of a series of short spark gaps between metal cylinders, in series

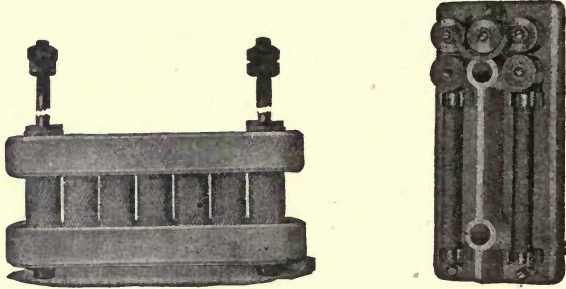

FIG. 279.

with resistance enough to attenuate the following line current sufficiently to allow the arcs across the spark gaps to go out. As the line voltage increases, more and more gaps and more and

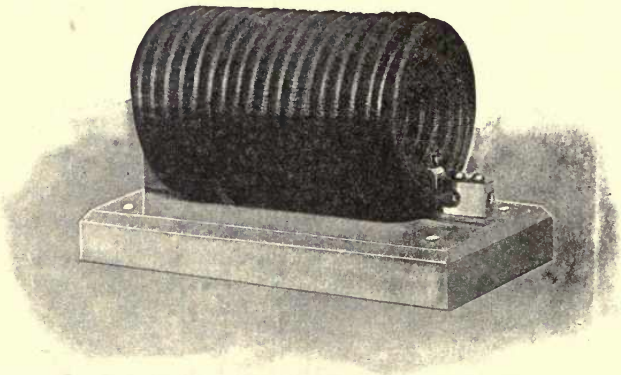

FIG. 280.

more resistances are put in series. For convenience, the gaps are arranged in groups and assembled as required. Fig. 279 shows a Westinghouse unit, and a General Electric unit respectively. The former has six gaps, the latter four and two high-

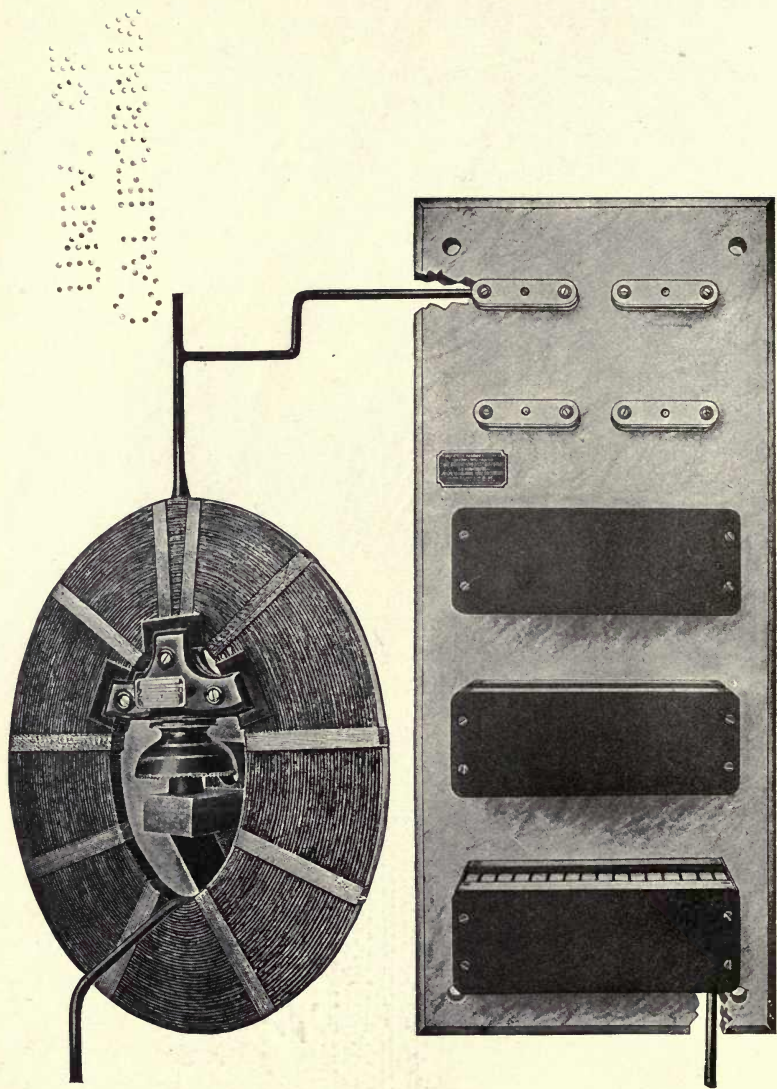

PLATE XXII.

resistance carbon sticks. The Westinghouse Company assembles its resistances separately.

Either can be arranged to work double pole for low voltage, and the General Electric unit is shown so arranged. Both companies use reactance coils next to the apparatus. Fig. 280 shows the General Electric form of coil. The individual gaps are about $\frac{1}{3\frac{1}{2}}$ in., and for high voltage enough units are assembled to aggregate the required striking distance. The Westinghouse

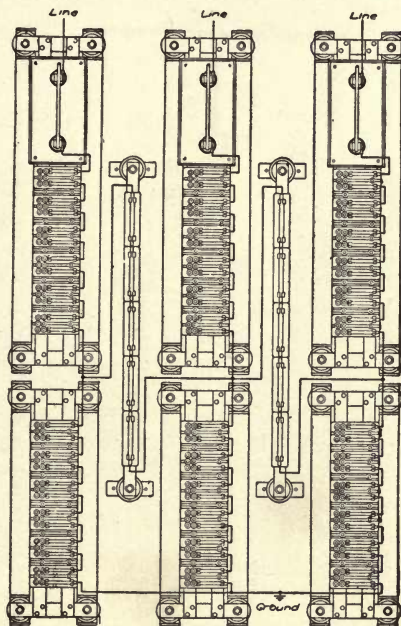

FIG. 281.

cylinders forming the gaps are made of an alloy which produces a non-conductive oxide when vaporized by the passage of an arc, while the General Electric cylinders are more massive and of somewhat different alloy, believed to act mainly by chilling the feeble arc permitted by the series resistances. Either is effective under not too severe conditions.

These components are assembled as convenient, generally in regular panels. Plate XXII shows a recent type of Westinghouse arrester for moderately high voltage including re-

actance coil arrester cylinders and resistances. Fig. 281 shows a General Electric arrester set for a three-phase line, equipped with cut-off switches and static protectors in the form of the intermediate high resistance carbons, shown as uniting the phases midway the groups of arrester units. The office of these is to allow minor rises of potential to be equalized through the auxiliary resistances, without having to leap the whole series of spark gaps, while a heavy lightning surge will go to

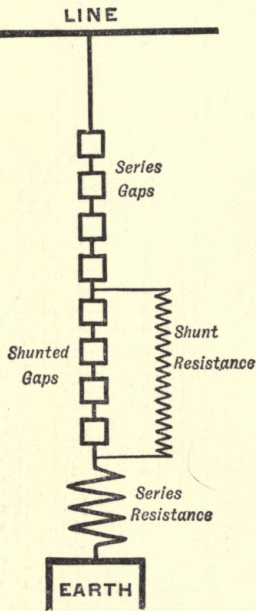

FIG. 282.

ground in the ordinary way. The arrester of Plate XXII has a similar function, the connection being diagrammatically as shown in Fig. 282. Minor disturbances are eliminated via the high-shunt resistance, the series gaps being proportioned to spill over on comparatively small rises above the line voltage. Heavy discharges are sent to earth over the full series of gaps and the relatively low series resistance.

The Westinghouse Company also employs, especially for the protection of very high-voltage apparatus, a device shown in Fig. 283, known as a "static interrupter." It consists of a

reactance coil in the line, and a condenser connected between the coil and the apparatus. One pole of the condenser is grounded, and the other is brought to the coil, both being enclosed in an oil-filled case. This device very considerably attenuates static waves from any source, the wave being, as it were, checked by the coil and soaked up by the condenser, to be frittered harmlessly away in minor oscillations.

The devices here described are the best yet devised for dealing with lightning. They are undoubtedly effective against a

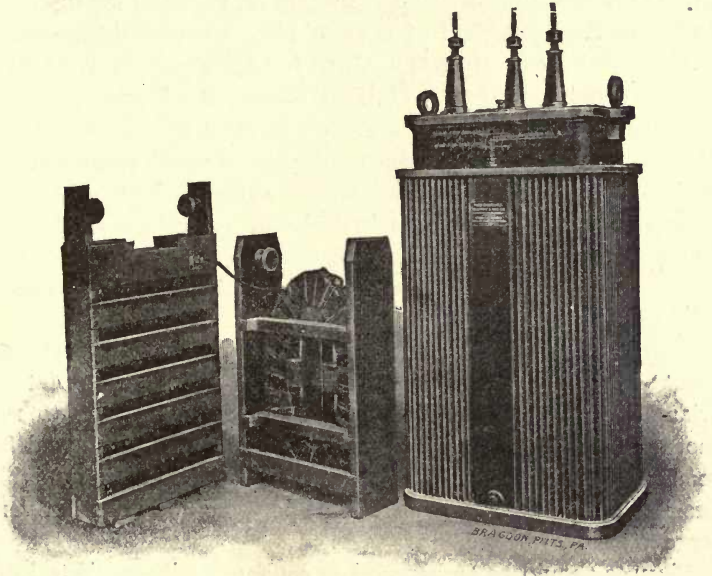

FIG. 283.

very large proportion of the induced class of discharges, but any and all protection is liable to failure in case of a heavy direct stroke.

As the line voltage is raised, it becomes increasingly difficult to deal with the tendency to short-circuit after a heavy discharge over the arresters. On the other hand, a system that is insulated for 60,000 volts with a factor of safety of, say, $2\frac{1}{2}$ has a margin of some 90,000 volts insulation to protect it against the effect of static surges. Hence, such a system is

fairly immune as regards most induced lightning discharges, although perhaps in increased danger from direct strokes.

At the power station and at sub-stations it is wise to install as complete lightning arrester systems as the state of the art permits. If, as is desirable on long lines, section houses are provided with means for cutting out and switching the lines, and to serve as headquarters for line inspection, arresters may be provided there also. But the custom of installing arresters on the line at frequent intervals has been abandoned on account of the elaborate nature of the protection required for high voltage and the likelihood of trouble after a severe discharge.

Grounded wires stretched above the transmission wires have in some cases proved useful, in others, ineffective. Present practice tends to their use, especially on steel pole lines in which the interior of the insulators is already at earth potential. If used at all, they should be of strong stranded steel cable such as is used for guy wires, the barbed wire sometimes used being too weak for safety. The most that can be said for the grounded wire is that it may be of considerable use as auxiliary to other lightning protection.

Experience indicates that the best way of stringing a three-phase transmission line is in the usual form of an equilateral triangle with the apex uppermost. It is undesirable to run more than two circuits per pole line at high voltage; and for security, at pressures of 50,000 volts and upwards, it is highly desirable to run but a single circuit per pole line unless in very large plants.

Circuits should be transposed at convenient intervals to keep down mutual indirection, especially at the higher voltages. Practice varies in this respect, from transposing every mile or less, to making only a few transpositions in the entire length of the line. If section houses are used, these afford convenient points for spiralling the lines, which at high voltage is somewhat troublesome.

It pays to make a very careful and thorough job of the line and to use only the best material.

The life of a pole line is a varying quantity, according to the character of the material and the soil in which it is fixed. With wooden poles the chief danger is of course rotting at and below

the surface of the ground. If one starts with a dry pole, thorough and repeated painting with tar-oil, asphalt, or the like, from the butt to a little above the ground line, will greatly increase the life of the pole. A well set and treated line should last at least 15 years, and if the poles were actually "creosoted," as railway ties are, this life should be extended for another decade. But lines set with green poles in damp earth

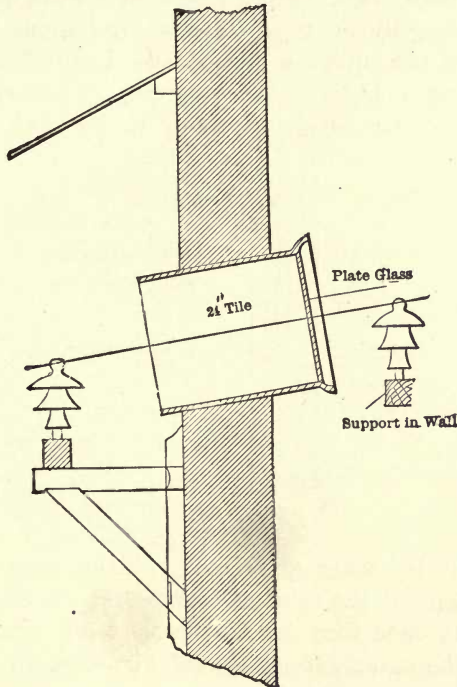

FIG. 284.

are likely to require heavy repairs within 6 or 8 years, if not sooner. Thorough treatment at the start and judicious inspection are necessary to keep a line in proper shape. The mechanical danger points in a line are changes in direction, whether horizontal or vertical, and changes in lengths of span. Double arms and proper guying will make these points safe.

One of the minor difficulties in line work is making a safe entrance into the power station and other buildings which the

high-tension lines have to enter. The chief requirement is ample space around the conductors. Up to 10,000 volts or so, long porcelain wall tubes set through the walls with a slight downward slope toward the outside do very well, the wires being supported on each side of the wall by line insulators.

At really high voltages the striking distance is so considerable as to call for better insulation around the wires, and many plans have been tried, mainly based on a wide hole with the wire held centrally in it by suitable insulators. Two of the best schemes for entrance hitherto tried are those shown in Figs. 284 and 285.

These are nearly self-descriptive. In Fig. 284 the purpose

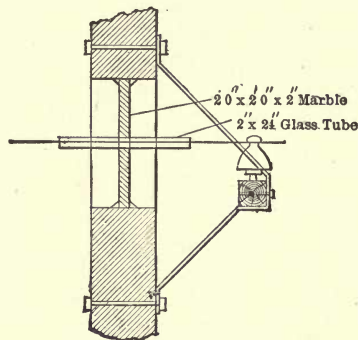

FIG. 285.

of the perforated plate glass cover at the inner end of the tile is to keep out the cold. Otherwise, the tile might as well be open, and open tiles are frequently used. The little rain shed and the downward slope of the wire to keep away dripping water are of obvious use.

Fig. 285 is an excellent construction for cold climates. A long tube of high-grade porcelain may well replace the glass, and the tube should be given a slight slope as in the previous case.

High-voltage wires should never be brought through a roof, or into any contracted place. Allow plenty of space about them. Inside the building they are sometimes insulated, but should be treated with the same respect as if they were bare.

In certain cases it becomes necessary to carry high-tension

conductors underground. This is always to be avoided if possible, but if necessary it can be done at present up to pressures of about 25,000 volts. The best plan is to use a three-conductor lead-covered cable run in vitrified clay ducts, well drained, and with frequent manholes of ample size so that the cable joints can be carefully made and supported.

Fig. 286 gives a full size section of the class of cable most commonly used for high-tension underground work. The insulation is of paper, well impregnated with insulating compound. Each conductor is served with a heavy coating of this, the interstices are packed with jute and insulating compound,

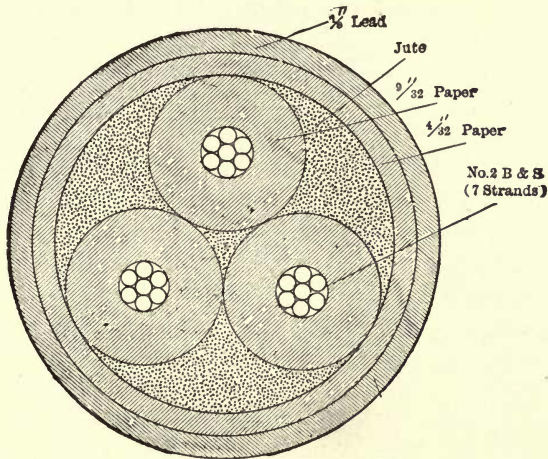

25000 Volts
FIG. 286.

and the whole is given an external wrapping and then leaded. This insulation is wholly dependent on the integrity of the lead covering, and hence the joints must be made and protected most carefully, but it has proved very reliable. Cables are used mostly below 12,000 volts, for which the insulation need not be as thick as that shown. To a certain extent leaded cables insulated with rubber and with varnished cambric are also used.

The junctions between cables and overhead lines are danger spots with reference to lightning and static surges generally, and should be protected by static dischargers and lightning

arresters on just the same plan as high-voltage apparatus in the stations. Underground cables should be laid in duplicate, since a fault cannot generally be quickly found and repaired.*

A well-nigh indispensable accessory of every power transmission line is a private telephone line connecting the power house with the sub-stations and with intermediate points. Such a line is usually carried on side brackets attached to the poles six or eight feet below the power wires. This line is most often a metallic circuit of galvanized iron wire, about No. 12 in size or larger on long lines, carried on ordinary glass insulators and transposed every twenty poles or so. Such lines can be made to give fair service, but the transposition of the wires has to be very carefully adjusted to suppress induction. The lengths of wire under induction must agree, not within a few poles merely, but within a few feet, to avoid annoying singing. The two sets of insulators should be kept at a uniform distance from the main line, and the wires should be drawn uniformly tight and so transposed that taking the line from end to end, each wire shall have just half its length on the upper and half on the lower bracket, or on the right and left insulators if a short cross arm is used.

The wires, too, must be kept clear of grounds from foliage and other interference, in order to keep the inductive balance perfect. With care in stringing, the line can easily be kept in good operative condition, but is seldom free from some residual induction. Such lines should be fused, protected with lightning arresters, and provided with insulated platforms for those using the instruments.

A far better although considerably more expensive line is obtained by using the twin-wire insulated cable made for telephonic purposes.

On long lines it is good policy to make provision, say every 10 miles or so, for getting at the high-voltage line for repairs.

* For much valuable though sometimes discordant information on modern line construction, see the *Trans. Int. Elec. Congress, St. Louis, 1904*, Section D, Vol. II, especially the papers of Baum, Gerry, Converse, Buck, Blackwell, and Nunn, to whom the author stands indebted. It will be sufficiently evident that the problems encountered are complicated and difficult.

If the line is in duplicate, it should be so arranged that at these junctions jumpers can easily be put on or switches closed between wires in the same phase, and a section of one of the lines cut loose so that it can be readily handled. At such points there should be opportunity for cutting in a portable instrument on the telephone line. Telephone boxes, Fig. 287, much like the ordinary police signal box, can be obtained, and may advantageously be permanently installed at the ends of these

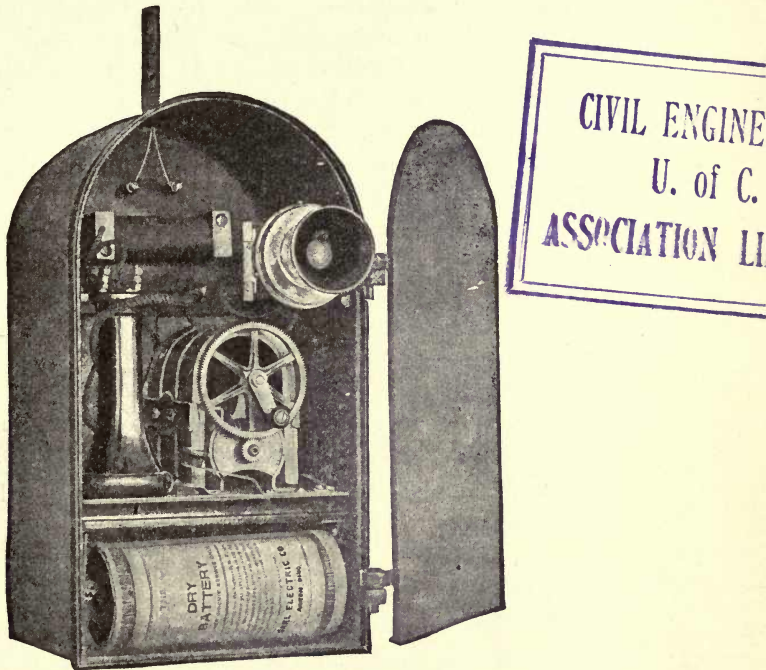

FIG. 287.

line sections. These are good points, too, for installing line lightning arresters and making provisions for testing.

The commonest accidents on high-voltage lines are short circuits from branches of trees and broken insulators. The effect of the first is to start an arc that is likely to burn down the line, if the branch is more than a mere twig. There are great fluctuations of current and voltage, and the character of the accident is generally evident. Broken insulators may in

dry weather produce no sensible effect at all, but if the cross arms are damp there may be serious leakage between line and line that sometimes ends by burning up the cross arm or even the pole top. Broken insulators can be replaced if necessary, while the line is "alive," even when carrying pressures as high as 15,000 or even 20,000 volts. The line affected can be pulled or pushed clear of the cross arm and held clear while the lineman puts on a new insulator, preferably one with a top groove for ease of manipulation. Then the line can be pulled back into position and an insulated tie wire put in place, if needful, with long rubber-handled pliers. It takes a skilful and cautious lineman to do the job, but it can be done if necessary. It is best not to trust to rubber gloves, as they are seldom in good condition, and there is nearly always enough leakage around the pole top to give a powerful shock. Sometimes, when working at such a job, a nail is driven into the pole well below the workman, and a temporary jumper thrown from it over the wire under repair so that the lineman will be less likely to get leakage shocks, or the cross arm is temporarily grounded by a wire for the same purpose.

Duplicate lines are much easier to repair, since one can then work on dead wires, and for very high voltages duplicate pole lines are better still; but, with care, it is far safer and easier to work on high-voltage lines than is generally supposed.

CHAPTER XV.

METHODS OF DISTRIBUTION.

IN most cases of power transmission, the primary object is the supply of power and light in various proportions throughout a more or less extended region. Therefore, the question of methods of distributing electric energy, after it has been received from the transmission line, must often be carefully considered. The subject may conveniently be treated in three divisions: First, distribution direct from the transmission circuit without the use of special reducing transformers or sub-stations. Second, distribution from scattered sub-stations. Third, distribution from a main reducing station. These divisions do not have rigid boundaries and often overlap, but they involve three quite diverse sets of conditions.

Into the class first mentioned fall all the ordinary electrical installations wherein the power station is separated from its load by a transmission line. This line is usually of moderate length, for otherwise the voltage used would need to be reduced for the working circuit, and the region supplied is generally a town or city of moderate size. Such cases are common enough, and generally arise from the existence of a convenient water-power half a dozen miles, more or less, from a town that needs light and power, or that has already a central station which from motives of economy it is desirable to operate by water-power. The power is therefore developed and new distribution lines are erected, or the old ones reorganized. The whole condition of things is closely similar to ordinary central station practice, save that the load is all at a considerable distance from the station. Only the use of alternating current need be considered, since this current alone is practically employed for general purposes at distances above a mile or two.

The rudimentary map, Fig. 288, gives a case typical of many. The power station is at *A*, with a line across country to the town which is to be supplied with light and power. The dis-

tance to the town, $A B$, is perhaps four miles. Now the problem is to distribute the energy derived from A over the town in the best and most economical way. Since much lighting as well as motor service is to be done, good regulation is essential, while abundance of water makes small variations in efficiency of little moment. The town is scattered, with a main business street C , running lengthwise through it.

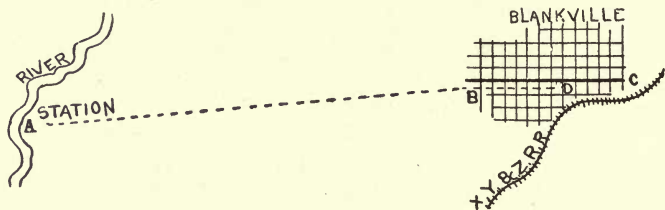

FIG. 288.

There is here little object in a sub-station, for the distances are too great for convenient distribution at low voltage, and the short transmission makes it desirable to avoid raising and reducing transformers. The choice of a system is the first consideration. This is not a question of such vital importance as the average salesman hastens to proclaim. The skilful organization of the installation will make much more difference in the general success of the plant, than the particular species of apparatus used. This should, however, be determined with due regard to the local conditions.

Any alternating system except plain monophasé can be conveniently used, and monophasé is inapplicable only in default of suitable motors, which are not at the present time available in this country, at least in any form which warrants their use in cases where motors are to form any considerable portion of the total load. With a moderate amount of motor service in small units, the monophasé system answers the purpose excellently. Something depends on the character and amount of the motor service. If it be very considerable and in all sorts of service, general experience both in this country and abroad indicates some advantages in triphase apparatus. This advantage, however, depends more on the ease and economy with which a triphase distribution can be carried out, when motors

and lights are to be served in the same territory, than on any intrinsic advantages in the motors. When made with equal care and skill, all polyphase motors are substantially alike in their properties. Details of the various systems of distribution will be given in treating sub-station work. Where the motor service consists of a few large units, even the monophase system with synchronous motors is entirely practicable, although seldom advisable. Diphase and triphase systems can be advantageously applied to any case that is likely to arise, and which one will best fit it is a matter that only a trained engineer with full knowledge of the local conditions can properly decide.

Of far more importance are the general methods employed in carrying out the electrical distribution, and these are applicable with almost equal force to any sort of alternating system.

First in importance is the maintenance of a uniform voltage on the primary service lines. This voltage should, as far as possible, be the same at every transformer and should be constant, save as it may be raised to compensate for the loss in the secondaries.

The first step toward obtaining this uniformity is to assume a fictitious centre of distribution as at *D*, Fig. 288. This should be chosen at or near the centre of load, generally in the business centre of the city. If the office of the operating company is conveniently situated, it should be used as a habitation for the centre of distribution, at which supplies can be kept and measurements made. *D* is taken as the termination of the transmission line proper, and acts in the capacity of a central station toward the primary service wires. As a preliminary toward a more exact regulation, there must be means for keeping the voltage at this point *D* up to the normal under all conditions of load. The most obvious suggestion is overcompounding the generators for constant voltage at *D*, and this is often advisable, though it must be remembered that compound winding is by no means the only and not always the best means of securing constant voltage at a point distant from the generator.

When the circuit is nearly non-inductive, and the current therefore very nearly in phase with the E. M. F., or when the power factor can be kept very nearly constant, compounding

works admirably, and so is readily applicable to cases where lighting is the main work to be done, or where synchronous motors keep up the power factor of the system.

If, however, the load is largely of induction motors, running at all sorts of loads, or is otherwise of strongly inductive character, compound winding alone will not suffice to keep constant voltage at the point *D*. It will fail in proportion to the amount of compounding necessary to be employed, and for two reasons: first, because of the direct effect of the lagging current on the excitation necessary; and second, because, as has already been pointed out in Chapter VI, the lagging in phase of the current disturbs the functions of the commutator. It is sometimes desirable to bring "pressure wires" back from *D* to show at the station exactly the condition of things at the load, so that the voltage may be maintained by hand regulation, if necessary. This is, of course, a temporary expedient with a compound-wound machine, but it may avert frequent bad service. The pressure wires may come either from the primary circuit at the centre of distribution, or from some point of the secondary system which is chosen to represent average conditions of load. The latter is the preferable method, if there is a fairly complete system of secondary mains. The pressure wires may be taken as a guide for close hand regulation, or may operate some form of automatic control of the field rheostat. Neither hand nor automatic control is very satisfactory, if the generator requires great change of excitation under change of load. For the class of power transmission under consideration, it is therefore better to use a generator of moderate inductance and armature reaction, whether it be compounded or otherwise regulated.

For the pressure wires may be substituted a compensated voltmeter, arranged to take account of the drop in the line and show at the station the real voltage at the centre of distribution, provided the power factor does not change so erratically as to vitiate the compensation.

Granted now that means are taken to regulate the voltage at *D* as it would be regulated if the generator were at that point, the distribution problem is the same as that in an ordinary central station. Most alternating stations, however, are far from well organized in this respect. Nothing is at present

commoner than to find an alternating station which receives pay for not more than one-half of the energy delivered to the lines, and sometimes this low figure falls to one-third or even a quarter. This unhappy state of things is due mainly to badly planned secondary circuits and to the indiscriminate use and abuse of small transformers. The alternating current transformer is a marvellously efficient and trustworthy piece of apparatus, and, perhaps in part for this very reason, it has been often the victim of wholesale misuse. Without going in detail into the case of sub-station *vs.* house-to-house distribution, it is sufficient to say that the essential thing for efficiency is to keep the transformers in use well loaded and hence at

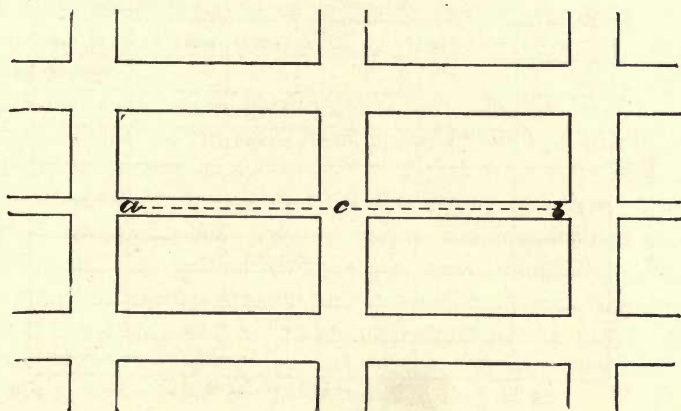

FIG. 289.

their best efficiency, and that for this purpose a few large transformers are, on the whole, much better than many small ones. The reason for this may be best shown by taking the following practical example:

A given region requires, let us say, 250 incandescent lamps or thereabouts, together with fan motors and perhaps an occasional large motor. These are distributed among a score of customers scattered over a couple of blocks, Fig. 289. The blocks are, say, 200 ft. long, with alleys cutting them in two. Now these customers may be supplied from individual transformers, or all may be supplied from one transformer. In either case the lines should be carried in the alley. In the

former case 20 transformers would be connected to service wires attached to the primary service main *a b*. These transformers would average, say, 12 lights capacity each (600 watts). In the latter case, *a b* would be a secondary main supplied from a single transformer of 12,000 watts capacity. Now, assuming a load such as would be met in ordinary practice, let us examine the transformer losses in each case. The day may conveniently be divided into three periods in considering load: 7 A.M. to 5 P.M. forms the day load of motors and a few lights; 5 P.M. to 12 night, the evening load; and 12 to 7 A.M., the morning load. During the first period we may assume 15 transformers to be quite unloaded, 2 to be three-quarters loaded on motor

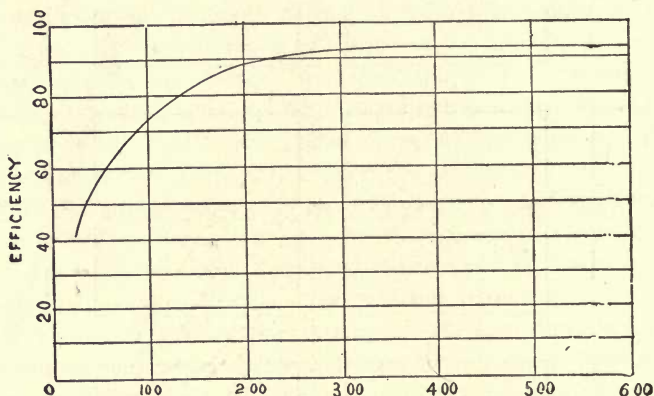

FIG. 290.

work except during the noon hour, and 3 transformers to be one-quarter loaded on day lights.

During the second period we will assume the motors to be off, 8 transformers to be three-quarters loaded on the average from 5 until 7 P.M., and the rest one-quarter loaded from 5 until midnight.

For the third period, it is safe to assume 15 transformers to be unloaded and the other 5 one-sixth loaded from midnight until 7.

Now the efficiency curve of a 500 or 600 watt transformer at various loads is approximately as shown in Fig. 290, derived from a consideration of several transformers of different makes.

The constant loss, when the transformer is run unloaded, is about 30 watts.

On the above assumptions, and knowing the efficiency of the transformer at various loads, it is easy to calculate for each period the total energy supplied and the transformer output which is delivered and paid for. The result of this calculation is as follows:

	1st Period.	2d Period.	3d Period.	Total.
Energy Supplied, Watt Hours,	18,480	20,420	10,050	48,950
Energy Delivered, " "	10,450	17,700	3,500	31,650

Therefore, barely six-tenths of the energy supplied to the transformers is delivered by them to the consumers. And this is a condition of things more favorable than is usually found in stations of moderate size, using, as many of them do, small transformers.

The other method of distribution is to use a single large transformer in place of the small ones, and distribute to all the district by secondary mains.

Now the efficiency of a 10-12 KW transformer is very closely that shown in Fig. 291. Moreover, the energy consumed when running without load is hardly more than 150 watts, so that the transformer, when absolutely unloaded, wastes only one-fifth of the energy wasted by the small transformers of the same total capacity. Taking the output for the same periods as before, a much better result is reached, as follows:

	1st Period.	2d Period.	3d Period.	Total.
Energy Supplied, Watt Hours,	11,800	19,660	5,830	37,290
Energy Delivered, " "	10,450	77,700	3,500	31,650

With the single large transformer, more than 80 per cent of the energy supplied to it is delivered on the customers' circuits. This means that for a given amount of energy supplied from the station, one-third more revenue will be obtained if the distribution be accomplished by a large transformer as against quite small ones. Such a difference is important, even in a plant driven by cheap water-power. Besides, for a given amount of energy delivered to the customers, high-plant efficiency means, smaller first cost of plant. With distribution by secondary mains, not only will smaller dynamos at the power station suffice for the work, but the cost of the trans-

former capacity necessary is enormously reduced. In the house-to-house distribution it is quite possible for any transformer to be loaded with all the lights connected to it. When twenty customers are supplied from a single transformer, the chance of such an occurrence is almost *nil*. In the hypothetical case just discussed, certain of the transformers would be called on for full output almost daily, while all of them would be subject to such a demand. The largest total regular out-

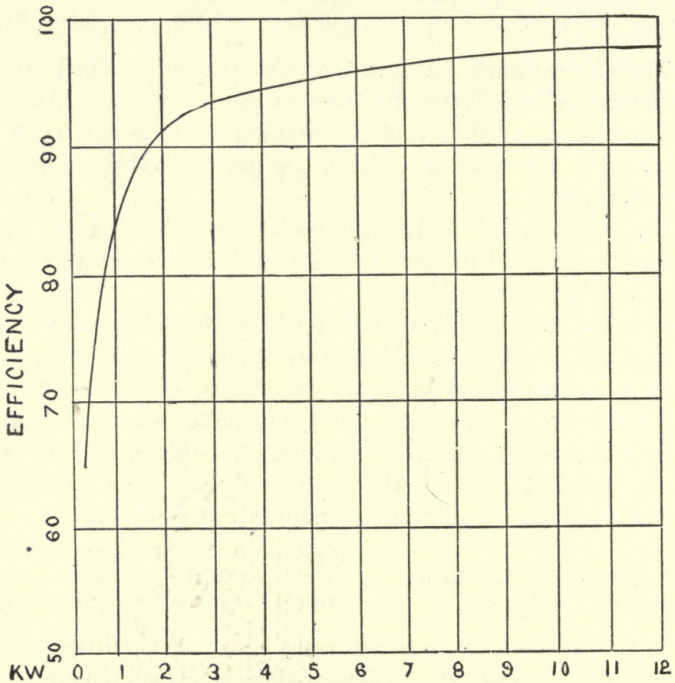

FIG. 291.

put, however, would be not much over one-half the aggregate transformer capacity. So, instead of using a 12 KW transformer to replace 20 small ones, in reality a smaller one, say one of 10 KW, would be ample.

In point of cost, the single transformer would have the advantage by not less than \$250, enough in most cases to pay for the difference in secondary wiring. In regulation, too, the single transformer has the advantage, for the load is less liable

to sudden fluctuations, and the transformer itself regulates more closely.

In practice it is best to go a step further than shown in Fig. 289, and connect the secondary mains at *a* and *b* to the next section of secondary just across the street, and also *c* with the main in the next alley, so as to form, at least in the region of dense load, a complete secondary network. Thus, each transformer can help out its neighbor, in case of need. The secondary mains should, in so far as is practicable, be designed for the same loss of voltage, and the compounding and other regulation applied to the generator should be arranged to compensate for the loss of voltage in the transformers, and to hold the voltage as steady as possible in their secondary mains. The perfection of such regulating arrangements depends, of course, on the uniformity of the distribution of load; but with a little tact in arranging the circuits, variations in voltage at the lamps can often be kept within 2 per cent of the normal pressure. In large systems, as will be presently shown, even better work can be done.

An essential point in the use of secondary mains is the employment of fairly high voltage. The general law, that the amount of copper necessary in a given distribution varies inversely as the square of the voltage, applies here with great force. Not less than 110 volts should be used, and a pressure of 115 to 120 volts is better, as it gives equally good service with a quarter less weight of copper. From the present outlook even higher voltage is becoming practicable.

It is not always advisable to do all the work of distribution by secondary mains. In districts where the service is scattered, a few small transformers of various sizes can be very advantageously used, but should be generally employed as a temporary expedient only, and shifted to another field of usefulness when the service grows heavy enough or stable enough to justify installing secondary mains.

Recurring now to Fig. 288, we have found that the best procedure is to use an alternating system, compounded or otherwise regulated so as to hold the voltage as nearly as possible constant at the secondary terminals of the transformers.

These should be large enough to do all the work within a distance of 200 ft., more or less, and should feed secondary mains at a pressure of, say, 115 volts. When these mains are more than usually long, it is best not to feed current directly into them, but to employ feeders connecting, for instance, *c*, Fig. 289, with points midway between *c* and *a*, and *c* and *b*, respectively. Neighboring secondaries may often be interconnected with great advantage.

As to the primary distribution, we have assumed a centre at *D*, Fig. 288. From this point feeders should extend to primary mains connecting the transformers more or less completely, preserving nearly equal drop in voltage from *D* to each transformer. The degree of elaboration in this primary network is a matter to be determined by local conditions. If, for example, the plant is of rather small size and the drop from *B* to *C*, Fig. 288, is not above 1 or 2 per cent, the transformers may be connected to short branch lines crossing *BDC* at various points, without any further complications, or the main line may be branched at *B*, each branch having short cross feeders, while with other distributions of load the primary lines may be quite completely netted, with regular feeders at *D*.

The motor service may often require special treatment. It often happens that it is best to feed large single motors or groups of motors from special transformers, which will generally be large enough to avoid the objections adduced against a general house-to-house transformer system. Such special transformers avoid throwing a large and varying load on the secondary lighting mains during the hours of "lap-load" when it might be objectionable, and thereby avoid needlessly heavy mains and annoying variations of voltage.

It must be remembered that Ohm's law is a very stubborn fact. Any apparatus that takes a large and variable current is liable to interfere with regulation. There is no such thing as a motor, either for continuous or alternating currents, which will not affect the lighting service. The nearest approach to such a motor is obtained by arranging the distributing system so that the largest current taken by the motor will be insufficient noticeably to disturb the regulation of the lamps.

This means that care should be taken, in arranging the distribution, to avoid overloading the lighting mains with motors. It is an easy matter to determine the effect of the motor current by calculation if the current is continuous, and by experiment or calculation for alternating current. In the latter case the easiest way is to connect the motor with any convenient main and put on load with a brake — even a plank held against the pulley will do. Put an ammeter in circuit, and if at the rated amperage of the motor the fall in volts at the transformer is enough to endanger regulation, the motor should be put on transformers of its own. Generally the likelihood of trouble can be judged from the size of the motor and the load on the mains, without experiment.

One of the nice questions to be decided, in such a plant as is under discussion, is arc lighting. The most obvious method of arc lighting from a transmission plant is to use alternating motors to drive arc dynamos, either belted or directly coupled. This method is in use in a good many plants, and works admirably, although the efficiency is not all that could be desired, being probably about 70 per cent at full load, reckoning from the energy received by the motor to that delivered at the lamps under the most favorable commercial conditions. That is, for the operation of each 450 watt (nominal 2,000 c. p.) continuous current arc, at least 650 watts would have to be delivered to the motor. In working commercial circuits, on which the number of lights varies greatly, the efficiency at light loads would be greatly reduced, and might easily fall to between 50 and 60 per cent.

This is not a cheerful showing, and much ingenuity has been spent in attempting to remedy such a state of things. For street lighting, the scheme is reasonably good, but it breaks down in commercial lighting.

In cases where plants operate low-tension direct current systems via motor-generators or rotary converters, the solution of the difficulty is simple, since all the commercial arcs can readily be worked at constant potential, using preferably enclosed arc lamps taking from 5 to 7 amperes. The efficiency of the rotaries is high and the loss in the mains is not great, so that by this means the only circuits that need be worked on the series system are the street lights, which form

a nearly constant full load. When the distributing system is alternating, one can still use constant potential lamps for the commercial circuits with fairly good results.

Alternating constant potential enclosed arc lamps have at the present time been brought to a state that justifies their extensive use, and yet it must be admitted that they are somewhat less satisfactory than the direct current arcs. Taking lamps as they are found commercially, and comparing direct current with alternating current enclosed constant potential arc lamps, the following results were obtained by a committee of the National Electric Light Association appointed to deal with arc photometry:

	Current.	Total Watts.	Mean Spherical C. P.		Watts Per M. S. C. P.		
			Opal Globe.	Clear Globe.	Opal Globe.	Clear Globe.	
Direct	4.90	529	155	182	3.41	2.90	Average of 8 lamps.
Alternating . .	6.29	417	114	140	3.66	2.98	Average of 7 lamps.

These figures show that even considering the energy absolutely wasted in dead resistance in the direct current constant potential lamp, it still has a slight advantage in efficiency over the alternating lamp, not enough, however, to compensate in addition for the loss of energy incurred in changing from alternating to direct current.

The alternating lamp is at a slight further disadvantage in that it requires rather the more careful handling, and a rather better grade of carbons. It also is liable to give trouble from noise, although the best recent lamps are comparatively free from this defect, which has in the past been a serious objection to this type of lamp. Some noisy lamps are still to be found on the market, and a hard carbon will make almost any lamp sing. Most of the noise originates in the arc itself, and it is considerably reduced by enclosing the arc and using a non-resonant gasket on the outer globe. Good lamps carefully operated are capable of giving very excellent service, and are entirely adequate for commercial circuits under ordinary circumstances.

It would appear at the first glance at the table just given, that enclosed arcs of either type are little, if at all, more efficient than good incandescent lamps.

The difference between them is in fact not very great, but incandescent lamps are generally rated on horizontal candle power and on their initial, not their average, efficiency. With due allowance for this, the efficiency of the best commercial incandescent lamps per mean spherical candle power ranges from 4 to 4.5 watts per candle power, so that the arcs have still a fair margin of advantage, increased by the better color of their light. In using alternating arcs for commercial work, their performance is much improved by pushing the current up to about 7.5 amperes, at which point the lamp is more efficient, more powerful, and, if properly adjusted, steadier.

In street lighting, the best results have so far been obtained by operating alternating arcs in series on the constant current system. This requires special lamp mechanism and special devices for changing the constant potential alternating current of the transmission line to a constant alternating current of voltage automatically varying with the requirements of the circuit.

Such constant current regulators vary considerably in detail, but the underlying principle of all of them is as follows: A heavy laminated iron core is surrounded by a movable, counter-balanced coil, through which the current to be regulated flows. Any change in the position of this coil changes the reactance of the combination, and hence varies the current. The coil is counterbalanced, until, when the normal current is flowing, the coil floats in equilibrium, the opposing forces being gravity and the attraction or repulsion between the coil and the magnetized core. Then any change of current due to varying conditions in the external circuit establishes a new position of equilibrium for the coil in which the changed reactance brings the current back to its normal amount. Sometimes the regulator is combined with a transformer which receives current from the transmission system at any convenient voltage, while the floating coil acts as a secondary and delivers constant current to the lighting circuits.

This is the arrangement of the constant current transformer

system as operated by the General Electric Company. Fig. 1, Plate XXIII, shows the internal arrangements of the transformer. It has two fixed primary coils at the top and bottom of the structure, receiving current from the main line, and two floating secondary coils counterbalanced against the repulsion of the primaries, and balanced against each other by the double system of rocker arms visible at the top of the cut, which are supported on knife edges. The short balance lever in the foreground is attached to the rocker arms by a chain, and is likewise pivoted on knife edges, while it carries on its longer sector, suspended by a chain, the adjustable counterbalance weights. The current can be adjusted at will within reasonable limits merely by adding or taking off counterbalance weights. The whole apparatus is enclosed in a deeply fluted cylindrical cast-iron case filled with paraffin oil, which serves the double purpose of giving high insulation and also damping the oscillations of the floating coils. Hence, the system has been jocularly dubbed the "tub" system, and the name has every appearance of sticking. Transformers of this type are built for as large a load as 100 series arc lights, in which instance they are usually arranged on the multi-circuit plan, with two 50-light circuits. Some of these big tubs have four primaries and four secondaries, while the smallest sizes have but one of each.

The diagram, Fig. 292, gives a very clear idea of the circuits of this simpler form of the apparatus, and of the shifting of the secondary coil under changing load. The secondary is shifted by hand into the short-circuit position and a plug short-circuiting switch inserted just prior to starting up, and when the primary current is on, the short-circuiting switch is withdrawn, throwing the current upon the lamps.

These transformers regulate promptly and steadily, and hold the current quite accurately constant from full load down to as low as one-quarter load. Their efficiency as transformers of energy is high in spite of a rather unfavorable form of the magnetic circuit, being 95-96 per cent at full load in the average sizes. From the nature of the case, however, the power factor of such apparatus is not as high as would be desirable, being about 80 per cent at full load, and falling off in practically

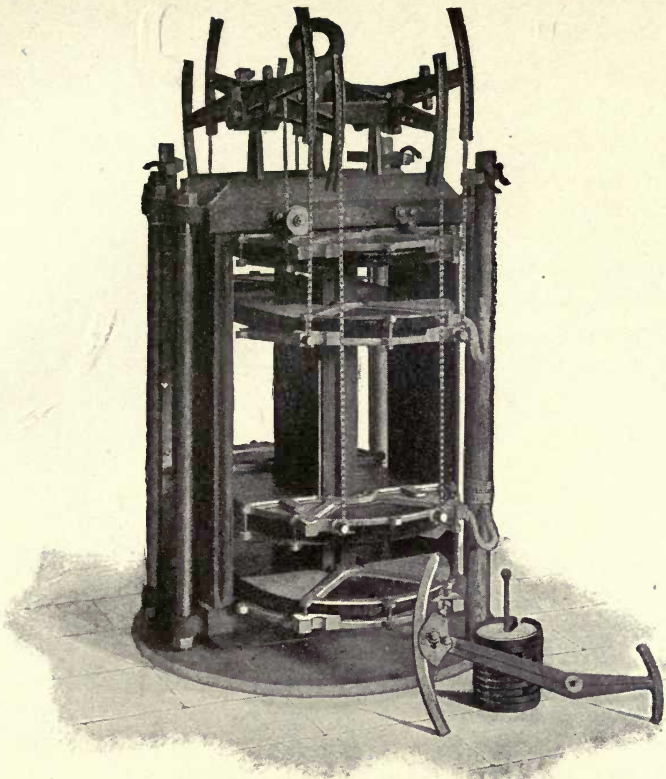

FIG. 1.

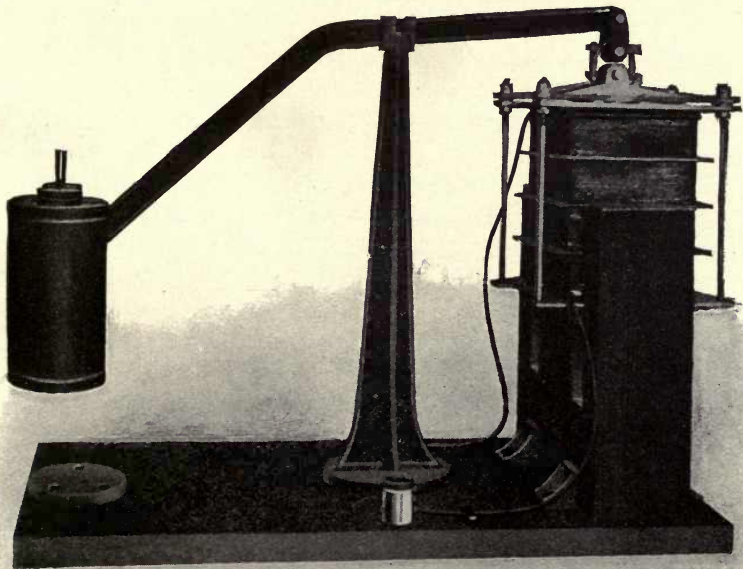

FIG. 2.

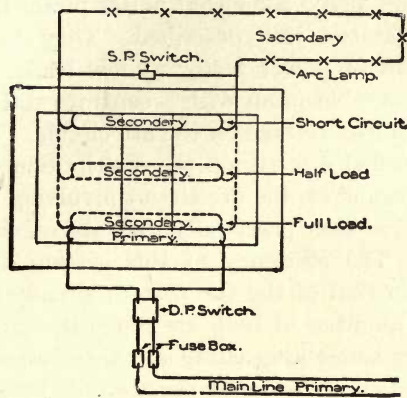

FIG. 292.

linear proportion as the load decreases. For this reason the apparatus, when put into action, throws a nasty inductive load upon the system, and it is good policy to cut it in with a water rheostat in the primary circuit so that the load may go on gradually. An ordinary barrel nearly filled with pure spring water, with a fixed electrode at the bottom and a movable one at the top, each a little smaller than the barrel head, makes a very efficient rheostat for an ordinary circuit of 2,000 volts or so.

Owing to the low-power factor, such apparatus should not be used on circuits likely to be worked much at partial load. It is very well suited, however, to street lighting, and has come into very extensive use.

A similar device has been considerably used in the practice of the Westinghouse Company, differing, however, in that the transformer and regulator functions are not combined. The regulator is shown in Fig. 2, Plate XXIII, and in virtue of what has already been said the cut is self-explanatory. The balance floating coil inserts automatically the reactance necessary to hold the current constant. Regulators are made for a range of action varying from 25 per cent to 100 per cent of the whole load, according to the requirements of the case, and, of course, are of greater size and cost according to the range required. They hold the current closely at a uniform value, and have,

probably, at full load a somewhat better power factor than the combined apparatus just described. They have the same rapid falling off of power factor at low loads, however, and must be used in connection with a separate static transformer to give the required voltage on the arc circuit. They could, of course, be installed directly on the distribution circuit, but at the risk of a ground on the arc circuit involving the whole system in trouble, so that practically they are regularly used with transformers. The efficiency of this system does not differ materially from that of the tub system already discussed, and the operative qualities of both are much the same.

The ordinary series alternating arc takes about 6.6 amperes and 425 watts, and at this input is materially better as an illuminant, light for light, than the so-called 1,200 c. p. open arc or the enclosed continuous current arc taking 5 amperes or thereabouts. To compete on favorable terms with the 9.5 ampere open arcs, or the 6.6 ampere enclosed continuous current arcs, the current in the alternating system should be carried up to at least 7.5 amperes, at which point it is substantially the equal of the others in practical street lighting.

Used thus on the street, the slight noise of the alternating arc is not noticeable, and experience has shown the operation of the system to be eminently satisfactory. For commercial lights the series alternating arcs are not to be commended, since the power factor of the regulating devices is objectionably low at partial loads. The choice for such work lies between conversion to continuous current and the use of constant potential alternating arcs, with the advantage, at the present time, rather in favor of the former expedient. Recently some very good results have been obtained in arc lighting by means of the mercury rectifier already described. The best success has been had with the so-called "luminous" arc. In this the lower electrode is chiefly of compressed magnetite in a sheet iron tube, and the upper of copper. The light is given mainly by the arc itself, is brilliant and highly efficient, and is thrown well out near the horizontal. The ordinary street arc of this type takes about 4 amperes and 70 volts.

For much commercial work there is no need of using arcs at

CIVIL ENGINEERING
U. of C.
ASSOCIATION LIBRARY

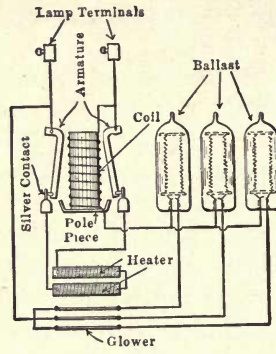

FIG. 1.

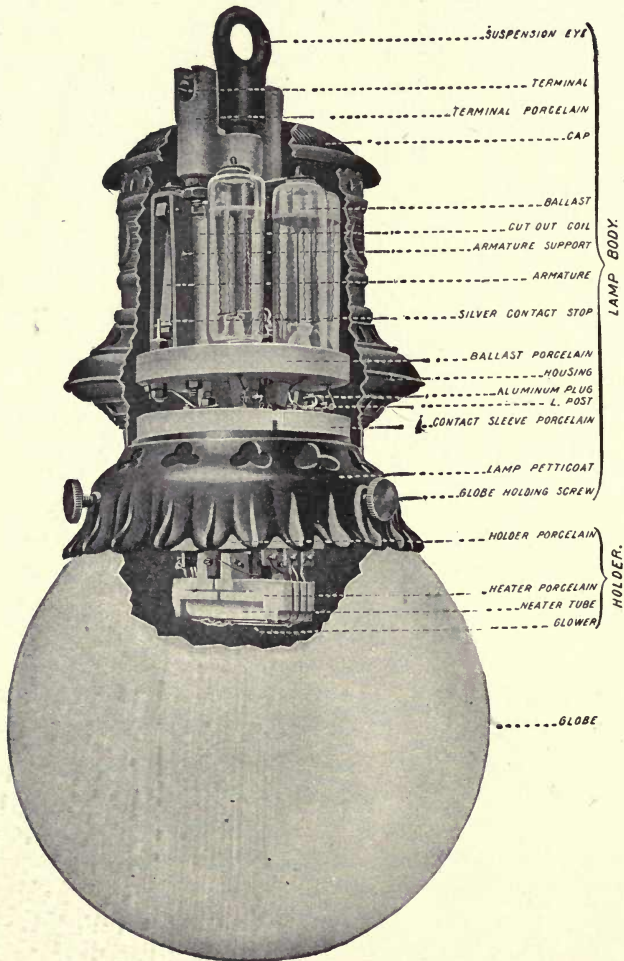

FIG. 2.

all, and often incandescent lamps may replace arcs to advantage. In cases where fairly powerful radiants are necessary, and particularly where the color of the light is important, very good results can be obtained by the use of Nernst lamps.

The Nernst lamp is a modified incandescent in which the light-giving body is not a filament *in vacuo*, but a stick of refractory material driven to high incandescence in air. The material used is akin to that used in Welsbach gas mantles, mainly thorium oxide. A non-conductor when cold, it must be artificially heated to start the current, when it becomes a tolerable conductor and can be successfully worked at a higher temperature, and hence a higher efficiency, than an ordinary incandescent lamp. The principle involved is simple, but the accessory parts needed produce a lamp which, while less complicated than an arc lamp, requires more attention than an ordinary incandescent.

The Nernst lamp as used in practice is shown in Plate XXIV, of which the upper figure shows the connections of the 3-glower lamp which is the ordinary form, and the lower, the 3-glower lamp complete. The essential parts are the glower, the heater, the heater cut out, and the ballast.

The first named is a stick of oxides, in a 220-volt lamp about an inch long and $\frac{1}{32}$ inch in diameter, into the ends of which are fused tiny platinum balls connected to the lead wires. The heater is a spiral of fine platinum wire embedded in a tube of refractory enamel, and the magnetic cut-out merely serves to prevent this from remaining in circuit after the current is fairly established through the glower. The ballast is a resistance of fine iron wire in series with the glower, and enclosed in an oxygen free tube to prevent oxidation. As iron rapidly increases in resistance when heated it prevents too large a current through the glower, which decreases its resistance when hot, in case of a rise in voltage, and thus tends to steady the action of the glower. The cuts speak for themselves.

The lamps suffer seriously from a species of electrolytic action on the glower when used on direct current, and thus are essentially alternately current lamps doing well at periodicities from 25~ up, with rather better life at the higher frequencies. The life of the glowers is 600 to 800 hours, some-

times more, and the mean spherical efficiency when used with a light-diffusing globe, as is usually necessary on account of the high intrinsic brilliancy, is slightly better than that of an a.c. arc lamp. The Nernst lamp, however, is arranged intentionally for a strong downward distribution of light, and hence in many situations does considerably better, watt for watt, than the enclosed arcs. Figures on the maintenance of these Nernst lamps vary widely, but the best information at hand indicates that it is relatively rather less than for arcs. The color of the light is almost pure white, very conspicuously better than that of any form of enclosed arc, and the illumination is beautifully steady. The lamps start rather slowly, rising to full brilliancy in forty seconds or so. They have come into considerable use already, and for commercial work on alternating current transmission systems have much to recommend them.

Very recently highly efficient incandescents with metallic filaments have been introduced. The best known of these are the tantalum and the tungsten lamps, the former requiring 2 watts per m. h. c. p., the latter about 1.25 watts. The tantalum lamp gives poor life on a. c. and the tungsten filament is as yet extremely fragile and so plastic when hot that the lamp must be burned tip downward. But improvements in metallic filaments are progressing rapidly, and there is a strong probability that they will eventually displace arcs for many, if not most, purposes. They give much longer life than ordinary incandescents and considerably surpass in efficiency all ordinary forms of enclosed arcs.

The general principles of distribution laid down hold whatever alternating system is used. Polyphase and other modified alternating systems require special treatment in the details of distribution, but not in the broad methods employed.

Motor service should generally be cultivated as a desirable source of profit and an excellent way of raising the plant efficiency. A motor load, if of numerous units or a few steadily loaded ones, is remarkably uniform. Fig. 293 shows the load line of a three-phase power transmission plant. The motor load consisted of about fifty induction motors of various makes, aggregating nearly 350 rated HP. The curve shows the prim-

ary amperes in one leg of the circuit throughout the twenty-four hours. It was taken on a day in early August when the lamp load was very light and reached its maximum as late as 8 P.M. The motor load, save for the sharp decline during the noon hours, was very steady, although there were frequent variations through a range of a few amperes, too brief to appear on the diagram. In this case and at this season of the year there is no "lap load." The distribution is, as far as possible, from secondary mains, and even in winter, when the lap load

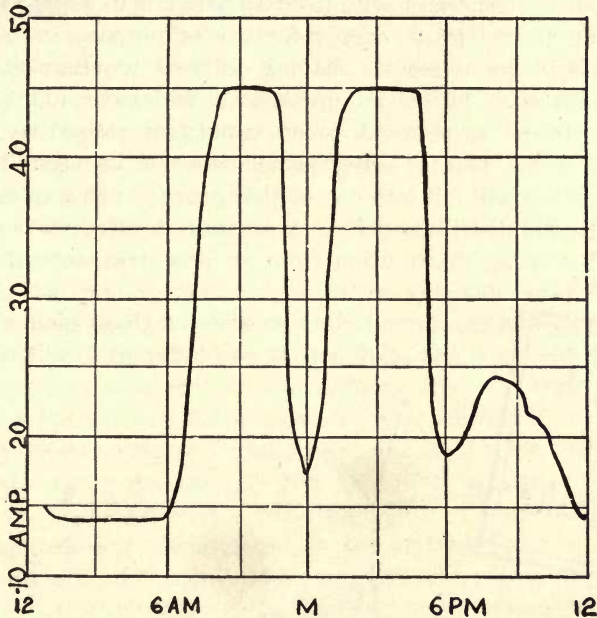

FIG. 233.

is prominent, although the motors still require the major part of the output, the regulation of the system is admirable.

Thus, even a heavy motor load gives very little trouble with a properly designed system of distribution and judicious handling. The things to be feared are large motors running on very variable load, motors with bad power factors carried by overloaded transformers, and overloaded conductors during the period of lap load. Now and then a system is installed for motor service only or with special motor circuits. In this case

it should be remembered that there is no need for any very close uniformity of voltage throughout the system, and that to attempt it means waste of time and money. The circuits can be laid out with reference to the desired efficiency alone, for in most cases even 10 per cent variation in voltage between one motor and another is of little consequence.

The distribution of power from scattered sub-stations fed by a common line, involves some of the most intricate and puzzling problems to be found in power transmission. Such distributions generally arise from an attempt to supply from a common power plant, energy for divers purposes to several separate towns or regions, having different requirements. In the main such plants require special treatment in order to secure decent service. A great variety of cases may arise, almost every plant having peculiarities of its own, but in general they will fall into one of the three following categories:

1. Radial distribution from a centrally located station.
2. Radiating distribution from an eccentric station.
3. Linear distribution.

1. The first-mentioned class consists of those plants which supply from a single station power to different localities lying

CIVIL ENGINEERING
U. of C.
ASSOCIATION LIBRARY

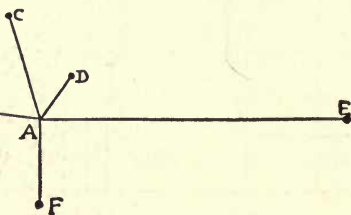

FIG. 294.

in different directions, and generally at different distances. Fig. 294 shows the character of the conditions thus met. *A* is a generating station, the position of which may be determined by various reasons — the existence of valuable water-power being the commonest; *B, C, D, E, F*, are the various points to be supplied with power. They may be at any distances, and of any sizes or natures. Usually the greatest distance involved will not be coupled with the greatest load, and the situation is otherwise inconvenient. If all the loads were large, the

simplest procedure would be to install one or more generators for each circuit and operate them independently. Or if by good luck two or more load points were of similar size, distance, and character, they would naturally be operated as if they were one.

To consider methods of operation more in detail, imagine a system consisting of the station *A*, a load at *B* consisting of 150 KW in lights and motors, largely the latter, distant 3 miles; and a load at *E*, 6 miles away, of 250 KW, mostly incandescent lamps. At both *B* and *E*, it would be desirable to distribute at the voltage of transmission without a general reducing station. In such a plant it might be possible to operate *B* and *E* from separate generators, compounding them or using the regulating methods already described. But, if day lighting at *E* is to be attempted, it would be necessary either to run one dynamo all day at a trivial load, or to throw this day work in on the other circuit and take the voltage as it chanced to come.

With the ordinary amount of loss in the line *AB*, the result would be decidedly bad regulation at *E*, with only motors at *B* or *E* the case would be very simple; the station would be regulated with reference to the lighting load alone, but with lights at both places there must be good regulation at both. During the day at least it would be desirable to work both lines from the same generator. The first step in this direction would be to install at *A* a hand regulator to control the line *AE*. As already pointed out, a motor load is often fairly steady except at certain times, so that the regulator would require little attention save in the early morning and at noon. Before the motor load fell off in the afternoon, it would probably be desirable to start a separate dynamo for *E*.

In operating both lines regularly from the same generators, hand regulation on at least one of them would become necessary; on which one is a matter of relative convenience. If the distances *AB*, *AE* were much smaller, not more than two or three miles, it might be feasible to install both lines for small and equal drop — not over 2 per cent — so that, if the dynamo were compounded for an equal amount, the possible variations of voltage would be trifling. Such a plan cannot,

however, give really good regulation over any save very short distances without inordinate expense for copper. This sort of regulation by general average has been tried too often already, with disastrous results, and is quite out of place in serious power transmission work.

If $A E$ were ten or fifteen miles long the manner of operation would become a still more troublesome question. Raising and reducing transformers would generally be used, and the best plan would probably be to install a pressure regulator in connection with the raising bank of transformers, and let the shorter line be taken care of by the compounding of the generator or by a pressure regulator of its own. The latter procedure is somewhat preferable. For if the drop in the lines be 5 or 10 per cent and the loads variable, the work of regulation will be lessened by compounding the generator, if at all, for constant potential at its own terminals. The range of the hand regulation is thus lessened, since there is no attempt at over compounding; and two regulators requiring occasional adjustment are easier to handle than one which requires continual juggling to produce indifferent results.

In certain cases of heavy load there may be a regular sub-station at B or at E , the distribution at the other point being direct. Then the regulation question is better transferred to the sub-station, the generator being regulated for the loss in the other line, which as its load will usually be relatively small, should have a comparatively small drop.

The most troublesome case that can arise is when power is to be furnished to a street railway at B or E , in addition to a general lighting and motor service. A railway load is so violently variable that it cannot be operated in direct connection with an incandescent service unless this latter with the general motor load is so great as to quite dwarf the variations of railway load. Frequently, therefore, a separate generator should be devoted to the railway work. In case this cannot be done without great inconvenience, it may become necessary to install a sub-station at which the lighting circuits can be regulated either by hand or automatically.

Suppose now that the problem is complicated by the addition of loads at C , D , and F . These lines will be treated on

the same general principles as the first two. To begin with, any line operating motors alone can be worked direct from the generator. Even if all the loads be mixed in character, two or more can often be found which through similarity of conditions can be worked together in parallel, either by a common regulator or by compounding the generator. The others should be treated as already indicated. At the worst, it might be necessary to install a regulator for each line. This is not really so burdensome as might be supposed, since several of the regulators will usually require infrequent attention, so that one man can manipulate the whole set. This line of action is similar to that followed in most large central stations, where feeder regulation, although rather a nuisance, is successfully accomplished without any particular difficulty. Feeder regulators for alternating circuits have, however, by no means received the attention that is their due.

Pressure wires from each load point are desirable, though, if the load is such that the inductive drop is small or quite steady, the regulator can be as easily adjusted in accordance with the current on the line, or in accordance with the indications of a compensating voltmeter.

In the transmission and distribution of power from an eccentric station, the difficulties are many unless recourse be taken to a regulator sub-station. Fig. 295 shows a typical situation. Here *A* is the generating station and *B*, *C*, *D*, *E*, *F*, are the load points. If the distance from *A* to the nearest load is

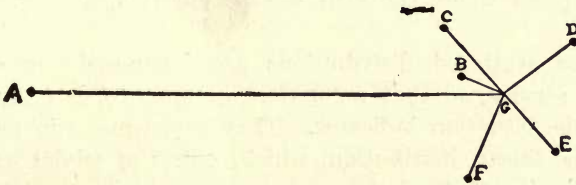

FIG. 295.

great enough to require raising and reducing transformers, it is generally best to install a reducing sub-station worked like the central station *A*, Fig. 294. Sometimes, however, it is only half a dozen miles or so from *A* to the group of load points. The case is similar to that discussed in the first part of this

chapter, save that the load is in several distinct localities instead of being generally distributed. From this difference the complication arises. A certain proportion of cases can be treated readily, however, by choosing a point G near the centre of load and then running the lines GB, GC, GD, GE, GF with 1 or 2 per cent loss wherever lights are to be furnished. Then by holding the voltage constant at G or slightly over compounding at that point, sufficiently good service can often be given.

If the loads are very unequal in size, G may be chosen at or near the most important point and lines run to the others as before, with the regulation question confined practically to the first. If the load points are quite numerous and scattered,

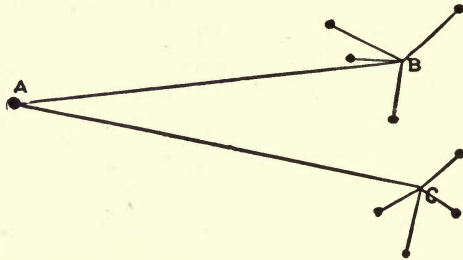

FIG. 296.

Fig. 296 may be a preferable plan. Here two lines AB and AC are run and a group of load points is served from the terminal of each line. The groups shown are about equal, but sometimes it would be desirable to run a separate line for a single point where the load was peculiarly heavy or troublesome.

These scattered distributions are fortunately mostly for motor service, so that regulation, in practice, is often easier than the situation indicates. They sometimes run naturally into the linear distribution, which, unless of trivial size, is a thorn in the flesh of the engineer.

Fig. 297 is a type of this linear distribution, which is often met with in large transmission work and especially in long distance cases.

The power station A is mainly intended to supply lights and power at B , which may generally be supposed to be the largest town in the immediate region. Incidentally it is highly desir-

able to supply lights and power to *C, D, E, F, G*, towns or manufacturing points at which electric power is needed. The main line *A B* may be taken as 20 miles, which is enough to disclose most of the difficulties.

Of course, the line must be operated at high voltage with raising and reducing transformers. In nearly every case the latter would be placed in a regular sub-station, with appropriate regulating apparatus for keeping uniform voltage throughout the primary and secondary networks in *B*. The loss of voltage in the line above may be assumed at 10 per cent, and the primary pressure at *B* as 20,000 volts. As *B*

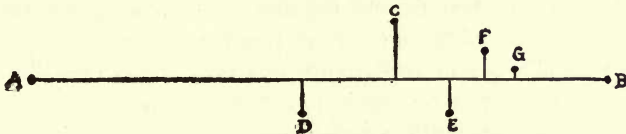

FIG. 297.

comprises by far the largest and most important part of the load, attention should be first directed to complete regulation at that point.

This can be best attained by first holding the primary pressure at *B* constant by compounding or other regulation at *A*, and second, by careful regulation of the primary and secondary feeders in the sub-station. In fact the whole transmission must first be treated with respect to results at *B*, while nevertheless it is necessary to scatter power along the line at the points indicated. There may be present all sorts of requirements. For example, at *C* there may be required 1,000 incandescent lamps and a few motors; at *D*, 500 incandescents; at *E*, a 50 HP motor and 300 incandescents; at *F*, 300 incandescents; and at *G*, 200 HP in motors and 200 lamps.

Frequently the load at one or more points may consist of motors only. This case is not included above, since no special regulation is needed; the power has only to be transformed from the line voltage to that of the motors, neglecting the effect of varying loss in the line.

Each of the cases noted involves the question of regulation in a somewhat troublesome form; at *D*, for example, the conditions under which incandescent lamps must be supplied are

most severe. To begin with, at the nearest point of the main line, *A B*, the voltage may change by about 6 per cent, owing to varying loss in the line; the branch to *D* causes a trifle more variation, the drop in the transformers still more, and finally there must be added the loss in the secondaries up to the lamps. In all, these cumulative variations in voltage may be 10 per cent or more. At best, this means 5 per cent change of voltage above and below the normal. This is too great to allow what can be called good service, although worse is sometimes given. In fact such variation ought to be classified as outrageously bad. To better matters, two methods are available.

First, one may use a hand regulator in connection with the reducing transformers; for, in so large a system as that involved, the changes in voltage are relatively slow, and the conditions of load may be such that over compounding on the main line may partially compensate for the losses elsewhere. Or second, the lights may be operated by a dynamo driven by a synchronous motor. This procedure adds somewhat to the expense and trouble, but completely eliminates the loss in the line, since the speed of the motor is independent of the applied voltage, and incidentally, of the load.

For small outputs a good induction motor serves the purpose well, for it is simpler to operate than the synchronous variety and can be made remarkably insensitive to changes of load and voltage. This motor generator device is an admirable resource when a very variable line voltage must be dealt with. In making the installation for a point like *D*, the actual variation of the pressure at the point of tapping the main line should be ascertained, and the effect of the subsequent losses up to the lamps should be computed. If the resultant changes are frequent and considerable, a motor generator gives the best result. For gradual and moderate changes, an occasional touch at a regulator may be all that is needed, and now and then the resultant variation will prove to be not more than 2 per cent above or below an assumed normal for the lamps, in which case the regulation often may take care of itself.

At *C* there is a distribution equivalent to that from a small central station. The line pressure will generally have to be twice reduced before feeding the lamps. The choice of

methods is the same as in the case just discussed, except that, with the losses of a double transformation and rather scattered service, regulation cannot be left to chance. Generally in a station of this size some regulation due to the distribution itself will have to be provided for, and the simplest course is to establish a sub-station with one or more pressure regulators. This is operated just like the sub-station at *B*, being merely on a much smaller scale. A careful study of local conditions, however, is needful to enable one to discriminate between the two methods mentioned.

At the station *E* the motor will take care of itself, but the lamps might give trouble owing to variations in motor load. If these are great and sudden, nothing save running from the motor a generator for the lights will answer, and even that will not be entirely satisfactory. If the load is steady and the lights regularly in use, as would be common in factory service, the loss in the branch line to *E* and the secondaries can be adjusted so that if the voltage at *B* is kept constant by regulation at *A*, that at *E* will be nearly so. This device is probably the one best suited to give good service at *F*. For *G* the same method holds, but with so large a proportion of motor load, separate transformers for the lights are almost necessary. In cases where there is no regulation at *A* for the loss in the line, pressure regulators or sometimes motor generators will have to be used at *E*, *F*, *G*.

The various cases of linear distribution just considered are of necessity treated little in detail, since they are so much modified in practice by special circumstances. Enough has been said, however, to indicate the methods to be followed and to show how tactfully this class of problems must be treated.

Finally comes that very important class of cases which involves the distribution of transmitted energy from large reducing stations. Such is the normal condition of affairs whenever power is transmitted to a city in large amounts for lighting and motor service. Passing over a few instances in which this power may be mainly utilized for driving by motors, or replacing by rotary transformers, existing central stations, one is confronted by the problem of constituting a great distributing system for alternating currents; a system general

enough to be available for every service, and perfect enough to compare favorably with the great networks now worked by continuous currents. Until very recently this problem would have been insoluble in any practicable way, but to-day, thanks to the modern alternating systems and to the intelligent use and arrangement of large transformer units, it is possible substantially to duplicate in convenience and efficiency the best direct current systems, while retaining the enormously valuable advantage of using high tension feeders. It must not be supposed, however, that the same procedure must suit both cases—the results but not necessarily the methods, must be in full accord.

The basis of each system must be a carefully laid out network of working conductors, giving throughout the area of service a substantially uniform voltage as high as can conveniently be employed in the various receiving apparatus — lights, motors, and so forth. This voltage is practically determined by that of the incandescent lamps which are available. A few years ago 100 to 110 volts was the working limit of effective voltage between incandescent service wires (not of course the extreme voltage to be found between any two wires of the system). Of late the majority of important stations employ lamps of 115–120 volts. Now and then 120–130 volts is reached, and very recently there has been a strong movement toward boldly doubling the usual voltages and employing lamps made for 200–250 volts.

A considerable number of scattered small plants use such lamps, and in a few cases central stations have adopted them in connection with three-wire systems, using thus about 440 to 500 volts between the outside wires. There is a decided tendency in this direction, and occasional stations have undertaken to change to this double voltage, at least to the extent of trying 220 volt lamps extensively. At present these lamps are of somewhat uncertain quality and rather high price, but they have been rapidly improved, both here and abroad.

It is undoubtedly much harder to get an efficient and durable filament for 220 than for 110 volts at a given candle-power. Such a filament is necessarily very slender and correspondingly fragile. If two 110 volt filaments mounted in series

would answer, the task would be simple, but such a combination gives double the required candle-power, which is generally undesirable. The net result of present experience is that while 220 volt lamps can be made to give excellent results in efficiency and life they are, as a rule, both poorer and costlier than the corresponding lamps of half the voltage. From the nature of lamp manufacture this condition is likely to remain, in perhaps lessened degree, even when the production of these high voltage lamps is extensive. The question between the two from a commercial standpoint will ultimately be a close one, although at present the advantage is altogether on the side of the lower voltage in most instances. The high voltage lamps are most satisfactory when of 20 to 32 candle-power and worked at 3.5 to 4 watts per candle. Under such conditions the filaments, being somewhat thicker than in a 16. c. p. lamp of similar voltage, and being worked at a lower temperature than the high efficiency lamps, give a reasonably good life.

Until much experience has been accumulated with reference to the high voltage lamps, their use in any considerable undertaking cannot safely be recommended. It would be particularly unwise to attempt it in a large transmission plant, where any trouble with the lamps would inevitably be charged against the general system. It is better, then, to select for incandescent lighting a voltage only so high as has been thoroughly tried — say 115 to 125.

The resulting service voltage on the secondary network depends on the system of distribution employed. There are actually employed for primary or secondary distribution with alternating currents about a round dozen of distinct methods, more or less convenient and inconvenient, and requiring very various amounts of copper for distributing the same amount of energy at the same loss and distance. Several of them are very convenient and valuable, others have as their only excuse for existence the desire to exploit a novelty or to evade somebody's patent.

The simplest of them all is the ordinary two-wire system worked with alternating currents. In this the maximum voltage of the lamps is the maximum voltage of the secondary system. To avoid this limitation and to secure the ability to

run motors is the principal function of the various modifications, polyphase and other, which make up the remainder. As these various systems are often exploited, it is worth the while to review them briefly, with special reference to economy of copper and convenience of installation on a large scale for the purpose we are considering. The two-wire system is shown diagrammatically in Fig. 298. Its main advantage is extreme simplicity. It requires the same amount of copper as a two-wire direct current system at the same effective voltage, and



FIG. 298.

is installed in the same general way, except that, owing to the peculiarities of alternating currents already explained, very large single wires are undesirable and armored conduits must be used with great caution, if at all.

As to motors for such a system, the case is not altogether what one would desire. Alternating monophase motors are not yet so satisfactory for general service as those of some other types, more particularly as regards starting and severe service, and, until considerable improvement is made in them, the pure monophase system is severely handicapped. The two-wire arrangement is always at rather a disadvantage in the amount of copper required both for feeders and service mains.

The most obvious modification of this distribution is its evolution into a three-wire system such as is familiar in Edison stations. The extreme working voltage is at once doubled,



FIG. 299.

and thus with the same voltage at the lamps, the cost of copper is greatly reduced. If the copper for a given two-wire system be taken as 100, that for the corresponding three-wire system is 31.25, assuming that the so-called neutral wire is of one-half the cross section of either of the others. Fig. 299 shows this familiar arrangement in diagram. Like every other system

which saves copper, a three-wire distribution is subject to certain inconveniences. In the first place, it is necessary to carry three wires instead of two over substantially the whole working area. Secondly, the lamps must be nearly equally divided between the two sides of the system. This balancing of the load is not particularly troublesome in a well-managed plant, and general experience has shown that the gain in copper far outweighs this disadvantage.

This three-wire distribution has been largely used for alternating current work. It is sometimes very convenient when applied to single or grouped transformers for the lighting of large buildings and regions in which balance of load is easily preserved. In such case the transformers are supplied from high voltage feeders, generally arranged on the two-wire system. As a rule, however, proper balancing is not easy in isolated districts, and the best use of the three-wire system is for

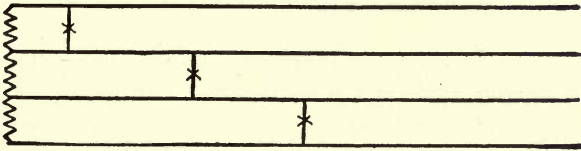

FIG. 300.

a general network of secondary mains, the voltage upon which can be controlled from a central station. In an ordinary direct current plant, the feeders are of course at low voltage, and a great advantage is gained for the alternating arrangement by feeders at two or more thousand volts supplying the mains through transformers. As regards motors, the alternating current three-wire system is on substantially the same basis as the alternating two-wire system.

More complicated pure monophase systems are seldom used, although there is an instance at Portland, Ore., of a four-wire feeder system; derived, however, from polyphase generators. Fig. 300 shows the arrangement of the lines, which are operated in general like a three-wire plant and require similar care in balancing, with the additional complication of running four wires and balancing three branches. The saving in copper is of course very great, the amount needed, allowing half the area

of the outside wires for each neutral, being about 16.6 against 100 for the two-wire plant. The corresponding five-wire system may be passed over, as it is not used at all for alternating currents, nor extensively in any way.

Next in proper order comes the so-called monocyclic system, which is essentially a monophas system, but heterophase with reference to the operation of motors. Its principal features have already been explained. So far as lights are concerned, it is simply the monophas system already described in both the two-wire and three-wire forms. The "power wire," which supplies magnetizing current for the fields of the motors, is only used in so far as is necessary for its special purpose, and

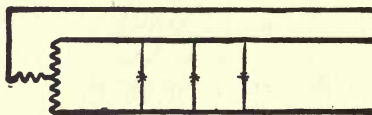

FIG. 301.

may or may not form part of the regular network. The two-wire monocyclic system shown in Fig. 301 describes itself. The expense and trouble of installing the "power wire" is the price paid for the ability to run motors. The total amount of copper is, of course, governed by the size and extent of the power wire. The main wires must accommodate the full current of the generator, for motors and lights must often be operated together, and at all events the machine must be fully utilized. The power wire, on the other hand, has to carry only a part of the current used in the motors. In a system heavily loaded with motors, the power wire might be one-half the cross section of each of the main wires. If then it extended over the entire system, it would add 25 per cent to the copper required for the main circuit. Generally its size or extent would be less than that just noted. The total copper required for a monocyclic system is then variable. Its relative amount may vary from 100, when the system is operating lights alone, to 125 for rather extreme cases of motor load.

The same general properties hold good for the three-wire monocyclic system shown in Fig. 302. It is treated like any other three-wire system, except for the addition of the power

wire wherever required. There is evidently a great saving of copper over the two-wire monocyclic, secured at the cost of running an extra wire as a neutral and balancing the load on the two branches. The relative weight of copper varies from 31.25 for lights only to say 40 when the motor system is extensive. Either form of the system is singularly easy to install and operate in plants already having a considerable network of lines, since there need be no rearrangement or balancing of circuits, but only an additional line wire running to the motors installed and extended hand in hand with the motor service. The monocyclic system is now very little used in practice, however, since it possesses no important advantages over

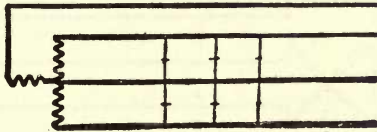

FIG. 302.

ordinary polyphase systems and is decidedly less satisfactory for motor service.

Passing now to the polyphase systems, it is well to reiterate what has already been stated in explaining them, viz., that they all involve about the same principles and lead dynamically to about the same results. They do, however, differ considerably in their characteristics as applied to a general system of distribution, and in rather interesting ways.

The diphas system can be worked either with four wires, *i.e.*, a complete and independent circuit for each phase, or with three wires. The former arrangement is the one almost invariably used. The two circuits can be worked independently for lights, but must be united to allow the operation of diphas motors. For the former purpose the two windings of the generator may be treated, save in one important respect, like separate monophase alternators. For the latter purpose they must work conjointly. Fig. 303 shows the relations of the two circuits. In a general system it is the best plan to carry the two circuits throughout the territory to be covered. In this way motors can be run anywhere. Otherwise, if the main circuits

covered different districts, connecting lines might have to be run at considerable expense for copper and labor, uniting the two systems. Further, when the two circuits are together, it is easier to divide the load evenly between them; which is desirable to prevent one circuit of the generator being overloaded before the other is fully used. Incidentally, hand regulation must sometimes be used for one or both circuits, unless the loads are equal as regards drop in the lines. If the generator is to be compound wound, the two phases must be equally loaded in order that the compounding may be able to hold the voltage on both phases alike. It must not be understood that unequal loads affect the voltage as in a three-wire system —

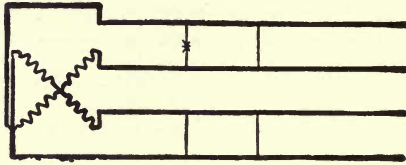

FIG. 303.

they merely produce different “drops” in the two systems, which cannot be equalized by the generator.

As to the relative amount of copper required, it is, when both phases are run together, 100. If separated, this may be slightly increased by cross connections for motors.

A diphase system can be organized with each phase forming a three-wire system like Fig. 299. This doubles the working voltage and so saves copper, but at the cost of very serious complication. The full distribution requires six wires, three per phase, and these must be carried together or cross-connected for motors, if separated. The first procedure — running two three-wire systems side by side over the same district — involves frightfully complicated wiring; and the second if the motors are at all numerous, requires a troublesome system of subsidiary lines. In either case, not only would each three-wire system have to be balanced in itself, but the two must be mutually balanced unless hand regulation is resorted to for one or both.

Altogether the diphase system with separated phases, does not lend itself readily to distribution for lights and motors

on a large scale, save in changing over existing monophasic or other two-wire systems, for which it happens to be exceedingly well suited. Its worst features are the large amount of copper required for secondary mains, and the forbidding complication of any attempt to secure economy by using the three-wire distribution. Like the diphasic interconnected system about to be described, and certain forms of the three-phase system, it is most practicable in plants of moderate size not requiring a complete sub-station with a full system of secondary mains.

The interconnected diphasic system, Fig. 304, employs a common return for the two phases. It has been often proposed but seldom used, for a good practical reason. The combined phases are unsymmetrical with respect to the inductance

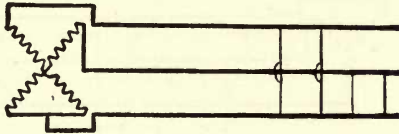

FIG. 304.

of the system, so that, even when the two sides of the system are equally loaded, the voltages between the common wire and the mains are unequal by an amount proportional to the inductive loss in the lines. Hence, it is unsuited for long lines either primary or secondary, overhead or underground. The lamps on the two sides of the circuit are at nearly the same voltage, but the voltage between the mains is so compounded of the two phases as to give increased working pressure enough to reduce the relative amount of copper to 72.8 under the most favorable circumstances. The system need scarcely be considered further, since it is more curious than valuable, and is unlikely to be employed in large sub-station work.

Three-phase circuits are variously arranged, as has been already indicated. The phases are very seldom separated, for a six-wire circuit is too complicated for general use, but are usually interconnected. The commonest and simplest connection is shown in Fig. 305. This consists of only three wires each running from the terminal of a phase winding on the

armature. Motors are connected to all three wires, and lamps between any two wires. The voltage is the same between each pair of wires, provided each pair be equally loaded. The relative amount of copper required is 75, as explained elsewhere. Here, as always, the uniting of circuits to save copper is accompanied by the need for balancing the loads. Not only does change of load on one branch change the drop in the other two, but interacts with them in the transformers and generators. The disturbance, however, is fortunately trivial in amount, except for very great inequalities of load or for abnormally large line loss. With ordinary losses in the line it is absolutely negligible when the circuits at full load are balanced within 10 or 15 per cent, and at light loads far greater inequality will have no perceptible effect. With ordinary care

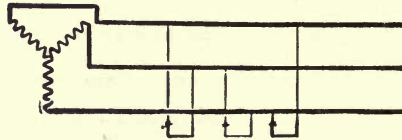

FIG. 305.

in arranging the installation the question of balance never assumes any considerable importance, and need not do so even when very close regulation is desired, although extra care is necessary in reaching first-class results. The main objection to the system of Fig. 305 is the considerable amount of copper required for a distribution by secondary mains as compared with the ordinary three-wire systems. Its salient advantage is its ability to handle motors and lights with equal facility on a system composed of only three wires, and with some saving of copper. The trouble of approximately balancing the three branches is regarded as insignificant by those who are operating such systems. This three-phase distribution is often taken from the three common junctions of a mesh connection, while for motors the connection is a matter of indifference.

A far better system for sub-station distribution is that shown in Fig. 306. It is a three-phase system with a neutral wire connected to the neutral point of the three-phase windings. The lamps are connected between this neutral wire and

the several main lines. The result is that the working voltage of the lamps is the voltage from either line to the neutral point, while the working voltage of the system is 1.73 times greater, being the voltage between line and line. Hence, there is a great reduction in the amount of copper required, the relative weight, as compared with the two-wire monophasic system, being only 29.2 if the neutral wire is taken of cross section equal to one-half that of either of the other wires. This system must be balanced approximately, but requires less care in this respect than the ordinary three-phase connection just described. It is on the whole, better adapted for large distributions of mixed lighting and power than any other of the modern alternating systems, since it combines a fairly simple arrangement of wiring with very great economy of copper. It lends itself readily even to underground service, giving a rather simple cable construc-

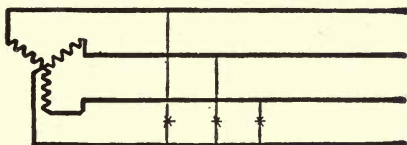

FIG. 306.

tion and facilitating testing. It is used with excellent results in the Folsom-Sacramento, the Fresno, and other important transmission plants, for the main work of distribution.

An interesting modification of the three-phase system is that used in the city of Dresden and shown in Fig. 307. Here the system is constituted in the ordinary way, but two of the leads, *a* and *b*, are arranged to carry all the lighting, while the third wire *c*, which may be of much less area, is used only in connection with the motors. It may even sometimes be advantageous to increase the cross section of two of the armature windings at the expense of the third. A machine so constituted would have fully as great capacity as a monophasic machine of the same dimensions, and still would be amply able to carry any ordinary motor loads. Even with the ordinary three-phase winding this connection may be used without serious reduction of output as compared with a monophasic generator of the same cost. Obviously the relative copper required may

vary from 100, when the load is of lights only, to 75 for the other extreme case. With half lights and half motors it would require 30-90 relative copper, according to the allowances made for drop, inductance, etc. In point of convenience it is

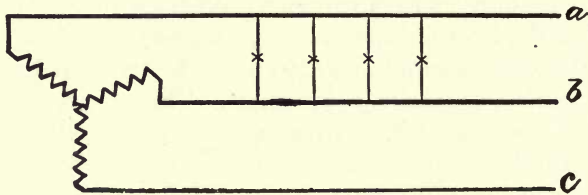

FIG. 307.

very similar to the "monocyclic" system, and like the latter may be used with great ease in remodeling monophase systems for motor work, without requiring special generators of a type which is tending to obsolescence.

A natural derivative of this mixed system is shown in Fig. 308. It is a combination of Figs. 306 and 307; *a* and *b* being the mains, *c* the motor wire and *d* the neutral wire. The relative copper required naturally varies with the proportion of motors and lights; 36 representing that necessary for an ap-

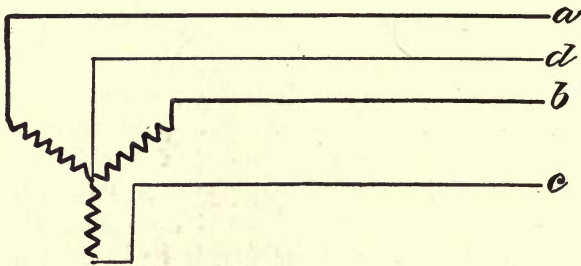

FIG. 308.

proximately equal division under ordinary conditions. Fig. 308 may be compared with Fig. 302, the monocyclic three-wire system. It is about the same in effect as the three-phase system with neutral, having but two branches instead of three to balance, and paying for this privilege with about 20 per cent more copper.

There is thus a liberal choice of methods more or less avail-

able for the general distribution of power and light. Any one of them may prove to be the most useful in particular situations. Now and then it may be worth while to use more than one of them in the same plant, as, for example, monophase two-wire and monophase three-wire or three-phase and three-phase with neutral.

It must be borne distinctly in mind that one cannot organize a large sub-station distribution successfully on any substantially two-wire system — the cost of copper is too great. If work akin to that of a large central station is to be done, methods must be used akin to those which have proved successful in such work. The methods of distribution must be those which are capable of giving a secondary network of moderate cost, easy to install and maintain. The use of alternating current gives a great advantage in the use of high tension feeders and in efficient methods of regulation, and there is at present no difficulty in furnishing a reliable and efficient motor service; but to secure the full advantage of all this, one must cut loose from the traditions of alternating current service. A transformer must be looked upon not merely as a device for lowering the voltage to a point available for direct consumption, but as a generator of extreme simplicity and enormous efficiency that operates without attention, can be started and stopped from any convenient point, and may be regulated without material loss of energy. That it receives current from a transmission line instead of energy of rotation from a steam engine is clear gain in simplicity, not a marvel to be looked at askance. On the contrary, the transmission plant is usually quite as manageable and trustworthy as a steam plant.

Approaching the sub-station from this standpoint, the problem of effective distribution becomes tolerably straightforward. Given the transmitted energy, it must be distributed over a known area cheaply and efficiently, with the smallest feasible loss of energy at all loads, and the best regulation attainable. It will not do to plead transformer losses when the lights burn dim, or the depravity of alternating motors when they flicker.

First, as to locating a sub-station. On general principles any station should be placed as nearly as may be at the centre of its load, and inasmuch as a transformer station requires

little space and makes no noise, there are few limitations to its position save the ability to bring to it the transmission lines, which, being generally at very high voltage, will be eyed cautiously by the municipal authorities. The main district to be

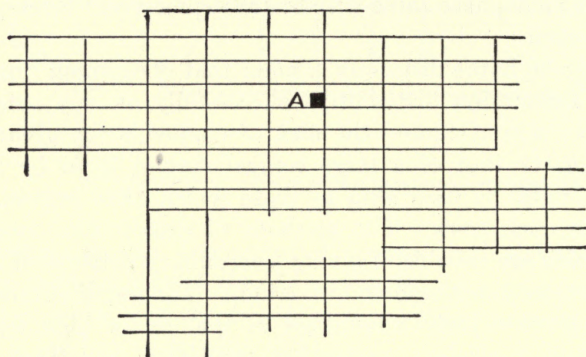

FIG. 309.

covered is generally quite definite, and the next thing to be done is to reach every part of it with a network of working conductors proportioned to the service. The nature of the

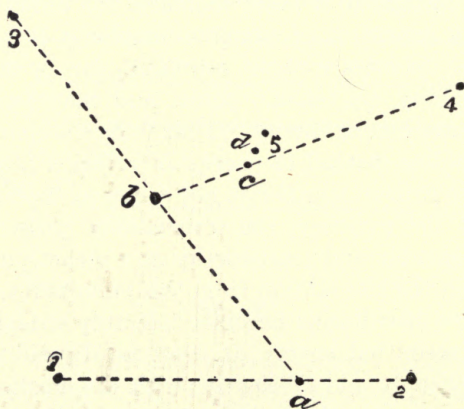

FIG. 310.

wiring will vary, according to the system employed; but the generally accepted principles are, save for inductance, the influence of which has already been considered, the same that are familiar in continuous current work.

The problem is to supply a certain amount of energy at a given loss over a known area, and the formulæ already stated give the key to the solution. Working out the details, however, is a somewhat complicated matter, requiring great judgment and *finesse*, and to be accomplished properly only by an experienced engineer, working on the spot. The intricacies of the problem are too great to be treated in an elementary treatise like the present. The general situation, however, is something as follows: A city, Fig. 309, is to be supplied with light and power from a transmission plant. Let A be the centre of load at which the transmission lines terminate. At this point can most advantageously be located the reducing sub-station, lowering the voltage of transmission to perhaps 2,200 volts for feeders, or to a tenth of this for direct supply. The centre of load considered is not the geographical centre of the district to be supplied, but the centre of gravity of the load. This is determined just as if the electrical loads at various points were weights fastened on a rigid weightless framework. For example, suppose there are given the loads of Fig. 310, five in number and in relative magnitude as shown by the figures. Connect any two of them, as 1 and 2. These would balance as weights at the point a , which acts with respect to other points as if 1 and 2 were concentrated at it. Now connect a and 3. These weights are equal, hence the point of balance is the middle point of a 3, b , at which the weight is evidently 6; b 4 balances at c , where the weight is 10, and finally the whole system balances at d , which is the centre of gravity. The points may be taken in any order, but each line must be divided so that, for instance, the length a 1, multiplied by weight 1, shall equal the length a 2 multiplied by weight 2.

The centre of load thus found should be the centre of distribution to secure maximum economy in copper. The fact that distribution lines usually run in a rectangular street system renders the solution thus obtained merely approximate, but it is nevertheless close enough for purposes of station location.

Recurring to Fig. 309, several methods of arranging the service are available. The simplest is, if the load is tolerably

concentrated, to institute a secondary network about *A* so as to include a good part of the load and then pick up the outlying load by transformers, placed where they can do the most good, fed from high tension feeders. Sometimes, however, there will be no heavy service near the centre of load, so that the whole work of the station will be done through high tension feeders, each supplying through its transformers a more or less extensive system of secondaries. Standard transformers are commonly wound for about 2,200 volts primary, but 2,400 volts and 3,100 volts are also regular primary pressures and the former is in considerable use. Above these figures small transformers are rather expensive, but if necessary the standard transformers can be used in star connection.

As has already been pointed out, there is every reason for using a secondary network, connected directly to the reducing transformers, at the sub-station if possible, thereby avoiding the expense of transformers for a second reduction in voltage and the loss of efficiency involved in such a reduction. The house-to-house transformer distribution should be shunned as one would shun the plague, if there is any expectation of securing an efficient station, capable of giving first-class service.

It must be remembered that to be successful, a modern plant for distributing power and light throughout a city must be able to compete with the best that can be done, not with the precarious and shiftless service of a dozen years ago.

It is possible with a modern alternating plant, to equal the best service given by a continuous current central station, but the feat can be accomplished only by the study of central station practice.

The sub-station at *A*, Fig. 309, should be treated, so far as distribution is concerned, as if the reducing transformers were ordinary generators. The transformer units should be of the size that would be convenient if they were generators, and the bank should be so managed as to keep the transformers in use as thoroughly loaded as possible. From the transformer bank should run feeders to the principal sub-centres of distribution in the network, with pressure regulators in such of the feeders as require them. From these sub-centres, pressure wires should

run back to the station whenever needed for the guidance of the operator in charge of the regulators.

Outside the effective radius of distribution of the principal secondary network will come the independent sub-centres referred to, with their high tension feeders and subsidiary networks. These latter should be, so far as possible, interlinked so that, at times of light load, only the transformers actually needed shall be in service. If secondary pressure wires are brought home from the subsidiary networks, all the regulation can be done on the high tension feeders, thereby giving equally good service all over the plant. Most continuous current stations extend their lines far beyond the radius that is economical for low tension currents, and often have to depend on boosters with feeders worked at a heavy loss for service in the outlying districts. With an alternating system this difficulty is avoided, and the loss in transformers and regulators is far less than that incurred with boosters and long low tension feeders.

As for the motor service in such a system, it should be treated by common sense, as it would be in a central station distributing continuous current.

Alternating motors, polyphase or other, can be connected to the secondary mains up to the point at which their demands for current become burdensome. At that point the mains must be reinforced or special feeders run, just as would be the case with continuous current motors. The only difference is that produced by the so-called idle current in the alternating motors, which simply means that the point in question is reached a little sooner than with continuous current motors. In practice this difference need not be enough to be of serious moment in plants having the ordinary proportions of lights and motors. In case of large motor plants in which the service is severe, the use of special high tension feeders will relieve the trouble that might be experienced with the lights, but this expedient is one to which recourse would seldom have to be taken on a large scale.

The greatest difficulty in such sub-station distribution is, as has been already indicated, the arc lighting. At present the alternating arc lamp is hardly adequate to meet all conditions,

although it is coming gradually into more and more extended and successful use.

In cases where power is to be supplied for railway purposes, there are few difficulties in the way. Existing railway generators can readily be utilized by driving them from synchronous motors. This is the method employed in the old transmission to Sacramento, Cal., and elsewhere not infrequently. Where the utilization of the old machine is not important, or in new plants, the tendency is to use the rotary converter, which has been already fully discussed. Such apparatus was first put into extensive use in the Portland (Ore.) transmission plant, and is now largely and very successfully employed everywhere. Continuous current for other purposes may be obtained with ease by the various methods described in Chapter VII. A very instructive example of recent practice in sub-station distribution may be found in Salt Lake City, Utah. This city is supplied with electric power from a group of transmission plants, the general location of which is shown in Fig. 311. These plants were started independently, but later were consolidated with the local lighting interests and are operated together. The Big Cottonwood plant, started in 1896, contains four 450 KW, three-phase generators, and has a double 10,000 volt circuit 14 miles long into Salt Lake City. The Ogden plant, started the succeeding year, has five 750 KW three-phase generators, at 2,300 volts, at which pressure energy is supplied in the city of Ogden. The rest of the output is raised to 16,000 volts and sent into Salt Lake City over a pair of circuits 36½ miles long.

The third plant, that of the Utah Power Co., is like the first, in the Big Cottonwood Cañon, but is two miles nearer the city, and contains two 750 KW two-phase generators, with a two-phase-three-phase raising bank of transformers to 16,000 volts, feeding duplicate three-phase circuits.

These are now (1905) also interlinked with the Provo system with its plants on the Provo River and with a 2,000 KW plant at Logan, some 40 miles to the north of Ogden. The longer lines are worked at 40,000 volts. The whole system comprises six hydraulic plants, two auxiliary steam plants, and 420 miles

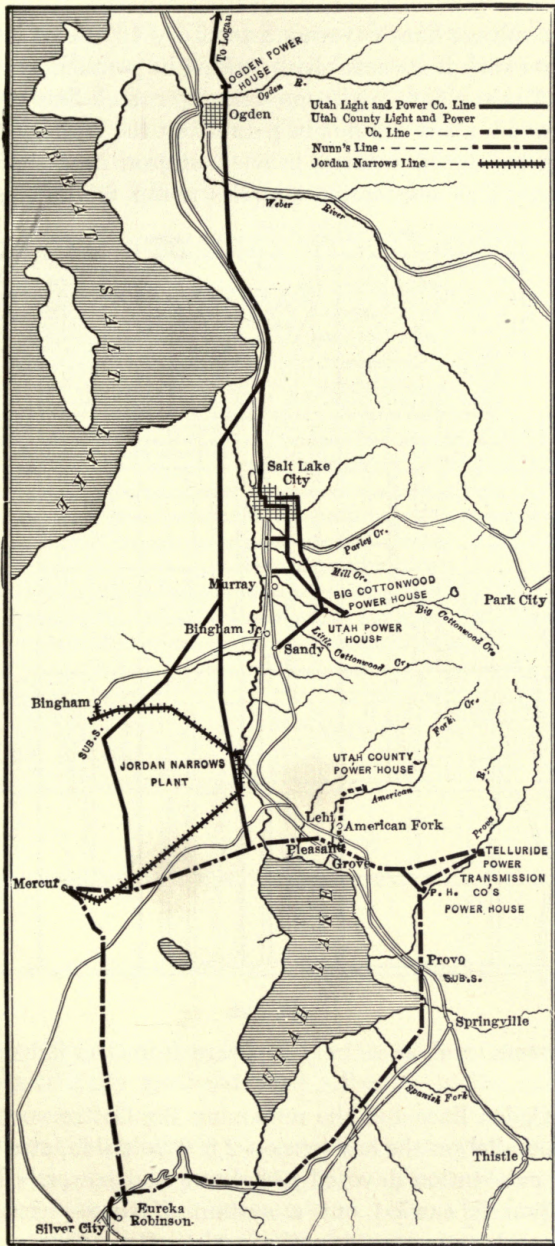

FIG. 311.

of high voltage lines covering a territory 160 miles long. The entire network is successfully operated in parallel.

The Utah plant, with one generator and line of the Big Cottonwood plant are put in parallel on the high tension side, and run two-phase rotaries in a sub-station near the centre of the city. This sub-station supplies power to the electric rail-

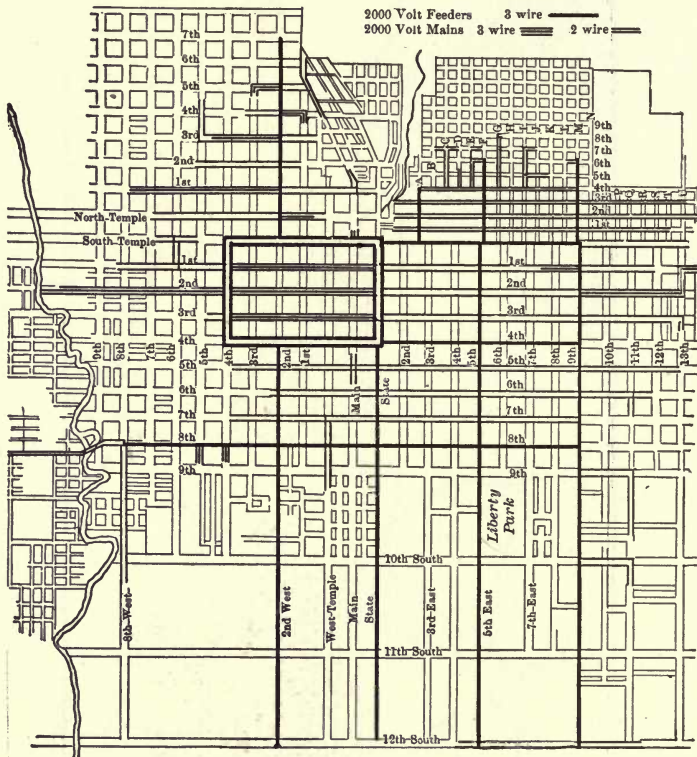

FIG. 312.

way system, and is entirely separate from the lighting distribution.

The Ogden lines and the remaining Big Cottonwood line are put in parallel on the low tension 2,300-volt side, at a centrally located sub-station devoted to lighting and power. From this sub-station is carried out a system of three-phase primary feeders and mains serving the entire city. This network is

well shown in Fig. 312. The primaries are connected in mesh, but the secondaries have the star connection with neutral, forming a regular three-phase four-wire distribution, with 115 volts between the neutral and either phase-wire. Motors are connected to the three-phase wires, giving about 200 volts, and all motors over 10 HP are put on transformers of their own.

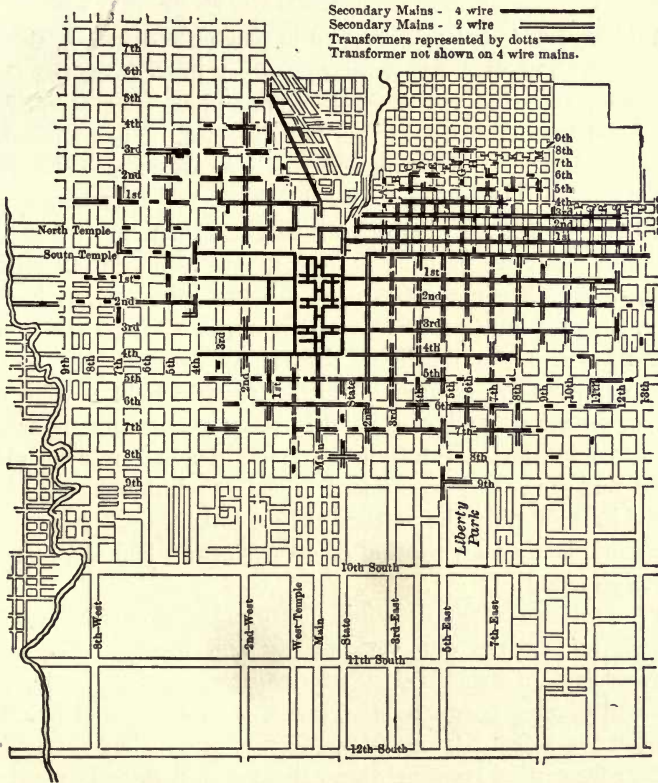

FIG. 313.

As appears from the cut, Fig. 312, the primary network is quite symmetrically arranged with reference to the extension of service.

The secondary service is developed into a systematic network of mains, well shown in Fig. 313. Where the service is dense there is a regular four-wire network. Each block is served by two groups of three transformers at the opposite corners,

from which secondary mains are carried around the block and tied by fuse boxes to the secondary mains of adjacent blocks. When a distribution of this sort is used, fuse boxes and cut-outs should be judiciously employed on both primary and secondary networks, so that in case of severe short circuits or of fire the district affected can be promptly cut clear of the rest of the system.

Where service is less dense, as in residence districts, the first step is to put in a two-wire secondary main from the transformers, consisting of a neutral and one phase-wire, street being balanced against street in this light service. Then when business demands, the other phase-wires are carried into the street, lights balanced upon them, and the completed four-wire system is then tied to the network already completed.

Commercial arc lighting is by constant potential alternating arcs, of which some 500 are in use in Ogden and Salt Lake City. Street lighting is at present supplied from continuous current series arc machines driven by synchronous motors. These motors are located in an old electric light station near the sub-station, and can be driven as generators in case of need, while the sub-station itself has a small reserve steam plant and generator equipment. The synchronous motors are useful in regulating the voltage at Salt Lake City, being capable of accomplishing a variation of 10 per cent when the lines are heavily loaded.

This scheme of sub-station distribution is admirably conceived, and works out very simply and neatly. The transmission system itself is decidedly complex, owing to the various and diverse power houses, but it works well and has done excellent service. It is interesting to note that no trouble is experienced in running these distant and diverse plants in parallel. At light load there is some interchange of current, but at heavy loads everything settles down to business.

All the stations are connected by telephone, and by a little intercommunication the generators can be put in parallel in the ordinary manner either at a station or at the sub-station in Salt Lake City. The record of the system for continuity of service has been good, and it is worth noting that most instances of trouble on the lines have been due to malicious interference,

such as shooting off insulators and throwing things across the lines. Altogether the system is a notable instance of the flexibility and convenience of modern power transmission methods, as well as a good example of a systematic and logical development of the distribution system. As the service grows various refinements will doubtless suggest themselves, but the system is correctly started and there will be little work to undo. It is in striking contrast with some transmission systems which could be named, in which the operators, less skilled in dealing with modern methods, have blundered around trying to give good service in an unsystematic and helter-skelter fashion, getting deeper into trouble at every jump, and then blaming the state of the art for the results of their own lack of discretion.

The most delicate and important work in connection with heavy sub-station service is that involved in the proper regulation of the voltage. The sub-station receives its supply of energy often from a long transmission line in which there is considerable drop, to say nothing of that encountered in the generators and two banks of transformers.

It must distribute this energy throughout a complicated network, so that the variations in pressure at the lamps shall not exceed two or three volts at the outside. This is never an easy task — it tries the ingenuity even of the best central station engineers.

In connection with a transmission plant, probably the best plan is to divide the regulation into two stages: first, that concerned with the transmission proper, and second, that concerned with the distribution. By compounding the generators, or by hand or automatic regulation of generators having good inherent regulation, it is certainly possible to hold the voltage closely constant up to the primary terminals of the reducing transformers. In large alternating generators ordinary compounding is seldom or never attempted, and in many cases the sole reliance is hand regulation, which is by no means to be despised in the absence of other means.

Within the last few years several automatic regulators capable of giving excellent service have been brought out, and they are coming into somewhat extensive use. The two principal forms have already been described.

None of these regulators are arranged automatically to take care of the line drop when the power factor varies considerably, but they are amply sufficient to provide for the general regulation up to the sub-station, at which point it may be taken up as a separate problem. This residual regulation ordinarily consists of the drop in the reducing transformers, which should be not over 2 per cent; the drop in the feeders and secondary mains; in high tension feeders and transformers when employed; and finally in the house wiring. These losses will aggre-

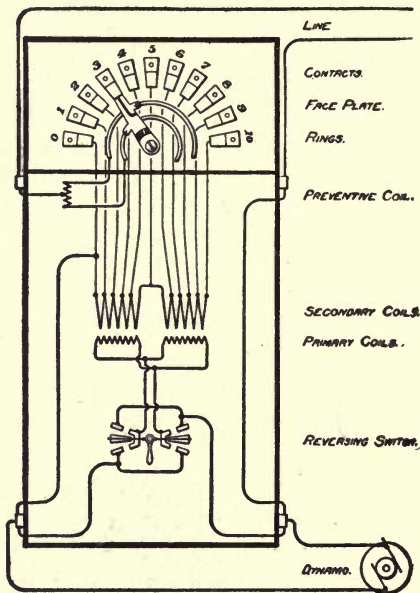

FIG. 314.

gate generally less than 10 per cent, and are best cared for in the sub-station. As the variations in load, and hence in loss, are generally rather slow, this regulation should be accomplished without difficulty. In some cases it may be advantageously reduced in amount by carrying the primary regulation through to the secondary terminals of the reducing transformers.

However this may be, the regulation of the voltage on the secondary lines must be carried out with the utmost care.

The apparatus employed for this purpose is both very simple and exceedingly efficient. It is in every case a transformer arranged to give a variable ratio of transformation and adding its E. M. F. to that of the working circuit.

The best known form of this device is probably the Stillwell regulator, which has for some years past been very successfully used by the Westinghouse Company. It is, in effect, a transformer, from the secondary coil of which leads are brought out to terminals so arranged as to enable one to vary the number of secondary turns, and so to vary the E. M. F. added to the working circuit. Fig. 314 shows a diagram of the connections by which this result is effected. The diagram is self-explanatory, except that it should be noted that the "preventive coil" is intended to avert the necessity of breaking circuit or short circuiting a secondary coil in passing from one contact to the

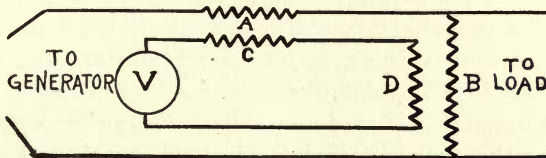

FIG. 315.

next, and that the reversing switch enables the regulator to diminish the voltage on the working circuit, which may now and then be convenient. In the ordinary practice of the Westinghouse Company, this regulator is installed in the generating station and used to vary the voltage on the primary line. In sub-station work it can be applied either to the primary or secondary side of the reducing transformers; practically the latter is the working connection. These regulators are made to have a range of action of 10, 15, and 20 per cent of the working voltage. They are generally employed with a very ingenious device known as the "compensator," the function of which is to indicate the pressure at the end of the line or feeder without the use of pressure wires. The principle of this is shown in Fig. 315. The voltmeter V is in circuit with the opposed E. M. F.'s of two secondaries C and D , of which the primaries A and D are respectively in series and in shunt with the load. The voltage of D is proportional to the main primary E. M. F., that

CIVIL ENGINE
U. of C.
ASSOCIATION LI

of C to the primary current strength, so that the difference between C and D , which shows on the voltmeter, can be made proportional to the voltage as reduced by the drop due to the current in the line. The compensator is in addition provided with a series of contacts by which the E. M. F. of C is adjustable for any given percentage of loss in the line.

The practice of the General Electric Company is somewhat different. The generator is generally over-compounded for a fixed loss in the line at full load, or hand regulation is effected by the field rheostat. For sub-station purposes a variable transformer is employed to vary the working voltage. The principle of this voltage regulator is the variation of the inductive relation of primary and secondary instead of varying the number of secondary turns. The apparatus itself is made in several forms, one of which, used in a number of three-phase plants, is shown in Fig. 262. It is essentially a transformer with a movable secondary, and serves either to raise or lower the working voltage, as occasion requires. The gradation of voltage is not by definite steps, but by continuous variation. The apparatus is made for substantially the same range of action as the Stillwell regulator just described, and accomplishes the same result. The General Electric Company also makes a voltage regulator with a variable number of secondary windings.

It should be stated that neither over-compounding nor any similar devices can deal successfully with a load of very variable power factor such as is often found in motor service. They can be made to work well on either non-inductive *or* inductive load, but are not well adapted for a load of which the power factor varies much. For this condition nothing has yet been devised so good as pressure wires combined with intelligent hand regulation.

Various attempts have been made to employ pressure wires in conjunction with automatic regulators, but none have yet met with very encouraging success. Automatic control of alternating current sub-station regulators is by no means so simple a matter as pressure regulation applied to the generator. Apparatus of the type of the Stillwell regulator has to deal with fairly large currents, and the contact arm, to prevent undue

load on the "preventive coil," should be quickly moved from segment to segment. This involves various mechanical difficulties and the expenditure of some power. Apparatus like Fig. 316 works none too easily, on account of the magnetic forces involved. Such regulators are sometimes motor-driven and thus readily controllable from the switchboard. In fact, it is safe to say that the problem of working sub-station regulators automatically involves the use of powerful relay mechan-

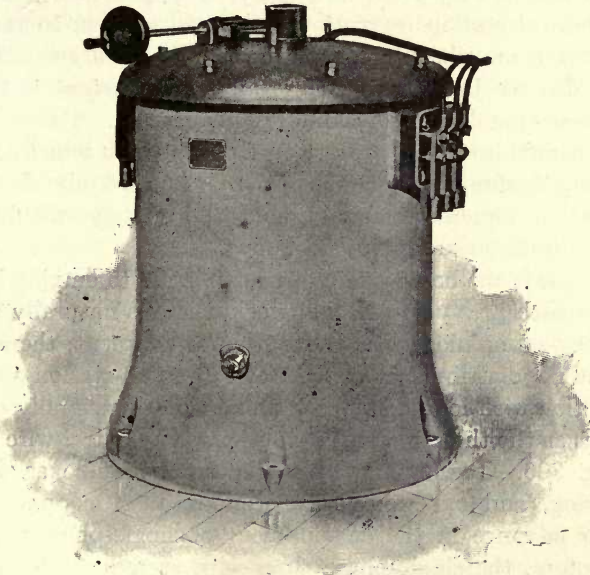

FIG. 316.

ism akin to that used for water-wheel governors, although on a very much smaller scale.

No such apparatus is just at present in practical use, although if successful it would be in considerable demand. Still less progress has been made toward the development of an automatic balancing device for polyphase circuits. Given a good automatic sub-station regulator, and its application to preserving accurate balance in a two-phase or three-phase distributing system is an obvious extension of its general use. Balance is not difficult to secure with a little tact in arranging

the load, but sometimes when there is a particularly heavy lap load, there will be sensible unbalancing while this load is coming on and going off. This is taken care of sometimes by having certain loads that can be switched at will upon any leg of the circuit, and sometimes pressure regulators are installed for manual operation. A good automatic balancer and pressure regulator would often be of very considerable service, but it is not yet forthcoming. It must not be supposed that the lack of it is a very grave deficiency, since practically all ordinary central station regulation is manual save in so far as it can be accomplished by over-compounding the generators.

The devices just described are amply competent to furnish very exact regulation for sub-station purposes. Its completeness depends in the last resort on the skill with which the distributing system is designed. If this is carefully done, the sub-station regulation should hold the voltage within very narrow limits clear up to the lamps.

As regards the best system of transmission to employ in connection with heavy sub-station work, there is naturally a wide diversity of opinion. In the author's judgment, there is at present no distributing system for large sub-station work in connection with long-distance transmission so generally advantageous as the three-phase distribution with neutral wire shown in Fig. 306. It is remarkably free from trouble as regards balancing, and extraordinarily economical of copper. With further advance in the development of single-phase alternating motors, the single-phase three-wire system shown in Fig. 299 will do admirable work when the motor service is rather light. The diphas system has been installed in some central stations and the "monocyclic" in others, so data will eventually be available regarding each of these systems, but there is little reason to expect as good general results as could be obtained by the systems mentioned above. Diphas, monocyclic, and the Dresden three-phase systems are, however, very much easier to adapt to the circuits of present stations than is the three-phase system with neutral wire.

When a large part of the output of a transmission plant is required for railway work and other motor service of extreme severity, and a lighting system is also to be operated, it is a

wise precaution to work the two services normally over separate lines and from separate generators as is done in the Salt Lake City system just described. Otherwise the variations of load may be so great and so rapid that no care in regulation could prevent serious fluctuations in voltage. A small railway load and all ordinary motor service can be worked from the same circuits as lamps without much difficulty. These limitations are not peculiar to transmission plants — no Edison station, for instance, would dare to attempt working a low voltage conduit railway from its lighting mains. In these, as in many similar matters, a little common sense will prevent serious mistakes and show the necessity of working every system so as to obtain the best possible results, and not to discover what it will endure without giving intolerably bad service. Of late storage battery auxiliaries have often been suggested, and sometimes have been employed, in connection with power transmission plants. Some reference has already been made to storage in Chapter II, but the matters here to be considered are of a different character. In transmission work a battery may be used for two entirely distinct purposes. In the first place it may be used, as it sometimes is in steam-driven stations, for the purpose of storing energy at times of light load to be used in making up deficiency of power at times of heavy load.

In steam-driven stations the installation of a battery effects a considerable economy by enabling the engines to be run at all times at the points of maximum economy, and an additional saving, in first cost, by reducing the capacity of the steam plant and generators required. The conditions of economy depend mainly upon local circumstances, but a material saving can be made in many instances by using the battery.

In hydraulic practice the case is different. In the average water power plant the main hydraulic works should generally be installed for the full available capacity, save in the few instances when a partial fall can be economically utilized. As a rule the dam will be substantially the same for a partial development as for a complete one, and the latter can be carried out more cheaply at the start than when added as patchwork later. Consequently there is seldom or never any saving in

installing a costly battery subject to heavy depreciation in order to avert the first cost of a larger plant. Further, the loss of energy in the battery is much greater than the loss ordinarily incurred in the line at full load, so that the total saleable power for a given first cost would in nearly every case be reduced by installing a battery. The one case in which a battery can advantageously be used in connection with power transmission for the purpose indicated, is that in which the total hydraulic power available is actually insufficient to carry the required maximum load. Storage may then be very advantageous, since it enables the unutilized power at light load to be applied to the peak. Especially will it be advisable when the peak is high and the load factor rather poor, under which conditions a battery may raise the possible maximum output by 30 to 50 per cent, sometimes even a little more.

The second use of a battery is as a reserve to tide over a brief break down. The question of reserve against accident in transmission work is always a troublesome one. In the author's opinion the need of a complete reserve located in the sub-station is overestimated. Experience clearly indicates that of the interruptions of service occurring on the system of a transmission plant with sub-station distribution, only a very small minority occur on the transmission line proper. The distribution lines throughout an average city are peculiarly exposed to interruption from limbs of trees, which in residence streets can never be adequately trimmed; from the fall of foreign wires; from necessary cutting off in case of fire, and from other causes. A high voltage transmission is neither more nor less likely to encounter trouble on its distributing system than an ordinary central station. So far as these causes of trouble go, the transmission plant's sub-station is exactly on a par with any other central station in requiring special precautions. Now while central stations always should have more or less reserve apparatus to use in case of break down, it is not required on account of possible trouble on the line except as such trouble may injure apparatus. A short circuit on the feeding system will not be removed by the presence of a spare engine and dynamo in the station. Hence, the need of reserve in the sub-

station of a power transmission system bears relation simply to the accidents which may affect continuity of service as regards the main transmission line, and particularly accidents producing more than momentary interruptions. Such accidents are rare on properly designed and erected lines, and save on extremely long lines of which the cost is a considerable part of the total cost of the system, it is generally true that a fraction of the cost of a complete reserve plant at the sub-station would provide a duplicate line so guarded that reserve apparatus would be practically needless. With well-built duplicate pole lines and proper switching arrangements, serious trouble on the lines, save under conditions which would also paralyze the service on the distributing system, and thus cripple the plant in any event, becomes almost impossible.

Sometimes, however, a partial auxiliary plant is extremely useful, but it is rather for its convenience in case of repairs to apparatus at the generating station or sub-station than as a safeguard to the main line. In working a large sub-station, a storage battery may be of considerable use in this way, particularly if the system is being pushed near to its capacity. It is decidedly not good policy, however, to use a battery unless the station is upon a scale large enough to warrant the employment of an especial man skilled in handling batteries and unburdened with other duties. Charged and discharged through motor generators or rotaries, a storage battery can be put into service on a moment's notice, and is far less troublesome to keep up than any other auxiliary for temporary use.

In some localities a generator coupled to a gas or oil engine makes an admirable auxiliary. Such engines can now be obtained of large output and very high economy, and form a reserve almost as convenient as a battery. Steam reserves are not large in first cost, unless high economy in operation is attempted, but cannot be put quickly into action unless the fires are kept banked, which is a very considerable expense. However, by keeping a banked fire under threatening climatic conditions the reserve can be ready when it is likely to be needed, and if apparatus needs repair there is generally notice enough given to get steam up. Power of quick firing is of great importance in boilers for an auxiliary plant, and with

tactful treatment a steam reserve is probably the most satisfactory for plants of moderate size.

In an increasing number of cases a steam auxiliary plant is used to supply a deficit of power at times of low water. The more use required of such a plant the more regard must be had for high economy, in which respect it must be sharply distinguished from an auxiliary used merely to tide over emergencies and accidents.

CHAPTER XVI.

THE COMMERCIAL PROBLEM.

POWER transmission is of little avail if it does not pay, and the chances of commercial success form the first subject of investigation in the development of any power transmission enterprise. Reduced to its lowest terms, the question presents itself thus: Can I profitably furnish power at a price which will enable me to undersell the current cost of power production? Evidently this question cannot be answered *a priori*, but must be thoroughly investigated in each particular case.

The first thing to be determined is the existence of a sufficient market, the second thing is the price current in this market. It is not difficult to find out the gross amount of power used in a given region, but it is exceedingly hard to discover the real cost of production. Even if all men were strictly veracious it is a fact that very few users of power have any clear idea of what they pay for it. Coal bills and wages are tangible and men realize them, but interest, depreciation, repairs, miscellaneous supplies, water, taxes, insurance, and incidentals, are seldom rigorously charged up to the power account, and these are large items when power is used irregularly.

Further, the cost per HP is often computed from the nominal HP of the engine, without exact knowledge of the real average yearly load. Hence, people often think that they are producing power at \$15 or \$20 per HP per year when the real cost is \$30 to \$50.

The most exhaustive researches as yet made on this subject are those of Dr. C. E. Emery. The accompanying table gives a summary of his results, based on 500 net HP delivered for ten hours per day, 308 days in the year. The power is supposed to be derived from a single engine worked continuously at its normal capacity. These figures represent results much better than are generally reached in practice, since most en-

gines are not worked continuously at full load. In a large majority of cases the real cost exceeds that given in the table, even for engines of similar size. For the rank and file of small engines used for miscellaneous manufacturing purposes, cheaply built and generally underloaded, the tabular figures should

Kind of Engine.	Coal \$2 per T.	Coal \$3 per T.	Coal \$4 per T.	Coal \$5 per T.
Simple high speed	\$29.81	\$36.17	\$42.51	\$48.90
Simple low speed	28.46	34.20	39.94	45.67
Simple low speed, condensing	22.82	26.77	30.73	34.69
Compound condensing, low speed	21.97	25.53	29.09	32.65
Triple expansion condensing, low speed	22.35	25.32	28.28	31.25

be nearly doubled. In regions where coal is unusually dear the cost in units of 50 HP and upward may range from \$100 to \$150 per HP year for a ten-hour day. Costs considerably below those in the table are now and then reported, particularly from engines in textile mills where the load is especially favorable. Some of the reduction is undoubtedly due merely to bookkeeping, a portion of the expense properly chargeable to power being taken care of elsewhere, but some very low genuine costs have certainly been secured. Dr. Emery's tables are based on costs which can be materially lowered at present prices as regards certain items, and they include some items of expense which in favorable cases can be reduced. For example, in the case of large engines the labor cost is materially less than with the 500 HP assumed, and the interest charge for an engine considered as part of a manufacturing plant might properly be reduced to 5 per cent.

Then the table is based on average steam consumption, while in recent mill engines a better figure is justified.

Assuming a power of 1,000 BHP and coal at \$2.00 per long ton, and making the necessary modifications in the data as just indicated, the cost of the HP year on the basis of 308 days of 10 hours each per year, with first-class compound condensing engines, falls to about \$17 to \$18. These figures have unquestionably been reached in actual practice, although rather

seldom. They must, however, now and then be reckoned with, and can be met only by very carefully planned transmission from an unusually cheap water-power. As a rule, even in large engine plants, the cost per HP year of 3,080 hours runs above rather than below \$20. On variable load the costs are likely to run 20 or 25 per cent higher. There are few cases in which transmission from cheap water-power on a large scale cannot beat out steam power even in large units.

In units under 50 HP one is very unlikely to find the HP year, reckoned on the above basis of 10 hours per day, costing less than \$50, even with coal as low as \$2 per long ton. These are the facts in the case; the fancies will be duly appreciated if one canvasses for electric power. Not more than one man in six knows and will admit that his power is costing him as much as the table would indicate. The process of reasoning (so called) is often about as follows: "I paid for my engine and boiler house when I built the factory, and I do not propose to charge my engine rent. It has been running ten years and is just as good now as it ever was; has not depreciated for my purpose a cent. If any repairs were needed, the engineer and one of my men have made them and they haven't cost me anything but my material. My fireman I have to have anyhow, for I heat by steam, and my taxes and insurance I have to pay anyhow: that is a 200 HP engine; my coal cost me \$2,450 last year, and oil and stuff \$70. I pay my engineer \$60 a month; that's \$16.20 per horse-power per year; if you can furnish electric power for \$15 per year perhaps we can trade." This theme, with variations, is familiar to anyone who has had practical experience in power transmission work, and although the more intelligent and able class of manufacturers are quite too keen not to see the facts when properly presented, a certain amount of this ignorant short-sightedness is always met in investigating the power market.

With a working year as above of 3,080 hours, the cost of steam power is actually very seldom as low as 1 cent per HP hour, and in units below 100 HP is not very often below 2 cents. In units of less than 20 HP it is quite certain to be 5 cents or more. These figures are based on continuous working. If the use of power is intermittent, the cost per HP hour

is increased, by an uncertain but always large amount, depending on the nature of the service. For highly intermittent service, gas engines are undoubtedly cheaper than steam, and in ordinary units the cost of operating these is seldom less than 10 cents per HP hour of use. Used continuously at full load or thereabouts, the gas or petroleum engine is the most formidable competitor of electric motors, since the actual cost of fuel is low — from 2 to 5 cents per HP hour — and the attendance required is trifling. Such engines, however, are high in cost and are inefficient at low loads, besides being subject to relatively large depreciation.

These peculiarities are well shown in a recent test of a 6 HP gas engine in which the following facts appeared: The cost of operation, including maintenance, was at full load 41 cents per hour, and at no load 20 cents per hour; the cost of gas being \$1.70 per M feet.

We may easily find from this the cost of power under given circumstances of use; \$10 per HP per year may fairly be charged up to interest and depreciation. Suppose, now, power is used for 10 hours per day 308 days in the year, the engine being fully loaded all the time. The cost can be made up as follows for 6 HP:

3,080 hours @ 41 cents	= \$1,262.80
Interest and depreciation	= 60.00
Total cost	= \$1,322.80

Cost per HP hour = 7.15 cents, of which the interest and depreciation amounts to but 0.31 cents per HP hour.

Second, suppose the engine is in full use 3 hours per day, and running idle the rest of the time, or is in equivalent partial use for 10 hours. We then have

924 hours @ 41 cents	= \$378.81
2,156 " " 20 "	= 431.20
Interest and depreciation	= 60.00
	= \$870.01

This is 12.08 cents per HP hour actually used, and is a fair type of present practice as gas engines are generally used. It will hold for the average engine used for small power purposes. In regular running such engines consume from 25 to 35 cubic feet of average illuminating gas per brake HP and, when run-

ning light, take nearly half as much gas as at full load. In careful experimental running these results can be bettered 10 to 20 per cent, but in regular work and with only ordinary care, the gas consumption given is correct.

Petroleum engines give rather less fuel expense, but lose in extra care and repairs nearly or quite all the gain in fuel.

These figures must not be understood as applying to large gas engines of 100 HP and upward, worked on cheap "producer" or fuel gas. It is reasonably certain that such engines give results better than any save the most economical steam engines, if worked at or near full load. The dubious point about such large gas engine plants is the maintenance, particularly in case a producer is installed. In the small sizes above considered the gas engine is a considerably cheaper source of power than steam engines, probably by not less than 30 per cent. It must not be forgotten also that the cost of power from small gas engines is steadily being reduced owing to the great stimulus given to engine design and operation by the development of the automobile industry.

In a general way we may summarize these facts regarding cost of power as follows, coal being taken at \$3 per ton:

Kind of Engine.	Cost per HPH, 10-Hour Day, Fully Loaded.	Cost per HPH, Intermittent Use, Partial Load.
Large compound cond.	0 8c. to 1c.	1c. to 1.5c.
Simple, 100 HP and less	1.5 " 2.5	3. " 5.
Gas, 20-50 HP	2.0 " 4.0	3. " 7.
Gas, small	5. " 8.0	10. " 15.
Steam, small	7. " 12.	12. " 20.

By small engines are meant those not over 15 to 20 HP, such as are used in large numbers for light manufacturing work. These figures are of course only approximate, and must be modified by the cost of fuel and labor in any particular locality.

They take no account of the efficiency lost between the engine and its work, which has been already discussed in Chapter II, and which gives motor service some of its greatest commercial advantages.

They show plainly, however, that electrical energy delivered to the consumer at 4 to 5 cents per kilowatt hour has the com-

mercial advantage in small work of all kinds, and in competition even with fairly large engines used at light load or intermittently. In addition there is, in favor of electricity, the generally considerable saving in waste power, and the greater cleanliness and convenience of the motor. At equal prices electric power will pretty effectively keep steam out of all new work, but the cost of changing from one motive power to the other demands some concessions on the part of electricity.

This cost of change is rather uncertain, for not only do electric motors vary very widely in price, owing to differences in size, speed, and construction, but the net value of engines and boilers replaced may vary from two-thirds to three-quarters of their cost down to little more than scrap.

In both engines and motors the cost of the smaller sizes is disproportionately large, owing to the relatively large percentage of labor in their construction. Gas engines are even more expensive than a steam boiler and engine in ordinary sizes. In replacing engines by motors, the selling value of the former, including boilers, if steam is used, may be anything, say from \$10 to \$25 per HP, and the market is rather uncertain at best. A little time will generally effect a sale on tolerable terms.

The following table gives the approximate cost of electric motors installed and ready to run, based on motors of ordinary speeds and voltages, with the usual accessories and with a moderate amount of wiring. No useful figures can be given on the cost of special installations with complex wiring.

HP.	Cost.
1	\$ 75 to \$ 125
3	150 " 250
5	200 " 275
10	300 " 450
15	350 " 450
20	400 " 600
25	500 " 700
30	600 " 800
40	700 " 900
50	800 " 1,100
75	1,200 " 1,500
100	1,500 " 2,000

From this it appears that while large motors, 50 HP and upward, can generally be counted on at not over \$20 per HP, the smaller sizes are much more costly. Below 20 HP the net cost of changing from steam or gas engines to motors is pretty certain to be \$20 to \$30 per HP. Taking interest and depreciation at 10 per cent, the annual charge amounts to \$2 or \$3 per HP, which must be increased to \$5 or \$6 to cover maintenance and miscellaneous expenses. Hence, for steady use 10 hours per day, there should be charged to general cost about 0.2 cent per HP hour, which is equivalent to perhaps 0.5 cent for intermittent use.

In changing motive power, then, electric service must generally be cheaper than what it replaces by about the amounts mentioned.

As to the cost of furnishing electric power figures are a little deceptive, since from place to place the conditions vary. It is safe to allow about one KW at the station for one HP actually delivered and paid for.

Now with steam for a motive power, the data already given for mechanical power can readily be reduced to kilowatt hours, assuming the dynamos to have as usual 92 to 95 per cent efficiency at full load. But a steam station for power transmission has the advantage of nearly or quite continuous running, thereby reducing general expenses, and besides, on a large scale, the load can be kept at an efficient point most of the time. In fact, in large railway power stations — the only steam-driven stations for power transmission on a large scale — the machines can be worked very efficiently most of the time, and power can be, and is, very cheaply produced.

Fig. 317 shows graphically the approximate variation of total cost with output in well-designed power stations, the figures given being based on \$3 per ton for coal and power delivered at the station bus bars. Anything under one cent per KW hour including interest, depreciation, superintendence, and general expense is good practice, even for a very large station. Steam is not likely to be often used as a motive power for power transmission work, except in working a very cheap coal supply.

Dr. Emery has worked out at considerable length, the prob-

lem of the cost of steam power on a very large scale and with the most economical modern machinery. He assumed a 20,000 HP plant, worked 24 hours per day, on a variable load averaging 12,760 HP, 63.8 per cent of the maximum. This load factor is judiciously estimated and could certainly be realized in a plant of such size, employed in the general dis-

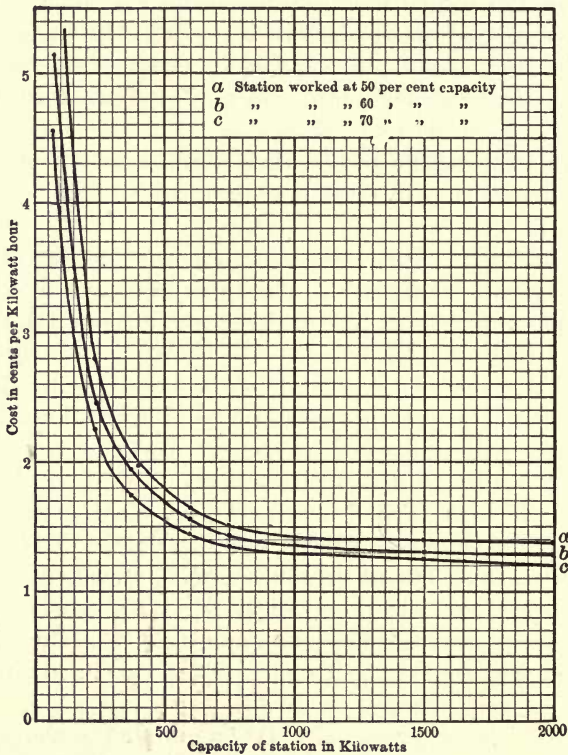

FIG. 317.

tribution of power. Taking coal at one mill per pound, \$2.24 per long ton, and entering every item of expense, he found the total cost per HP per year to be \$33.14. If the plant were established at the mouth of the coal mine, fuel should be obtained at not over one-third the above cost. This advantage would bring the cost per HP per year down to \$24.89. Taking now 15,000 KW in dynamo capacity in large direct coupled

units, say five in number, the electrical plant would cost, installed with all needful accessories and ready to run, \$200,000. Taking interest, taxes, and depreciation together at 10 per cent, which is enough, since a 3 per cent sinking fund would amply allow for depreciation; allowing \$15,000 per year for additional labor and superintendence and \$10,000 more for maintenance and miscellaneous expenses, brings the total annual charge for the electrical machinery to \$45,000. Adding this to the steam power item and reducing the whole to cost per KW hour, assuming 94 per cent average dynamo efficiency, the total cost per KW hour delivered at the station switchboard becomes 0.436 cent. Working, then, on an immense scale from cheap coal, it is safe to say that less than half a cent per KW hour will deliver the energy to the bus bars.

The next step is the cost of delivering it to the customer. This varies so greatly, according to circumstances, that an average is very hard to strike. A plant such as we are considering will usually be installed only when the radius of distribution is fairly long. Taking the transmission proper as 50 miles, the line and right of way, using 30,000 volts, may be taken as about \$25 per KW; the raising and reducing transformers with sub-station and equipment would cost perhaps \$15 per KW, and the distributing circuits, with a fair proportion of large motors, about \$10 per KW additional. The complete distributing system for 15,000 KW would then cost about \$750,000. Figuring interest and depreciation roundly at 10 per cent, the annual charge is \$75,000. Add now \$15,000 for labor in sub-station and distributing system, \$10,000 for general administrative expense, and 5 per cent on the cost for maintenance and miscellaneous expenses, and we reach a total annual charge for distribution of \$137,500. The average output being almost exactly 9,000 KW, the cost of distribution per KW hour is 0.174 cent. The actual cost of generating and distributing the power then becomes 0.610 cent per KW hour.

This is probably pretty nearly a minimum for distribution of power from coal mines. It supposes a very large plant installed for cash and operated for profit. It makes no allowance for the floating of bonds at 60 to 80 cents on the dollar, the operations of a construction company, the purchase of

coal from the directors, the payment of big salaries to the promoters, or any of the allied devices well-known in financial circles.

Under favorable circumstances a materially better result can be reached with hydraulic power.

These figures mean that power could be sold at an average of 1 cent per KW hour at a good profit, aggregating for the plant in question more than a quarter of a million dollars per year.

Only the largest plants, skilfully handled, can approach such figures for cost of power as have just been given.

It should be possible, however, to bring the cost of distribution per KW hour in a well-designed transmission plant of 1,000 HP or more down to less than 0.5 cent per KW hour. Less than this may indeed be found in practice, while figures approaching 0.25 cent may be found in good central station working.

The cost of producing power in steam-driven plants of various sizes has already been given; that in water-power plants is far less definite, but on the whole lower. In some hydraulic plants where development has been costly, the cost of water-power rises to \$20 or \$25 per net HP year, while on the other hand water-power has been leased at the canal for as little as \$5 per year per hydraulic HP in the canal, equivalent to about \$6.50 per available HP at the wheel shaft. The investment per effective HP at the wheel ranges from nearly \$150 to as low as \$30 or \$40. This includes both the hydraulic rights and work and the wheels themselves.

A typical estimate for a water-power plant under fairly favorable conditions, derived from actual practice, runs about as follows, for a 1,000 HP plant working at, say, 3,000 volts, so

Hydraulic works.....	\$40,000
Wheels and fittings.....	12,500
Power station.....	2,500
Pole line, 8 miles.....	4,000
Transmission circuit.....	15,000
Dynamos and equipment, 750 KW.....	15,000
Transformers, 750 KW.....	7,500
Distributing lines.....	15,000
Miscellaneous.....	5,000
Total.....	\$116,500

Operating expense:	
Interest and depreciation, 10 per cent.....	\$11,650
Attendance at plant.....	4,000
Linemen and team.....	2,000
Office expense.....	3,500
Rent, taxes, and incidentals.....	1,000
Maintenance and supplies.....	4,000
Total.....	\$26,150

that there is no reducing sub-station, but only an ordinary distribution.

The full capacity of the plant is about 750 KW. Supposing the plant to be worked somewhere near its capacity at maximum load, and to be in operation on a mixed load 24 hours per day, we may estimate the daily output about as follows:

	KW	KWH
9 hours @ 500.....		4,500
5 " " 250.....		1,250
3 " " 100.....		300
6 " " 50.....		300
Total.....		6,350

This should be taken for 300 days in the year. The other 65 days, Sundays, holidays, and occasional periods of unusually small motor loads, it is not safe to count on more than 1,000 KW hours per day. Taking account of stock, we have for the year,

1,970,000 KWH,

and the net cost per kilowatt hour becomes 1.33 cents. It is worth noting that the distribution of power for the day is taken from a transmission plant in actual operation.

Of the above total cost, 0.47 cent is chargeable to distribution expenses and 0.86 to power production. Doubling the cost of the hydraulic works would raise the generating cost to 1.07 cents and the total cost to 1.54.

It is evident in this case that power could be sold at 2 cents net per HPH with a good profit, assuming the smaller total cost, and at 2.5 cents, even with the greater hydraulic cost. Even if the total investment were as great as \$250,000, the plant would pay fairly well at 3 cents per HPH.

The fact is, hydraulic transmission plants generally will pay well if a good load can be obtained. The above example does not show a cheap plant nor a remarkable load factor. In

fact, the cost per KW in this case runs to about \$155, while at present prices of material, many plants are installed at a considerably less figure even when as here the cost of the distributing system is large. In really favorable cases the cost of power distributed will not exceed 1 cent per HP hour, and in comparatively few plants will it rise to 2 cents, unless the market for power is grossly overestimated.

This is one of the commonest troubles with plants that do not pay well. A costly hydraulic development is undertaken, resulting in rendering available several times as much power as can be utilized; a portion of this is then transmitted and sold, but the plant is burdened with heavy initial expense, and struggles along as best it can. It is not safe to count on the stimulation of industrial growth by cheap power unless the situation is exceptionally fortunate, or cost of producing power is so small that the plant will pay tolerably well on the existing market.

A careful canvass for power is a necessary part of the preliminary work for a power transmission, and the more complete it can be made the better. Reference to the table of p. 643 shows that, at a selling rate of 2 to 4 cents per HP hour, the cost of power can be reduced for all small consumers and a good many rather large ones. If the cost of coal is high, \$5 per ton or more, nearly all consumers will save by using electric power, while with favorable hydraulic conditions money can be saved by transmission even when replacing very cheap steam power.

Take, for example, a large manufacturing plant requiring 1,000 HP steadily, 12 hours a day. At a distance of, say, 8 miles, is a hydraulic power that can give, say, 1,200 HP, and can be purchased and developed for \$100,000. The cost of generating and transmitting power will be about as follows:

Hydraulic work	\$100,000
Wheels and fittings	15,000
Power house	3,000
Pole line	4,000
Dynamos and equipment	20,000
Transmission circuit	15,000
Motors and equipment	15,000
Miscellaneous	10,000
Total	<u>\$182,000</u>

and the operating expenses would be about as follows:

Interest and depreciation	\$18,200
Attendance at plant	2,500
“ “ motors	1,800
Other labor	1,000
Maintenance, supplies, etc.	5,000
Total	<u>\$28,500</u>

This would furnish, taking the working year as 308 days, 3,696,000 HP hours at a cost of 0.77 cent per HP hour. With a low cost of hydraulic development and a short line, say not over three miles, the above figures for cost could be brought down to about \$130,000. Now, allowing 5 per cent for interest, and setting aside 3 per cent for sinking fund, which allows for complete replacement in less than 20 years, we may figure the annual cost of power again thus:

Interest and sinking fund	\$10,400
Attendance at plant	2,500
“ “ motors	1,800
Maintenance and incidentals	5,000
Total	<u>\$19,700</u>

This is \$19.70 per HP year, or 0.53 cent per HP hour, or \$15.80 per HP year omitting the sinking fund, which very seldom is allowed to creep into estimates on the cost of steam power. This is certainly cheaper than power can be generated by steam, save in very exceptional instances, provided proper account be taken of interest, depreciation, and repairs. As a matter of fact, the cost just given has been reached, in practice, in transmission work at moderate distances. On a larger scale, slightly better results can be attained. These figures take no account of the saving in actual power obtained by distributed motors, always an important matter in organizing a transmission for manufacturing purposes. This can generally be counted on to make it possible to replace 1,000 HP in a steam engine by not over 750 HP in electric motors, with a corresponding reduction in the aggregate yearly cost of power.

Speaking in a general way of costs at the present time (1906), dynamos and their equipment may safely be taken at \$10 to \$20 per kilowatt, raising and reducing transformers at from \$4 to \$8 per KW, line erected at from \$10 to \$30 per KW, water-wheels and governors at \$10 to \$20 per HP, and steam

plant, when used, at from \$40 to \$60 per net HP. Under favorable conditions the total cost per KW of capacity can be brought to \$50 or \$60 excluding all questions of steam plant and of hydraulic development.

The line is always a rather uncertain item, on account of its variations in cost at different distances, and in meeting local conditions of distribution. The pole line itself will cost from \$250 to \$500 per mile, according to circumstances, but the copper must be figured separately, as already explained.

No account is here taken of freaks in design — dynamos of special design for peculiar speeds or voltages, extraordinary line voltages, unusual frequencies, or eccentric methods of distribution like the wholesome use of rotary converters and storage batteries. The figures are intended to represent ordinary good practice as it exists to-day.

One of the nicest points in operating a transmission plant is the proper adjustment of the price of power to the existing market. It is no easy matter to strike the point between the cost of other power and the cost of generating and distributing electric power, which will give the maximum net profit. In general it is best to work entirely on a meter basis, for the customer then pays simply for what he uses, and the station manager knows the exact distribution of his output.

The generating station or the sub-station should be equipped with a recording wattmeter that will show the actual output, and from this measurement much valuable information can be obtained.

Knowing the investment and the approximate operating expense, it is easy to figure, as we have just done, the total cost of delivering energy per KW power at various outputs. This is the basis of operations. The next thing is to estimate as closely as possible the average local cost of power in units of various sizes. These two quantities form the possible limits of selling price. One must keep far enough above the first to insure a good profit, and enough below the second to capture the business. It is convenient to plot these data as in Fig. 318, which is based on the table of p. 643, and the plant discussed on p. 649. Curve 1 shows the effect of change in the annual output on the net cost per KWH. Curve 2 shows the

approximate existing cost of steam or other power, the points from which the curve was drawn being shown by crosses. Curve 3 shows the same for intermittent loads, the points being indicated by circles. It is evident that for yearly outputs less than 1,000,000 KWH, the plant would be in bad shape to get business. At 2,000,000 KWH good profits are in sight,

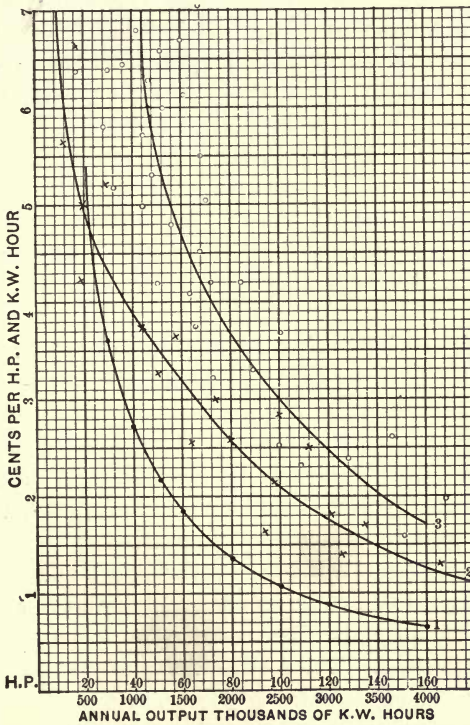

FIG. 318.

while at 3,000,000, the electric plant can meet all cases at a profit.

At the given output of 1,970,000 KWH, it would be possible to charge 2 cents per KWH as a minimum without losing business, while all the smaller customers could gain by changing to electric power at 4, 5, or 6 cents per KWH.

When a few consumers are generating power at an unusually low figure, there is always the temptation to obtain them at a

special cut rate. As a rule, this is bad policy unless they are desirable for some particular reason aside from increase of output, for the moral effect of special low price contracts is always bad, and in the long run it is best to make standard rates and to adhere to them.

The best prices can always of course be obtained from small consumers, and these are also specially desirable in that they tend to keep a uniform load on the system. Not only do 50 10 HP motors yield ordinarily several times as much revenue as one 500 HP motor, but they will call for power very steadily all day long and keep the regulation excellent, while the large motor may be off and on in the most exasperating way and cause great annoyance at the time of the "lap load," when lights and motors are all in use. Large motors running intermittently are especially disadvantageous, for they do not greatly increase the aggregate station output and pay relatively little.

In general, the best schedule of prices can be made up by starting with a rate arranged to get all the powers below, say, 4 or 5 HP, and then for larger powers arranging a set of discounts from this initial rate. These discounts, however, should be based, not exclusively upon the size of the motors, but on the monthly KW hours recorded against them. In one respect, charging by wattmeter alone is at rather a disadvantage. A large motor running at variable load, and much of the time at light load, is far less desirable as a station load than a small and steadily running motor using the same number of KW hours monthly. The former demands far greater station capacity for the same earning power, and also inflicts a bad power factor upon the system at times of light load if the distribution is by alternating current. It is not easy to avoid this difficulty, although various devices to that end have been introduced. In one large plant, recording ammeters are installed for each motor, and the largest demand for current lasting two minutes or more during a given month is made a factor in determining the price paid for that month's supply of power, so that large demands for station capacity must in part be paid for by the consumer.

Another device for the same purpose is a combination of the

flat-rate and meter methods of charging. A fixed monthly charge per horse-power of the motor connected is made, and in addition the consumer pays for his energy by wattmeter, of course at a somewhat lower rate than in using the meter alone. A rough illustration of the effect is as follows. Suppose a flat charge of \$1 per month per HP of the motor installed and a meter rate of 3 cents per KWH. One customer has a 10 HP motor worked steadily at full load 10 hours per day for 30 days. Another has a 50 HP motor which runs at full load for 2 hours per day. Each may, for example, use 3,000 KWH per month, and pay by meter \$90 therefor; but the former pays a flat charge of \$10, the latter one of \$50, so that the monthly bill is in the former case \$100, in the latter \$140. The extra \$40 may be regarded as the payment of rent for station capacity, and capacity of lines and transformers, to be held at the customer's call at all times. It is, in fact, a very genuine expense to the station. The whole question of equitable charging for current used for light and power is a very puzzling one. Taking the country through, there has been a tendency for basic rates to cluster about 20 cents per KWH for lighting and 10 cents per KWH for power. This difference has no logical reason for existence, and merely represents the natural tendency to get business by trying to keep below each consumer's supposed cost of production. The present tendency is to put current for lighting and power upon nearly the same basis, letting a sliding scale of discounts take care of the generally smaller output purchased by the lighting customer. These discounts vary greatly from place to place, but they generally run up to 50 to 70 per cent for large consumers, and are commonly less for lighting than for power. On the whole, the simpler the system of rates and discounts, the better.

It must not be forgotten that an electric supply company is a public service corporation doing business in virtue of franchise rights, and consequently it must tread softly and circumspectly in its dealings with the public. Special contracts, save for an open and general reason, like the use of power during restricted hours, are from this point of view particularly to be avoided, and the whole rate system ought to be as open and above board as possible.

A complicated system of discounts is not at all necessary to financial success, as witness the results obtained by the gas companies from a nearly flat rate. A simple and obvious discount scale generally is acceptable to the public, and the trouble really begins when one attempts to take account of differences in demand of the sort already mentioned. A minimum bill per lamp or HP installed plus a simple meter schedule can prob-

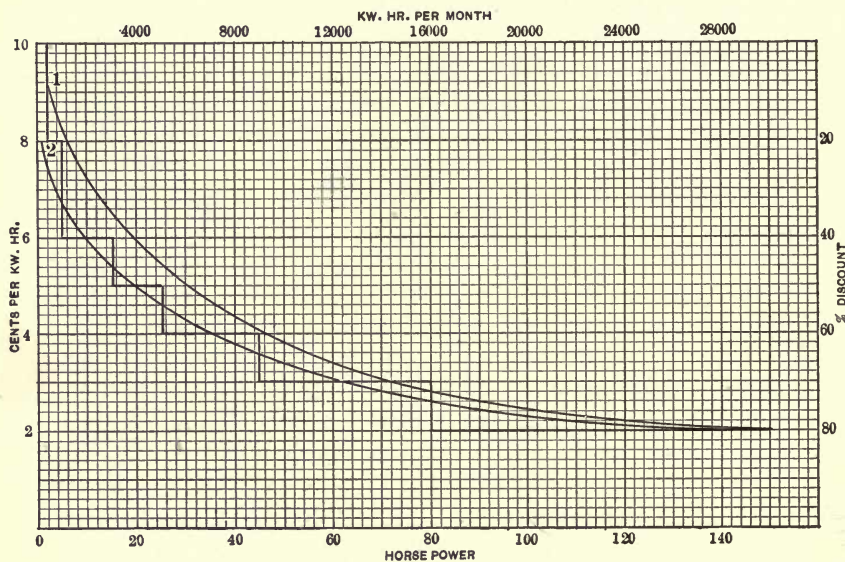

FIG. 319.

ably take account of varying conditions as satisfactorily as any system yet devised.

The exact form of the rate schedule can best be determined after looking over the local conditions. As an example of how the thing can be done, let us start with the data of Fig. 318 on local costs of power. On the basis of curves 2 and 3, lay down a tentative curve of a sort fitted to get the business. Let this be, for example, curve 1 of Fig. 319. This naturally falls pretty near curve 2 of Fig. 318. Now at near full load a 10 HP motor should take not far from 2,000 KWH per month. Hence, one can set down a rough scale of outputs corresponding to the horse-power of the several motor sizes. Of course

very few motors run fully loaded, and as they fall below full load their condition of economy approaches curve 3, Fig. 318, and their bills slip up along our present curve. By the curve a man with a 20 HP motor fully loaded will pay for 4,000 KWH a month at 6 cents, while if he consumes but 2,000 KWH he will pay for it at the rate of 6.7 cents per KWH. The man with a 100 HP motor will get his power at 2.4 cents per KWH at full load, or at half load for 3.8 cents. These figures, although based on reasonable data, are, as compared with actual motor rates, rather high for the small motors and low for the large ones. The difference perhaps indicates that in general it has been found wise to encourage small motor business, as has already been indicated.

Now to apply the combination of flat rate and meter to encourage steady loads. A regular charge of \$1 per HP of motor per month will mean, on a basis of 200 KWH monthly per HP, a fixed charge of 0.5 cent per KWH on the fully loaded motor. Therefore curve 1, Fig. 319, should be dropped down 0.5 cent to get the new meter rates. Here is the chance for equalizing a bit, by dropping the upper end of the curve and letting its lower end alone. Curve 2 shows a curve thus lowered. At about 50 HP the drop compensates for the fixed charge, and the total rates rise above that point, and below it, fall. Now for the 20 HP motor the monthly bill is \$20 + 4,000 KWH @ 5 cents = \$220, and for the 100 HP motor \$100 + 20,000 @ 2.3 cents = \$560. The former pays \$11 per horse-power per month, the latter \$5.60. At half input these figures rise to about \$14 and \$9.40 respectively.

To simplify the discounts, curve 2 is commonly made up of a series of arbitrary steps such as are shown. They can be arranged to suit any case, the one shown being merely a simple example. Based upon it the discounts from the basic price of 10 cents per KWH are:

KWH Monthly Consumption	Discount per cent
Below 400	0
400- 1,000	20
1,000- 3,000	40
3,000- 5,000	50
5,000- 9,000	60
9,000-16,000	70
16,000 and over	80

If there is an unusually good market for small motors, the steps can be arranged to favor them a bit, as, for instance, by giving a 10 per cent discount from 200 to 400 KWH. It will be seen that the whole scheme is frankly empirical, although based on premises which are not without reason. Some discount schedules are far more complex than that shown, while others are rather simpler. The prices given here are fairly high save on the large motors. Many plants give an extra discount of 5 or 10 per cent for prompt settlement. In selling current for lighting, the discounts are generally less variable with the consumption than here shown, and a flat service rate in addition is of rather dubious expediency considering the policy of the gas companies. The discount schedule here given would do very well for the lighting output as well as for the motor load.

Charging by a recording ammeter instead of a wattmeter will reach the users of motors that injure the power factor of the system, and, combined with the flat rate just mentioned, would probably give a really fairer system of payment for the customer's demand upon the station than either of the schemes just described, but the wattmeter is so generally used and understood that it can hardly be escaped.

Methods of selling and charging, however, must be modified to suit local conditions and customs. Each community has peculiarities of its own that must be studied and reached. Sometimes a flat rate, objectionable as it often is, will secure a more remunerative business than any system of metering, while elsewhere a meter system, however intricate, may work better than a flat rate. As a rule, however, metering is the best method of charging for all parties.

A water-power transmission plant has the peculiarity when, as usual, the water is owned outright, of showing a nearly constant operating expense, irrespective of output. Hence, after the receipts exceed this expense, all additional load, at any price, means profit. But it means profit precisely in proportion to its price, so that taking on large consumers at a very low price is usually bad policy, it being better to encourage small consumers by giving what is to them a very reasonable figure.

After the maximum output comes near to the capacity of the plant, the total yearly output for the given plant is difficult to increase. Hence, it is desirable persistently to cultivate the use of power at such times as will not increase the maximum load. This can best be done by offering liberal discounts for power used only between, say, 8 P.M. and 8 A.M. There is at best rather a small amount of this, and it is all worth getting even at a low rate. After getting all the available night power, the next step should be to get whatever day business is possible for hours restricted to the period prior to the beginning of the peak, say at 4 P.M., again at special discounts. Now and then a customer can be picked up on this basis to the great advantage of the station.

In stations using rented water-power at a fixed price per HP, or employing steam, the operating expense is of course variable, and this variation will influence greatly the adjustment of prices, although the general principles are unchanged.

Experience has now shown that electric power transmission may generally be made a profitable enterprise.

If a transmission is planned and executed on sound business principles and with ordinary forethought, it is well-nigh certain to be a permanent and profitable investment.

Failure is generally chargeable to attempts to work with altogether insufficient capital, leading to ruinous actual rates of interest; the purchase of material at extortionate prices due to various forms of credit; and huge commissions to promoters.

Organized in such wise, almost any enterprise becomes merely speculative, and its failure should produce neither surprise nor sympathy, for such a course is the broad highway that leads straight into the ever ready clutches of a receiver. Honesty is the best policy in power transmission, as elsewhere.

CHAPTER XVII.

THE MEASUREMENT OF ELECTRICAL ENERGY.

THE basic fact regarding the measurement of electrical power is the stress between a magnetic field and a coil carrying a current. Obviously such a coil produces of itself a magnetic field, but it is the proportionality of this field to the current rather than its mere existence that gives it importance in measuring instruments.

The fundamental measurements which have to be made in ordinary practical engineering are three — current, electromotive force, and electrical energy, which is their co-directed product. In continuous current work, while mere readings of the first two give the energy as their numerical product, it is generally desirable to have instruments which measure energy directly and which integrate a varying output continuously, so that one may at all times keep track of the output of the station, a single circuit, or the energy supplied to a single customer. In alternating current work a wattmeter is doubly necessary, first because the product of volts and amperes does not give the real energy, but the apparent energy, as has already been explained; and, second, because the true energy divided by the apparent energy equals the power factor, which should be looked after very carefully in an alternating station.

Any effect of electric current which is proportional to or simply related to that current may obviously be used for its measurement, and in laboratory measurements instruments based on almost every imaginable property of electric current have been used with more or less success. But for every-day, practical purposes instruments must possess qualities not so important in the laboratory, so that the possible types of measuring instrument have simmered down to a very few, with respect to the principles concerned.

So far as continuous currents are involved, nearly all practical instruments are electro-magnetic, as has already been

CIVIL ENGINEERING
 U. of C.
 ASSOCIATION LIBRARY

indicated — almost the sole exception being the Edison chemical meter, which need not here be described, since it is passing rapidly out of use.

The simplest electrical measuring instrument is the ammeter, designed for the practical measurement of current strength. In its commonest forms, as used for continuous current, it consists of a fixed coil of wire carrying the current to be measured and a pivoted magnetic core, to which is attached a pointer sweeping over a fixed scale. The force on this core varies with the current, and is resisted by some opposing force that brings the pointer into a new point of equilibrium for each value of the current. Sometimes this opposing force is the magnetic field of the earth, as in the ordinary laboratory galvanometer,

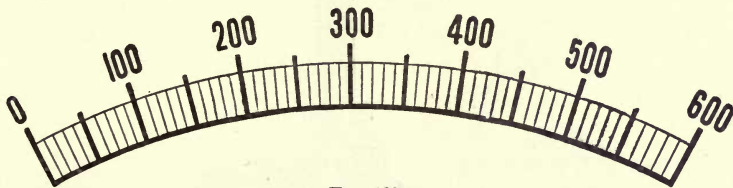

FIG. 320.

but in practical instruments it is generally gravity, a spring, or a relatively powerful permanent magnet.

Most of the numerous varieties of ammeter have been produced in the effort to secure a permanent and constant controlling force, and uniformity of scale; that is, such an arrangement of parts as will make the angular deflection of the pointer directly proportional to the amperes flowing through the coil. The result has been all sorts of curious arrangements of the coils and the moving armature with respect to each other, and the upshot of the matter generally is that the scale has to be hand-calibrated for each instrument, the divisions of the scale being fairly uniform through the parts of the scale most often used, but varying somewhat near its ends. In first-class modern instruments, a remarkably even scale is attained. Fig. 320 is a good example taken from the scale of a regular station ammeter. Gravity is far and away the most reliable controlling force, but it is also highly inconvenient in instruments intended for portable use or for a wide range of action while

still preserving small inertia in the moving parts, so that springs or permanent magnetic fields form the main reliance in practice. In some admirable instruments the well-known principle of the D'Arsonval galvanometer is employed. In this instrument, of which a familiar laboratory type is shown in Fig. 321, a light

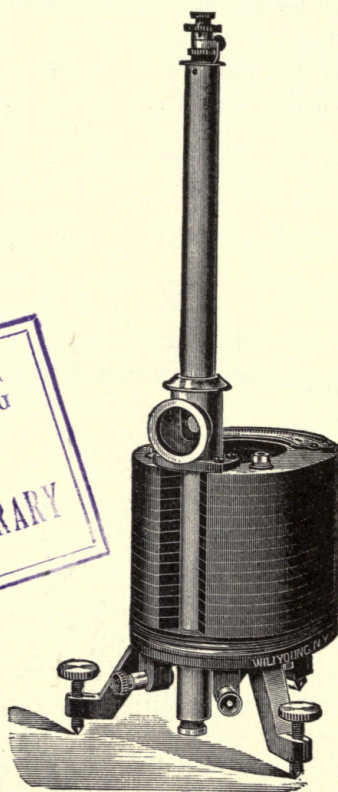

FIG. 321.

movable coil is suspended between the poles of a very powerful permanent magnet, shown in the cut as built up in circular form. Current traversing the coil through the suspension wires sets up a field, which, reacting with the magnet, produces a powerful deflecting force on the coil, controlled by the torsion suspension. In commercial instruments the suspension is replaced by jeweled bearings, and the current is led in

through the controlling hair springs or by very flexible leads. The resulting instrument is very sensitive and accurate for the measurement of small currents or known fractions shunted from larger ones. The famous Weston direct current instruments, together with others less well known, are constructed along this general line.

The sources of error even in the best commercial ammeters are many. Permanent magnets and springs do not always hold their strength precisely, jeweled bearings wear, and break if the instruments are roughly handled, pointers get bent, dust sometimes gets in, and on these accidental errors are superposed those due to errors in scale and calibration. Nevertheless, the best station and portable ammeters possess and maintain a very commendable degree of accuracy. When carefully handled and used well within their working range they can be trusted to within about one or two per cent. If of the highest grade and frequently verified, they can be relied on in the best part of the scale down to, say, half the above amount, and under circumstances exceptionally favorable will do even a little better. In laboratory work, where they are merely used as working instruments and often checked, it is possible to nurse them into still higher accuracy, but one cannot depend upon it for long at a time under commercial conditions. For relative measurements only, made within a short time, high-grade ammeters are very accurate, but the hints already given should make it clear that when in regular use one must not expect to use them for absolute measurements with a great degree of precision. The cheaper class of instruments is likely to show double the errors just noted.

For the measurement of alternating currents only a few of the types of ammeter used for continuous current are applicable. Hysteresis in the iron parts and reactance in the coils are likely to incapacitate them, but some of the forms can readily be modified to give good results, and certain others are specially suited to alternating currents. In this work a new class, having a fixed field coil reacting on an armature coil capable of rotation, and spring controlled, has been made generally useful. These instruments are derived from the laboratory electro-dynamometer much as those pre-

viously mentioned are derived from the D'Arsonval galvanometer, and are capable of similar precision in practice. On account of their extremely small reactance, hot wire instruments have retained still some slight measure of their one-time popularity. In this class of instruments the current is passed through a fine suspended wire of rather large resistance, which is thereby heated and expands, carrying with it the pointer to which it is attached, usually by means of multiplying gear. Such instruments require correction for the temperature of the air, but are capable of very good accuracy if carefully handled. They are "dead beat," *i.e.*, the pointer comes to rest without oscillation, a very useful property, which is secured to a certain extent in most instruments by various damping devices. Instruments having a powerful permanent magnet often are supplied with a copper damping vane, which checks oscillations by virtue of the eddy currents stirred up in it by the magnet; and sometimes air vanes in a close-fitting recess or light mechanical stops, which can be brought up against the moving parts, are used for this purpose. For high-voltage generators the current for the instruments is derived from a current transformer, as the instruments themselves are difficult properly to insulate for more than 2,000 to 2,500 volts. They are used with instruments graduated to show the primary current, a known fraction of which is actually derived from the secondary. Such a current transformer for moderate currents is shown in Fig. 322. It is designed merely to furnish current for the ammeter and wattmeters.

Voltmeters for measuring the electromotive force are in all general points constructed precisely like ammeters, save that the working coil, whether fixed or movable, is wound with very fine wire in many turns, so as to be adapted to work with very small currents, and usually has in series with it a resistance of several thousand ohms. Voltmeters are in fact ammeters having so much resistance permanently in circuit that the current which flows through them is substantially proportional to the voltage across the points to which the instrument is connected, irrespective of other resistances which may casually be in circuit. Only in rare instances, as sometimes in incandescent lamp testing, is the current taken by the voltmeter a

source of perceptible error, and in such cases it is readily allowed for. Voltmeters are more difficult to construct than ordinary ammeters, owing to the fine wire windings and the high resistance, and are generally rather more expensive.

They are capable of just about the same degree of precision as ammeters, being subject to about the same sources of error. When used for alternating current, the large auxiliary resistance is wound non-inductively, and the working coil is proportioned for as low reactance as may be possible with the required sensitiveness. For measuring very high alternating voltages, a "potential transformer," shown in Fig. 323, as adapted for high-voltage transmission systems, is used. These transformers

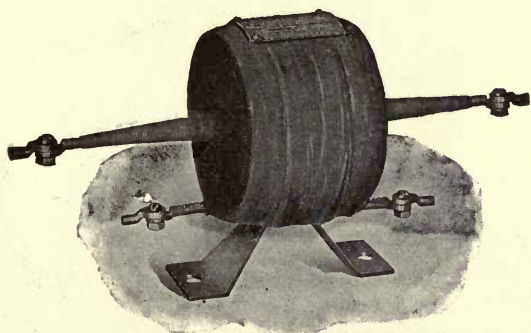

FIG. 322.

have usually a capacity of from 50 to 250 watts, and are used for the instruments only. They are wound with an accurately known ratio of transformation, receive the high-pressure current, and deliver it to the voltmeter at a more reasonable voltage. In dealing with continuous currents the problem is more difficult. Sometimes a very sensitive voltmeter is provided with a separate high-resistance box, reducing the scale readings to some convenient fraction of their real value, so that the instrument is used with a constant multiplier to transform its readings to the corresponding voltage. This is a useful device for obtaining the voltage of arc circuits and the like.

In default of high-voltage instruments, a rack of incandescent lamps may be wired in series and voltmeter readings taken across a known fraction of the total resistance thus inserted;

250-volt lamps in sufficient number not to be brought up to full candle-power are convenient for this purpose, and the voltmeter should be of so high resistance that its presence as a shunt around part of the lamps will not introduce material error.

A generating station should be liberally equipped with ammeters and voltmeters. Besides the ordinary switchboard instruments, usually an ammeter for each machine and each

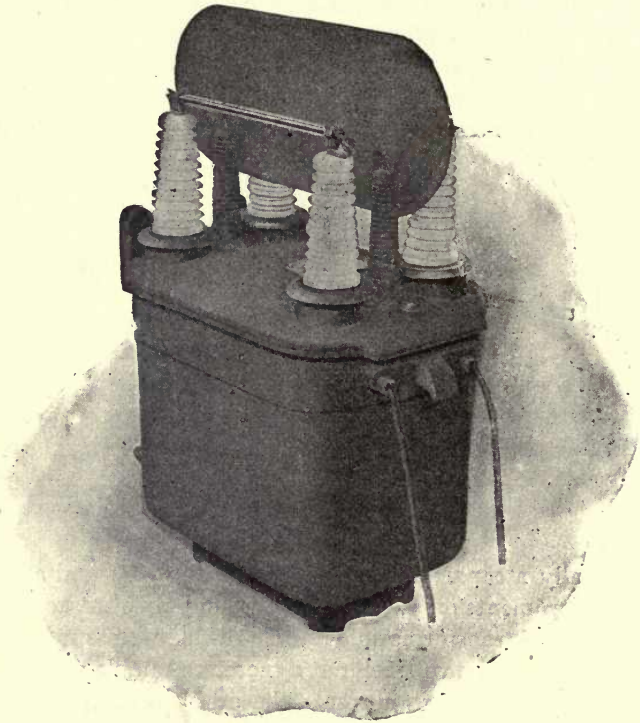

FIG. 325.

feeder, it is desirable to have several spare instruments which can be temporarily put in for testing purposes. Station instruments should have large, clearly divided scales and conspicuous pointer, so that the readings can be seen at a distance from the switchboard. The large illuminated dial instruments are excellent for the principal circuits, and the main station voltmeters may well be of similar type. To save space such

instruments are very commonly made with scales arranged edgewise as in the station voltmeter shown in Fig. 324.

Voltmeters are ordinarily not numerous in a station, and are usually arranged with changeable connections, so that they may be plugged in on any circuit and mounted on swinging brackets so as to be readily visible from various directions. There should, however, always be at least one conspicuous voltmeter permanently connected to show the working pressure on the main circuits. In polyphase work, this should be capable of being plugged in on each phase, although it is preferable to have a voltmeter permanently on each phase in large transmission work. At least two other

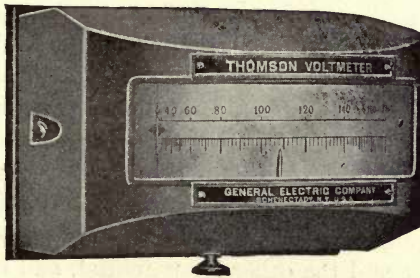

FIG. 324.

voltmeters should be available for connection to such circuits as may be desirable, in testing circuits, parallelizing machines, and the like. These ought to be small switchboard instruments of the highest grade, mounted side by side to enable comparative readings to be readily made. As potential transformers for high voltage are decidedly costly, a simple and safe arrangement for plugging in the primary side of such a transformer on any high voltage connection is much to be desired. A duplicate or spare potential transformer should always be kept in stock, since it is most inconvenient to have a voltmeter thrown out of action. In stations having high voltage generators it is sometimes practicable to connect for the voltmeters around a single fixed armature coil in each generator, which much simplifies the transforming arrangements.

Indicating wattmeters reading the output directly are not in by any means as general use as ammeters and voltmeters, but are highly desirable in portable form for motor and lamp testing, and should be seen upon the switchboard far oftener than they are. These instruments follow the same general line of design as ammeters and voltmeters, but are provided with two working coils or sets of coils. One takes the current of the line on which the output is to be measured either directly or through a current transformer, and the other is a voltmeter coil suspended so as to turn in the field due to the current coil. The torque produced obviously depends on the product of the two fields due to the coils respectively, which is proportional to the energy delivered. If the two fields are in the same phase, as in continuous current practice, or at times of unity power factor in alternating circuits, the numerical product of the two field strengths is proportional to the total energy; but if there is difference of phase, then the co-directed components of the two fields are proportional to the energy. The controlling and damping forces are like those in ammeters and voltmeters, and the wattmeters differ little from them in general arrangement save for having two sets of terminals, one for current and the other for potential, and in the graduation of the scale. An indicating wattmeter is at times a valuable addition to a generator or feeder panel, but it is not necessary in the same sense as ammeter or wattmeter.

A well-equipped station should also have two or three such instruments in portable form, one for the testing of incandescent lamps and such small outputs, and others capable of taking the output delivered to the ordinary sizes of motors and recording wattmeters. It should also have a set of portable ammeters capable of reading the ordinary range of customer's currents without getting off the good working portions of their respective scales. For instance, if one ammeter will read with good accuracy from 1 to 10 amperes, the next might go effectively from 5 to 25 amperes, and the next from 20 to 60.

Of portable voltmeters there should be enough to measure accurately the voltages used for the distribution, and a portable potential transformer to enable primary voltages to be

dealt with in an alternating system. It is desirable to have a pair of exactly similar voltmeters to use in simultaneous readings for drop, and to check each other and the station instruments.

Another form of voltmeter regarded by the author as a necessity in every power transmission plant is a recording instrument keeping a continuous permanent record of the voltage and its variations. Such a record is shown reduced

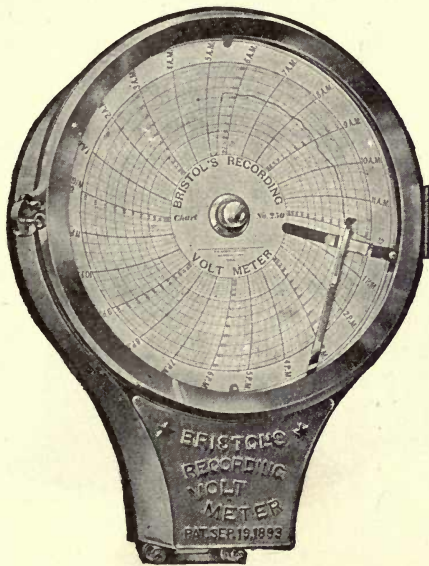

FIG. 325.

in Fig. 130, page 234. The Bristol voltmeter is the form of instrument most commonly seen, and is shown in Fig. 325. It is merely a strongly made voltmeter with a long pointer carrying a pen, and swinging from centre to circumference of a paper disk driven by a clock and ruled in circles for the volts and radially for time. A variable resistance permits it to be accurately adjusted to agree with a standard voltmeter, and when carefully managed it is quite reliable. As a check on the operation of the station and for reference in case of dispute it is invaluable, since it shows every variation of voltage,

and the time at which it occurred. In using it the pen should be kept clean and smooth running, bearing just heavily enough to leave a sharp, thin line, and the clock should be very carefully adjusted to keep correct time. The chart should be changed at the same time each day and put on so as to record the correct time.

Recording ammeters and steam gauges are made upon a similar principle, but for power transmission plants the voltmeter is the most important instrument. Installed in the

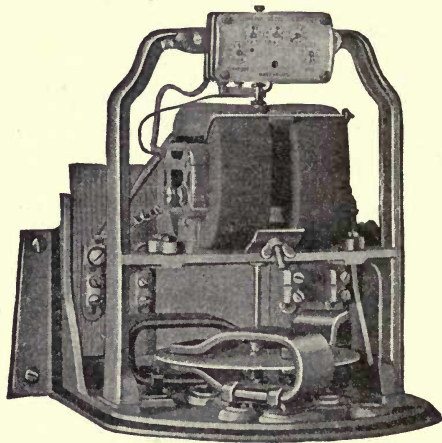

FIG. 326.

generating station it keeps accurate record of the regulation, and in the sub-station it serves a similar purpose.

An instrument sometimes used of late is a frequency meter, showing on its dial the periodicity at any time just as an ammeter shows the current. Its principle is very simple. Any voltmeter having some considerable reactance will change its reading with change of frequency. If furnished with a scale empirically graduated for different frequencies, it becomes a frequency meter, and if installed where the voltage is fairly constant and designed so as to be hypersensitive to changes of frequency, it serves a useful purpose in telling whether the machines are at the exact speed intended. In

fact it could in any given situation be graduated for speed as well as for frequency.

Occasionally recording wattmeters, similar to the recording voltmeters already described, are used; but it is difficult to get accurate readings over a wide enough range to be of much use, and the more usual instrument is the integrating wattmeter, sometimes referred to as recording, which registers the output in watt hours continuously. Instruments of this class are used both to register the energy supplied to customers and to take account of the energy generated. Daily readings of the switchboard instruments give by difference the daily output in KW hours, and in steam driven stations are most important in keeping record of the station efficiency and its variations. It is needless to say that instruments used for this purpose should be kept in especially careful calibration since errors in the whole output are dealt with. Even in hydraulic stations they give a useful check on station operation and on the energy sold.

Integrating wattmeters are essentially motors whose speed is proportional to the output. Like indicating wattmeters they produce a torque due to the co-action of current and potential coils, and the armatures revolving under this stress are furnished with an automatic drag due to a disk revolving between magnet poles or to air vanes, so that the speed shall be proportional to the output on the circuit in watts. Probably in principle the simplest of these instruments is the widely known Thomson recording wattmeter. Fig. 326 shows the general appearance of this meter with the cover removed, and Fig. 327 gives its connections in the ordinary two-wire form. Essentially it consists of the following parts: a pair of field coils of thick wire, in series with the load; an armature, drum wound, of very fine wire, in series with a large resistance and placed across the mains; and a copper disk on the armature shaft revolving between the poles of three drag magnets. The fields and armature are entirely without iron, the armature shaft rests on a sapphire or diamond jewel bearing, and its upper end carries a worm to drive the recording gear.

The commutator is of silver of which the oxide is a fair conductor so that the commutator does not easily get out of

condition, and current is taken to it by slender copper brushes resting tangentially upon it. The drag magnets are artificially aged, so that they remain very permanent and are adjustable to regulate the meter, if necessary. The resistance of the potential circuit is several thousand ohms, and the loss of energy in the meter at full load does not often exceed 5 to 10 watts. As the static friction of the armature is considerably greater than the running friction, the "shunt" in the potential circuit is made part of the field, so as to help the meter in starting. Doubling the current evidently doubles the torque in such a motor meter, but since the work done in eddy

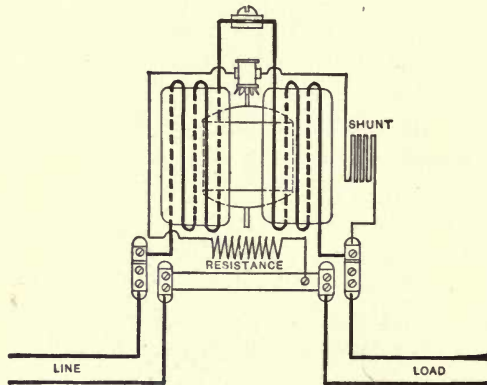

FIG. 327.

currents in the drag increases as the square of the speed, the armature will run at a speed directly proportional to the energy, which is the speed desired.

In point of fact, such meters are capable of giving very great accuracy — within two per cent under ordinary good commercial conditions, and very uniform results under different conditions of load.

Such meters are suited for use on both continuous and alternating circuits, and are remarkably reliable in their indications under all sorts of conditions, save with very low power factors. Another and very beautiful group of meters is designed especially for use on alternating circuits only, and follows the principle of the induction motor, just as the Thomson meter is a

commutating motor. The pioneer of this class was the famous Shallenberger meter, an ampere-hour meter, which has been very widely used and would be extremely useful where amperes rather than watts are to be measured, although now practically abandoned.

A fair type of the induction wattmeter is shown in Fig. 328, the Scheefer meter, one of the earliest of the class, although here shown in a recent form. It consists of a finely laminated

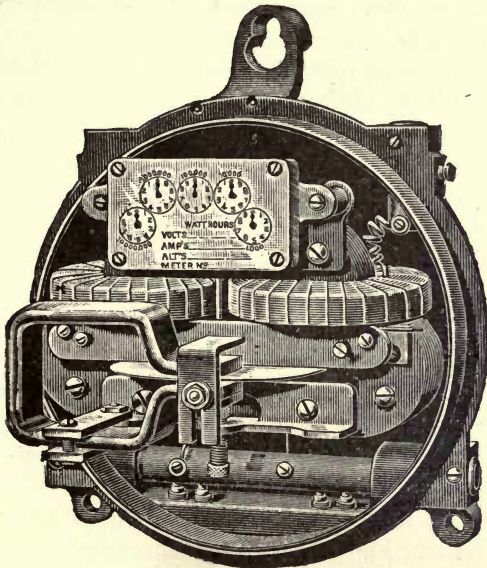

FIG. 328.

field magnet energized by a current coil and a potential coil, an aluminium disk armature, and the magnetic drag which has come to be generally used in meters. *A priori* one would suppose that so simple a structure could hardly be made to give an armature speed proportional to the energy in the circuit; and in fact it takes great *finesse* to design it so as to accomplish this result, but it can be successfully done, and meters of this class turned out by various manufacturers are capable of doing very accurate work.

As a class they develop very small torque, but in part make up for this failing by the very small weight of armature and

shaft. The speed is seldom accurately proportional to the energy over a very wide range of load, but day in and day out the small errors generally tend to balance each other, so that the total reading at the end of a month varies but little from the facts. The induction meters are liable to material errors in case of large change of voltage, power factor, or frequency, but within the range of these factors in ordinary service they do sufficiently accurate work for all commercial purposes, and the best of them are substantially as accurate as the commutating meters.

All types of meters are made suitable for switchboard work in measuring large outputs, and in alternating stations can be fitted for use on primary circuits, although this is seldom necessary, and should not be attempted at any but moderate voltages without the use of transforming apparatus for the meter. Most switchboard meters for such work as power transmission are of special designs, modified for the particular work in hand.

Monophase alternating circuits and continuous current circuits are measured in the most direct way possible, the ammeters being put in the mains, and the voltmeters across them, through a potential transformer if need be, as it is somewhat troublesome to wind voltmeters for use directly upon circuits above 2,000 to 2,500 volts.

Wattmeters are connected to such circuits in a similar straightforward way, shown for continuous or secondary alternating current in Fig. 327 and for primary alternating circuits in Fig. 329. In these and other cuts of wattmeter connections the circuits of the Thomson meter are shown, but they must be regarded as merely typical, since in using other meters the arrangement of circuits follows the same principle, the field or current coil being put in the mains and the armature or potential circuit across them. The former is wound with coarse wire or copper strips, the latter with very fine wire, so that they can very easily be told apart even at a casual inspection.

Ordinary two-phase circuits are measured in a precisely similar fashion, each pair of phase-wires being treated as a separate circuit and supplied with its own instruments. The metering likewise, whether of primary or secondary circuits, is generally accomplished by the use of two wattmeters, each con-

nected to its own pair of mains. In case of motors in which the two phases may be regarded as substantially balanced and equal, it is only necessary to put the instruments in one of the phases and to multiply the readings of energy by 2 to get the total input. If the two-phase circuits are unbalanced, two sets of instruments are absolutely necessary for a simultaneous reading on both phases, unless some form of combined instrument takes their place.

With three-phase circuits the case is rather more complicated. The simplest to manage is a star-connected three-phase balanced circuit, as found in some motors. Here the

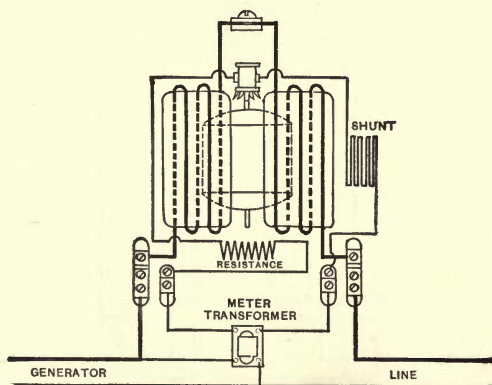

FIG. 329.

ammeter or current coil of the wattmeter goes directly into one lead, and the voltmeter or potential coil of the wattmeter is connected between *that lead* and *the neutral point of the star*. The instrument then gives correctly one-third of the energy. Therefore, the wattmeter reading multiplied by 3 gives the energy on the circuit. On some of the early three-phase motors of which the primaries were star-wound, an extra lead was brought from the neutral point to the connection board to facilitate measurements. On a circuit mainly of motors fair balance usually exists.

If the circuit is balanced it is not necessary that a star connection at the generator or transformers should either be easily accessible or exist in order to use the method of measurement just described. For if the circuit is balanced the am-

meter or current coil of the wattmeter may be put in a lead, and the voltmeter or potential coil of the wattmeter be connected between the same lead and the neutral point formed by three equal high resistances connected to the three leads respectively, and with their three free ends brought to a common junction. Such an artificial neutral is very commonly used in connecting wattmeters on the secondary circuits for motors, and may be applied to primary circuits as well. The writer has sometimes constructed such a neutral by connecting three strings of incandescent lamps to the three leads and

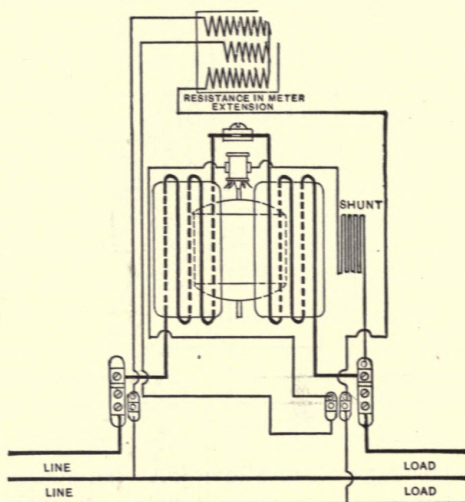

FIG. 330.

to a common junction. Then connecting the potential coil of a wattmeter around one lamp and its current coil in the lead to which the string containing this lamp ran, it became possible to make a closely approximate measurement of the primary energy with only an ordinary 110 voltmeter and such appliances as can be picked up around any station. This device of an artificial neutral as applied to secondary circuits is well shown in Fig. 330.

The measurement of energy on an unbalanced three-phase circuit is a very different proposition. Of course three watt-

meters with their three potential coils respectively in the three branches of a star-connected resistance, such as has just been shown, would do the work, but at a very undesirable cost and complication.

If, however, two wattmeters are used with their current coils in two phase-wires respectively, and their potential coils respectively between their own phase-wires and the remaining wire of the three, the sum of the readings of these two meters records correctly the total energy of the circuit. Such an arrangement of meters is shown in Fig. 331, as commonly

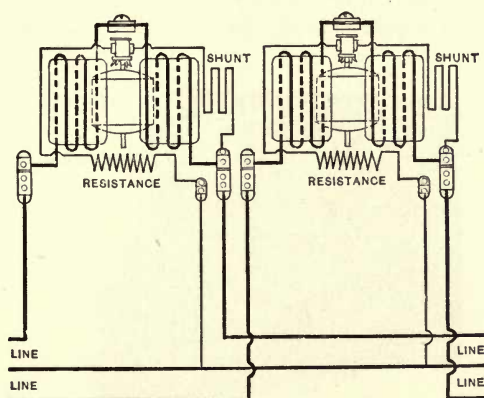

FIG. 331.

applied to three-phase secondary circuits. A precisely similar arrangement with the addition of potential and current transformers is used for primary circuits.

In a similar connection two indicating wattmeters will give the energy of the circuit at any moment. An indicating wattmeter with its current coil in one phase-wire of a three-phase system, will give three diverse readings according as its potential coil is connected between its own wire and each of the other phase-wires, or finally across the two other phase-wires. The latter reading is dependent on the angle of lag, being zero for unity power factor, and a wattmeter so connected can be used as a phase meter, while the other readings will be respectively increased and diminished to an amount dependent on the lag.

Many attempts have been made to combine the two wattmeters necessary to measure correctly the energy on an unbalanced three-phase circuit into a single instrument, and recently with considerable success. Fig. 332 shows a combined induction wattmeter, for two- or three-phase circuits, balanced or unbalanced, and Fig. 333 its connections with current and potential transformers as viewed from the front when used on a three-phase, or three-wire two-phase circuit. If the three-phase circuit to be measured be a balanced one, such a composite wattmeter need merely have a current coil connected in either lead and a pair of potential coils connected from this to the adjacent leads respectively. In testing motors

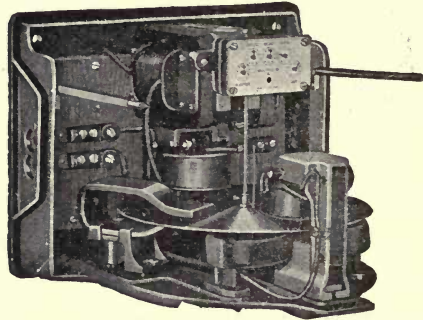

FIG. 332.

one can readily get the same result if the load be uniform, by using an indicating wattmeter with one lead connected through its current coil and then switching the potential connection successively to the adjacent leads, and adding the two readings. Instruments for unbalanced circuits should have two currents and two potential coils, as already indicated.

It should be noted that in balanced mesh-connected circuits one can measure the energy correctly by putting the current coil of the wattmeter into one side of the mesh inside the joint connection to the lead, and the potential coil across the same side of the mesh. This gives a reading of one-third the total energy. Ammeter and voltmeter similarly connected give readings showing one-third the apparent watts.

In ordinary three-phase distributing systems the actual

metering is much simpler than would appear at first sight. Motors are provided with a single meter, usually connected as shown in Fig. 330. Much of the lighting is from a pair of phase-wires or from one phase-wire and the neutral, in which case the secondary service is a simple two-wire distribution measured like any other monophase system. In cases where all three wires are taken into the same service, the energy can be measured by two meters, as shown in Fig. 331, or by a meter like Fig. 332.

The induction type of meter is sometimes liable to consider-

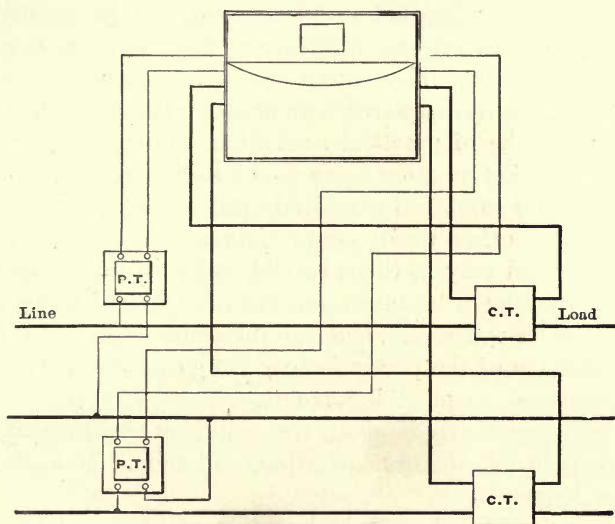

FIG. 333.

able errors on motor circuits where the power factor is subject to large variations, and should therefore be used with caution. Before purchasing meters it is advisable to ascertain by actual tests how they will perform on circuits of varying power factor. In the case of large station meters especially in polyphase stations, it is necessary as already indicated to take especial precautions. In the first place, the meter in such cases has a large constant, since it is operated from current and potential transformers, each of which transforms down to the meter. Assuming that the transformation ratios of these transformers are correct, there are still some residual errors that must be

looked out for. Unless the potential transformer has a negligible drop of potential under load, which is never really the case, the voltage supplied by it to the wattmeter will vary slightly with the load upon the transformer. Hence, for station wattmeters, separate transformers should be used if high precision is expected.

Second, there will be some variation of the phase displacement between primary and secondary E. M. F. due to the transformer reactance, which in a wattmeter is combined with another slight phase shift between primary and secondary current in the current transformers due to the magnetizing current required for the transformer core, and varying with the power factor. There may also be slight error from the wiring loss between the transformer and meter. None of these items would be of practical account in ordinary meter work, but in a station or other large meter they may be significant. They are of a combined magnitude which may be two or three per cent, in other words larger than any ordinary errors in the meter and may at times be additive with respect to these, so that they must be taken account of. Special transformers for the main wattmeter, and careful meter calibration for an average value of the power factor, will go far toward reducing such errors to a negligible amount.

Stray magnetic fields about the switchboard may also cause very appreciable instrument errors, and should be looked out for assiduously.

Meters should be installed where they will be free from vibration, extreme heat, and dampness, chemical fumes, and dust. To a less extent the same rules apply to other instruments, but meters with their constantly moving parts and very light torque should be looked after with particular care. They should be thoroughly inspected every few months, and at less frequent intervals should be carefully tested *in situ*, which can very readily be done by the aid of an indicating wattmeter connected to the same load. The following formula serves for this test:

$$\frac{3600 \times \text{Constant of meter (if any)}}{\text{Watts in use}} =$$

seconds per revolution of armature.

Nearly all meters use the magnetic drag, and a light mark near the periphery of the meter disk timed for a few revolutions with a stop watch, gives the right hand side of the equation, while the watts input is checked by the indicating wattmeter. The constant of the meter by which its reading must be multiplied to give the true energy recorded is nearly always plainly marked as an integral number upon the meter. If a meter shows material error it can be brought to the correct rate by slightly shifting the position of a drag magnet or adjusting the dragging device, whatever it is. This adjustment up to a reasonable amount is provided for in meters of all types, and if the error is more than can be thus compensated the meter should be thoroughly overhauled, particularly as to the armature bearings. For the details of meter inspection and adjustments reference should be had to the instruction books issued by the manufacturers, as many types and forms of meters are in use, and no generalized directions can fit them all.

With proper care, meters in commercial service can be kept correct within two or three per cent year in and year out. They are more apt to run slow than fast, so that the consumer seldom has just ground for complaint. For the best work meters should be installed with the idea of keeping them generally working near their rated loads. The greatest inaccuracies are at light loads, and part of the inspector's duty should be to make certain that the consumer's meter will start promptly on, say, a single 8 c.p. incandescent lamp. Otherwise the consumer can, and usually finds out that he can, get a certain amount of light without paying for it. Electric meters nearly always are read on their dials in exactly the manner that gas meters are read. With unskilled or careless men reading the meters there is some chance for mistake. To avert this some companies furnish their meter readers with record books having facsimiles of the meter dials plainly printed on the pages. The reader then merely marks on these with a sharp-pointed pencil the position of the hand on each dial of the consumer's meter, and the record thus made is translated deliberately at the office. Part of a page from such a record book is shown in Fig. 334.

A direct-reading meter, arranged somewhat after the manner

of a cyclometer, showing the total reading in plain figures, is a highly desirable instrument, but although several such meters have been brought out they have not as yet come into a secure place in the art. The difficulty is mainly a mechanical one. The meter can easily move one number disk, but, as it runs on, an evil time comes when it has simultaneously to move two, three, four, or five disks, and at one of these points it is likely to balk. Such a meter would be particularly hard to adapt to the induction type now widely used, and, desirable as it would be, the time of its coming is not yet.



Customer.....	Meter No.....	
Meter Capacity.....	Rate..... Constant.....	
Jan.		Hours.
Feb.		Hours.
Mar.		Hours.

FIG. 334.

For special purposes a considerable variety of meters are used, all, however, being made and applied on substantially the lines already described. In some cities prepayment meters with an attachment for switching on the current worked like a slot machine, are finding a foothold, particularly in the poorer quarters. Elsewhere two-rate meters with a clock-work attachment to cut down the rate of running between certain hours of relatively light station load, and some other automatic discount meters, have been employed. But all these are peculiar in their special attachments rather than in any fundamentals.

The chemical meters of which the early Edison meter was a type, have passed quite out of use in this country. In spite of certain advantages, the demand for a meter which can be

read by the consumer and the use of alternating current grew so overpowering that the chemical meter had to go. It survives in various forms abroad, some of them rather successful, and even arranged for direct reading upon an easily observed scale.

Whatever meters and instruments are used, it is of primary importance that they be kept always in the best working order.

Most of the measurements with which the supply station has to do are those connected with metering, but at times more difficult problems arise. Most of these are due to the use of unusually high voltage. The exact determination of high primary voltages is rather troublesome when one gets beyond the potential transformer and desires to obtain independent voltage measurements. The most available method of work is to use a high-grade voltmeter, very carefully insulated, in connection with very high and nearly non-inductive resistances, of which the impedance has been carefully determined before hand. It must be remembered that such impedances must be added to the voltmeter impedance geometrically, as is generally the case in alternating current measurements.

For a check upon such devices electrostatic instruments may sometimes be used to advantage. The best known of these is the Kelvin electrostatic balance shown in Fig. 335, and in its simpler forms well known in laboratories. It is merely a quadrant electrometer reduced to a practical form, and is obtainable for voltages of even 50,000 and more. It is not a very convenient instrument to use, but at times serves a useful purpose in keeping track of errors, being free from all those associated with the amount and phase of the current necessary in working electro-dynamic instruments.

Very earnest efforts have been made to obtain a close measurement of voltage by its sparking distance between points. As appeared from the previous discussion of this matter, the measurement is a somewhat troublesome one, but it has a value in that it measures the very effect that is sometimes most important in keeping track of abnormalities of line pressure. From the work thus far done it appears that by careful attention to detail, fair precision may be reached, but that it is unsafe to rely upon tabular values unless for the apparatus and conditions of use these values are checked at a few points.

Within limits the method is useful, and anyone interested in trying it will find a good account of the details in a paper by Fisher.*

The measurement of line insulation on high tension systems is another troublesome matter. In fact, very little has been

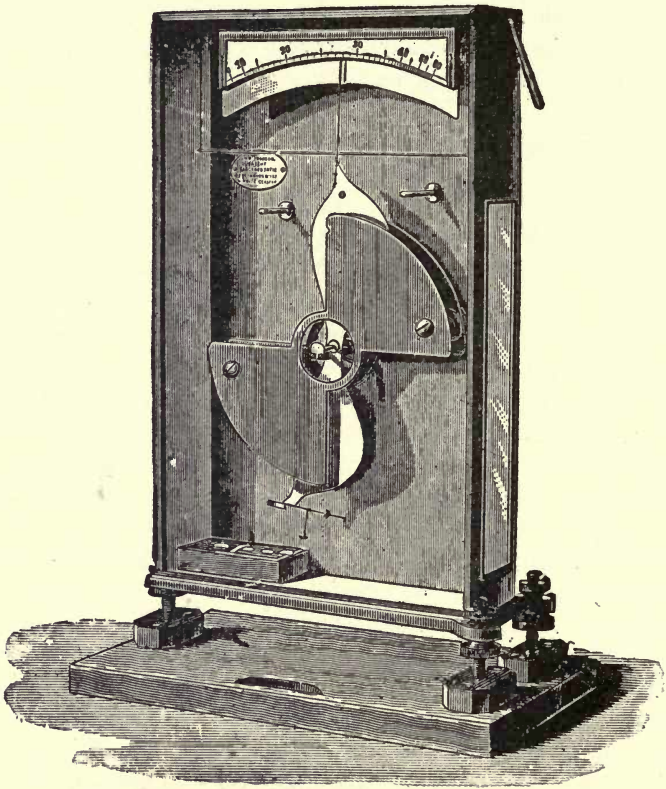

FIG. 335.

done on this problem beyond the ordinary resistance measurements that may be made with the "bridge-box," which should form a part of every station equipment. The capacity of a long line is so considerable as to introduce great difficulties in testing with high alternating voltages, and direct

* Trans. Int. Elec. Cong., 1904, Vol. II., p. 294.

current voltages high enough to be of much use in testing are difficult to attain. For such measurements, for capacity measurements, and the like, one has to revert to strictly laboratory processes, since no commercial apparatus is up to the present available.

No useful general method of locating faults on high tension overhead lines has yet been devised. They occur under so various conditions and for so different causes that they cannot be treated in any systematic way. The telephone and friends along the line is the winning combination in case of trouble. As a rule line troubles are not instantaneous in their occurrence, and serious results can often be averted by starting a prompt inquiry over the wires. On high voltage systems any abnormal loss of energy means mischief in the very near future, so that there is the constant necessity of keeping the insulation at the highest attainable figure. If it is low enough to measure readily, it is too low for safety. On underground circuits which are usually of rather moderate voltage and length, troubles assume a more definite character and can generally be located when the cable can be put out of service and tested.

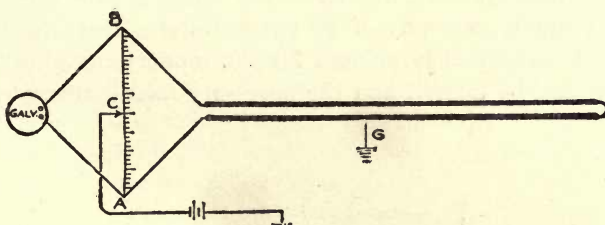

FIG. 336.

Insulation tests are here of more service and should be periodically made. In case of grounds the following adaptation of the loop test, described by Ferguson in a valuable paper on underground work,* may be found useful. Fig. 336 shows the arrangement of the apparatus. *AB* is a slide wire bridge or its equivalent, carefully calibrated. *C* is the moving contact connected to a grounded battery. Let a conductor be grounded at *G*. Join the remote end of it to the end of a

* Trans. Int. Elec. Cong., 1904, Vol. II., p. 683.

sound conductor and the near ends respectively to the ends of the bridge. Then balance in the ordinary way. Let L be the total length of the joined conductors. Then

$$A G = \frac{A C (L - A G)}{C B}.$$

L may be taken directly as linear distance if the loop is of the same cross section throughout, but if the sizes differ L should be taken as resistance and $A G$ should be reduced to distance from the known size of the conductors. The result does not involve the resistance of the fault, but this should be low enough, or the testing voltage high enough, to get proper deflection of the galvanometer. This test is reported to give location within one or two hundred feet, in lines from 1 to 5 miles in length. If the conductor is burned off, the fault can sometimes be located by capacity tests from the two ends, if there is not too much leakage. Similar tests can in a certain number of cases be used for overhead lines, for which reference should be had to the general testing methods used on telegraph systems, but as before noted a fault on a high tension line is generally of so pyrotechnic a character that it can be located closely enough for the repair gang long before the line can be cleared and the necessary measurements made.

CHAPTER XVIII.

PRESENT TENDENCIES IN HIGH VOLTAGE TRANSMISSION.

It is now nearly seven years since the third edition of this work appeared, and during that time there has been a great advance in the freedom with which high voltage is employed, although there have been no sensational changes. Improvement has come through gradual progress along lines which had already been pretty well mapped out.

In fact, the list of high voltages in existing plants runs little higher to-day than it did five years ago, albeit the average working voltage, if one may be permitted to speak of so vague a thing, has been nearly doubled within the same period. The list of high voltage transmissions which appears at the end of this chapter, tells the story clearly enough. It has proved so hopeless a task even to catalogue the 10,000 volt plants that it has been necessary to confine the list to those plants operated at 20,000 volts or more. There are about 110 such plants in the United States, Canada, and Mexico, as against 70 plants working at or above 10,000 volts five years ago. And of the total list at least 25 are working at or above 50,000 volts, in contrast with the single plant of the earlier date.

The longest distance of transmission in the earlier list is 145 miles, on the same great system which has now carried commercial transmission up to 232 miles. The region between 40,000 and 60,000 volts has now been pretty thoroughly explored, and may be entered without fear. The difficulties encountered there are, as was to be expected, connected with the line insulation. So far as transformers are concerned, higher voltages than 60,000, perhaps up to 80,000 or even 100,000, might be commercially employed, but the insulator has not kept pace with the transformer, and while excellent insulators have been made for use, at 60,000 volts and even a little higher, the factors of safety, generally 2.5 to 3, are not yet as great as conservative engineer-

ing should demand. That this condition will be improved there is little reason to doubt, but for the present great caution is desirable in going above 60,000 volts.

The most radical innovation in high voltage construction is the introduction of the tower construction with spans of 500 ft. or more. The tower system gives certainly a very durable line, and one which, under some conditions, is relatively cheap. Its weak point is exceptional danger from lightning, and the certainty that any insulator failure will put the line out of business unless current is immediately shut off on any sign of a ground as is the custom on some tower systems. The use of thoroughly treated wooden cross arms would probably relieve this difficulty to a considerable extent.

As to distance, the question is now as it always has been, a commercial one. The higher the available voltage, at least within wide limits, the greater distance can be covered with a given capital and maintenance charge per kilowatt transmitted. Certain elements of cost like right of way, poles, insulators, and line construction depend mainly upon the distance alone and not upon the output, so that in a general way the larger the amount of power to be transmitted the farther it will pay to transmit it irrespective of voltage, which in every case of long transmission is likely to be pushed up as far as the state of the art permits. At the present time power is regularly transmitted 100 miles or more from about a dozen plants, but the ordinary requirements are, and are likely to remain, very much below this figure.

As a matter of fact, there are comparatively few sources of power which are compelled to find a market at a great distance or are large enough to warrant a very long transmission. In most cases the power can be sold within a radius of much less than 100 miles. Still, there are instances in which conditions demand a far greater distance of distribution. At the present time enough experience has actually accumulated to justify transmissions of several hundred miles, so far as the engineering side of the matter is concerned.

Few data on the economic performance and cost of maintenance of very long lines are available. The latter item undoubtedly increases considerably faster than the length of the line since the actual number of troubles increases, other things being equal, about as the number of insulators, while

they are scattered over a large territory that must be watched. This fact has a bearing on the advantage gained where very large amounts of energy are transmitted.

In the matter of commercial frequency there is small tendency toward change. A large majority of all the high tension plants, including nearly all of those operating over 100 miles or more, are worked at 60~. One of the remaining ones is worked at 50~, the others at 25~. In the case of a transmission of several hundred miles involving say 50,000 or 100,000 KW, a lower frequency than 60~ would certainly be advisable, but for the rank and file of plants there is a tendency to standardize at 60~ unless there is some very good reason to the contrary.

As to generator voltage, practice has not been much changed recently. With the increasing use of 20,000 volts and upwards there is perhaps somewhat less incentive to use high voltage generators, which now show an economy only on lines of a few miles in length. Nevertheless, many generators of 10,000, 12,000, and 13,500 volts are in use, the first mentioned having been superseded in new plants by the others. For use with raising transformers of course any voltage will serve, but practice is now gravitating toward about 2,200 to 2,400 volts which is standard for local lighting and power distribution.

Occasionally a somewhat higher voltage is chosen on account of a more extensive local load than can be conveniently managed at 2,200 volts, but such instances are exceptional.

The most striking and important feature in recent power transmission work is the growing tendency to unite the power generating plants of a single district into a coherent system. This means far more than the fusion of the business of several stations into a single administration — it implies as well the physical organization of a group of plants into a single dynamical unit. It must not be confused with the tendency to replace a group of stations by a common central plant, a practice often carried to unwise extremes.

The development of the transmission network is carrying out upon a gigantic scale the same organization that has proved so valuable in low tension distribution networks. It consists in linking together into a network the transmission lines of all

the power plants of a large region, so that each may reinforce the others in capacity and in the market for output. The region covered may amount to thousands of square miles, and the stations linked may be half a dozen or more, scores of miles apart and located on different streams, and even upon different watersheds. It has proved feasible to operate many plants in parallel on such a network whether large or small, driven by water- or by steam-power.

The essential feature is that the network voltage shall be high enough to enable the plants to work together without a loss in the lines sufficient to imperil regulation.

If the network be wisely laid out it will like low tension net-

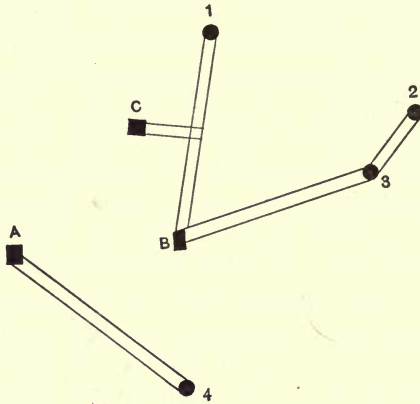

FIG. 337.

works, enable the territory to be covered at a lower cost for lines than if independent feeding systems were employed, or for equal costs it will give a lower average loss of energy.

There is also a considerable gain in the matter of establishing reserve capacity, since in case of accident the several plants can help each other out. In the same way, with a properly arranged network one line so serves as a relief for another as to obviate the necessity for duplicating lines.

The details of networks are very various and there are no precise rules to be laid down, but the general principles are shown in Figs. 337 and 338. The former shows the ordinary arrange-

ment of independent stations, the latter the effects of intelligent linkage. In Fig. 337 there are four generating stations 1, 2, 3, 4, and three load points A, B, C. We will assume 1 and 4 to be the most important stations, and B the largest load point. Now as power plants are commonly installed by diverse interests and somewhat at haphazard, one would generally find say three companies working, one supplying A from station 4, another supplying B and C from station 1, and a third supplying B from stations 2 and 3. The lines certainly, and the pole lines generally, would be in duplicate, and the voltages would differ according to the period of the respective installations. In point of fact the largest network

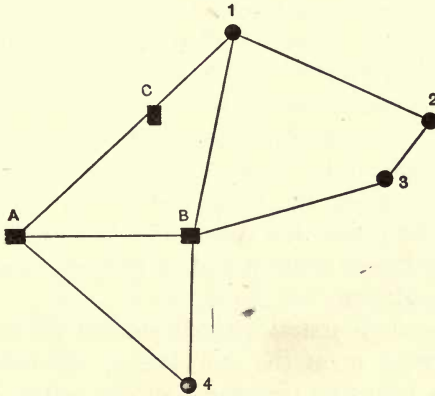

FIG. 338.

in existence is the result of a consolidation which left the operating company in the proud possession of lines at 50,000, 40,000, 23,000, 16,000, 10,000, and 5,000 volts, and it is small wonder that the work of standardization has been long delayed.

Now, were the situation of Fig. 337 developed in accordance with the methods now becoming current, the result would be something like Fig. 338 modified more or less by topographical and commercial requirements. Here there are no duplicate lines as such, but each load point is supplied by two or more lines through each of which all the generating stations can deliver current.

The security against interruption is further increased by the fact that the several supply lines to each load point follow different routes. As regards auxiliary plants and spare capacity the network of Fig. 338 is highly advantageous, since a single auxiliary plant, say at *B*, will serve for the whole system, and the reserve generator capacity can be located wherever it seems best.

The price paid for these advantages is some additional loss in the lines at times when the longer routes are in action, and some additional care in operation.

The latter requirement comes not so much from any one cause as from a variety of causes. As a general proposition, a group of stations can be operated in parallel without much difficulty provided the stations individually are well designed. The first requirement is stability of voltage at the several stations, which implies in turn generators giving close regulation, especially under changes of lag, and operated at constant speed. Second, there should not be excessive drop in the lines, for changes of terminal voltage due to this cause make it difficult to equalize the loads between the stations. Third, there should be means for governing the power factors so as to steady the inductive drop and to keep down cross currents between the stations.

The best modern practice tends toward throwing the burden of regulation upon the sub-station, the endeavor of the power houses being to preserve uniform voltage at the ends of the respective lines. The details of regulation are then looked out for by the sub-station regulating apparatus, voltage regulators, or synchronous motors at adjustable excitation. In this operation the power factor meter plays an important part.

Obviously a scheme of regulation such as this cannot be carried out effectively unless it is accomplished at a single point and under systematic direction. The regulating point is naturally the main substation as at *B*, Fig. 338. For such a single point the regulation can be reduced to a rather regular programme, but the wandering of the load which takes place on every large system complicates the situation. For example, at certain times of the day, *A*, Fig. 338, may require

an abnormal proportion of the total load, and the voltage regulators must be adjusted accordingly; the exact programme being determined by experience. The problem is akin to voltage regulation upon a large distributing system, and must be solved by the same general process.

As in distributing networks, too, means must be provided for promptly isolating lines on which there is trouble, and to this end it is often necessary to do a certain amount of switching at high tension. If, for example, the line *B 3*, Fig. 338, begins to show signs of trouble, quick work in cutting it clear may often save a short circuit that would seriously disturb the voltage of the whole system.

When a group of stations of very diverse character is to be operated in parallel great care must be taken with the governing. If a sudden variation of load occurs, the natural tendency is for the shock to be taken up by the plant equipped with the most sensitive governor. This would practically mean that if a steam plant were one of the group it would have to stand the worst of the blow, which would then fall in succession upon the hydraulic plants in order of the rapidity of their governing. As it is undesirable generally to make the steam plant take up such variations, the governors in the several plants should be adjusted for rapidity of action in such a manner if possible, as to throw the shock on the plant best able to stand it.

The large networks of the country have grown up rather gradually so that they have not been arranged as yet to operate in the fullest harmony, but they are being steadily improved.

The most striking single example of a great and far-reaching system is that of the California Gas and Electric Co., of which much has been heard. It is shown roughly in Fig. 339, which gives not only the system but the parts from which it has been aggregated. It operates about 700 miles of line at 50,000 volts, besides several hundred miles at lower voltages, and has an aggregate capacity of about 50,000 KW. There are all told 14 power houses, the most recent being a huge gas-engine auxiliary plant in San Francisco, with 4,000 KW units, the first of which has just been installed. As will be

seen from the map, the fusion of the whole into a network is not yet complete, but it is being done as occasion offers. The transmission from the De Sabla power house to Sausalito,



FIG. 339.

232 miles, is the longest yet attempted in the world although, on occasion, power has been commercially transmitted between points on the system nearly 350 miles apart. The main transmission may be reckoned at about 150 miles from

the chief power houses at Colgate and Electra. On this system have been worked out some very important problems in power transmission. The long cable span over Carquinez Straits has already been described, and it need only be added that during more than three years of operation it has given no trouble. Long spans are freely used on the more recent parts of the system with a strong wooden pole construction. Another interesting feature of the system is the considerable use of long break open-air disconnecting switches on lines up to more than 60,000 volts, and also the practical abandonment of ordinary lightning arresters in favor of open-air horn-gap arresters of the simplest possible description. The whole system spans a space of about 240 miles in length by about half that breadth, and constitutes altogether the most extensive power-transmission yet undertaken, supplying light and power at nearly a hundred distribution points. The uniform frequency is 60~ and the voltage is tending toward 60,000 as the general limit for the present.

Second only in magnitude to this system is that of the Los Angeles Edison Co., in southern California. This was earlier than the northern system in its inception, containing among its constituents not only the first polyphase transmission plant operated in America, but the first long distance plant operated at anything like the voltages now common. It is less characteristically a network than the system just described, being essentially a long trunk line through the splendid valley that lies south of the Sierra Madre, beginning in the mountains just east of Redlands and running clear through to the sea, with numerous branches, the main point of supply being Los Angeles itself. The system operates 8 plants, five hydraulic and three steam, with several more hydraulic plants under construction. Fig. 340 shows in outline the group of plants and transmission lines at present constituting the system. The beginning of the network was the Redlands plant, known on the map as Mill Co. Hyd. P.H. 1, the first polyphase transmission plant, started as a 2,500 volt transmission into Redlands in 1893. Three years later the Edison Company started with a steam station in Los Angeles, and in 1898 it acquired the Southern California Power Com-

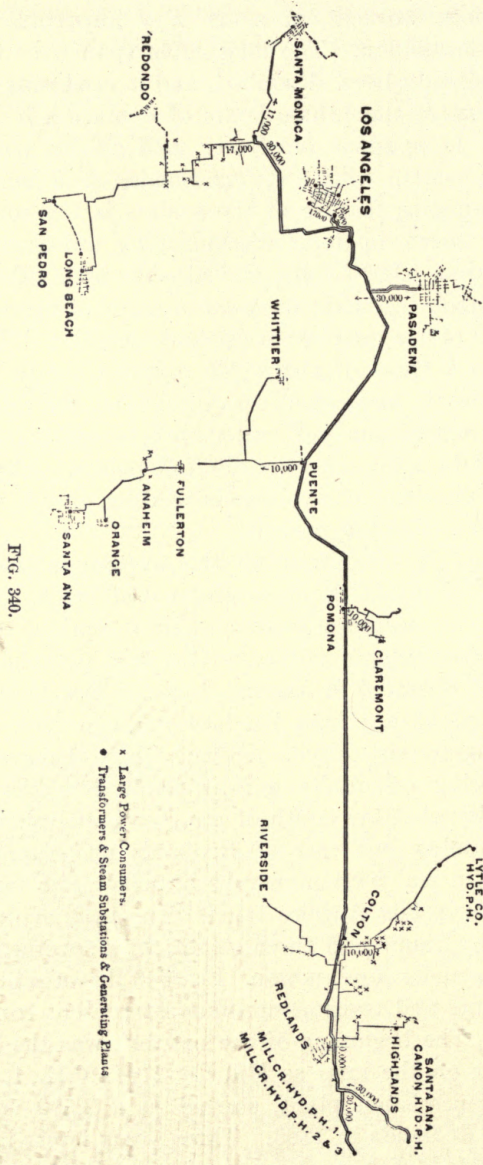

FIG. 340.

pany, which then owned the original Redlands plant and the Santa Ana cañon plant with its 80 mile transmission at 33,000 volts into Los Angeles, the first of the very long high voltage lines. Since then its growth has been rapid. In 1896 the Mill Creek plant was changed by extending the pipe line, from 377 to 530 ft. head, and raising transformers to 10,000 volts were installed, although it is interesting to note that the original generators are still in use after more than 12 years of service. Later, Mill Creek power houses No. 2 and No. 3 were added higher up the cañon. Also in Santa Ana cañon a plant, No. 2, has been added, and No. 3 and No. 4 are projected. In the same region the Lytle Creek Power House has been added on a branch of the Santa Ana River. A point worth noting in several of these later plants is that the receiver, a usual feature of the earlier hydraulic plants, and already mentioned, has been abandoned in favor of branches spreading finger-like from the end of the main pressure pipe, cast-steel Y's being used for the division. This arrangement averts some loss of pressure otherwise incurred.

Another feature lately introduced in the hydraulic construction, is the use of concrete pipe on the slight grades leading to the steel pressure pipes. This pipe is moulded on the ground of heavy gravel 2 parts, and Portland cement 1 part, made up in very short sections and united by concrete collars. It is laid in trenches and back filled. Depressions across which this pipe cannot be conveniently laid are spanned by steel pipe in inverted siphons. Aside from the hydraulic plants here noted, the system is to be supplied with a very large additional amount of power from points on the Kern River far to the northward, over a transmission system of nearly 150 miles in length. The number of power sites available is 6, aggregating some 87,000 HP at the minimum, but of these only plant No. 1 is needed for immediate use, and that with some 24,000 HP capacity is nearing completion. A notable fact is that the whole Kern River district is across the Sierra Madre Mountains, on a watershed of its own covering some 2,000 square miles, and has a higher and more wooded region upon which to draw than is possessed by the streams earlier developed.

The whole system is operated at 50~, which was the frequency adopted for the original Redlands plant.

As in the work of the California Gas and Electric Company, there is here also a tendency to use much longer spans than are common in regions where transmission lines are less familiar. Fig. 341 shows the pole head used for some miles of recently constructed line. Of course, anyone who takes the trouble to design a pole line instead of guessing at it knows that a 225 ft.

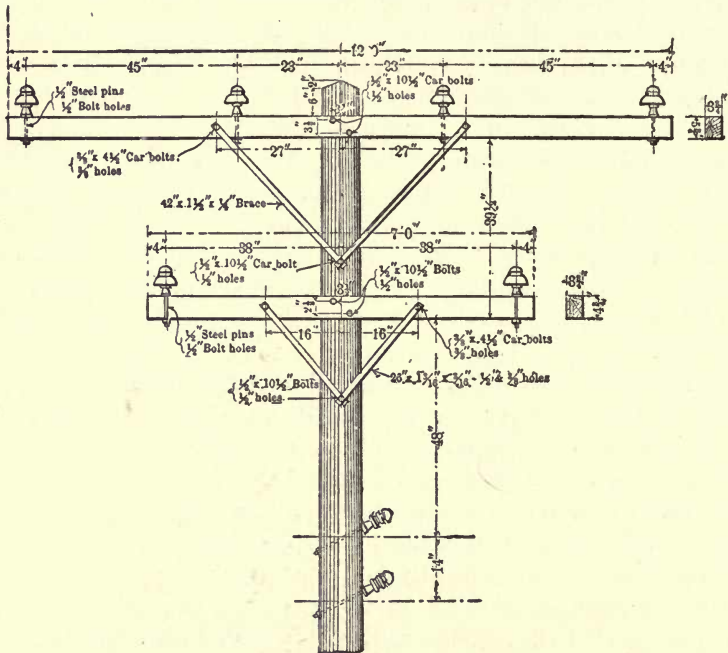

FIG. 341.

span such as is here used is entirely feasible with light high voltage wires, but it is a rather striking exhibit to see the plan carried out with a 12 ft. upper cross arm. The line thus constructed stood up against wind storms of exceptional violence without the slightest damage. It is generally preferable to set the wire triangles with the points up instead of down as here shown, and in most cases so long a cross arm as here shown would scarcely be needed.

The important group of plants near Salt Lake City, Utah, has already been noticed. The system just over the mountains near Telluride, Colorado, although much less extensive, is memorable as the scene of the first serious work on transmission at high voltage from which was derived much of the data and experience which has made modern transmission practicable.

The transmission network fed from many stations must certainly be ranked as the most considerable advance in power transmission made within recent years. As at present carried out it is mostly concerned with large powers, but the same principle applies whatever the scale of the operations.

There are many small powers which can well be utilized in a similar manner. The tendency is to work up the large powers and to neglect the lesser ones.

Another line of operations which is beginning to be pressed is the creation of artificial powers. In regions of fairly considerable rainfall the aggregate amount of water received by a given watershed may be large, while the distribution of runoff is very unfavorable. If the situation is such that even a few square miles of watershed can be made to contribute to a storage system at high head, a very considerable permanent power can be developed.

The problem is akin to the ordinary one of providing water supply for city use or for irrigation, with the exception that for a power plant the available head should be as great as possible.

Oddly enough the most typical case of the kind here considered is to be found in the State of Vermont. In the southern reaches of the Green Mountains there is much high country over which the rainfall is heavy, averaging nearly 45 inches per annum, and at a point in this region about eleven miles from Rutland on East Creek, a water storage for power purposes has been created. The area of the pond is about 800 acres, secured by a dam 750 ft. long and 54 ft. in maximum height. The storage here secured amounts to 435,000,000 cubic feet and by a pipe line 35,000 ft. long the water can be delivered under a head of 697 ft. At the present time the water from the large reservoir is used to reinforce the supply in a second reservoir 5 miles down stream having a capacity of about 63,000,000

cubic feet, and this lower reservoir supplies the power station under a head of 222 ft., through a pipe line 8,000 ft. long. Thus at present only about the lower third of the fall is utilized, though the rest can readily be made available.

The drainage area of the upper reservoir is only 15 square miles, but of a total rainfall of 45 inches only 11.5 inches need reach the pond to fill it, while the actual run-off from the watershed has been found by measurement to be nearly 70 per cent, so that there is a large margin of safety in reckoning the storage given.

At the full head given the 435,000,000 cubic feet of storage would give more than 5,000,000 KWH per year, available as desired, and equivalent under ordinary conditions of use to an installation of more than 2,000 KW. Even now 1,200 KW of generator capacity is in place, and the maximum output provided for is merely a question of profitable use.

The cost of purely artificial storage is generally high and only in case of very great heads is it likely to pay at present. If topographical conditions are favorable, however, there is no reason why impounding the rainfall cannot be made profitable. The actual amount of land diverted from its ordinary uses is in such a case only that used for the reservoir, in which this power storage has the advantage of storage for water supply, and stands in exactly the position of storage for irrigation. In the Chittenden reservoir only some 800 acres of upland was removed from employment as farm, forest, or pasture. As regards the rest of the watershed, it is rather improved than injured by the pond.

Looking at the proposition broadly, one can under a head of 650 to 700 ft. store power on the basis of 1 mechanical horsepower hour from the wheels for each 60 cubic feet of water, or about 4,800 KWH for each acre per foot of depth. And for each acre of watershed one should be able at ordinary values of the run-off, to store this foot of depth. Mountain land, therefore, may easily be worth more for storage than for anything else. At present, water-powers can generally be developed from natural falls more easily than they can be thus created, but as the natural powers are taken up and fuel rises in price storage will become more and more profitable.

In the inevitable struggle of industry against increasing scarcity of fuel, every source of hydraulic power must be developed to the fullest extent. It is idle to speculate on the date of probable exhaustion of the coal supply since we know not what stores are hoarded unknown in the great unused continents of Africa and South America, but the fact remains that to-day the energies of the human race are being expended in regions in which fuel is necessary not only for industry but for artificial heat, and that the supply readily obtainable is being rapidly depleted.

At no distant day increasing cost of fuel will compel either a drift of civilization southward or the utilization of every continuous source of energy available. The key to the situation lies in the transmission of power at high voltage and in the union of all the available powers of a large district into a coherent network. The steady rise in working voltage during recent years makes possible an ever increasing area over which networks can be made effective.

The following approximate list of plants now operating at 20,000 volts and more, tells more plainly than any general statement the tendencies now prominent. But steps are now going forward toward still higher voltages, 70,000 to 80,000 being already in view, and for some of the transmissions now being seriously considered, like that from Victoria Falls on the Zambesi to the Rand, something like double even these figures is imperative for commercially profitable work.

The highest voltage now regularly in commercial use is 69,000. Then follows a group of 60,000 volt plants some 15 in number, and while some of these are working slightly under the rated pressure most of them are fairly up to the limit. On the whole these high voltage systems are being worked with little if any more trouble than those at half the pressure, and at the present moment 60,000 volts may be regarded, as in a measure, standard pressure for very long transmissions. Above this experience is still very limited, and while some large transformers have already been shipped insulated for voltage as high as 80,000, they are, so far as yet announced, actually worked in star connection or on taps for lower voltage. The Los Angeles Edison Co. which has

done much pioneering in high pressure work, is experimenting with 75,000 volts on its Kern River line, and it is very likely that this plant and others will soon regularly pass the 70,000 volt mark to greater or less extent.

The insulator is the only thing which stands in the way. Very recently material progress has been made in insulators carrying the wires in suspension, and thereby avoiding the very serious difficulty of supporting the structure necessary to give proper sparking distance for voltages of 100,000 volts or more. The experimental results from such insulators are good, but they have not yet been tried out to any such extent as is necessary thoroughly to test their mechanical properties. At the present high prices of copper and aluminum the need of a general increase of voltage is pressing. In case of very long lines the cost is very severe even at the highest voltages now in use. If the suspension insulators prove effective and reliable, there will be a good change for considerable increase and corresponding economy.

The present list shows how fearlessly voltages considered extreme a few years since, are now employed under all sorts of climatic conditions, and this fact is the best possible augury for greater achievements in the future.

American Plants Worked at 20,000 Volts or More.

Name.	Location.	Capacity, KW.	Voltage.	Dis- tance.	Fre- quency.
Grand Rapids-Muskegon Power Co.	Roger's Dam, Mich..	3,000	69,000	58	30
California Gas & Electric Co.....	Colgate, Electra, De Sabla, and elsewhere, Cal.	50,000	15,000 60,000	{ 139 145 232 }	{ 60 60 60 }
American River Electric Co.....	Placerville, Cal.....	3,000	60,000	90	60
Ontario Power Co.....	Niagara Falls, Can.	30,000	60,000	25
Winnipeg General Power Co.....	Lac Du Bonnet, Manitoba	5,000	60,000	67	60
Electrical Development Co. of Ontario.	Niagara Falls, Ont..	88,000	60,000	160	25
Canadian Niagara Power Co. ...	Niagara Falls, Ont..	37,500	22,000 40,000 60,000	{ 93 93 93 }	{ 25 25 25 }
Washington Water Power Co...	Spokane, Wash.....	9,000	60,000	110	60
Guanajuato Electric & Power Co.	Guanajuato, Mexico.	2,400	60,000	101	60
Whitney Reduction Co.....	Sailsbury, N. C.....	25,000	60,000	75	50
Madison River Power Co.....	Wisconsin.....	2,000	60,000	60	60
Los Angeles Edison Co.....	Kern River, Cal.....	20,000	60,000	139	50
Great Northern Power Co.....	Duluth, Minn.....	22,500	60,000	25
Missouri River Power Co.....	Helena, Mont.....	4,500	60,000	60	60
Winnipeg Electric Railway Co..	Lac Du Bonnet, Winn.	14,000	60,000	65	60
Missouri River Power Co.....	Canyon Ferry, Mont.	7,500	57,000	65	60
Columbia Improvement Co.....	Seattle, Wash.....	23,000	{ 55,000 40,000 }	{ 47 47 }	{ 60 60 }
Nevada Power & Milling Co.....	Bishop's Creek, Cal.	1,500	50,000	113	60
Columbia Improvement Co.....	Taylor's Falls, Mich.	10,000	50,000	38	60
Shawinigan Water & Power Co..	Montreal, P. Q..... (Shawinigan Falls).	15,000	50,000	80	30
Union Traction Co. of Indiana..	Anderson, Ind.....	3,000	50,000	27
Animas Canal Co.....	Durango, Colo.....	4,500	50,000	55	60
Minneapolis General Elec. Co...	Taylor's Falls, Minn.	10,000	50,000	41	60
Hamilton Cataract Power Light & Traction Co.	Hamilton, Ont..... (Decew Falls)	{ 2,200 2,200 }	{ 45,000 45,000 }	{ 36 36 }	{ 66 66 }
Lewiston-Clarkston Co.....	(Lewiston, Id.) Clarkston, Wash... Asotin, Wash.....	{ 900 900 900 }	{ 45,000 45,000 45,000 }	{ }	{ 60 60 60 }
Juniata Hydro-Electric Co.....	Warrior's Ridge, Pa.	2,000	45,000	30	60
Southern Power Co.....	Great Falls, S. C.....	24,000	44,000	60
Telluride Power Transfer Co.....	Provo, Utah.....	1,500	40,000	55	60
Power Co. of Montana, The.....	Norris, Montana.....	2,000	40,000	67	60
Kalamazoo Valley Electric Co...	Kalamazoo, Mich.....	1,500	40,000	46	60
Detroit and Chicago Ry. Co.....	Kalamazoo, Mich.....	600	40,000	32	60
Plainwell Construction Co.....	Plainwell, Mich.....	2,500	40,000	75	60
Hercules Power Co.....	Logan, Utah.....	2,000	40,000	150	60
New Milford Power Co.....	Near New Milford, Conn.	6,000	33,500	30	60
American Falls Power Light & Water Co.	American Falls, Idaho	500	33,500	25	60
Conn. Railway & Light Co.....	Bull's Bridge, Conn.	4,500	33,500	40	60
Auburn and Syracuse El.R. R. Co.	Auburn, N. Y.....	1,300	33,000	25
Cedar Rapids Electric Light & Power Co.	Cedar Rapids, Ia.....	1,160	33,000	60
Central California Electric Co...	Sacramento, Cal.....	590	33,000	60
Fort Wayne & Wabash Valley Tr. Co.	Ft. Wayne, Ind.....	6,900	33,000	25
Hawaiian Electric Co.....	Honolulu, T. H.....	1,350	33,000	60
Indianapolis & Cincinnati Tr. Co.	Indianapolis, Ind.....	3,000	33,000	25
Indianapolis & Northern Tr. Co..	Lebanon, Ind.....	2,000	33,000	25
San Gabriel Electric Co.....	Los Angeles, Cal.....	750	33,000	60
Seattle-Tacoma Power Co.....	Snoqualmie, Wash..	11,000	35,000	40	60
Western Ohio Ry. Co.	Lima, Ohio.....	1,900	33,000	25
Spring River Power Co.....	Joplin, Mo.....	3,000	33,000	28	25
Southern Cal. Power Co.....	Redlands, Cal.....	3,000	33,000	80	50
Redlands Elec. Light & Power Co.	Redlands, Cal.....	4,500	33,000	80	50
Edison Electric Co.....	Crafton, Cal.....	3,000	33,000	80	50
Economy Light & Power Co., Joliet, Ill.	Lockport, Ill.....	1,875	32,000	37	60
Mt. Whitney Power Co.....	Visalia, Cal.....	1,350	30,000	36	60
Hudson River Electric Co.....	Spiers Falls, N. Y..	14,000	30,000	35	40

American Plants Worked at 20,000 Volts or More — Continued.

Name.	Location.	Capacity, KW.	Voltage.	Dis- tance.	Fre- quency.
Montgomery Water Power Co....	Tallassee, Ala.....	2,625	30,000	30	60
North Mt. Power Co.....	Junction City, Cal....	1,500	30,000	65	25
Aurora, Elgin & Chicago Ry.....	Wheaton, Ill.....	4,500	26,400	28	25
Columbus, London & Springfield Ry.	Medway, O.....	1,600	26,400	59	25
Montana Power Trans. Co.....	Butte, Mont.....	3,000	26,000	21	60
Columbia Mills Co.....	Columbia, S. C.....	1,000	25,000	18	40
Pioneer Electric Power Co.....	Ogden, Utah.....	3,750	25,000	40	60
Blue Lakes Water Co.....	Big Bar Bridge, Cal.	1,350	25,000	40	60
Montreal Cotton Co.....	Valleyfield, Que.....	2,800	25,000	17	60
Montreal Light, Heat & Power Co.	Chambly Falls, St. Therese	11,000	25,000	19	60
Snoqualmie Falls Power Co.....	Snoqualmie Falls, Wash.	6,000	25,000	45	60
St. Croix Power Co.....	St. Paul, Minn.....	3,000	25,000	28	60
Kaministiquia Power Co.....	Kakabeka Falls, Ont.	10,000	25,000	25
Utah Sugar Co.....	Salt Lake City, (Bear River) U.	2,250	23,000	90	60
Utica Gas & Electric Co.....	Trenton Falls, N. Y.	6,000	23,000	12	60
York Haven Water Power Co.....	York Haven, Pa.....	3,750	23,000	60
Belton Power Co.....	Belton, S. C.....	3,100	22,500	60
Phoenix Lighting & Fuel Co.....	Phoenix, Ariz.....	1,100	22,500	24	60
Cataract Power Co.....	Hamilton, Ont.....	2,000	22,500	33	66
Allegheny County Light Co.....	Pittsburg, Pa.....	16,000	22,000	60
Atlanta Water & Elec. Power Co.	Morgan Falls, Ga....	10,500	22,000	12	25
Utica Electric Light & Power Co.	Utica, N. Y.	4,000	22,000	12	60
G. & O. Braniff & Co.....	Tlalnepantla, Mex..	4,500	22,000
Siskiyou Electric Power Co.....	Yreka, Cal.....	500	22,000	32	60
Niagara Falls Power Co.....	Niagara Falls, N. Y.	78,750	22,000	22	25
Truckee River Power Co.....	Truckee River, Cal..	1,500	22,000	33	60
Barber Lumber Co.....	Boise, Id.....	900	22,000	10	60
Boise-Payette Electric Power Co.	Boise, Id.....	1,000	22,000	27	60
Big Creek Power Co.....	San Jose, Cal.....	1,200	22,000	60
Cascade Water Power & Lighting Co.	Cascade, B. C. (Co- lumbia River)	2,250	22,000	16	60
Cataract Power & Conduit Co., (Niagara Falls Power Co.)	Niagara Falls, N. Y.	37,500	22,000	25	25
Cia. Electricaè Irrigadora.....	Pachuca, Mex.....	2,250	22,000	28	60
Cia. Explotadora de las Fuerzas Hidro-Elctricas de San Idefonso.	Mexico, Mex.....	5,370	22,000	35
Condor Water & Power Co.....	Tolo, Ore.....	750	22,000	100	60
Cleveland & Southwestern Traction Co.	Elyria, Ohio.....	2,000	22,000	25
Corporation of Orilla.....	Orilla, Can.....	600	22,000	22	60
Detroit, Ypsilanti & Ann Arbor R. R. Co.	Ypsilanti, Mich....	1,750	22,000	25
Grande Consolidated N.S. & P.Co.	Grand Forks, B. C...	750	22,000	60
Highland Park Mfg. Co.....	Charlotte, N. C.....	1,500	22,000	60
Illinois Steel Co.....	S. Chicago, Ill.....	4,000	22,000	25
Lackawanna & Wyoming Valley Rapid Trans. Co.	Scranton, Pa.....	2,500	22,000	25
Niagara, St. Catherine & Toronto Ry. Co.	St. Catherine, Can...	500	22,000	12	25
Nooksack Falls Power Co.....	Myrtle Falls, Wash.	1,500	22,000	40	60
Northern California Power Co...	Redding, Cal.....	5,250	22,000	60	60
Portsmouth St. Ry. Co.....	Portsmouth, Ohio...	1,200	22,000	60
Stark Electric Ry. Co.....	Alliance, Ohio.....	1,000	22,000	25
St. Lawrence River Power Co....	Massena Springs, N.Y.	15,000	22,000	25
Trade Dollar Consolidated Mining Co.	Silver City, Id.....	1,125	22,000	22	60
Truckee River Wr. Power Co....	Floriston, Cal.....	1,500	22,000	38	60
Vancouver Power Co.....	Vancouver, B. C. (Lake Beautiful).	4,500	22,000	17	60
W. Penn. Ry. & Ltg. Syndicate..	Connellsville, Pa....	6,000	22,000	60 & 25
Youngstown & Sharon Railroad & Lighting Co.	Youngstown, Ohio .	600	22,000	60
West Kootnay Electric Power Co.	West Kootnay, B. C.	2,650	20,000	30	60
Colorado Electric Power Co.....	Colo. Springs, Colo..	1,410	20,000	30
Consolidated Mercur Gold Mines Co.	Mercur, Utah.....	600	20,000	60

American Plants Worked at 20,000 Volts or More. — Continued.

Name.	Location.	Capacity, KW.	Vol- tage.	Dis- tance.	Fre- quency.
G. & O. Braniff & Co.....	Deronica, Mex.....	20,000	50
Grand Rapids, Holland & Lake Mich. Railway Co.....	Jenison, Mich.....	1,000	20,000	25
Keswick Electric Power Co.....	Anderson, Cal.....	1,500	20,000	60
Wetmore Electric Co.....	Lowville, N. Y.....	250	20,000	60
Jacques Cartier Power Co.....	Quebec, P. Q.....	1,500	20,000	18	60
International Hydraulic Co.....	Canada.....	1,500	20,000	60
Hamawa Falls Power Co.....	Colton, N. Y.....	1,500	20,000	30	60

This list cannot claim to be complete, but it is approximately so at the date of writing. So many transmissions at 20,000 volts and thereabouts are now being installed that it is almost impossible to keep track of them even by the help of the large manufacturers, through whose courteous assistance this list has been made up.

INDEX.

- Air:**
compression of, efficiency, 51.
compressor, 48, 50.
gap in induction motors, 251.
reheater, 53.
- Alloys, relative properties of, 486.**
- Alternating currents:**
characteristics of, 125.
circuits, properties of, 125.
compared with d. c., 125.
- Alternating vs. d. c. machinery, 120.**
- Alternators. (See Generators.)**
- Aluminum:**
conductor joints, 489.
electrolytic corrosion of, 489.
vs. copper, 489.
- Ammeters, 661.**
a. c., 663.
recording, 670.
sources of error in, 663.
- Ampere:**
definition of, 21.
hour meter, 673.
- Analysis of wave form, 169.**
- Anchor ice, 409.**
- Angle of lag, 131, 133.**
method of measuring, 136.
- Arc motor, 89.**
lamps, power, current, and candle power of, 592.
lighting, commutating apparatus for, 285.
- Armature:**
(a. c.) iron clad, 162.
(a. c.) loss of e.m.f. in, 164.
four coil drum, 78.
inductance, ways of reducing, 165.
- Armature, *continued.***
of 5,000 h. p. Niagara generator, 180.
reaction, 96, 167.
effect of, 168, 170.
slots (a. c.), arrangement and insulation of, 163.
winding, bar type, 81.
comparison of Gramme and drum types, 81.
Gramme type, 80.
iron-clad drum type, 82.
modern ring type, 82.
polyodontal, 179.
principle of, 78.
turns per coil, 79.
- Arresters, 569.**
- Auto-converter, 249.**
- Auto-starter, 249.**
- Baum's method of alternator regulation, 197.**
- Barlow's wheel, 237.**
- Barometric height effect on striking distance, 497.**
- Battery, installation of, in water-power plant, 635.**
- Belting, loss in, 64, 427.**
- Boiler capacity for engines, 322.**
- Boilers, 309.**
classification of, 325.
efficiency of, 328.
evaporating power of various types, 330.
firing of, 331.
fire-tube vs. water-tube type, 331.
forcing of, 329.
fuels for, 329.

- Boilers, *continued*.
 furnaces for, 332.
 mechanical stokers, 332.
 merits of different classes, 326.
 results of tests of, 330.
- Booster transformer, 213.
 electrostatic, 521.
- Bradley split phase connection, 215.
- Bridges for damping fluctuations, 236.
- Bristol voltmeter, 669.
- Cable:**
 capacity of, 150.
 for long spans, 548.
 high tension underground, 577.
 insulation of, 485.
 methods of locating faults in, 685.
 submarine, 550.
- California Gas and Electric Co. system, 693.
- Canals, construction of, 405.
- Capacity:
 for splitting phases, 215.
 in actual circuits, 150.
 in circuits, 143.
 of armored cables, 150.
 of overhead circuits (formulas and curves), 516, 517.
 unit of, 144.
- Catenary curve, formulas for, 540.
- C.G.S. system, 2.
- Chapman regulator, 457.
- Charge, electric, definition of, 9.
- Charging current for line (formula), 517.
- Circuit breakers, 463.
 with time limit relay, 464.
- Circuits:
 a. c. inductance, 130.
 a. c. phase displacement, 131.
 a. c. properties of, 125.
 angle of lag, in 133.
 method of measuring, 136.
 capacity and inductance in actual circuits, 150.
 capacity in, 143.
- Circuits, *continued*.
 carrying leading current, 146.
 coefficient of self-induction of, 137.
 condensance in, 145.
 effect of energy losses on phase position, 153.
 energy losses in, 153.
 impedance, 134.
 diagram with condensance, 149.
 impedances in parallel, 142.
 in series, 141.
 increase of e.m.f. by condensance, 154.
 inductive e.m.f.'s in, 133.
 power factor in, 139, 149.
 resonance, 155.
 time constant of, 155.
- Circular coil, definition of, 508.
- Clearance in induction motors, 251.
- Coal, as fuel, 24.
 fields, extent and capacity of, 24.
 per i. h. p. with various types of engines, 332.
 utilization of, 32.
- Coefficient of self-induction, definition of, 137.
- Combe-Garot constant current transmission system, 109.
- Commercial problem, 639.
- Commutation, process of, 78.
- Commutator, multi-segment, 78.
 Pollock, 284.
 principle of, 18.
 sparking at, 79.
 synchronizing, 281.
 two-part, 18.
 volts per segment, 79.
- Commutators, rectifying, maximum output of, 287.
- Compound alternators, 174.
 wires, 488.
- Compounding arrangement for alternators, diagram of, 196.
 for inductive loads, 175.
 for various power factors, 176.
 of alternators on inductive load, 196.

- Compressed air transmission, 48.
- Compressor, air, 48, 50.
hydraulic efficiency of, 57.
Taylor hydraulic, 55.
- Compressors, air, efficiency of, 51.
- Condensance, definition of, 145.
- Condenser, effect of frequency upon
current received and delivered by, 144.
nature of, 143.
used to increase power factor, 152.
used to increase e.m.f., 154.
- Conductivity of various metals and
alloys, 486.
- Conductors, 539.
compound, 488.
high tension underground, 576.
loss of energy in, 475.
- Connections commonly found in
practice (table), 450.
- Constant current plants in Genoa,
104.
- Continuous current, 17.
production of, 77.
vs. a. c. machinery, 120.
- Converter, mercury vapor, 304.
cascade, 308.
efficiency of, 307.
for constant current, 307.
- Copper, hard drawn, tensile
strength of, 540.
losses, 200.
required by various transmission
systems, 186.
vs. aluminium, 488.
wire, mechanical constants of, 539.
wire, properties of (table), 509.
- Corliss valve gear, 313.
- Cosines, sines, and tangent (table
of), 522.
- Cost formula, 510.
- Cotton mill drive, 67.
- Counter e.m. f., 87.
- Cross-arms, 552.
steel and iron *vs.* wooden, 562.
- Culm, utilization of, 33.
- Current:
continuous, 17.
electric, 10.
generation of polyphase, 177.
leading, 146.
monophase, 158.
polyphase, 158.
reorganizers, definition of, 280.
three-phase, 182.
transformers, 664.
unit of, 21.
value of polyphase for motor pur-
poses, 179.
- Currents (a. c.), characteristics of,
125.
- Cycle, definition, 136.
- Dampers:
on synchronous machines, 236.
- Damping, 235.
- Dams, 399.
concrete steel, 404.
construction of, 399.
masonry, 401.
materials for, 400.
timber, 402.
- D'Arsonval galvanometer, 662.
- Delta connections, 185, 209.
- Depreciation charges, 647.
- Dielectric constant, definition of,
143.
- Discounts, 656.
- Distribution:
arc lighting, 591.
centre of load, 621.
constant potential, 119.
efficiency of, 120.
current and power taken by
lamps, 592.
desirability of motor service, 598.
diphase system, 613.
direct from transmission circuit,
581.
efficiency of, 63.
example of, 440.
substation system, 624.
few vs. many transformers, 587.

- Distribution, *continued*.
 from eccentrically located station, 603.
 large reducing stations, 607.
 scattered substations, 600.
 substation, 621.
 heavy substation, 629.
 interconnected diphas system, 615.
 interdependent dynamos and motors, 115.
 maintenance of uniform voltage, 583.
 methods of, 581.
 monocyclic system, 612.
 monophas system, 611.
 motor generator device to compensate for losses, 606.
 motor power, 62.
 motor service, 590.
 of power by shafting, belts, etc., 65.
 polyphase system, 613.
 primary, 590.
 problem, 482, 621.
 radial from centrally located station, 600.
 radius of operation of transformers, 590.
 railway load in addition to motor and lighting service, 602.
 regulation of voltage on secondary lines, 630.
 relative importance of polyphase, heterophase and single-phase systems, 277.
 secondary mains, 589.
 substation *vs.* house-to-house, 585.
 three-phase system, 615.
 three-wire system, 114, 610.
 two-wire system, 610.
 voltage, 608.
 Doble water-wheel, 362.
 Draft tube, 351.
 Drive:
 choice of, 427.
 from vertical shafts, 430.
 Dynamos. (*See* Generators.)
- Dynamotor, 103.
 Dyne, definition of, 20.
- Eddy current loss, 201.
 Edison three-wire system, 113.
 Electric charge, definition of, 9.
 current, definition of, 10.
 current, propagation of, transmission. (*See* Transmission)
- Electricity:
 flow of, 7.
 nature of, 1.
 principles of, 1.
 static, 8.
- Electro-magnetic induction, 13.
 strains, 11.
- Electrolytic strain on insulation, 123.
- Electrostatic booster, 521.
 instruments, 683.
- E.M.F. automatic regulation of polyphase generators, 194.
 effective, 188.
 generation of, 127.
 impressed, 131.
 increase of, by use of condenser, 154.
 induced, direction of, 14.
 inductive, 131.
 in resonant circuit, 156.
 loss in a. c. generator, 164.
 teaser, 189.
 unit of, 20.
 waves, 128.
- Energy:
 apparent, 136.
 classification of, 4.
 conservation of, 3.
 definition of, 2.
 electrical, 7.
 electrical measurement of, 660.
 internal heat of earth, 31.
 losses, effect on phase position of current, 153.
 luminous, 5.
 measurement of, on three-phase circuit, 676.

- Energy, *continued*.
 potential and kinetic, 2.
 sources of, 24.
 transformation of, 3.
 transformation, efficiency of, 4.
 wave, 5.
- Engine:
 and dynamo, combined efficiency of, 64.
 choice of, for given service, 324.
 steam, boiler capacity necessary, 322.
 boiler pressure, 318.
 choice of, for powerservice, 320.
 choice of, for railway service, 320.
 classification, 312.
 coal per i.h.p. for various types of, 332.
 compound *vs.* simple, 315.
 condensing *vs.* non-condensing, 315.
 effect of varying load on economy, 319.
 performance at different loads of various types, 321.
 performance of, 333.
 piston speed, 316.
 principle of, 309.
 speed of, 325.
 steam consumption, of different types, 318.
 thermal efficiency, expression for, 310.
 use of, superheated steam in, 322.
 valves, 312.
- Engines, 309.
 gas, 323.
 cost of fuel for, 642.
 cost of operation, 642.
 economy of, 25.
 thermal efficiency of, 323.
 solar, 27.
- Ether, 5.
- Evaporation, definition of, 329.
 in various types of boilers, 330.
- Exciter equipment, 455.
- Exciters, choice of, drive for, 432.
 connection of, 456.
- Faesch & Piccard governor, 380.
- Farad, definition of, 144.
- Faults, method of, locating, 685.
- Field:
 about current carrying conductor, 11.
 distortion of, 167.
 windings, 83.
 compound type, 85.
 series type, 84.
 shunt type, 84.
- Fire risk of transformers, 447.
- Fire-tube boilers, 326.
- Flat rate, 655.
- Flume, timber, 439.
- Flumes, 357.
 loss of head in, 397.
- Frazil, 409.
- Frequency:
 choice of, 278.
 formula for, 160.
 indicator, 471.
 meter, 670.
 used in rotaries, 300.
- Fuel:
 coal, 24.
 gas, 24.
 oil, 334.
 variation of cost of, throughout day per k.w., 348.
- Fuels, heat of combustion and evaporative power of various, 329.
- Furnaces for boilers, 332.
- Fuses, 461.
- Galvani constant current plant, 104.
- Galvanometer, 662.
- Gas as fuel, 24.
- Gas engine. (*See* Engine.)
 economy of, 25.
- Gearing, bevel, loss in, 41.

- G. E. voltage regulator, 458.
 Generator and engine, combined efficiency of, 64.
- Generators:
- a. c., armature reaction, 167.
 as effected by inductance, 523.
 Baum's method of regulation, 197.
 - compound wound, 85, 174.
 - compounding for inductance loads, 175.
 - connections commonly found in practice, 450.
 - constitutional features of, 159.
 - device for over-compounding on inductive load, 195.
 - direct connection of, 193.
 - efficiency of, 59.
 - field. (*See* Field.)
 - formula for frequency, 160.
 - G. E. compensated field alternator, 196.
 - general construction of, 190.
 - heterophase, 189.
 - inductor type, 192.
 - methods of reducing inductance in, 165, 166.
 - monocyclic system, 188.
 - polyphase, regulation of, 194.
 - practical limits of voltage, 532.
 - principle of, 126.
 - regulation of, 173.
 - relation between poles, speed, and frequency, 160.
 - revolving field, 191.
 - revolving field, advantages of, 194.
 - series wound, 84.
 - shunt wound, 85.
 - star and delt connections, 184.
 - theoretical e.m.f. generated by, 164.
 - three-phase, 181.
 - three-phase, efficiency of, 194.
 - wave forms, 128.
 - windings, 161.
- Generators, *continued.*
- advantages of moderate voltage, 441.
 - arrangement of, in power station, 432.
 - choice of drive, 427.
 - comparison of a. c. and d. c., 18.
 - commutators. (*See* Commutator.)
 - cost of, 651.
 - design, principles of, 18, 19.
 - energy required for excitation, 455.
 - high voltage, 689.
 - high voltage, d. c., 109.
 - inductance of, 150.
 - insulation of, from floor, 441.
 - location of, 424.
 - operated in parallel, 442.
 - principle of, 14.
 - regulation of compounding, 116.
 - turbo, 342.
 - two-phase, 178.
- Glass vs. porcelain, 492.
- Governors:
- action of, 371.
 - classification of, 372.
 - Fæsch and Piccard type, 380.
 - hydraulic, disadvantages of, 385.
 - load type, 374.
 - Lombard type, 376.
 - on Pelton wheel, 384.
 - water-wheel, 370.
 - Replogle type, 382.
- Gramme ring, 80.
- Ground detector, 472.
- Grounded conductors for lightning protection, 574.
- neutrals, 450.
- Gutta-percha, 502.
- Heat:
- radiant, 5.
 - of combustion, definition of, 329.
 - fuel oil, 334.
- Heating value of various fuels, 329.
- Henry, definition of, 138.
- Heterophase systems, 189.

High Voltage:

- measurement of, 665.
- measurements, 683.

Hoist motor, 94.

Hunting, 233, 235.

Hydraulic:

- development, 387. [415.
- maximum allowable, cost of,
- plants, description of various, 419.
- power, price of, 43, 46.

Hydro-electric plant, efficiency of, 67.

Hysteresis losses, 200.

Ice:

- on wires, 543.

Idlers for rope drive, 38.

Impedance:

- definition of, 134.
- diagram, 135.
- factor, 511.

Impedances:

- addition of, 15.
- in parallel, 142.
- in series, 141.

Incandescent lamps:

- 220 volt, 608.
- watts per candle-power, 593.

India rubber, 502.

Individual drive, 62.

Inductance:

- armature, ways of reducing, 165.
- effects on generator, 523.
- for splitting phases, 216.
- in actual circuits, 150.
- line, 506.
- nature of, 130.
- of generators and transformers, 150.
- of generators, method of reducing, 166.
- of line (curves), 514.
- on line, 121.
- troubles caused by inductive drop, 141.
- unit of, 138.
- used to preserve regulation, 523.

Induction:

- electromagnetic, 13.
- motor, 237.
 - advantages of, 266.
 - arrangement of windings, 253.
 - auto starter, 249.
 - choice of, 276.
 - comparative qualities of different types, 270.
 - construction of, 239.
 - depth of air gap, 251.
 - form of slots, 253.
 - maximum torque, 273.
 - performance curves, 266, 268.
 - primary winding, 247.
 - principle of, 239, 244.
 - relation between static and running torque, 274.
 - relation between resistance and reactance in, 273.
 - secondary winding, 239.
 - single-phase, 258.
 - single-phase, characteristic curves, 260, 262.
 - single-phase, principle of, 255.
 - slip as affected by resistance, 273.
 - slip in, 241.
 - slow speed, 268.
 - speed regulation, 275.
 - starting current, 271.
 - starting torque, 271.
 - use of resistance, in secondary, 272.
 - wattmeter, 673.
- Inductive drop, 141.
- Inductor type alternator, 192.
- Instrument equipment of generating station, 666.
- Instruments:
 - continuous current, 660.
 - edgewise type, 473.
 - electrostatic, 683.
 - used in power transmission, 468.
- Insulated wires, classification of, 502.

Insulation:

- continuous, 501.
- materials available for, 501.
- of a. c. and d. c. lines, 121, 123.
- of a. c. armature slots, 163.
- of bar-wound armatures, 81.
- of constant current line, 109.
- of lines, 122.
- of machines operated on constant current line, 101.
- tests, 685.

Insulator pins. (*See Pins.*)**Insulators:**

- factor of safety, 499.
- for high tension work, 565.
- line, 491.
- number replaced yearly, 568.
- porcelain, 565.
- sparking, distance for, 567.
- support of, 556.
- strain (novel type), 549.

Interrupter static, 572.**Joule:**

- definition of, 21.

Kelvin:

- balance, 683.
- Kelvin's law, 478.
- modifications of, 479.
- Kinetic energy, 2.

Lahmeyer rotary, 294.**Lamps, 220 volts, 608.****Leakage, 491.****Lentz's law, 16.****Light, electromagnetic theory of, 6, energy, 5.****Lighting, lamps in series, 102.****Lightning, 568.****arresters, 569.****danger from — with a. c. and d. c. apparatus, 123.****protection, grounded wire, 574.****Line, 474.****amount of copper required, 476.****Line, *continued.***

- calculation of terminal voltage, 517.
- calculations of losses, etc., 508.
- capacity of (formula and curves), 516, 517.
- charging current (formula), 517.
- choice of initial voltage, 531.
- conductors, 539.
- conductors, loss in, 475.
- construction used on Missouri River Power Co., 559.
- continuous insulation of, 501.
- cost formula, 510.
- energy losses in (curves), 496.
- entrance into buildings, 575. (erected), cost of, 651.
- formula for self-induction in, 511
- formula for weight of wire required, 509.
- grounded wires for lightning protection, 574.
- impedance factor, 511.
- inductance in, 506.
- insulation, 490.
- insulators. (*See Insulators.*)
- its general relation to the plant, 474.
- junctions between cables and overhead lines, 577.
- lightning arresters on, 574.
- lightning stroke, 569.
- long, cost of maintenance, 688.
- long spans, 698.
- loss of current to earth, 491.
- maximum loss in, 534.
- mil-foot constant, 509.
- overhead, 505.
- pins. (*See Pins.*)
- poles. (*See Poles.*)
- provision for repairs, 578.
- river-crossings, 550.
- skin effect, 515.
- static disturbances, 530.
- steel towers, 547.
- surging, 528.
- telephone, 578.

- Line, continued.**
 three-phase, formula for weight of wire, 510.
 tower construction, 562.
 tower, total cost of, 563.
 towers, cost of, 563.
 voltages, 499.
 wave form, 127.
 way of treating inductance, 511.
 wire, 539.
 choice of deflections, 546.
 copper, mechanical constants of, 539.
 deflection due to temperature, 542.
 factor of safety, 544.
 ice loaded, 543.
 maximum deflection of, 541.
 maximum length of span, 544.
 relation between deflection, tension, and length of span, 546.
 wind-pressure on, 543.
 wires, transposition of, 558.
- Lines, duplicate, 485.**
 general character of, 483.
- Load governors, 374.**
 lines (curves), 347.
 synchronous motor, disturbing effect of, 171.
- Lombard governor, 376.**
- Loop test, 685.**
- Los Angeles Co., system, 695.**
- Magnet, solenoid, 12.**
- Magnetic field, 11.**
- Market, estimate of, 639.**
- McCormick turbine, 356.**
- Measurements, electrical, 660.**
- Mechanical drive, efficiency of, 65.**
- Mercury rectifier in arclighting, 597.**
 vapor converter, 304.
- Mershon's tests, 497.**
- Mesh connections, 185, 209.**
- Metals, relative properties of, 486.**
- Meters, chemical, 682.**
 reading of, 681.
 testing of, 680.
- Microfarad, definition of, 144.**
- Miner's inch, definition of, 391.**
- Monocyclic system, 188.**
- Motor:**
 generator, 103, 288.
 advantage of, 289.
 d. c. loss in, 117.
 disadvantages of, 290.
 efficiency of, 290, 302.
 efficiency of large sizes, 292.
 synchronous, operation of, 221.
 in transmission, 221.
 maximum power factor, 225.
 output, input, etc., of, 223.
 principles of, 217.
 vector diagram of, 224.
- water, 44.**
 hydraulic efficiency of, 44.
 impulse, 45.
 oscillating, 44.
- Motors:**
 electric,
 a. c., 217.
 arranged for wide speed range, 100.
 classification of operating conditions, 89.
 commutating a. c. (*See Series a. c.*)
 commutator. (*See Commutator.*)
 compared with mechanical drive, 66.
 constant speed series, 95.
 cost of — installed ready to run, 644.
 current taken by, 87.
 differential shunt motor, 99.
 drive, choice of, 62.
 effect of synchronous — on wave form, 171.
 efficiency of, 59.
 efficiency of system, 63.

- Motors, *continued.***
 efficiency for different sizes
 (table), 62. [load, 63.
 efficiency, variation of, with
 field. (*See* Field.)
 fundamental principle, 237.
 high voltage, d. c., 109.
 induction. (*See* Induction
 Motor.)
 installation of — for constant
 current systems, 107.
 interpolate, 121.
 performance of, 87.
 principle of, 14, 17.
 pull on armature conductors,
 86.
 self-regulating series, 94.
 series a. c. (*See* series, Motor.)
 series driven by series dynamo,
 95.
 series for constant potential,
 91.
 series-wound constant current,
 89.
 shunt-wound constant poten-
 tial, 96.
 single-phase (*See* Single-phase
 Motors.)
 synchronous. (*See* Synchron-
 ous Motor.)
 torque at armature surface, 86.
 voltage of, 113.
 with one meter, 679.
 working of, 86.
 wave, 31.
- Needle-valve for water-wheels, 363.**
Nernst lamps, 597.
- Ohm, definition of, 21.**
Ohm's law, 475.
Oil fuel, 334.
Overload circuit-breaker, 463.
- Pacinotti constant current plant,
 106.**
- Parallel, operation, switching re-
 quirements for, 461.**
- Paralleling of alternators, 443.**
Pelton wheel, 44, 352.
 governing of, 384.
Pendulum, oscillation of, 155.
Periodicity. (*See* Frequency.)
Permutator, 309.
Petroleum as fuel, 24.
Phase displacement, 131.
 lamps, 443.
Pilot wires, 457.
Pins, 556.
 burning of, 560.
 composite, 561.
 metal, 561.
 treated, 561.
- Pipe line:**
 concrete, 697.
 cost of, 418.
 lines, construction of, 406.
 loss of head in, 397.
 steel hydraulic, properties of
 (table), 408.
- Plant, location of, 23.**
Plants, in parallel, 461.
**Pneumatic transmission. (*See*
 Transmission.)**
- Pole-head, used on Niagara-Buffalo
 line, 558.**
 line, life of, 574.
 cost of, 652.
- Poles, 551.**
 at angles, 554.
 bending moment of, 553.
 classification of, stresses on, 553.
 creosoting of, 552.
 cross-arms, 552.
 crushing resistance of, 553.
 general dimensions of, 551.
 guying of, 554.
 number per mile, 553.
 stresses from sleet-storms, 556.
 wind-pressure on, 555.
 wood for, 551.
- Pollak commutator, 284.**
Porcelain vs. glass, 492.
Potential energy, 2.
 transformer, 665.

Power:

- centralization of, 33.
- cost at customer's meter, 647.
- cost at switchboard, 647.
- cost of, when developed by various types of steam-engines, 640.
- cost of, when developed by divers engines, 643.
- cost of per k.w. for different capacities, 646.
- definition of, 35.
- determination of price of, 654.
- estimate of cost of, 639.
- estimate of market for, 416.
- factor, 149.
 - definition of, 139.
 - increase of, with condenser, 152.
 - indicator, 471.
- plant, choice of power units, 426.
 - load curves, 347.
 - organization of, 418.
 - station. (*See* Power-station.)
 - transportation of materials for, 426.
 - variation of cost of fuel per k. w. throughout day, 348.
- plants, description of various, 419.
 - list of — operating at more than 20,000 volts, 702.
- station, at Folsom, Cal.
- at Fresno, Cal., 436.
- building, 425.
- design of, 418.
- foundations for, 422.
- general arrangement of typical station, 434.
- lighting-arrester system for, 574.
- location of, 418.
- location of high voltage wires, 453.
- location of generators, 424.
- number of units, choice of, 429.

Power, *continued.*

- of Truckee River, G. E. Co., 438.
- operated in parallel, 693.
- reserve apparatus, 636.
- structure, 423.
- switchboard. (*See* Switchboard.)
- traveling crane in, 454.
- steam, cost of, 415.
- steam electric, cost of, 69.
- Prime movers, classification of, 309.
 - gas-engines. (*See* Engines.)
 - steam-engine. (*See* Engine.)
 - steam-turbines. (*See* Turbines.)
 - water-wheels. (*See* Water-wheels.)
- Pumping, 233, 235.

Railway:

- a. c. transmission d. c. distribution efficiency of system, 111.
- motor, 91.
- Railways with three-wire system, 114.
- Rainfall observations, 394.
- Rates, determination of, 654.
- Ratio of transformation, definition of, 200.
- Reactance, negative, 145.
- Rectifiers, 280.
 - commutating, 280.
 - electrolytic, 303.
- Rectifying commutator, advantages of, 287.
 - commutators, maximum output of, 287.
- Regulation:
 - Baum's method, 197.
 - best modern practice, 692.
 - close, 302.
 - diagram, 519.
 - of alternators, 173.
 - of alternators with inductive load, 174, 177.
 - of polyphase generators, 194.

- Regulation, *continued*.
 of three-phasers, 184.
 of voltage, 456.
 of voltage on secondary lines, 630.
 of water-wheels, 370.
 preserved by use of inductance, 523.
 speed. (*See* Speed.)
- Regulator:
 Chapman type, 457.
 G. E. type, 458, 632.
 Stillwell type, 631.
- Regulators for constant current, principle of, 593.
- Relay, time limit, 464.
- Reorganizers, definition of, 280.
- Replogle governor, 382.
- Resistance:
 apparent, 134.
 increase of — by alternating current, 515.
 of copper wire, 509.
 unit of, 21.
- Resonance, 170.
 as affected by armature reaction, 168.
 dynamics of, 155.
 testing for, 168.
- River crossings, 550.
- Rivers:
 low land, 388.
 measurement of flow, 392.
 mountain, 388.
 slow, 387.
 swift, 387.
 upland, 388.
- Rope drive, cost of, 41.
 cost of plant, 70.
 cost of plant operation, 70.
 efficiency of, 38.
 idlers, use of, 38.
 losses in, 427.
 multiple sheaves, 38.
 multiple sheaves, efficiency of, 39.
 power, size of rope, diameter of pulley and speed (table), 42.
- Rope drive, *continued*.
 straightaway, 37.
 wire, 35.
 construction of rope, 36.
 efficiency of, 42.
 span, 36.
 speed of, 36.
- Rotary converter. (*See* Synchronous Converter.)
- Rotating field, 240, 244.
- Samson turbine, 354.
- Scott system of connections, 210.
- Self-induction in a circuit, 511.
- Series motor:
 a. c., 262.
 commutation sparking, 265.
 compensating winding, 264.
 efficiency and power factor of, 265.
 Westinghouse, 264.
- Shafting, losses in, 65.
- Shallenberger meter, 673.
- Sheaves, rope, construction of, 37.
- Sheefer meter, 673.
- Shell-boilers, 326.
- Shields, for damping fluctuations, 236.
- Sines, tangents, and cosines, table of, 522.
- Single-phase motors, characteristic curves, 260, 262.
 efficiency and power factor, 259.
 induction. (*See* Induction motors.)
 power factor of, 277.
 uses of, 258.
 Wagner, 259.
- Skin effect, 515.
- Slip in induction motor, 241.
- Slots in induction motors, 253.
- Solar-engines, 27.
 cost of, 28.
- Speed:
 constant — motor, 95, 97.
 of engines and dynamos, choice of, 325.
 regulation for series motors, 93.

- Speed, *continued*.
 regulation of constant-current series motors, 90.
 of induction motors, 275.
 of shunt-motor, 98.
 variable — motor, 92, 93, 98.
 wide-range, motor, 100.
- Split-phase connections, 215.
- Squirrel cage, secondary, 239.
- Stanley motor, 255.
- Star connection, voltage to neutral, 449.
 connections, 185, 209.
- Static, 530.
 electricity, 8.
 interrupter, 572.
- Steam and water-power, relative cost of, 33.
 auxiliary, 412.
 consumption of, different types of engines, 318.
 electric plant, cost of, 69.
 efficiency of, 66.
 engine. (*See Engine.*)
 gauges, recording, 670.
 plant, cost of, 651.
 power of, cost of, 415.
 superheated, use of, 322.
 turbine. (*See Turbine.*)
- Stillwell regulator, 631.
- Stokers, mechanical, 332.
- Strain insulators, novel, 549.
- Street lighting, 593.
- Strength of various metals and alloys, 486.
- Striking distances, 494.
- Substation:
 reserve apparatus in, 636.
- Surging caused by lightning, 569.
 definition and theory of, 528.
 e.m.f. of, 529.
 relation of voltage rise to current broken, 530.
- Switchboard apparatus, 455.
 equipment of panels, 469.
 location of, 451.
 purpose of, 459.
- Switchboards, 455.
- Switches:
 air-break for high voltage, 467.
 electrically operated, 464.
 for remote control, 464.
 oil-break, 462.
- Switching connections, elementary, 460.
- Synchronous converter, 293.
 action in, 297.
 and transformers, combined efficiency of, 302.
 connection of, 188.
 effects of line loss, inductance and resonance upon d. c. e.m.f., 301.
 efficiency of, 300.
 frequencies used, 300.
 in railway operations, 299.
 ratio between a. c. and d. c. e.m.f., 301.
 winding of, 297.
- motor, advantages of, 229.
 disadvantages of, 230.
 hunting or pumping of, 233.
 load, disturbing, effect of, 171.
 minimum, practical size of, 233.
 power factor of, 228.
 polyphase power factor of, 232.
 polyphase, 232.
 regulation of line by, 227.
 self-starting, 231.
 starting of, 230.
 uses of, 277.
 with solid poles, 235.
- Synchronism, definition of, 218.
 indicators, 443.
- Synchronization, automatic, 470.
- Synchronizing commutator, 281.
- Synchroscope, 469.
- Tangents, sines and cosines, table of, 522.
- Taylor hydraulic air-compressor, 55.
- Teaser, 189.

- Three-wire system, 113.
 for railways, 114.
- Thury system, 109.
- Tidal energy, 28.
 cost of utilizing, 30.
- Time, constant of, electric circuit,
 155.
- Torque:
 constant, 89.
 maximum in induction motor,
 273.
 relation between static and run-
 ning in induction motor,
 274.
- Towers, 562.
- Transmission:
 a. c. and d. c. compared, 121.
 analysis of, 68.
 comparison of commercial pos-
 sibilities of different systems,
 68, 76.
 comparison of rope and electric,
 39.
 electric, a. c. 158.
 a. c., classification, 158.
 a. c., material of, 159.
 at high voltage, present ten-
 dencies, 687.
 best system for heavy sub-
 station work, 634.
 constant current, 101.
 constant potential, 111.
 voltage control, 112.
 continuous current voltage
 control, 103.
 copper required by various
 systems, 186.
 cost of operation, 71.
 cost of plant, 71.
 d. c. system, 77.
 development of network, 689.
 delivery known power from
 limited water-power, 482.
 delivery of known power from
 ample water-power, 481.
 effect of distance and voltage
 on copper required, 476.
- Transmission, *continued.*
 efficiency of, 110.
 efficiency of, at full and half-
 load of different systems, 74.
 efficiency of system, 61, 66.
 general distribution from water-
 power, 481.
 heterophase systems, 189.
 installations, 702, 703.
 line efficiency, 61.
 line insulation. (*See Insulation.*)
 lightning protection. (*See*
Lightning.)
 longest distance, 687.
 monocyclic system, 188.
 polyphase, efficiency of, 111.
 polyphase, with rotary con-
 verter, efficiency of, 111.
 problems, 480.
 study of various cases, 481.
 synchronous motor for regu-
 lation, 228.
 the line. (*See line.*)
 voltage to be used, 477.
 vs. all other systems, 58.
 underground, 484.
 gas, 58.
 gearing bevel, efficiency, 41.
 general conditions of, 23.
 hydraulic, 42.
 allowable velocity in pipes, 46.
 efficiency of, 44, 47.
 high artificial pressure, 45.
 loss of head in pipe (table), 47.
 medium pressure, 43.
 methods, classification of, 35.
 of coal energy, efficiency of, 32.
 pneumatic, 48.
 allowable velocity, in pipes, 52.
 cost of plant, 70.
 cost of operation, 70.
 efficiency of, 54.
 loss of head in pipes (table),
 52.
 Paris system, 54.
 price of power, 54.
 process of, 50.

Transmission, continued.

- reheater, use of, 53.
 - rope. (*See* Rope Drive.)
 - straightaway, 37.
 - cost of plant, 70.
 - cost of operation, 70.
 - shafting, belting, etc., losses in, 65.
 - sphere of application of different systems, 75.
 - wire-rope, 35.
 - efficiency of, 38.
- Transformers, 198.**
- a. c. to d. c., choice of apparatus, 303.
 - air-blast, 448.
 - artificial cooling of, 204.
 - choice of, 446.
 - connection of, 208.
 - connected for split single-phase into three-phase, 215.
 - connections commonly used in practice, 450.
 - constant current, 594.
 - constant loss in, 587.
 - construction of, 199.
 - core type, 203.
 - cost of, 651.
 - current, 664.
 - data, 201.
 - determination of magnitude of units, 445.
 - duplex machine. (*See* Synchronous Converter.)
 - efficiency of, 59, 201, 205, 206, 588.
 - fire protection, 447.
 - fire risk in, 447.
 - high voltage, location of, 448.
 - inductance of, 150.
 - installation of, 451.
 - losses in, 200.
 - maximum, practicable voltage of, 687.
 - maximum, size of, self-cooled, 446.
 - motor-generator. (*See* Motor Generator.)

Transformers, continued.

- polyphase, 206.
 - principle of, 130.
 - radius of operation of, 590.
 - ratio of transformation of, 200.
 - rectifiers. (*See* Rectifiers.)
 - rotary converter. (*See* Synchronous Converter.)
 - shell type, 202.
 - star, mesh and resultant mesh connections, 209.
 - static converter. (*See* Converter.)
 - two to three-phase and *vice versa*, 210.
 - two to three-phase and *vice versa*, without special transformers, 212.
 - used as boosters, 213.
 - working of, 199.
- Turbines:**
- steam, 334.
 - actual efficiency of, 345.
 - advantages of, 344.
 - Curtis, principles of, 342.
 - De Laval, principles of, 335.
 - De Laval, steam consumption of, 336.
 - Parsons, efficiency of, 340.
 - Parsons, performance curves of, 340.
 - Parsons, principles of, 336.
 - Parsons, steam consumption of, 340.
 - water, choice of, 367.
 - for high heads, 360.
 - for low heads, 360.
 - governors for. (*See* Governors.)
 - impulse type, 351.
 - impulse type, efficiency of, 366.
 - impulse type, maximum efficiency of, 361.
 - installation of, 357.
 - McCormick type, 356.
 - methods of regulating, 365.
 - multiplex types, 369. [of, 362.
 - Pelton and Doble, efficiency

- Turbines, *continued*.
 pressure type, 351.
 pressure type, losses in, 364.
 pressure type, efficiency of, 364.
 Samson type, 354.
 Victor type, 355.
 Turbo-generator, 342.
- Umformer, 294.
 Units, 20.
- Valve:
 needle for water-wheels, 363.
 Valves, engine, dependent type, 313.
 independent type, 312.
 Victor turbine, 355.
 Volt, definition of, 20.
 Volta, constant current plant, 106, 108.
 Voltage:
 choice of, initial, 531.
 diagram, 519.
 regulator, of, G. E. Co., 632.
 regulation for lighting and motor service, 513.
 rise at end of line containing capacity, 521.
 Voltages, striking distance at various, 494.
 Voltmeter relays, 457.
 Voltmeters, 664.
 a. c., 665.
 classification of, 387.
 connections for, 667.
 cost of, 648.
 recording, 669.
- Water-power:
 and steam, relative cost of, 33.
 canals, 405.
 creation of artificial, 699.
 dams. (*See Dams.*)
 development of, 387.
 development, maximum allowable cost of, 415.
 difficulties from ice, 409.
- Water-power, *continued*.
 distribution of, 25.
 estimate of market for, 416.
 formula for available h. p., 396.
 formula for mechanical h. p., 396.
 measurement of flow, 389.
 mountain streams, development of, 399.
 pipe line, cost of, 418.
 plant, itemized cost of, 648.
 cost of generating and transmitting power, 650.
 operating expenses of, 651.
 protection against ice, 409.
 questions involved in development of, 410.
 rainfall observations, 394.
 reconnaissance of, 389.
 settling tanks for sand, 408.
 steam auxiliary, when to install, 414.
 steel and iron pipe lines, 406.
 storage, when to provide, 410.
 storage reservoir, 397.
 utilization of, 416.
 varying head, how to deal with, 368.
 with steam auxiliary, 412.
 wooden pipe lines, 406.
- Water-tube boilers, 326.
 Water velocity, allowable, 46.
 Water-wheels, 349.
 classification of, 349.
 cost of, 651.
 drive from vertical, 430.
 governors. (*See Governors.*)
 installation of, 357.
 Leffel cascade type, 363.
 Pelton, 352.
 principles of, 350.
 regulation of, 370.
 timber flumes, 439.
 turbine. (*See Turbines.*)
- Watt, definition of, 21.
 Wattmeter:
 connection to three-phase circuit, 676.

- Wattmeter, *continued*.
for two or three-phase circuits,
678.
induction type, 673.
integrating, 671.
recording, 671.
- Wave energy, 5.
form analysis of, 169.
as affected by inductive load,
524.
as affected by synchronous
motor, 171.
device to obtain sine, 164.
in practical circuits, 527.
of three-phasers, 184.
- Wave forms, 128.
- Wave motors, 31.
- Waves, irregular forms of, 278.
- Weston, d. c. instruments, 663.
- Wiers:
coefficient formula for, 391.
formula, 390.
table, 391.
- Wind-power, windmills as prime
movers, 26.
pressure on line wire, 543.
- Winding armature. (*See* Armature
Winding.)
- Wire-rope, 36.
- Woods, tensile strength of various,
554.
- Work, unit of, 21.

UNIVERSITY OF CALIFORNIA
DEPARTMENT OF CIVIL ENGINEERING
BERKELEY, CALIFORNIA

UNIVERSITY OF CALIFORNIA
DEPARTMENT OF CIVIL ENGINEERING
BERKELEY, CALIFORNIA

788155

TK1001

B4

1907

Engineering
Library

UNIVERSITY OF CALIFORNIA LIBRARY

