

• ANNI • DOMINI • AEDIFICAVIT • DOMVM •

MODERN HOUSE  
CONSTRUCTION





THE PRINCIPLES AND PRACTICE  
OF  
MODERN HOUSE-CONSTRUCTION





THE PRINCIPLES AND PRACTICE  
OF  
MODERN HOUSE-CONSTRUCTION

INCLUDING  
WATER-SUPPLY AND FITTINGS—SANITARY FITTINGS AND  
PLUMBING—DRAINAGE AND SEWAGE-DISPOSAL—WARMING  
VENTILATION—LIGHTING—SANITARY ASPECTS OF FUR-  
NITURE AND DECORATION—CLIMATE AND SITUATION  
STABLES—SANITARY LAW, &c.

WRITTEN BY

F. W. ANDREWES, M.D., F.R.C.P., D.P.H.	PROF. ROBERT KERR, F.R.I.B.A.
A. WYNTER BLYTH, M.R.C.S., F.I.C.	HENRY LAW, M.Inst.C.E., F.San.I.
H. PERCY BOULNOIS, M.Inst.C.E., F.San.I.	F. W. LOCKWOOD, F.I.S.E.
E. A. CLAREMONT, M.I.E.E., M.I.M.E.	J. MURRAY SOMERVILLE
HENRY CLAY, R.I.Pl.	W. SPINKS, A.M.Inst.C.E., Pr.I.S.E.
E. R. DOLBY, A.M.Inst.C.E., M.I.M.E.	G. LISTER SUTCLIFFE, A.R.I.B.A., M.San.I.
WILLIAM HENMAN, F.R.I.B.A.	WILLIAM H. WELLS
H. JOSSÉ JOHNSON, M.B., D.P.H.	E. F. WILLOUGHBY, M.D., D.P.H.

KEITH D. YOUNG, F.R.I.B.A.

EDITED BY

G. LISTER SUTCLIFFE

ARCHITECT

ASSOCIATE OF THE ROYAL INSTITUTE OF BRITISH ARCHITECTS, MEMBER OF THE SANITARY INSTITUTE  
AUTHOR OF "CONCRETE: ITS NATURE AND USES", ETC.

1782

21.

ILLUSTRATED BY ABOVE 700 FIGURES IN THE TEXT, AND A SERIES OF SEPARATELY-PRINTED PLATES

DIVISIONAL-VOL II.

LONDON: BLACKIE & SON, LIMITED  
GLASGOW AND DUBLIN

*With regard to the Illustrations in Divisional-Volume II., indebtedness has to be acknowledged to Messrs. D. Anderson & Son, Ltd., Belfast; The Berkefeld Filter Co., Ltd., London; Claughton Bros., Bradley Hall, Bramley, Yorks.; J. Defries & Sons, Ltd., London; Durran's Patents Syndicate, London; Hartley & Sugden, Halifax; S. S. Hellyer, London; Jas. Keith, C.E., Arbroath; Langstaffe, Banks, and Peckover, London; The Palatine Engineering Co., Ltd., Liverpool; T. Robinson, Wardle, near Rochdale; Sharpe Bros. & Co., Ltd., Swadlincote, near Burton-on-Trent; J. Tylor & Sons, Ltd., London.*

# CONTENTS.

## DIVISIONAL-VOL. II.

### SECTION III.—WATER-SUPPLY.

By HENRY LAW, M.INST.C.E., F.SAN.I., F.R.M.S., &c.

	Page
CHAP. I.—SOURCES OF SUPPLY. Origin of supply—Pure water—Rain-water—Quantity of rain—Rain-gauging—Duration of droughts—Quantity of rain absorbed, evaporated, and discharged from the surface—Permeability of grounds—Collection of rain—Storage—Water-bearing strata—Situation of springs—Intermittent springs—Spring-water—Artesian wells—Shallow and deep wells—Reservoirs—Rivers and lakes	171
CHAP. II.—THE PHYSICAL PROPERTIES OF WATER. Weight—Standard gallon—Reduction under compression—Freedom of motion—Transmission of pressure—Hydrostatic head—Hydrostatic pressure—Centre of pressure	178
CHAP. III.—METHODS OF SUPPLY.	
1. SURFACE-WATER.—Rivers and lakes—Gauging the flow of water by means of floats and weirs—Quantity of water required—Dams for impounding water: earth and clay, concrete, masonry—Overflow-channels—Flood-discharge of streams—Outlet-pipes—Valve-chambers—Underground tanks—Strains on walls—Ventilation-pipes	181
2. WELL-WATER.—Shallow and deep wells—Concrete walls—Bore-holes—Driven-tube wells	189
CHAP. IV.—METHODS OF RAISING WATER. Hydraulic rams—Lifting-pumps—Force-pumps—Plunger-and-bucket pumps—Efficiency of pumps—Centrifugal pumps—Chain-pumps—Motive powers—Water-wheels—Wind-power—Definition of "horse-power"—Steam-engines—Turbines—Dynamos—Loss by friction, &c.	192
CHAP. V.—THE CONVEYANCE OF WATER. Gravitation and pressure—Open channels and closed pipes—Friction—Calculating the flow of water in open channels, and in pipes under pressure—Horse-power required to pump water through pipes—Materials: wrought-iron, cast-iron, steel, lead—Lead-poisoning—Preventatives of the same—Calculating the strength of cast-iron pipes—Diameter, thickness, weight, &c., of cast-iron pipes—Flanged joints—Spigot-and-socket joints—Turned and bored joints—Weight of lead in joints—Cast-iron—Flanged joints for wrought-iron and steel—Laying pipes—Air-valves—Reducing-valves—Shuice-valves—Hydrant-valves—Discharge from hydrants	198

CHAP. VI.—THE PURIFICATION OF WATER. Foreign matters in water—Examination of water—Matters in suspension and solution—Bacteria—Straining, settlement, and filtration—Sand filters—Natural filtration—The Fischer system—The Pasteur-Chamberland filter—Aëration—Effect of light on bacteria—Classification of dissolved matters in water—Water for domestic use—Hardness of water, and methods of removal—Installation for softening water at Luton Hoo—Continuous softening processes	212
--	-----

## SECTION IV.—DOMESTIC WATER-SUPPLY.

By HENRY CLAY.

### CHAP. I.—MATERIALS.

1. LEAD.—Manufacture—Physical and chemical properties—Action of water and gases on lead—Red and white lead	225
2. TIN.—Manufacture—Uses	227
3. COPPER.—Properties—Uses	228
4. ZINC.—Manufacture—Properties—Uses	228
5. ALLOYS.—Brass—Gun-metal—Plumber's solder	229

### CHAP. II.—COLD-WATER SUPPLY.

1. PIPES AND JOINTS.—Connections with iron main—Stop-cocks—Water-meters—Lead pipes—Lead pipes washed with tin—Tin-lined lead pipes—Wrought-iron pipes—Galvanized-iron pipes—Iron-encased tin pipes—Soldered joints—Copper-bit joints—Joints in lead-encased tin pipes—Pure tin pipes—Diameters and thickness of lead pipes—Course of service-pipes—Fixing pipes—Wood casings—Gutters—Protection of pipes from frost	230
2. CISTERNS.—Position—Cistern-rooms—Wood cisterns lined with lead—Galvanized wrought-iron cisterns—Wood cisterns lined with zinc—Cast-iron and wrought-iron cisterns—Enamelled-iron cisterns—Porcelain-enamelled stoneware cisterns—Fireclay salt-glazed cisterns—Slate cisterns—Constant and intermittent supplies—Harding's system of storing water—The "Kalio" self-cleansing cistern—Sizes of cisterns—Connections—Overflows—Lead safes—Wood covers	238
3. COCKS AND TAPS.—Ball-cocks—Stop-cocks—Lord Kelvin's taps—Stamped fittings	245

### CHAP. III.—HOT-WATER SUPPLY: PRINCIPLES AND FITTINGS.

1. GENERAL PRINCIPLES.—The circulation of water—Convection currents—Conduction—Model of hot-water apparatus—Rate of flow	248
2. BOILERS.—Wrought-iron—Cast-iron—Copper—Independent boilers—Tube boilers—Hand-holes—Incrustation—Setting bath-boilers—Dampers—Noises in hot-water apparatus—Mud-taps	251
3. CISTERNS AND CYLINDERS.—Feed-cisterns—Tanks—Cylinders: copper, corrugated, galvanized-iron	255

### CHAP. IV.—HOT-WATER SUPPLY: SYSTEMS.

1. THE CYLINDER-SYSTEM.—Ordinary arrangement—Apparatus with two boilers—Secondary circulations—Independent boilers—Double-cylinder apparatus, systems 1 and 2—Connections	258
2. THE TANK-SYSTEM.—Ordinary arrangement—Modified arrangement	266



	Page
CHAP. V.—BOILER-EXPLOSIONS AND CYLINDER-COLLAPSES. Causes of explosions—Stop-cocks—Frost—Safety-valves—Incrustation—Causes of cylinder-collapses—Safety-valves of various kinds—Fusible plugs—Mercury regulators	268

## SECTION V.—HOUSEHOLD FILTERS.

By H. JOSSE JOHNSON, M.B., D.P.H., &amp;c.

Dangers of filters—Organic matter in filtered water—Accepted definition of “filter”—Filtration in nature—Proper definition—History of filters— <i>The Lancet</i> Sanitary Commission of 1867—Micro-organisms—“Mechanical” and “organic” passage of germs through filters—German tests of various filters in 1886—No filter permanently germ-proof—The workable usefulness of filters; (1) rate of delivery, (2) simplicity of construction, (3) cost—Investigations by Drs. Woodhead and Wood in 1894; carbon, iron, asbestos, prepared porcelain and other clays, natural porous stone, compressed siliceous and diatomaceous earths—Comparison of Pasteur (Chamberland), Berkefeld, and other “pressure” filters—Summary of tests and results—Six trustworthy filters compared—Most useful form for household use—Amount of water yielded by various filters—How to purify a filter—Drs. Woodhead and Wood’s conclusions—Position of non-pressure filters—Comparison of boiling and filtration—Removal of suspended matter, &c.—Summary	279
---	-----

## SECTION VI.—SANITARY PLUMBING.

By HENRY CLAY.

CHAP. I.—INTRODUCTORY. Definition of “sanitary plumbing”—Importance of the education of plumbers—The City and Guilds of London Institute—Registration of plumbers—Chief points in sanitary plumbing	301
CHAP. II.—TRAPS AND WASTE-PIPES FOR BATHS, LAVATORIES, AND SINKS. Object of traps—Characteristics of a good trap—Mid-feather trap—D-trap—Mansion-trap—Anti-D trap—Round-pipe traps—Bell-traps—Mechanical traps—Syphonage and momentum—Depth of seal—The unsealing of traps—Ventilation of traps—Waste-pipes—Materials for traps—Trap-screws—Connections of traps with stone and lead-lined sinks, lavatories, and baths—Diameter and weight of waste-pipes—Bends in drawn-lead pipes—Fixing lead waste-pipes—Concentration of plumber’s work—Lining wood sinks with lead and copper—Copper sinks	303
CHAP. III.—SLOP-SINKS. General remarks—Waste-pipes—Traps and trap-ventilation—Water-supply	318
CHAP. IV.—WATER-CLOSETS.	
1. WASH-OUT AND WASH-DOWN CLOSETS.—Setting the basins—Height of cisterns—Flush-pipes—Water-supply—Flushing-rims, &c.—Wash-down basins with lead traps	320
2. VALVE-CLOSETS.—Fixing the basins, &c.—Flush-pipes and cisterns—Traps and trap-ventilation	323
3. SYPHONIC CLOSETS.—Compared with other closets—Fixing—Various kinds	325

CHAP. V.—SOIL-PIPES AND THEIR CONNECTIONS. The position of soil-pipes— Sizes of soil-pipes—Ventilation-pipes—Soil-pipe terminals—Disconnection of soil- pipes from drains—Materials for soil-pipes: earthenware and stoneware, cast-iron, glass-enamelled cast-iron—Bends and junctions in iron pipes—Joints—Advantages and disadvantages of iron pipes—Testing a stack of soil-pipes—Lead hand-made seamed pipes—Solid drawn-lead pipes—How to make lead bends, offsets, junctions, and underhand and upright joints—Flange and block joints—Fixing lead soil-pipes —Weight and thickness of lead soil-pipes—Effect of hot water, urine, and the sun on lead soil-pipes—Protection of external lead soil-pipes—Advantages of lead - -	328
CHAP. VI.—CONNECTION OF WATER-CLOSETS WITH DRAINS AND SOIL- PIPES. Earthenware to earthenware—Earthenware to lead (4 methods)—Screwed connections—Quirk, Sharp, & Co.'s and Robinson's joints—Metallo-keramic joint— Earthenware to iron—Lead to lead—Lead to iron—Lead to earthenware—Iron to iron—Iron to lead - - - - -	344
CHAP. VII.—WATER-CLOSET TRAPS AND THEIR VENTILATION. Lead traps— D-traps—Hand-made round-pipe traps—Cast-lead round-pipe traps—Anti-D traps —Dubois round-pipe traps—Thickness of lead—Ventilation of W.C. traps, in tiers and ranges—Diameter and weight of trap-ventilating pipes—Connection of wastes from various fittings - - - - -	349

# ILLUSTRATIONS.

## DIVISIONAL-VOL. II.

	Page
Plate VI. RAINFALL MAP OF THE BRITISH ISLES - - - - -	- 171
„ VII. WATER-SOFTENING APPARATUS AT LUTON HOO - - - - -	- 221
„ VIII. DIAGRAM OF HOT-WATER CIRCULATION—Cylinder System - - - - -	- 249
„ IX. HOT-WATER APPARATUS WITH TWO BOILERS—Cylinder System - - - - -	- 259
„ X. SOIL-PIPE AND TRAP-VENTILATING PIPES FOR A TIER OF THREE CLOSETS - - - - -	- 351

### LIST OF ILLUSTRATIONS IN TEXT.

<i>SECTION III.</i>		Fig.	Page
Fig.	Page	119.—Section of Improved Double-acting Force-	
98.—Section of Valley and Water-connecting Basin - - - - -	176	pump - - - - -	195
99.—Section of Strata showing a Fault - - - - -	176	120.—Flanged Joint in Cast-iron Pipes	204
100.— „ showing Formation of Intermittent Spring - - - - -	177	121.—Spigot-and-socket „ „ „	205
101.—Section showing Artesian Well - - - - -	177	122.—Turned-and-bored „ „ „	206
102.—Diagram of Water-pressure - - - - -	180	123.—Flanged Joint for Wrought-iron and Steel Pipes - - - - -	208
103.— „ „ „ - - - - -	180	124.—Air-valve for Water-pipes - - - - -	209
104.—Float for Measuring the Velocity of a Stream below the Surface - - - - -	182	125.—Section through Equilibrium Reducing-valve - - - - -	210
105.—Transverse Section of Concrete Dam - - - - -	185	126.—Sections through Simple Reducing-valve - - - - -	210
106.—Section of Rubble Dam, Vyrnwy Reservoir	186	127.—Section through Sluice-valve - - - - -	210
107.—Vertical Section of Valve-chamber - - - - -	187	128.— „ Hydrant-valve - - - - -	211
108.—Horizontal Section of Valve-chamber on line EE - - - - -	187	129.— „ Hose-nozzle - - - - -	211
109.—Vertical Section of Underground Concrete Tank - - - - -	189	130.—Curve of Jet from Inclined Nozzle - - - - -	212
110.—Plan and Section of Well constructed of Concrete - - - - -	190	131.—Section of Sand Filter and Outlet-chamber - - - - -	214
111.—Vertical Section of Well constructed of Concrete and Iron Cylinders - - - - -	191	<i>SECTION IV.</i>	
112.—Section of Hydraulic Ram - - - - -	192	132.—Connection of Lead Service-pipe with Iron Main - - - - -	230
113.— „ Lifting-pump - - - - -	193	133.—Connection of Tin-lined Lead Pipe with Iron Main - - - - -	230
114.— „ Lifting-pump with high Delivery-pipe - - - - -	193	134.—Stop-cock and Box - - - - -	231
115.—Section of Force-pump - - - - -	193	135.—Iron Tee lined with Tin - - - - -	233
116.— „ Force-pump with Plunger - - - - -	193	136.—Patent Vented Socket or Coupling for Tin-lined Iron Pipe - - - - -	233
117.— „ Plunger-and-bucket Pump - - - - -	194	137.—Underhand Wiped Joint - - - - -	233
118.— „ Double-acting Force-pump with Solid Piston - - - - -	194	138.—A “Stumpy” „ - - - - -	233
		139.—A “Long” „ - - - - -	233

Fig.	Page
140.—Equal-branch Wiped Joint - - -	233
141.—Side-branch " - - -	234
142.—Bib-tap " Wiped " to a Lead Pipe - - -	234
143.—Joint to Elbow Boss-plate - - -	234
144.—" " Plain Boss - - -	234
145.—Copper-bit Joint - - -	234
146.—Two Methods of Joining Lead-encased Tin Pipes - - -	236
147.—Pipes wrapped with Hair-felt - - -	238
148.—Harding's closed Water-cistern - - -	242
149.—Durrans's " Kalio " Self-cleansing Cistern	243
150.—Globular Ball-cock - - -	245
151.—Side-screw Ball-cock, with Stuffing-box and Loose Valve - - -	245
152.—Round-way Stop-cock - - -	245
153.—" " " for Lead Pipes - - -	246
154.—Gland " " " - - -	246
155.—High-pressure " " " - - -	246
156.—Section through Lord Kelvin's Patent Bib-tap - - -	246
157.—Lord Kelvin's Bib-tap for Filters - - -	247
158.—Lord Kelvin's Patent Pillar-cocks for Lavatories - - -	247
159.—Lord Kelvin's Rapid-opening Tap - - -	247
160.—Wrought-welded Iron Boiler for Open Range - - -	251
161.—Wrought-welded Iron Boiler with Arched Flue, for Open Range - - -	251
162.—Wrought-welded Iron Boiler for Closed Range - - -	251
163.—Wrought-welded Iron Boot Boilers for Close Ranges - - -	252
164.—Copper Boot Boiler - - -	252
165.—" Palatine " Independent Boiler - - -	252
166.—Coiled-pipe Boiler - - -	253
167.—Ordinary Hot-water Apparatus—Cylinder-system - - -	258
168.—Hot-water Apparatus, with Independent Boiler and Horizontal Cylinder - - -	261
169.—Hot-water Apparatus, with Independent Boiler and Vertical Cylinder - - -	262
170.—Double-cylinder Hot-water Apparatus: System 1 - - -	263
171.—Double-cylinder Hot-water Apparatus: System 2 - - -	265
172.—Hot-water Apparatus: Tank-system - - -	266
173.—" " " Hot-cistern Circulation-system - - -	267
174.—Boiler, with Pipes Frozen - - -	269
175.—" Octopus " for collecting Deposits in Boilers - - -	270
176.—Hot-water Apparatus: Cylinder-system - - -	271
177.—View of a Collapsed Cylinder - - -	273
178.—Lever Safety-valve - - -	273
179.—Spring " " - - -	273
180.—Dead-weight Safety-valve - - -	274

Fig.	Page
181.—Spring Safety-valves, with and without Liquid Seal - - -	274
182.—Mercury Regulator for Hot-water Apparatus - - -	275

SECTION V.

183.—Berkefeld Single-tube Filter - - -	293
184.—" " Filter, with Seven Tubes - - -	294
185.—Single-tube Pasteur (Chamberland) Filter	295
186.—Pasteur (Chamberland) Filter, with Stone-ware Reservoir - - -	295
187.—Simple Apparatus for Softening Water - - -	296

SECTION VI.

188.—Section of Mid-feather Trap - - -	303
189.—" " Old D-trap - - -	304
190.—View of Improved D-trap - - -	304
191.—Section of Mansion-trap - - -	304
192.—View of Medium-size Anti-D Trap - - -	305
193.—Section of Large-size " - - -	305
194.—View of 1½-in. Anti-D Trap, with Enlarged Mouth - - -	305
195.—Section of Dubois Drawn-lead S-trap - - -	305
196.—" " " P-trap - - -	305
197.—Round-pipe W.C. Trap, with Square Dip and Enlarged Inlet - - -	306
198.—Section of Bell-trap for Sink - - -	306
199.—" " Bower Trap - - -	306
200.—Sections of Traps to illustrate Syphonage	309
201.—Waste-pipe and Air-pipe to Sink - - -	310
202.—Tier of Fittings on one Main Waste-pipe, with all the Traps Ventilated - - -	311
203.—Connection of Stone Sink and Trap - - -	313
204.—Connection of Lead-lined Sink and Trap (grating outlet) - - -	313
205.—Connection of Lead-lined Sink and Trap (sunk-plug outlet) - - -	313
206.—Connection of Lavatory Basin and Trap - - -	314
207.—Connection to Lavatory Basin with Brass Union - - -	314
208.—Waste-pipe secured by Lead Clip - - -	316
209.—" " " Single Lead Tacks	316
210.—Waste or Soil Pipe secured by Double Lead Tacks - - -	316
211.—Lead for Small Sink, ready for folding or putting in position - - -	317
212.—Finished Angle of Lead-lined Sink - - -	318
213.—Lead for Large Sink - - -	318
214.—Waste-pipe from Slop-hopper - - -	319
215.—Bad Form of Joint between Syphon-cistern and Flush-pipe - - -	322
216.—Overbent Flush-pipe - - -	322
217.—Flush-pipe properly Bent - - -	322
218.—Lead Trap for Valve-closet, with connection to Soil-pipe, &c. - - -	324

Fig.	Page	Fig.	Page
219.—View of Holt's Syphonic Closet and Cistern - - - - -	326	239.—Connection of Earthenware Trap to Earthenware Drain - - - - -	344
220.—Section through Holt's Syphonic Closet and "Sanspareil" Cistern - - - - -	327	240.—Connection of Earthenware Trap to Lead Soil-pipe by Socketed Joint - - - - -	345
221.—Cast-iron Bend with Foot-rest, and Connection with Lead Soil-pipe - - - - -	333	241.—Connection of Earthenware Trap to Lead Soil-pipe by Socketed and Flanged Joint - - - - -	345
222.—Joints of Iron Soil-pipes - - - - -	334	242.—Improved Socketed Joint - - - - -	345
223.—Wood Pipe-straightener - - - - -	336	243.—Socketed and Flanged Joint with India-rubber Ring, &c. - - - - -	345
224.—Wood Dummies for Pipe-bending - - - - -	336	244.—Freeman's "Grip" Joint - - - - -	346
225.—Bending drawn-lead Pipe, 1st stage - - - - -	337	245.—Quirk, Sharp, & Co.'s Joint - - - - -	346
226.—" " 2nd stage - - - - -	337	246.—Robinson's "Adaptable" Joint - - - - -	347
227.—" " 3rd stage - - - - -	338	247.—Robinson's "Enable" Connecting Collar for joining Lead and Iron Pipes - - - - -	348
228.—Making an Offset, or Ogee Bend, on Drawn-lead Pipe - - - - -	338	248.—Flanged Joint between Lead Soil-pipe and Earthenware Drain - - - - -	348
229.—Wiped Branch Joint - - - - -	339	249.—Robinson's "Enable" Connection between Lead Soil-pipe and Earthenware Drain - - - - -	348
230.—" " of Quicker Pitch - - - - -	339	250.—Lead D-trap, with 4-inch Cleaning Cap and Screw - - - - -	349
231.—" Underhand Joint: pipes ready for joining - - - - -	340	251.—Hand-made Round-pipe P-trap - - - - -	350
232.—Wiped Underhand Joint Complete - - - - -	340	252.—Cast-lead P-trap with too easy Outgo - - - - -	350
233.—" Upright Joint - - - - -	340	253.—" " "Anti-D" Trap - - - - -	350
234.—Flange Joint - - - - -	341	254.—Dubois Drawn-lead Round-pipe Trap, with Claughton's Cast Base and Socket - - - - -	351
235.—Block " - - - - -	341	255.—Soil-pipe and Trap-ventilating Pipes for one or more Ranges of Three Closets - - - - -	352
236.—Claughton's Cast-lead Double-banded Pipe-clip - - - - -	341		
237.—Claughton's Single Cast-lead Stay - - - - -	342		
238.—Pipe-stay with Lip Joint and Cast Astragals and Lugs - - - - -	342		



SECTION III  
WATER-SUPPLY

BY

HENRY LAW

MEMBER OF THE INSTITUTION OF CIVIL ENGINEERS

FELLOW AND MEMBER OF COUNCIL OF THE SANITARY INSTITUTE, FELLOW OF THE ROYAL METEOROLOGICAL SOCIETY

AUTHOR OF "CIVIL ENGINEERING", "MEMOIR OF THE THAMES TUNNEL", ETC.

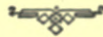









## SECTION III.—WATER-SUPPLY.

---

### CHAPTER I.

#### SOURCES OF SUPPLY.

It is obvious that, from whatever source a supply of water is obtained, **the origin of the supply** must be the rainfall. The various forms in which it appears, may be classified as follows:—1, Rain-water; 2, Surface-water; 3, Lake-water; 4, River-water; 5, Spring-water; 6, Shallow-well water, or subsoil water; 7, Deep-well water.

**Pure water** can only be obtained by distillation, and is colourless when in small quantity, but in bulk is of a blue tint; it is transparent, insipid, and inodorous.

The nearest approach to pure water in nature is good **rain-water**; but owing to the great solvent and absorbent power of pure water, it readily dissolves or absorbs the various solids and gases with which it comes in contact; and consequently rain-water contains various foreign matters which are always present in the atmosphere, the chief of which are atmospheric air and carbonic acid gas. Rain-water is purest in country districts, but in the neighbourhood of towns it becomes contaminated with soot, carburetted and sulphuretted hydrogen, ammonia, and many other matters.

**The quantity of rain** which falls in different districts varies greatly, according to their geographical position, their altitude above the sea, their distance from the sea, the conformation of the ground, the direction of the prevailing winds, the temperature, and other circumstances. Plate VI. shows the average annual rainfall throughout the British Isles. For further information upon this subject, the reader is referred to Symons's *British Rainfall*, which is published annually, and gives the amount of the rainfall at upwards of 3000 places in the United Kingdom.

The fall of rain is very unequally distributed throughout the year, as will be seen from Table VII., which gives the average monthly fall at Greenwich for

the ten years from 1886 to 1895. The figures in the Table are the mean results obtained from three gauges fixed at the Royal Observatory, the top of the gauges being five inches above the surface of the ground, and 155 feet above Ordnance Datum, that is to say, above the mean level of the sea.

TABLE VII.

AVERAGE MONTHLY RAINFALL AT GREENWICH OBSERVATORY, 1886-1895.

Year.	Jan.	Feb.	Mar.	April.	May.	June.	July.	Aug.	Sept.	Oct.	Nov.	Dec.	Whole year.
	inches.	inches.	inches.	inches.	inches.	inches.	inches.	inches.	inches.	inches.	inches.	inches.	inches.
1886	3·704	0·574	1·097	1·258	4·235	0·433	2·467	1·113	1·240	1·411	3·067	3·621	24·220
1887	1·184	0·531	1·361	1·760	1·710	1·233	1·268	2·331	2·214	1·038	3·816	1·492	19·938
1888	0·906	0·890	2·787	1·503	0·659	3·290	6·647	3·725	0·716	1·303	4·043	0·914	27·383
1889	0·889	2·224	1·326	1·873	3·296	2·061	2·050	1·816	1·691	3·951	0·799	1·458	23·434
1890	2·129	1·065	1·979	1·783	1·343	2·531	4·468	2·521	0·651	1·187	1·499	0·789	21·945
1891	1·572	0·056	2·120	0·723	2·707	0·963	3·373	3·670	0·819	4·326	2·045	2·674	25·048
1892	0·396	1·664	1·096	1·426	1·651	2·243	1·551	3·059	2·026	3·915	2·264	1·177	22·468
1893	1·478	2·754	0·435	0·120	0·529	0·818	3·349	1·244	1·288	4·180	1·836	2·199	20·230
1894	3·097	1·611	0·736	1·442	1·524	2·045	3·257	3·026	1·262	4·009	3·021	1·961	26·991
1895	1·615	0·237	1·434	1·234	0·456	0·211	3·375	2·147	0·940	2·715	2·894	2·466	19·724
Mean,	1·697	1·161	1·437	1·312	1·811	1·583	3·181	2·465	1·285	2·803	2·528	1·875	23·138

The quantity of water collected in a rain-gauge decreases as the height of the gauge above the ground increases, as is shown by Table VIII., which gives the results of the observations taken at the Observatory at Greenwich for the ten years from 1886 to 1895, with gauges varying in height above the ground from 5 inches to 50 feet.

TABLE VIII.

AMOUNT OF RAINFALL AT GREENWICH OBSERVATORY AT DIFFERENT HEIGHTS ABOVE THE GROUND.

YEAR.	HEIGHT OF GAUGE ABOVE GROUND.				
	5 inches.	10 ft. 0 in.	21 ft. 6 in.	38 ft. 4 in.	50 ft. 0 in.
	inches.	inches.	inches.	inches.	inches.
1886	24·220	23·403	21·342	18·793	14·725
1887	19·938	19·708	18·646	15·651	12·223
1888	27·383	27·374	25·826	22·972	19·104
1889	23·434	23·385	21·726	19·018	15·295
1890	21·945	21·555	20·037	17·538	13·339
1891	25·048	24·540	22·585	20·001	15·112
1892	22·468	22·352	20·839	18·115	13·617
1893	20·230	20·006	18·746	16·105	12·953
1894	26·991	26·435	24·860	22·488	18·328
1895	19·724	19·220	17·712	15·938	13·066
Mean,	23·138	22·798	21·232	18·662	14·776

Although the rainfall at any given place decreases, as the height above the ground at which it is collected increases, yet in any given district the quantity is found to increase as the height of the ground above the sea-level increases; thus, in the year 1895, the rainfall at Cardiff (which is 38 feet above the sea) amounted to 35·04 inches; at Pontypridd (which is 300 feet above the sea), 52·52 inches; and at Treherbert (which is 670 feet above the sea), 70·34 inches.

One very important matter as regards water-supply is **the duration of droughts**. Mr. Symons has prepared tables (published in *British Rainfall* for 1895), which show the frequency and duration of droughts at fifty stations equally spread over the British Isles, for the eight years from 1888 to 1895. He defines as an *absolute drought*, one which has lasted for 14 consecutive days absolutely without measurable rain; and as a *partial drought*, one that has lasted 28 consecutive days, the aggregate rainfall of which has not exceeded 0·01 inch per diem. In the spring of 1893, there was an unusually severe drought, especially on the south coast of England; the longest period of *absolute drought* was 73 days in London, and the longest period of *partial drought* was 128 days at Romford in Essex.

The water which falls in the form of **rain is disposed of in three different ways:—**

- (a) Absorbed by the surface on which it falls.
- (b) Evaporated.
- (c) Discharged from the surface on which it falls, into reservoirs, tanks, ponds, rivers, and streams.

*The quantity absorbed* depends on the temperature, the nature of the surface on which it falls and of the underlying ground, and the previous amount of rainfall. *The quantity evaporated* depends on the temperature, the moisture of the air, the nature of the surface and whether bare, cultivated, or planted with trees. *The quantity discharged* depends on the temperature, the moisture of the air, and on the smoothness, inclination, and the more or less absorbent nature of the surface upon which it falls. As a rough-and-ready calculation, it is estimated that a third of the rainfall is absorbed, a third evaporated, and a third discharged from the surface upon which it falls; but these proportions vary very greatly according to the special circumstances stated above.

In *British Rainfall* for 1895 will be found in detail the results of the observations made by Messrs. John Dickinson & Co. at the Apsley Mills, Hemel Hempstead, for the 12 years from 1884 to 1895, of the relative proportions of the rainfall which percolated through 3 feet 3 inches of sand, of chalk, and of

TABLE IX.  
PERCOLATION AND EVAPORATION OF RAIN-WATER.

	Total Rainfall.			Percolation through 3 feet 3 inches of						Loss and Evaporation.					
				Sand.		Chalk.		Earth.		Sand.		Chalk.		Earth.	
	inches.	per cent.	per cent.	inches.	per cent.	inches.	per cent.	inches.	per cent.	inches.	per cent.	inches.	per cent.	inches.	per cent.
Average of 12 years, 1884-95.....	26.20	16.71	63.78	12.23	46.68	13.07	49.89	9.49	36.22	13.97	53.32	13.13	50.11	13.13	50.11
Driest year, 1890.....	20.60	8.44	40.97	5.86	28.44	5.42	25.73	12.16	59.03	14.74	71.56	15.18	74.27	15.18	74.27
Wettest year, 1891.....	31.75	21.99	69.26	19.55	61.57	19.30	61.10	9.76	30.74	12.20	38.43	12.25	38.90	12.25	38.90

earth, and of that which was lost by evaporation. Table IX. gives the mean results for the twelve years, and also for the driest and wettest years. These results will only apply to level ground; where the ground is inclined, a certain proportion of that, which would have percolated, will be discharged from the surface.

The relative permeability of different descriptions of ground may be stated as follows, in the order of their permeability, namely:—Sand, gravel, marl, chalk, clay, rocks, gault.

The amount of rain collected from a roof will depend in a great measure on the material with which the roof is covered; if with lead, zinc, copper, or galvanized iron, or Doulton's glazed stoneware tiles, nearly the whole of the rain will run off. With ordinary tiles from 3 to 20 per cent will be absorbed or evaporated, and with slates from 1 to 5 per cent; the amount in each case depending upon the heaviness of the rainfall, the temperature of the air, and the inclination of the roof. The first rain which falls upon a roof, washes off all the dust, soot, dead leaves, &c., which have accumulated since the previous rain, and is not fit to be received into a storage tank without passing first through a filter. It is, however, very difficult to construct a filter which shall satisfactorily deal with rain-water; and a "rain-water separator" has been contrived by Mr. Roberts of Haslemere, which allows a regulated quantity of rain to run off to waste, and when this has passed, the rest is automatically turned into the tank to be stored for use.

A rain-water tank, intended to store the whole of the available rainfall, should contain at least 1 gallon for every square foot of the surface of ground covered by the roof, and for every 8 inches of annual rainfall; that is to say, in a

district with an annual rainfall of 32 inches, a storage-capacity of 4 gallons should be provided for every square foot of roof-area.

**The crust of the earth** consists of a series of strata (varying from loose sand to the hardest and most compact rock), which, for our purpose, may be divided into those which are *pervious*, and those which are *impervious* to the passage of water. If the whole of these strata existed at any one spot and of their greatest thickness, they would form a succession of parallel beds of an aggregate depth of between 5 and 6 miles. In nature, however, owing to the action of heat, water, volcanoes, earthquakes, and other causes, this crust has been broken up and disturbed in such a manner that the strata have generally become inclined, causing many of the lower beds to appear upon the surface, changing the original level surface into a succession of hills and valleys, and in many cases obliterating altogether some of the beds.

Considered with regard to the question of water-supply, this condition of the strata composing the earth's crust is of the greatest importance; for the porous strata thus brought to the surface absorb the rain falling upon them, and thus become subterranean reservoirs charged with water, which is retained in them by impervious beds of clay and other argillaceous strata, upon which they rest; the further progress of the water being thus arrested, it collects in the porous strata, until it rises to the lowest point round the margin of the impervious stratum, at which point it escapes in the form of a spring. When the impervious stratum is in the form of a basin, as is very frequently the case, a permanent natural reservoir is formed, from which the water may be lifted to the surface by pumps or other mechanical means.

**The surface of the water in a porous stratum** is seldom horizontal, for it will always decline towards any point at which it can escape by gravity, or from which it is being withdrawn by pumping, or other similar means. The inclination of the water towards this point depends upon the more or less porous nature of the stratum, and upon the rate at which it escapes, or is withdrawn.

**The size of the collecting basin** does not depend upon the area of the valley or basin visible on the surface, but on that of the basin formed by the impervious stratum below, by which the water is finally arrested. Thus in fig. 98, the surface-valley only extends from A to B, whereas the water-collecting basin extends from C to D, being that formed by the gault underlying the chalk and upper greensand, both of which are water-bearing strata.

**The localities in which springs should be sought** are wherever there is the outcrop of a porous stratum resting upon an impervious bed; as, for instance, at the outcrop of the chalk or upper greensand resting upon chalk-marl or gault

clay, as at c and D in fig. 98; the lower greensand resting on the Weald clay; the oolite resting on the Kimmeridge clay; the coral rag resting on the Oxford clay; and so forth.

In many cases the strata have been fissured in a plane more or less vertical,

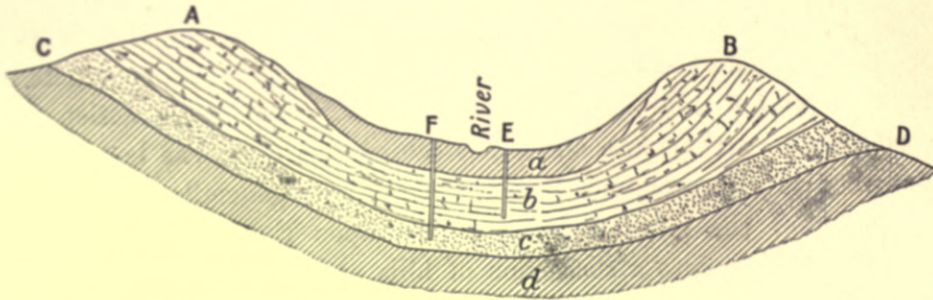

Fig. 98.—Section of Valley (A B) and Water-collecting Basin (C D).

a, London clay; b, chalk; c, upper greensand; d, gault.

and the strata on one side of the fissure have been raised or thrown up to a higher level than the corresponding strata on the other side. Such a fissure is termed a *fault*, and is frequently filled with a material impervious to water; such a case is shown at A, in fig. 99, where the chalk has been thrown up on one

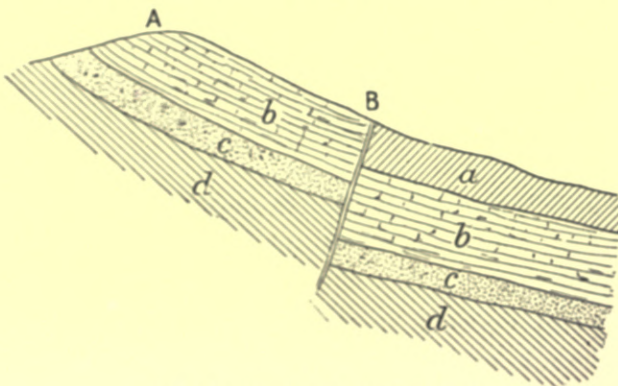

Fig. 99.—Section of Strata showing a Fault.

a, London clay; b, chalk; c, lower greensand; d, gault.

side of the fault B. The rain falling upon the chalk will accumulate until it rises to the level of the clay at B, and will there escape as a spring.

**Some springs are intermittent**—that is to say, they flow after a rainy season, but cease to do so after a spell of dry weather. The explanation of this intermittent action is sometimes as follows:—

*a* (fig. 100) is an impervious bed, upon which the porous bed, *b*, rests, cropping out from beneath a superficial bed of clay, *c*. At D, the porous bed absorbs the rain falling upon its exposed surface, and also that draining from the impervious bed above, until the water has risen to the level EE, when it overflows the raised lip F, and escapes as a spring at the lower outcrop of the pervious stratum at G, and, acting as a syphon, it continues to run, until it has drawn down the water in the hollow depression H; when this has become



exhausted it ceases to flow, and the spring remains dry until fresh rain has again filled the depression up to the level *E E*.

The purity, or otherwise, of spring-water will depend upon the distance which it has traversed, and the nature of the strata through which it has passed. Consequently, it may vary from nearly pure water, to a water containing so large a proportion of mineral matter as to be quite unfit for use for dietetic purposes.

Where the upper stratum consists of clay, or other impervious material, having a porous stratum beneath it, it will be necessary, in order to reach the water, to sink a well or make a bore-hole through the upper stratum, as at *E*, fig. 98, where the supply is derived from the chalk, or at *F*, where it penetrates to the upper greensand. And the same course will be necessary where the porous stratum reaches to the surface, but the water-level is some distance below. The level to which the water will ascend in such a well or bore-hole will depend upon the relative levels of the ground where the well is sunk, and of the lowest point at which the water from the porous stratum can escape. When

the level of the lowest point of outcrop of the porous stratum is above the surface of the ground where the well is sunk, and where the water is prevented from escaping by an impervious stratum covering the surface, the water in the well will not only rise to the surface, but will overflow, as shown in fig. 101; such a well is termed an *artesian* well.

Wells are distinguished as *shallow* wells and *deep* wells, the former term being applied to wells which derive their supply from the superficial strata, at no great depth below the surface, while the latter term is applied to wells which pass through one impervious stratum and are supplied by water which has traversed a considerable thickness of ground, and is upheld by a lower impervious stratum.

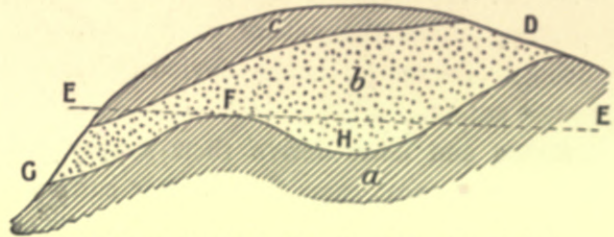

Fig. 100.—Section showing Formation of Intermittent Spring.  
a, boulder-clay; b, sand and gravel; c, clay.

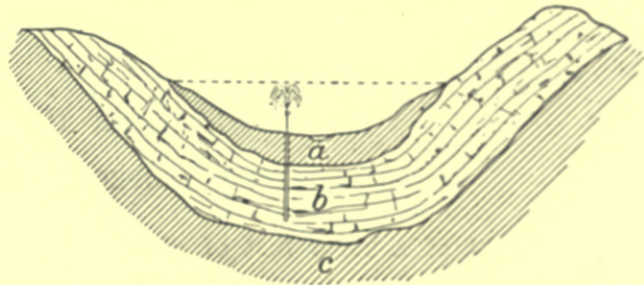

Fig. 101.—Section showing Artesian Well.—a, clay; b, chalk; c, gault.

One frequent means of supply is **impounding the rain-water** falling upon the upper part of a valley. Where the ground is of a sufficiently impervious character, and the surface is of a suitable configuration, this method may be adopted with advantage. In every case, however, where water flows over the surface of the ground, it will be more or less charged with foreign matter, depending upon the nature of the surface; cultivated lands, which receive dressings of manure, being obviously those which pollute the water to the greatest extent.

**Rivers and lakes** derive their supply almost entirely from surface-water, which has in most cases flowed over cultivated land, and although most rivers and lakes are also fed by springs which find vent in their beds, the spring-water, in its passage through the soil, will dissolve any soluble substance which this may contain, and will wash out fine particles of insoluble matter, and will thus become charged with foreign matter, both in solution and suspension.

The water from shallow wells and from rivers should always be regarded with suspicion; and, in fact, all water intended for dietetic purposes should be subjected to careful chemical analysis and bacteriological examination before being adopted for use.

---

## CHAPTER II.

### THE PHYSICAL PROPERTIES OF WATER.

The weight of a cubic foot of distilled water at the temperature of 62° Fahr., and with the barometer at 30°, has been variously estimated. The Board of Trade has fixed the standard weight at 62·2786 lbs.; Prof. Everett, however, gives it as 62·356 lbs., and this agrees with the average of several observers. Ordinary water has, however, a somewhat higher specific gravity than pure distilled water, and it is usual amongst hydraulic engineers to take the weight of a cubic foot of water as 62·5 lbs., which is sufficiently accurate for all practical purposes. The weight of water is rather more than 814 times the weight of an equal volume of air. The weight of a cubic foot of water at 62° as estimated by Prof. Everett is, as stated above, 62·356 lbs., but, as the temperature is lowered, it contracts in bulk until it has fallen to 39·2° Fahr., when the weight of a cubic foot will have increased to 62·425 lbs.; as the temperature is further lowered, the water ceases to contract, and begins to expand, until at 32°, the freezing-point, a cubic foot only weighs 62·417 lbs.

In the actual act of congealing, a sudden and still greater expansion, amounting to one-eleventh of its previous volume, takes place, so that a cubic foot of ice at a temperature of 32° only weighs 57·2 lbs. per cubic foot. It is this property of sudden expansion in the act of congealing, which frequently bursts water-pipes in times of severe frost.

A standard gallon of water weighs 10 lbs., and taking the standard weight of a cubic foot of water as fixed by the Board of Trade, there would be 6·2279 gallons in a cubic foot, and one gallon would contain 277·463 cubic inches; it is, however, usual to consider that there are 6·25 gallons in the cubic foot, and 277·123 cubic inches in a gallon.

Water is so nearly incompressible that an additional pressure of one atmosphere, or 15 lbs. per square inch, only reduces its volume '000047, or about one twenty-thousandth part. This property of water is taken advantage of in the construction of the hydraulic ram, which will be hereinafter described, by means of which the momentum of a moving body of water is utilized to raise a portion of the water to a higher level. It is also the cause of the shock occasioned by the sudden stoppage of water in motion, which under certain circumstances results in the bursting of the pipes by which it is distributed.

Water, in common with all other fluids, possesses the property of perfect freedom of motion amongst its particles, and the power of transmitting pressure freely in all directions. Consequently it conforms its shape to that of the vessel containing it, filling every portion situated below the level of its surface, and pressing against every part of the internal surface of the vessel with a force proportional to the depth of that point below the surface of the water, and in a direction perpendicular to the surface of the vessel at that point.

The height of the surface of the water in an open vessel above any given point in the same is termed the **hydrostatic head**, and the pressure produced upon an unit of surface by that head is called the **hydrostatic pressure** at that point. The weight of a cubic foot of water being 62·5 lbs:—if  $\alpha$  = the area of any given surface in square feet,  $h$  = the hydrostatic head in feet (that is, the depth of the centre of gravity of the surface below the top of the water in feet),  $p$  = the hydrostatic pressure in pounds per square foot, and  $P$  = the total amount of the pressure of the water upon the given surface in pounds, we shall have

$$p = 62\cdot5 h \dots\dots\dots(1)$$

$$\text{and } P = 62\cdot5 h a \dots\dots\dots(2)$$

Thus, in fig. 102, ABCD represents a vessel of irregular shape, filled with water to the level AB; and EF is a horizontal line which touches or intersects the internal surface of the vessel in the several points G, H, I, J, and K; then AE

will be the *hydrostatic head* at those points, and the *hydrostatic pressure* of the water at each of those points will be identical, and will act in each case perpendicularly to the surface at that point, as shown by the arrow; namely, *downwards* at G and H, *horizontally* at I, and *upwards* at J and K.

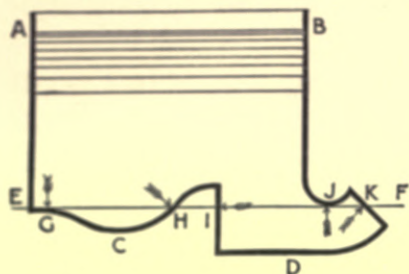

Fig. 102.—Diagram of Water-pressure.

When a surface under water is horizontal, the pressure upon it is everywhere uniform, and the total amount of that pressure over the whole surface is found by formula 2; but if the surface is vertical, or inclined, then the pressure upon any part of the surface will vary according to the depth, and the total

pressure acting in a direction perpendicular to a given surface will be equal to the weight of a column of water whose base is equal to the area of the surface, and whose height is equal to the depth of the centre of magnitude of that surface below the top surface of the water; and there is a particular point of the pressed surface, called the *centre of pressure*, at which if a pressure equal to the total pressure of the water over the whole surface be substituted for the same, and applied in a direction perpendicular to the surface, the mechanical effect will be identical. The centre of pressure of a rectangular surface, one side of which coincides with the surface of the water, is situated at two-thirds of the whole depth of the lower side of the surface. In the case of a triangular surface, if the base of the triangle coincides with the surface of the water, the centre of

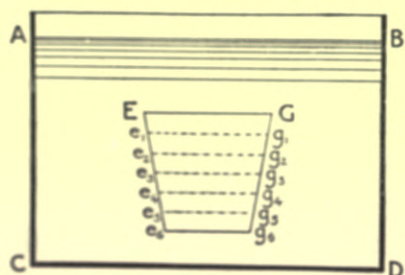

Fig. 103.—Diagram of Water-pressure.

pressure is at one-half the depth of the apex. The foregoing propositions are true whether the surfaces are vertical or inclined; in the case of a horizontal surface the centre of pressure coincides with the centre of gravity, whatever may be its form.

Let ABCD, fig. 103, be a reservoir, AB being the surface of the water, and let EG  $e_1 g_1$   $e_2 g_2$  represent a valve in the vertical side of the reservoir; let  $a$  = the area of this valve,  $\delta$  = the depth of its *centre of magnitude*, and  $d$  = the depth of the *centre of pressure* below the surface AB, and let  $P$  = the total pressure of the water upon the surface of the valve; then we have

$$P = 62.5 a \delta \dots \dots \dots (3)$$

Now, if we suppose the surface of the valve to be divided into a number of

horizontal laminæ of equal breadth, EG,  $e_1 g_1, e_2 g_2, \dots, e_5 g_5, e_6 g_6$ , and let  $\delta_1, \delta_2, \dots, \delta_6$  = the depths of the *centres of magnitude* of these laminæ below AB, and  $l_1, l_2, \dots, l_6$  = the horizontal distances of the same centres from the vertical line AC, and  $l$  = the horizontal distance of the *centre of pressure* from the same horizontal line; then we have

$$\delta = \frac{a_1 \delta_1 + a_2 \delta_2 + \dots + a_6 \delta_6}{a} \dots\dots\dots(4)$$

$$d = \frac{a_1 \delta_1^2 + a_2 \delta_2^2 + \dots + a_6 \delta_6^2}{a_1 \delta_1 + a_2 \delta_2 + \dots + a_6 \delta_6} = \frac{a_1 \delta_1^2 + a_2 \delta_2^2 + \dots + a_6 \delta_6^2}{a \delta} \dots\dots\dots(5)$$

$$\text{and } l = \frac{a_1 l_1 \delta_1 + a_2 l_2 \delta_2 + \dots + a_6 l_6 \delta_6}{a \delta} \dots\dots\dots(6)$$

If, instead of the surface of the valve being in a vertical plane, it is inclined, the foregoing formulas will apply, the distances  $\delta_1, \dots, \delta_6$  being measured along the inclined surface, from the line of intersection of the same with the surface of the water; only in formula 3 we must substitute  $\delta \sin \theta$  for  $\delta$ ;  $\theta$  being the angle which the inclined surface makes with the surface of the water. Formula 3 then becomes

$$P = 62.5 a \delta \sin \theta \dots\dots\dots(7)$$

---

### CHAPTER III.

#### METHODS OF SUPPLY.

##### 1. SURFACE-WATER.

**The simplest method of supply** is where the water is taken directly from a river or stream, or from a pond or lake. If the river or lake is at a sufficient height above the place to be supplied, it is only necessary to lay a pipe to convey the water to the place by gravitation. In taking water from a river or stream, it is desirable to take it as near the source as possible, because there is less likelihood of pollution. The water from a river or lake should always be carefully examined before being adopted as a source of supply, because it is in most cases chiefly derived from the surface-water draining off the land, which is always more or less liable to be polluted.

It is also necessary **to gauge the flow of the river or stream**, in order to ascertain whether it is sufficient to allow of the quantity required being abstracted from it without interfering with the interests of the riparian owners lower down

the stream. If the river is of considerable volume, a length of two or three hundred feet should be selected, where its course is straight, and uniform in the area of its cross-section. At the upper and lower extremities of the portion selected, ranging-rods should be set up on each side of the river, and an observer with a stop-watch should be placed at each to observe the exact moment at which a float passes each point. If then the distance in feet between the upper and lower ranging-rods be divided by the number of seconds which elapsed between the float passing the upper and lower rods, the result will give the surface-velocity of the stream in feet per second. The ratio which the surface-velocity bears to the mean velocity over the whole cross-section of the river, is so completely dependent upon varying circumstances, such as the comparative depth and width, and the direction and force of the wind, that no fixed rule can be given. In cases where an exact result is desired, the velocity should be measured at varying distances from the centre of the stream and at various depths.

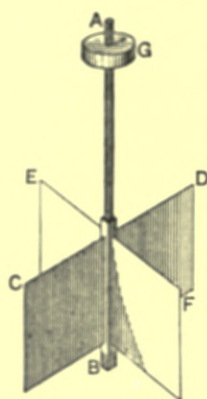

Fig. 104.—Float for Measuring the Velocity of a Stream below the Surface.

For ascertaining surface-velocities, an orange, or a potato cut in half, forms as good a float as can be used. For measuring the velocity below the surface, a very convenient form of float is shown in fig. 104. It consists of a rod of wood AB, the upper part round and the lower part square in cross-section; two saw-cuts are made at right angles in the square part, and two plates of zinc, CD and EF, each about 2 feet long and a foot in depth, are inserted in these cuts; the plates are prevented from dropping out by tying string round the bottom of the rod. The round portion of the rod is passed through a hole in the circular float G, the buoyancy of which is sufficient to cause it to float with its surface just above the water, and it is fixed at such a height as will bring the centre of the zinc plates to the depth required. With this float very accurate results can be obtained.

Another very convenient mode of measuring the velocity of a stream is by means of an electric-current meter, which consists of a two-bladed screw, fixed on a shaft, the revolutions of which are recorded above water by an electric current. The great advantage of this method is that the velocity at any moment is seen without raising the instrument, so that a great number of observations at different parts of the section, and at different depths, can be taken in a short time, and the mean velocity derived from them with great accuracy. The rate of the meter, that is to say, the number of revolutions which the screw makes in a given time for any given velocity of stream, is first determined by experiment.

Having ascertained the mean velocity of the stream, the next step is to determine the area in square feet of the cross-section, which must be done by taking soundings at equal distances, and multiplying the total width of the stream by the mean depth; the volume of water passing per second in cubic feet, is found by multiplying the mean velocity in feet per second by the transverse sectional area in square feet.

In small streams, the volume of the flow is most conveniently measured by constructing a weir for it to pass over. **An ordinary weir** consists of a horizontal sill over which the water flows, the sides being vertical. In the case of a *rectangular weir*,—that is, a weir having a level sill and sharp edges,—if  $q$  = the quantity of water discharged in cubic feet per minute,  $c$  = the coefficient from the table given below,  $b$  = the breadth of the weir,  $w$  = the width of the stream, and  $h$  = the head of water above the sill of the weir, measured some distance above the same, all in feet; then

$$q = c b \sqrt{h^3} \dots\dots\dots(8)$$

When  $b = w$ , that is, when the weir occupies the whole width of the stream,  $c = 214$ ; the values of  $c$ , when  $b$  is less than  $w$  are given in the table below, namely:

Values of $\frac{b}{w}$	1.0	0.9	0.8	0.7	0.6	0.5	0.4	0.3	0.25
Values of $c$	214.0	211.0	208.0	204.4	201.5	198.5	194.9	191.9	190.1

The above formula supposes the water to flow over the weir from a still pond, but if the water approaches the weir with a velocity equal to  $v$  feet per second, let  $h_1 = 0.01553 v^2$ ; then

$$q = c b \{ \sqrt{(h + h_1)^3} - \sqrt{h_1^3} \} \dots\dots\dots(9)$$

In the case of a *drowned weir*, if  $h_2$  = the height of the surface of the water on the lower side of the weir, above the sill of the weir, in feet; then

$$q = c b \left( h + \frac{h_2}{2} \right) \sqrt{h - h_2} \dots\dots\dots(10)$$

When the stream is very small, it is convenient to use a *triangular notch*; if the angle made by the two sides of the notch is  $90^\circ$ , let  $h_3$  = the height in inches of the surface of the water above the lowest point of the notch. the notch being sharp-edged, and the pond still; then

$$q = 0.306 \sqrt{h_3^5} \dots\dots\dots(11)$$

The quantity of water required daily for a domestic water-supply will depend upon the number of persons to be supplied, and upon the character of the

establishment. In a middle-class house, where no horse or carriage is kept, and exclusive of water required for a garden, the quantity of water required per head per diem will be approximately as follows, namely:—Cooking, 0·75 gallon; fluid as drink, 0·33 gallon; ablution (including a daily sponge-bath), 5·00 gallons; washing house and utensils, 3·00 gallons; washing clothes, 2·92 gallons; flushing water-closet, 3·00 gallons—that is to say, a total of 15 gallons per head per day. In a large establishment, where a carriage and horses are kept, the allowance should be from 20 to 30 gallons per head per day.

In determining the sufficiency or otherwise of a stream to afford the quantity of water required in any particular case, it is necessary to ascertain **the minimum dry-weather flow**. Where the dry-weather flow would be insufficient, and the power is possessed to throw a dam across the stream, a large reservoir may be formed in order to impound the water in time of floods. In the construction of the dam, very great care must be taken to render it capable of sustaining the pressure to which it will be exposed.

Up to recent times **dams for impounding water** were constructed of earthen embankments, with a slope of 3 to 1 on the inner face and 2 to 1 on the outer face; the inner face was usually paved, and a wall of clay puddle was inserted in the middle of the embankment, with the view of rendering it water-tight. Dams so constructed may stand for many years, but a time will come, when the water, having found its way through the puddle-wall in ever so small a quantity, gradually washes away the puddle, until without warning the embankment gives way, occasioning a disaster usually attended by serious loss of life and property. Clay puddle is a most treacherous material, very useful for temporary purposes, but should never be employed in permanent construction. At the present day engineers usually employ concrete in place of clay; and the most recent dams have been constructed either of concrete or rubble masonry.

In order to ensure perfect safety in **dams constructed of concrete or masonry**, no part of the structure should be exposed to a tensile strain; to ensure which condition it is necessary that the resultant of the pressure of the water when the reservoir is full, and of the weight of the dam itself, above any given horizontal plane, shall be within the middle third of the breadth of the dam at the level of such plane. If  $h$  = the height of the dam in feet,  $b$  = the breadth of its base in feet,  $w$  = the weight in pounds of a cubic foot of the material of which the dam is composed, and  $c$  = the maximum pressure in pounds per square foot to which this material may be safely exposed; then

$$b = 7.9 h \sqrt{\frac{1}{w}} \dots\dots\dots(12)$$

$$\text{and } c = (h \ 62.5 + w) \dots\dots\dots(13)$$



If the dam is of concrete,  $w$  may be taken at 142 pounds, and we have

$$b = \frac{2}{3} h \dots\dots\dots(14)$$

$$\text{and } c = 204.5 h \dots\dots\dots(15)$$

Fig. 105 is the **transverse section of a concrete dam**, the profile of which is determined from formula 14, the breadth being in all parts two-thirds of the depth from the surface of the reservoir when full; the section is a triangle with its inner face vertical, and its outer face inclined to the vertical at an angle of  $33^\circ 42'$ . The theoretic section would give no breadth at the top of the dam, as shown by the dotted line. It is, however, convenient to have a path on the top, and some thickness is necessary to render the upper part of the dam water-tight; therefore the top may be made from 6 to 10 feet in width, carried down vertically until it coincides with the sloping face. In a concrete dam of the section shown, the value of  $c$ ,—that is, the maximum pressure upon the concrete,—at a depth of 30 feet, would be 6135 pounds per square foot; at a depth of 50 feet, 10,215 pounds; and at a depth of 100 feet, 20,430 pounds.

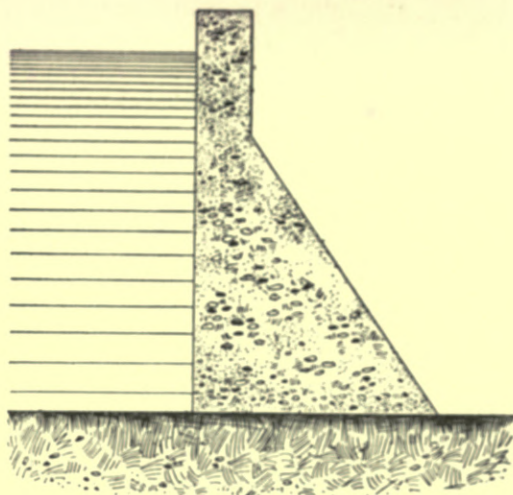

Fig. 105.—Transverse Section of Concrete Dam.

In an impounding reservoir, it is necessary to provide **an overflow-channel**, by which flood-water may escape after the reservoir is full. In the case of an earthen dam, this is a matter of some difficulty, and it is usual to make the overflow-channel in the solid ground at one end of the dam; but when the dam is of concrete or masonry, the overflow-weir and channel may be constructed in the dam itself. It is important that the channel should be large enough to allow of the escape of the heaviest flood which can occur. Let  $r$  = the heaviest rainfall in inches per hour which has been known in the locality,  $a$  = the area in acres of the catchment basin,  $l$  = the length in feet of the overflow-weir,  $d$  = the maximum depth in feet of the water flowing over the same,  $n$  = a fraction expressing the proportion of the rainfall which will find its way into the reservoir, and  $q$  = the quantity in cubic feet per minute flowing over the weir, then

$$q = 60.5 r n a \dots\dots\dots(16)$$

$$\text{and } l = 0.2827 \frac{n r a}{\sqrt{d^3}} \dots\dots\dots(17)$$

If  $d = 2$ , then

$$l = \frac{nra}{10} \dots\dots\dots(18)$$

The value of  $n$  will depend upon the extent of the catchment basin, the greater or less inclination of its surface, and the more or less pervious character of the soil, as explained in Chapter I. Professor Unwin in the article on Hydro-mechanics in the *Encyclopædia Britannica* gives, on the authority of Tiefenbacher, the following estimate of the flood-discharge of streams in Europe:—

TABLE X.  
FLOOD-DISCHARGE OF STREAMS.

Description of Country.	Cubic feet per second per square mile.	Equivalent to inches of rainfall per hour running off.
In flat country,.....	8.7 to 12.5	0.013 to 0.019
In hilly districts,.....	17.5 to 22.5	0.027 to 0.035
In moderately mountainous districts,...	36.2 to 45.0	0.056 to 0.070
In very mountainous districts,.....	50.0 to 75.0	0.077 to 0.116

For comparatively small areas these quantities are obviously much too small. Occasionally in England a rainfall of two inches in the hour has been recorded;

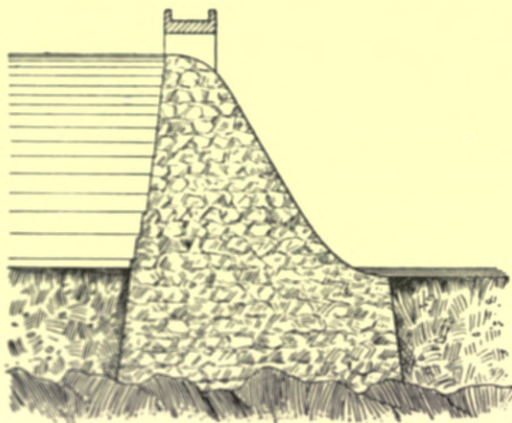

Fig. 106.—Section of Rubble Dam, Vyrnwy Reservoir.

and assuming that only half the rainfall finds its way into the reservoir, the quantity discharged per acre would amount to 60.5 cubic feet per minute; equal to 645 cubic feet per second per square mile.

Fig. 106 is a transverse section of the rubble-masonry dam of the **Vyrnwy reservoir**, which supplies Liverpool with water; and in this case the whole dam forms the weir over which the flood-waters are discharged, the roadway across the dam being carried on

arches, through which the flood-waters escape.

To make a dam secure, it must be carried down until either solid rock, or a stratum of clay, or other material impervious to water, is reached, as is seen in fig. 106.

The pipe for drawing the water from the reservoir must be led from it at the lowest level to which it is intended to draw down the water. With an

earthen dam, it is so difficult to prevent the water creeping along outside the pipe, that it is usual to drive a tunnel through the solid ground for the reception of the pipe. If, however, the dam is of concrete or masonry, the pipe may be taken through it with perfect safety.

Fig. 107 is a vertical section, and fig. 108 is a plan, showing a convenient arrangement for the valve-chamber, when the dam is of concrete and the inner face is vertical. The water is admitted to the valve-chamber A, through a pipe B which is built into the wall of the chamber; this pipe has a valve C to regulate the discharge, and its outer end in the reservoir is protected by a rose pierced with small

holes so as to prevent the entrance of foreign substances. It is not unusual to have more than one pipe for admitting water to the valve-chamber, placed at different levels; as the nearer the water is drawn from the surface, the less liable it is to contain deposit. D is the supply-main, which is carried through the solid concrete.

Where the supply is derived from a spring, an underground tank should be constructed at such a level as to allow the water from the spring to fill it by gravitation. For small tanks, it is most economical to construct them circular on plan, but large tanks are usually made rectangular with straight sides. The side-walls of the tank have to resist the pressure of the earth on the outer side, and of the water on the inner side. The centre of pressure of all kinds of earth is (as in the case of water) at two-thirds of the

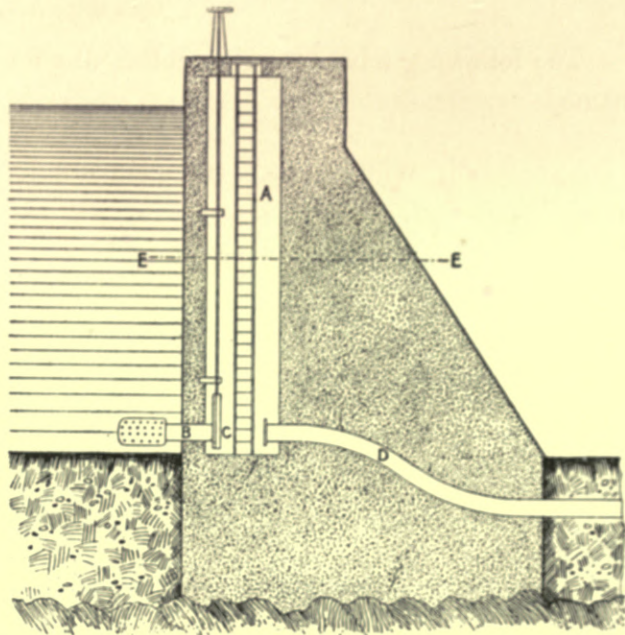

Fig. 107.—Vertical Section of Valve-chamber.

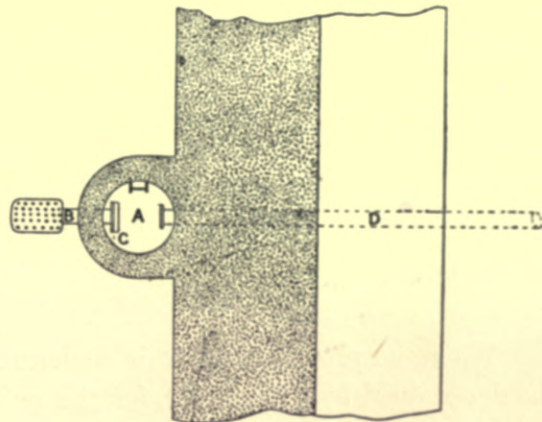

Fig. 108.—Horizontal Section of Valve-chamber on line E-E.

height of the wall below the top; and putting  $p$  = this pressure in pounds,  $h$  = the height of the wall in feet, and  $c$  = a coefficient, we have

$$p = ch^2 \dots \dots \dots (19)$$

The following table gives the values of  $c$  for the various descriptions of earth named:—

TABLE XI.  
WEIGHT, &c., OF VARIOUS KINDS OF EARTH.

Nature of the Earth.	Weight of a cubic foot in pounds.	Value of $c$ .
Fine dry sand, ... ..	94 to 119	15.67 to 12.94
Loose shingle, perfectly dry, ... ..	106	12.06
Common earth, perfectly dry and pulverulent, ...	94	8.82
The same, slightly moistened, or in its natural state,	106	5.60
Earth the most dense and compact, ... ..	125	6.21

The greatest strain upon the wall is when the tank is empty, when the pressure of the earth tends to overthrow it. This tendency is resisted by the weight of the wall. Let  $h$  = the depth of the floor of the tank below the surface of the ground,  $d$  = the horizontal distance of the centre of gravity of the wall from the inner face of the wall, both in feet,  $w$  = the weight of the wall in pounds, and  $c$  = the coefficient in the table above; then, in order that the wall may not be overthrown,

$$wd \text{ must be greater than } \frac{ch^3}{3} \dots \dots \dots (20)$$

When the tank is filled with water, let  $h_1$  = the height of the same in feet, and  $p_1$  = the pressure in pounds tending to overthrow the wall outwards; then

$$p_1 = 31.25 h_1^2 \dots \dots \dots (21)$$

For a tank above the surface of the ground, if  $b$  = the breadth of the wall at its base in feet, in order that the wall may not be overthrown by the pressure of the water,

$$w(b - d) \text{ must be greater than } 10.42 h_1^3 \dots \dots \dots (22)$$

When, however, the tank is underground, the dimensions of the wall may be determined by formula 20, for the resistance which the ground offers to any pressure to which it is exposed, is very much greater than its active pressure tending to overthrow the wall.

When the tank is underground and covered, **ventilation-pipes** should be inserted in the roof, and their upper extremities should be protected by wire cages to prevent birds building nests in them.

Fig. 109 is a vertical section of an underground concrete tank, showing the details of its construction. The outer face of the wall should never be made sloping, but should diminish in thickness by set-offs as shown. The best material for the construction of tanks is concrete, which if properly made is perfectly water-tight. The

floor should be a sheet of concrete 12 inches in thickness, and the roof should consist of a sheet of the same material  $4\frac{1}{2}$  inches in thickness, having embedded in its lower surface a sheet of "expanded metal"; and over this should be spread from 18 inches to 2 feet of soil to keep the tank cool. The usual mode of covering

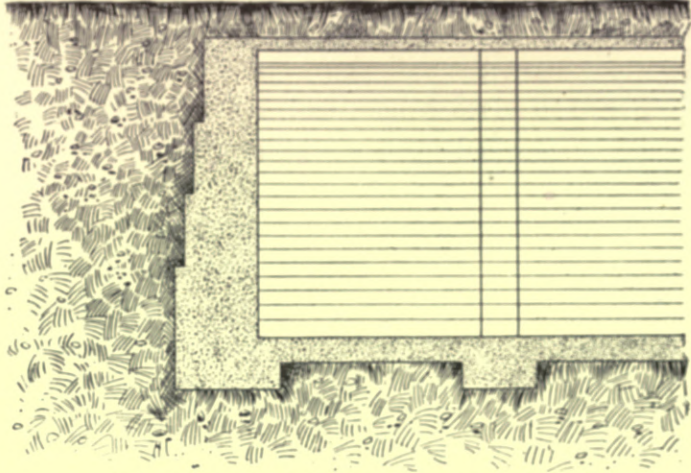

Fig. 109.—Vertical Section of Underground Concrete Tank.

tanks is with segmental brick arches, but the flat covering of concrete, supported upon piers of concrete one foot square, placed at distances from centre to centre of about 12 feet, is far superior, as it brings no thrust upon the side-walls, and occupies less space.

## 2. WELL-WATER.

In all the foregoing cases, the water is met with on the surface; when, however, the water-bearing stratum is situated at some distance below the surface, the water can only be reached by sinking a well, or boring.

**Wells are of two descriptions**, namely, *shallow* wells, which derive their supply from the strata near the surface; and *deep* wells, which derive their supply from a water-bearing stratum beneath the uppermost impervious stratum.

The water from **shallow wells** is very liable to be polluted, and should therefore be carefully examined from time to time. Before the importance of the purity of the water used for dietetic purposes was recognized, wells were intentionally made so that the subsoil-water should percolate through the sides of the well, which were constructed with bricks laid dry. Now, however, in the construction of wells, every endeavour is made to exclude the water near the surface, which is liable to be polluted from manure spread over the land, from

decaying vegetation, from cesspools and leaky sewers, and from other causes. With this object, if the well is constructed of brick or stone, the joints should be made with Portland cement, and the outer surface should be rendered with the same material. The best material, however, for the construction of wells is concrete, which is more homogeneous, and more impervious to water, than either brickwork or stone. Where the well is carried to any considerable depth, it is best to construct it with cylinders of cast-iron, wrought-iron, or steel.

Fig. 110 gives a plan and section of a well constructed of concrete. It should be founded upon a cast-iron curb of the form shown, made in segments and bolted together.

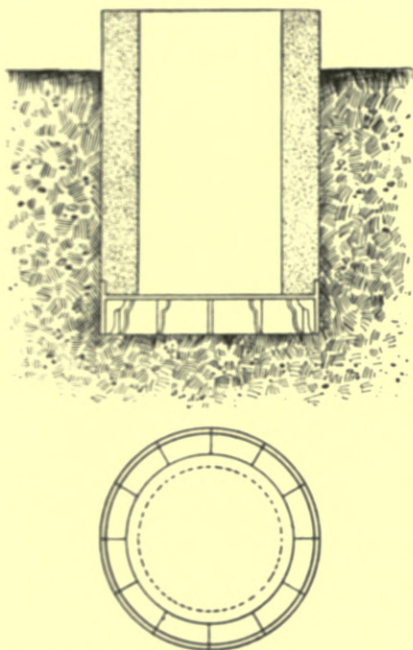

Fig. 110.—Plan and Section of Well constructed of Concrete.

The outer surface of the concrete should be rendered with cement, made perfectly smooth, and payed over with grease. The friction of the ground against the sides of the well causes a resistance to its descent, and after it has attained a certain depth (depending upon the nature of the soil), it will become earth-bound. When this occurs, water should be poured round the outside to diminish the friction, and the well should be loaded. If the concrete well becomes earth-bound before it has reached the depth required, an iron or steel cylinder may be sunk inside it, and when this becomes earth-bound, a smaller cylinder may be sunk inside the larger one, and so on until the requisite depth, to which the well has to be lined, has been reached. The annular spaces between the several cylinders should be filled with concrete, so as entirely to exclude the

water from the surrounding ground. Fig. 111 is a vertical section of a well thus lined.

The usual practice is to carry the lining of the well down until all the water liable to pollution is excluded, and then to carry down a **bore-hole** to the water-bearing stratum from which the supply is desired to be obtained. The expediency, however, of doing this must depend on the nature of this lower stratum. If the water generally permeates the rock, or if it is obtained from sandy beds, then the well should be carried down; if a very large supply is required, then the well should be carried down, and headings or galleries should be driven horizontally to intercept the water over a larger area. Where, however,

the water comes from horizontal beds, such as flints in the chalk, or from fissures in the rock, a bore-hole often yields a sufficient supply. The bore-hole for a certain distance down should be lined with a steel tube, into which, if the water does not rise to the top of the tube, a lifting-pump should be fixed, by means of which the water can be raised to the level required. The pump is similar in construction to that shown in fig. 114, the pump-rod being connected to a crank-shaft at the top of the well. In this case the whole of the work is done on the upward stroke, when the column of water is lifted; to equalize the work, it is usual to have on the shaft a second crank at right angles to that to which the pump-rod is attached, and from this second crank to suspend a weight, equal to half that of the column of water lifted by the pump. If the water rises to a sufficient height in the well itself, it is better to have three pumps worked from a three-throw crank, and discharging into one rising main, as the flow of water in this will then be much more equable.

In localities where the water within from 15 to 30 feet of the surface is suitable in quality for a domestic supply, what is termed an **Abysinian or driven-tube well** may be very economically and conveniently used. It consists of a wrought-iron tube, varying in diameter from  $1\frac{1}{4}$  to 3 inches (depending upon the quantity of water required), and shod with a solid point so as to prevent any dirt from entering the pipe while it is being driven into the ground; the lower part of the pipe is pierced with numerous holes, through which the water contained in the ground finds its way into the pipe, when it has reached the water-bearing stratum. An ordinary suction-pump, similar to that shown in fig. 113, is then connected to the upper end of the tube, and a supply of water can be drawn from the ground.

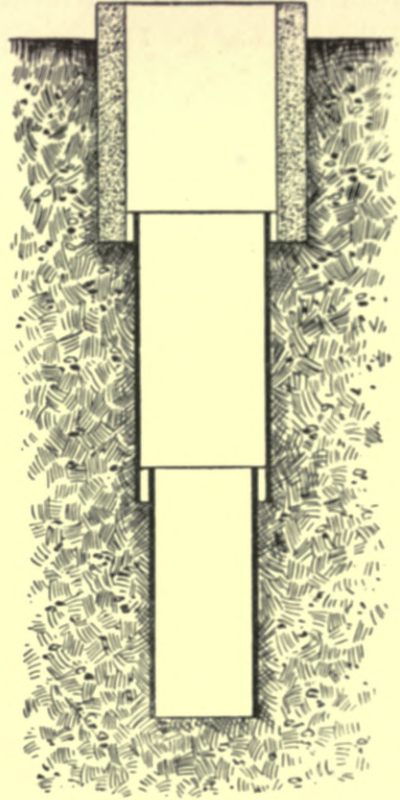

Fig. 111.—Vertical Section of Well constructed of Concrete and Iron Cylinders.

CHAPTER IV.

METHODS OF RAISING WATER.

The hydraulic ram is a simple machine, which may be used for raising water from a stream in which there is sufficient fall. The principle of its action is as follows:—A B, fig. 112, is a pipe supplied with water from the stream at a

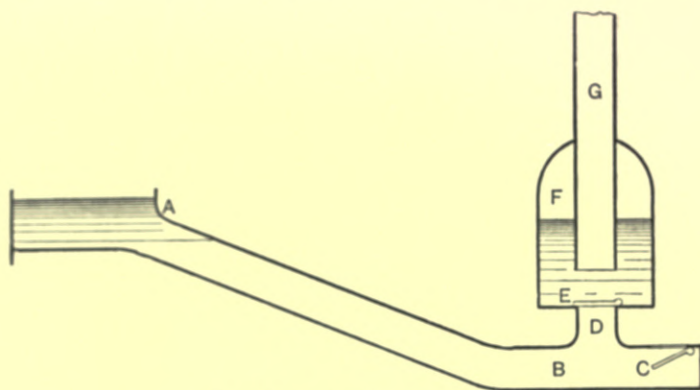

Fig. 112.—Section of Hydraulic Ram.

higher level; at the lower termination of this pipe there is a weighted valve *c*, opening inwards; there is also a branch-pipe *D*, having a valve *E* opening outwards, and discharging into an air-vessel *F*, from which the supply-pipe or rising main *G* is led to the point to be supplied. The water

contained in the pipe *A B* escapes from the valve *c*, until it has acquired sufficient velocity to close it; water being practically incompressible, as soon as the valve *c* closes, the momentum acquired by the volume of water in the pipe *A B* expends itself by opening the valve *E*, and forcing a certain amount of water through it and the rising main *G*. As soon as the water in the pipe *A B* has expended its force and becomes stationary, the weighted valve *c* opens, when the water again begins to flow down the pipe *A B*, until its momentum closes the valve *c*; and so the operation is repeated.

If *f* = the difference of level in feet between the water at *A* and at the escape-valve *c*, *w* = the number of gallons of water which escape per beat from the valve *c*, *h* = the height in feet to which the water has to be supplied, *q* = the quantity of water in gallons which will be supplied per beat, and *c* = a coefficient which varies from 0.55 to 0.70, we have .

$$q = c \frac{f w}{h} \dots\dots\dots(23)$$

The pipe *A B* should be about twice the diameter of the delivery-pipe *G*, and its length from  $2\frac{1}{2}$  to 3 times *f*. The height to which the water is raised may be from 20 to 30 times *f*, and *f* should not be less than 8 feet.



Pumps for raising water may be divided into (a) lifting-pumps, (b) force-pumps, (c) centrifugal pumps, and (d) chain-pumps.

(a). A section of a **lifting-pump** is shown in fig. 113. It consists of a cylinder or barrel A B, from the lower end of which a pipe B C, called the suction-pipe, is led into the stream or reservoir of water from which the supply is to be obtained; at B is a valve opening upwards, and in the barrel is a piston D, usually termed a bucket, which perfectly fits the barrel, and contains a valve opening upwards; E is the delivery-pipe. Upon pushing the bucket D downwards, the air contained in the barrel between D and B is expelled through the valve in D; upon moving the bucket D upwards, a partial vacuum is created, and the pressure of the atmosphere upon the surface of the water at c, causes the water to ascend the pipe B C, expelling the air. After a few strokes the air in the barrel and suction-pipe is replaced by water, after which each upward stroke of the bucket discharges, through the delivery-pipe E, a quantity of water nearly equal to that contained in a length of the barrel equal to the stroke of the bucket.

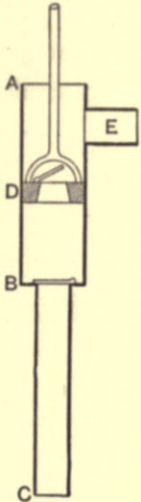

Fig. 113.—Section of Lifting-pump.

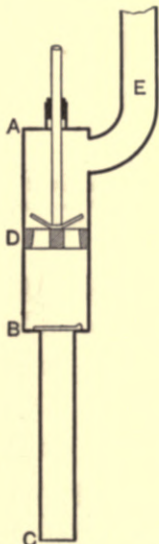

Fig. 114.—Section of Lifting-pump, with high Delivery-pipe.

When the water is required to be delivered at a higher level than the top A of the barrel, a water-tight cover is bolted thereon, through which the rod working the bucket passes, a stuffing-box being provided to prevent leakage, as shown in fig. 114. The height to which water can be raised by this arrangement is only limited by the strength and power of the pump. The valve at B, however, must not be placed more than 25 or 30 feet above the surface of the water in the well.

(b). Fig. 115 is a section of a **force-pump**, the letters having the same significance as in the two former figures; but the bucket is replaced by a solid piston, and the delivery-valve is placed at the entrance to the delivery-pipe E, and the water is ejected during the down stroke of the piston. Fig. 116 shows another form of the force-pump, in which the piston D is replaced by a

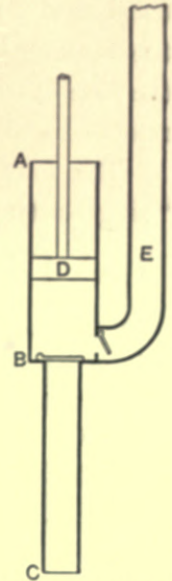

Fig. 115.—Section of Force-pump.

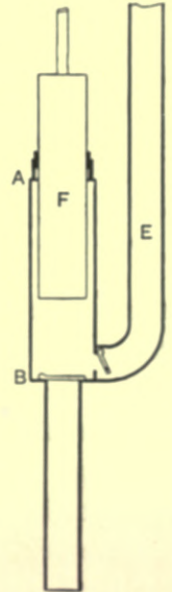

Fig. 116.—Section of Force-pump, with Plunger.

plunger F, which passes through a water-tight stuffing-box in the top cover of the barrel A B. The plunger is preferable to the piston, because the packing in the stuffing-box can be renewed without disturbing the machinery; whereas in the case of the piston, when the packing has to be renewed the piston must be removed from the barrel.

The four pumps shown in the figures 113, 114, 115, and 116, are termed "single-acting" pumps, because the water is only delivered during the up stroke in the two former, and on the down stroke in the two latter.

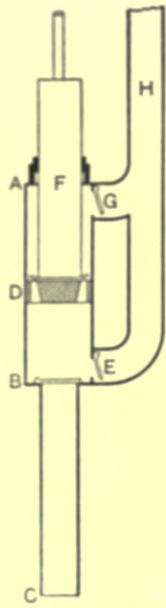

Fig. 117.—Section of Plunger-and-bucket Pump.

Fig. 117 shows another form of force-pump, known as **the plunger-and-bucket pump**. The diameters of the barrel A B, and of the plunger F, are so proportioned that the sectional area of the former is twice that of the latter. The bottom of the plunger is connected to a bucket D, with valves opening upwards, and a rising main or delivery-pipe H is connected both with the top and the bottom of the barrel A B, having valves opening outwards both at E and at G. When the plunger is raised, the water contained in the annular space above the piston is forced into the delivery-pipe H, through the valve G, and on the down stroke half the water contained in the barrel below the bucket passes through the valves in

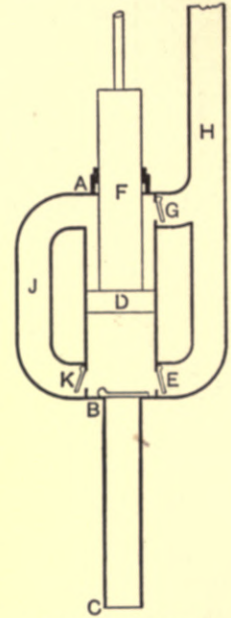

Fig. 118.—Section of Double-acting Force-pump, with Solid Piston.

the bucket, again filling the annular space, while the other half is forced through the valve E into the delivery-pipe H. This form of pump is termed "double-acting", as the water is sent into the delivery-pipe both on the up and down strokes, the advantage of which is that a more equable flow is obtained.

Fig. 118 shows a modification of the double-acting force-pump, which consists in substituting a solid piston for the bucket D, and providing a pipe J, connecting the top and bottom of the barrel with a valve K opening outward at its lower end.

The double-acting pumps shown in figs. 117 and 118 only deliver half a barrelful of water each up and down stroke, but by the arrangement shown in fig. 119 a barrelful of water will be delivered both on the up and down strokes of the piston.

The intermittent action of the pumps just described is objectionable, in

consequence of the shock which results from the sudden stopping and starting of the column of water in the suction and delivery pipes, at each stroke of the pumps. To obviate this, and to produce as uniform a flow as possible, an air-vessel should always be introduced upon the delivery-pipe, as near to the pump as possible; and a similar air-vessel should be placed on the suction-pipe close to the pump, whenever the water is drawn from any distance. As the air gradually escapes from air-vessels, a pet-cock should be introduced at the highest and lowest points of the air-vessel, both of which should be opened previous to starting the pumps. One of the best and simplest forms of air-vessel is a vertical pipe, equal in diameter to the suction or delivery pipe upon which it is placed.

If  $c$  = the capacity of the air-vessel in cubic feet,  $d$  = the quantity of water delivered per stroke in cubic feet,  $h$  = the head of water in the rising main in feet and  $n$  = a coefficient, then we have

$$c = n h d \dots\dots\dots(24)$$

With one single-acting pump,  $n = 0.0434$ ; with two single-acting pumps, or one double-acting pump,  $n = 0.0239$ ; with three single-acting-pumps,  $n = 0.0145$ ; and with four single-acting pumps, or two double-acting pumps,  $n = 0.0108$ .

Where there are the means of supporting it, and its appearance would not be objectionable, a *stand-pipe* (that is, a perpendicular pipe equal in diameter to the rising main, open at the top, and connected to the rising main at the bottom, as near to the pump as possible, and rising above the level of the tank into which the water is pumped) may be employed instead of an air-vessel.

In order to obtain the greatest amount of efficiency from pumping-machinery, the following points should be attended to:—

1. The suction-pipe should be as short as possible; in fact, if the pump can be placed below the level of the water, it will give the best results. The greatest vertical length possible for the suction-pipe is about 30 feet, and when approaching that length it is desirable to have a valve at the bottom of the pipe opening upwards, which is termed a foot-valve. And if the water is liable to contain leaves or other floating matter, the bottom of the suction-pipe should be protected by a *rose* pierced with holes.

2. The suction and delivery pipes should be as large as possible, and are best when they are the same size as the pump-barrel.

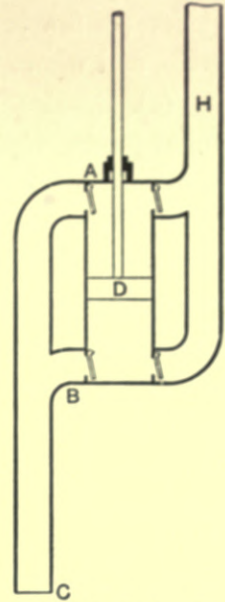

Fig. 119.—Section of Improved Double-acting Force-pump.

3. The valves should afford as large a passage for the water as possible, and should have a limited beat.

4. The longer the stroke of the pump the better, as at each change of stroke there is a certain loss from the return of water through the valves, before they close.

5. As few bends should be made in the suction and delivery pipes as possible, and where they are unavoidable they should be made as easy as possible.

(c). Besides the different forms of pumps above described, there is **the centrifugal pump**, which consists of revolving vanes within a case, which draw the water in at the axis, and expel it by centrifugal force at the circumference.

(d). There is also **the chain-pump**, which consists of an endless chain passing round two pulleys, and having fixed upon it, at regular distances, discs which fit loosely a vertical pipe; when the pulleys revolve, the upward movement of the discs carries the water up the pipe, and delivers it at its upper end.

**The various sources of power** utilized to work pumps or other machines for raising water, may be enumerated as follows:—the fall of water, windmills, manual or animal labour, steam-engines, gas and oil engines, hot-air engines, and dynamos.

The simplest form in which **water-power** is utilized to raise water is the hydraulic ram, which has been already described. Where a weir can be constructed to pen back the water so that a fall of a few feet can be obtained, either a water-wheel or a turbine may be used; these are more economical, as far as use of water is concerned, than the hydraulic ram.

Three different forms of **water-wheel** are in use, namely, the undershot, the breast-wheel, and the overshot. The undershot is merely a wheel with floats similar to a paddle-wheel, and is only used with very low falls; it is actuated only by the impact of the water. In the case of the breast and overshot wheels, a series of buckets are formed on the circumference of the wheel, which become filled with water; the weight of the water is the motive power. If  $H$  = the horse-power equal to 33,000 pounds raised one foot high per minute,  $q$  = the quantity of water used in cubic feet per second, and  $h$  = the head of water in feet, then we have in the case of the undershot wheel,

$$H = 0.034 qh \dots \dots \dots (25)$$

$$q = 29.4 \frac{H}{h} \dots \dots \dots (26)$$

In the case of the breast-wheel,

$$H = 0.068 qh \dots \dots \dots (27)$$

$$q = 14.7 \frac{H}{h} \dots \dots \dots (28)$$

And in the case of the overshot wheel,

$$H = 0.077 qh \dots\dots\dots(29)$$

$$q = 12.95 \frac{H}{h} \dots\dots\dots(30)$$

There are various forms of **turbines**, but the best is the "Vortex" turbine, designed by Professor James Thompson. One great advantage which the turbine possesses over a water-wheel, is that it is able to work in time of floods, when the rise of the backwater would prevent a water-wheel from working. With a well-designed turbine,

$$H = 0.09 qh \dots\dots\dots(31)$$

$$q = 11.11 \frac{H}{h} \dots\dots\dots(32)$$

**Wind-power** is sometimes adopted, but a great drawback is its uncertainty, and the possibility of the absence of wind for some days. When wind-power is used, it is necessary that the capacity of the tank or reservoir, into which the water is pumped, should be equal to at least three days' consumption. It may be taken that in this country the wind blows on the average with a pressure of one pound per square foot for eight hours in the twenty-four. If the annular type of wind-engine be used, the power obtained would vary according to the diameter, from about a quarter of a horse-power when 10 feet in diameter, to 4 horse-power when 30 feet in diameter.

**Power is estimated in foot-pounds per minute**—that is to say, the number of pounds which can be raised one foot high per minute. The power of a man pumping water may be taken at 2600 foot-pounds; and that of a horse working with ordinary horse-gear, 20,000 foot-pounds. In estimating the power of steam or other engines, the horse-power is taken at 33,000 foot-pounds per minute. The *indicated* horse-power of an engine is the power developed in the cylinder, from which the power absorbed in overcoming the friction of the several moving parts of the engine has to be deducted, and the remainder is termed the *brake* horse-power, and is that which the engine is actually capable of exerting.

**The steam-engine** requires constant attention, and is therefore not so convenient or economical for small powers as oil or gas engines; but the latter do not work so quietly, and are not so easily started.

The high speed at which both **turbines and dynamos** work makes them better suited for driving centrifugal pumps; if used to drive ordinary reciprocating pumps, it is necessary to reduce the speed by gear-work, or straps and pulleys, which occasion a loss from friction.

**In estimating the power required to raise water by pumping**, an allowance

must be made for the friction of the pumping machinery, for the loss of water at the end of each stroke by its escape through the valves before they close, and for the friction of the water passing through the rising main. If  $h$  = the height the water has to be lifted,  $h_1$  = the head required to overcome the resistance of the water passing through the rising main, both in feet,  $q$  = the quantity of water to be lifted in cubic feet per minute,  $\alpha$  = the loss of water returning through the valves in cubic feet per minute,  $f$  = the frictional resistance of the pumping machinery, and  $H$  = the brake horse-power of the steam-engine or other motor; then

$$H = 528 (1 + f) \cdot (h + h_1) \cdot (q + \alpha) \dots \dots \dots (33)$$

$f$  will vary from 0.2 to 0.35, and  $\alpha$  from 0.06 to 0.10; the value of  $h_1$  will be found by formula (39) page 200.

---

## CHAPTER V.

### THE CONVEYANCE OF WATER.

**There are two forces** which may be employed to produce motion in water; namely—*first*, the natural force of gravity, by virtue of which each particle tends to move to a lower point; and *secondly*, pressure produced by some mechanical means, in which case each particle tends to move towards a point where the pressure is less.

**Two different kinds of conduits** may also be used for its conveyance from place to place; namely—*first*, open channels, in which case only gravity can act; and *secondly*, closed pipes, in which the motion is created by pressure, whether that pressure be caused by the weight of the water itself or by mechanical means.

The motion of the water is opposed by the resistance caused by **the friction of its particles** against the sides and bed of the open channel, or the surface of the closed pipe. This resistance will be directly proportional to the wetted surface or perimeter, and inversely proportional to the area occupied by the water; that is, if  $a$  = the area filled by the water in square feet, and  $p$  = the wetted perimeter in feet, then  $\frac{a}{p}$  is termed the *hydraulic mean depth*.

Up to within a recent date, the formula generally employed by engineers for **calculating the flow of water not under pressure** was that proposed by Eytelwein, which, when reduced to its most convenient form, is as follows:—

$$v = 5651 \cdot 9 \sqrt{\frac{\alpha}{pl}} \dots\dots\dots(34)$$

$$q = 5651 \cdot 9 \sqrt{\frac{\alpha^3}{pl}} \dots\dots\dots(35)$$

In these formulas,  $\alpha$  = the area in square feet of the channel filled with water,  $p$  = the wetted perimeter in feet,  $l$  = the length in feet in which the surface of the water falls one foot,  $v$  = the mean velocity in feet per minute, and  $q$  = the quantity of water discharged in cubic feet per minute.

It will be observed that in these formulas no account is taken of the roughness or smoothness of the wetted surface. More recent observations, however, have shown that the nature of the surface should be regarded, and that Eytelwein's formula in some cases gives too low a value for  $v$  and  $q$ . The observations made by Darcy, Bazin, Ganguillet, and Kutter show that the value of the coefficient, by which  $\sqrt{\frac{\alpha}{pl}}$  should be multiplied, depends upon the hydraulic mean depth and the nature and condition of the wetted perimeter, and, in the case of open channels, upon the inclination of the surface of the stream.

Kutter's formula for the velocity of water flowing in an open channel may be expressed as follows:—

$$v_1 = \delta \sqrt{\frac{1}{l} \left( \frac{s+m}{\sqrt{\delta+sn}} \right)} \dots\dots\dots(36)$$

in which  $v_1$  = the mean velocity in feet per second,  $\delta$  = the hydraulic mean depth in feet,  $l$  = the length in which the surface of the water in the channel falls 1,  $s = 41 \cdot 6605 + \cdot 0028076 l$ , and  $n$  and  $m$  are coefficients, the value of which are given in the following table:—

TABLE XII.

VALUE OF COEFFICIENTS FOR CALCULATING THE FLOW OF WATER IN OPEN CHANNELS (KUTTER'S FORMULA).

NATURE OF CHANNEL.	Value of $n$ .	Value of $m$ .
Regular channel lined with well-planed timber, .....	·009	201·27
"    "    rendered with neat cement, .....	·010	181·13
"    "    "    "    1 part sand and 3 parts cement, .....	·011	164·66
"    "    lined with unplanned timber, .....	·012	150·94
"    "    "    "    brickwork or ashlar masonry, .....	·013	139·33
"    "    "    "    rubble masonry, .....	·017	106·55
Irregular channel in firm gravel, .....	·020	90·57
Canals and rivers, in moderately good order, and free from boulders and weeds, .....	·025	72·45
"    "    having boulders and weeds occasionally, .....	·030	60·38
"    "    in bad order, overgrown with vegetation, and strewn with boulders, .....	·035	51·75

Putting  $\alpha$  = the area of channel filled with water in square feet, and  $q$  = the discharge in cubic feet per minute; then

$$q = 60 v_1 a \dots\dots\dots(37)$$

To give the velocity and discharge through pipes under pressure, Darcy's formula is to be preferred to Kutter's. Let  $v$  = the velocity in feet per minute,  $l$  = the length of the pipe in feet,  $d$  = the diameter of the pipe in feet,  $h$  = the difference of level in feet of the water at the two extremities of the pipe,  $q$  = the discharge in cubic feet per minute, and  $c$  and  $e$  = coefficients whose values depend upon the condition of the internal surface of the pipe; then

$$v = c \sqrt{\frac{d^2 h}{l(d + 0.0833)}} \dots\dots\dots(38)$$

$$q = c \sqrt{\frac{d^6 h}{l(d + 0.0833)}} \dots\dots\dots(39)$$

With clean iron pipes,  $c = 3390$ , and  $e = 2662$ ; and with rusted pipes,  $c = 2400$ , and  $e = 1885$ .

The above formulas suppose the pipes to be in one straight course; if bends are introduced, the resistance is increased; if  $R$  = the radius of the centre line of the bend,  $r$  = the radius of the pipe,  $v_1$  = the velocity in feet per second through the pipe,  $c$  = a variable coefficient,  $n$  = the number of degrees that the pipe changes its direction, and  $h$  = the head in feet required to overcome the resistance of the bend, then

$$h = cnv_1^2 \dots\dots\dots(40)$$

In circular pipes,

$$c = .000011304 + .00015938 \sqrt{\left(\frac{r}{R}\right)^7}.$$

And in square pipes,

$$c = .0000107 + .00026786 \sqrt{\left(\frac{r}{R}\right)^7}.$$

The following is a convenient formula for calculating the horse-power required to pump water through pipes. Let  $P$  = the horse-power required,  $l$  = the length of the pipe in feet,  $q$  = the quantity of water in cubic feet per minute, and  $d$  = the diameter of the pipe in inches; then

$$P = .00009688 \frac{q^3 l}{d^5} \dots\dots\dots(41)$$

In leading a pipe from a reservoir or tank, it should be formed with a bell-mouth. If  $d$  = the diameter of the pipe, the opening into the tank should equal  $1.25d$ ; the length of the curved portion, measured on the centre-line of



the pipe, should equal  $0.625d$ , and the radius of the curved side should equal  $1.625d$ .

In some cases it may be convenient to convey the water from a distant source to the point at which it is required to be supplied by means of an open channel, but generally the water will be conveyed in **pipes under pressure**. The material for these pipes may be wrought-iron, cast-iron, steel, lead, or copper. For very small pipes, either lead or wrought-iron may be employed, depending upon the nature of the water to be conveyed. It is found that some waters dissolve lead, in which case iron pipes should be used. Wrought-iron pipes should be galvanized,<sup>1</sup> and cast-iron pipes should be coated with Angus Smith's preparation to preserve them from rusting. To prevent the action of the water on lead pipes they are sometimes lined with tin, but the practical difficulty in the use of tin-lined pipes is to preserve the perfect continuity of the tin in the case of soldered joints and branches.

There is much difference of opinion amongst chemists as to the precise cause of **the action of water upon lead**. In a paper read by Professor Percy Frankland before the Brighton Congress of the Sanitary Institute in 1890, on "Lead Poisoning by Soft Water-supplies", he says: "It is unquestionable that one and the same water-supply may have the power of acting upon lead at one time, and become inactive at another. If we inquire into the cause of this activity, we find that opinion at the present day is even more divided than in the past; according to some authorities it is due to the presence of acidity in the water, according to others the cause is to be sought in an insufficiency of dissolved silica, whilst others again see, in the absence of a certain proportion of dissolved carbonic acid, the secret of the lead-dissolving power."

Dr. Thresh, in his work on *Water and Water-supplies* (1896), says: "Whatever may be the nature of the action which takes place, the waters which act most freely upon lead are *soft* waters, such as rain-water, upland surface-water, and the waters of certain lakes; and if the uplands from which the water is collected be covered with peat, the plumbo-solvent action of the water will at certain seasons be most energetic. Few *hard* waters exert any action upon lead."

All very soft waters, and those which possess little or no *permanent* hardness, should be carefully examined from time to time as to their power of dissolving lead. Dr. Frankland observes: "If the quantity of lead taken up by the water diminishes from day to day, and soon falls to an insignificant amount,

<sup>1</sup> Small wrought-iron pipes are better lined with a continuous tube of tin, as it is almost impossible to ensure a perfect coat of zinc being deposited, by the galvanizing process, throughout the entire length of a small pipe; the zinc coating, moreover, is at the best very thin, and is easily dissolved by water which acts on lead.—ED.

it may be safely assumed that the water will exert no permanent action on lead. On the other hand, if the proportion of lead taken up is considerable and remains practically constant, or actually increases from day to day, the obvious inference is that the activity will be permanent, and inasmuch as by corrosion the surface of the pipe is enormously increased, larger and larger quantities of lead will in all probability be taken up by the water."

It has been found that filtration through filters constructed of chalk or limestone, as well as filtration through sand, is efficacious in removing lead from water, at any rate for a certain time. But by far the most efficacious method of prevention is **the addition of carbonate of soda to the water**. Dr. Frankland says: "As regards the quantity of carbonate of soda it is necessary to add, this must be ascertained by actual experiment in every particular instance; but in an extreme case, I found it necessary to use five parts of soda to 100,000 parts of water by weight, which, with carbonate of soda at £5 per ton, represents a cost of threepence per 1000 gallons. In most cases, probably, a very much smaller amount only is necessary, and if the quality of a water-supply be watched from time to time, the amount could be frequently varied, and at certain seasons probably the treatment might even be suspended with safety."

At Sheffield the solvent action of the water upon the lead pipes caused much trouble, but the difficulty was got over by **adding powdered chalk** to the water, in quantities varying from one-half to three grains per gallon.

Dr. Frankland suggests that in the case of a domestic water-supply the following precautions should be taken:—

"(1). That no water should be collected for drinking-purposes, until after the tap has been allowed to run for such a length of time as will presumably clear the service-pipe, and that the drinking-water, may, therefore, be advantageously collected immediately after a considerable quantity of water has been drawn for other domestic purposes.

"(2). That the filtration of the water through any form of animal-charcoal filter practically guarantees its absolute freedom from lead.<sup>1</sup>

"(3). That hot water acts more powerfully on lead than cold, and that, therefore, metal tea-pots and other soldered vessels for holding hot water should be avoided as much as possible."

**To determine the thickness of metal** required to resist the internal pressure to which a pipe is exposed, let  $d$  = its internal diameter in inches,  $h$  = the head of water in feet to which it is exposed,  $p$  = the pressure in pounds per square

<sup>1</sup> It must not be forgotten, however, that animal-charcoal filters are not by any means proof against germs, but, on the contrary, favour their propagation.—Ed.

inch resulting from the head  $h$ ,  $s$  = the tensile strain in pounds per square inch to which the material of the pipe may be *safely* exposed, and  $t$  = the thickness of the metal in inches; then

$$t = \frac{dp}{2s} \dots\dots\dots(42)$$

$$t = \frac{0.217hd}{s} \dots\dots\dots(43)$$

The values of  $t$  obtained from the above formulas are sufficient to resist a steady pressure, but in most cases pipes containing water are exposed to shocks produced by suddenly stopping the motion of the water in the pipes. To prevent this shock, all taps, cocks, and valves should be so constructed that they cannot be suddenly closed, but should be moved by a screw which will close them gradually. But as, with every precaution, it is impossible entirely to prevent shocks, an extra thickness beyond that found by the formulas is always allowed. Furthermore, cast pipes are liable to inequalities in their thickness, and an additional allowance is made in consequence.

The following is an empirical rule for **determining the safe thickness for cast-iron pipes**, allowance being made for shocks and inequalities in thickness:—

$$t = .000104 dh + 0.313 \dots\dots\dots(44)$$

$$h = \frac{9615t - 3000}{d} \dots\dots\dots(45)$$

and  $p = \frac{4173t - 1300}{d} \dots\dots\dots(46)$

if  $t_1$  = the thickness of the pipe in 32nds of an inch,

$$h = \frac{300t_1 - 3000}{d} \dots\dots\dots(47)$$

or  $p = \frac{130t_1 - 1300}{d} \dots\dots\dots(48)$

The table on p. 204 gives the safe head of water in feet, and the weight in pounds of one foot in length, of **cast-iron pipes** of various diameters and thicknesses. The weight of the socket or flanges may be taken as equal to one foot in length of the pipe.

It is usual to make cast-iron pipes less than 3 inches in diameter, in 6-foot lengths; above 3 inches and less than 2 feet in diameter, in 9-foot lengths; and pipes of a larger diameter in 12-foot lengths.

**Two kinds of joints** are used, namely—*flanged* joints, and *spigot-and-socket* joints; and these latter are divided into two kinds, namely—*turned-and-bored* joints, and joints run with lead.

TABLE XIII.  
DIAMETER, THICKNESS, WEIGHT, &c., OF CAST-IRON PIPES.

Internal Diameter.	Thick-ness.	Weight.	Safe Head of Water in Feet.	Internal Diameter.	Thick-ness.	Weight.	Safe Head of Water in Feet.	Internal Diameter.	Thick-ness.	Weight.	Safe Head of Water in Feet.
2	$\frac{3}{16}$	8.74	300	9	$\frac{5}{16}$	59.06	333	18	1	181.5	367
2	$\frac{7}{16}$	10.46	600	9	$\frac{3}{4}$	71.70	467	18	$1\frac{1}{4}$	236.2	500
3	$\frac{3}{8}$	12.43	200	9	$\frac{7}{8}$	84.83	600	18	$1\frac{7}{8}$	274.3	600
3	$\frac{7}{16}$	14.77	400	10	$\frac{1}{2}$	51.54	180	21	$\frac{3}{4}$	160.2	200
3	$\frac{1}{2}$	17.18	600	10	$\frac{5}{8}$	65.20	300	21	1	216.0	314
4	$\frac{3}{8}$	16.10	150	10	$\frac{3}{4}$	79.17	420	21	$1\frac{1}{4}$	272.1	429
4	$\frac{7}{16}$	19.06	300	10	$\frac{7}{8}$	93.41	540	21	$1\frac{1}{2}$	331.5	543
4	$\frac{1}{2}$	22.09	450	10	$1\frac{5}{16}$	100.7	600	24	$\frac{3}{4}$	182.3	175
4	$\frac{9}{16}$	25.19	600	11	$\frac{1}{2}$	56.45	164	24	1	245.4	275
5	$\frac{3}{8}$	19.78	120	11	$\frac{5}{8}$	71.33	273	24	$1\frac{1}{4}$	309.9	375
5	$\frac{7}{16}$	23.35	240	11	$\frac{3}{4}$	86.52	382	24	$1\frac{1}{2}$	375.5	475
5	$\frac{1}{2}$	26.99	360	11	$\frac{7}{8}$	102.0	491	27	$\frac{3}{4}$	204.3	155
5	$\frac{5}{8}$	34.53	600	11	1	117.8	600	27	1	274.9	244
6	$\frac{3}{8}$	23.49	100	12	$\frac{1}{2}$	61.34	150	27	$1\frac{1}{4}$	346.7	333
6	$\frac{7}{16}$	27.67	200	12	$\frac{5}{8}$	77.47	250	27	$1\frac{1}{2}$	419.7	422
6	$\frac{1}{2}$	31.82	300	12	$\frac{3}{4}$	93.87	350	30	$\frac{3}{4}$	226.4	140
6	$\frac{5}{8}$	40.67	500	12	$\frac{7}{8}$	110.6	450	30	1	304.3	220
6	$1\frac{1}{16}$	45.15	600	12	1	127.6	550	30	$1\frac{1}{4}$	383.5	300
7	$\frac{7}{16}$	31.94	171	12	$1\frac{1}{16}$	136.2	600	30	$1\frac{1}{2}$	463.9	380
7	$\frac{1}{2}$	36.81	257	15	$\frac{5}{8}$	95.88	200	33	$\frac{3}{4}$	248.5	128
7	$\frac{5}{8}$	46.78	429	15	$\frac{3}{4}$	116.0	280	33	1	333.8	200
7	$\frac{3}{4}$	57.04	600	15	$\frac{7}{8}$	136.4	360	33	$1\frac{1}{4}$	420.3	273
8	$\frac{1}{2}$	41.73	225	15	1	157.1	440	33	$1\frac{1}{2}$	505.0	345
8	$\frac{5}{8}$	52.93	375	15	$1\frac{1}{8}$	178.1	520	36	$\frac{3}{4}$	583.1	117
8	$\frac{3}{4}$	64.43	525	15	$1\frac{1}{4}$	199.4	600	36	1	363.1	183
8	$1\frac{3}{16}$	70.03	600	18	$\frac{5}{8}$	114.3	167	36	$1\frac{1}{4}$	457.2	250
9	$\frac{1}{2}$	46.63	200	18	$\frac{3}{4}$	138.1	233	36	$1\frac{1}{2}$	552.2	317

A flanged joint is shown in fig. 120. Sometimes angular fillets are cast on flanged pipes to connect the flange to the body of the pipe, but these should be

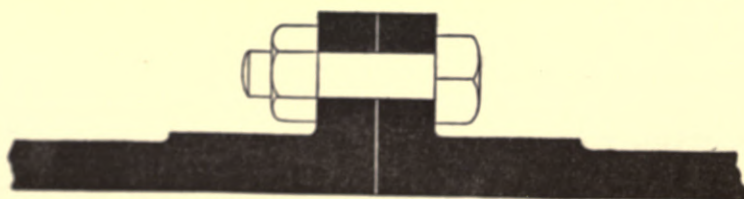

Fig. 120.—Flanged Joint in Cast-iron Pipes.

avoided, as the edges of the sand are very liable to break away when the metal is run into the mould; it is much better to thicken the body of the pipe

for a short distance from the flange, as shown in the figure. The thickness of the flange should be one and a quarter times the thickness of the pipe, and that

of the thickened part of the pipe should be the same as that of the flange. The meeting surfaces of the flange should be faced, in which case a sound joint may be made with millboard, steeped in warm water, and coated with equal parts of white and red lead mixed with boiled linseed-oil; or copper-wire gauze may be substituted for the millboard. Where the flanges have not been faced, insertion (that is, india-rubber with canvas inserted in it) makes the best joint.

Flanged joints are secured by means of **wrought-iron bolts**, the number and size of which depend upon the diameter of the pipe and the pressure to which it is exposed. The number, however, should be such that the distances between them should not be greater than six inches. If  $A$  = the internal area of the pipe in square inches,  $p$  = the pressure to which the pipe is exposed in pounds per square inch,  $s$  = the strain in pounds tending to separate the joint, and  $a$  = the sum of the areas of all the bolts in square inches, then

$$s = pA \dots\dots\dots(49)$$

and  $a = \frac{s}{5000} \dots\dots\dots(50)$

The ordinary spigot-and-socket joint is shown in fig. 121; the dimensions

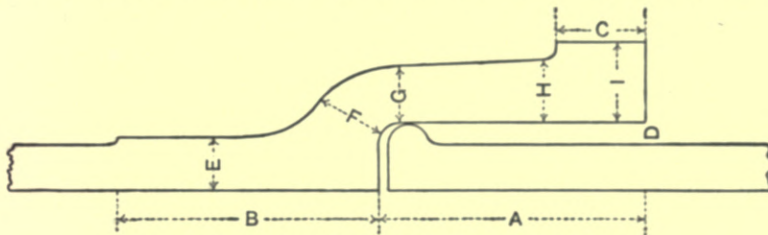

Fig. 121.—Spigot-and-socket Joint in Cast-iron Pipes.

A, B, C, and D shown in the figure should depend upon the internal diameter of the pipe, and should be as in the following table, all the dimensions being in inches.

TABLE XIV.

DIMENSIONS OF SPIGOT-AND-SOCKET JOINTS IN CAST-IRON PIPES.

Diameter of pipe.	A	B	C	D	Diameter of pipe.	A	B	C	D
in.	in.	in.	in.	in.	in.	in.	in.	in.	in.
2	3	3	$\frac{3}{4}$	$\frac{1}{4}$	15	$4\frac{1}{4}$	$4\frac{1}{4}$	$1\frac{1}{8}$	$\frac{3}{8}$
3	3	3	$\frac{3}{4}$	$\frac{1}{4}$	18	$4\frac{1}{2}$	$4\frac{1}{2}$	$1\frac{1}{4}$	$\frac{3}{8}$
4	$3\frac{1}{8}$	$3\frac{1}{8}$	$\frac{3}{4}$	$\frac{1}{4}$	21	$4\frac{3}{4}$	$4\frac{3}{4}$	$1\frac{3}{8}$	$\frac{3}{8}$
5	$3\frac{1}{4}$	$3\frac{1}{4}$	$\frac{7}{8}$	$\frac{3}{8}$	24	$4\frac{7}{8}$	$4\frac{7}{8}$	$1\frac{1}{2}$	$\frac{7}{16}$
6	$3\frac{1}{2}$	$3\frac{1}{2}$	$\frac{7}{8}$	$\frac{3}{8}$	27	5	5	$1\frac{1}{2}$	$\frac{7}{16}$
7	$3\frac{3}{4}$	$3\frac{3}{4}$	$\frac{7}{8}$	$\frac{3}{8}$	30	$5\frac{1}{8}$	$5\frac{1}{8}$	$1\frac{5}{8}$	$\frac{7}{16}$
8	$3\frac{7}{8}$	$3\frac{7}{8}$	1	$\frac{3}{8}$	33	$5\frac{1}{4}$	$5\frac{1}{4}$	$1\frac{3}{4}$	$\frac{1}{2}$
9	4	4	1	$\frac{3}{8}$	36	$5\frac{1}{2}$	$5\frac{1}{2}$	$1\frac{7}{8}$	$\frac{1}{2}$
12	$4\frac{1}{8}$	$4\frac{1}{8}$	1	$\frac{3}{8}$					

The thicknesses E, F, G, H, and I should depend upon the thickness of the body of the pipe, and should be as in the following table, all the dimensions being in inches.

TABLE XV.  
THICKNESS OF METAL IN SPIGOT-AND-SOCKET JOINTS  
IN CAST-IRON PIPES.

Thickness of pipe.	E	F	G	H	I
in.	in.	in.	in.	in.	in.
$\frac{3}{8}$	$\frac{1}{2}$	$\frac{3}{4}$	$\frac{5}{8}$	$\frac{11}{16}$	$\frac{7}{8}$
$\frac{7}{16}$	$\frac{9}{16}$	$\frac{15}{16}$	$\frac{11}{16}$	$\frac{3}{4}$	$\frac{15}{16}$
$\frac{1}{2}$	$\frac{5}{8}$	1	$\frac{3}{4}$	$\frac{13}{16}$	$1\frac{1}{16}$
$\frac{9}{16}$	$\frac{11}{16}$	$1\frac{1}{16}$	$\frac{13}{16}$	$\frac{7}{8}$	$1\frac{1}{8}$
$\frac{5}{8}$	$\frac{3}{4}$	$1\frac{1}{8}$	$\frac{7}{8}$	$\frac{15}{16}$	$1\frac{3}{16}$
$1\frac{1}{16}$	$1\frac{3}{16}$	$1\frac{3}{16}$	$\frac{15}{16}$	1	$1\frac{1}{4}$
$\frac{3}{4}$	$\frac{7}{8}$	$1\frac{1}{4}$	1	$1\frac{1}{16}$	$1\frac{3}{8}$
$1\frac{1}{8}$	$1\frac{5}{16}$	$1\frac{5}{16}$	$1\frac{1}{16}$	$1\frac{1}{8}$	$1\frac{7}{16}$
$\frac{7}{8}$	1	$1\frac{3}{8}$	$1\frac{1}{8}$	$1\frac{1}{4}$	$1\frac{9}{16}$
1	$1\frac{1}{8}$	$1\frac{1}{2}$	$1\frac{1}{4}$	$1\frac{3}{8}$	$1\frac{11}{16}$
$1\frac{1}{8}$	$1\frac{1}{4}$	$1\frac{5}{8}$	$1\frac{3}{8}$	$1\frac{1}{2}$	$1\frac{7}{8}$
$1\frac{1}{4}$	$1\frac{3}{8}$	$1\frac{3}{4}$	$1\frac{1}{2}$	$1\frac{5}{8}$	2

The joint is made by inserting two or three strands of spun yarn into the annular space between the spigot and socket, and pushing it well home, and then filling the remainder of the annular space with lead, which must be well caulked.

The turned-and-bored joint is shown in fig. 122. Before inserting the spigot into the socket, it should be painted with red-lead, and then driven home while

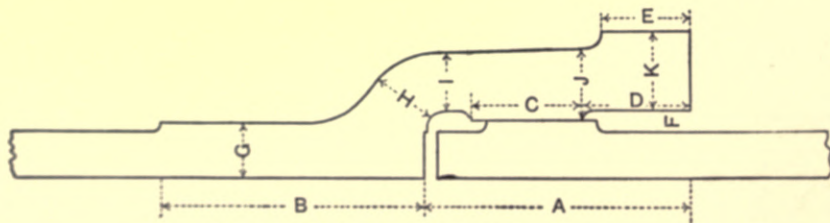

Fig. 122.—Turned-and-bored Joint in Cast-iron Pipes.

wet. The taper of the bored and turned portions should be 1 in 32. The socket is extended in order that, if any joint is found to leak, it may be run with lead and caulked. The dimensions A, B, C, D, E, and F depend upon the internal diameter of the pipe, and should be as in the following table, all the dimensions being in inches.

TABLE XVI.  
DIMENSIONS OF TURNED-AND-BORED JOINTS IN  
CAST-IRON PIPES.

Diameter of Pipe.	A	B	C	D	E	F
in.	in.	in.	in.	in.	in.	in.
2	3	3	1 $\frac{1}{4}$	1 $\frac{1}{4}$	$\frac{7}{8}$	1 $\frac{1}{4}$
3	3	3	1 $\frac{1}{4}$	1 $\frac{1}{4}$	$\frac{7}{8}$	1 $\frac{1}{4}$
4	3	3	1 $\frac{1}{4}$	1 $\frac{1}{4}$	$\frac{7}{8}$	1 $\frac{1}{4}$
5	3 $\frac{1}{2}$	3 $\frac{1}{2}$	1 $\frac{3}{8}$	1 $\frac{3}{8}$	1	3 $\frac{3}{8}$
6	3 $\frac{1}{2}$	3 $\frac{1}{2}$	1 $\frac{3}{8}$	1 $\frac{3}{8}$	1	3 $\frac{3}{8}$
7	3 $\frac{1}{2}$	3 $\frac{1}{2}$	1 $\frac{3}{8}$	1 $\frac{3}{8}$	1	3 $\frac{3}{8}$
8	4	4	1 $\frac{5}{8}$	1 $\frac{5}{8}$	1 $\frac{1}{8}$	3 $\frac{3}{8}$
9	4	4	1 $\frac{5}{8}$	1 $\frac{5}{8}$	1 $\frac{1}{8}$	3 $\frac{3}{8}$
12	4 $\frac{1}{4}$	4 $\frac{1}{4}$	1 $\frac{3}{4}$	1 $\frac{3}{4}$	1 $\frac{1}{4}$	3 $\frac{3}{8}$

The thicknesses G, H, I, J, and K should depend upon the thickness of the body of the pipe, and should be as in the following table, all the dimensions being in inches.

TABLE XVII.  
THICKNESSES OF METAL IN TURNED-AND-BORED  
JOINTS IN CAST-IRON PIPES.

Thickness of Pipe.	G	H	I	J	K
in.	in.	in.	in.	in.	in.
$\frac{3}{8}$	$\frac{1}{2}$	$\frac{3}{4}$	$\frac{5}{8}$	$\frac{11}{16}$	$\frac{7}{8}$
$\frac{7}{16}$	$\frac{9}{16}$	$\frac{13}{16}$	$\frac{11}{16}$	$\frac{3}{4}$	$\frac{15}{16}$
$\frac{1}{2}$	$\frac{5}{8}$	1	$\frac{3}{4}$	$\frac{13}{16}$	1 $\frac{1}{16}$
$\frac{9}{16}$	$\frac{11}{16}$	1 $\frac{1}{16}$	$\frac{13}{16}$	$\frac{7}{8}$	1 $\frac{1}{8}$
$\frac{5}{8}$	$\frac{3}{4}$	1 $\frac{1}{8}$	$\frac{7}{8}$	1 $\frac{15}{16}$	1 $\frac{3}{16}$
1 $\frac{1}{16}$	$\frac{13}{16}$	1 $\frac{3}{16}$	$\frac{15}{16}$	1	1 $\frac{1}{4}$
$\frac{3}{4}$	$\frac{7}{8}$	1 $\frac{1}{4}$	1	1 $\frac{1}{16}$	1 $\frac{3}{8}$
1 $\frac{13}{16}$	$\frac{15}{16}$	1 $\frac{5}{16}$	1 $\frac{1}{16}$	1 $\frac{1}{8}$	1 $\frac{7}{16}$
$\frac{7}{8}$	1	1 $\frac{3}{8}$	1 $\frac{1}{8}$	1 $\frac{1}{4}$	1 $\frac{9}{16}$

The depth of lead in the joint will depend upon the pressure to which the pipe is exposed, and should vary from 2 to 2 $\frac{1}{2}$  inches. If  $d$  = the internal diameter of the pipe,  $p$  = the thickness of metal of the pipe,  $t$  = the thickness of the joint, and  $l$  = the depth of the lead, all in inches, and  $w$  = the weight of the lead in the joint; then

$$w = 1.31 (d + 2p + t) l \dots\dots\dots (51)$$

Pipes with turned-and-bored joints can only be laid in straight lines. Where it is necessary that the pipes should deviate from a straight line, lead joints should be used; and in a long length of pipes with turned-and-bored joints, lead joints should be introduced at intervals to allow for the expansion and contraction caused by variations of temperature.

Pipes should be cast from the best gray metal run from the cupola, the moulds for pipes 4 inches or less in diameter being inclined at an angle of  $45^{\circ}$ ; pipes above that diameter should be cast vertical, with the sockets downward, and with an extra head of at least one foot of metal. They should be clean and perfectly sound castings, free from all flaws and defects, and of uniform thickness. The quality of the metal should be such that a bar 1 inch square, with a bearing of 3 feet, will not break with a less transverse strain than 650 pounds applied in the centre. Each pipe should be subjected to proof by hydrostatic pressure equal to double that to which the pipes will be exposed in use. Cast-iron pipes should be coated with Angus Smith's preparation to prevent corrosion.

**Wrought-iron and mild steel** are also being used for mains for the conveyance of water; these are usually made in lengths varying from 12 to 16 feet. The

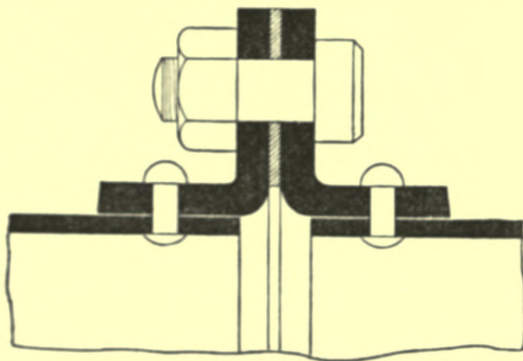

Fig. 123.—Flanged Joint for Wrought-iron and Steel Pipes

advantage possessed by wrought-iron and steel pipes is that they require a much less thickness of metal, and consequently are much lighter. They are, however, much more liable to rust and corrode; to avoid which they should be covered with a composition of pitch, tar, petroleum, linseed-oil, and chalk, or with natural asphaltum. When less than 12 inches in diameter, they are lap-welded, but above that diameter they are riveted. A great number of different kinds of joints have been patented, but one of the simplest is that shown in fig. 123, which consists of a pressed-steel flanged collar riveted to each end of the pipe, the joint being made as in the case of cast-iron flanged pipes, and secured by wrought-iron bolts. Wrought-iron pipes less than 6 inches in diameter are usually united by wrought-iron collars, a screw being cut on each end of the pipe corresponding with the screw on the inside of the collar. The screw is painted with red-lead before being put together, and is screwed up while still wet.

**Water-pipes should be laid** in a trench of sufficient depth to allow, at the least, from  $2\frac{1}{2}$  to 3 feet of earth over the top of the pipe, and where the traffic



is unusually heavy, a greater depth should be allowed. In the case of turned-and-bored joints, the trench should be sufficiently wide to allow a space of 6 inches on each side of the pipe, but when the joints are run with lead, from 9 to 12 inches will be required to enable the lower part of the joint to be properly caulked. Where the ground is loose, the sides of the trench must be supported by poling boards; in the case of rock, the trench should be excavated a few inches deeper, and a bed of earth well punned should be formed at the bottom of the trench, upon which the pipes should be laid. The trench should be filled with great care so as to avoid injuring the pipes, the earth being deposited in thin layers, each carefully punned.

Where the pipes follow the undulations of the surface, care must be taken to provide for the escape of the air which would otherwise collect in the upper parts of the pipes, and check or stop the flow of water.

The valve which is used for this purpose, is shown in fig. 124. It consists of a ball of vulcanized india-rubber, which, when in the position shown, allows the air to escape, but as soon as the whole of the air has been expelled, the ball floats into the position shown by the dotted line, and closes the opening. The valve should be fixed at the highest part of the pipe.

At the lowest point of the main, a sluice-valve should be placed upon a branch-pipe, to enable any deposit which may have accumulated in the pipe to be scoured out; the pipe leading from the scour-valve should discharge into some ditch, water-course, or drain.

When a district, in which there is a considerable variation of level, is supplied from an elevated tank or reservoir, it will be necessary in the lower parts of the district, where the pressure would become excessive, to reduce the pressure; and this is effected by means of a **reducing-valve**, a section of which is shown in fig. 125. A is an equilibrium-valve, that is to say, a valve which is not affected by variations in the pressure of the water; upon the same spindle as the equilibrium-valve, a solid piston B is fixed, which works in a cylinder C, and is only exposed to pressure on its lower side. The spindle is carried through the cover of the valve, and is loaded with weights D, so adjusted as to balance the required reduced pressure upon the surface of the piston B; the high-pressure water enters at E, but cannot escape if the equilibrium-valve is closed. Under these circumstances, there being no pressure upon the piston B, the weight D causes it to descend and open the equilibrium-valve A, when the water flows

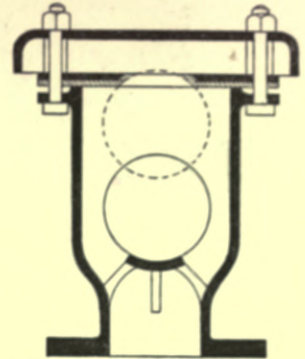

Fig. 124.—Air-valve for Water-pipes.

onwards at the reduced pressure; if this pressure exceeds that to which the weight has been adjusted, the piston B is forced upwards, partially closing the equilibrium-valve, and thus reducing the pressure.

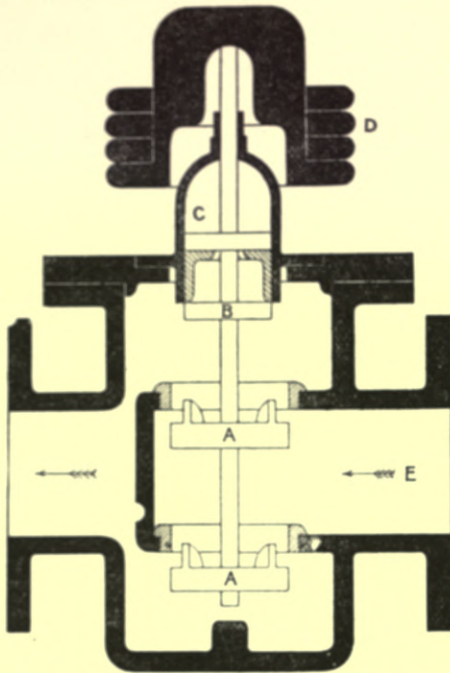

Fig. 125.—Section through Equilibrium Reducing-valve.

Another very simple contrivance for reducing the pressure in a main, is shown in fig. 126. It consists of a wedge-shaped valve A, suspended on centres; its weight makes it tend to hang vertically, but the pressure of the water behind it causes it to assume an inclined position, as shown by the dotted lines, partially closing the opening B by which the water escapes into the pipe beyond the valve, thus reducing the pressure.

Sluice-valves, to check or entirely stop the flow of water in mains, should be introduced at intervals. A section of such a valve is shown in fig. 127; the valve, and the surfaces against which it bears, should be faced with gun-metal. The stuffing-box, through which the spindle for opening or closing the valve passes, should be perfectly water-tight. A manhole should be constructed of concrete around the valve, with a cast-iron manhole cover, so as to allow of easy access to the valve.

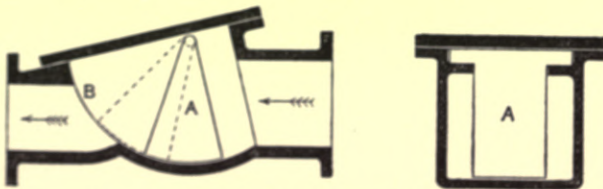

Fig. 126.—Longitudinal and Transverse Sections through Simple Reducing-valve.

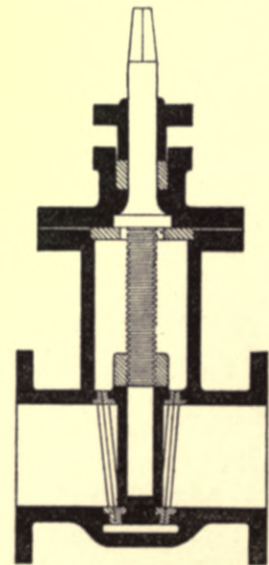

Fig. 127.—Section through Sluice-valve.

For the purpose of supplying water for extinguishing fires, or for watering roads, gardens, &c., a valve termed a **hydrant** is placed upon a branch-pipe connected with the main; a section of a hydrant is shown in fig. 128. In the case of fire, it is of the utmost consequence that the valve should be opened as

rapidly as possible, with which object the hose is usually connected to the hydrant by a bayonet-joint. In towns it is usual to place hydrants upon the mains at intervals varying from 50 to 100 yards. In the case, however, of isolated houses, a pipe not less than 6 inches in diameter should be carried round the building, and hydrants placed at the corners, or other points so situated as best to command the building; and in the case of large buildings, branch-pipes should be carried into the interior, and hydrants placed on every floor, with a hose coiled or flaked in a cupboard adjoining, so as to be available on the shortest notice.

When water is being discharged from the lower end of a main, the available pressure will be reduced by that required to force through the pipe the quantity of water being discharged. If  $l$  = the length of the pipe in feet,  $d$  = the diameter of the pipe in feet,  $H$  = the difference of

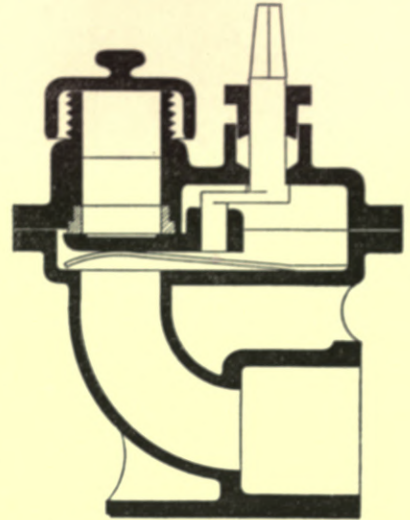

Fig. 128.—Section through Hydrant-valve.

level in feet of the water at the two extremities of the pipe,  $q$  = the discharge in cubic feet per minute,  $e$  = a coefficient whose value is 2662 in the case of a clean iron pipe and 1885 in the case of a rusted pipe, and  $p$  = the pressure in pounds per square inch at the lower end of the pipe; then

$$p = 0.434 \left\{ H - q^2 \frac{l (d + 0.0833)}{e^2 d^6} \right\} \dots \dots \dots (52)$$

The discharge from a hydrant for the purpose of fire-extinction should not be less than 120 gallons, or say 20 cubic feet, per minute. The nozzle attached to the hose should be in the form of the *vena contracta*, as shown in fig. 129. In order to ascertain the pressure at the nozzle, the loss of pressure resulting from the friction of the water passing through the hose must also be taken into account. Let  $l_1$  = the length of the hose in feet,  $d_1$  = the diameter of the hose in feet,  $q_1$  = the discharge from the nozzle in cubic feet

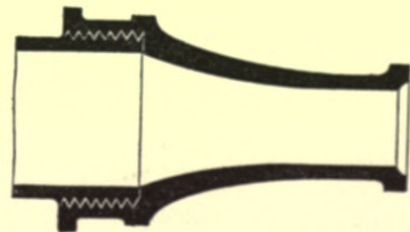

Fig. 129.—Section through Hose-nozzle.

per minute,  $e = 2662$ , and  $p_1$  = the pressure in pounds per square inch at the nozzle; then

$$p_1 = p - 0.434 \frac{q_1^2 l_1 (d_1 + 0.0833)}{e^2 d_1^6} \dots \dots \dots (53)$$

In the above formula (53), it is assumed that the nozzle is at the same level as the lower end of the main; if this is not the case, the difference of level in feet, multiplied by 0.434, must be deducted from or added to  $p_1$  according as the level of the nozzle is above or below that of the main.

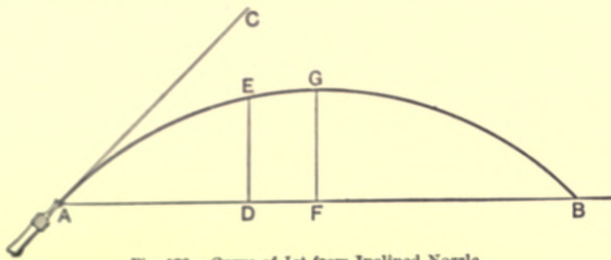

Fig. 130.—Curve of Jet from Inclined Nozzle.

The jet discharged from a nozzle which is inclined to the vertical, will describe a curve as shown in fig. 130. If  $\alpha$  = the angle CAB, which the jet as it leaves the nozzle makes with the horizon,  $\delta$  = the horizontal distance AD (in feet) of any point D, and  $h$  = the vertical height DE (in feet) of the jet at this distance from the nozzle; then

$$h = \delta \tan \alpha - \frac{0.115 (\delta \sec \alpha)^2}{p_1} \dots\dots\dots(54)$$

If  $r = AB$ , the maximum range in feet; then

$$r = 8.7 p_1 \cos \alpha \sin \alpha \dots\dots\dots(55)$$

and the maximum height  $h_1 = FG$ , will be

$$h_1 = 2.175 p_1 \sin^2 \alpha \dots\dots\dots(56)$$

when  $\delta$  is greater than half  $r$ , we have

$$h = (r - \delta) \tan \alpha - 0.115 \frac{\{(r - \delta) \sec \alpha\}^2}{p_1} \dots\dots\dots(57)$$

## CHAPTER VI.

### THE PURIFICATION OF WATER.

Water in its natural state is never pure; it always contains foreign matter, and the wholesomeness of the water depends upon the *quality* and *quantity* of such foreign matter. Water is only said to be *polluted* when either the quality or quantity of the foreign matter, which it contains, is such as renders it unwholesome or unsuited for domestic purposes. Foreign matter exists in water in four forms, namely, as solids in *suspension*, solids in *solution*, gases in a state of absorption, and living organisms. Water may, and usually does, contain foreign matter in each of these forms, and yet may be perfectly wholesome. *Pure*

water is very insipid, and not so suitable for domestic use as a water which contains a certain proportion of solids in *solution* and of gases; but all matter in *suspension* should be removed, and as many of the living organisms as possible.

**In order to determine the suitability of any water for domestic use**, it should be examined with reference to its clearness or turbidity, its colour, smell, and taste, and also the number and nature of the organisms which it contains. To test its smell, it should be warmed and shaken in a bottle half filled. The colour should be judged by observing a white surface through a column of the water two feet high. Pure water has a slightly *blue* tint; a *green* or *yellow* tint indicates vegetable or animal matter, a *brown* tint indicates peat, and a *reddish* tint shows the presence of iron. For chemical and bacteriological examination, a sample should be collected in a Winchester quart stoppered bottle, the bottle being rinsed out with the same water two or three times, and then perfectly filled. This sample should be subjected to chemical analysis and bacteriological examination, full particulars being supplied to the analyst as to the source of the water.

The amount of solid matter in *suspension* in water is only of importance as affecting the trouble and expense of filtration, by which means the whole of it should be removed previous to the water being used.

The quantity and quality of the matters in *solution*, and the characteristics of the source from which the water is obtained, are the important matters to be considered in determining the suitability of the water for domestic use. The matters in solution may be divided into organic and inorganic. The organic matters are composed of carbon, hydrogen, and nitrogen; the relative proportions of carbon and nitrogen indicating whether the organic matter is of vegetable or animal origin. The inorganic or mineral matters chiefly consist of carbonates and sulphates of lime and magnesia. The gases usually found in water are oxygen, nitrogen, and carbonic acid.

**The living organisms or bacteria** may vary from half a dozen to two millions per cubic centimetre, and Koch considers that wholesome drinking-water should not contain more than 100 in a cubic centimetre. Microscopical investigation has discovered a very great variety of these bacteria, and, while the greater number of them are believed to be harmless, a few have been found to be *pathogenic*, that is, capable of producing specific diseases, such as cholera and typhoid fever.

**Matter in suspension may be removed by straining, settlement, and filtration.** Water derived from a river or stream should be subjected to each of these operations; it should be strained at the intake to arrest floating leaves and

other rubbish, and the coarser matters in suspension; it should then be passed into reservoirs or settling-ponds, where it should be kept in a state of perfect quiescence, to allow as much as possible of the matters held in suspension to subside, after which it should be subjected to filtration. By thus allowing the water to be clarified as far as possible by subsidence, the filtration will be carried on much more rapidly, and the filter will remain in an efficient state for a much longer time. The extent of the settling-ponds, and the time required for subsidence, must depend upon the amount of turbidity in the water. In the case of rivers liable to floods, the settling-ponds should be of ample size. The clear water should be drawn off from the settling-pond by means of a floating arm,

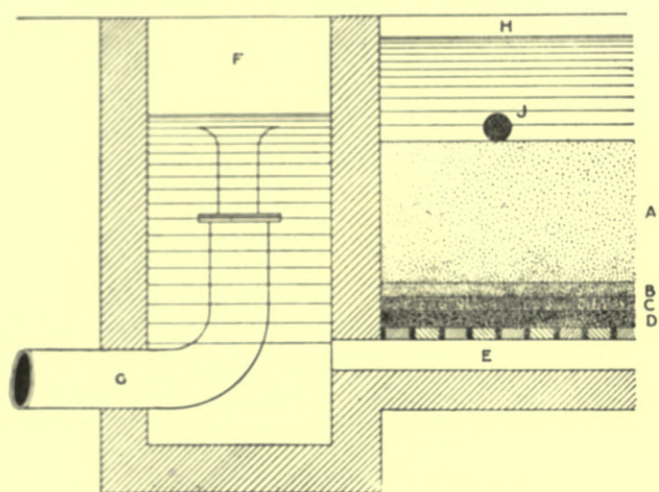

Fig. 131. —Section of Sand Filter and Outlet-chamber.

which takes the water only from the surface. The water should not be drawn down lower than a foot or eighteen inches from the bottom, so as to avoid disturbing the sediment.

The material generally used for the artificial filtration of water for domestic use is sand. Fig. 131 is a vertical section of a sand filter; it consists of a bed, A, 3 feet in thickness, of clean, sharp sand, the grains of which are about one-fiftieth of an inch in diameter; this rests upon a layer of sand, B, 3 inches in thickness, the grains of which are one-twentieth of an inch in diameter; the next layer, C, is composed of sand 3 inches in thickness, the grains being one-quarter of an inch in diameter; and the lowest layer, D, consists of a bed of gravel 6 inches in thickness, varying in diameter from three-quarters to one inch. The floor of the filter is covered with bricks with open joints, so disposed as to form a series of channels or drains, E, through which the filtered water finds its way to the chamber or well, F, from which it flows through the pipe, G, to the storage-reservoir. The upper part of the pipe, G, is telescopic, capable of sliding up and down, for the purpose of adjusting the difference of level of the water in the filter, H, and the well, F, which difference forms the working head, producing the pressure which forces the water through the filter.

At first the water passes very freely through the filter, and is very imper-

fectly filtered; but gradually a slime forms upon the upper surface of the sand, and becomes the chief filtering medium, the filtration becoming more and more perfect as this slime increases in thickness. As this takes place, however, it becomes necessary to increase the working head, or difference of level of the water in the filter and the well. This difference of level should not exceed two feet, and, when this is reached, the slime, and an inch or two of the sand, should be removed, and an upward stream of water should be sent through the filter to wash out the matter deposited in the pores of the sand; the water so used for cleansing the filter is allowed to run to waste through a pipe, J, provided for that purpose. There should be another waste-pipe at the level of the bottom of the filter, to allow the water to be drawn off when required. A separate pipe should be taken from each filter, so that a sample of the filtered water can be taken from time to time, for examination and analysis.

The drains at the bottom of the filter should be ventilated by means of pipes in the side walls of the filter. The supply of water to the filter should be so regulated as to be constant. The minimum depth of water in the filter above the sand should be 2 feet. The number of filter-beds, and their size, will depend upon the quantity and quality of the water to be filtered. Koch considers that not more than 4 inches in depth of water should be passed through a sand filter (such as that described) in one hour. This would require 20 square feet of filter for every 1000 gallons per diem. The number of filters should never be less than two, so that one can always be in use while the other is being cleaned. Where the quantity of water to be filtered is considerable, it is economical to have several filter-beds. No filter should exceed in size 30,000 square feet.

**Natural filtration** has been successfully adopted in some cases; that is to say, allowing the water to pass through a certain thickness of suitable porous soil. This is usually effected by constructing an underground gallery parallel to the shore of a river or lake, at such a level below the same as will cause the water to percolate through the soil into the gallery. Toulouse is supplied in this manner from the river Garonne; the sediment which is deposited on the bed of the river by the water which escapes into the gallery is constantly being washed away by the current of the river.

**The Fischer system of water-filtration** has been for some time in successful operation at Arad in Hungary, and at Worms and other towns on the Rhine. The water is filtered by passing through hollow plates, 1 metre square and 8 inches in thickness, composed of sand, glass, and silica, burnt at a temperature of about 2000° Fahr., each plate presenting a filtering surface of 21½ square

feet. They are immersed in the water to be filtered, in a vertical position, side by side, a few inches apart; pipes are laid along the top of each row of filter-plates connected with the hollow space in the centre of the plate, and the filtration is effected by the water passing through the substance of the plate into this hollow space. The impurities in the water are arrested upon the outside of the plates, and are easily removed by washing the outer surfaces. The plates occupy about one-eighth of the space required by sand filters of equal capacity; and it is stated that their first cost and working expenses are less. An installation to filter 7,700,000 gallons in twenty-four hours is now in course of construction at Wienthal waterworks, Vienna. This system appears to be very suitable for small installations for domestic water-supply.

Another form of filter which is being used for filtering water for supply upon a large scale, is the **Pasteur-Chamberland filter**. This consists of tubes of porous porcelain, through which the water to be filtered is forced by pressure; the water passes from the outside inwards, leaving the impurities on the outside of the tubes, which can be easily cleansed, and the tubes can be sterilized from time to time by heating them to redness. An installation has been established at Darjeeling in India for the municipal waterworks, consisting of 38 cells, each of which contains 250 Pasteur filter-tubes. This installation is capable of delivering 150,000 gallons per day.

Up to the present we have only been dealing with matters in *suspension*. We now come to consider those in *solution*. **Matter in solution may be removed by filtration, aëration, precipitation by reagents, and distillation.** *Filtration* in this connection is used in a somewhat different sense from the filtration which is employed to remove the foreign matters in suspension in the water. Filtration in the latter sense removes suspended matters by straining them out, and is *continuous* in its action. On the other hand, the filtration by means of which the organic impurities in water are removed is *intermittent* in its action, and really consists in decomposing the organic matter, which would in its then state be deleterious to health, by the agency of bacteria known as *nitrifying organisms*. The filter must consist of some granulated material, the particles of which shall form a *nidus* for the bacteria, and the spaces between which shall be filled with air. Under these conditions, upon passing water containing organic matter through the filter, the organic matter is devoured by the bacteria, and is ejected in the form of carbonic acid and ammonia; other species of bacteria convert the ammonia into nitrous acid, which is again further changed into nitric acid, and these acids, uniting with the mineral or inorganic matters contained in the water, produce harmless nitrites and nitrates. These bacteria are present in almost all



soils, and it is requisite that they should be supplied with sufficient oxygen, and not exposed to light, and that the water should be either alkaline or neutral. In order to afford the requisite supply of oxygen, it is necessary that the use of the filter should be intermittent. After a certain amount of water has been passed through the filter, it is allowed to drain off, drawing air into the pores of the filter, and thus supplying it with the oxygen required.

The number of these organisms in the soil decreases rapidly as the depth increases, chiefly in consequence of the absence of oxygen and organic matter, which constitute their food. Even the *anaërobic* bacteria, which subsist without oxygen, rarely extend beyond 12 feet from the surface, there being below that depth an insufficient supply of organic matter for their sustenance. Deep-well waters are consequently almost entirely free from them. By careful sand filtration, 98 per cent of the bacteria may be removed. On the other hand, the water in rivers, which are chiefly supplied by water running off the surface of the land, usually contains a very large number of bacteria; by the mere storage of the water, a very great reduction in the number takes place, the bacteria being carried down with the sediment. Dr. Percy Frankland found that "at the West Middlesex Company's works, the Thames water at the intake contained 1437 bacteria per cubic centimetre, whilst after passing through one storage reservoir the number present was only 318, and after passing through a second reservoir it had fallen to the astonishingly low figure of 177 per cubic centimetre". The quality of filtered and deep-well water, however, deteriorates by storage. Dr. Woodhead observes: "If a sample of even the purest water (containing, say, 200 germs per cubic centimetre) be left to stand in a room, in which the temperature is comparatively high and therefore suited for rapid growth of these organisms, it may be found that in place of 200 germs per cubic centimetre there may be present on the second day 5000, on the third day 20,000, whilst on the fourth, as pointed out by Carl Fraenkel, they are almost innumerable".

**Purification of water by aëration** is only another form of nitrification, and is due to the presence of the nitrifying organisms; the most notable instance is that afforded by the self-purification of running streams and rivers. In a paper recently read before the Institution of Civil Engineers by Dr. Percy Frankland, on the "Bacterial Purification of Water", he instances the river Dee. Above Braemar the river contained only 88 microbes in 1 cubic centimetre; after receiving the sewage of Braemar the number was increased to 2829; after flowing on to Ballater the number was reduced to 1139; upon receiving the sewage of Ballater the number rose to 3780, but had fallen to 938 on reaching

the Neil Burn, the sewage from which, however, increased the number to 1860, which decreased again to 950 microbes in the cubic centimetre at Invercarnie. The total distance from Braemar to Invercarnie is only 40 miles.

**Light, and especially sunshine, is inimical to bacterial life**, and therefore it has been suggested that reservoirs for the storage of water should not be covered. Procaccini, however, found that the bactericidal action of the sun's rays was confined to a very moderate depth. He exposed water containing bacteria in a vessel, 50 centimetres or 20 inches in depth, to bright sunshine for three hours, with the result that the number of microbes per cubic centimetre at the surface was reduced from 3103 to 9, at a depth of 10 inches from 3021 to 10, and at the bottom from 3463 to 2115. It is therefore evident that very little advantage is gained by leaving the storage-reservoir uncovered; while by covering it, the many microbes, impurities, and dust, which are always present in the atmosphere, will be excluded, and, furthermore, the growth of algæ, which cannot exist without light, will be prevented. These algæ render the water green, and impart to it an unpleasant fishy odour and taste.

After the matters in suspension have been removed, and the bacteria reduced in number as far as possible by subsidence, filtration, and aëration, there yet remain in the water the **foreign matters in solution**, the following classification of which is taken from Rideal's *Water and its Purification*:—

#### CLASSIFICATION OF DISSOLVED MATTERS IN WATER.

ORGANIC SOLIDS.	{	Peaty and other vegetable matter; urea and other constituents of excreta and animal fluids; albuminoid substances; products of putrefaction, as alkaloids (ptomaines) and amido-acids; phenol and its derivatives; with waste products from factories, such as fat, soap, oils, tar, colouring matters, &c.; sulphocyanides; and benzene from gas-works.						
INORGANIC OR MINERAL SOLIDS.	{	<table border="0" style="margin-left: 2em;"> <tr> <td style="vertical-align: middle;">Usual, (harmless unless quantity excessive).</td> <td style="font-size: 3em; vertical-align: middle;">{</td> <td>Carbonates, chlorides, sulphates, nitrates of calcium, magnesium, sodium, potassium, iron, aluminium; silica and phosphates, with minute traces of other bodies and small quantities of ammonium salts.</td> </tr> <tr> <td style="vertical-align: middle;">Occasional, (generally extraneous and noxious).</td> <td style="font-size: 3em; vertical-align: middle;">{</td> <td>Nitrates; poisonous metals: lead, iron (in excess), copper, zinc, arsenic, manganese, barium, strontium; medicinal salts containing iron, iodine, bromine, silica, boron, lithium, &amp;c.; products of manufacture: mineral acids, alkalis, and salts.</td> </tr> </table>	Usual, (harmless unless quantity excessive).	{	Carbonates, chlorides, sulphates, nitrates of calcium, magnesium, sodium, potassium, iron, aluminium; silica and phosphates, with minute traces of other bodies and small quantities of ammonium salts.	Occasional, (generally extraneous and noxious).	{	Nitrates; poisonous metals: lead, iron (in excess), copper, zinc, arsenic, manganese, barium, strontium; medicinal salts containing iron, iodine, bromine, silica, boron, lithium, &c.; products of manufacture: mineral acids, alkalis, and salts.
Usual, (harmless unless quantity excessive).	{	Carbonates, chlorides, sulphates, nitrates of calcium, magnesium, sodium, potassium, iron, aluminium; silica and phosphates, with minute traces of other bodies and small quantities of ammonium salts.						
Occasional, (generally extraneous and noxious).	{	Nitrates; poisonous metals: lead, iron (in excess), copper, zinc, arsenic, manganese, barium, strontium; medicinal salts containing iron, iodine, bromine, silica, boron, lithium, &c.; products of manufacture: mineral acids, alkalis, and salts.						
GASES.	{	<table border="0" style="margin-left: 2em;"> <tr> <td style="vertical-align: middle;">Normal—Oxygen, nitrogen, carbon dioxide.</td> </tr> <tr> <td style="vertical-align: middle;">Abnormal—Sulphuretted hydrogen, sulphur dioxide, ammonia, &amp;c.</td> </tr> </table>	Normal—Oxygen, nitrogen, carbon dioxide.	Abnormal—Sulphuretted hydrogen, sulphur dioxide, ammonia, &c.				
Normal—Oxygen, nitrogen, carbon dioxide.								
Abnormal—Sulphuretted hydrogen, sulphur dioxide, ammonia, &c.								

**Water intended for domestic supply** should not contain more than 0·02 parts of organic nitrogen, or more than 0·20 parts of organic carbon, in 100,000 parts; and the proportion of the nitrogen to the carbon should not

exceed 1 to 7. In many cases where the water is collected from the surface, the organic matter will chiefly consist of peat, which is not objectionable unless in excessive quantity; but such water is very active in dissolving lead, and may therefore be a source of grave danger.

The nature and amount of the inorganic or mineral matter contained in the water will depend upon the source of supply, and should not exceed 70 grains per gallon. The chief ingredients are usually carbonates and sulphates of lime and magnesia, which, if in considerable amount, are liable to produce constipation and dyspepsia; while, on the other hand, sulphate of soda has a purgative effect. Chloride of sodium, or common salt, is usually found in water, and, unless otherwise accounted for, is an indication of previous sewage-contamination. Silica is also frequently met with in water, and it has been stated that its presence prevents the water dissolving lead. Iron is also frequently present in water, and renders the water unsuited for washing purposes.

The amount of different gases which water is capable of dissolving varies very greatly; thus, it will dissolve rather more than its own volume of carbonic acid gas, while it will only dissolve about 3 per cent of oxygen and  $1\frac{1}{2}$  per cent of nitrogen. These are the gases which are most frequently found in water.

**The quality of hardness in water** is produced by the presence of salts of lime and magnesia. It is measured by Dr. Clark's scale, each unit of which is equivalent to the hardness produced by 1 grain of carbonate of lime per gallon of water. The most usual salts which produce the quality of hardness in water are the carbonates and sulphates of lime and magnesia. The hardness produced by the carbonates is termed *temporary* hardness, because it is removed by boiling the water, the carbonic acid being expelled and the lime and magnesia being precipitated. The hardness resulting from the presence of the sulphates of lime and magnesia is termed *permanent* hardness, because it cannot be removed by boiling. If the permanent hardness exceeds 5°, the water is considered a *hard* water.

**The effect of hardness in water** is to cause a very unnecessary waste of soap, as, before the soap can act as a detergent, the hardness must be reduced in the water by a sufficient quantity of the alkaline soap being dissolved to neutralize the acids. Each degree of hardness removed, wastes one pound of the best hard soap for every 830 gallons of water. It is estimated that the saving in soap alone in Glasgow from the introduction of a soft water-supply from Loch Katrine, amounts to £36,000 per annum. Not only does hard water occasion a waste of soap, but it renders the water very unpleasant for washing, producing

roughness of the skin. It also causes deposit of lime in boilers and in utensils used for boiling water, and in hot-water pipes.

**Dr. Clark's process for removing the temporary hardness** of water consists in the addition of lime. The lime in the water is in the form of a bicarbonate, which, being soluble, is held in solution in the water; by the addition of more lime, the bicarbonate is reduced to the form of a carbonate, which, being insoluble, is precipitated. The result is expressed chemically thus—

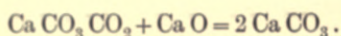

For most purposes it is sufficient to **remove the temporary hardness** only, and this can be effected by the addition of lime, the quantity of lime required to soften 700 gallons of water being 1 ounce for each degree of hardness.

When, however, it is desired to **reduce the permanent hardness**, other chemicals must be added. At the Taff Vale Railway Company's works at Penarth, near Cardiff, the hardness of the water is reduced from 18° to 6° by the addition of 112 pounds of lime, 25 pounds of soda, and 5 pounds of alum, to each 50,000 gallons of water.

To carry out the process of softening water in a satisfactory manner, it is necessary that the following conditions should be fulfilled, namely:—

1. The substances to be added should be *perfectly dissolved* before being mixed with the water to be softened, so that they may be presented to the substances to be reacted upon in the most finely divided state possible, as this is necessary to ensure perfect chemical action.

2. The substances so added should be neither in excess of, nor wanting in, the due proportion required to react upon the substances contained in the water to be softened.

3. It is important (as was pointed out by Dr. Clark) that the lime or lime-water—that is, the softening ingredient—be put into the vessel first, and the hard water gradually added, because there is thus an excess of lime present up to the very close of the process, and this circumstance is found to render the precipitation of the carbonate of lime produced in the process more easy.

4. Means must be employed to remove from the water the insoluble compounds resulting from the chemical reaction; and this may be effected in one of two ways, namely, by subsidence, or by filtration.

Plate VII. illustrates **an installation for softening water** for the supply to the mansion, stables, and farm at Luton Hoo. The water is raised by the pumps, A, from a deep well sunk in the chalk, and is delivered into one or other of three covered tanks, B, C, and D, according to the position of a three-way

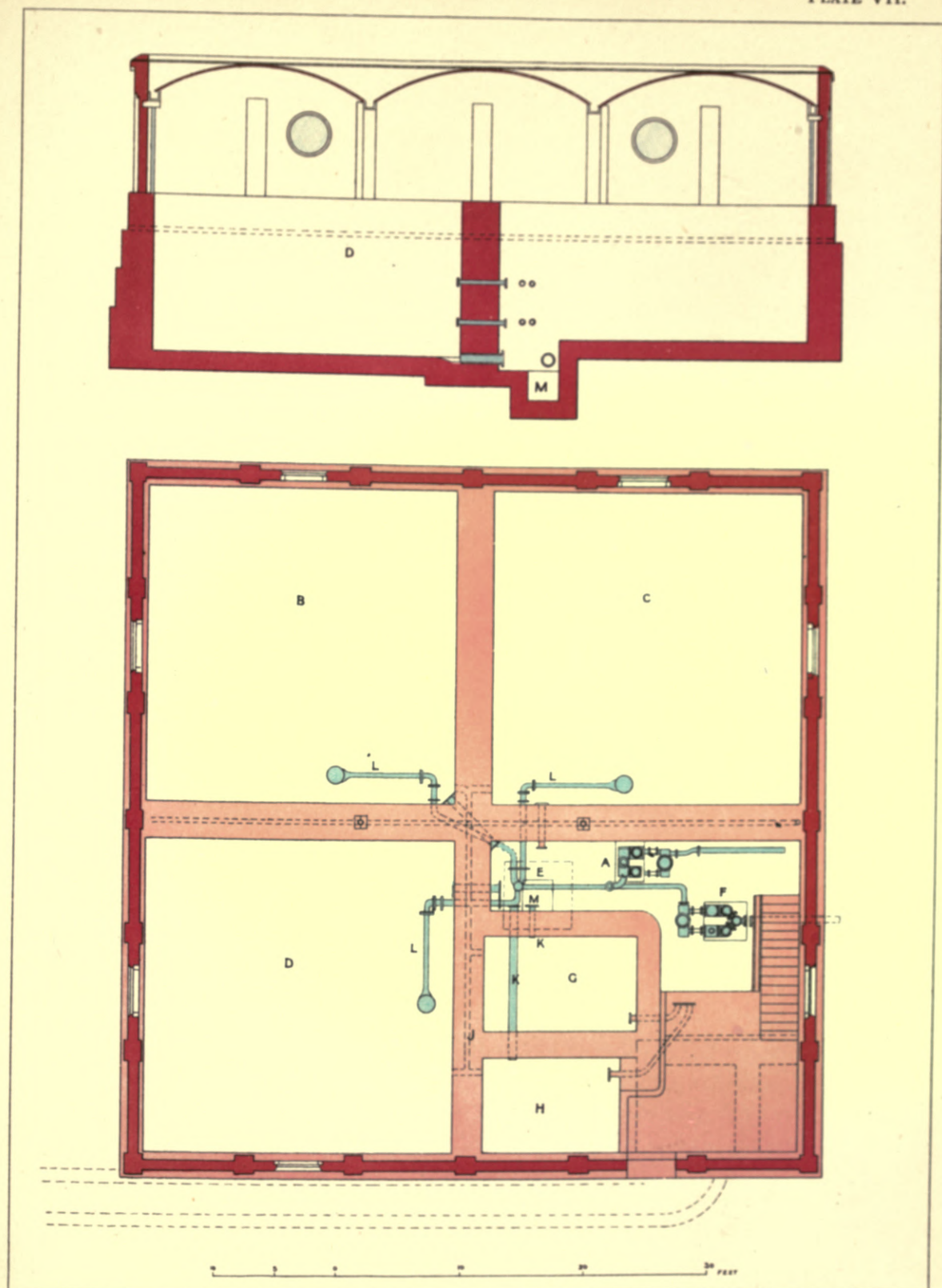

PLAN AND SECTION OF THE WATER-SOFTENING INSTALLATION AT LUTON HOO.

- A, Pumps for raising water from deep well.
- B, C, D, Tanks for water—natural, in process of clarification, and clear.
- E, Three-way valve.
- F, Pumps for forcing water to mansion.
- G and H, Tanks for saturated solution of lime.

- J, Channels for conveying softened water to the lime-tanks.
- KK, Pipes for conveying lime-water to tanks for softening water.
- LL, Floating arms for drawing off the water.
- M, Pit for sediment.



valve, E. While one of these tanks is being filled with the water to be softened, the next contains the water which has been softened, and in which subsidence is taking place, and the third contains clear water, which is then raised by the pumps, F, to the mansion. The water at Luton Hoo has  $18\frac{1}{2}$  degrees of hardness, of which about  $14\frac{1}{2}$  degrees are removed by the addition of  $1\frac{1}{4}$  pounds of lime to 1000 gallons of water, the hardness being chiefly due to the presence of carbonate of lime. The lime is first mixed in one of Michele's liming machines, and is converted into a smooth cream of lime. There are two smaller tanks, G and H, in which the cream of lime is diluted with softened water, so as to form a *saturated solution* of lime. Water will only dissolve about  $\frac{1}{750}$  of its weight of lime, and to ensure saturation an excess of lime is admitted to the tanks, and the contents are violently agitated by a screw, made to revolve rapidly in a short tube. These tanks are in duplicate, to allow of the perfect subsidence of the excess of lime in one, while clear lime-water is being supplied from the other.

As the lime-water contains a known quantity of lime in each gallon, and the respective areas of the lime-water tanks and the softening tanks are known, the admission of the right quantity to soften the contents of a tank of hard water is determined by the depth of lime-water run off, 2.55 inches of lime-water being run into each softening tank for every foot in depth of hard water which has been pumped into the same. Channels, J, are formed in the walls which separate the tanks, through which softened water is conveyed to the lime-water tanks, and  $\kappa \kappa$  are pipes through which the lime-water is drawn off into the particular tank in which the water is next to be softened. The requisite quantity of lime-water is first run into the tank, and then hard water is pumped into it; the agitation thus produced disturbs the carbonate of lime, which has been precipitated in a finely crystalline state from the water previously softened, and which in its subsequent subsidence materially assists the process of precipitation. The time required for perfect clarification is about six hours, and as each tank delivers 35,000 gallons of softened water, the plant at Luton Hoo is capable of softening 70,000 gallons per day. Both the lime-water and the softened water are drawn off by means of floating arms, L, and the softened water is only drawn to 18 inches from the bottom of the tank. The deposit is allowed to accumulate until it has attained a thickness of 3 or 4 inches, when it is run off into a pit, M, whence it is raised by a pump, carted away, and used as a top-dressing for the land. The whole of the machinery is driven by a turbine, and there is an automatic arrangement which stops the deep-well pumps, A, as soon as the tank is full.

When the water, as in this case, is used for dietetic purposes, it is essential

that there should be **no free lime** left in the softened water. Its presence is easily detected by putting a drop of a solution of nitrate of silver at the bottom of a white tea-cup, and pouring upon it a little of the softened water, when, if there is any free lime present, a brown deposit will result. To ascertain whether sufficient lime is being used, a little lime-water should be added to some of the softened water in a test-tube, when, if there is a deficiency of lime, a cloudiness will be produced.

The method of softening water above described is open to the objection that it is *intermittent*, and that the tanks require a considerable space; and a large number of apparatus have been contrived by Howatson, Porter, Doulton, Mather and Platt, Atkins, Maignen, and others, **to render the process continuous**. But in all these apparatus the difficulty is to ensure the continuous and uniform mixing, in due proportions, of the water to be softened and the softening ingredients, conditions which are *absolutely essential* where the water is to be used for dietetic purposes. For these reasons, while these various apparatus are well adapted for softening water for manufacturing purposes, they are not suitable for a domestic water-supply.

According to Dr. Percy Frankland, the process of softening water, if properly conducted, will remove 98 per cent of the **bacteria** which the water contains.



SECTION IV.  
DOMESTIC WATER-SUPPLY

BY

HENRY CLAY

FIRST HONOURS IN PLUMBING, CITY AND GUILDS OF LONDON INSTITUTE; REGISTERED INSTRUCTOR IN PLUMBING  
AUTHOR OF "PRACTICAL PLUMBING", "HOT-WATER FITTING", ETC.





## SECTION IV.—DOMESTIC WATER-SUPPLY.

---

### CHAPTER I.

#### MATERIALS.

All plumbers should be well acquainted with the physical and chemical properties of the various **metals**, otherwise mistakes may be made, causing perhaps serious illness or even loss of life. In no case is the danger greater than with lead. The principal materials used by plumbers are lead, tin, copper, zinc, and the alloys—brass, gun-metal, and solder.

**1. Lead.**—Lead (Plumbum, Pb) is used by plumbers in the form of sheets and pipes, but before the metal can be manufactured into useful forms, it must be reduced to the metallic state by a process of calcination. Lead does not occur free in nature, most of it being obtained from the ore galena or lead sulphide (PbS), which generally contains silver as well as lead, in combination with sulphur. The ore is roasted in a reverberatory furnace, limestone being added to form a fusible slag with the worthless portions of the ore. During the first portion of the process, air is admitted and fumes of sulphur di-oxide (SO<sub>2</sub>) are given off, and by subsequent increased heat the lead is reduced to the state of metal. The lighter impurities are burned or skimmed off the surface, and the silver is extracted after it has been concentrated into a small portion of the lead by gradually melting or burning out the lead. The metal is first cast into pigs ready for the manufacturer of sheet-lead and pipes.

In making **sheet-lead**, the pigs are remelted and cast into blocks of sufficient size to form sheets of 3, 4, 5, or 6 lbs. to the superficial foot. These blocks are placed on a lead-rolling machine, and rolled out to the requisite length, width, and thickness. Good sheet-lead will be smooth on both sides, and all up to 6 lbs. per foot will be soft enough to be easily bent at a corner. When the inside face has a rough grained appearance, the lead will usually be considerably harder and more brittle than the smooth sheets, and should be rejected, as it is very difficult to work up a break of any depth with lead of this kind.

For **lead pipes** the pigs are melted, and the molten metal is led to the pipe-press, in which it is forced through dies by a piston actuated by hydraulic pressure, the bore of the pipe being regulated by a core and the strength or thickness by the dies. The length of the pipes varies according to the size and strength, and the uses to which they are to be put.

A knowledge of the **physical and chemical properties** of lead is essential to the architect and plumber. It is of a bluish-white colour, and can be easily cut or scratched, being soft enough to produce a mark upon paper. It is highly malleable, but not very ductile. Its specific gravity is 11.3. It melts at about 617° Fahr., and boils and passes away in fumes at white heat. The tenacity of lead is low. It is not sonorous, and is a bad conductor of heat and electricity. Its surface is slowly oxidized when exposed to dry air, but rapidly in moist air, and this oxide ( $\text{PbO}$ ) is readily attacked by weak acids such as carbonic or acetic. Lead withstands the action of concentrated acids much better than any other of the common metals, and is much used for cisterns and tanks in chemical works, but it yields to the action of dilute acids and gases to such an extent as to be entirely dissolved or corroded into holes, or converted in places into a yellowish-white powder.

**Some waters**—especially pure and soft waters, and waters containing organic acids (*e.g.* moorland waters)—have a very decided corrosive action on the lead linings of cisterns, and on the soldered seams of the copper balls of the supply-valves, the corrosion being more rapid owing to the galvanic action set up between the metals. If the seam on the copper ball is above the surface of the water, the soldered seams of the cistern are corroded at the edges, and the action once set up continues until the lead is also corroded into holes at the edges of the soldering. If there are no soldered seams, the whole surface of the lead beneath the water is attacked and dissolved. If a lead pipe is surrounded by a copper bell, and the cistern is of iron, the water will eat holes in the walls of the lead pipe.

Rain-water has a solvent action on lead, partly owing to its being acidified during its passage through the air—especially of towns,—and partly because it is free from those salts upon which we rely for protection from lead-poisoning. Rain-water cisterns lined with lead are always thickly coated with lead carbonate ( $\text{PbCO}_3$ ) up to the water-level, the upper portion being oxidized by the action of the air. All the compounds of lead are poisonous.

**Certain gases**, and especially sewer-gases, attack lead in various ways, according to their strength and dryness; some attack the whole of the exposed surface equally, and others corrode it into holes, while in many cases the lead remains intact, and the soldered seams are eaten away.

**Red-lead** is the oxide of lead ( $Pb_2O_3$ ), and is rarely used unless mixed with **white-lead** ( $2 Pb CO_3 + Pb H_2O_2$ ) or with common **putty**. The usual proportion is four parts of white-lead or putty to one part of red-lead, for the ordinary jointing of earthenware, and of slate cisterns, and for screwed joints. If too much red-lead is used, the cement crumbles to dust, losing its grip and often cracking when exposed to the action of the air.

It is customary to join slate cisterns with a mixture of red and white lead, as it makes a better joint than any other cement. The oxides of lead, however, are slightly soluble in most waters, and this fact should preclude the use of red and white lead for the joints of cisterns in which drinking-water is stored. An improvement in the method of jointing slate cisterns would be the introduction of a double joint, the inside joint to be run with Portland cement, and the outer to be made good with red-lead cement in the usual way; the water would thus be kept from contact with the poisonous compound in the outer joint. When joints are made with Portland cement alone, the leakage is always greater than with red-lead.

All compounds of red-lead, white-lead, and common putty are unsuitable for the joining of soil and waste pipes, and should never be used, as the variations in temperature and consequent slight movement of the metals, as well as vibrations, lead to cracks in the jointing materials.

**2. Tin.**—**Tin** (Stannum, Sn) is obtained from tinstone ( $Sn O_2$ ) in the same manner as lead from galena, except that a better class of coal, such as anthracite or charcoal, is used. The blocks of tin obtained from the reverberatory furnace are subjected to a further process of refining by gradually melting out the tin, leaving an impure alloy behind. English tin is said to contain traces of arsenic, as well as of copper and other metals. Tin is, next to silver, the whitest of metals. Its density is 7.3, and it melts at  $442^\circ$  Fahr. It is soft, malleable, and ductile, but possesses little tenacity. It tarnishes slightly on exposure to air, and is little acted on by dilute acids.

Tin is extensively used for coating the surfaces of iron and copper to prevent them from being oxidized by the action of the air, and from being attacked by dilute acids. It is used by plumbers in the form of sheets for drainers and sinks, and alloyed with lead as solder. Pure tin pipes are frequently adopted for the conveyance of pure or distilled water, and spirits. Tin has also been employed for lining or coating the interior of lead pipes with the object of preventing lead-poisoning, but as the coating is seldom perfect through the whole length of the pipe, galvanic action will probably be set up between the two metals, and the tin lining, instead of preventing the corrosion of the lead, may increase its

rapidity. Tin-lined iron pipes are much to be preferred. Sheet-lead is also heavily coated with tin for use in lining storage-cisterns, but such cisterns may be more easily and safely lined with sheets of pure tin. Copper hot-water cylinders, boilers, and pipes are also coated with tin, as well as all copper cooking-utensils. It is also extensively used with copper in varying proportions to form the alloys known as bronze, gun-metal, &c.

**3. Copper.**—Copper (Cuprum, Cu) occurs in the metallic state, and is also reduced from various ores. It is the only red metal. Its density is about 8.9. It is highly malleable and ductile, and is an excellent conductor of heat and electricity. It rapidly tarnishes on exposure to the air, and in damp situations acquires a green crust from the formation of the carbonate.

Some waters have a direct action on this metal, which is dissolved in the same manner as lead, but the addition of soap quickly reveals the presence of the poisonous salts of copper, by causing the water to turn green.

Sheets of copper are used by plumbers for covering roofs, and copper pipes and vessels for the conveyance and storage of water are also used, many of these being coated with tin. The tinning on the inside of copper cylinders, boilers, and pipes requires to be renewed occasionally, the periods varying with the nature of the water in contact with the metal. Tin can be easily obtained from the sediment collected from the bottom of copper cylinders, by reducing it in the flame of the blow-pipe.

**4. Zinc (Zn).**—The ore of this metal is crushed and roasted in a current of air at a high temperature, and is then mixed with coal or charcoal and strongly heated, when the metallic zinc rises in vapour and, distilling over, is received and condensed in water. Its density is from 6.8 to 7.3. At ordinary temperatures it is highly crystalline and brittle, but if heated to from 250° up to 300° it becomes quite malleable, and may be rolled into sheets. It melts at about 773° Fahr. and at red heat rises in vapour.

The plumber uses sheet-zinc for the shelling of broken slates. For lead-burning, cakes of zinc known as spelter are used as the source of hydrogen, which the metal furnishes when dissolved in dilute sulphuric acid. Zinc is extensively used for coating or galvanizing sheet-iron for roof-work, and also for coating wrought-iron cylinders, tanks, and cisterns after manufacture. Wrought-iron pipes are also coated internally and externally with it. The value of such coating is uncertain in the case of pipes, cylinders, and tanks, as it quickly disappears owing to the direct action of most waters on it, and indeed in pipes of small bore, the internal coating is seldom perfect throughout. The external coating of cylinders, tanks, and cisterns remains good for a considerable time, as it is

subjected to the action of the atmosphere only. Sheet-zinc is used in considerable quantity for the covering of roofs; the surface soon becomes coated with the oxide, which usually turns black and protects it from further change, unless when exposed to smoke, sulphur-fumes, or the rain-water of towns, when it becomes rotten, or is eaten away. Zinc is most important as an ingredient of the alloys—brass, German silver, &c.

**5. Alloys.**—The composition of the **brass** used for plumbers' fittings varies considerably, the brass-founder altering the alloy to suit the work for which the fitting is intended. The plugs of common plug-cocks are usually made of what is known as "best" brass, and the bodies of "common" brass. The best quality have **gun-metal** plugs, and "best" brass bodies. Common screw-down taps have "best" brass spindles, with "yellow" brass bodies, the best having gun-metal spindles and "best" brass bodies. Unions, ferrules, tail-pipes, and nuts are usually of "common yellow", but may be had in "best" brass and gun-metal for hot-water work. The ordinary proportions of these alloys are:

Yellow brass,	...	...	copper 60	+	zinc 40
Common "	...	...	" 66.6	+	" 33.4
Best "	...	...	" 71.4	+	" 28.6
Gun-metal,	...	...	" 90	+	tin 10.

No hard-and-fast figures, however, can be given, as the proportions are constantly varied to suit the fittings.

The action of air on these alloys is slight. Most waters act slightly, but this is more noticeable with hot water, the barrels, plugs, and seatings being slightly corroded.

**Plumber's solder** consists of two parts lead to one part tin, and is used for all kinds of "wiped" soldering. **Fine solder** is composed of equal quantities of lead and tin, and is used for seams, and joints made with the copper bit.

**Plumber's solder** is always varied to suit the work, a 2-to-1 mixture being suitable for wiping cisterns; solder a little finer—that is to say, containing rather more tin—is often used for hot-water work, and a little coarser—made by adding lead—for cold-water work and also for large jointing. If blow-pipes or soldering-lamps are used, the solder may be coarser still, the proportions varying according to the size of the joint and the quality of the tin. The flame brings up the tin to the surface, and if the solder is too rich, it is impossible to do neat work. This is true also of strap solder, for that which is suitable for floating a seam, or a flow-joint, is too fine for a ring-joint; but very little of this class of work is done now, fine solder being almost exclusively used by plumbers for tinning brass-work.

The action of dry or moist air on all solders is too slight for consideration. Some waters act upon solder, but in a peculiar way. They do not attack the whole of the surface exposed, the portion eaten or corroded being always along the outer edges, especially the bottom edge, which is considerably richer in tin than the upper edge. When this occurs it is generally found that a galvanic action, set up between the various metals and the water, is the cause, and in the case of a tinned copper cylinder in direct communication with a soldered cistern, the whole of the tinning on the inside of the cylinder will probably have disappeared before the solder is attacked. Sewer-gases will attack a fine-soldered seam, on soil and waste pipes, and corrode it away for several feet, leaving the lead untouched. A wiped joint is scarcely affected, except where small portions of tin have separated from the solder and passed through the joint; such places will have a yellowish-white powder on the surface, but in most cases the lead is corroded away long before the joint is seriously injured.

## CHAPTER II.

### COLD-WATER SUPPLY.

#### 1. PIPES AND JOINTS.

The connection of the **main supply-pipe** to the street-main is usually made, as shown in fig. 132, by means of a brass ferrule and wiped joint. If the pipe is

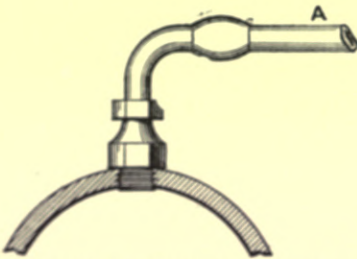

Fig. 132.—Connection of Lead Service-pipe with Iron Main.

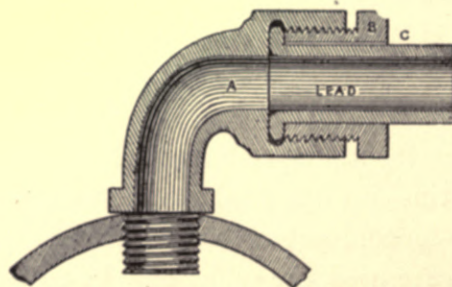

Fig. 133.—Connection of Tin-lined Lead Pipe with Iron Main.

of tin encased with lead, the connection will be as in fig. 133, which shows the pipe flanged, and the brass nut screwed up, making the joint. The pipe A, fig. 132, is usually laid by the Water Company's men, and continued to the boundary of the premises, where it is connected to the end of the pipe left by the plumber for that purpose.



When laying the main service-pipe from the street main to the building, care should be taken to avoid the plasterer's lime-pit, as pipes are soon corroded by the action of the lime with which the ground is saturated. Iron and lead suffer the most. Clay is the best bedding for all kinds of metal pipes; it appears to have no action on lead, tin, or copper, and only the usual corrosion takes place with iron buried in it.

Some water-companies fix **stop-cocks** between the street main and the building, generally in the footpath, and others cause them to be fixed just inside the boundary. Fig. 134 shows a stop-cock and box as they appear when fixed in the footpath, garden, or yard. In any case a stop-cock should be placed on the supply-pipe immediately after it enters the building, with a  $\frac{3}{8}$ -inch or  $\frac{1}{2}$ -inch bib-cock just beyond on the house side, for

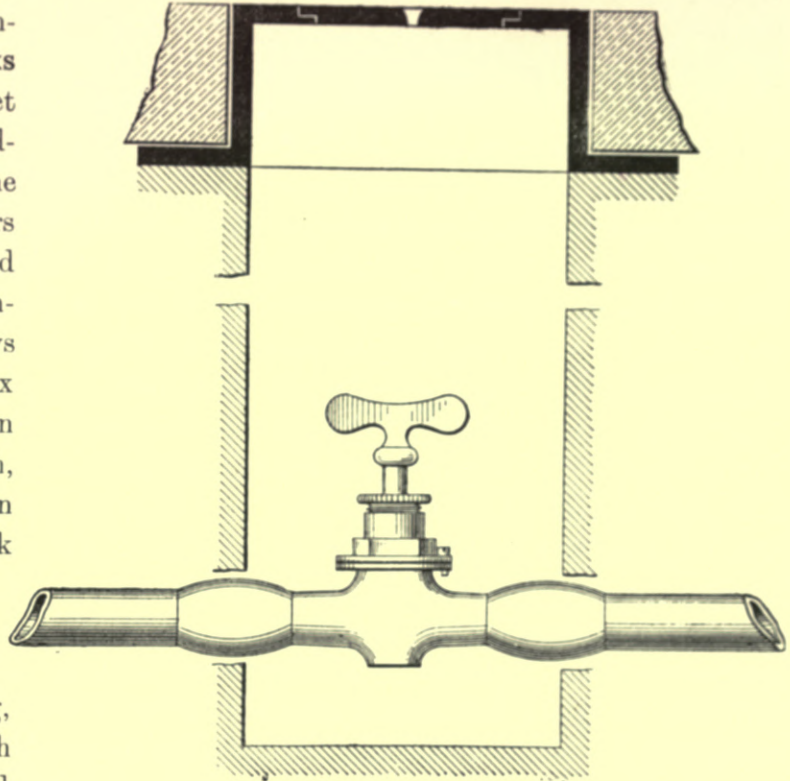

Fig. 134.—Stop-cock and Box.

the purpose of emptying the main service-pipe during frost, and so preventing the bursting of the pipes. The main service-pipe generally rises from the point at which it enters the building to the store-cistern, and can always with a little care be fixed so as to drain itself when the stop-cock is turned off, the bib-tap opened, and a little water drawn from the store-cistern so as to admit air through the ball-cock.

Houses in towns are usually rated for water according to their assessment, but in works and manufactories **water-meters** are fixed, and the water is supplied at so much per 1000 gallons. There are various kinds of water-meters. Usually the water, in passing through the meter, rotates a fan inside the case, which in turn operates the dial. Means are provided for the adjustment of the fan by a

screw and washers, which are afterwards sealed. Some meters are capable of registering at high, low, or varying pressures.

**Lead pipes** are used for main supplies, and also for cold-service pipes, according to the regulations of the water-authorities. They are classified according to their diameter and weight per yard. The weights demanded by different water-authorities vary. It is seldom, however, that stronger pipes than the following are demanded:— $\frac{3}{8}$ -inch pipe,  $4\frac{1}{2}$  lbs. per yard;  $\frac{1}{2}$ -inch, 7 lbs.; and  $\frac{3}{4}$ -inch, 11 lbs. A  $\frac{3}{4}$ -inch lead pipe, weighing 8 lbs. per yard, was recently tested at University College, Liverpool, and proved to be capable of resisting a pressure of 1680 lbs. per sq. inch; a  $\frac{1}{2}$ -inch lead pipe 9 lbs. per yard will withstand upwards of 2000 lbs. pressure.

**Lead pipes washed with tin** inside can be obtained; they are, however, of no value as a preventative of lead-poisoning.

**Pure tin pipes with a protective covering or casing of lead** are now made, the tin pipe being so united to the lead at the surface of contact as to be inseparable by any contortion, while the lead, being of much greater thickness than the tin, imparts to the pipe in its combined form the qualities which characterize leaden pipes. The difficulty of making joints without breaking the continuity of the tin lining is the one great objection to these pipes. This objection appears to be obviated in a new form of pipe, in which a tube of asbestos is inserted between the tin and the lead.

**Wrought-iron pipes** are little used for domestic supplies, as they soon rust up internally if of small bore, and also suffer considerably from outward corrosion. The discoloration of the water passing through them is very noticeable in baths and wash-basins, but is harmless in itself, although there are places where the rust would certainly be injurious—as, for instance, the bottom of a lead cistern. These pipes are chiefly used in works for the conveyance of large quantities of water, where a little iron or discoloration is of no consequence.

**Galvanized wrought-iron pipes**, though much cleaner for a time than ordinary black iron, become at length just as bad as regards discoloration. The zinc coating is not to be depended on, as most waters attack it even more vigorously than lead. Moreover, the dissolved metal is poisonous, though not so dangerous as lead, as it does not remain in the system.

**Iron-encased tin pipe** consists of a wrought-iron tube, with an internal lining of pure tin, thus producing the strongest and purest water-pipe ever made. All the fittings are lined and fitted together so as to present a continuous tin pipe. They are non-poisonous, because the metals are non-poisonous, and not on account of their being absolutely incorrodible. Figs. 135 and 136 show the tin-lined

iron pipe, and the method of joining by means of screwed threads. The new "safety vented socket or coupling" (fig. 136) is made with right and left hand threads for drawing the ends of the pipes together, and contains a hole as shown through which the water will escape if the tinned ends of the pipes are not

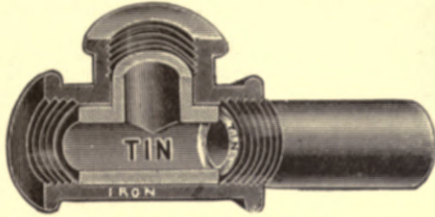

Fig. 135.—Iron Tee lined with Tin.

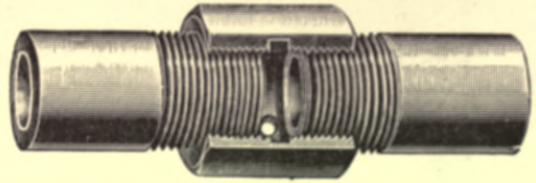

Fig. 136.—Patent Vented Socket or Coupling for Tin-lined Iron Pipe.

in close contact; this simple contrivance ensures the continuity of the tin lining, and so prevents the rusting of the joints.

The ends of lead pipes are united by **soldered joints**, varying according to the size and strength of the pipes. It is now customary to make "wiped" joints on all lead service-pipes, with the exception of the tail-pipes to baths and lavatories, which are often too short to make a good strong wiped joint upon. There are only four kinds of joints in general use, but they have to be made in so many positions, and the shapes and sizes are varied so much by individual workmen, that the number appears to the casual observer considerably



Fig. 137.—Underhand Wiped Joint.

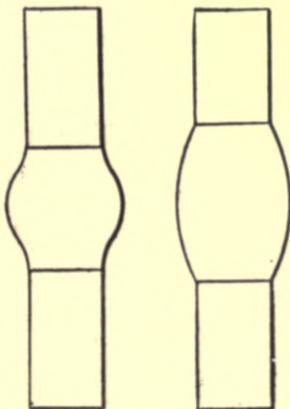

Fig. 138.—A "Stumpy" Wiped Joint.  
Fig. 139.—A "Long" Wiped Joint.

greater. The *underhand joint* (fig. 137) is used to connect the two ends of pipes lead to lead, and lead to brass, iron, or copper. The joint occurs in practice in all positions from horizontal to upright, the connection remaining the same, although the method of making it varies. From the horizontal to an angle of 45°, the

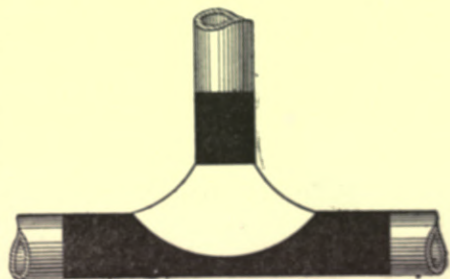

Fig. 140.—Equal-branch Wiped Joint.

solder is poured on the pipes from the ladle, a cloth being held under to hold up and regulate the solder until sufficient heat is attained to wipe the joint in the usual way. When the joint is inclined from 45° upwards, the solder is usually splashed on the pipes with a wood or iron spitter, and when of sufficient heat, is

wiped round as in the previous case; a smaller cloth, however, is often used. Two such joints are shown in figs. 138 and 139, the one known as the "stumpy" and

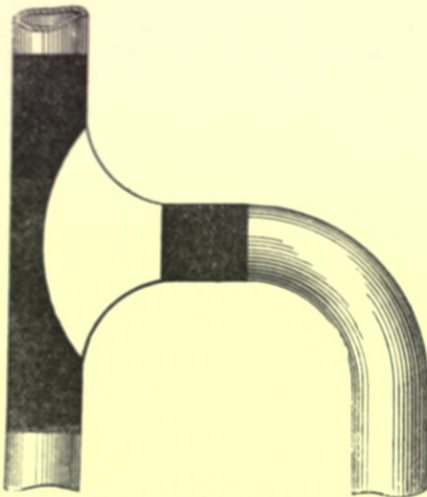

Fig. 141.—Side-branch Wiped Joint.

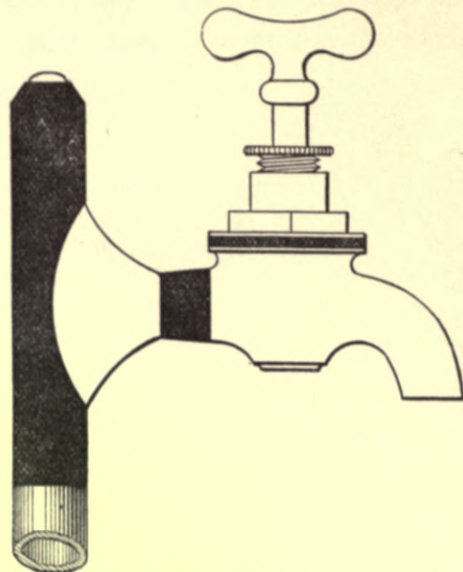

Fig. 142.—Bib-tap "Wiped" to a Lead Pipe

the other as the "long" joint. The stumpy joint answers its purpose just as well as the long joint, but does not look as well. The *equal-branch joint* (fig. 140) is the easiest of all joints to make. The bottom edge should be well curved. The metal is splashed on, and the joint wiped with or without the aid of an iron. The *side-branch joint* (fig. 141) is much more difficult to make, but the method of wiping is the same as for fig. 140.



Fig. 143.—Joint to Elbow Boss-plate.

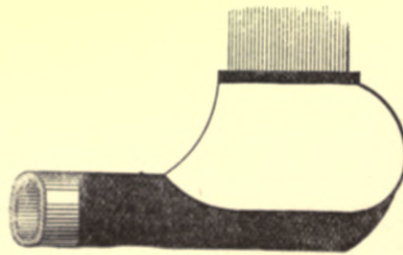

Fig. 144.—Joint to Plain Boss.

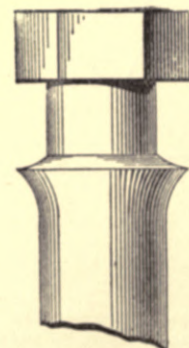

Fig. 145.—Copper-bit Joint.

to a lead pipe; the end of the tap is filed, prepared, and tinned, and the joint made like fig. 140. Figs. 143 and 144 show the brass bosses of boss-cocks wiped to the lead pipe; these joints are more difficult to make, as the top

edge of the brass boss overhangs the pipe. The *flow* or *copper-bit joint* (fig. 145), generally made on short tail-pipes, is not to be recommended for other purposes; many water-companies prohibit its use on main service-pipes.

The usual lengths of wiped joints in pipes of various sizes are as follows:—

$\frac{1}{2}$ -inch pipe	has wiped joint	$2\frac{1}{4}$ inches long.
$\frac{3}{4}$	"	" $2\frac{1}{2}$ "
1	"	" $2\frac{3}{4}$ "
$1\frac{1}{4}$	"	" $2\frac{7}{8}$ "
$1\frac{1}{2}$ and 2	"	" 3 "

For "branch" joints, the main and branch are generally "shaved" for soldering to the distances given in the following table:—

TABLE XVIII.  
SIZES OF SOLDERED JOINTS.

Size of Pipe.	Length of Service-pipe "shaved".	Length of Branch-pipe "shaved".
$\frac{1}{2}$ -inch pipe.	$\frac{3}{8}$ -inch each side.	$\frac{7}{8}$ -inch.
$\frac{3}{4}$ " "	$\frac{1}{2}$ " " "	1 " "
$1\frac{1}{4}$ " "	1 " " "	$1\frac{1}{8}$ " "
$1\frac{1}{2}$ " "	1 " " "	$1\frac{1}{4}$ " "
2 " "	$1\frac{1}{8}$ " " "	$1\frac{1}{4}$ " "

**Lead pipes washed with tin inside** are required by certain water-companies. The coating thus produced is merely a film, and in no way interferes with the connections of the ends and branches by a wiped soldered joint, but as the films of tin cannot be united, there is no advantage in using these pipes.

**Lead-encased tin pipes** consist of an internal pipe of tin with an outer covering of lead, and are made in all the usual sizes and strengths. The thickness of the tin lining varies with the size of the pipe,  $\frac{1}{32}$  inch being about the usual thickness for pipes up to 1 inch in diameter, and above this size  $\frac{1}{16}$  inch, but the thicknesses of the tin lining and the lead covering vary with different manufacturers. The tin lining is sometimes very faulty, and care should be taken to see that there are no seams or blisters on the inner surface. The advantages of using lead-encased tin pipes, where the water supplied is of such a nature as to render lead pipe unsuitable, or where the water is liable to remain for long periods without being drawn off, are more apparent than real, the difficulty of making permanent connections is so great. For cold-service pipes, these pipes are more lasting than lead pipes; but when fixed on the hot-water service, they are failures. Many methods have been tried to make a permanent connection on these pipes, but in vain. In some cases, a core of pasted brown paper has been

placed inside the pipes, and in others the ends have been filled with clay, in both cases the object being to hold the tin in position when melted; but the shrinkage of the tin on the application of heat makes it impossible for either of these methods to be successful, and there is also the difficulty of getting the papers and clay out of the pipes. Brass internal liners have also been tried, but without success, and I have just tried the latest form of soldered joint—which consists in using an outer ring of copper, and having the solder composed of 2 parts tin and 1 part lead, the melting-point being about 340° Fahr. as against 442° for tin,—and failed, but it is doubtful whether the lining of this particular piece of pipe was of *pure tin*. There is no difficulty whatever in soldering pure sheet tin with ordinary fine solder, or by using a thin strip of the metal itself.

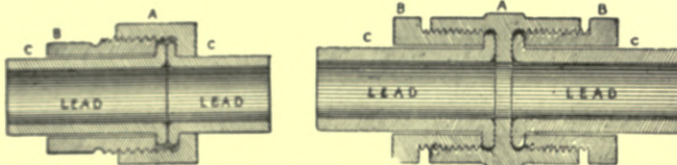

Fig. 146.—Two Methods of Joining Lead-encased Tin Pipes.

It is the same with pure tin pipes; they may have either wiped or blown joints made on them, but for lead-encased tin pipes the only suitable connections are those shown in fig. 146, and these would be considerably improved by inserting asbestos rings between the faces of the pipes and the brass flange in the one case, and between the faces of the two pipes in the other case. With plain lead pipe, no packing will be required, but with lead-encased tin pipe, a packing must be used to get a water-tight connection. The lead covering to these pipes prevents the tin from outward corrosion when laid in the ground, and also enables it to be bent to any position without buckling.

Where there is any danger of lead-poisoning from the use of lead pipes, it would be better to specify **pure tin pipes** without any covering. For inside work, the sharp bends and branches could be specially made, and all connections made by means of the blow-pipe joint. The outside main could be laid in a wood trough, to be afterwards filled with pitch, which would effectually prevent corrosion from the outside.

The pressure on street-mains varies from about 25 lbs. per sq. inch up to 75, or even 100 lbs., but the **diameters and thickness of lead service-pipes** are not regulated entirely by the pressure on the mains, as this would lead to complications in the rules laid down by the water-companies. The following diameters and strengths of pipes are ample for all practical purposes:—For one house not exceeding £20 per annum,  $\frac{3}{8}$ -inch pipe, 4½ lbs. per yard; for one house above £20, but not exceeding £70, or for six houses not exceeding £13 each,  $\frac{1}{2}$ -inch

pipe, 7 lbs. per yard; for one house above £70, but not exceeding £200, or for fourteen houses not exceeding £13 each,  $\frac{3}{4}$ -inch pipe, 11 lbs. per yard. When service-pipes exceeding  $\frac{3}{4}$ -inch in diameter are laid on private property, the water-company usually connects them to the main with  $\frac{3}{4}$ -inch pipes, but in the case of large public buildings, special branch-connections are put in, and the main carried up through the building with 2-inch or 3-inch cast or wrought iron pipes; sometimes there is also a special fire-main under heavier pressure than the ordinary main, with branches taken to the various parts of the building.

**The course of the main service-pipe** is usually along some portion of the basement walls, until it reaches a convenient point for being carried up inside the building to the storage-cistern. A wood ground, with a narrow fillet nailed on the front, is secured to the basement walls, and the pipe laid in the groove formed to receive it, after being wrapped in hair-felt or silicate-cotton as a protection from frost. Service-pipes should never be exposed to the damp air of basements, as the moisture is condensed on the cold pipes, giving them the appearance of being porous. The water collected in this way is very poisonous, as it contains a large proportion of lead.

When the pipe is turned up from the basement, it is sometimes carried on the face of the plaster or brickwork, and sometime (a better plan) on a back-board fixed to receive it. Whenever possible, pipes should be fixed on internal walls or partitions, and not on external walls. A burst seldom occurs except through frost, so that if the pipes are fixed where they cannot be frozen, the risk of damage will be reduced to a minimum. Such slight leakages as occur are at once noticed if the floor is properly made good, or the pipes are passed through a piece of sheet-lead to turn the drip on to the floor instead of allowing it to follow down the pipes.

Pipes are now frequently exposed on the face of **back-boards**, and secured to them by sheet-copper clips, or ornamental cast brass clips, either in the rough or with burnished edges, or with the surface wholly burnished. When copper pipes, fittings, and clips are used, they are frequently nickel-plated. When the pipes are exposed, there is less risk of inferior scamped work being done. The greatest drawback occurs with exposed hot-water pipes, whether of lead, iron, or copper, for when these pipes are strongly heated, they burn the floating particles of dust in the air, causing the ceilings and walls to be discoloured by lines of black smoke. Even when the pipes are cased with wood-work, the same unsightly marks appear if the joints are slightly open. The neatest covering for exposed pipes consists of asbestos sheets, cut into lengths to fold round the

pipes; if well damped and carefully put on whilst the pipes are hot, the asbestos will adhere to the pipes and may be painted.

In common work, the pipes are merely **buried in the plaster**; but this is a mistaken economy, leading to greatly-enhanced cost for repairs, besides increasing the dirt and annoyance whenever the pipes have to be laid bare.

**Wood casings** are a great improvement. They are sometimes fixed to the grounds with nails or screws, but it is always better to have them hung like doors, so that the pipes can be reached without the slightest difficulty. When hot-water pipes are fixed in casings without being wrapped, the ends of the wood casings should be packed with silicate-cotton to prevent loss of heat by a current of air passing through them.

When pipes are run across floors, behind skirtings, or between the joists, and there are valuable ceilings, &c., in the rooms beneath, it is customary to fix a **lead-lined gutter** under the pipes, for the purpose of carrying away the water in case of leakage. It is in exceptional cases only that such gutters will be allowed *in* the floor, but they can easily be run on it, and inclosed in a boxed skirting. The outlet-pipe should be carried through the outside wall, and should have a hinged flap on the end, unless the gutter empties on a lead safe beneath the bath, lavatory, or sink.

To protect pipes from frost they are sometimes laid in wood troughs filled

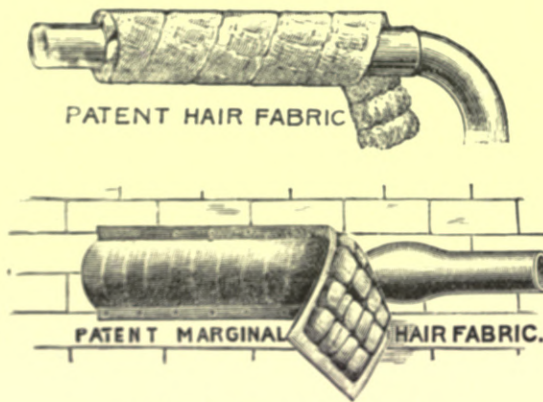

Fig. 147.—Pipes wrapped with Hair-felt.

with sawdust, or are wrapped in hair-felt (fig. 147), Anderson's being among the best; neither material, however, can be strongly recommended, as both may rot, smell, and harbour vermin. For external work, hair-felt or tarred roofing-felt is the best covering, and for internal work, asbestos or silicate-cotton. The pipes on or near external walls at the feet of baths, or in connection with water-closets or other fittings usually fixed near external

walls, and also all the pipes in the cistern-room, should be protected from frost by being wrapped with one of the materials mentioned.

## 2. CISTERNS.

It is customary to place the store-cistern in any odd corner or space in the upper part of a building, without taking much thought as to the **suitability of**



**the position.** The custom of fixing cisterns in any place which happens to be handy and economical, is to be regretted, and can only be dealt with by the sanitary and water authorities combined. A corner on the top landing is often selected in large houses, and it is not unusual to find the housemaid's sink and slop-hopper adjoining it, with possibly a water-closet facing it, and a soil-pipe terminal within a few feet of the window, and near enough to contaminate the whole of the atmosphere surrounding the cistern when the window is open. The landing is not a suitable position for a store-cistern, especially when surrounded with bedrooms, as the air of such places is not by any means as pure as it might be, especially at night. Still it is much better than many other places, such as the bathroom, or next to a water-closet, or over it, or between it and the floor above.

**The cistern-room** should be well removed from that part of the house containing the sanitary fittings, and should have a concrete floor, and brick walls lined with cement (painted or lime-washed), or with glazed tiles. The floor may be covered with 6-lbs. lead, having an outlet-pipe to the open air. The room should be at least 3 feet greater each way than the cistern, so as to give a space of 18 inches clear all round. It should be adequately lighted, preferably from the roof, and provided with its own inlet and outlet ventilators, and ought not to be used as a box-room or lumber-room, or for any other purpose. The cistern should be cleaned out at least once every three months.

**Wood storage-cisterns lined with sheet-lead** are now seldom used. The Manchester Corporation condemned them in 1873, so that lead-lined cisterns must be scarce in and around that city, except for w.c. purposes. It cannot be denied that certain classes of water vigorously attack lead, or that the dissolved salts of lead are poisonous, and it is only right that the use of lead in cisterns should be discontinued where the slightest danger exists; but great care should be taken that it is succeeded by something better. The lead used in lining cisterns usually weighs 5, 6, or 7 lbs. to the square foot.

**Galvanized wrought-iron cisterns** have been numerous fixed during late years, but they are not the most durable of cisterns, as the zinc coating is thin and easily corroded or dissolved. If the water is of the class that will attack lead, zinc will not withstand it. They are totally unfit for the storage of many waters, and the galvanic action set up between the various metals used throughout the service-system,—viz. lead, tin, copper, iron, and zinc,—results in the destruction of the tin and zinc coatings, and partial destruction of the lead pipes, the dissolved metals being drawn off with the water used for household purposes. These cisterns usually have a slimy scum on the surface, until

the zinc coating has disappeared. The advantages are that they are light, cheap, easily fixed and connected to, but they are not always watertight, a handful of sawdust or meal being often required to make them so. The poorest quality of galvanized cisterns, up to a capacity of 50 gallons, are made from iron sheets of the thicknesses known as 20 and 18 Birmingham wire gauge, and are galvanized after manufacture by dipping in molten zinc. The better class are usually ordered to be made of  $\frac{1}{8}$ ,  $\frac{3}{16}$ , or  $\frac{1}{4}$ -inch iron plates, according to their size and shape.

**Wood cisterns lined with sheet zinc** are to be found in the jerriest of property. They are quite unsuitable for the storage of most waters, and last only a short time, the bottom corroding through like a riddle. The iron rust from the street mains soon eats through the zinc, and corrosion may be assisted by nails or other iron, which may be accidentally dropped into the cistern. There are firms in London who are taking out the lead linings of cisterns and replacing them with zinc of nearly the same thickness as the lead, with the object of getting rid of the risk of lead-poisoning from the use of lead-lined cisterns, but this may be more than compensated for by the rapid deterioration of the lead pipes in connection with the cistern.

Large **cast-iron cisterns**, flanged and bolted, the joints made with sal-ammoniac and iron borings, are very good. They should be washed with lime or Portland cement on the inside and not painted. Small cast-iron cisterns are very dirty in use, and if frozen are liable to crack. The metal is from  $\frac{1}{4}$  to  $\frac{1}{2}$  inch thick.

Large **wrought-iron cisterns** are also very good, and are made from  $\frac{3}{8}$ -inch plates riveted together. They should be washed with lime or cement in the same way as cast-iron. Small wrought-iron cisterns for hot and cold water are very dirty in use, but are safer than when galvanized, although more apt to rust. They are of the same thickness as galvanized cisterns.

The larger sizes of cast and wrought iron cisterns are used chiefly in works and breweries, and owing to the regular periods for cleaning and lime-washing, they are generally in a good and wholesome condition. The water from these cisterns is slightly discoloured by rust, but there is no danger in drinking water slightly impregnated with iron.

**Enamelled-iron cisterns** are the ordinary light wrought-iron cisterns, covered internally with a coating of a special kind of enamel. They are claimed to be economical, not liable to rust, and to last longer than ordinary iron cisterns. They have been favourably reported upon after a three years' trial in Her Majesty's Royal Navy. There cannot be the slightest doubt that the enamelled

cistern is a great improvement upon plain iron or galvanized cisterns.\* They are made in various sizes, to hold from 50 to 400 gallons, and are  $\frac{1}{2}$  inch thick. The position of the holes required should be given when ordering, as these should be cut before the enamelling is done.

**Porcelain-enamelled stoneware cisterns** are the cleanest of all for the storage of drinking-water. Their excessive weight (for the walls are about 2 inches thick), and their liability to fracture (either from the connections or through frost), will, however, prevent their extensive use. As they can only be made in small sizes, the largest holding about 50 gallons, two or three of them will be required where one of slate would suffice. Sometimes an enamelled cistern is used for drinking-water only, but this means that another cistern with separate pipes and draw-off cocks must be fixed for the remaining water-supply. There is always great risk when this is done, as the water for drinking and cooking will probably be often drawn from the wrong taps.

**Fireclay salt-glazed cisterns** are made in much larger sizes than stoneware, and can be obtained to hold from 300 to 400 gallons. The glaze is brown and somewhat rough, and if not well done, the cisterns are liable to be slightly porous.

**Slate cisterns** are, next to stoneware, the cleanest for the storage of drinking-water, but they are heavy, costly, and liable to leak. Small slate cisterns have 1-inch sides and  $1\frac{1}{4}$ -inch bottoms; medium size,  $1\frac{1}{4}$ -inch sides and  $1\frac{1}{2}$ -inch bottoms; and large size,  $1\frac{1}{2}$ -inch sides and 2-inch bottoms. I have treated the jointing under the heading of red-lead.

To persons living in places where there is a **constant supply** of pure water, the idea of storing a quantity, even in the finest of stoneware, is repulsive. Where the supply is constant, and the various streets and districts have their own stop-valves, there is no difficulty in obtaining a supply of fresh water, for if one street is shut off for repairs during the day,—but repairs are mostly done at night,—there is plenty to be had in the next, or water can be drawn from a temporary stand-pipe at the end of the street. Thus it is only on very rare occasions that there is the slightest difficulty in procuring fresh water in most cities and towns, and there is therefore no necessity to store drinking-water in any quantity. As a general rule, it may be said that no tap for drinking or cooking purposes in dwellings or warehouses should be supplied from a cistern; in all cases the draw-off taps must be on the main service before it enters the cistern. The sanitary fittings only should be allowed to be supplied from a cistern.

In those towns, however, where only an **intermittent supply** is provided, cisterns

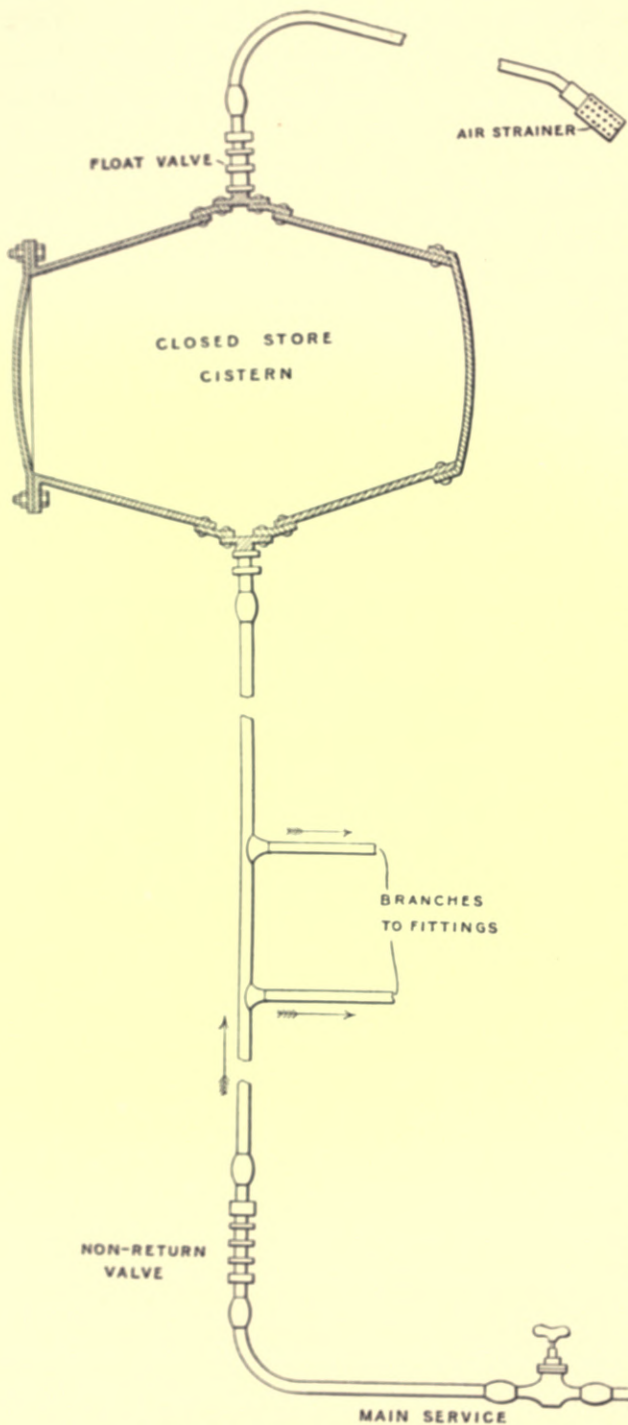

Fig. 148.—Harding's Closed Water-cistern.

are absolutely necessary, as also in those places where the springs are likely to fail wholly or partially in dry weather, or where the water has to be raised by pumping.

In many cases, **Harding's system of storing water** can be recommended. It consists in placing a galvanized-iron closed cylindrical cistern, capable of standing the pressure of the street main or other supply, in the space usually occupied by the ordinary open store-cistern. A non-return valve is fixed lower down on the main service-pipe, and a float-valve is fixed above the closed cistern. The water from the main enters the cistern and forces out the air through the float-valve, until the vessel is full, when the float-valve is automatically closed. When the supply from the street-main is turned off, the non-return valve closes, and the water retained in the cylindrical vessel can be drawn off at the taps fixed on the branch-pipes, air being admitted through the air-pipe and float-valve. The end of the air-pipe is provided with a fine wire strainer. An arrangement of this kind is much better than storing water in the ordinary form of cistern; the contents, being hermetically sealed, are preserved free from dust, dirt, foul gases

are absolutely necessary, as also in those places where the springs are likely to fail wholly or partially in dry weather, or where the water has to be raised by pumping.

and any impure particles which may be floating in the air, and which form the chief sources of contamination when the water is stored in open cisterns. It may, however, be pointed out that a system of this kind cannot be expected to work always without noise, for with quick-closing taps and high pressures, noises, known as "check" or "rattle", may occur in the pipes. It is an advance over the present method of storing water, and given a suitable vessel, capable of standing the pressure of the water and the shock from the closing of taps, there is no reason why it should not be largely adopted.

Still another new invention possessing some merit is Durrans's "**Kallo**" self-cleansing galvanized-iron cistern, shown in fig. 149. This is circular in shape, with a coned bottom, and mounted on an iron-framed stand E, for easy access to a clearway emptying valve, c. The ball-valve A has a copper circular flushing pipe, so that when the valve c is opened, all dirt and sediment are completely washed out in a few moments. For convenience, where cisterns are fixed inside roofs and other inaccessible places, the valve c can be fixed on a length of pipe discharging over a sink below, or in the bath-room; by this arrangement the

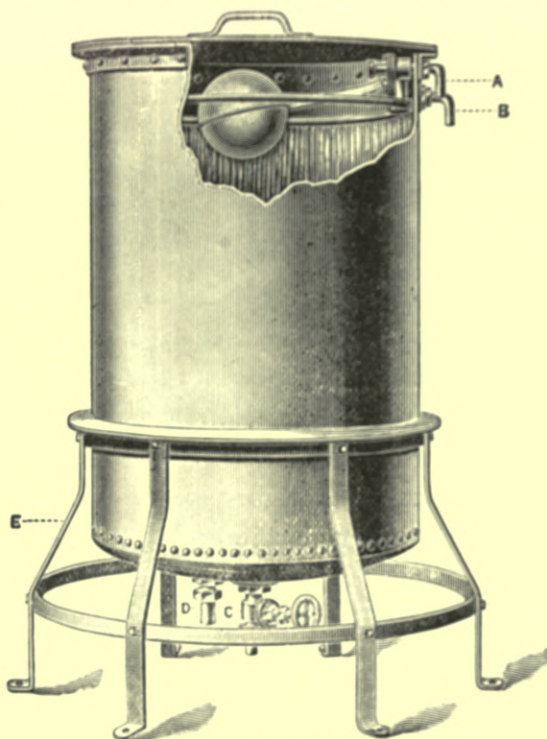

Fig. 149.—Durrans's "Kallo" Self-cleansing Cistern.

valve can be turned on and off without the slightest trouble. D is the union for the supply of pure drinking water, and B the union for the overflow. The cistern is fitted with a galvanized-iron cover, bolted down air-tight with nuts and screws to prevent any foul air contaminating the water.

No hard-and-fast rule can be laid down to govern the **size of store-cisterns** in the various classes of property. In a £30 house, storage for not less than 50 gallons should be provided; much larger cisterns are often fixed, but the smaller the cistern can be kept, the better.

The following table gives the approximate capacity and size of cistern required in houses of various classes:—

Annual Rent of House.	Capacity of Cistern.	Size of Cistern.
£30	50 gallons	24 in. × 24 in. × 24 in.
£60	150 "	34 " × 43 " × 29 "
£100	250 "	36 " × 60 " × 32 "
£200	750 "	90 " × 48 " × 48 "

All **connections** to lead cisterns are made by lead pipes and wiped soldered joints. The connections to iron cisterns are made by means of screwed brass ferrules, and stop-cocks are connected by means of screwed ends and nuts; the joints are made watertight with spun yarn and a mixture of red and white lead, or with sheet-lead washers and the same cement. The connections to slate and stoneware cisterns are the same as for iron, the screwed ends of the brass fittings being longer, according to the thickness of the walls of the cistern.

Cisterns should always be provided with **overflows**. The overflow from a lead cistern with a  $\frac{3}{4}$ -inch ball-cock under ordinary pressure will be a piece of 4-inch pipe, flattened, bonneted, and wiped on to a 2-inch lead pipe, the large bonnet end being wiped into the side of the cistern. With a slate cistern, a flange is wiped on the bonnet to fit against the outside of the cistern, and the portion passed through is tafted (turned back) on the inside to secure it. To find the correct size of overflow-pipe required, it is necessary to know the size of the water-way through the cock, and the pressure of the water. No ball-cocks, except those of the equilibrium type, have full clear-ways through them,—quite the contrary; a  $\frac{1}{2}$ -inch ball-tap will have about a  $\frac{1}{4}$ -inch water-way, and a  $\frac{3}{4}$ -inch about  $\frac{3}{8}$ -inch. Small flushing-cisterns with  $\frac{3}{8}$ -inch ball-cocks require 1-inch overflows. Store-cisterns with  $\frac{1}{2}$ -inch ball-cocks should have  $1\frac{1}{2}$ -inch overflows, enlarged at the inlet to equal a 2-inch pipe; and with a  $\frac{3}{4}$ -inch ball-cock, the overflow-pipe should be 2 inches in diameter, with a 4-inch bonnet. Overflow-pipes should, as a rule, be carried through the nearest wall, and discharge in the open air; the ends should have properly-ground brass flaps, the rims being soldered to the end of the pipe.

**Lead safes** should be fixed beneath all cisterns, and not only under those of slate and stoneware. The sides of the upstand should be supported by wood fillets. The waste-pipe from the safe should be at least 1 inch in diameter, with a flap on the end. If the overflow from the cistern empties into the safe, the size of the waste should equal that of the overflow, and be properly bell-mouthed so as to admit sufficient water to fully charge the pipe.

Every cistern should be covered with a well-made and closely-fitting **wood cover**, having a small door over the ball-cock for repairs.

3. COCKS AND TAPS.

**Ball-cocks**—sometimes called ball-valves—often need repairs in the form of new washers, or need regulating as the washers wear, or as the pressure of the mains varies. The floating ball sometimes gives way, as previously mentioned,

at the soldered seam, when it must be taken out and re-soldered, or a new one put on. When the copper ball is water-logged, it loses its buoyancy and cannot close the ball-cock, even if the washer is good, the

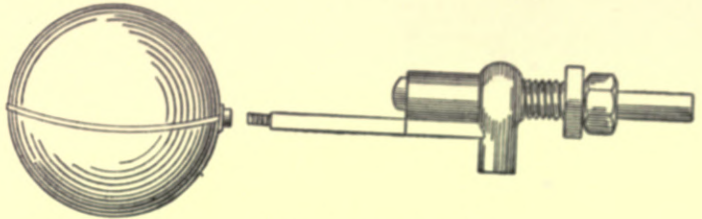

Fig. 150.—Globular Ball-cock.

buoyancy and leverage in ordinary circumstances being only just sufficient to overcome the pressure of the water in the water-way of the cock. The valve-

seat is sometimes rapidly corroded, causing heavy leakage. The ball-cock shown in fig. 150 is known as the globular. The lever forces the plug, placed at the end of the short arm,

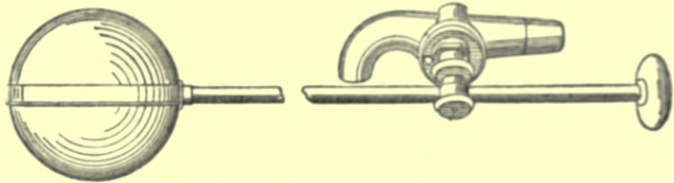

Fig. 151.—Side-screw Ball-cock, with Stuffing-box and loose Valve.

against the seating; the end of the plug has an india-rubber washer. The ball-cock shown in fig. 151 is on the same principle as a screw-down tap, and has a leather washer and loose valve.

**Stop-cocks** should be fixed on all service-pipes from store-cisterns. To prevent the noises in the pipes known as check or rattle, the stop-cocks should be of the kind known as “clear-way”, and should be one size larger than the pipes. An air-pipe should also be affixed to the pipe, close to the stop-cock, and carried back over the edge of the cistern.

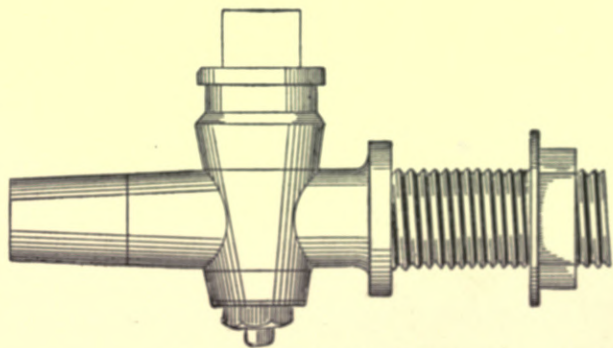

Fig. 152.—Round-way Stop-cock.

The “round-way” stop-cock (fig. 152) is the one usually fixed to iron and slate cisterns; it has a clear way through it. Either of the stop-cocks

(figs. 153 and 154) is used for connection with lead service-pipes. The stop-cock (fig. 155) is for fixing to the main supply-pipe, it being necessary that such taps should be of the screw-down type, having loose valves.

**Lord Kelvin's patent Indestructible taps**, which are now in high favour, deserve

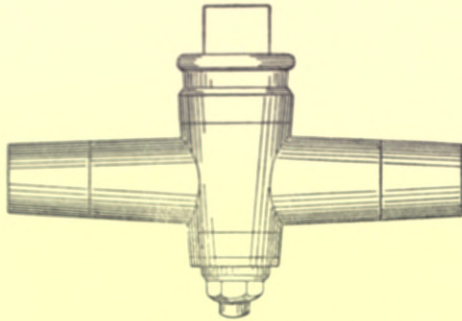

Fig. 153.—Round-way Stop-cock, for lead Pipes.

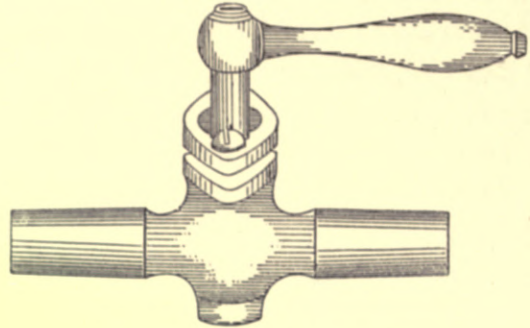

Fig. 154.—Gland Stop-cock for lead Pipes.

special mention. These taps are of admirable design, are made of the best gun-metal, and have a finer finish than any bib-tap in the trade. There are no less than twenty-six different patterns of these taps, all made in the various sizes, and chiefly of the class known as bib-taps, or draw-off taps, having a free

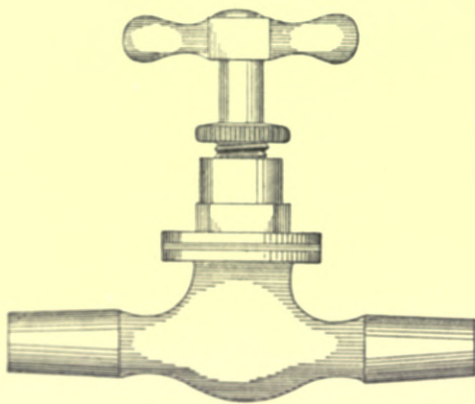

Fig. 155.—High-pressure Stop-cock, for lead Pipes.

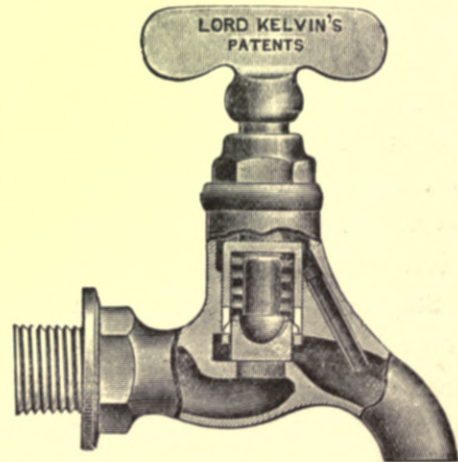

Fig. 156.—Section through Lord Kelvin's Patent Bib-tap.

end. The latest improvement in them is the substitution of vulcanite for metal, so as to avoid having metal pressing against the metal seating. Fig. 156 illustrates a very suitable draw-off cock, and fig. 157 represents a suitable spirit-cock or draw-off cock for a filter. The two lavatory pillar-cocks (fig. 158) are for tip-up and toilet basins. The rapid-opening tap (fig. 159) is designed for use in laboratories, hospitals, baths, lavatories, &c., to permit of the tap being opened



rapidly to the full flow. It is a screw-down tap with the arrangement for burnishing the valve upon the seat, as in the other forms of Lord Kelvin's taps, the only difference in the rapid-opening taps being that, by placing the thread on the outside of the body, it has become possible to employ a very rapid pitch of thread without exceeding the "angle of repose", so that there is no risk of the water-pressure (which increases during the night) lifting the valve off the seat. These taps are made in the form illustrated, and also in the form of pillar-taps for basins. They are made right and left handed for fitting in pairs.

It is customary for water-companies to stamp certain classes of fittings, which have been approved by their own engineers as being suitable for the purpose for which they were designed. The quality of the fittings used in particular districts thus largely depends on the good judgment of this official. The tendency in all cases is to

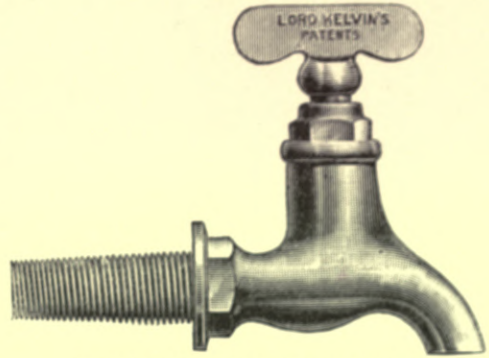

Fig. 157.—Lord Kelvin's Bib-tap for Filters.

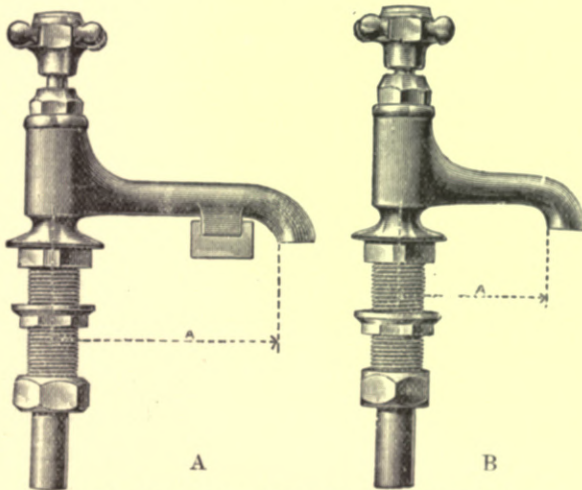

Fig. 158.—Lord Kelvin's Pillar-cocks:—A, for Tip-up Basins;  
B, for Toilet Basins.

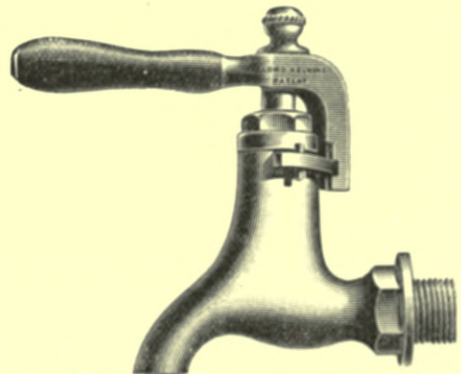

Fig. 159.—Lord Kelvin's Rapid-opening Tap.

restrict to the lowest limit the number of fittings to be stamped, and newer and better appliances are often shut out because sufficient weight and interest cannot be brought to bear. Various London districts, for instance, favour particular makes of syphon-flushing cisterns, none of which are accepted in Liverpool or Manchester, although it is possible to get a special permit. The cistern in favour in Liverpool is not allowed in Manchester, and some of the Manchester cisterns are not allowed in Liverpool. It is impossible to

deal fully with the subject of **stamped fittings**, but a few suitable fittings have been selected to show the various kinds of screw-down and plug-cocks in general use. The subject of flushing-cisterns will be dealt with in a subsequent section.

---

### CHAPTER III.

#### HOT-WATER SUPPLY: PRINCIPLES AND FITTINGS.

##### 1. *GENERAL PRINCIPLES.*

The circulation of water through a system of boilers and pipes is due to the expansion of the water by heat (which is received from the boiler placed at the lowest point of the system), and to the contraction of the water as it gives off some of this heat during its passage through the pipes. The heated water, being lighter than the cold, rises, whilst the colder and denser particles gravitate towards the source of heat at the lowest point. To have a brisk circulation of water, the heat given off should be sufficient to lower the temperature in the return-pipe. The greater the difference in temperature between the water in the flow and return pipes, the greater will be the volume of water flowing through them. The nearer the temperatures approach each other at the commencement of the flow and at the extremity of the return pipes, the more sluggish will be the circulation.

When water is heated in a vessel, no matter whether it be a glass flask, an open pan, or a steam boiler, the heat absorbed by the vessel is conducted to and taken up by the water in contact with it. During the process convection-currents are set up, the heated particles of water rising to the surface and returning to the bottom by flowing down the sides of the vessel. Thus a continuous movement or circulation is kept up until the water reaches the boiling point, when ebullition takes place. Up to this point the surface of the water has apparently remained stationary, as it is not disturbed by the movement of the whole body of water beneath it.

In small vessels, such as a glass flask, containing only a few inches in depth of water, and heated at the bottom, the **convection currents** appear to revolve in circles, gyrating in all directions from the source of heat in the centre. After removing the source of heat and allowing the particles of water to become stationary, the currents may be started again by cooling the upper part of the flask. Thus we see that if water is heated at the bottom, the heated particles

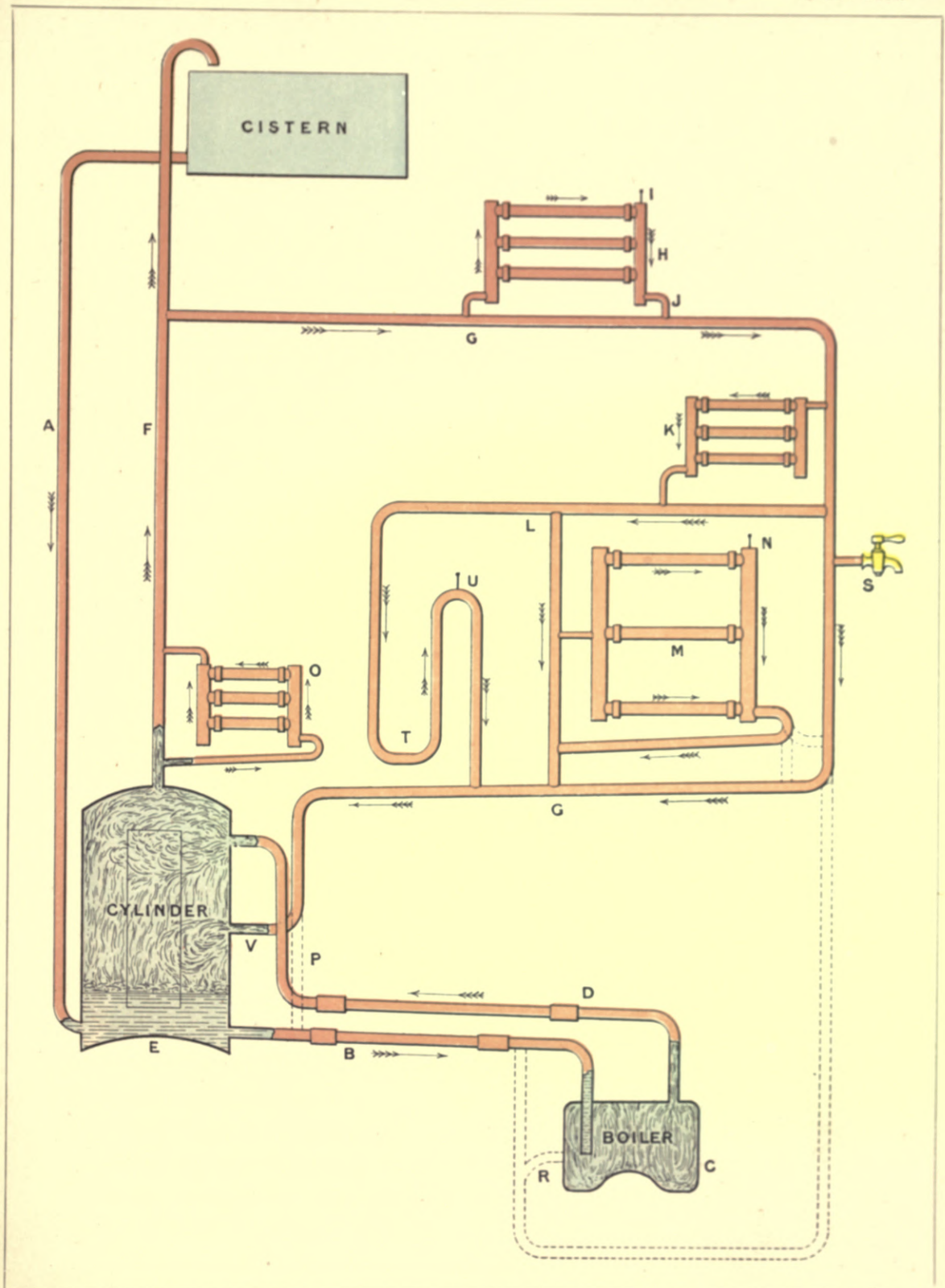

DIAGRAM OF HOT-WATER CIRCULATION—CYLINDER SYSTEM.

- |  |  |  |
|--|--|--|
| <p>A. Cold-water supply from cistern to cylinder.</p> <p>B. Return-pipe from cylinder to boiler.</p> <p>C. Boiler.</p> <p>D. Flow-pipe from boiler to cylinder.</p> <p>E. Cylinder.</p> <p>F. Expansion-pipe.</p> <p>G. Return circulation-pipe.</p> | <p>H. Coil or radiator.</p> <p>I. Air-cock on radiator.</p> <p>J. Return-pipe from radiator to circulation-pipe.</p> <p>K. Towel-rail.</p> <p>L. Branch return-pipe.</p> <p>M. Branch-pipe returned to L or G.</p> <p>N. Air-cock.</p> <p>O. Towel-rail or radiator.</p> | <p>P. Faulty connection of return-pipe shown by dotted lines.</p> <p>R. Connections of return circulation-pipe in tank-system.</p> <p>S. Tap.</p> <p>T. Dip in Branch return-pipe.</p> <p>U. Upward bend with air-cock.</p> <p>V. Position for non-return valve.</p> |
|--|--|--|



rise to the top, and if the water is afterwards cooled at the top, the cooler particles fall to the bottom to be replaced by the hotter ones from beneath. In both cases convection-currents are set up, causing a circulation or movement in the whole body. These currents are set up by the expansion of the water by heat, and as the heated particles are lighter bulk for bulk, and occupy more space than the colder particles, they rise to the top, while the latter sink to the bottom and are in turn heated and rise again.

A body of water becomes heated throughout partly by convection, as just explained, and partly by **conduction**, for, in addition to the heat "conveyed" by the currents set up, the whole of the particles forming the body of water are in intimate contact with each other, and a small proportion of heat is transmitted or "conducted" from one particle to another.

To illustrate the practical application of the foregoing principles in heating water for domestic use, the drawing of **a model of a hot-water apparatus** (cylinder system), shown in Plate VIII., will be useful. The cold water from the cistern is led by the pipe **A** to the bottom of the cylinder **E**, and by the return-pipe **B** to the boiler **C**. On the application of heat to the boiler **C** by means of a small bunsen-burner, gas-jet, or spirit-lamp, the heated water will commence to flow through the flow-pipe **D** to the upper part of the cylinder **E**, and, after the water in the cylinder is warmed, it will rise up the expansion-pipe **F**, and return to the cylinder by the return circulation-pipe **G**. The expansion-pipe **F** is open to the atmosphere, no other air-pipe being necessary. The flow-pipe to the coil or radiator **H** is connected at one side, and when the pin or tap at **I** is opened to let out the air, the water rises and passes through the pipes, as indicated by the arrows, and returns again to the return circulation-pipe **G** by the pipe **J**. The towel-rail at **K** is supplied from the descending return-pipe **G**. No air-cock is necessary in this case, as the rail is supplied from the top, and the course of the water is downward, not upward as before. The return-pipe from the rail is connected with the return-pipe **L**, which may have a number of branch-pipes taken from it to the various fittings, and these branches may be returned to pipe **L** in the same manner as pipe **L** is taken from and returned to pipe **G**. The rows of pipes **M** are placed here to show that the water can be taken through the three pipes and returned to pipe **L**, or to pipe **G** as shown by the dotted lines. An air-cock or air-pipe must be provided, as shown at **N**. The circulation-pipe **L** is continued and carried downwards at **T**, and is then taken up to **U**, at which point an air cock or pipe must be fixed. When the air is removed from the crown of the bend at **U**, the water will flow as shown by the arrows. The flow to the towel-rail at **O** is taken from and returned to

the expansion-pipe F, and no air-cock is required. To supply this rail with a downward flow is not easy, owing to the probability of a short circuit being made; this can be done, however, when there is sufficient work for the pipe to do before its return to the cylinder or boiler. The return-pipe G should be connected with the cylinder at a point high enough in the side to allow, say, 20 gallons of cold water to enter the lower portion of the cylinder from the pipe A, to replace that quantity of hot water drawn off for a bath, without submerging the end of the pipe G. There will then be no interruption of the circulation, as would be the case if the return-pipe G were connected at a lower point, or as shown by the dotted lines at P. With a body of cold water in the cylinder and pipe B, it is impossible for the warmer water in the return-pipe G to circulate through this colder water moving in the opposite direction, *i.e.* towards the boiler. When the return-pipe G is connected as at P, and a body of hot water is drawn off, the cold water enters the cylinder and rises to the same level in the pipe at P, thus preventing circulation, until the temperatures are approximately alike.

If the tap s is opened the whole system will be disturbed, water being supplied in both directions. The same remark applies to the air-cocks. To overcome this, a check-valve, or, as it is sometimes termed, a non-return-valve, is fixed at v, the effect of which is that all the water will be supplied from the expansion-pipe F. If this arrangement is tested, the necessity for having the branch-connection for the return circulation-pipe about 5 feet or 6 feet below the level of the water in the store-cistern will be demonstrated. The course of the water throughout the model is shown by the arrows.

When there is no cylinder, the flow and return pipes B and D are continued up to a closed tank at a higher level, or to a hot-water cistern on a level with the cold-supply cistern. In such cases the return circulation-pipe G must be connected with the return-pipe B, or direct to the boiler as at R.

The materials required for a **model circulation-apparatus**, like that illustrated in the plate, include sheet-lead (weighing 6 lbs. per sq. foot) for the boiler, cylinder, and cistern; half-inch pipes of copper, brass, or lead for the pipes and connections; and water-gauge glasses (as used in steam boilers) cut to length, and inserted between the lead pipes, the connections between the glass and lead being made with short pieces of india-rubber tube. The size of the boiler may be 2 inches by  $1\frac{1}{2}$  inch by  $1\frac{1}{4}$  inch, and that of the cylinder  $3\frac{1}{2}$  inches by  $1\frac{3}{4}$  inch. Two glass panels are inserted in the cylinder on opposite sides, so that the convection-currents inside the cylinder may be seen. The cistern may be 3 inches by 2 inches by 2 inches. The heat applied to the boiler should be well

regulated and not too strong, or bubbles of steam will be formed in the pipes and the results be exaggerated. With a steady even flame the water can be heated to within a few degrees from the boiling-point, and it can be distinctly seen that the water is circulating through the whole set of pipes. Cork dust, oak saw-dust, or raspings of amber put into the cylinder will be carried with the water and indicate its course through the pipes.

The **rate of flow** through circulation-pipes varies considerably, according to the heating surface of the boiler, the intensity of the fire, the size of the pipes, the number of bends, the height of the supply-cistern, and the amount of radiating surface. The difference between the density of the water in the flow-pipes and that in the return-pipes is an indication of the rate of flow; but an allowance has also to be made for the expansion of the water as it enters the cylinder from the boiler. In ordinary systems the speed is from 30 to 50 feet per minute; but where there is a very high head of water and the boiler is strongly heated, the expansion of the water is far greater, and the circulation may be at double the speed mentioned. This may be noted in the model by carrying the expansion-pipe *F* about 9 inches above the cistern.

## 2. BOILERS.

Most of the **boilers** used for heating water for domestic purposes are of the forms shown in figs. 160 and 161, and are frequently of cast-iron; as, however, this material is apt to crack and burst, especially in frosty weather, it ought

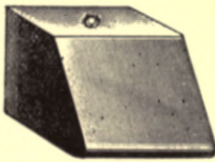

Fig. 160.—Wrought-welded Iron Boiler for open Range.

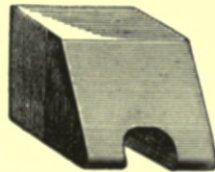

Fig. 161.—Wrought-welded Iron Boiler with arched Flue, for open Range.



Fig. 162.—Wrought-welded Iron Boiler for closed Range.

never to be adopted. Wrought-iron boilers are better, and have been much used during recent years; but copper boilers are undoubtedly the best and safest. The iron and copper Leamington boilers (fig. 162) are made for close ranges, as are also the boot-shaped iron and copper boilers (figs. 163 and 164).

**Cast-iron boilers** of the form shown in figs. 160 and 161 rarely wear out, but they sometimes crack when the water in the pipes is frozen. Most renewals are necessitated by explosions, except in districts where incrustation takes place. Up to the present no water-company—or even the Board of Trade—has been bold enough to fix a period which shall be considered the life of a cast-iron

boiler. But a period ought to be fixed, say from ten to fifteen years, according to the kind of water used, and the kind of grate—whether open or closed.

**Wrought-iron boilers** should be of  $\frac{3}{8}$ -inch plates welded together. They may either corrode through at the ends, or burn through in the front or bottom.

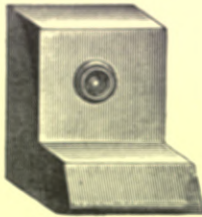

With Bevelled Toe.

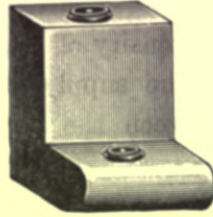

With Round Toe.

Fig. 163.—Wrought-welded Iron Boot Boilers, for close Ranges.

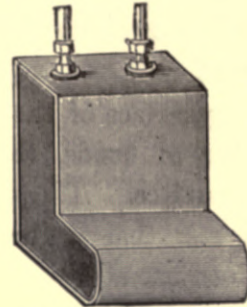
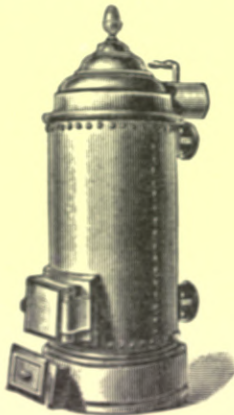

Fig. 164.—Copper Boot Boiler.

**Copper boilers** are made from copper plates, seamed and brazed together. They are expensive, but as they heat more rapidly than iron, do not favour incrustation, do not discolour the water, and are more durable, the extra cost is well spent. A cast-iron guard should be fixed in front, as otherwise they are liable to be injured by the poker. Wrought-iron and copper boilers rarely explode and fly to pieces, but they sometimes open at the seams.

The "Palatine" (fig. 165) is a good type of "independent" boiler, and is



Straight Pattern.



Section.

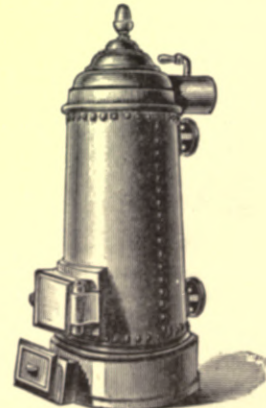

Conical Pattern.

Fig. 165.—"The Palatine" Independent Boiler.

suitable for a large residence. In mansions and large houses, the kitchen fire should not be used for the hot-water apparatus, on account of the large fires that would be required, and the temptation to close the boiler-flue when roasting, boiling, and baking are going on. To maintain a good supply of hot water, the boiler should be of the "independent" type, and should be connected with



a copper cylinder placed on a stone base on a level with the boiler, and distant from it only from 4 to 8 feet. Saddle boilers surrounded with brickwork ought not to be fixed in the basement of houses, as the brickwork may harbour cockroaches and crickets.

If "independent" or saddle boilers are fixed in or near the basement, special means should be adopted to get rid of the sulphurous fumes which arise from the "clinking" of portions of the fuel used.

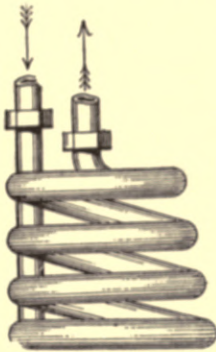

Fig. 166.—Coiled-pipe Boiler.

There are numerous **tube-boilers** in which the principle of coiling the pipe is adopted, as shown in fig. 166. This kind of boiler is made of strong wrought-iron or copper pipe, and although called a "safety" boiler, it is less safe than other kinds, as it is more easily blocked. Moreover, it will soon burn away, and either leak or burst. Clay's "Combination" boiler will prove safer, and is made in various forms to suit both open and closed ranges. For open fire-grates, the lines are the same as the ordinary cast or wrought iron boilers; but these boilers, instead of being in one piece, are built up by using strong cast-iron box-ends and wrought-iron steam or hydraulic pipes. If these boilers are at any time subjected to undue pressure, the joints will give way, and so prevent an explosion, the top joints not being constructed to carry a high pressure. These boilers are rapid heaters, but neither they nor the coiled-tube boilers ought to be used with chalky waters, as incrustation may soon block the pipes.

Ordinary cast-iron and welded-iron boilers usually have **hand-holes** in the top, between the unions, and boot-shaped boilers have two hand-holes in the front. These hand-holes are necessary to enable the boilers to be cleaned, and the end of the flow-pipe, which is sometimes corroded over, to be freed. These hand-holes often cause much annoyance through leakage, and in wrought-iron boilers their corrosion is rapid. They are rarely screwed up so as to be air and steam tight, and the corrosion around them is in excess of that in all other parts of the boiler. India-rubber rings are unsuitable for bolting up the covers, as they harden and shrink, causing leakage. A mixture of red and white lead with chopped hemp is often used, but a mixture of white-lead and plumbago with a little chopped hemp, used as soon as mixed, will last longer, and make a tighter joint. A good steam-tight joint should always be aimed at to prevent the outward corrosion of the boilers at their weakest part, as well as to prevent the bolt between the covers, or between the cover and the bridge, from being corroded and weakened.

Where **incrustation** takes place, it must be removed periodically, according to the quality of the water and also the quantity used. In some parts of the country, independent boilers like the "Palatine" last only two years, on account of the deposits. Special provision is made at the bottom of some independent boilers for receiving the deposit, which can be removed by unscrewing the mud-box. The best course is to adopt Clay's safety apparatus (figs. 170 and 171), which retain all the incrustation in the cylinders, where it cannot do any harm. The water in the boiler, and that in the cylinder (from which the domestic hot-water supply is drawn), are kept separate, and as the water in the boiler can only deposit once, hard water may be used without danger; but it would, of course, be better to reserve a small quantity of rain-water for the boiler-supply. Anyone can remove the cylinder and clean it out thoroughly, after unscrewing the cover, and the kitchen fire need not be put out during the time the work is being done. No deposit takes place in the boiler, so that it will not burn away as rapidly as ordinary boilers where the sides are encrusted with deposits.

Ordinary plain **bath-boilers** are usually set on two fire-bricks placed flat on the bottom of the grate, one at each side of the boiler, with the ends of the bricks to the fire. With a 12-inch boiler this gives a flue nearly 4 inches wide and nearly the same in height, and with a 14-inch boiler the flue will be nearly 6 inches wide. These flues answer well where good fires are kept up; but where the fires occasionally get low it is better to make the flue less in height and greater in width. This is done by using ordinary fire-tiles, 2 inches thick, thus placing the boiler down in the fire instead of above it. When a bath-boiler with arched flues is set on bricks laid flat, the top of the flue is from 6 to 7 inches above the fire-bottom; in this case, when the fire is low, cold air passes over the top of the fire under the boiler and cools instead of heating it. The air, to be thoroughly heated, must pass through the fire or source of heat, otherwise it will not heat the boiler. The boilers for Leamington ranges have a 2-inch flue, like boot-boilers. The latter are also made with flues passing through them; they can then be set on the grate-bottom. Boot-boilers with flues of various kinds are intended to present a little more heating surface, and where heavy firing takes place, they answer well; but where only poor fires are kept, the flues are liable to be choked by soot.

**Dampers** should be fixed to the flues of all boilers to regulate the heat, especially where there is much cooking done. In open fire-grates, boiler-dampers are easily regulated; but where wrought-iron or steel boilers are used in closed ranges, there is often great difficulty in regulating the draught under

the boiler. It is frequently impossible to heat the ovens without closing the boiler-flue; in such cases, an iron plate with a  $1\frac{1}{4}$ -inch,  $1\frac{1}{2}$ -inch, or 2-inch hole bored in it should be placed over the flue, immediately under the damper frame, and the draught can then be easily regulated by the damper in the usual way.

**Noises** of a more or less disquieting character are frequently heard in connection with boilers. They are caused in several ways. Sometimes boilers are fixed unevenly, although there is generally a level base to start from. If they are so fixed, and as a consequence contain an air or steam space at the top, there may be a sudden condensation of the steam and a consequent thumping of the water against the inside of the boiler. These noises are more frequently heard in the pipes immediately above the boiler, owing to the end of the flow-pipe inside the boiler not being free. Noises are also produced when the boiler is too rapidly heated and the circulation-pipes are long.

**Mud-taps** are necessary when the water-supply is obtained from a river or small reservoir likely to be disturbed during heavy rains. The overflow at such times generally passes directly to the mains, without any pretence of filtration or even settlement, and boilers become charged with mud, deposited as the water passes through. In such cases mud-taps should be fixed to drain away the accumulations. Boilers with arched flues should not be used for dirty water, as only one side of such boilers can be emptied. The ordinary plain bath-boiler (fig. 162) is most suitable, and the mud-tap should be fixed low down at the end, or on the bottom near the end. If there is a basement below, the mud-pipe and tap will be carried down, so as to be handy for emptying; but in most cases they are brought through the jamb in the kitchen.

### 3. CISTERNS AND CYLINDERS.

When a **feed-cistern** is fixed to supply the hot-water apparatus, independent of the store-cistern, it should be of sufficient capacity to supply the largest quantity of hot water required at one time. The quantity of hot water required for an earthenware or stoneware bath is from 15 to 20 gallons, and for an iron bath about 15 gallons, so that a feed-cistern should be capable of holding at least 15 gallons. As water may at the same time be drawn from another tap, it is seldom that tanks of less capacity than 20 gallons are used, and in large houses, a capacity of 60 or even 80 gallons may be necessary. The supply to the feed-cistern is often taken from the store-cistern, and only a very low head of water is allowed, possibly only 2 or 3 feet; it may happen, therefore, that the water

is not supplied to the feed-cistern as rapidly as it is withdrawn. If the circulation-pipes in the tank-system are improperly connected, it is possible to withdraw the water from the tank, stop the circulation (as hereafter explained), and turn the system for the time being into a high-pressure one. Feed-cisterns should be of some incorrodible material, such as earthenware or slate, but most frequently they are of galvanized iron. For reasons already given, it is best to confine the number of metals used in a circulation-system within the narrowest limits.

**Closed cisterns**, usually termed "tanks", vary in size and shape, according to requirements, and range in storage capacity from 20 to 100 gallons. They are made in various strengths out of thin sheets of black iron, and are galvanized inside and outside after manufacture. The better class of cisterns are made of iron plate  $\frac{1}{8}$  inch thick, and are suitable for fixing under heads up to 10 or 12 feet. The poorest of these tanks are tested by the best makers up to 1 lb. per square inch, and the best tanks, which are of  $\frac{3}{16}$ -inch metal, are submitted to a strain of 10 lbs. per square inch, equal to a head of water of about 24 feet.

**Copper cylinders** vary in size from 30 inches by 12 inches up to 72 inches by 24 inches, and in capacity from about 12 gallons to 120 gallons. They are made of various strengths, but the weakest are usually capable of sustaining more pressure than most cast-iron boilers. These cylinders never burst from internal pressure, but the weaker kinds frequently collapse, and sometimes tear slightly, when subjected to a quick reversal from internal to external pressure.

There are various methods of making copper cylinders: some have all the seams weltd and brazed; some have the seams riveted and brazed; while others have the top or bottom weltd and brazed. The top or bottom of the cylinder may also be bolted on, and those so treated are the best. A well-hammered copper cylinder is much stronger than one only slightly or poorly hammered. Cylinders having a capacity of 40 gallons and upwards should be provided with hand-holes, so that they can be cleaned without being removed. Copper cylinders can now be obtained with rings brazed on to them, in order to stiffen them and prevent their collapse.

**Corrugated cylinders** are unnecessary and valueless for the purpose for which they were intended; for though they are stronger than the straight-sided ones, the additional strength is not required. The ordinary cylinder will resist more internal pressure than the boiler, so that the purpose of the corrugated cylinder can only be to prevent collapse. This cylinder is not unlike the bellows of a concertina, and in the event of its being subjected to a quick reversal from internal to external pressure, it is liable to shut up like the bellows. Corrugated

cylinders have never been looked upon with favour, and are not likely to be extensively used. If the sides of a cylinder are increased in strength, for which there is no necessity, the bottom of the cylinder may be blown down, and an excessive strain put on the seams.

**Galvanized-iron cylinders** vary in size and strength, being made from thin sheet-iron, and from iron plates varying in thickness up to one-eighth of an inch. They range in capacity from 20 to 50 gallons. These cylinders seldom collapse like those made of copper, but are liable to open at the seams and leak after being in use a short time, and a sharp tap usually makes a hole in them.

The cheapest copper and the best galvanized-iron cylinders are capable of withstanding the **pressure of water** in ordinary cases. The pressure, of course, varies with the heights of buildings and the positions of the cylinder and cistern. When the cylinder is fixed in the basement and the feed-cistern is in the attic, there is a head of water varying from 25 feet to perhaps 70 feet, and a severe strain is put upon cylinders of the common kind. The cheapest galvanized-iron cylinders may be used for a head of water not exceeding 20 feet, but if the height is from 20 to 40 feet, the metal should not be less than  $\frac{1}{8}$  inch thick; and above 40 feet, it should be from  $\frac{3}{16}$  inch to  $\frac{1}{4}$  inch thick. It is usual for makers to increase the thickness of the plate with the size of cylinder, and where there are high heads of water, there are generally large cylinders. It is possible, however, that a small cylinder may be required where there is a high head of water, and in that case great care should be taken that the cylinder is strong enough to sustain the pressure. A copper cylinder, 36 inches by 12 inches, holding  $14\frac{1}{2}$  gallons of water and weighing 36 lbs., is capable of resisting the pressure of all ordinary heads of water. A cylinder of a better quality is made the same size but 4 lbs. heavier. Cylinders to hold 40 gallons, measuring 48 inches by  $17\frac{1}{4}$  inches, should weigh from 76 lbs. to 84 lbs., and those to hold 50 gallons, measuring 48 inches by 20 inches, should weigh from 95 lbs. to 112 lbs. These are stock sizes, and the weights are suitable for all pressures met with in ordinary practice.

---

## CHAPTER IV.

## HOT-WATER SUPPLY: SYSTEMS.

## 1. THE CYLINDER-SYSTEM.

For middle-class houses, the **cylinder-system** shown in fig. 167 is most frequently adopted. It consists of a copper boiler 12 inches by 10 inches by 10 inches, weighing 40 lbs., a copper cylinder 42 inches by 16 inches, containing 30 gallons, and a slate feed-cistern, holding 50 gallons or upwards. The pipes are usually of lead  $\frac{3}{4}$  inch in diameter, weighing 9 lbs., 10 lbs., or 11 lbs. per yard, but sometimes 1-inch pipes are used, weighing 10 lbs., 12 lbs., or 14 lbs. per yard. All the joints are wiped and a clear-way stop-cock is fixed at the side of the store-cistern. The safety-valve, to the use of which plumbers are averse, should be of the dead-weight type, and may be fixed on the boiler direct, which is the best, or brought out from behind by means of a copper pipe. The pipe A supplies the cylinder from the feed-cistern, and the branch-pipe B supplies all the hot water drawn at the fittings. Other branches, however, may be taken from the expansion-pipe C to other fittings on various floors; but no branch is fixed below the crown of the cylinder. The

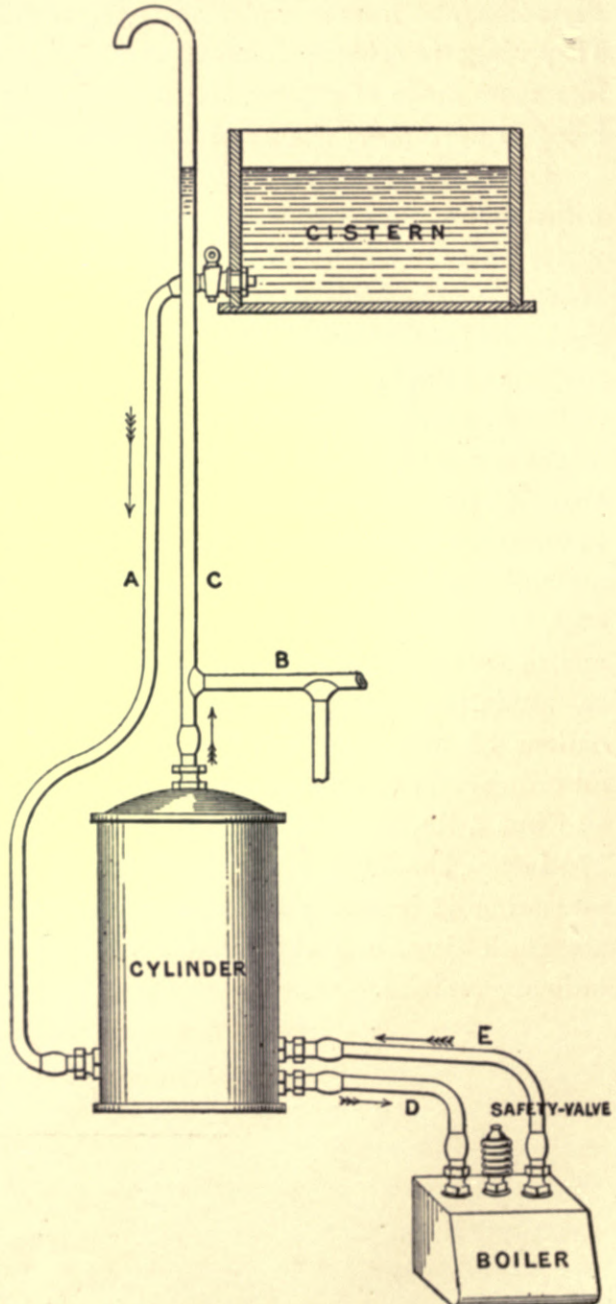
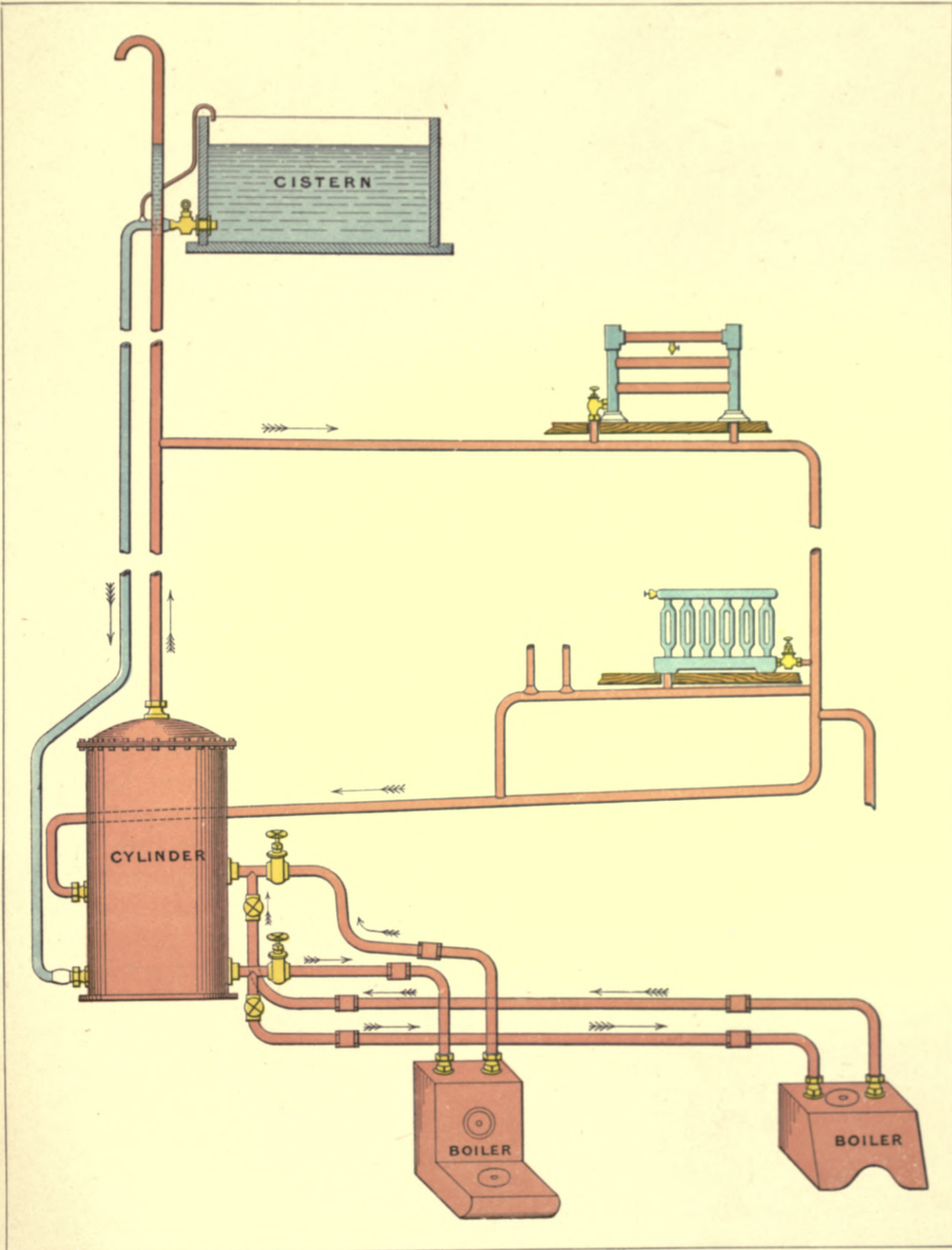

Fig. 167.—Ordinary Hot-water Apparatus: Cylinder-system.



HOT-WATER APPARATUS WITH TWO BOILERS—CYLINDER SYSTEM.





reason for fixing the cylinder at a level lower than the feed-cistern, is to secure a constant reserve of water for the boiler (which cannot be drawn off at any of the fittings), and to keep the circulation-pipes D and E as short as possible. The heated water from the boiler rises through the flow-pipe E to the cylinder, and the cold water from the bottom of the cylinder flows to the boiler by the return-pipe D, the end of which dips into the boiler 6 inches. The heated water rises through the cylinder and up the expansion-pipe C. The hottest water, being at the top of the cylinder, is drawn through the pipe B when a draw-off cock is opened. The cylinder is usually fixed in the kitchen, to keep the circulating-pipes as short as practicable, as the water in the pipes may otherwise be frozen. Especially is this the case when the cylinder is fixed in a distant bath-room, where there is no fire or other means of warming the room. When there is no risk from frost, as in some terrace-houses, the cylinder may be advantageously fixed in the bath-room, or in a linen-closet. A separate cold-water supply-pipe must be taken from the feed-cistern to supply the fittings. This pipe should not be branched out of pipe A, for if this is done, there will be only a poor supply of water, should two or three taps be opened at one time. The safety-valve may be carried to any desired position by a copper pipe; it is sometimes brought through the coving above the hob-plate, or through the front of the chimney-piece, or on the top of the mantle-shelf, but the position to be preferred is immediately on the boiler, and it should be enclosed in a cast-iron box, having a loose door for examination.

This system is suitable for houses up to £40 or £50 rental; but a 40-gallon cylinder, with a 14-inch boiler and 1-inch pipes, should be used for houses of £50 to £70 rental. In large residences, both an open and a closed kitchen-range are often fixed, either alongside or back to back, and it is usual to fix **two boilers** (one to each range) with separate circulation-pipes between them and the cylinder, as shown in Plate IX. Stop-cocks are almost always fixed on these pipes, so that one range can be worked whilst the other is undergoing repairs. The fixing of stop-cocks in such positions appears to be a very dangerous practice; but the number of explosions occurring where this class of apparatus is used is greatly exaggerated, probably owing to the frequency of explosions where commoner systems are adopted, and in which stop-cocks have also been fixed on the circulation-pipes. The stop-cocks are of the kind known as "Peet's" valves, and have a clear way through them. Where it is considered dangerous to fix stop-cocks on the circulation-pipes, separate air-pipes of  $\frac{3}{4}$ -inch bore should be carried from each of the flow-pipes to above the level of the water in the feed-cistern, to relieve the boilers in the event of the fires being lighted when the stop-cocks are turned

off; or safety-valves may be fixed on the boilers, but they will always be a fruitful source of trouble and annoyance, on account of constant leakages when fixed on an apparatus like this. These leakages may be due to a variety of causes. In a large installation, two or perhaps more taps may be open at one time, and as each tap is closed, one or other of the valves may be forced from its seat by the shock. In addition to this, the rapid variation in the temperature of the water causes the valves to leak, and when one of the boilers has been thrown out of use for a month or two, the corroding influence of the water standing in it often destroys the seating of the valves.

The bath-boiler shown in the plate measures 16 inches by 12 inches by 12 inches, and the boot-boiler 14 inches by 7 inches by 6 inches. The circulation-pipes are of copper,  $1\frac{1}{4}$ -inch diameter, and are strongly screwed. The cold-water supply-pipe from the feed-cistern to the cylinder is of lead,  $1\frac{1}{4}$ -inch diameter. The expansion-pipe is  $1\frac{1}{2}$ -inch diameter, and the return circulation-pipe 1-inch or  $1\frac{1}{4}$ -inch diameter, and is of light copper. The cylinder contains 60 gallons of water, and the slate feed-cistern 100 gallons. The branch-pipes to the fittings are taken at any convenient point, from the return circulation-pipe, which also supplies the towel-rail and radiator. If these branches are long, they should be returned to the main circulation-pipe; they will then form **secondary circulations**, and hot water can be drawn immediately a tap is opened. The flow-pipe from the boilers is connected with the cylinder well up the body, so that the hot water will enter above the connection with the cylinder of the return circulation-pipe. The best point for connecting a return circulation-pipe with a 60-gallon cylinder is about the centre of the latter, thus allowing a bath of hot water to be drawn off without interfering with the circulation. This pipe may be connected with the return-pipe (if there is only one), as shown by dotted lines in Plate VIII., or with the boiler itself, but a connection with the cylinder is the best.

For a large building, containing a considerable number of fittings, and with return-pipes connecting the various branch-pipes with the main circulation-pipes, the cylinder would be too bulky and give off too much heat for convenience and comfort if placed in the kitchen. The degree of heat required for a suitable apparatus for such a building could not be obtained from an ordinary kitchen fire, so that an **independent boiler** becomes a necessity. When an independent boiler is fixed in the basement or an adjacent outhouse, the cylinder can be fixed alongside. A good place in the basement is between the chimney jambs, where it may be fixed after the grate has been removed, and the flue may be utilized for the boiler. When this can be done, the cylinder should be fixed horizontally on wood bearers, and the front boarded up and filled with non-conducting

material, care being taken to thoroughly build up the flue. An apparatus fixed in this way is shown in fig. 168, the branches and rails being omitted. The

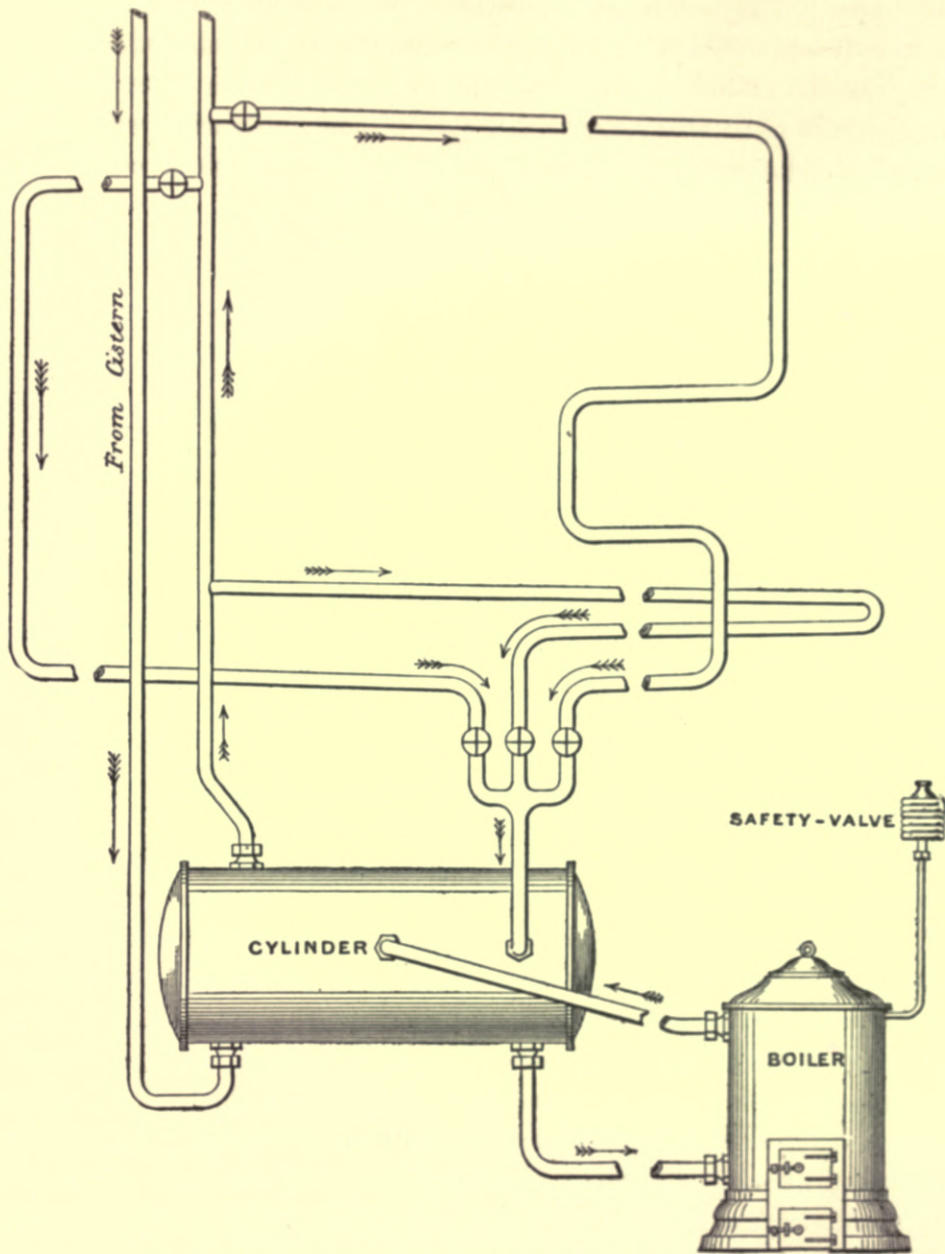

Fig. 168.—Hot-water Apparatus, with Independent Boiler and Horizontal Cylinder.

arrows indicate the direction of the flow of water through the pipes. The boiler is of the "Palatine" type, and is 24 inches across. The copper cylinder contains 80 gallons. The flow and return pipes to the boiler, and the expansion-pipe are

of copper,  $1\frac{1}{2}$  inch diameter. The pipe conveying cold water to the cylinder is of lead,  $1\frac{1}{4}$  inch diameter, and the return circulation-pipes of the same diameter are of copper. The two main circulation-pipes have stop-cocks affixed at the point where they are taken from the expansion-pipe, and also where they terminate near the cylinder; the stop-cocks so arranged are a great convenience, allowing repairs to be effected on either side without interfering with the other. The small circulation-pipe has only one stop-cock. The three cocks are con-

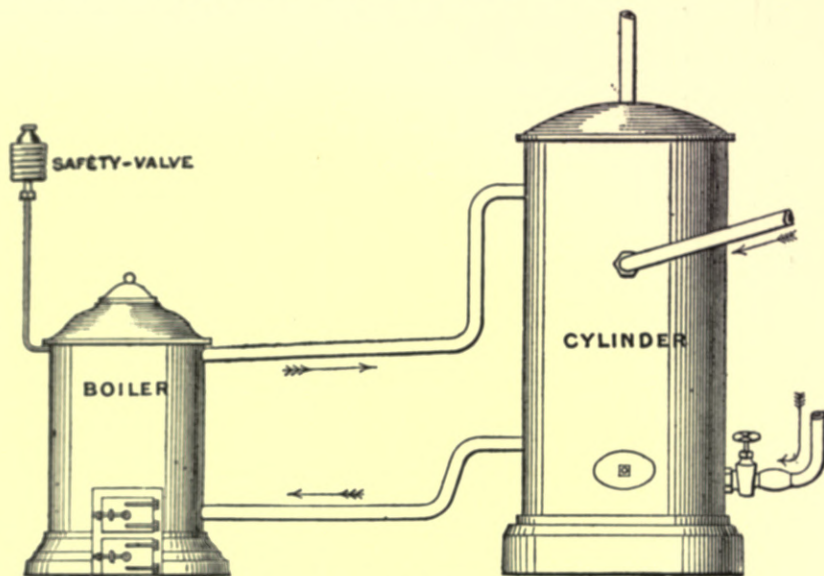

Fig. 169. — Hot-water Apparatus, with Independent Boiler and Vertical Cylinder.

veniently placed over the cylinder, and can be used to stop or regulate the circulation, as in summer-time the heat may not be required throughout the house. Fig. 169 shows an independent boiler connected with an upright cylinder standing on a stone base, and having the flow and return pipes, connecting the boiler and cylinder, affixed at the proper places. The expansion-pipe is taken from the top of the cylinder, the cold supply-pipe is fixed near the bottom, and the return circulation-pipe is connected with the cylinder a little above its centre. A hand-hole is provided near the bottom of the cylinder, so that the cylinder can be cleaned out when necessary.

It is well known that boilers sometimes explode, and that cylinders occasionally collapse. The causes of these catastrophes will be explained hereafter; suffice it to say here that both can be prevented by adopting a system of boilers and pipes, which will heat the water up to but not above the boiling-point at atmospheric pressure. With such a system there is no need to fix any safety-valve or other contrivance to prevent explosion. In the double-cylinder appa-

ratus shown in fig. 170, the water in the outer cylinder supplied from the store-cistern can only be heated to  $212^{\circ}$ , and the water in the boiler and inner cylinder, supplied from the lower feed-cistern, can only be heated to  $214^{\circ}$ , on account of the small head of water. The boiler is in free communication with

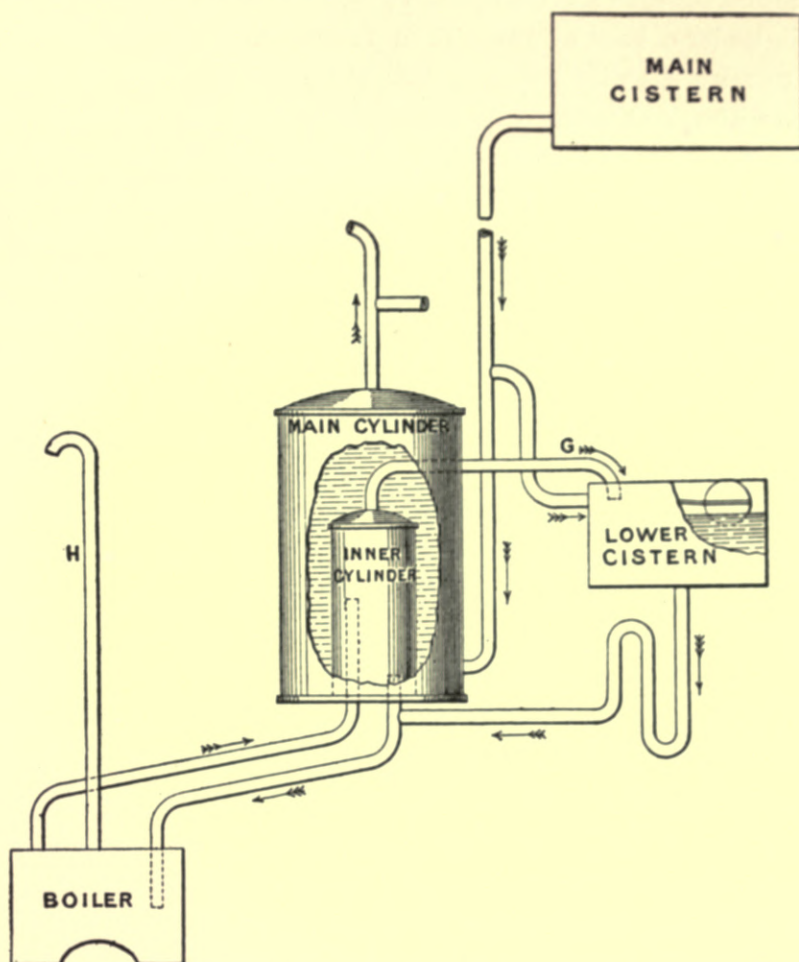

Fig. 170.—Double-cylinder Hot-water Apparatus: System 1.

the atmosphere by the two pipes H and G. This apparatus will supply the same quantity of water, at a temperature a little below boiling-point, as the ordinary systems which are liable to explosions. The boiler in this system cannot under any circumstances explode, for if the whole of the water in the apparatus is frozen solid, and a fire is lighted, the safety-pipe H in the boiler-flue will have thawed, before the ice in the boiler will have been melted, and heated sufficiently high to again fill the boiler. Thus, this apparatus is proof against explosion from the effects of frost. It has already been pointed out

that before an explosion can take place in the cylinder-system, the expansion-pipe must be frozen or blocked up in some way. So long as it remains free no explosion or collapse can take place, for it rarely happens that the circulation-pipes in the cylinder-system are frozen. The main cylinder in the system under notice cannot collapse, as the water contained in it cannot be heated above  $212^{\circ}$ ; and as it is under a head of water from the store-cistern, it will require more than  $212^{\circ}$  to raise it to its boiling-point; therefore it cannot give off steam to displace the water, and so long as the water cannot be displaced the cylinder cannot collapse. The diameter of the inner cylinder is too small for this to collapse under any ordinary pressure. The boiler cannot be furred up with incrustation, as the water drawn at the fittings and supplied from the store-cistern never enters the boiler; all the incrustation will be deposited in the cylinder, from which it can be easily removed. The system is just as safe with the cylinder full of incrustation as when full of water. The water supplied to the boiler from the lower feed-cistern is used only as a heating medium. A draw-off tap may be fixed to the pipe H or to the boiler, to change the water occasionally. The outer cylinder and the feed-cistern are supplied with water from the store-cistern. All hot water drawn at the fittings is supplied through the outer cylinder. The heated water from the boiler circulates through the flow and return pipes to the inner cylinder and back to the boiler, and gives off any excess of heat through the two pipes H and G. The water in the outer cylinder is heated by the absorption of the heat transmitted by the water in the inner cylinder.

Fig. 171 shows the same apparatus with the functions of the respective cylinders reversed. The boiler is supplied with water, and provided with the safety-pipe H, and works in the same manner as the one previously described, except that the water circulates between the *outer cylinder* and the boiler. The water in the outer cylinder cannot be raised above  $212^{\circ}$ , as it is in free communication with the atmosphere by the pipes H and G. All the heat absorbed by the water in the boiler is transferred by the circulation-pipes to the outer cylinder, from which the inner cylinder receives its heat. All the hot water drawn at the fittings is supplied through the inner cylinder, in which all the incrustation will be deposited.

These systems are proof against boiler-explosion from any cause, and collapse of the cylinders cannot occur. The one drawback is that there is no proper circulation of water in the service-pipes, and consequently a considerable quantity of cold or lukewarm water must be drawn from them before hot water can be obtained. The arrangement shown in fig. 171 will not admit of the service-pipe

being returned to the cylinder, so as to induce a proper circulation, but in the other system (fig. 170), the hot-water pipe or pipes above the cylinder can be returned to it exactly as in the ordinary cylinder-system.

I have omitted to show a draw-off tap so placed that it can be used to empty

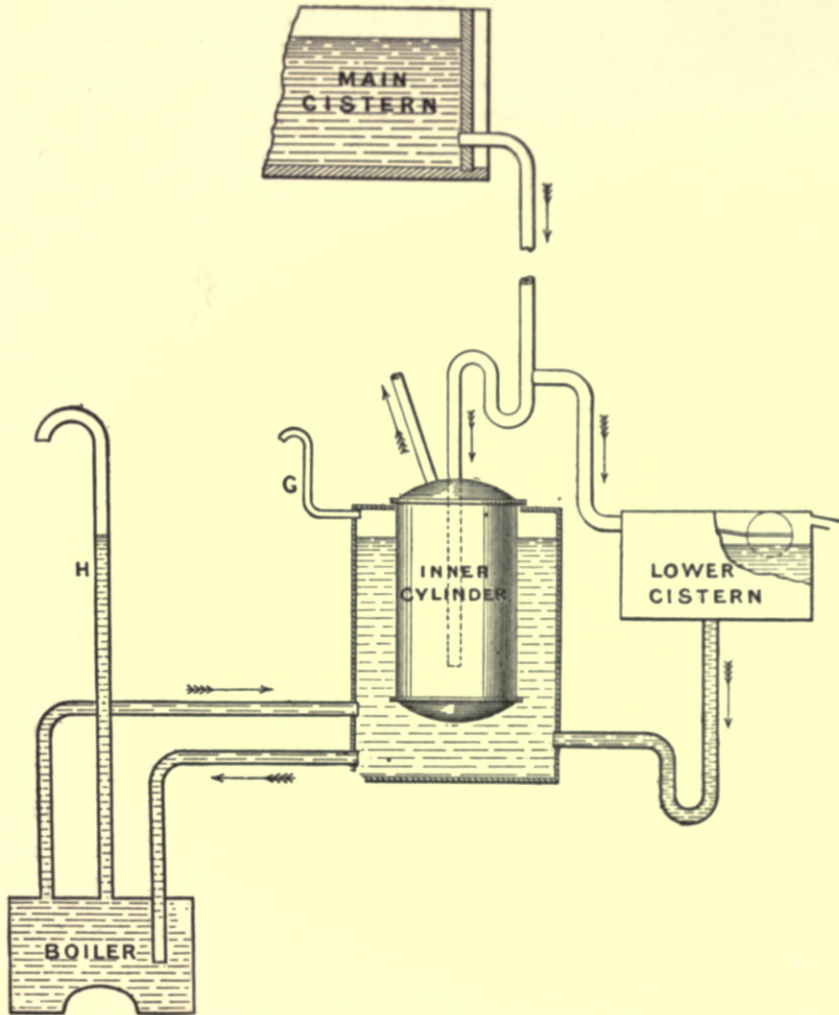

Fig. 171.—Double-cylinder Hot-water Apparatus: System 2.

the cylinder; these taps are only occasionally used, and should be connected with the cold-water supply-pipe, or with the bottom of the cylinder. Where there are a large cylinder and an independent boiler, the tap is usually fixed in the side of the boiler. In some districts a pipe and tap are required for the purpose of drawing-off the dirt, which may have accumulated in the boiler. This pipe may be connected with the end or bottom of the boiler and carried to any desirable point.

When the cold-water service-pipes are of lead, the **connections** to the branch-pipes are made by wiped soldered joints. When the hot-water pipes are of lead, the branch-pipes should be connected by means of a T-joint of brass or copper. The brass Tees with unions and tail-pipes are much better than the plain copper-

pipe Tees, for when the tinned surface has been destroyed and the solder lost its grip, the joint leaks, and if a copper T has been used it has to be cut out, and this necessitates the making of six joints to replace it; but when a brass T with unions is used, and one of the ends loses its tin, it can be made good with two joints. With copper pipes the ordinary screwed Tees are used.

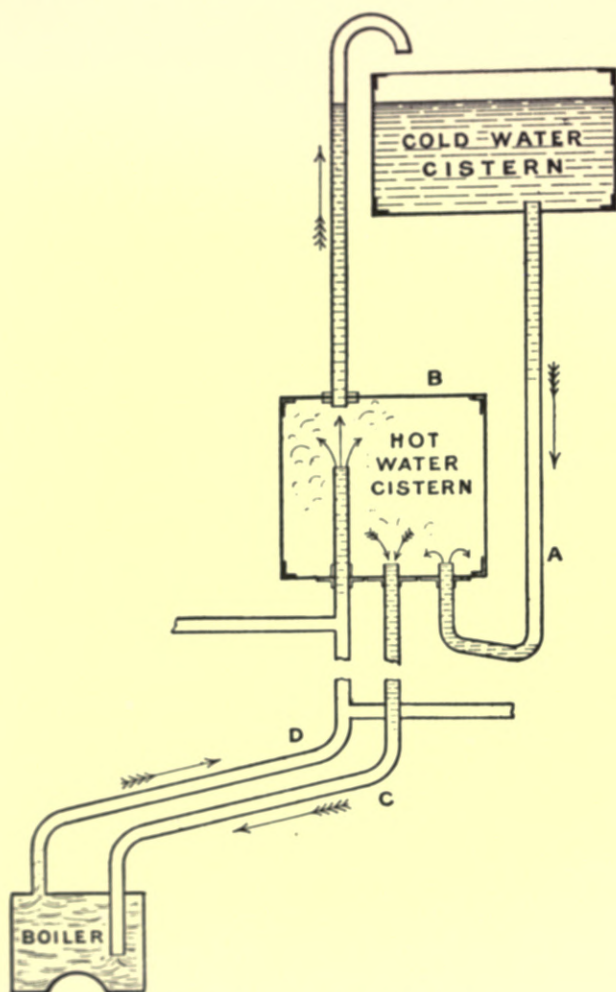

Fig. 172.—Hot-water Apparatus: Tank-system.

tank bulge out. In no case is the tank used as a reserve to supply water to the boiler, as in the case of the cylinder. The hot-water branch-pipes are usually taken from the flow-pipe, between the boiler and tank, as shown in fig. 172, so that the tank can be drained empty when the supply fails. When this occurs the circulation is stopped, as the two circulation-pipes are not in communication with each other at the top; and as the boiler and the pipes above are still full of water the system is changed from a circulation-system into a high-pressure one—that

## 2. THE TANK-SYSTEM.

The tank-system is usually adopted for the poorer class of houses, as the materials employed only cost about one-half those used in the cylinder-system. The tank is placed in an elevated position in the system, as it is incapable of sustaining a pressure of more than ten feet of water for any length of time, and sometimes with even a less weight of water the sides of the



is, a system which consists merely of a boiler with a cold supply-pipe and a hot exhaust-pipe, and in which, therefore, no circulation of water takes place. The end of the exhaust-pipe is carried above the feed-cistern, or through the roof. When the tank becomes empty the fire should always be put out. The water from the feed-cistern flows by the pipe A to the tank B, and by the return-pipe C to the boiler, where it is heated, and then rises by the flow-pipe D back to the tank B. It will be noticed that the flow-pipe D is carried up some distance inside the tank, which is necessary if the branch-pipes are fixed below the tank, as shown in the figure, for if ten gallons of hot water were drawn off, and the pipe D terminated at the same level in the tank as pipe C, then, when the draw-off cock was opened, the cold water from the bottom of the tank and a portion of the hot water from the boiler would be drawn together, and a lukewarm supply would be the result. By carrying the flow-pipe D up inside the tank, the hot water from the top of the tank is drawn off at the same time as that supplied from the boiler. One of the greatest faults of this apparatus is that the circulation-pipes C and D are often very long, on account of the tank being fixed near the feed-cistern, and the water in them is liable to be frozen. The circulation of the water in this system is slow, being only about fifteen feet to twenty feet per minute.

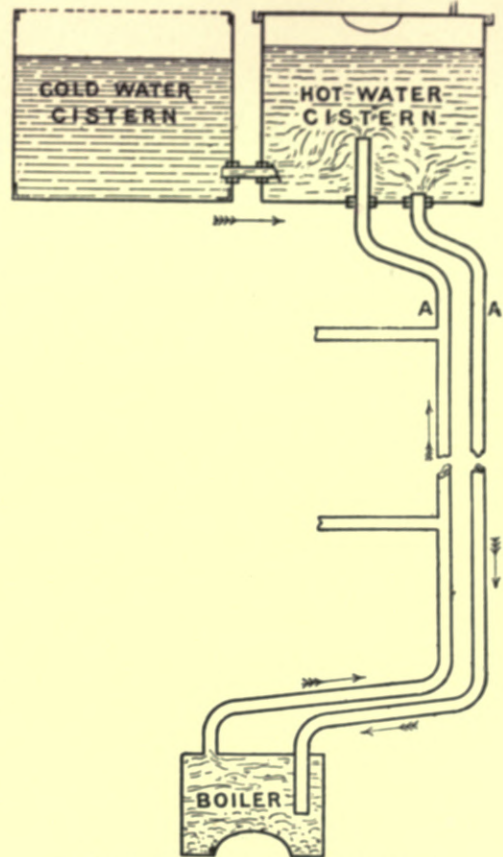

Fig. 173.—Hot-water Apparatus: Hot-cistern Circulation-system.

The system shown in fig. 173 is a modification of the tank-system, known as the **hot-cistern circulation-system**. The hot-water cistern is fixed on a level with the cold feed-cistern, and the circulation-pipes are usually longer than in the tank-system, but the principle of the two systems is the same. A cast-iron hot-water cistern, having a loose cover, is used instead of a closed galvanized-iron tank. The branch-pipes are taken from the flow-pipe, which is carried up inside the cistern. This system, which often has stop-cocks fixed on the circulation-pipes, is one of the most dangerous in use.

The proper places for connecting circulation and supply pipes to boilers, cylinders, and tanks are shown in the illustrations, but other places are sometimes necessitated by the exigencies of position, &c.

---

## CHAPTER V.

### *BOILER-EXPLOSIONS AND CYLINDER-COLLAPSES.*

**Boiler-explosions** are caused by—1st, *Stop-cocks* placed on the circulation-pipes; 2nd, *Frost*, the water in the two circulation-pipes, or in the supply-pipe or expansion-pipe, becoming frozen; and 3rd, *Incrustation*, and consequent stoppage of the circulation-pipes. An insufficient supply of water is often given as one of the causes of boiler-explosions, but it has been proved by exhaustive experiments that boilers do not explode from this cause.

If we suppose that two **stop-cocks** at A A (fig. 173) are turned off, and the draw-off taps on the branches are closed, there will be water in the boiler and pipes up to the stop-cocks. If the draw-off cocks are opened, the water will run out to the level of the bottom branch, leaving the boiler and a portion of the pipes full. If there is water in the pipes up to the stop-cocks, and a fire is lighted under the boiler, the water will be heated, and as it cannot expand,—for the pipes and boiler are already full,—there will be increased pressure on the boiler and pipes, and the more heat is taken up by the water the greater will be the pressure. No steam can be given off by the water, although it may have been heated considerably above its boiling-point, 212°, as there is no space to contain it, so that the pressure exerted is that of super-heated water. If the circulation-pipes are of lead,  $\frac{3}{4}$  inch diameter, weighing only 8 lbs. per yard, the pressure they will bear before bursting is 1680 lbs. per square inch. It is obvious that these pipes will not burst, unless they are in a very poor condition; but the boiler will at last yield, and if it is of cast-iron it will explode, flying in pieces. When the boiler yields to this extra pressure, there is not a particle of steam formed until after the rupture takes place, when all the heat stored up in the water is thrown off as steam, thus giving rise to the erroneous idea that steam is present in the boiler before the explosion. If the draw-off taps have been opened and a portion of the pipes drained, then the portion of the pipes above the water-level will be filled with steam, of the same temperature and at the same pressure as the water beneath it; but the boiler will explode in the same manner as before.

Explosions through **frost** do not occur when only one pipe is frozen up, as a boiler is safe if it has one free outlet. The water in both pipes must be frozen solid at some point to cause an explosion. We will suppose that the circulation-pipes are frozen at A A, fig. 174, as they pass through the bath-room on their way to and from the cistern. It will be seen that the boiler and pipes are full of water up to the ice in the pipes. When a portion of the pipes is once filled with ice, a little additional pressure has been brought to bear on the water below, by the expansion of the water on solidification. This extra pressure lowers the freezing point of the water in the pipes and boiler to such an extent that it is almost impossible for it to be solidified in a climate like ours. If we had an elastic vessel, instead of a rigid boiler, the freezing of the water might continue in a downward direction; but with a cast-iron boiler and good metal pipes, no downward expansion can take place. The only way in which the water in the pipes between the boiler and the frozen portion at A A can become solid, is by the bursting of either the pipes or the boiler. Unless the boiler or pipes yield to the pressure caused by the expansion of the water on forming ice, it is impossible for the water in a boiler to become frozen. If the frozen portion of the pipes is immediately over the boiler, the water in the boiler cannot solidify without rupturing the boiler, and if a boiler yields to this pressure, it is not a case of explosion. If the water in the pipes is frozen across at any part between the boiler and cistern, and the fire is lighted, the explosion of the boiler is as certain as in the case of the stop-cocks previously mentioned. There is the same danger in all hot-water apparatus. If the water in the two pipes is frozen at some point or blocked up in any way, on lighting the fire the pressure increases, until an explosion takes place.



Fig. 174. — Boiler, with Pipes frozen at A A.

If a dead-weight **safety-valve** has been fixed on the boiler (see figs. 167 and 168), and the water in the pipes above becomes frozen, it will continue to freeze in both directions, for when the additional pressure, caused by the expansion of the water as it freezes in the pipes, is exerted on the water below, the safety-valve, if in an efficient condition, will be lifted, and the water will issue from the boiler, allowing that in the pipes as well as in the greater portion of the boiler to solidify. It is therefore possible for the water in boilers supplied with safety-valves to be frozen solid, without the boiler itself being ruptured; but if the boiler fire is then lighted, and the boiler rapidly heated, there may be an explosion, especially if the ice above and surrounding the safety-valve is not

melted. This, however, will rarely happen, because as the ice is melted in the boiler, the valve will become liberated and thus prevent an explosion, even although the water in the pipes above the boiler remains in a frozen state.

Explosions sometimes occur through the **incrustation** of the boiler and pipes; but more frequently, incrustated boilers are burned through or crack. When the boiler and pipes become incrustated, the supply of water through the hot-water pipes is diminished, and this gives warning of the danger. The boiler and pipes should then be taken out and cleaned. A system which is slightly incrustated is not as liable to be affected by frost as one free from incrustation, because the incrustation, which is a non-conductor of heat, serves as a good protective

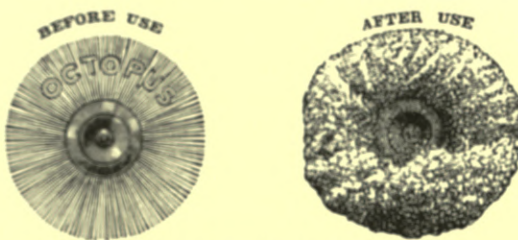

Fig. 175. — "Octopus", for collecting Deposits in Boilers.

covering. Still, there is always some danger with incrustated boilers, but it is diminished by the use of the "Octopus" (fig. 175), an appliance placed in the boiler to collect the fur or incrustation. There is no doubt that these appliances serve the purpose for which they are intended, at least for a time;

but they have a tendency to rot and fall to pieces. If these pieces collect at the elbows and bends in the pipes, as they may when the pipes are partially corroded, a serious explosion may be the result. Incrustation is almost invariably due to the use of hard waters containing lime in solution, and to prevent the ill effects of incrustation, the water must be purified before entering the feed-cistern, or the boiler must be regularly cleaned at intervals varying with the nature of the water and the quantity used, say, from three to twelve months.

**Cylinders collapse** more frequently in summer than in winter. There are several causes of collapse. The expansion-pipe may be trapped, or it may run horizontally or at only a slight incline for several feet. The bore of the pipe is often too small, but the most frequent cause of collapse is that the expansion-pipe is too long. If the water in the expansion-pipe is frozen, or the pipe is otherwise blocked, the cylinder may collapse. Fig. 176 shows the ordinary cylinder-system. The water supplied by the feed-cistern enters the cylinder, and the cylinder is in communication with the boiler by the usual flow and return pipes. The expansion-pipe may terminate at any height above the cistern, but is usually carried through the roof or turned over the cistern. The water in the expansion-pipe may be from 6 inches to 12 inches higher than that in the feed-cistern, as it depends upon the height of the cistern above the boiler, and the temperature of the water contained in the cylinder and pipes. If, for instance, the cistern is

33 feet above the boiler, and the cylinder is 6 feet above the boiler, the boiling-point of the water will vary considerably at different points in the system, namely from  $212^{\circ}$  at the top of the expansion-pipe and at the water-level in the cistern, to  $240^{\circ}$  at the cylinder and  $246^{\circ}$  at the boiler. The water in the boiler can take up and retain  $246^{\circ}$  of heat. Of this heat  $6^{\circ}$  have been given off when it reaches the cylinder, as it can only retain  $240^{\circ}$  at this point. The tendency of the water is to expand still more as it rises up the expansion-pipe, and the additional heat above

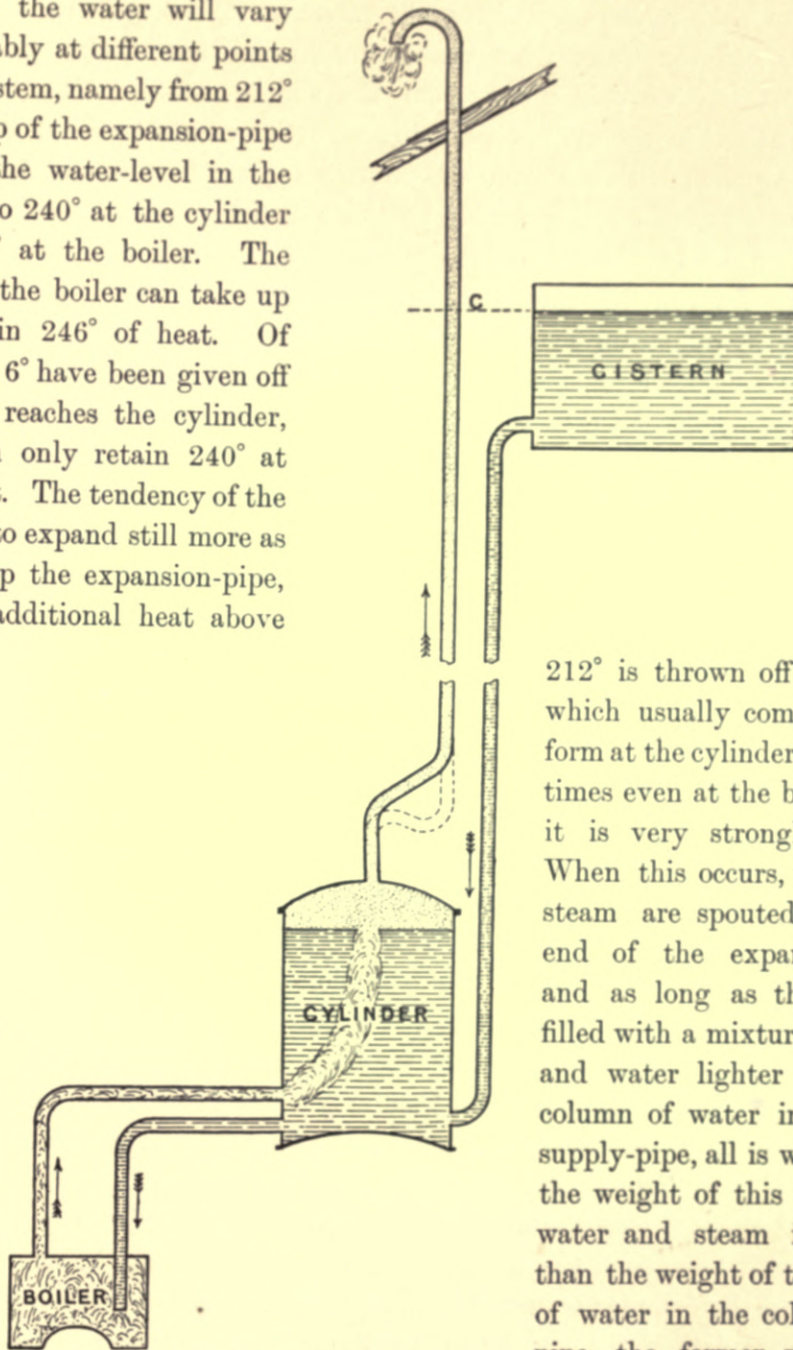

Fig. 176.—Hot-water Apparatus: Cylinder-system.

$212^{\circ}$  is thrown off as steam, which usually commences to form at the cylinder, and sometimes even at the boiler when it is very strongly heated. When this occurs, water and steam are spouted from the end of the expansion-pipe, and as long as this pipe is filled with a mixture of steam and water lighter than the column of water in the cold supply-pipe, all is well; but if the weight of this column of water and steam is greater than the weight of the column of water in the cold supply-pipe, the former will overcome the latter, and the water

in the cylinder will be forced back to the cistern by the superior force of the column in the expansion-pipe, until at last an outlet for the steam in the

cylinder is found in the same direction. As soon as a puff of steam passes through the cold-water supply-pipe the pressure in the cylinder is suddenly diminished, and the water from the expansion-pipe falls back, together with a small quantity of cold water from the supply-cistern. The latter condenses the steam in the cylinder, causing a partial vacuum, and as this cannot readily be supplied with sufficient air through the expansion-pipe, the ordinary atmospheric pressure on the outside of the cylinder forces the sides inwards, causing them to buckle up and sometimes to tear slightly. If the expansion-pipe is trapped by the pipe bagging down, as shown by the dotted lines in the figure, steam accumulates in the crown of the bend and forces the water up to a higher level, thus overcoming the column in the cold-water supply-pipe, and the displacement of the water in the cylinder occurs as before. If the expansion-pipe is not carried high enough above the cistern to overbalance the weight of water in the cold-water supply-pipe, collapse cannot occur from this cause, and it is impossible to displace the body of water contained in the cylinder in any other way except by frost. It is sometimes said that if all the water in the expansion-pipe is blown out, the cylinder may collapse in consequence, but this is not the case.

When the expansion-pipe is 1 inch or more in bore, the cylinder cannot collapse, for the increased bore of the pipe facilitates the escape of the steam, and prevents the water in the pipe being raised to the same extent that occurs in the smaller sizes, as in a  $\frac{3}{4}$ -inch pipe. In fig. 176 the dotted line c represents the water-level in the cistern and expansion-pipe when cold. The freezing-point at this level is 32° Fahr. Nearer the boiler a greater degree of cold is necessary to freeze the water, the freezing-point varying according to the pressure. If the water in the cistern and that in the expansion-pipe are submitted to the same degree of cold, the small column in the expansion-pipe will solidify first, and continue to freeze downwards. The water in the cistern will take longer to cool down to the freezing-point, and then only a thin crust of ice will be formed, whilst the water in the expansion-pipe may be frozen for several inches. If the boiler-fire is then lighted, the water in the boiler and that in the cylinder are heated and expand. As the expansion-pipe is blocked by ice, the expansion of the water will force back the water in the supply-pipe, which is not frozen. If the water in the cylinder is heated beyond its boiling-point, steam will be given off and accumulate in the crown of the cylinder, forcing back the water beneath it in the cylinder to the cistern as before, and the cylinder will collapse. When the expansion-pipe and the cold-water supply-pipe are run together, the water in the expansion-pipe will freeze down to a point on a level with that where

the cold-water supply-pipe is taken from the cistern, before the water in the cold supply will commence to freeze. If both these pipes are frozen and the fire is then lighted, either the pipes or the boiler will burst from the increased pressure caused by the expansion of the water.

Fig. 177 represents a copper cylinder after collapse; the sides are bent and puckered until they almost meet. The extent to which the sides of a cylinder are forced in, depends upon the thickness of the copper and the extent of the vacuum created by the sudden condensation of the steam; the latter varies according to the head of water from the feed-cistern.

The numerous kinds of **safety-valves** provided for fixing on the boilers of domestic hot-water apparatus may be classed under four heads: *lever*, *spring*, *dead-weight*, and (the most recent) *spring-valve, with liquid seal*.

A safety-valve should be carefully and accurately fixed, the load on the lever or spring correctly calculated, a working allowance being added to keep the valve water-tight when in use. New valves may be tight when the correct load is put upon them, but they will not long remain so. Additional pressure is obtained by screwing up the spring, moving the weight on the lever, or by adding other weights as required.

Safety-valves are always loaded until they remain tight. It is useless to attempt to regulate any valve at present in the market by the head of water. The lever safety-valve (fig. 178) may be fixed on a boiler and loaded

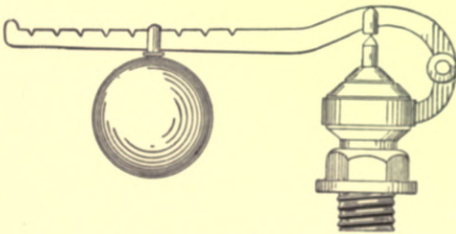

Fig. 178.—Lever Safety-valve.

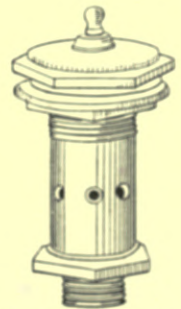

Fig. 179.—Spring Safety-valve.

until it is just water-tight, and, at the expiration of three months, the plug may have become as fast as though it and the seat formed one piece of metal. If the plug is loosened it is impossible to make it tight again without adding more weight; but it is customary to leave these plugs leaking, as they soon become fast again. It is the same with the spring-valve (fig. 179), for after a time the screwed cap and the spring may be removed, while the plug remains fixed. These valves are much worse than the lever ones, for it is possible to



Fig. 177.—View of a Collapsed Cylinder.

calculate the load in the case of the lever, but it is impossible to do so in the case of a spring-valve which has been in use for some time. Both spring and lever valves are liable to become corroded and rendered inoperative.

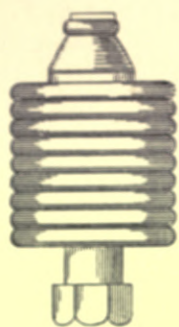

Fig. 180.—Dead-weight Safety-valve.

The dead-weight valve (fig. 180) is much better than the others, and more reliable in regard to the load, as the outer case and the three bottom rings balance a column of water equal to a weight of 10 lbs., and the separate rings to 5 lbs. each. The valves should be made tight by adding an additional ring over and above that required to balance the column of water. Dead-weight valves have, however, faults of their own. The long stem often becomes corroded, and the valve will leak if disturbed, and cannot afterwards be made tight. Safety-valve makers state how valves should be tested to see if they are in working order, but they do not explain how they may be made tight after the test. Much has been heard of the spring liquid-seal valve (fig. 181), which has recently been patented and is largely advertised.

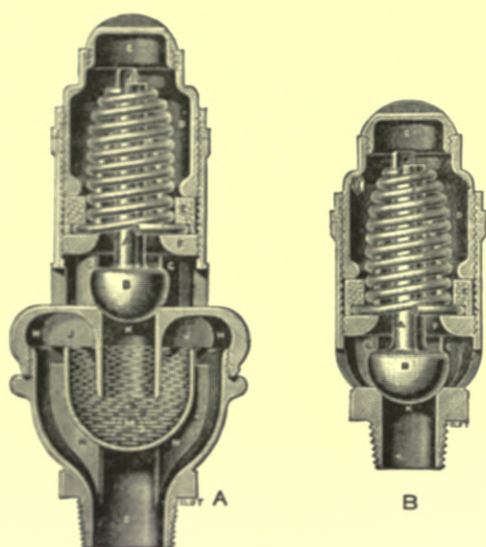

Fig. 181.—Keith's Tension-spring Safety-valves.  
A, With liquid seal. B, Without liquid seal.

It appears to be the natural offspring of the preceding valves. This valve is, for all practical purposes, the same as the spring-valve (fig. 179), except that the spring is in tension instead of compression from the cap to the seating of the plug. Below the plug B, there is the liquid-seal M (water or glycerine), and an air-space K between the liquid and the plug; and between the liquid-seal and the water in the boiler, there is another air-space H. Plumbers know by experience that it is impossible to have an air-space at H; that a plug on a seat, as shown, is not air-tight, though it may be water-tight; and that the liquid-seal,

by the pressure at J, will be forced up the air-space K, and the liquid will come in contact with the plug and seat.

It has been demonstrated over and over again that "safety-valves", so called, cannot always be relied upon to prevent explosions. They may, indeed, lead to explosions by inducing a false sense of security in the servant or householder, and leading these to light fires in frosty weather, under the delusion that it



does not matter if pipes are frozen—the safety-valve will prevent mishap. Safety-valves must be of good design, and so placed that they can be inspected without trouble; and they must be inspected at the beginning of every winter, especially if the water is one which leads to incrustation.

There are fittings known as **fusible plugs**, which are supposed to melt when the temperature reaches a certain point. In one case recently, when an explosion occurred and the fusible plug was for the time being *infusible*, the Board of Trade Commissioners fined the man who fixed the plug £30. Further comment is unnecessary.

Before leaving the subject of safety-valves, it will perhaps be as well to show an appliance which is far more reliable and delicate, more easily fixed than those named, and which will not leak when once fixed. This appliance cannot be overloaded, become jammed, or become fast. This **mercury regulator** is designed to overcome the difficulties experienced with all the contrivances called safety-valves. A column of mercury 30 inches high will support a column of water about 33 feet high, giving approximately an inch to every foot-head of water; in ordinary houses, therefore, a 30-inch or 36-inch mercury regulator will be ample, and it can always be relied upon to liberate any additional pressure, which may accumulate in the boiler or pipes.

Fig. 182 shows the apparatus complete and under pressure. It consists of an inverted syphon, which is coupled to a pipe branched from the hot-water circulation-pipe. The syphon is placed in a tube of oval section, which is closed at the bottom and provided at the top with a small reservoir or cup. The normal pressure in the circulation-system balances a column of mercury

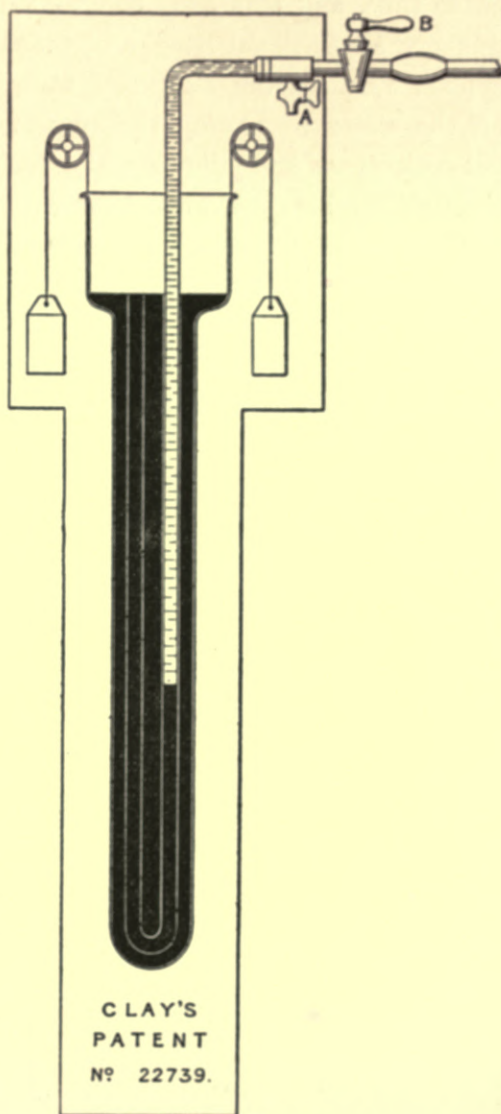

Fig. 182.—Mercury Regulator for Hot-water Apparatus.

in the syphon, such mercury being supplied by the outer oval tube. When the pressure in the boiler or pipes rises above that for which the regulator is arranged, the mercury is ejected from the syphon into the reservoir of the outer tube, and this tube being counterbalanced by weights and chains, sinks under the additional weight of mercury and water, leaving the mouth of the syphon free for the escape of water or steam from the boiler. By turning off the water by closing the stop-cock on the branch-pipe, opening the small pet-cock at A, and allowing the water to drain out of the reservoir or cup through the hole provided, the oval container with its complement of mercury is then raised by its counterbalance weights into position for recharging the syphon with the mercury ejected from it. The mercury in flowing into the syphon forces the water contained in it out through the open pet-cock. To complete the resetting of the apparatus, it is only necessary to see that the pet-cock is turned off, and the stop-cock on the branch-pipe above turned on.

SECTION V.  
HOUSEHOLD FILTERS

BY

H. JOSSÉ JOHNSON

M.B. (LOND.), D.P.H. (CANTAB.)





## SECTION V.—HOUSEHOLD FILTERS.

---

An old saying of Dr. M'Adam, that "**domestic filters are a delusion and a snare**", although sweeping, is still very true, unless they are most carefully selected and periodically cleansed. The fact that water has been drawn from the tap of a filter is, to many people's minds, a warrant that it is fit to drink. The very presence of a filter leads to a false sense of security, which is so far from being justified that it may, on the contrary, be a distinct and fruitful source of danger. An instance illustrating this occurred lately in India, as recorded in *The British Medical Journal*, December 26, 1896. An outbreak of typhoid fever was traced to aërated water as a cause. The water in the mains was free from typhoid bacilli, but after passing through a certain cistern was found to contain them. The cistern was emptied, and a small filter was found in it, which had been *in situ* during a former temporary infection of the water with typhoid. Others like it had been removed, but this had been overlooked. It had been contaminated, and had preserved and possibly increased the infection, and had communicated it to the source from which the aërated water was manufactured, after all trace of infection had disappeared from the mains.

This false sense of security and trust in a filter as in a charm, is fostered by the advertisements of filter-makers, many of which are criminally misleading. The circulars of not a few filter-vendors point out the dangers of blood-poisoning by impure water, and enumerate all the probable and improbable diseases which may arise from the use of such water, or even from water filtered by the apparatus of other makers, but they do not so much as hint at the dangers arising from inefficient filters. In *The Architect* of 1897 there appears regularly an advertisement of filters "requiring when once fixed *no* attention whatever, and superior to any others". Testimonials from scientists are then quoted, not one of which, however, bears a later date than 1872. When it is remembered that it was not until the eighties that the nature of the disease-bearing organisms was known, or the means of testing filters for germ-tightness

understood, it will be seen how misleading to the general public such a statement is.

That water should be aerated and rendered clear and sparkling is most desirable, and many, one may say most, modern filters yield water possessing these properties, well and quickly, but they must not generally be trusted for more than this. There must be no relying on the false hope that everything called a "filter" confers protection against the specific organisms of disease which may be present in the unfiltered water. Only one or two kinds of filters are germ-proof, and even these must be regularly cleansed, or, like the others, they will prove delusions and snares.

To gauge the purity of filtered water merely by the amount of **organic matter** present is also misleading, though many testimonials given by medical men and analysts are based upon this test. The presence of organic matter is an indication of probable sewage or organic contamination, but is no guide to the number or quality of specific disease-organisms. Such testimonials, therefore, are useless as a guide to the choice of a germ-proof filter. Equally, of course, all testimonials given previous to the early eighties are untrustworthy for the same reason.

There can be little doubt that when water is filtered on a large scale by a responsible authority, and delivered from the reservoirs by a **constant service**, it is purest and most free from danger when used direct from the mains without further filtration, or storage in house-cisterns.

Where such a supply is not available, and where good spring-water or deep-well water cannot be obtained, it is desirable to use a filter, but this must be chosen and treated in accordance with the principles hereinafter set forth, or it may do more harm than good.

**The accepted definition of a filter** is—An arrangement for separating the impurities from liquids, by passing these through a porous material. This is a satisfactory definition for general purposes, but when household-filters are to be considered, something more is required. Not only must such a filter separate all impurities from the liquid it is to purify; it must also not add any fresh impurities, either in suspension or solution.

**Filtration in Nature** goes on constantly on an immense scale. Water, falling on the earth's surface in the form of rain, brings with it impurities in the form of solid particles and gases in solution or suspension. These impurities occur in a marked degree in the neighbourhood of large towns. The rain-water during its passage over or through the gathering-ground, carries all kinds of animal, vegetable, and mineral matters along with it. It sinks then deeper and passes

through various strata,—becoming, perhaps, still further impregnated with mineral matter,—and after being confined beneath some impermeable stratum, may eventually crop out on the surface as a spring. These outflow-points of deep springs are the taps of Nature's filters. The water from them is generally bright, sparkling, and clear. The original dulness of the water, and the debris which it held in suspension on the gathering-ground, are gone, having been separated during the passage through the various strata of sand, gravel, chalk, lias, &c. This mechanical straining, however, is only one function of an efficient filter.

In the spring-water, pleasant to the eye though it may be,—and generally to the palate also,—mineral, gaseous, and even vegetable matters may be present in solution or suspension, collected during its contact with strata rich in these ingredients. These matters, foreign to a pure water, may or may not be harmful if the water be drunk. Many waters thus impregnated are useful medicinally when properly applied, but taken continually may prove deleterious.

It is, however, vitally important that artificial filtering media should add no impurity to the water, and a **proper definition of a filter** would therefore be—An arrangement of porous material, passing through the interstices of which, a liquid, without gathering any fresh impurities, is freed from those which it originally possessed.

**A glance at the history** of household-filters shows that they are of ancient date. Those used by the Egyptians were made of earthenware or sandstone, egg-or-bowl-shaped vessels resting on a wooden frame. Through these the water percolated, and was collected in a receptacle below. Though the method of application differs greatly, yet we find this type of material employed as the filtering medium in the most modern and efficient filters (Pasteur, Berkefeld, &c.). Cistern-filters were made in the middle of the last century, a slab of lias being fitted as a false bottom, and the water drawn off by a tap below the filtering slab. The "Alcarazas" made in Spain are filters of porous biscuit-china. The patent-records show that Mrs. Johanna Hempel, in 1790, invented a filter consisting of a supported basin made of tobacco-pipe clay and coarse sand, hardened in a furnace. In 1791, Mr. James Peacock applied the ascending principle to filtration, and also used the method of cleansing the filter by a return stream. Vegetable charcoal was first used in 1802, animal charcoal in 1818, and carbon blocks in 1834. More recently, these and other materials have been used as filtering media, including stone, sand, gravel, clay, sulphur, preparations of iron, sponge, wood, silicated carbon, cane, capillary-threads, cloth, felt, horse-hair, skins, paper, and asbestos. These have all been used in various

forms, and inventors have expended much ingenuity in applying them in such a manner that the filtered water should be clear, sparkling, and pleasant.

In 1867, the **Lancet Sanitary Commission** reported upon the relative efficiency of most of the filters then in the market, and arrived at such conclusions as the then state of knowledge concerning water-impurities allowed. The points which the Commissioners set themselves to investigate were suggested by the fact that these filters were "advertised as doing something more than straining water from suspended matter"; they were "stated to free water from some of the matters dissolved in it".

These investigators had to rely for their results upon chemical or the coarser optical tests, the only ones then known. We know now that no chemical tests are sufficient for the pronouncement of a water as pure and fit for drinking purposes. Such tests can show that a certain water is not fit for drinking, and for this purpose they are useful; but a water, which in the fullest degree satisfies chemical tests, may nevertheless contain the most deadly germs of disease in considerable quantity. Although it had long been recognized that some contagious diseases (typhoid and cholera for example) were spread by the agency of drinking-water, yet it was not until the early eighties of this century, when the "germ theory" was propounded, and the microbes connected with various diseases were discovered, that it was known exactly what the pathogenic impurity was. This discovery, which marked an epoch in the history of medicine, affected every branch of that art, and the filter question as much as any.

Until this time three special conditions had been required of a filter, viz.:—

- I. That it should remove macroscopic suspended matter from water.
- II. That it should, to some extent at least, chemically alter the composition of water, *e.g.* remove or lessen hardness, extract from the water the metals in solution (iron, lead, &c.), and render organic matter less harmful by changing nitrites into nitrates.
- III. That it should aërate a dead water, *e.g.* rain-water or boiled water.

To these three conditions a fourth has now to be added, vastly more difficult to fulfil and of equal or even greater importance, viz.:—

- IV. That it should remove microscopic suspended matter, *including bacilli and other micro-organisms.*

It is true that the large proportion of **micro-organisms** are practically harmless, but as a filter is at best only a machine, and incapable of distinguishing the harmful from the innocent, it must be so designed as to free water from *all* germs, infective or otherwise. In a word, the filter must be "germ-proof".



For if harmless bacteria can find their way through, those of disease may do so also; as, for instance, the cholera bacillus, which is amongst the smallest.

A clear understanding of the difference between the mechanical and organic passage of germs through a filter is necessary. *Mechanical* or direct passage takes place almost immediately through a filter the pores of which are not sufficiently small, and such a filter is quite unreliable; *organic* passage occurs by growth of the bacteria in the interstices of the material, and complete passage is only effected after a certain lapse of time varying with the denseness of the material. Filters of this last class may be quite reliable against the specific germs of disease, owing to the fact that water—even the worst sample likely to be taken for drinking purposes—does not provide a medium in which such germs can grow; as the germs can neither pass mechanically nor grow through the pores, the filter serves its end.

During the years 1884–86 a long and complete series of trials of various kinds of filters was made, and the results were published at the **Medical Congress held in Berlin in 1886**.<sup>1</sup> About twenty varieties of filters were examined, new and old. Most of these were found, in a bacteriological sense, useless,—the germs passed directly through with the water. Not only this: in many cases the filtering material formed a *nidus*, or convenient breeding-place for the germs, so that, though at first the number in the filtrate was about the same as in the original water, yet in a short time the effluent contained a hundred or more times as many as the water which the filter was pretending to purify. The appended table, illustrating this point, is taken from *The Lancet*, 1894, vol. ii. p. 1058:—

TABLE XIX.

INCREASE OF GERMS IN WATER PASSED THROUGH FILTERS WHICH HAD BEEN IN USE 5 OR 6 MONTHS.<sup>2</sup>

Name of filter in continuous use for five or six months.	Average number of organisms per cubic centimetre before filtration.	Average number of organisms per cubic centimetre in filtrate.
Silicated carbon domestic filter,.....	30–40	800–1000
Atkin's Admiralty filter,.....	40–50	600–800
Carbon-block table-filter (origin unknown),	20–30	5000–6000

A few of the filters—those in which clay or asbestos formed the filtering medium—were found to be germ-proof at first, but retained this quality only a

<sup>1</sup> *Tagblatt der Naturforscher-Versammlung*, Berlin, 1886, p. 323.

<sup>2</sup> See also Table XXI., page 289.

few days at most. By that time the germs had grown through the pores of the material, and showed themselves in the filtrate. There were other objections to these filters which rendered them practically worthless.

The results of investigation may be summed up thus:—

I. *Charcoal Filters*: quite useless—allow bacteria to pass at once, and form a breeding-ground where they multiply exceedingly.

II. *Spongy-iron Filters* do not keep bacteria back.

III. *Stone, Flint, Sand, Cloth, Sponge, and Paper Filters* of very various construction are not germ-proof even temporarily.

IV. *Asbestos Filters*: completely “germ-proof” for a time, but practically useless, owing to the difficulty and delicacy of manipulation required in renewing the material.

V. *Chamberland-Pasteur Porcelain Filters*: quite germ-proof until the bacteria have grown through; supply of filtered water small.

The conclusions drawn from these very complete experiments were, *firstly*, that most filters allow micro-organisms to pass unhindered; *secondly*, that some porcelain and asbestos filters are germ-proof for a time, but after some continued use, of days or hours, cease to be so owing to the bacteria, by a process of growth and multiplication, finding their way through the pores of the material; and *thirdly*, that there is no filter which is lastingly germ-proof.

Many other and later investigations have emphasized these conclusions, and it has been recognized as a fact that there neither is nor can be such a thing as a permanently “germ-proof” filter. And how can it reasonably be expected? A watch will not go without winding, nor a kitchen-stove cook unless its flues are swept at intervals, nor an engine work satisfactorily unless oiled and kept clean. If then any filter is found to be “germ-proof” for a certain time, and it is also found that by proper periodical attention (whether by cleaning or sterilizing, or renewal of its medium) it is capable of continuing to supply water free from harmful germs, that is all that can be reasonably expected or that hygienic science can require.

Only the workable usefulness of such filters need then be considered, and this will depend upon—

I. The rate of delivery of the sterilized water.

II. The simplicity of construction and ease of manipulation for sterilizing and cleaning purposes.

III. The prime cost, and the cost of renewal of filtering material or parts liable to injury.

These three points embrace only mechanical details, upon which the ingen-

uity of the inventor has been exercised to a vast extent. Anyone making a few simple trials will be able to prove how far any particular filter efficiently fulfils these conditions. But with the prime question of "germ-tightness" it is different. Only someone whose mind and method have been trained to scientific accuracy of detail, and who has a well-appointed laboratory at his disposal, can pronounce finally upon this point.

**The practical examination of filters** in regard to the first three points is not difficult:—

**I. Rate of Delivery.** Fill the filter and open the delivery-tap, and note the time that the first pint takes to run; repeat this observation every hour, leaving the filter running all the while. The pint will take longer to run each hour, the time increasing quickly or slowly according as the water is less or more pure. An average of these hourly times must then be taken. Even when a water is fairly pure, any filter which is doing its work must in the very nature of things become stopped up. The rate will also vary with the pressure—whether the feeding-reservoir is full or partly empty,—and also with the capacity of the filter. A rapid delivery is suggestive of imperfect filtration, though slowness of filtration is not of necessity directly proportioned to the purity of the filtrate.

The flow must be sufficiently rapid to supply the wants of the household. The number of minutes required for the filtration of one pint of water by different filters will be found in Tables XX. and XXII., pages 287 and 292.

## II. Simplicity of Construction.

(a) *The case.* The compartment containing the filtering medium, and the reservoirs for unfiltered and filtered water, must be easily accessible for sterilizing purposes and for cleansing. There should be no unnecessary angles or corners, and every part of any reservoir should be easily seen when the filter is empty.

(b) *The filtering medium* should be easy to remove and to replace in its case. The cleaning has to be done often, and any unnecessary increase of labour would impair the usefulness of the filter as a domestic appliance. The filtering medium must be of such a nature that it can be readily sterilized by baking, boiling, or burning; it must not deteriorate in quality, nor be very liable to injury during sterilization.

(c) *The process of cleansing and sterilizing* must be capable of easy performance without the employment of skilled labour. The household filter will be tended by the domestic servant.

(d) *The fittings* of filters must be as inabsorbent as possible, preferably of metal which can be boiled. Where compressible material is necessary, india-

rubber should be used; this can be chemically sterilized and scrubbed. Corks are quite inadmissible anywhere in contact with the water. They are most often seen around the tubes in carbon-block filters, or around delivery-taps.

(e) *There must be no possibility of water passing from one reservoir to the other without percolating through a sufficient thickness of the filtering medium.*

III. **The prime cost** of the filter, and of parts requiring renewal, can be had from the makers' lists. It is necessary to consider the relative liability to injury of the various kinds of material when estimating the cost.

These three points can be settled without much difficulty, and there is still something more which every one can do for himself before handing over the investigation to scientists in laboratories. The old test of the capability of any filter to keep back very fine but visible suspended particles, may be applied. Before the "bacteriological era", this was the most searching test known. It consists in mixing with the water to be filtered a quantity of matter, in a state of minute subdivision, which will remain in suspension. These particles should not be found in the filtrate. If they are found, we may be sure that the filter is far from being germ-proof, and may be considered as useless for cleansing an infected water. Unfortunately the converse to this does not hold true, or it would simplify matters greatly. A filter may keep back all such suspended matters and yet not be germ-proof. The substances used for making the suspension are various, and include clay, garden-mould, gunpowder charcoal, ultramarine, and the minute fat-globules of milk stirred into and freely diluted with water.

Drs. Sims Woodhead and Cartwright Wood employed the three last-mentioned substances in testing non-pressure filters, in their "**Inquiry into the relative efficiency of water-filters** in the prevention of infective disease" (*British Medical Journal*, Nov. 10th, 1894, p. 1055). From actual and elaborate experiments they compiled the valuable table on page 287.

It will be gathered from the table how varied are the types of filters now or recently in use. The filtering-media tested include—to quote the report—"all the materials which have been used to any extent in the construction of filters".

I. **Carbon** in various forms, pure or compounded with some other chemical substance, as in the case of the silicated and manganous varieties:—

(a) In blocks, or in the powdered or granular form, used either separately or in combination.

(b) Charcoal in fine powder deposited on an asbestos cloth, or placed in the interior of a stone block.

TABLE XX.  
TESTS OF NON-PRESSURE FILTERS BY DRs. WOODHEAD AND WOOD.

Name and Type of Filter.	Time (in minutes) required for Filtration of one Pint of Water.	Presence or Absence of Carbon in Filtrate.	Presence or Absence of Ultramarine in Filtrate.	Presence or Absence of Fat-globules of Milk in Filtrate.	Percentage of Organisms per c.c. allowed to pass into Filtrate.
Silicated carbon table filter (glass),.....	68	0	++	+++	7½
„ Ascension table filter (glass),..	120	0	+	+++	16
„ pocket filter, .....	N.R.	0	+(?)	+++	N.R.
Doulton's pint table filter (solid block),.....	27	0	+	+++	26
„ pint table filter (solid block and granular carbon),.....	18	0	+	+++	13
„ carbon bottle filter,.....	13	0	0(?)	+++	17
„ natural porous stone bottle filter,....	15	0	0(?)	++	31
„ pocket filter,.....	N.R.	0	+	+++	N.R.
Maignen's domestic <i>Filtre Rapide</i> ,.....	4	0	0	++	0(?)*
„ table <i>Filtre Rapide</i> (glass),.....	32	0	0	++	4
Atkin's Admiralty filter (No. 1),.....	5	0	++	+++	20
„ pocket filter,.....	N.R.	0	+	+++	N.R.
Asbestos filter,.....	6	0	0	++	7½
Fr. Lipscombe & Co.'s new patent cylinder filter,	23	0	++	+++	60
„ „ table filter (solid block),..	30	0	+	++	45
„ „ table filter (powdered and granular charcoal),.....	7	0	++	+++	30
„ „ table filter (solid carbon block), .....	16	0	+	++	25
Spencer's magnetic domestic filter,.....	9	+	++	+++	15
Spongy-iron table filter (glass), .....	14	0	0†	+++	6
„ „ „ (porcelain),.....	17	0	0†	+++	10
Morris's 2-gallon domestic filter,.....	2½	0	+++	++	12
Cheavin's Idiocathartes domestic filter,.....	4	+	+++	+++	57½
Crown Filter Co.'s table filter (quart),.....	3	0	+	+++	28
Barston's table filter (quart),.....	35	0	+	++	27
Alcarazas domestic filter (No. 1),.....	57	0	0	+	0(?)*
Slack & Brownlow's compressed charcoal domestic filter, .....	1	0	++	+++	26½
Wittmann's charcoal vase table filter,.....	10	0	0	0†	0(?)*
Defries & Son's carbon block glass table filter,	19½	0	++	+++	23
Pasteur-Chamberland filter (single candle, style F),.....	420	0	0	0	0
Berkefeld filter (single candle, No. 13), .....	140	0	0	0	0
London Pure Water Co.'s cistern filter,.....	N.R.	+	++	+++	N.R.
Maignen's field service <i>Filtre Rapide</i> , A.M.D.,...	N.R.	0	0(?)	++	N.R.
Silicated carbon syphon filter, A.M.D., .....	N.R.	0	++	+++	N.R.
Stoneware filter with sponge-plug, A.M.D., ....	N.R.	+	++	+++	N.R.
Morris's 4-gallon domestic filter, A.M.D., .....	N.R.	0	+	+	N.R.

A.M.D. denotes Army Medical Department.

N.R. denotes "Not recorded".

The times given in the first column are approximate only.

The number of crosses in the table indicates the larger or smaller proportion of the substance in suspension which passed through the filter and appeared in the filtrate.

The substances used in these experiments were the finest gunpowder charcoal (Enfield) particles, 24  $\mu$  (micromillimetres) to 0.9  $\mu$ ; artificial ultramarine particles, 16  $\mu$  to 0.6  $\mu$ , or even less; and milk minute granules and globules of fat, 0.5  $\mu$  to 30  $\mu$  in diameter.

\* Positive result not obtained, but when treated with suspensions of test organisms, all these filters allowed of their direct passage.

† Possibly due to chemical interaction.

‡ Filtering material became clogged.

II. **Iron** in the form known as spongy iron or as magnetic oxide, either

- (a) Alone, or
- (b) In conjunction with asbestos cloth.

III. **Asbestos** in various forms, either

- (a) Alone as a fine film, or
- (b) As a film in combination with cellulose, or
- (c) Along with some finely-powdered or granular medium.

IV. **Prepared Porcelain and other Clays.**

V. **Natural Porous Stone**, either

- (a) Alone, or
- (b) With other substances, such as powdered carbon, &c.

VI. **Compressed Siliceous and Diatomaceous Earths.**

The result of these careful and scientific experiments is not only to emphasize the conclusions arrived at by the 1886 Berlin inquiry, quoted above, but also to show that, among all the filters enumerated, only two withstood the first test necessary to prove the germ-tightness of a filter, namely the Pasteur (Chamberland) and the Berkefeld. The filtering appliance in each of these is a tube or "candle", through which the water passes, but in the former the candle is made of porcelain, while in the latter it is of compressed Kieselguhr earth.

Various and more searching experiments were made with most of these filters, the full particulars of which were published in *The British Medical Journal* on August 18, November 10, 17, 24, and December 15 and 29, 1894. All the experiments bear out fully the results of the original trials already quoted.

**The Pasteur (Chamberland) and the Berkefeld filters** underwent a searching investigation during the inquiry carried out by Dr. Plagge for the German War Office (Berlin, 1895). Both these filters are essentially for high-pressure services, though they also filter slowly with low-pressure. Dr. Plagge's numerous experiments with these two forms of filter led him to sum up greatly in favour of the Berkefeld, owing mostly to its greater output, though he allowed that the Pasteur would be an ideal filter, if, with an equal degree of germ-proofness, it gave a tenfold yield of water. In this respect it falls short of the standard of usefulness, and this paucity of yield is shared by all porcelain filters hitherto made. "A filter of six Pasteur candles will yield in 24 hours about 40 gallons, whereas a single ordinary Berkefeld candle yields 40 gallons in  $1\frac{1}{2}$  hours—both filtering under a pressure of  $2\frac{3}{4}$  atmospheres" (Plagge).

Filters of the porcelain-candle type have recently found many imitators, and some now in the market appear to promise good results. They all need pressure of water to perform their function usefully, and are therefore collectively called

"pressure filters". The most recent investigations on the usefulness of pressure filters have been made by Drs. Sims Woodhead and Cartwright Wood. The results of these investigations were published at length in *The British Medical Journal* of January 22, 1898, and with their previous report on non-pressure filters (already referred to and quoted from) are reprinted in pamphlet form, and obtainable at the offices of the British Medical Association, 429 Strand, London. This pamphlet will be found to give the fullest information as to the methods of testing and the results obtained with the various filters, and should be read by all who wish to know more of the scientific and medical aspect of the question than can be included in a practical work such as the present. In this later investigation, pressure filters alone were tested, and with such results that certain filters can be confidently recommended for general use as perfect safeguards against water-borne disease. It must be remembered that the makers of every variety claimed this perfection for their filters, but only six were found to justify the statement.

TABLE XXI.

## TESTS OF PRESSURE FILTERS BY DRS. WOODHEAD AND WOOD.

Filter fed with tap-water containing on the average 40-60 micro-organisms per c.cm.	Average number of organisms in filtrate per c.cm. on each day.						
	Name of Filter.	1st.	2nd.	3rd.	4th.	5th.	6th.
Silicated Carbon Filter, ...	0?	26	60	200	1000	innumerable.	
Maignen's Filtre Rapide, ...	0	40	150	9000			
William Dalton's, ...	20	30	80	100	150	...	300
Jacob Barstow & Sons', ...	5	25	250	300	400		
Piefke Filter, ...	20	30	70	400	500		
Pasteur-Chamberland, ...	0	0	0	+			
Berkefeld, ...	0	0	0	+			
Aëri-Filtre-Mallié, ...	0	0	0	0	0	0	none up to 9th day.
Porcelaine d'Amiante, ...	0	0	0	0	0	0	none up to 30th day.
Pukall Filter, ...	0	0	0	+			
Slack & Brownlow's, ...	0	0	0	+			
Duff's Patent, ...	0	0	+				

The sign + denotes the day on which the organisms appeared in the filtrate, not by direct passage, but by growth through the filtering medium.

The tests to which the filters were subjected were numerous and searching. They included:—

1. *Tests with organisms usually found in all waters*, as to whether they passed directly through the material, or only appeared in the filtrate after such time as they might be expected to take to grow through the filtering medium (a very important distinction).

2. *Tests with chromogenic organisms*, easily demonstrated in the filtrate by the property they possess of forming coloured growths when cultivated on gelatine.
3. *Tests with cholera and typhoid-fever bacilli*, (a) in sterilized tap-water; (b) in New River water; (c) in contaminated water taken from the Thames near Waterloo Bridge, at low tide,—as bad a water as is ever likely to be used for drinking purposes; and (d) in undiluted London sewage.
4. *Tests with cholera and typhoid-fever bacilli and filters on which a scum had been allowed to accumulate* from the lengthened filtration of ordinary tap-water and of impure water, which scum would be thought to be a good pabulum for the growth and multiplication of such bacilli.

Some of the filters were not able to stand the earlier of these tests, whilst others triumphantly withstood the whole series. They are consequently divided into two groups:—

1. *“Those filters which allow the direct passage of test-organisms into the filtrate.”*

These were by the following makers:—The Silicated Carbon Filter Company; Maignen's “Filtre Rapide” and “Anti-Calcaire” Co., Ltd.; William Dalton; Jacob Barstow & Sons; Arnold & Schirmer (Piefke Filter); Chabrier Jeune et Cie. (Filtre Universel).

For these filters the most perfect results were claimed; for instance, the vendors of the first-named say that it “yields an absolutely sterilized water under any pressure”, also that it “is invaluable in the tropics and in all climates as a safeguard against cholera, typhoid, and other zymotic diseases”. A reference to Table XXI. will show how far the first part of the statement agrees with actual experiment. Cholera bacilli were easily demonstrated in the filtrate, when the reservoir was fed with an emulsion of these germs.

2. *“Those filters which do not allow test-organisms to pass directly into the filtrate.”*

These were by the following makers:—

1. J. Defries & Sons, Ltd. (Filtre Chamberland Système Pasteur).
2. Berkefeld Filter Company, Ltd.
3. Aëri-Filtre-Mallié, Théories Pasteur, Porcelaine d'Amiante.
4. Royal Porcelain Factory, Potsdam (Pukall Filter).
5. Slack & Brownlow.
6. Witty & Wyatt, Ltd., Agents (Duff's Patent Germ-proof Filter).



**Tested with pathogenic or disease-bearing germs**, these passed freely through the filters in the first list, but were completely arrested by those in the second list. After even six or eight weeks' exposure to the action of cholera and typhoid-fever bacilli, a sterile filtrate was obtained from Chamberland and Berkefeld filters, although numerous living pathogenic germs were still demonstrable on the outer surface of the candles. Like experiments were performed with the rest of the filters in the second list, with similar results.

Having now six trustworthy filters from which to choose, it only remains to contrast their **practical utility** as regards (1) liability to injury, (2) ease of cleansing, and (3) output of filtered water.

1. *Liability to injury*:—The advantage which porcelain candles possess over the Berkefeld, in being less brittle, is considerable. Duff's patent germ-proof filter, of natural porous stone, is at present so fitted together, that it is, owing to the unequal expansion of the metal and stone parts, very liable to crack when raised to the high temperatures necessary for sterilization.

2. *Ease of cleansing*:—The porcelain filters cannot be so easily or so perfectly cleansed, as the Berkefeld is, by simply boiling. The Berkefeld candle must be put into cold water and boiled up in it, not plunged direct into boiling water. It should be allowed to cool down with the water after boiling for an hour.

3. *Output of filtered water*:—The quantities rendered by the various filters can be seen at a glance from Table XXII. The figures are the average results of many experiments with different candles. The rate of filtration of individual candles, by the same maker and sold as identical, was found to vary within somewhat wide limits,—namely, as 1 : 3, or even more,—owing to variations in thickness, presence of air-spaces, &c. The table also shows how the output diminishes, as the fine pores of the filtering medium become blocked up by impurities. The rate of output is restored by brushing the surface of the candle with a hard brush, or by sterilizing by fire or boiling.

**The most useful form for household use** is one which is affixed to a tap connected with the main, similar to the Berkefeld filter shown in fig. 183. The water enters the outer case, which is of cast-iron enamelled inside and painted and varnished outside, and percolates through the material of which the filter is composed (Kieselguhr or porcelain), until it reaches the hollow inside the candle and is forced up through the outlet-pipe *r*. By turning the thumb-screws, the filter can be taken bodily out, cleared externally if only clogged, or sterilized by boiling if it has worked its period. Means have been applied to both filters, by which they can be scrubbed by revolving brushes without removal from the case;

TABLE XXII.  
TABLE SHOWING THE AVERAGE<sup>1</sup> AMOUNT OF WATER GIVEN BY VARIOUS FILTERS  
(compiled from observations made by Drs. Woodhead and Wood).

Name of Filter.	Average time required to filter one pint.		Average time taken to filter one litre.			Calculated quantity filtered in 24 hours.		
	Pressure.	Time.	1st day.	2nd day.	3rd day.	1st day.	2nd day.	3rd day.
Filter Chamberland, <sup>2</sup>	24 lbs.	3 mins. 53½ secs.	6 mins.	9 mins. 11 secs.	16 mins. 59 secs.	46½ gals.	25½ gals.	16½ gals.
Berkfeld No. 1, <sup>3</sup>	24 lbs.	28 secs.	50 secs.	1 min. 34 secs.	2 mins. 55 secs.	293 gals.	172 gals.	95 gals.
Berkfeld No. 14,	24 lbs.	48 secs.	1 min. 41 secs.	3 mins. 53 secs.	8 mins. 21 secs.	136½ gals.	61 gals.	31½ gals.
Porcelaine d'Amiante,	16 lbs.	1 hour 8 mins.	Too slow for ordinary utility.					
Pukall,—small,	16 lbs.	8 mins.						
" medium,	16 lbs.	5 mins. 6 secs.						
" large,	16 lbs.	2 mins. 16 secs.						
Slack & Brownlow's,	24 lbs.	1 min. 42 secs.						
Duff's patent filter,	24 lbs.	15½ secs.						

Output declines very rapidly.

After 24 hours  $\frac{1}{3}$ , and after 48 hours  $\frac{1}{5}$  of original output.  
Diminishes rapidly, but experiments insufficient for exact estimation.

<sup>1</sup> The filtering capacity of candles ostensibly the same varies very considerably; thus, the time taken to filter one pint of water (under a pressure of less than 24 lbs.) ranged between 118 and 426 seconds with Pasteur (Chamberland) candles, 25 and 31 with Berkfeld No. 1, 38 and 51 with Berkfeld No. 14, and between 85 and 136 with Slack and Brownlow's.

<sup>2</sup> See fig. 185, page 295.

<sup>3</sup> See fig. 183, page 293.

these for many reasons cannot be recommended. Another plan of cleansing is more satisfactory. Taking advantage of the fact that filtration is chiefly effected on the surface of the filter, the plan has been devised of making a temporary and easily removable surface. A certain amount (varying with the filtering surface) of Kieselguhr, a finely-powdered diatomaceous earth, is mixed with the water in the receiver, and the filter is then placed in position and the supply-tap turned on. As the pressure comes to bear, the water filters through, and the fine particles of Kieselguhr in suspension are deposited all over the surface of the candle and form a superficial filtering film, which stops the greater part (if not all) of the suspended impurities. This false surface is exceedingly easy to remove by rinsing or lightly brushing. It can be brought off, almost as a mould of the candle, by pumping a little air into its bore, whilst the whole is held under water. A pump for bicycle pneumatic tyres, screwed on to the delivery-pipe, serves the purpose well. By this means the bulk of the impurities are easily removed from the actual filter, and at the same time the diminished output of filtered water, which naturally takes place from clogging of the pores, is to a great extent prevented. The following table, containing the results of tests with a No. 1 candle, illustrates this:—

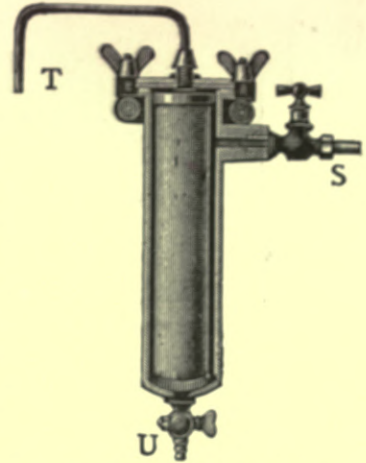

Fig. 183.—Berkefeld Single-tube Filter. s, water-supply; T, filtered-water outlet; U, flushing tap.

TABLE XXIII.

PASSAGE OF WATER THROUGH FILTERS WITH AND WITHOUT KIESELGUHR.

Filter with and without Kieselguhr.		1st day.	2nd day.	3rd day.
Time taken to filter one litre in seconds.	Without Kieselguhr,	52	68	147
	With Kieselguhr,	56	65	88
Calculated quantity filtered in 24 hours in gallons.	Without Kieselguhr,	316	178	90
	With Kieselguhr,	314	248	192

The Berkefeld filter, illustrated in fig. 183, is said to yield upwards of 100 gallons of pure sterile water per day, if the supply has a pressure of 35·40 lbs. This, of course, is sufficient for the pure-water requirements of ordinary houses. Where more water is required, filters containing more candles must be used, such

as that shown in fig. 184, which has seven candles; filters containing almost any number of candles are now made. Fig. 185 is an elevation of a Pasteur (Chamberland) filter attached to an ordinary tap, while fig. 186 is the same filter connected with a stoneware reservoir for the filtered water. Such reservoirs, however, should not be used except in cases where the intermittent nature of the supply renders them absolutely necessary.



Fig. 184.—Berkefeld Filter, with Seven Tubes

Numerous other adaptations of both the Pasteur and Berkefeld filters can be obtained, including cistern-filters, portable filters, &c.

In concluding their report, **Drs. Woodhead and Wood** say:—"The efficiency of a filtering medium . . . depends on the size (and regularity) of the channels by which it is traversed; . . . all porcelains do not arrest the direct

passage of organisms. The most perfect filter, from a scientific point of view, which we have seen, is undoubtedly the Porcelaine d'Amiante, but unfortunately the rate of filtration is so slow that the use of this filter for domestic purposes appears to be out of the question. We should like again to insist upon the necessity of all the water required for domestic purposes being filtered where it is considered necessary that the water to be used for drinking purposes should be subjected to this process. Inasmuch as the more pervious porcelains can be relied on to arrest the passage of infective disease germs, they are naturally much more suitable for all practical purposes. The compressed diatomaceous earths as used by the Berkefeld Filter Company furnish a much less perfect filter from the strictly bacteriological point of view than the porcelain; they are nevertheless capable of arresting the passage of disease-organisms, and have the great advantage of affording a larger output.

"We regard this rapidity of filtration as an all-important point in discussing the applicability of any filter for domestic purposes.

"The same amount of output as from the Berkefeld filter may no doubt be obtained by combining a number of porcelain candles of slower filtering capacity, but we have already insisted upon the risk of a leak, and the whole object of filtration being frustrated from the multiplicity of fittings thus involved, and we are accordingly unable to recommend any such arrangement.

"We are of opinion that experiments carried out with the more porous materials, such as diatomaceous earths or natural stone, rather than with denser media such as porcelain, are more likely to lead to the production of the filter of the future"

Where water-pressure is not available and a non-pressure filter must be used, its position should be carefully selected. It ought to stand in the light and in as pure air as possible, and not in a pantry or kitchen, or near a sink, opening of a drain, drain-ventilator, w.c., dust-bin, &c. Water, like milk, has the power of absorbing gases from the air, and when these are foul the water will taste of them. This power of absorption is especially great when water is cooling, a state

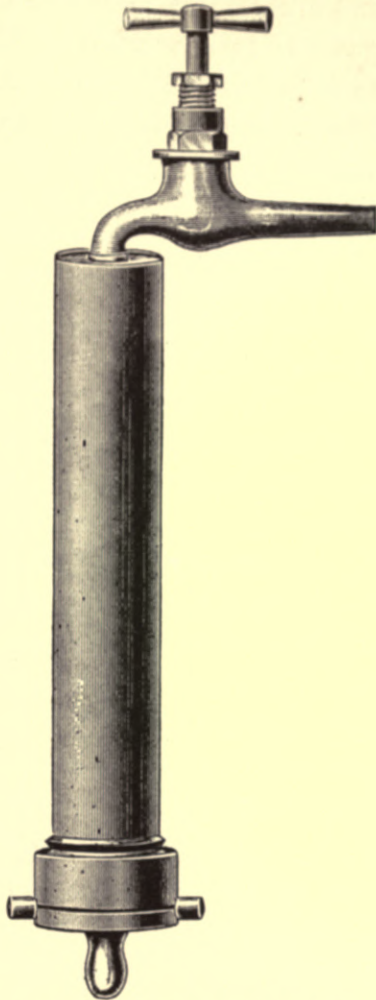

Fig. 185.—Single-tube Pasteur (Chamberland) Filter.

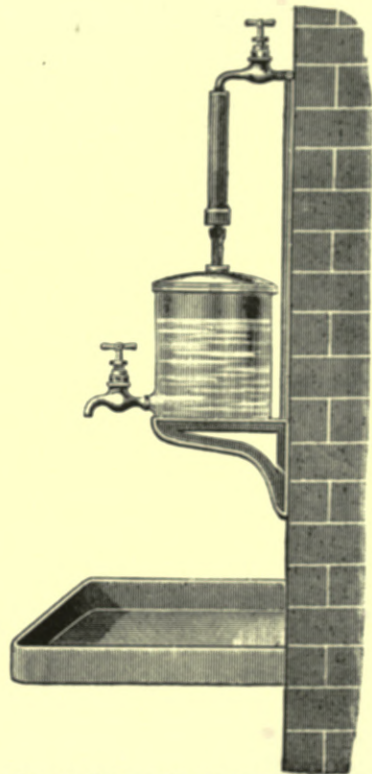

Fig. 186.—Pasteur (Chamberland) Filter, with Stoneware Reservoir.

in which it is found in the filter when boiled previous to filtration. A greater safeguard would be to boil the water after filtration, and then cool and aerate it to render it palatable by letting it fall from the height of a few feet, in fine streams, such as are formed by its passage through a fine hair sieve, or by letting it run through a loose mass of broken bricks. Boiling drives off the carbon dioxide gas naturally present in water, and its loss renders the water dull, and mawkish to the taste. The aëration is merely to replace this lost constituent.

Some of the very fine-meshed filters, notably the porcelain ones, have the same effect upon the taste of water as boiling has, and for the same reason, only the bubbles of gas are not driven off, but stopped mechanically; the same remedy can be used. This applies also to ordinary non-pressure filters.

Comparing the relative merits of **boiling and filtration** as means of sterilizing water, we find that each has its advantages. If garden-mould be stirred into water, and the mixture boiled, the micro-organisms will be reduced in number from 30,000 to 160 per cubic centimetre after five minutes' boiling, but even after boiling for two hours there will still be some resisting spores left alive, which can multiply rapidly under suitable conditions. In this respect a good germ-proof filter holds a distinct advantage. It is a fact, however, that the bacilli of cholera and typhoid are readily killed by a temperature of 180° F., that is to say, 32° F. below the ordinary boiling-point of water. The best results can therefore be obtained by combining boiling and filtration.

When the only water obtainable is full of **suspended matter**, which would quickly clog any filter, a method introduced by Mr. G. Embery in the Gloucester

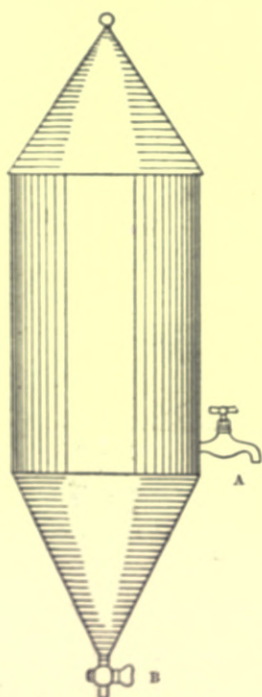

Fig. 187.—Simple Apparatus for softening water.

district can be recommended. By its use the water is not only cleared, but much improved in quality. It is only necessary to know the number of degrees of temporary and permanent hardness<sup>1</sup> of the water in question. A tank holding about 50 gallons, with a funnel-shaped bottom and two taps (see fig. 187), is filled with the water, and to it is added a quantity of slaked lime in grains per gallon equal to three-quarters of the number of degrees of *temporary* hardness; e.g. for 12 degrees of temporary hardness, add 9 grains of slaked lime to every gallon of water. Also twice as many grains per gallon of washing-soda as there are degrees of *permanent* hardness must be added; e.g. for 6 degrees of permanent hardness, add 12 grains of washing-soda to every gallon of water. The water thus treated is allowed to stand for about twelve hours, and the softened clear water is then drawn off at the tap A; the tank may then be refilled with water, and a fresh charge of lime and soda added. After three or four charges have been thus treated, the tap B is opened, and the mud, which has settled, is allowed

to escape, and the tank thoroughly cleaned. This procedure does not, of course,

<sup>1</sup> For the explanation of *temporary* and *permanent* hardness, see § III., page 219.

obviate the necessity of boiling and filtering the water before using it for drinking.

Most filters lessen **the hardness of water** to some extent. Spongy iron, silicated carbon, and magnetic carbide are all good mechanical filtering media, whilst in addition a considerable oxidation of organic matter takes place owing to their capability of condensing oxygen.

Against **lead-contamination**, no filtering medium is so efficacious as animal charcoal, though even this can only remove small traces. Vegetable charcoal is less useful in this respect.

The following **summary of the advice** here given as to the use and choice of filters will be useful:—

Where a constant public supply, drawn direct from the mains, is used, or where deep-well water or spring-water is available, no filter is needed, nor should any be used, except in times of epidemics.

When the supply is from any doubtful source,—river, stored rain-water, shallow-well or surface water,—a competent filter is desirable. Wherever it is possible, the water should be raised to such a height as will allow a pressure filter to be used.

The choice of filter will largely depend upon the character of the water to be dealt with. On this head it is always advisable to consult the public analyst of the district, whose knowledge of the local water-supplies is usually accurate and exhaustive. For a small fee he will make a special analysis of the water in question, giving much useful information as to its ingredients, hardness, &c.

The most suitable filter having been procured, it must be given fair play. Let it be placed in a light, clean, airy situation, and make one person responsible for the duty of attending to it, keeping it supplied with freshly-boiled water, and cleaning it thoroughly at specified intervals. The filtering material must be occasionally renewed.

In epidemics of infectious disease it is wise to take the additional precaution of reboiling the water after filtration, and afterwards to aërate it and cool it in the open air, except where one of the six trustworthy filters is used with discretion.





SECTION VI.  
SANITARY PLUMBING

BY

HENRY CLAY

FIRST HONOURS IN PLUMBING, CITY AND GUILDS OF LONDON INSTITUTE; REGISTERED INSTRUCTOR IN PLUMBING  
AUTHOR OF "PRACTICAL PLUMBING"; "HOT-WATER FITTING"; ETC.





## SECTION VI.—SANITARY PLUMBING.

---

### CHAPTER I.

#### INTRODUCTORY.

As defined by the Plumbers' Registration Bill, "**Sanitary Plumbing** means the art of plumbing as commonly understood, and such knowledge of sanitary appliances and their proper construction and adjustment, as may enable plumbers to prevent contamination of water and air in dwelling-houses and other buildings by emanations from drains and sewers". The subject of sanitary appliances will be treated in the following section; it is our province to consider the practical details of the proper adjustment of these and of their accessories.

Undoubtedly rapid advance has been made, during the last twenty years, in the direction indicated in the foregoing definition; but though much has been done, much remains to be done, particularly among the rank and file of the craft, and in the smaller towns and villages. Many workmen are sufficiently skilful in the practical details of plumbers' work, but are sadly ignorant of the principles underlying that work. Of course, it may be said that it is the architect's province to study principles and to promulgate a scheme embodying them, while it is the plumber's duty merely to carry out the scheme. This is true to some extent; but there are thousands of buildings erected every year, on which no architect ever sets foot, and even when an architect is employed, it is infinitely better, both for him and the house-owner, that his requirements should be carried out by a workman who has a head on his shoulders, and not by one who, in the language of the craft, is "all thumbs". But knowledge, however important, is not everything; care and attention to detail are equally necessary, if the workman is to be worthy of his craft, and if his work is to be dignified with the name of Sanitary Plumbing. Ignorance is bad enough, but carelessness, in such important work as plumbing, is almost criminal.

**The City and Guilds of London Institute** has assisted largely in removing the ignorance of plumbers, by promoting classes and examinations in centres of

population throughout the country. Upwards of a thousand apprentices every year are thus initiated in the theory and practice of plumbing. After each examination, the written papers, and the specimens of practical work, are sent to London to be judged. No candidate can obtain a certificate for practical work until he has satisfactorily passed an examination in the theory of plumbing, the great aim of the institute being to educate the plumber in the principles of his trade. The examination in practical work is always a stiff one, and a pass is a sufficient guarantee of competency.<sup>1</sup>

In **good sanitary plumbing**, the following points will be observed:—

All *lead pipes* will be of perfect shape, with bends of uniform shape and curve, and will be exposed to view on backboards, so as to be easily accessible for repairs. When pipes must be hidden by wood or other casing, they will be carefully secured and fixed in straight lines. All joints will be strongly wiped, and will be both air-tight and water-tight, and placed in good positions away from the bends.

Every *fitting* will be separately trapped.

*Waste-pipes and traps* will be properly ventilated, and the lower ends of all waste-pipes will be open to the atmosphere, and will discharge over or under the grids of disconnecting traps or gullies, while the upper ends will probably be carried above the roof.

*Soil-pipes* will be outside the building, generally connected directly with the drain, and always carried up full size above the roof.

<sup>1</sup> The scheme for the registration of plumbers has now been in operation for some time, and must not be overlooked in any survey of the status of plumbers to-day. So long ago as 1875 Mr. George Shaw secured the appointment of a committee of the Plumbers' Company "to inquire into and report to the Court how far technical education can be promoted among the workmen of the trade, and to ascertain the mode or modes by which it can be best attained". The committee reported in due course, but as no action was taken, Mr. Shaw published a pamphlet, entitled "Revived Guild Action", in support of his views, and presented a copy of it to each member of the Company in September, 1878. In the following April a second committee was appointed, and in May, 1879, the Court of the Company agreed to its recommendations, which were as follows:—"That the freedom of the Company be given to competent working plumbers of fifteen years' standing, and diplomas under the Company's seal to workmen who have followed the trade for at least ten years, and who can give satisfactory certificates of ability and personal character". These resolutions, as Mr. Shaw candidly remarks, "being unaccompanied by any form of examination, led to no immediate practical results".

In the meantime the City and Guilds of London Technical Institute had been established, and the Plumbers' Company agreed that those who passed the City and Guilds' examination in plumbing, in the honours class, "should be eligible to receive the freedom of the Company. This", continues Mr. Shaw, "*was really the first practical step towards the registration of plumbers*". It is unnecessary to trace further in detail the progress of the movement, which culminated in the opening of a "Register for Plumbers" in the year 1886, and in the institution of examinations throughout the country for plumbers desiring to be registered. Sufficient has been said to show the honourable efforts of the Plumbers' Company, even before the formation of the City and Guilds' Institute, to improve the status of plumbers, in the hope that seamped plumbing will be thereby to a great extent prevented. There can be no doubt that the registration of plumbers has been a public benefit, and the extension of the system is undoubtedly improving the quality of plumbers' work generally, although it must not be forgotten that carelessness cannot be eradicated by any examination or standard.—ED.

## CHAPTER II.

## TRAPS AND WASTE-PIPES FOR BATHS, LAVATORIES, AND SINKS.

The object of fixing traps to fittings is to prevent bad air from waste-pipes and disconnecting traps from entering the house. The interior of a waste-pipe in course of time becomes coated with a slimy substance, which decomposes and gives off stale and musty odours. These are not so dangerous as sewer-gases, but they are capable of causing severe headaches, nausea, sore throats, &c., and it is to prevent their entrance into the house that traps are fixed.

A good trap consists of a pipe bent in such a manner that the smallest quantity of water will give the greatest depth of seal. The seal should not be less than 2 inches, but where there are tiers or ranges of fittings, the depth of the seals may be slightly increased with advantage. A trap should be so constructed as to clear itself, and on no account should it retain any of the solid portion of the discharges. There should be no corners or angles in which dirt can accumulate, and in all cases the trap should be constructed so as to show a water leakage in the event of any portion being corroded away. Traps should not on any account have any moving parts. There are only two traps which fulfil these conditions, the one known as the *round-pipe trap*, and the other as the *anti-D trap*.

The mid-feather trap, shown in fig. 188, is now deservedly obsolete. It favoured the accumulation of foul matter, and was scarcely ever proof against the passage of sewer-air. No amount of water passing down the waste-pipe could possibly keep it clean. Indeed, it may be called the most faulty and dangerous of all traps. A trap of this kind would often hold two bucketfuls of coagulated filth, while still permitting the flow of water. It became, in fact, a small cesspool, and the waste-pipe might just as well have been connected directly with the drain. It was usually constructed of bricks with flag bottom and cover, and mid-feather of flag or slate, and the joints were often formed with clay.

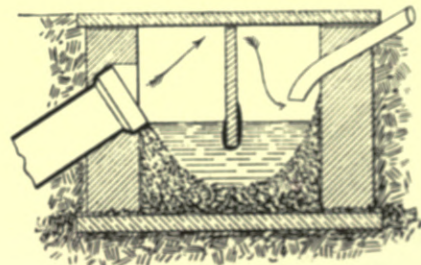

Fig. 188.—Section of Mid-feather Trap.

The D-trap (fig. 189), being constructed of lead, is more cheaply and more easily made with a rounded bottom, and this gives it some advantage over the mid-feather trap in point of efficiency. If we examine the section of the

mid-feather trap, and note the shape of the interior,—the top, the sides, the curved line formed by the accumulation of filth, and the position of the outgo,—we shall see that they correspond with the cheek and outgo of the D-trap, the only difference being that the inlet to the D-trap is at the top. The D-trap was at one time the usual form of trap adopted

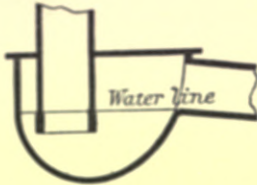

Fig. 189.—Section of Old D-trap.

for lavatories, sinks, and water-closets. Like the mid-feather trap, it becomes a cesspool, although on a smaller scale. Some improvement has been effected in the D-trap by reducing its capacity, and by sloping the side towards the

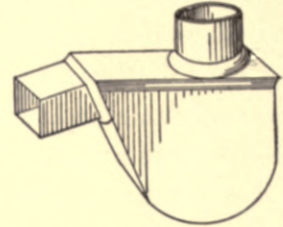

Fig. 190.—View of Improved D-trap.

outlet, as shown in fig. 190, but no amount of improvement can make it satisfactory. Its one good point—that it cannot be unsealed by syphonage—does not counterbalance its foulness and its other defects; for example, the dip-pipe may be corroded through above the water-level, and a passage for foul air be formed, all the more dangerous for being entirely out of sight. This form of trap should never be used, and wherever one is found, it should be taken out and replaced by a round-pipe trap of modern form.

**The mansion-trap** (fig. 191) is an improvement over the D-trap, but the body is square and larger than the inlet, so that it cannot possibly be kept clean by the ordinary flow of waste-water, and deposits therefore take place on the bottom and sides. The smaller the quantity of water held by a trap, the more frequently will it be changed; and the smaller the water-way the more rapidly will the water pass through it, and the more thoroughly therefore will the trap be scoured out by the passing water. At the best, the flow through a mansion-trap is slow, and the water held in it is much greater than is desirable, while the square angles seem to invite the deposit of filth.



Fig. 191.—Section of Mansion-trap.

**The anti-D trap** was devised by Mr. Hellyer for the purpose of securing a self-cleansing trap, holding only a small quantity of water, but having a sufficient depth of seal, and being so formed at the outgo as to reduce or prevent the risk of unsealing by syphonage. The body of this trap is contracted to half the area of the inlet, so as to increase the velocity of the discharges passing through it, and obtain a great depth of seal with a smaller volume of standing water. Fig. 192 is a view of the medium size anti-D trap. The square angle at A helps to prevent unsealing by syphonage. This size is sufficiently large for water-closets.

The "largest" size of anti-D trap, shown in fig. 193, is seldom used. It has an inlet of  $4\frac{1}{4}$  inches, and an outlet of  $3\frac{1}{2}$  inches, and is not very much unlike the mansion-trap in appearance. Fig. 194 is a view of the  $1\frac{1}{4}$ -inch trap, with enlarged mouth for baths and sinks, while a trap of the same size but without



Fig. 192.—View of Medium-size Anti-D Trap.

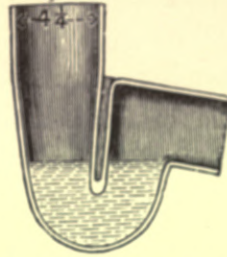

Fig. 193.—Section of Large-size Anti-D Trap.



Fig. 194.—View of  $1\frac{1}{4}$ -inch Anti-D Trap, with enlarged Mouth.

the enlarged mouth, is used for lavatories. The anti-D trap has a greater depth of seal than the ordinary round-pipe trap, and this is of course a great protection against unsealing.

**Round-pipe traps** are those most commonly used. If not too large for their work, they are quite self-cleansing, and when properly ventilated they cannot be unsealed by syphonage or momentum. The round-pipe traps, known as the "Dubois drawn traps" (figs. 195 and 196), are of a suitable form for all purposes,



Fig. 195.—Section of Dubois drawn-lead S-trap.

and when ventilated their seals are efficient. They are self-cleansing, unless the trap has a larger bore than the inlet. These traps have the same bore throughout, and are a little too easy at the bends. They would be improved by having an enlarged inlet, and by keeping the inlet and outlet closer together,



Fig. 196.—Section of Dubois drawn-lead P-trap.

while the bottom curve of the outgo as well as the dip should be made straighter, like the outgo and dip of the mansion-trap. The section of the trap below the dip, and also the section of the outgo, should not be true circles, but segments, as shown at B in fig. 197. By thus straightening the bottom of the dip in a 2-inch trap, the depth of seal is increased  $\frac{3}{16}$  inch without increasing the quantity of water in the trap, and at the same time the contraction of the bore at this point tends to prevent deposit. The straightening of the outgo reduces the surface-area of the water, and therefore lessens evaporation.

The round-pipe trap shown in fig. 197 has a square dip and an enlarged inlet,

and the outgo is of the weir type and not curved. Anyone is at liberty to make this form of trap, as the various features are public property. The illustration gives the dimensions required for w.c. traps of this form. These traps can be made by hand, in one or two pieces, and will be found to be very serviceable, although some people may object to them on account of the seams. Undoubtedly, however, a good seamed pipe or trap is better than badly-worked solid-drawn pipes and traps.

**Bell-traps** were at one time extensively used for sinks, as well as in yards and cellars. Fig. 198 illustrates the form of bell-trap for sinks. It consists of a cup with the outlet-pipe jutting through it, and covered with a brass or iron grating

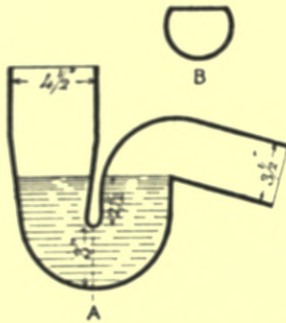

Fig. 197. — Round-pipe W. C. Trap, with square Dip and enlarged Inlet.

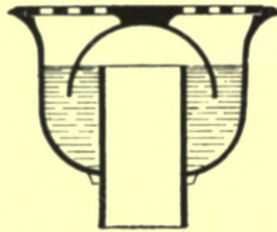

Fig. 198. — Section of Bell-trap for Sink.

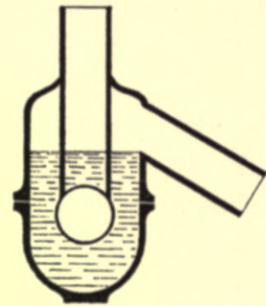

Fig. 199. — Section of the Bower Trap.

beneath which an inverted cup or bell is attached. When the grate and bell are in position and the trap is filled with water, the rim of the bell dips into the water contained in the trap, and thus forms the necessary water-seal. Bell-traps are not self-cleansing, but retain filth very largely. The grate and bell are often removed, and at once the gases from the outlet-pipe are free to enter the room in which the trap is placed. They are condemned by all sanitarians, and ought not to be used in any situation whatever.

All **mechanical traps** sin against one of the first principles of a good trap, namely, that it shall have no moving parts. On this account alone they must be condemned. The Bower trap (fig. 199) is a mechanical trap which has been much used. It has an india-rubber ball, which is floated by the sealing water against a brass seating on the end of the lead inlet-pipe. In use these traps are very dirty, the interior soon becoming furred up, while the cup at the bottom retains a considerable quantity of dirt. In Buchan's mechanical trap, the ball is placed on the end of the outlet-pipe, which is so arranged as to form the seat. This trap is not intended to be proof against syphonage, but its object is to prevent the gases from passing through the trap when it is syphoned. In the



Bower trap the ball falls away from the seat when the water is syphoned out, and gases can pass from the outlet pipe up the inlet, but in Buchan's trap the ball rests on the seat, and is more effective. The slightest dirt—even a tea leaf—will, however, prevent it from properly seating itself so as to prevent the escape of gases. There are also traps with flaps on the outgo, as well as traps with mercury seals, all of which are unnecessary when the waste-pipes are disconnected and ventilated. As these traps were designed to prevent sewer-gases from passing through them into the house, they have become obsolete, that end having been attained by the compulsory disconnection and ventilation of waste-pipes.

The depth of seal required to resist the action of syphonage, or a combination of **syphonage and momentum**, must always depend on the kind of fitting used, and its position, particularly in regard to the position of other fittings served by the same waste-pipes. A trap that would be perfectly safe if fixed to a sink on the ground-floor, would not be so if the waste-pipe from the ground-floor sink were connected with the waste-pipe from the bath on the floor above. A trap fixed to a bath might be perfectly safe in regard to the discharges from the bath; but if it be connected with the waste-pipe from a lavatory or sink on the same floor, there may be a failure of the trap to the bath owing to the discharges from the sink or lavatory sucking the water out of the bath-trap, or *vice versâ*. In sinks, large volumes of cold water are often succeeded by a pail or two of hot water, and if a small quantity of cold succeed a discharge of hot water, the traps will be unsealed more readily than by a heavy discharge of water.

Temperature plays an important part in trap-syphonage; a slight increase or decrease of pressure, due to a rapid expansion or contraction of the air contained in the waste-pipes, is not readily enough counterbalanced by the external air. When a stack of waste-pipes receives the discharges from (say) a sink on the fourth floor, a bath on the third floor, and a couple of wash-basins on the second floor, it will be readily seen that a discharge of hot water from the sink will cause the air in the main waste-pipe to become rarefied, and the rarefied air will rise up the pipe and out at the top, whilst some air is also carried down with the discharge; so that the supply of air to the waste-pipe will often be drawn through the traps of the fittings. The sink-trap may not lose its seal, for the tendency of the current is to keep it charged, but the traps of the fittings below will supply the air required to fill the partial vacuum which has been created. The coating which forms on the inside of waste-pipes prevents the hot water from coming into direct contact with the metal, and thus dissipating the heat, which goes to increase the temperature of the air in the pipes.

The depth of seal necessary for the different kinds of traps can only be indicated in a general way. The plumber who decides the question will take into consideration the class of fitting, the number of fittings on the waste-pipe, their position, the size of the main waste-pipe, and the size of the ventilating pipes from the traps. If the seals of traps are made too deep, they will probably become blocked up, or they will not cleanse themselves at each discharge. Seals should not, as a rule, exceed  $2\frac{1}{4}$  inches in depth, and in any case the discharge should be sufficiently large to cleanse the trap thoroughly.

A tier of three water-closets, having a 4-inch main soil-pipe, with  $3\frac{1}{2}$ -inch branches and traps, and 2-inch ventilating pipes from the traps, should have a seal 2 inches deep for the first,  $1\frac{3}{4}$  inches deep for the second, and  $1\frac{1}{2}$  inches deep for the third. If the main soil-pipe is reduced from 4 inches to  $3\frac{1}{2}$  or 3 inches, the depth of seal should be increased by  $\frac{1}{8}$  inch or  $\frac{1}{4}$  inch, so as to make the traps capable of holding their sealing water, notwithstanding the greater strain caused by the momentum of the falling discharges, which may completely fill the main soil-pipe, and descend in the form of a plug or piston, driving the air below it into the drain or out at the foot,—where foot-ventilation exists. If there is the slightest resistance to the free passage of the air, such resistance will be exerted on the seals of the traps below the discharge, forcing the water up into the inlet, and immediately the discharge has passed the end of the branch, the slight pressure on the sealing water is at once changed into a slight vacuum, and as the water falls back again to its original position, some portion will be waved, or sucked out, even when the trap-ventilation is good. The coating of fur inside waste-pipes increases the risk of syphonage, for, in all pipes up to 2 inches in diameter, the bore is materially decreased by the coating. It has been supposed that full discharges and rapid delivery will not only cleanse the trap and scour out the waste-pipe, but prevent the coating from adhering to the pipe. A wide experience proves that such is not the case, but that the coating will adhere in spite of full and rapid discharges, although these are of service in removing loose accumulations. For tiers of sinks, the traps should have from 2 inches to  $2\frac{1}{2}$  inches depth of seal, and for lavatories the seals should be from  $1\frac{1}{2}$  to 2 inches deep.

Where there is a range of (say) three water-closets on each of three floors, the depth of seal to each trap must be considered in its relation to each of the others in the same range, and also in relation to the whole number; some consideration must also be given to the sizes of the branch and main soil-pipes and the ventilating pipes. The traps of the three lowest closets should have seals of  $2\frac{1}{4}$ ,  $2\frac{1}{8}$ , and 2 inches in depth, the deepest seal being in the trap nearest to

the soil-pipe; the seals of the two ranges above should be 2,  $1\frac{7}{8}$ , and  $1\frac{3}{4}$  inches deep. If the depth of seal is not graduated in this way, the seals of the traps nearest the soil-pipe will always be broken. The object to be aimed at, is to put all the seals under the same strain as nearly as possible, so that, instead of the seal being broken in the trap nearest the soil-pipe, the depth of seal in all the traps will be equally but only slightly lowered.

The section A in fig. 200 represents a round-pipe trap properly sealed, the water standing at the level of the outgo. B shows the same trap with the seal lowered half an inch, the water in the two legs of the trap standing at an equilibrium as before. C shows the sealing water held up to the level of the outgo, and as half an inch has disappeared out of each leg in B, the level of the sealing water in the inlet-leg in C will be 1 inch below that in the

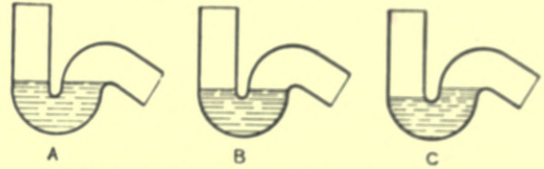

Fig. 200.—Sections of Traps to Illustrate Syphonage.

outgo, and the water in the outgo-leg is not counterbalanced by a corresponding height of water in the inlet-leg. It will be seen that the lower the level of the sealing water in the inlet-leg, the greater must be the vacuum to support the water in the outlet-leg; in C the amount of the vacuum is represented by the 1 inch of water held above the level of that in the inlet-leg. To break the seal of this trap, the water-level in the inlet-leg must sink to the dip, which would represent a vacuum equal to  $1\frac{1}{2}$  inches of water.

**Traps may be unsealed in at least three different ways:**—*first*, by momentum, *i.e.* the velocity acquired by the water in passing from the fitting to the trap carries too much of the water through the trap, the quantity remaining being too little to seal it; *second*, by syphonage, caused by the falling discharge from some other fitting on the same waste-pipe drawing the water from the trap; and *third*, by evaporation. Momentum and syphonage often combine to unseal a trap, even with the discharge from its own fitting alone. A *fourth* cause of unsealing is sometimes added, known as “waving”. This is the movement of the sealing water in one trap, caused by discharges of water from other fittings, or by currents of air from ventilating pipes, &c. When waving occurs, part of the water is of course carried over the outgo of the trap, but it is seldom that a trap is quite unsealed in this way. The unsealing of traps by discharges passing through them seldom occurs in connection with sinks, baths, and lavatories, as the drainage from the large surface of these fittings is sufficient to recharge the traps. In by far the greatest number of cases, unsealing of a trap is due to a discharge from some other fitting on the same waste-pipe; but as a trap *may*

be unsealed by the discharge from the fitting to which it is attached, every trap should be protected from this danger by adequate ventilation on the outgo side of the seal.

**Sinks and lavatories on the ground-floor** should have an air-pipe, equal to half the area of the waste-pipe, carried from near the crown of the trap through the outside wall.

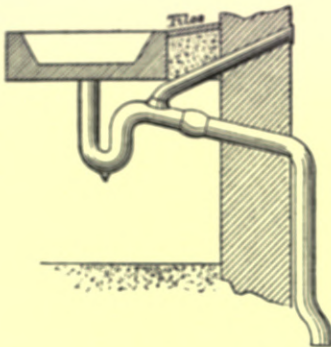

Fig. 201.—Waste-pipe and Air-pipe to Sink.

The waste-pipe should be fixed to deliver into a receiving head, or over a disconnecting trap. The air-pipe serves a double purpose, supplying air to the waste-pipe during the discharge, and allowing a current of air to pass through the pipe. The latter tends to oxidize and dry up the coating on the inside of the waste-pipe, and it is then more easily washed off by succeeding discharges. Two unventilated traps, connected with separate fittings but with the same waste-pipe, destroy the seals of each other, and the same effect is produced where there are two unventilated traps with one fitting.

A separate air-pipe to each will remedy the evil. The ends of air-pipes should terminate above the level of the fittings, as in fig. 201, which shows the waste-pipe and trap connected with a sink, the same arrangement being suitable for a lavatory.

**The main waste-pipes from fittings on the first floor**, and all floors above, should be continued up as ventilation-pipes, full size, from the disconnecting traps to the height of (say) 2 feet above the eaves, and left with open ends, or provided with ball gratings. In such a case the main waste-pipe may receive the discharges from sinks and lavatories on the first, second, and third floors; each trap must, however, be ventilated, the vent-pipe being carried up and branched into the main vent-pipe above the level of the highest fitting. The connection of the trap-ventilating pipe with the main ventilating pipe, as shown in fig. 202, is much better than having it carried up separately to the same level as the main vent-pipe, the object being to get the supply of air for the trap from the nearest point, and to benefit by the inrush of air down the main vent-pipe following a discharge. If the trap-ventilating pipe is carried up separately to the level of the main vent-pipe, the value of the sudden inrush of air will be lost, and there is nothing gained by so doing, to set against this loss.

**Waste-pipes of sheet-lead**, weighing 5 lbs., 6 lbs., and 7 lbs. to the square foot, were at one time in common use. The sheet-lead can be made up by hand into the various sizes required, the pieces used being united by soldered seams. The seams are of two kinds—copper-bit seams and wiped seams. In old houses,

the waste-pipes and traps are of this description, but in new property, **drawn-lead pipes** are generally used. These seamless pipes are manufactured in lengths of 10 feet, 12 feet, and 14 feet. To outsiders, drawn pipe appears to be much superior to hand-made seamed pipe; but experience proves that this is not the case, for the drawn pipe yields to the action of hot water much more readily than hand-made seamed pipe of the same strength. Drawn pipes may be found having innumerable small cracks throughout their length, after they have been in use a few years, while the seamed pipe has stood in the same position for thirty years. It is customary to denounce hand-made pipes and traps, chiefly because the sewer-gases attack and corrode the seams. The lead itself, however, is often corroded away, the corrosion depending solely upon the nature of the gases which attack the pipe. If this is carbon dioxide ( $\text{CO}_2$ ), the lead will be corroded away, and the seam remain good; but if it is sulphuretted hydrogen ( $\text{SH}_2$ ), then the seam will be corroded away first, and the lead, though thinned, will rarely be corroded through. But when the pipes and traps are disconnected from the sewer, and the drain is ventilated, there can be no

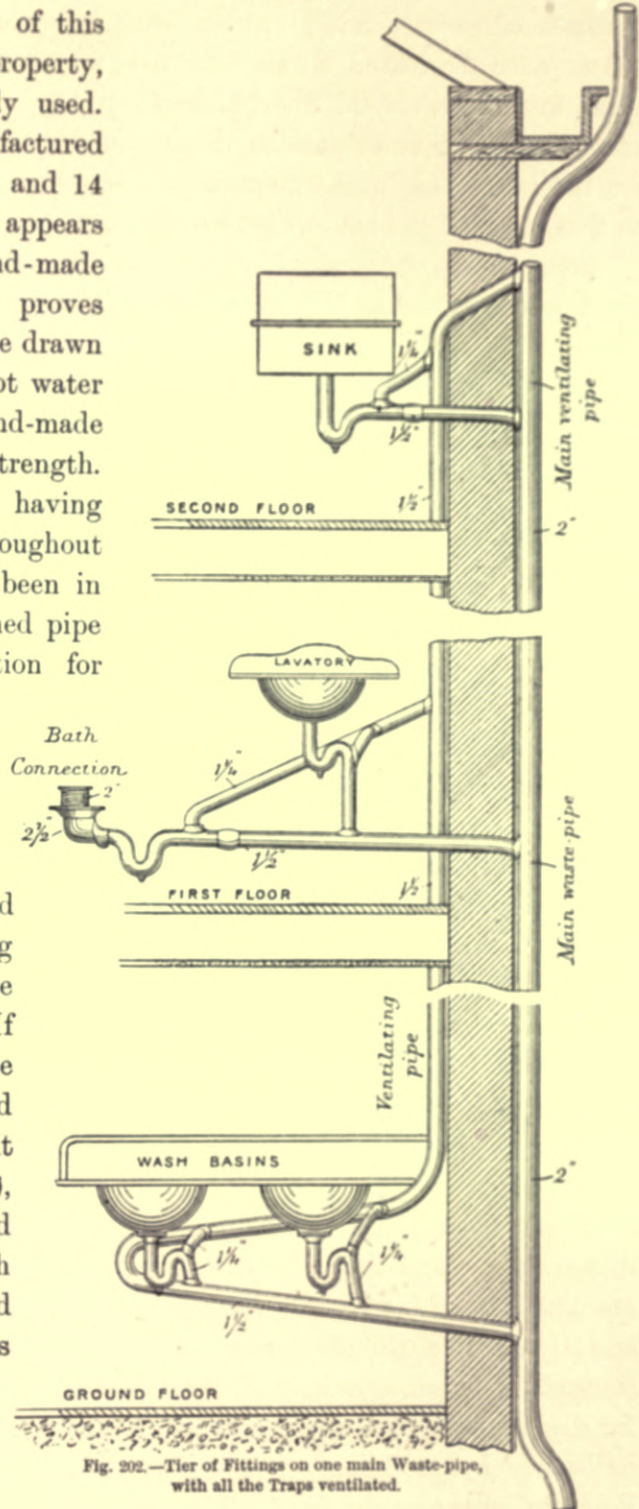

Fig. 202.—Tier of Fittings on one main Waste-pipe, with all the Traps ventilated.

question of gases, for if given off from decomposing matter in the drain, they are at once dissipated, so that there is no reason except the cost why seamed pipes and traps should not be used. If the seamed pipe is made from good sheet-lead, it is more durable than drawn pipe of the same size and strength, for the lead used in the manufacture of drawn pipes is not as a rule so good as that used for the manufacture of sheet-lead.

Some of the **drawn-lead traps** crack after they have been in use for a short time, and it is useless to try and mend them, for in a brief period the traps will have a network of small cracks similar to those in drawn pipes. The chief faults of the drawn traps are that they are too wide between the legs, and the bottom of the dip and the edge of the outgo are not straight enough.

**Hand-made traps** crack in the bends sometimes, but more usually they fail at the soldered seams, not, as some suppose, on account of the bad seams, but owing to the lead having been thinned at that point in the making. The hand-made round-pipe traps are always made perfectly upright, and have a sharp outgo; both the dip and the outgo weir are made straighter than in many other kinds, and the space between the legs is kept narrower.

**Cast-lead traps** often crack; they are unevenly made, are rough internally and externally, and are often faulty at the trap screws. The cast-lead round-pipe trap known as Beard and Dent's, with the outgo running away from the inlet, and having an easy curved outgo, is one of the worst forms of trap for holding its seal.

**Brass traps** must be viewed with suspicion, as they are made to suit the eye. The exteriors are usually burnished, while the inside is left rough as it came from the sand. The small brass traps for lavatories are generally of bad form; they are often made on the lines of the wet-trap and lip-trap, instead of being of the round-pipe form, and are not self-cleansing. There are round-pipe brass traps made for baths, but they are usually too wide between the inlet and outgo legs, and the bends are too easy. No reliance can be placed on them even when ventilated.

**Iron traps** are made and used for water-closets, slop-hoppers, sinks, and as disconnecting and drain traps. The iron round-pipe traps, enamelled inside, are about equal (as regards cleanliness and resistance to unsealing) to a Beard and Dent's or a Dubois drawn trap, being made on the same lines. Iron disconnecting traps, especially if enamelled, are superior to those of earthenware for disconnecting traps, as there is no danger of the bottoms becoming cracked or broken by prodding. When fixed near the ground-level, they are not so liable to be broken by frost. If such traps are not enamelled, they should have

periodic attention to keep them from furring up by corrosion as well as by the accumulation of deposit.

**Trap-screws** should be fitted under all traps beneath sinks, baths, lavatories, and urinals. By their means the traps can be thoroughly cleaned in a few moments, whenever a stoppage occurs. The traps of water-closets and slop-hoppers do not need them, as the discharges are heavy enough to keep the traps scoured out.

The connection of a lead trap with a **stone sink** is usually made as in fig. 203. The trap, cup, and flange are wiped together by a flange-joint as before. The cup is bedded in red-lead cement, and tafted back into position in the groove; the brass grating is then covered with pasted brown paper and the edge tinned previous to being secured in position, which is done by turning some of the lead against the edge to hold it whilst being soldered. It is, of course, impossible to solder lead to stone, but the grating is soldered to the cup to make a neat and strong finish. Some plumbers burn the cup in by pouring in molten lead, and support it in position by using clay, the connection still remaining as shown, with the exception of lead being used instead of solder.

One method of connection with a **lead-lined sink** is shown in fig. 204, which

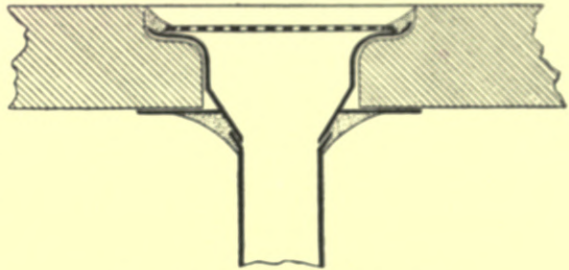

Fig. 203.—Connection of Stone Sink and Trap.

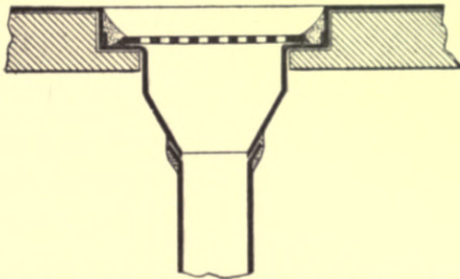

Fig. 204.—Connection of Lead-lined Sink and Trap  
(grating outlet).

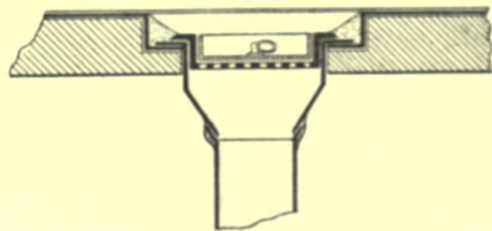

Fig. 205.—Connection of Lead-lined Sink and Trap  
(sunk-plug outlet).

exhibits a grating outlet, while fig. 205 shows a sunk-plug outlet. In each case the mouth of the trap is enlarged, so that the quantity of water passing through the grating will be capable of filling the trap and waste-pipe to cleanse them.

A good connection for the common type of **lavatories and wash-basins** is shown in fig. 206. The brass connection consists of a plug and washer with screwed thread, and a heavy ring, A, for screwing up beneath the fitting. The ring

is inserted in a lead flange, B; the inlet of the trap is placed over the ring, and the three are wiped together by a strong flange-joint, c. The lead flange is scored and bedded in red-lead cement, the washer being screwed up from the inside. Such a connection never leaks and cannot be broken. There is no union-connection, and no reduction of the water-way. Lavatories with standing

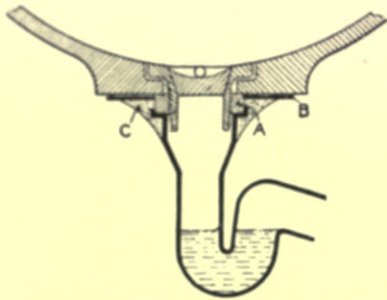

Fig. 206.—Connection of Lavatory Basin and Trap.

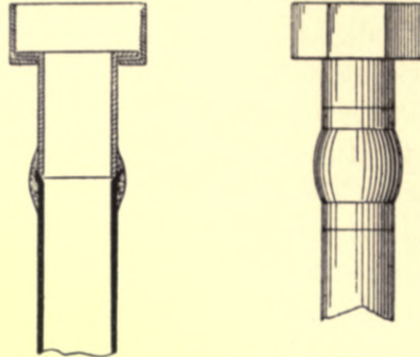

Fig. 207.—Connection to Lavatory Basin with Brass Union.

wastes have  $1\frac{1}{4}$ -inch and  $1\frac{1}{2}$ -inch brass unions, and the tail-pipes are wiped to the lead trap, as shown in fig. 207. The brass union is filed the length required, and afterwards tinned with resin and copper bit, using fine solder.

The best connection for **stoneware and earthenware baths** will be as described for lavatories (fig. 206). For **iron baths**, the connection will be by brass union and tail-pipe as shown in fig. 207, the only difference being that the tail-pipe for the bath will be bent, and not straight as shown in the figure.

The usual **diameter of waste-pipes** from baths is  $1\frac{1}{2}$  inches, but where there is no flushing tank at the head of the system of drainage, the waste-pipe from the bath may be employed for the purpose, in which case a pipe 2 inches in diameter may be used, being carried directly to the drain and treated in every way like a soil-pipe. It would not be advisable to have any other waste-pipes connected with that from the bath, when this is used for flushing the drains, as the heavy and continuous discharge might destroy the seals of their traps. The diameter of the waste-pipe from a single lavatory, whether long or short, should be  $1\frac{1}{4}$  inches. A tier or range of three lavatories should have a  $1\frac{1}{2}$ -inch main waste-pipe, and  $1\frac{1}{4}$ -inch branches and traps. Where a range of three lavatories is provided on each of three floors, in such a manner that one main waste-pipe will serve them, this main should be 2 inches in diameter, the branch waste-pipe from each range  $1\frac{1}{2}$  inches in diameter, and the branches and traps to the fittings should be  $1\frac{1}{4}$  inches. The ventilating pipe, from the lowest range to the point at which it is connected into the main vent-pipe above the highest range of fittings,



should be  $1\frac{1}{2}$  inches in diameter, and the branch vent-pipes  $1\frac{1}{4}$  inches. Traps and waste-pipes for sinks vary in diameter from  $1\frac{1}{2}$  inches for a butler's sink, to 2 inches for a housemaid's wash-up sink (the latter being larger on account of the presence of soap), and from 2 to  $2\frac{1}{2}$  inches for a large kitchen-sink.

**The weight of waste-pipes** varies with the size, the nature of the fitting, and the kind of pipe. Seamed pipes, made of sheet-lead weighing 6 or 7 lbs. to the square foot, were formerly used, but at the present time pressed pipes of the following weights are generally adopted:— $1\frac{1}{4}$ -inch diameter, 9 to 11 lbs. per yard;  $1\frac{1}{2}$ -inch diameter, 12 to 14 lbs. per yard; and 2-inch diameter, 18 to 20 lbs. per yard. Drawn pipes are equal in thickness to sheet-lead weighing 8 and 10 lbs. per square foot. The ordinary pressed pipe made in rolls is much superior to the seamed and drawn pipes, and is also much cheaper, as it can be bent to almost any shape by a skilled plumber, there being no need to cut and work the bends, or to make joints. It is sufficiently strong to be secured by means of clips or hooks. Lead seamed pipes are always secured by lead stays or tacks, single or double according to position. The bends are made separately and afterwards jointed up, making the work rather costly. It is the same with drawn pipes; and the joints have to be made near the bends.

**Bends in drawn pipes** are worked by means of bending bars, placed inside the pipe, to lift up the throat of the bend which is forced in during the bending process. The throat of the bend must be lifted out full size, and the pipe rounded up with the dresser; but most plumbers send a ball and followers through to round up the whole length of pipe; and where the pipes are fixed in sight, this must be done or the work will be unsightly, owing to the irregularities. If the bending bars are not used to lift the throat of the bend, and the plumber depends solely on the ball and followers, the back of the bend will be much reduced in thickness. It is impossible to bend lead pipe by means of balls and followers without reducing its substance, for the back stretches and the throat thickens as soon as it is bent, and when the ball is driven in, it is forced against the back, which is still further thinned by opening out. It is useless to heat the throat and cool the back in the hope that the ball will force out the throat, for this cannot be done. The ball should only be used for rounding up after the bend is made. For the larger sizes—from 3 inches in diameter upwards—no good plumber requires the ball, for with his dummies and mandrils alone he can turn out numerous bends in one length, each perfectly true and even in substance.

A good method of permanently **fixing lead waste-pipes** is shown in fig. 208, the lead clip being soldered to the pipe, front and back. It is suitable for

exposed pipes. For inclosed pipes, lead stays or tacks are soldered to the sides of the pipes, as shown in fig. 209, and screwed to the backboards, or nailed to the walls. Pipes secured in this way have a clumsy appearance at best. When the pipes run horizontally, the lead stays are often folded round the pipe and soldered

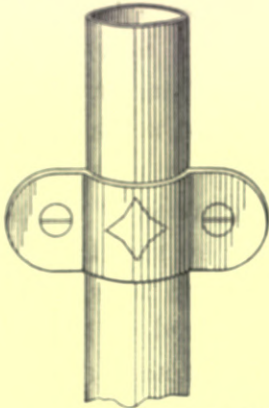

Fig. 208.—Waste-pipe secured by Lead Clip.

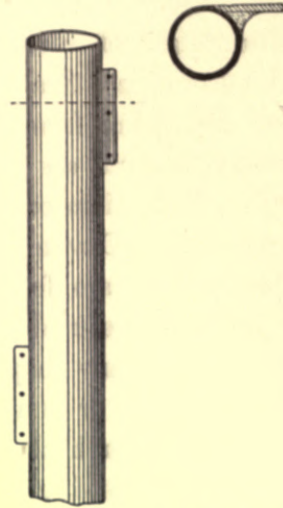
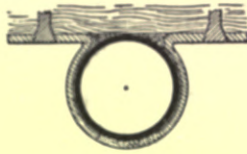

Fig. 209.—Waste-pipe secured by Single Lead Tacks.

at the back, but this is only done when there is no wood ground on which to lay the pipe. In old houses, the seamed pipes were generally fixed to the walls before the plastering was done, and the casing was built round them afterwards. This is rarely done now it being customary to have at least a

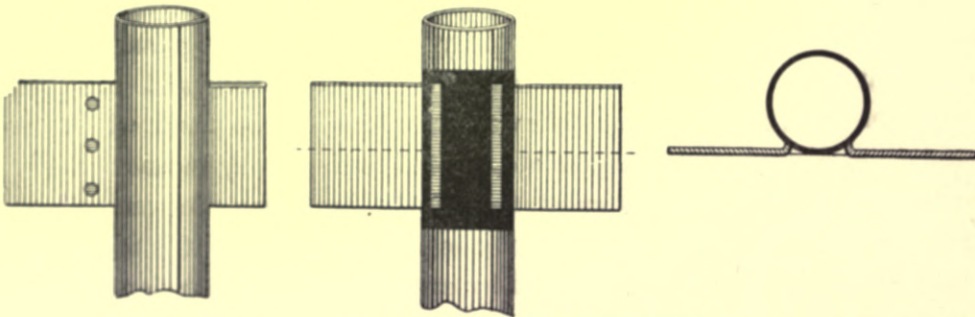

Fig. 210.—Waste or Soil Pipe secured by Double Lead Tacks.

backboard to carry the pipe, and in most instances grounds will also be provided for each pipe. This considerably reduces the number of stays required. Double stays, shown in fig. 210, are used for all sizes of waste-pipes and soil-pipes.

It is advantageous, where possible, to connect the branch waste-pipes into a main waste-pipe, which allows the plumbing work to be concentrated, and permits a better class of work to be done, perhaps at less cost than would be the

case if separate waste-pipes were fixed. The waste-pipes from baths, lavatories, and sinks (other than scullery sinks at which a large quantity of grease is produced), may be connected with a main waste-pipe, as shown in fig. 202. The waste water from each of these fittings is practically the same, being soapy, and consisting chiefly of washings from the body, and the slops to be disposed of after general household scrubbing. Where there is only one of these fittings on a waste-pipe, an air-pipe carried through the wall will be sufficient for all purposes; but where two or more fittings are connected with one waste-pipe, then separate air-pipes, or trap-ventilation, according to position, should be carried out as shown in the figure. If several of these fittings are connected, and the trap-ventilating pipes omitted, musty-smelling air from the waste-pipe will pass through the broken seals of the traps into the house, and although it will not cause typhoid fever, it will considerably lower the purity of the atmosphere inside the house, especially at night, and the constant breathing of such impure air may cause headaches, nausea, and sometimes diarrhoea. The harmful effect of waste-pipe air is more noticeable when the waste-pipe from the slop-hopper, or housemaid's sink and hopper combined, is connected with the other waste-pipes, and no vent-pipes provided.

The methods of lining wood sinks with lead may be briefly considered. The linings vary according to the size of the sink, and the upstand required above the back or ends. Small sinks are lined with sheet-lead in one piece, the vertical angles only being soldered. Fig. 211 shows the lead prepared for folding and putting in position. All measurements must be accurately taken, and the lead cut, straightened, tarnished, and shaved; and the portions cleansed for the soldering must then be greased to prevent them being oxidized or soiled by handling. A strip of lead  $\frac{3}{8}$  inch wide must be left at each seam for turning in behind the lead at the ends, but care must be taken that the ends do not fold round on to the front or back, as such folds weaken the seams. The front lead must finish in the angle, and not past it, or the seam will be much stronger on one side than the other. The section of the corners (fig. 212) shows the lead in its proper position. The ends of sinks are frequently put in separately, the lead being prepared as shown in fig. 213, which shows the bottom, front, and back in one piece, and one of the

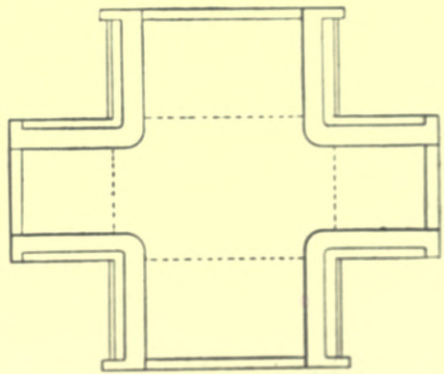

Fig. 211.—Lead for Small Sink, ready for folding and putting in position.

ends ready for putting in position. The sides are sometimes specified to be 6 lbs. to the foot and the bottom 8 lbs., or the sides 7 lbs. and the bottom 10 lbs. In such cases the lead is in three pieces, the front and one end, the back and one end, and the bottom.

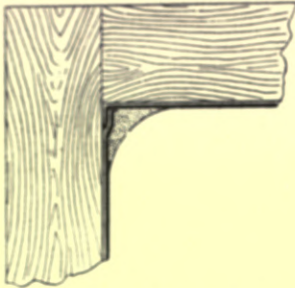

Fig. 212.—Finished Angle of Lead-lined Sink.

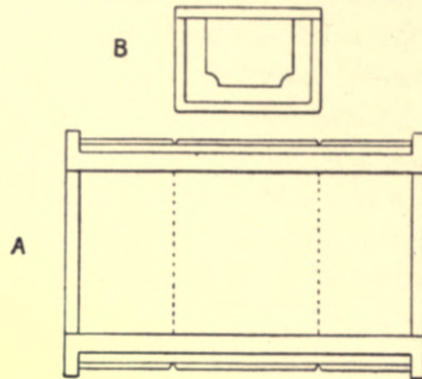

Fig. 213.—Lead for Large Sink.  
A, lead for front, bottom, and back; B, lead for one end.

It is not usual to line wood sinks with copper, although it is done occasionally. In such cases the whole of the seams must be welted, and the inside afterwards tinned. This sweats up the welted seams, making them water-tight. Copper linings are, of course, made out of their place, and to fit as tight to the wood sink as possible. Such work is often unsatisfactory, unless done by good workmen.

**Copper sinks without wood boxing** are always round or elliptical, with dished bottoms. To work the copper to these shapes, it must be well hammered, which stiffens it, so that it requires no support except from the flanged rim. These sinks are not usually made by plumbers, as special appliances are required for making them.

## CHAPTER III.

### SLOP-SINKS.

Where a suitable pedestal w.c. basin is provided, a special fitting for slops is not imperatively required, except in very large houses, hotels, and similar buildings. Such a fitting is, however, always convenient and useful, preventing droppings in the water-closet; and the room in which it is placed provides a suitable receptacle for bedroom utensils of various kinds. A tap for clean water should be fitted to every slop-sink, so that this can be easily and frequently

flushed. Slop-sinks are of various forms, some being not unlike ordinary sinks, while others are of the hopper shape, like many water-closets. The sink should be of stoneware, complete in itself, and fixed after the manner of a pedestal closet, and must have a flushing rim, and be connected with a syphon cistern. Some adaptation of the now well-known syphonic closet would be better still, as the shape of the basin is admirably suited for the reception of slops, and the flushing arrangements are almost perfection. The large body of water held by the syphonic-closet basin, together with the flush of water from the cistern, would cause the slops to be thoroughly diluted, and this is just as important as their actual disposal.

The waste-pipe from a slop-hopper should be treated in every way like a soil-pipe. It must not be connected with the waste-pipes from baths, lavatories, or sinks, and should not have a hot-water tap fixed over it. There is no reason, however, why it should not be connected with the soil-pipe from a w.c. if the traps of both are properly ventilated. It is sometimes said that there is no valid reason against the connection of the waste-pipes from baths, lavatories, &c., with the slop-hopper waste-pipe, but this I hold to be an erroneous statement. Not only is there increased danger of furring within the slop-hopper waste-pipe on account of the presence of soapy wastes from the other fittings, but there is considerable danger of the small traps on these fittings being unsealed by the rapid discharges through the slop-hopper, and in this way the foul air from the slop-pipe may pass into the house. Indeed, the waste-pipes from baths, &c., might be connected with soil-pipes with equal reason, for there is very little difference between a slop-pipe and a soil-pipe; of the two, the soil-pipe is generally the cleaner.

The diameter of the waste-pipe from a slop-hopper is frequently 4 inches; but this size is excessive, presenting a large surface for the accumulation of deposit and the generation of foul odours. The waste-pipe and trap from any receptacle for slops need not exceed 2 inches in diameter, but of course the trap must be properly ventilated.

The arrangement of the trap and waste-pipe may be seen in fig. 214. The inlet of the trap is shown prepared for the reception of an enamelled-iron hopper. The trap is ventilated, and the branch waste-pipe is connected with a main waste, which is fixed outside the building and carried

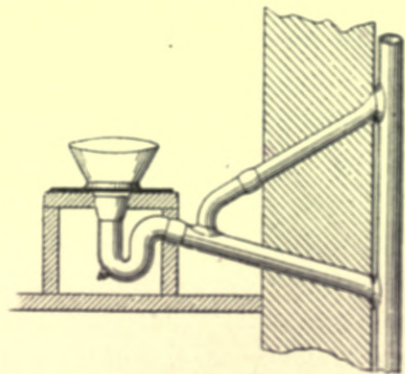

Fig. 214.—Waste-pipe from Slop-hopper.

up above the roof. The hopper above the trap should be flushed in exactly the same manner as a water-closet. A cold-water tap may be provided to rinse out the utensils, which should afterwards be dealt with over the housemaid's sink provided for this and similar purposes.

---

## CHAPTER IV.

### WATER-CLOSETS.

#### 1. WASH-OUT AND WASH-DOWN CLOSETS.

In fixing water-closets, particularly pedestal basins of the wash-out or wash-down form, great care must be taken to **set the basins level**, as otherwise the flush may be unsatisfactory and the seal of the trap reduced. Many wash-down basins, if inclined towards the outgo, lose their seals, not only during the flush, but afterwards; and if inclined in the opposite direction, may not be properly cleared with a single flush. If a wash-out basin leans back, the flushing water will probably not have sufficient energy to clear out the basin at the commencement of the flush; and when a sufficient weight of water has accumulated to carry the soil out of the basin, there will be none left to clear the discharge out of the trap. In this class of closets, the soil is rarely pushed over the weir into the trap before one-half of the flushing water has passed away. The greater the depth of water standing in the basin, the heavier will be the flush required to remove the soil. In most of these closets the soil leaves the basin too late to be floated away through the trap by the flushing water. If, on the other hand, the basin is tilted towards the outlet, to enable the flushing water to remove the soil expeditiously, the basin may contain too little water to receive and drown the soil, and bad odours will be given off from the evacuations. By submitting all w.c. basins to a test under a well-constructed syphon flushing-cistern, which will work with  $1\frac{1}{4}$ -inch and  $1\frac{1}{2}$ -inch flush-pipes, it can be easily determined whether the basin can be fixed so as to hold its full complement of water, or whether it will have to be slightly tilted to make it clear itself efficiently, and at the same time the requisite size of flush-pipe may be ascertained.

In all water-closets, the flushing-rims to the basins, the flushing-cisterns, and the flush-pipes play a most important part, and the method of fixing should always be a matter of careful consideration. Plumbers too often take it for granted that certain kinds of basins and cisterns are perfect in every way, and

that all they have to do is simply to connect the supply-pipe with the cistern, fix the flush-pipe, and connect the basin with the soil-pipe; they do not consider that the success of an apparatus is largely due to the skill with which the several parts are fixed.

For example, **the height of the flushing-cistern** above the basin cannot be properly determined without due consideration being given to the mechanism of the cistern, the shape of the basin, and the diameter of the flush-pipe. If the cistern is fixed too low, the basin and trap will not be adequately flushed; if too high, the water may splash on to the seat and floor. As a general rule, it may be said that no two-gallon cistern is too powerful for cleansing a wash-out basin unless it is fixed more than 6 or 7 feet above the basin, but as the basins of this class vary considerably in shape and size, as well as in the quantity of water allowed to stand in the basin, some judgment is required on the part of the plumber.

Some manufacturers now supply, with their w.c. basins and cisterns, **flush-pipes** of brass or galvanized iron, made of the exact diameter and length to give the best flush. These have certain advantages over the lead pipes which are commonly used, being more sightly and less liable to bulging; but iron pipes are apt to corrode, the result being that the flush is retarded and the basin stained. Light solid-drawn copper pipes are largely used in good work; they are usually filled with lead before being bent to their position, and the lead is afterwards melted out. Brass and copper pipes are frequently nickel-plated, and the latter are also sometimes tinned.

**The diameter and construction of the flush-pipe** are also important. Some syphon cisterns will not work satisfactorily with  $1\frac{1}{2}$ -inch pipes, while others work better with  $1\frac{1}{2}$ -inch pipes than with  $1\frac{1}{4}$ -inch. As a general rule, that size of pipe should be used which will be fully charged with water when the cistern is in action. When the water supplying the cistern will only rise a short distance above the basin, the diameter of the flush-pipe must be enlarged accordingly; in such cases pipes 2 or 3 inches in diameter may be necessary, but in every case as much height as possible should be obtained, as it is the momentum of the falling water which is required to cleanse the basin and trap, rather than the actual volume of water poured into them. At one time pipes  $\frac{3}{4}$  inch or 1 inch in diameter were generally used, but the most common size of flush-pipe to-day is  $1\frac{1}{2}$  inches. The height of the cistern above the basin will greatly modify the size of the flush-pipe. When the height is under 5 feet, the pipe cannot well be less than  $1\frac{1}{2}$  inches in diameter; from 5 to 8 feet,  $1\frac{1}{4}$ -inch pipe may be used; and above 8 feet, 1-inch pipe will probably be

ample. In a good flush the standing water and soil will be carried out of the basin and trap by the first half of the discharge, and the second half will cleanse the basin and recharge the trap with clean water. The number of bends in the flush-pipe must also be considered. Sometimes syphon-cisterns fail in consequence of the number or shape of the bends in the flush-pipes. No intelligent

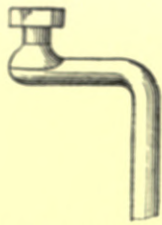

Fig. 215.—Bad Form of Joint between Syphon-cistern and Flush-pipe.



Fig. 216.—Over-bent Flush-pipe.



Fig. 217.—Flush-pipe properly bent.

plumber would connect the flush-union of a syphon-cistern with the flush-pipe by a hooded joint, as shown in fig. 215, as the probability of success would be considerably reduced by having the square connection. The curves of all bends in flush-pipes should be "easy". Fig. 216 shows an over-bent flush-pipe, and fig. 217 a well-bent one. To bend the pipe as shown in the latter case is a

simple matter if the pipe is strong; but when light pipes are used the pipe is flattened with a piece of soft wood before the bends are made, a ball being afterwards driven through the pipe to round it again. The flush-pipe should never dip below the flushing-arm of the closet, so as to form a trap or hold water, and the bend to the arm should be as free as that shown in fig. 217.

The supply of water to the flushing-cistern should be obtained through a service-pipe from the store-cistern, so that the reserve of water in the store-cistern will keep the w.c. cistern supplied in the event of the water in the street main being turned off for a few hours. The pipe is usually  $\frac{1}{2}$  inch in diameter, weighing 6 lbs. per yard. This size is large enough, as it is three or four times greater than the water-way through the ball-cock. One of the greatest drawbacks to flushing-cisterns is the length of time required to refill the cistern after its discharge. The water-way through the ball-cock is never more than  $\frac{1}{4}$  inch in diameter, owing to the length of lever and size of copper ball required to close it against a given pressure. These have to be regulated before the ball-cock can be stamped. Some ball-cocks begin to close as soon as the cistern begins to fill, so that a long time is occupied in drawing the last inch or two of water, and as most syphon-cisterns cannot be started till they are filled to a certain level, it follows that a considerable interval must elapse after the closet has been used before it can be used again. To obviate this drawback, ball-cocks have been designed which allow the water to run full bore until the cistern is practically full, when about another pint of water suffices to close the ball-cock. These are



quick-filling ball-cocks, but very few of them are in use. The overflow from a flushing-cistern is usually carried through the outside wall, in accordance with the water company's rules; but when fixed in basements, overflows are sometimes placed over the seat of the w.c., so that any leakage from the ball-cock will throw the closet out of use until the defect is made good.

**The method of flushing the basin** varies in the different types of closet. The tendency in the wash-down basin is to concentrate the flush, by means of jets, on to the surface of the standing water in the trap, less water being sent round the flushing rim and down the sides of the basin than in other types. No intelligent plumber would try to regulate a flush to wash the fouled surface of an upright back, and much less would he try to arrange it so as to flow beneath a back inclined away from the basin. With the upright back, the water usually glides over the surface without force enough to cleanse it, and with an over-sailing back the flushing water is useless, as it falls straight down away from the inclined surface.

**Wash-down basins with lead traps**, similar to that shown in Plate X., are, as a rule, superior to those in which the trap is of the same material as the basin, in so far as a better joint can be made between the outgo of the trap and the lead branch to the soil-pipe. This objection to the earthenware trap has, however, been partially overcome by Doulton's "metallo-ceramic" joint.

## 2. VALVE-CLOSETS.

**Valve-closets require more care and skill in fixing** than either of the preceding closets, although the same general rules apply. It is customary to fix the centre of the trap 14 inches from the external wall, as shown in fig. 218. The trap is a 3-inch round-pipe trap, enlarged at the inlet to receive the outgo of the closet. From the outgo of the trap a 3-inch branch-pipe leads to the soil-pipe, while from the branch a 2-inch trap-ventilating pipe is carried up and connected with the soil-pipe at a higher level. The joints A, B, and C are made in position, the branches D and E having been connected with the soil-pipe before fixing it, if this is of lead, or with lead branch-pieces, if the soil-pipe is of iron. The upright joint at F is also made in position. G is the lead safe under the closet; the waste-pipe from this must be carried through the wall, and finished with a brass flap, so that a current of air will not pass through it into the house.

Valve-closets are proscribed by most water companies, being regarded as unsuitable for connection with a domestic water-supply. These closets are usually flushed by a service-pipe from the store-cistern, through the special

valves provided with them. These valves are of two kinds. The ordinary valve will allow the water to run as long as the handle is held up, and a bellows-regulator supplies the quantity of water required for the basin, after the handle is let down. The other kind of valve is known as a water-waste preventer, and is constructed to allow a two-gallon flush each time the handle is raised, and an after-flush for the basin when it is lowered. There is often great trouble and

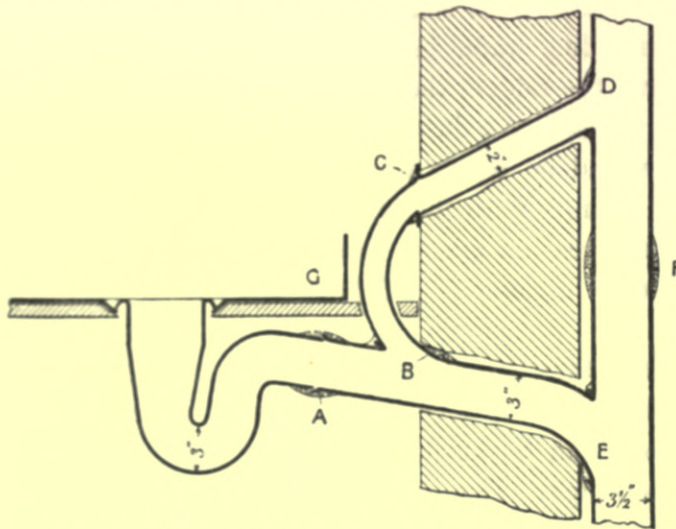

Fig. 218.—Lead Trap for Valve-closet, with connection to Soil-pipe, &c.

annoyance with both these valves, for when once thrown out of order they are difficult to set right, and require special washers. The size of the flush-pipe and valve must be in accordance with the head of water from the store-cistern. Dent and Hellyer are makers of valve-closets, and the sizes of flush-pipes and valves given by Mr. Hellyer may be considered correct. When the head of water is under 3 feet, the flush-pipe should be  $2\frac{1}{2}$  inches in diameter, and the supply-valve 2 inches. With a foot or two more head of water, a 2-inch pipe and  $1\frac{1}{2}$ -inch valve will give a good flush. With 8 or 10 feet head of water, a  $1\frac{1}{2}$ -inch pipe and  $1\frac{1}{2}$ -inch or  $1\frac{1}{4}$ -inch valve is necessary; from 10 feet to 15 feet, a  $1\frac{1}{4}$ -inch pipe and a  $1\frac{1}{4}$ -inch valve should be provided; and above 20 feet, a 1-inch pipe and a 1-inch valve. Instead of supplying a valve-closet with a greater head of water than 30 feet, it is better to fix a small cistern over the closet.

In connecting the service-pipe to the cistern there is little to do beyond fixing the pipe, making a joint to the tail-pipe of the ball-valve, and covering the pipe with a good non-conductor to prevent the water from freezing. Where there are tiers, or ranges, of valve-closets, much annoyance is sometimes caused by the singing or chattering of the valves; this can often be relieved by having air-pipes fixed. The vent-pipe from the valve-box should be carried through the external wall, its end being kept above the level of the basin, so that in the event of stoppage, the vent-pipe will not become an outlet.

Mr. Hellyer states that if a separate cistern is fixed to supply a valve-closet, it should hold not less than six gallons. The valve-closet has some advantages,

but these are far out-weighed by its disadvantages when the water for flushing purposes is limited. An up-to-date closet must both clear and cleanse itself with a 2-gallon flush. It is useless to argue with the water-authorities, who have made up their minds that no more than two gallons of water can be spared for each flush, and this quantity is found to be quite sufficient for the wash-down pedestal, and also for the newer form of closets described later, although it certainly is not enough to keep the soil-pipes and drains free from deposit.

### 3. *SYPHONIC CLOSETS.*

The need of a large area and depth of water in the basin to receive and cover the soil, together with the restrictions placed on the quantity of water to be used for flushing purposes, have resulted in the invention of **syphonic closets**. The wash-down and wash-out closets do not hold sufficient water in the basin, and the valve and syphonic closets are the only ones that are really satisfactory in this respect. The syphonic closets, however, have not been as successful as was anticipated, each of the earlier kinds having serious faults of its own, either in regard to the supply, the discharge, the form, the combination of traps, the air-pipes, jet and puff pipes, butterfly valves, or the necessity for from 4 to 6 gallons of water for each flush. Some syphonic closets will discharge themselves three times with a 2-gallon flushing cistern, and others, with the same quantity of flush, refuse to take a heavy deposit, and even leave the paper behind when the deposit is light. In another closet some portion of the flushing water is used to create a vacuum between the traps, without being passed through the basin.

**The method of fixing syphonic closets** varies with each kind, as the syphonic discharge is obtained in different ways. In some, the air is expelled by means of a jet of water, in others the air is sucked out, or exhausted by induction. In all cases the basin and cistern work in combination, so that the closet and cistern must be bought together. The provision of two traps for one closet, as in certain syphonic closets, cannot be recommended, for the lower trap will not clear itself with a 2-gallon flush, although this is the chief requirement of a good sanitary closet.

**The syphonic is a pedestal closet**, and as such must be capable of receiving a heavy discharge of slops without losing its seal; it is by trying to prevent this loss of seal that its construction has become a little complicated. Many of those at present in the market require special contrivances, such as butterfly-valves,

air-pipes, puff-pipes, and ejectors, which add to their cost and make them very troublesome.

**Holt's Patent Syphonic Closet** is one of the simplest forms. Fig. 220 gives

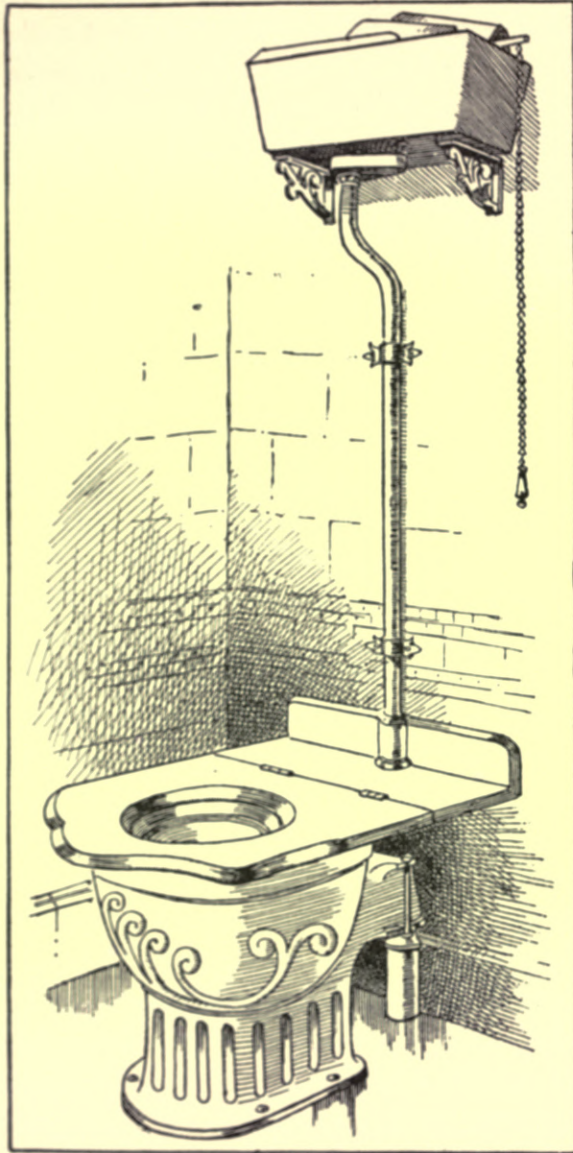

Fig. 219.—View of Holt's Syphonic Closet and Cistern.

a vertical section through the basin, as shown in the patent-drawings. The exposed water-surface in the basin is about equal to that in a valve-closet. The basin is discharged by the rapid flow of the flushing water from the cistern, which increases the head of water in the basin, and forces the water in the trap over the weir in such volume as to charge the  $2\frac{1}{2}$ -inch outgo leg, or long leg of the syphon trap. The channel formed round the top edge of the basin holds back a small quantity of water to assist in bringing up the water-level in the basin to the desired height. The flattened portion of the basin bottom is also intended to hold back a small portion of water, in addition to holding up the flushing water, so as to fully charge the outgo leg at the commencement of the flush. The advantages of this form of basin are:—it presents a large area of water to receive the soil; it has a deep trap; it will dilute a pail of slops; there is no complication of parts; and the fixing is simple. The branch soil-pipe is  $2\frac{1}{2}$  inches

in diameter. The disadvantages are:—the rising of the flushing water in the basin agitates the contents, causing them to smell strongly; the water being sucked out from the bottom of the basin, the soil and paper leave the basin last, and sometimes remain on the flattened bottom; the great depth of

water in the centre of the basin causes splashing; when the basin has been syphoned out below the level of the dip, the large body of fouled water in the trap falls back, the discoloured water and sometimes the solid matter, being left in full view in the mouth of the trap. The branch soil-pipe must be continued downwards from 2 feet to 2 feet 6 inches to give the pull necessary to empty the basin, and the pipe requires to be bent in such form as to offer some resistance to the flow of water through it, and should be obtained with the basin. It does not allow of the branch soil-pipe being ventilated.

For comparison, another simple form of syphonic closet, of which Messrs. Ashworth Bros. are the makers, is shown in section in Plate X. The outlet of the basin is at the back. The back is flat and upright, allowing a wide, narrow trap, with a wide weir. The force of the flushing water down the back, and the wave formed by the meeting of the flushing water at the front, start the syphon much more readily than the one previously described. The contents of the basin are floated to the outlet and drawn out by the syphon without having to dive to pass round the dip of the trap, the bottom edge of the dip being in line with the

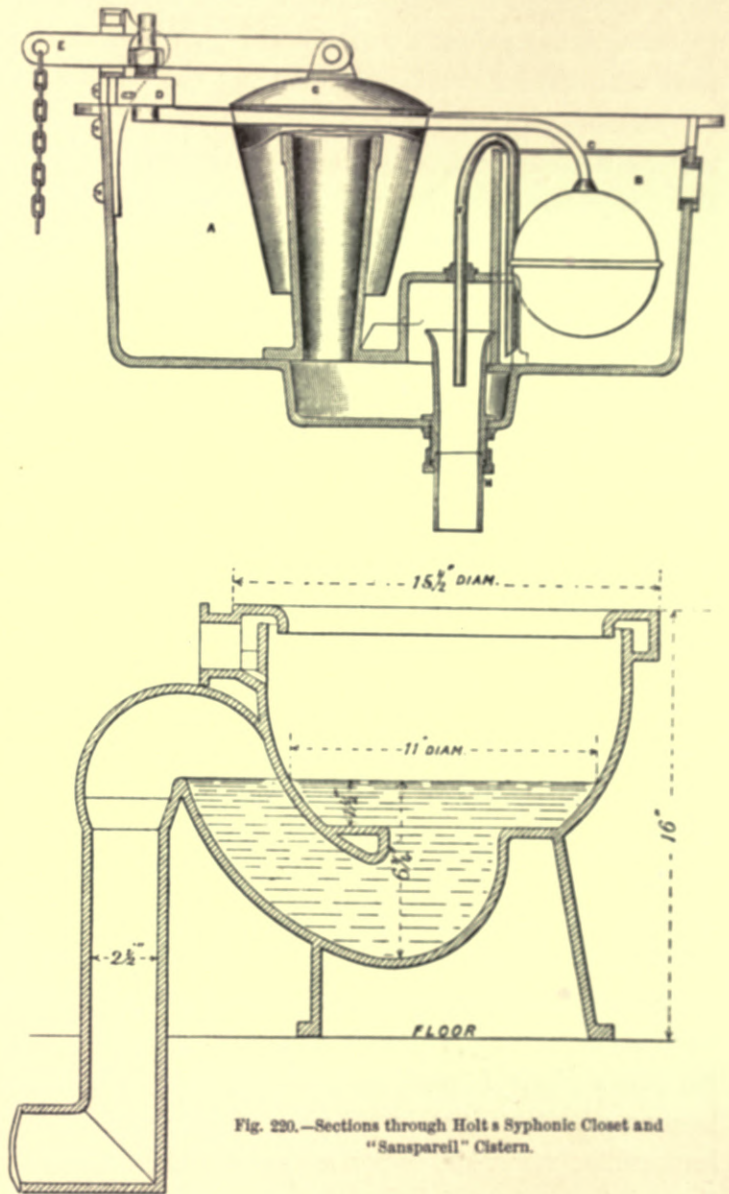

Fig. 220.—Sections through Holt's Syphonic Closet and "Sanspareil" Cistern.

water in the centre of the basin causes splashing; when the basin has been syphoned out below the level of the dip, the large body of fouled water in the trap falls back, the discoloured water and sometimes the solid matter, being left in full view in the mouth of the trap. The branch soil-pipe must be continued downwards from 2 feet to 2 feet 6 inches to give the pull necessary to empty the basin, and the pipe requires to be bent in such form as to offer some resistance to the flow of water through it, and should be obtained with the basin. It does not allow of the branch soil-pipe being ventilated.

basin bottom. The advantages of this form of basin are:—it can be discharged and refilled with 2 gallons of water; it presents a large surface of water (14 inches by 12 inches, and 2 inches deep); the seal of the trap is  $3\frac{1}{2}$  inches when full, and when discharged by a pail of slops it is  $1\frac{1}{2}$  inches; the basin will discharge by syphonage, independently of the soil-pipe branch or its connection, thus doing away with special bends, and allowing the branch soil-pipe to be connected in any suitable way; the branch soil-pipe may be ventilated by means of the usual trap-ventilating pipe, without interfering with the syphonic discharge from the basin, thus rendering it possible to fix these closets in tiers or ranges, or in company with closets of other form. The soil and paper pass out of the basin and through the trap with the first part of the discharge, leaving a good supply to cleanse the basin, and bring the water up to its normal level in the basin. It is impossible to break the seal of the trap by the discharge of slops, owing to the peculiar formation of the bottom and the shape of the trap. The urine passing through the pipes is thoroughly diluted. There is no need of a second trap, and there are no jets, air-pipes, or valves to become deranged and so interfere with the syphonic discharge from the basin. The fixing of the basin is a simple operation, as there is no complication of parts. A  $2\frac{1}{2}$ -inch soil-pipe is provided, and works satisfactorily. The strongest advocates of large soil-pipes must be convinced that, if a  $2\frac{1}{2}$ -inch branch soil-pipe is large enough, a 3 or  $3\frac{1}{2}$ -inch main soil-pipe will also be large enough.

---

## CHAPTER V.

### SOIL-PIPES AND THEIR CONNECTIONS.

**The position of soil-pipes** is a matter of considerable importance. In the early days of water-closets the soil-pipe was almost invariably built into the wall, or let into a chase formed in the wall. But the dangers of internal pipes soon became manifest: the joints were often scamped, as inspection was difficult or impossible; sewer-air, or foul air generated in the soil-pipe itself, escaped through the joints, and pervaded the closet and the house; and repairs were difficult, troublesome, and costly. Even if the soil-pipe was perfect when fixed, it might eventually be corroded through, and sewer-air might pass into the house for months or years, until the illness of one of the members of the household drew the medical officer's attention to the danger. To-day internal soil-pipes are

forbidden almost throughout the length and breadth of the land. External soil-pipes have undoubtedly certain disadvantages,—chief of which is the liability to injury from heat and frost,—but, on the other hand, they are constantly open to inspection, and all the joints between the w.c. and the drain, with the exception of the joint at the outgo of the closet, are outside the building, so that the danger of air-pollution within the house is reduced to the lowest possible limit. External lead pipes, when fixed on the sunny side of a house, are frequently drawn out of the perpendicular between the fastenings, or injured in some other way, by the alternate heating and cooling to which they are subjected. The same effect is sometimes due to repeated currents of hot water. Some sanitarians, who advocate the use of external soil-pipes, appear to be content with internal trap-ventilating pipes, even though these must be through two or three stories to ventilate the traps of a tier of closets. While, of course, ventilating pipes are not so foul as soil-pipes, currents of foul air undoubtedly pass through them, and the external soil-pipe logically demands the external trap-ventilating pipe. The multiplication of pipes on the outside of buildings is an architectural misfortune, but by skilful planning they can be placed in retired positions, so that they will not obtrude themselves upon the sight. Soil-pipes should be carried, whenever possible, above the ridge of the building, and should terminate not less than 10 feet from every window and skylight, nor should they be fixed on or near chimney stacks.

**The size of a soil-pipe** for a single closet, or for two closets, fixed one over the other, or for a range of three closets, should be  $3\frac{1}{2}$  inches if of lead, and 4 inches (on account of the internal corrosion) if of heavy cast-iron. A 4-inch lead soil-pipe is large enough for connection with six or more w.c.'s, and in no case is it necessary to go beyond  $4\frac{1}{2}$  inches, although it may be advisable in the case of iron to increase the size, according to circumstances, up to 5 inches, for a 5-inch iron pipe is only equal to a  $4\frac{1}{2}$ -inch lead one, after it has been in use a short time. Occasionally smaller pipes than those now suggested have been used, some persons even advocating  $2\frac{1}{2}$ -inch pipes. The tendency of our fathers was undoubtedly towards excessive size, both of drains and soil-pipes, but we must be careful that we do not run to the opposite extreme.

Soil-pipes, whether used as drain-ventilators or not, must always be carried up full-bore above the roof, so as to act as **ventilation-pipes**. Frequently a 2-inch ventilation-pipe is carried up from a 4-inch soil-pipe. This is a mistaken economy, and may lead to the unsealing of the closet-trap and the consequent pollution of the air of the house. Bends in vent-pipes should be avoided wherever practicable, and the top of the pipe should be as far removed from windows

and skylights as possible. The purpose of a ventilation-pipe is not only to allow free escape for the vitiated air in the pipe and branch drain, but also to afford a supply of air in order to prevent the syphonage of traps when closets are discharged. Separate trap-ventilation pipes must, however, be provided for closets in tiers.

**Soil-pipe terminals** ought to be of such a kind as to prevent as little as possible the free supply of air to the traps connected with the soil-pipe. Mr. Hellyer's tests clearly demonstrated that, for *extracting* purposes, certain cowls are superior to the simple open pipe, but they also showed that the open pipe is better than one-half of the cowls tested. It has also been proved that some cowls are better for preventing a downcast than inducing an upcast. Those cowls, however, which exert the most influence in creating an upcast, or are most efficient in preventing down-draughts, are unsuitable types of cowls for fixing on stacks of soil-pipes, having traps and trap-ventilating pipes attached. If a cowl is selected and fixed on the soil-pipe, on account of its powerful influence in inducing an up-current, it follows that, if a downward current of air is required, the very efficiency of the cowl will exclude it. If a cowl creates an upcast, the resistance it offers to a downward current must be overcome, and it is here that a slight hesitancy in the supply of air required to maintain the seals of traps may be looked for. The free ingress of air, at the desired moment and in sufficient volume, is more important than the extraction of a large amount of air. In Mr. Hellyer's tests, the open pipe comes out fairly well as an extractor, and, all things considered, the open pipe, with a ball grating, or a plain cone cap fixed well above the end of the pipe, is much superior to any cowl ever made or tested. Good extracting cowls should, however, always be fixed on separate drain-ventilating pipes, when these are intended to act solely as exhaust pipes for ventilating the drains.

There are two advantages gained by fixing a **disconnecting trap at the foot of a soil-pipe**. It is impossible, when properly trapped off from the drain, for the soil-pipe to convey drain-air into the house, and the soil-pipe, being open at both ends, will have a current of fresh air always passing through it. Mr. Hellyer asserts, on page 164 of *The Plumber and Sanitary Houses*, that the disconnecting trap "has been found quite free from any offensive odours, and the atmosphere has been passing freely *into* the discharging end of the soil-pipe at this point, and not *out* of it". It appears from this that the science of foot-ventilation is practically complete if you use a little judgment, and up-to-date *self-cleansing traps*. But one is led to make further inquiry after reading on the next page, that to get rid of the "vitiating air", induct-pipes



must be fixed, and removed some little distance away; and that, if there is much traffic over an induct-pipe, "it should be taken up 15 feet or more above the ground-level, so as to prevent anyone inhaling the air which would be sent out through the pipe when any of the water-closets were in action".

**The objections to the foot-ventilation of soil-pipes**, in my opinion, more than counterbalance the advantages. They may be briefly stated. Whenever a closet is used, a certain amount of vitiated air will necessarily be driven out at the open foot of the soil-pipe, and in many places this will undoubtedly prove a great nuisance. The provision of an additional trap between the closet and the drain is not an unmixed blessing, as it will frequently retain foul matter, and give rise to more or less unpleasant emanations. The fixing of an induct-pipe and mica-flap valve will go a long way towards preventing any nuisance from this cause, but in many cases the valve would have to be fixed so far away from the soil-pipe (on account of doors and windows), that the air might as well be supplied to the soil-pipe through the manhole or inspection-chamber and along the branch drain in the usual way. Certainly where the drains are properly disconnected from the sewer, and where the branch drains are short, there is absolutely no necessity for the foot-ventilation of soil-pipes. Cases may occur where such ventilation is desirable, but they are certainly the rare exception and not the rule. For example, when a soil-pipe is fixed in connection with an old, filthy, and unventilated drain, it may be advisable to disconnect it, but undoubtedly the better and only safe plan in such a case would be to take up the old drains and replace them with a new system in conformity with modern sanitary knowledge.

**Earthenware and stoneware** are both unsuitable and unsightly materials for soil-pipes. The number of joints, the probability of the cement giving way owing to settlement or the action of frost, the liability of the socket to break, the clumsy appearance of the pipes and fastenings, the risk of stoppage, and the fact that the joints and pipes yield to light blows or moderate pressure, show that there is good reason why these pipes should not be used. They cannot be considered suitable for any position in which a plumber can work, and even underground, cast-iron pipes are much superior, owing to their strength, and the smaller number and greater strength of the joints.

**Cast-iron pipes** have almost superseded lead soil-pipes, not because they are better, but because they are cheaper. Cast-iron pipes may be classified as light, medium, and strong. The light pipe, which is about  $\frac{1}{8}$  inch thick, is scarcely suitable even for the conveyance of rain-water, and totally unsuitable for soil-pipes. The medium pipe is  $\frac{3}{16}$  inch thick, and is a good pipe for rain-

water, but as it is not strong enough to stand a good caulked-lead joint being made, it is unsuitable for soil-pipes. The strong cast-iron pipe is  $\frac{1}{4}$  inch thick, and is suitable for a soil-pipe, if well fixed and the joints properly caulked. These pipes have, however, a very clumsy appearance, and are only suitable for fixing outside the house. The branch pipes and all internal work should always be of lead. The weights of cast-iron soil-pipes, required by the London County Council, are (per 6-foot length and one socket) 48 lbs. for  $3\frac{1}{2}$ -inch pipe, 54 lbs. for 4-inch, 69 lbs. for 5-inch, and 84 lbs. for 6-inch. Modifications of the by-law respecting these are, however, now contemplated, so that the thickness of metal in  $3\frac{1}{2}$ - and 4-inch pipes may not be less than  $\frac{1}{4}$  inch, and not less than  $\frac{5}{16}$  inch in 5- and 6-inch pipes; these modifications will bring the weights of the 6-foot lengths of pipes up to 65 lbs. for  $3\frac{1}{2}$ -inch pipe, 73 lbs. for 4-inch, 121 lbs. for 5-inch, and 142 lbs. for 6-inch.

To prevent external and internal corrosion, the pipes should be protected by a coating of Dr. Angus Smith's solution. This solution is a composition of pitch, resin, and oil, heated in a boiler to a high temperature. Into this composition the pipes are immersed, and are thus thoroughly coated inside and out. The coating forms a fairly good but not permanent protection, as it lasts only for a time; but while it does last, the pipes are certainly clean inside. There is also the Bower-Barff process, in which the pipes are submitted to the action of superheated steam, a black coating of oxide being formed on the pipes, which prevents them from rusting for a time. There is no permanent protective covering for iron soil-pipes, for to whatever process they are submitted the coating will come off in a few years, and the pipes will corrode. Both the solution and the coating, however, protect the outside surface of the pipes whether fixed above or below ground. Although such coatings are not permanent, no iron soil- or drain-pipes should be fixed without them.

**Glass-enamelled iron pipes** have been recently introduced for soil-pipes. If the enamel is perfect and will stand the extremes of heat and cold without cracking, then it is a good coating; but neither porcelain nor glass-enamel will stand such a test. If there is the slightest flaw in the surface of either, the enamel will be forced off by the corrosion of the metal behind. The surface of the glass-enamelled pipes fouls in a way opposite to that of lead and iron pipes. Both lead and iron, no matter how treated, become covered with a film or coating of slime, which, *as long as the pipes remain moist*, prevents them from being fouled by the adherence of excrementitious matters. In the case of glass-enamelled pipes, no such film or coating will be formed, and the internal surface of the pipes is fouled by the contact of the soil as it passes through the pipe.

Such matter cannot readily be scoured off, especially during the summer when the warmth of the mass of metal holds it to the surface. When the pipe has cooled down to about the same temperature as the flushing water, some of it may be removed. These pipes require too much care in the fixing, and as cutting cannot be thought of, they must come from the manufacturers ready for being fixed.

**Cast-iron bends** at the feet of soil-pipes should be of long radius and good pitch, and should be provided with strong wide foot-rests (as in fig. 221), cast on the bends directly under the upright length of the pipes. Such a bend should be set on a good bed of concrete, the flange being also covered with concrete to prevent it being moved. The bend should be firmly fixed, and the drain and soil-pipe connections to it should be made by expansion-joints. When the soil-pipe is in a shady corner, it may be connected by the usual caulked lead joint, but the drain should always be connected by means of an expansion-joint.

**Junctions** should be cast on the soil-pipe, so as to save the cutting of the pipes and the large number of joints such cutting entails. All junctions should enter the main soil-pipe curved in the direction of the flow of water or air; they should never be straight or mitred. The curved connection gives a much greater area at the mouth of the branch-pipe than any other, and there is much less probability of the solid plug covering the whole length of the opening in the side of the main soil-pipe.

**The jointing of cast-iron pipes** (light, medium, and strong) is as shown in fig. 222. *Light pipes* can only be jointed with red-lead and chopped hemp, or marine glue, but the top length standing above the roof is often run in with lead to hold it securely in position, when no iron stay is fixed. The lead cannot be caulked without splitting the socket, and as the space between the surfaces of the metals is so small, it is almost impossible to run the lead in so as to make a good joint. In some towns and cities, the Health Department fixes 6-inch light iron pipes as sewer-vents up the face of public buildings and houses, the joints being made with red-lead. Two such stacks of pipes are just under the notice of the author; one horizontal pipe is cracked, and has a long patch wired along its upper side; the joints are generally cracked and open, and when remade they

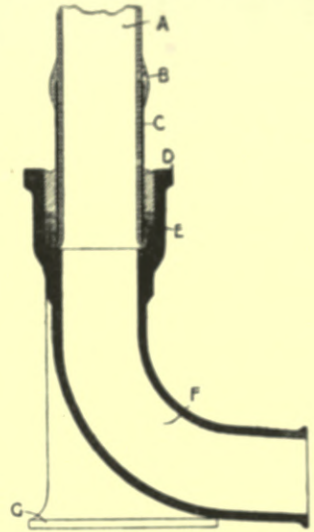

Fig. 221.—Cast-iron Bend with Foot-rest, and Connection with Lead Soil-pipe.

A, lead soil-pipe; B, wiped joint; C, brass or copper thimble; D, caulked lead; E, spun yarn; F, cast-iron bend; G, foot-rest on bend.

do not last a month. The building on which they are fixed has recently been in the hands of sanitarians, who have disconnected the drains from the sewer, and although typhoid fever has broken out, it was not considered worth while

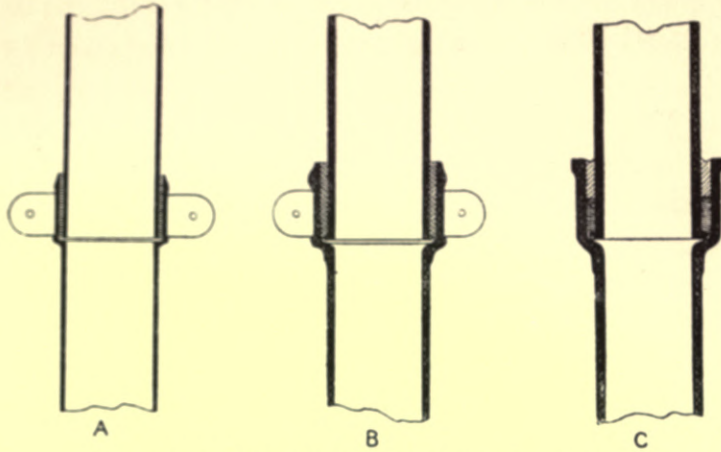

Fig. 222.—Joints of Iron Soil-pipes. A, light; B, medium; C, strong.

to remove the two stacks of sewer-ventilating pipes. The Health Department should have fixed heavy lead vent-pipes with the joints wiped.

*Medium pipes* have larger sockets, and a much better joint can therefore be made, but as they cannot be caulked strongly and

tight, the joints may become slack after a time. The fixing of these pipes is the same as for the light pipes, both being held up by nails driven through the lugs into the walls, or suspended on brackets.

*Heavy iron soil-pipes* allow a good and strong joint, as shown in the illustration. Two rings of spun yarn are caulked down first to prevent the lead from running through the joint into the pipe, and the remainder of the socket is filled up with molten lead, and caulked whilst warm. Some authorities say that the spun yarn used in the joint may be saturated with foul matter in the event of the pipe being stopped up, but this is straining at a gnat as regards the materials used for making the joint, and swallowing a camel as regards the fixing of the iron pipe instead of lead. The heavy cast-iron pipes are fixed to strong cast-iron brackets, and owing to the thickness of the metal forming the pipe, and the bulky socketed joint, they have a very ugly and heavy appearance.

The advantages of iron soil-pipes of good quality are that nails cannot be driven into them, that they are not bulged by light blows, and that, if waste-pipes from sinks, &c., are connected with them, the hot water does not affect them to the same extent as it does lead pipes. Other advantages of iron are that it is cheaper than lead, and does not require the same amount of skill in fixing.

The disadvantages of iron soil-pipes may be summed up as follows:—1. Cast-iron is a rigid and intractable material; all bends and junctions must therefore be specially cast, and the several parts cannot be “humoured” in fixing without

throwing the joints crooked. 2. The metal is apt to corrode, both internally and externally. 3. The thickness of the metal necessary for good work renders the pipes and sockets heavy and unsightly. 4. The crust of the pipes often varies considerably in thickness, and may contain flaws and even small holes. 5. The pipes may be cracked by a hard blow. 6. The sockets are often too small and too weak for a proper joint to be made in them. 7. Cast-iron pipes require regular painting to preserve them from external corrosion.

**The testing of a stack of soil-pipes** ought never to be omitted. Several methods are available, but the water-test is the only suitable one for ascertaining the soundness of cast-iron pipes and the effectiveness of their joints. In the event of a stoppage the pipes would be subjected to the same amount of pressure up to the level of the first w.c. From that point to the top, the pipes may be subjected to a chemical or a smoke test. The smoke test is the better of the two, as the smoke can be seen. It may be forced into the pipes under a little pressure, though this should not be sufficient to break the seals of the traps. If, however, the traps are plugged up, much more pressure may be used.

**Lead hand-made seam-pipes** have been referred to in the chapter on waste-pipes. They were formerly much used for soil-pipes, but experience showed that the seams were apt to give way and cause leakage. Probably this was largely due to the hot water from baths, sinks, &c., which in those days were commonly connected with the soil-pipe. Undoubtedly seamed pipes are more durable, when hot water is kept from them, and when they are properly ventilated. Used for rain-water only, seamed pipes will last for a great number of years; the writer has seen many which have been in use for nearly a hundred years, and which appear to be still quite satisfactory. The supposed superiority of drawn-lead pipe is slight when both are fixed under favourable conditions. A seamed pipe and bend made from one piece of sheet-lead, is of the same substance throughout, while the metal of a drawn pipe is sometimes thicker on one side than the other. Frequently, too, the sheet-lead is better than the lead used for the drawn pipe. The seams may be either "burned" or "wiped" (sometimes known also as "swabbed"), and great care is necessary on the part of the workman to ensure that the joint is thoroughly "tight" throughout.

**Solid drawn-lead pipes** are now in high favour, and as they are made ready for use, and in suitable lengths, they are much used for soil-pipes, and also for rain-water pipes when such pipes are fixed on the face of an important building. The bad conditions under which the old seamed pipes were fixed have done more to bring this pipe into general use than anything else. The well-made drawn-lead pipe forms undoubtedly an excellent soil-pipe, being smooth both internally

and externally, and not easily cracked. On the other hand, drawn-pipes of inferior quality are not uncommon. There may be deep scratches and indentations almost through the substance of the lead, and the outside and inside of the pipes may be scored with lines throughout their length. The metal of the pipes may, possibly, be equal in thickness to only 6-lbs. sheet-lead on one side, while the other side is equal to 8-lbs. or 9-lbs. They are sometimes made of very hard and inferior lead, which increases by about one-half the length of time required to make a bend; and when the bend is made it is a poor one, as the lead is too hard to be driven from the front to the back of the bend to bring it to an even thickness. Drawn pipes should be free from blisters and thin ragged ends of lead. They should not be heavily greased, as grease hides the imperfections; and they should be as soft as ordinary sheet-lead of the same strength.

Drawn-lead pipes are rarely used in full lengths, and are usually cut up to suit the job in hand, so that in ordering care should be taken to get the lengths most suitable for cutting up advantageously. The lengths for outside work are usually about 6 feet or 7 feet, but in some classes of work the full length of 10 feet, 12 feet, or 14 feet is used.

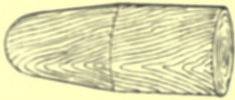

Fig. 223.—Wood Pipe-straightener.

Before being fixed, the pipes are **straightened by hand-pressure** on the bench, and afterwards by a small piece of soft wood. The pipe is then warmed, and a wood straightener of the shape shown in fig. 223 is driven through it, which brings it once more into shape. The wood mandril can now be put in and the pipe slightly flamed up, when it is ready to be prepared in the usual manner for fixing, unless there are bends to be worked on it, or stays to be soldered to it.

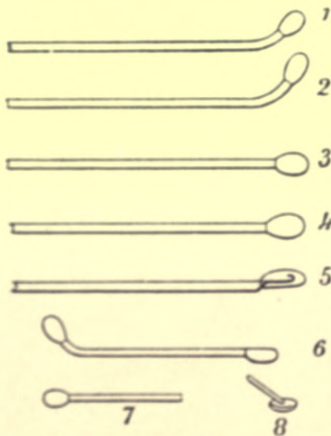

Fig. 224.—Wood Dummies for Pipe-bending.

To make a bend, take the length of pipe required, allowing about 3 inches extra for the bend. First round up the pipe, and then select suitable wood mandrils, one for each end of the pipe, and also the dummies required for working the bend. The wood mandrils may be 3 feet and 4 feet long, and the dummies required are shown in fig. 224. No. 1 will be used first, and as the bend is being formed No. 2 will be required, to reach where No. 1 fails. No. 3 is a straight, round-ended dummy, used to lift up the straight part of the pipe, and No. 4 is a flatter dummy, for rounding up and taking out some of the marks caused by the other dummies. It is shown in section in No. 5. No. 6 is a

double-ended dummy suitable for making offsets. Nos. 7 and 8 are short hand-dummies. A piece of soft wood  $2\frac{1}{2}$  inches by 2 inches, and 15 inches long, planed smooth and with the edges rounded off, is used in flattening the pipe for bending, and for driving the surplus lead towards the back, which should be done

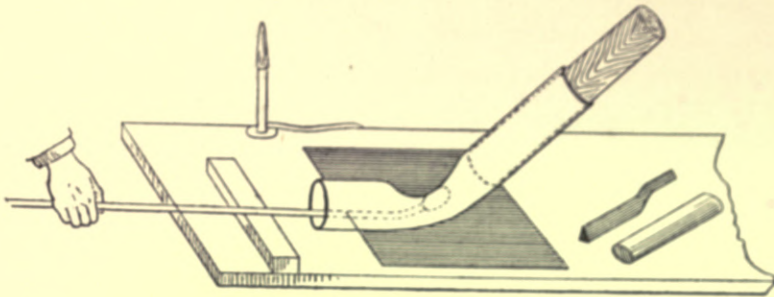

Fig. 225.—Bending Drawn-lead Pipe: 1st stage.

without marking or damaging the pipe. The pipe should be first flattened for a distance of 6 inches on each side of the place marked for the bend. The mandrils should then be driven in tight, up to the flattened portion. The throat of the bend may be heated with a blow-pipe, bunsen-burner, or spirit-lamp. The worker should place his felt against the pipe, and his knee against the felt, and pull the mandrils towards him. The pipe being placed on its side, the bulged-up lead on the sides should be driven to the back, and then the pipe may be bent a little more. The mandril should then be taken from one end, and dummy No. 1 should be driven up the throat, whilst the pipe is held

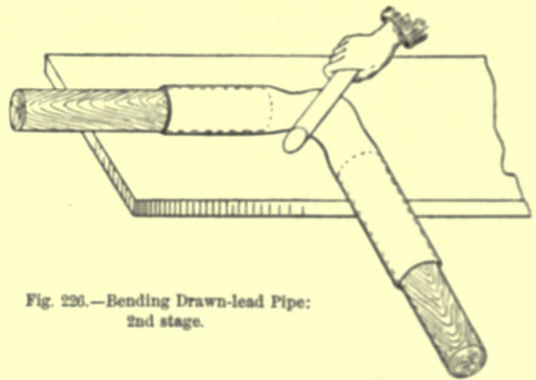

Fig. 226.—Bending Drawn-lead Pipe:  
2nd stage.

as shown in fig. 225. The dummy is passed over a piece of wood, which serves as a fulcrum in front of the pipe, and by means of which a heavy blow can be struck. If the pipe is kept warm, there will be little difficulty in lifting up the lead which is forced inside during the bending of the pipe. The pipe must be held firmly up, or the blows from the dummy will cause it to open out again nearly straight. The sides must be flattened, and the process repeated as before, all the spare lead being driven to the back, as shown in fig. 226; and the throat should be worked up from each end with dummies 1 and 2. The next bending should bring the pipe round to the desired position, and after the throat has

been worked up with the round dummies Nos. 1, 2, and 3, No. 4 should be used to round up the straight parts of the pipe so that the mandrils can be put in up to the bend, and the pipe straightened on them. Fig. 227 shows the bend

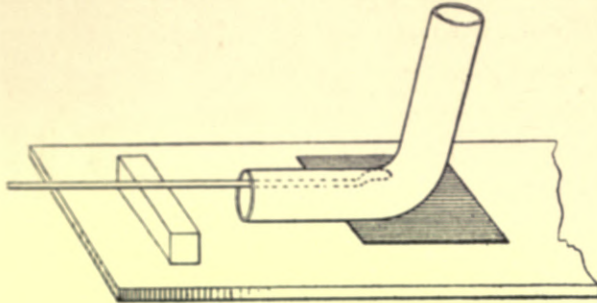

Fig. 227. - Bending Drawn-lead Pipe: 3rd stage.

nearly finished. The bent portion is finally rounded and dressed up with dummies, the short hand-dummies being used in preference to the long ones, if the inside can be reached. If the piece of soft wood has been properly used to drive the surplus lead to the back, the metal at this part will be as thick as the unworked pipe, if not thicker. Hard-wood dressers should not be used, as they "work" the lead instead of driving it bodily, and the bulk of the spare metal will be found on the sides instead of at the back.

When **making an offset**, the second bend should be commenced when the first has been half made. Care should be taken to allow sufficient length of

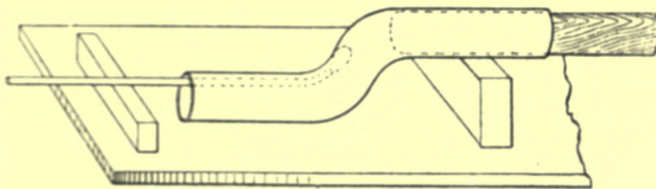

Fig. 228. - Making an Offset, or Ogee Bend, on Drawn-lead Pipe.

pipe between the bends, as a length of from 2 inches to 3 inches is taken up, according to the worker, and the more taken up the better and stronger the bend. When the bends are close together, as in fig. 228, they are both worked at one time, and can be done in from 4 to 6 bendings or throws of the pipe. If the bends are more than 6 inches apart they should be worked separately.

**To make a junction** between the soil-pipe and branch-pipe, the branch-pipe should be bent as near the end as possible, and worked up with hand-dummies. One throw of the pipe should be enough. The pipe should then be placed on the bench, with the branch end inclined to the proper fall, and the line across the bend should be marked with the bench square, and cut. After the end has been rounded-up and rasped, it is ready to be fitted to the main soil-pipe. The length and shape of the hole required in the main-pipe can be marked on placing the end of the branch-pipe on it. Cut out from the main soil-pipe, lengthways, a strip  $1\frac{1}{4}$  inches wide, commencing  $\frac{1}{2}$  inch from the top side of the proposed hole, and continuing to nearly 1 inch from the bottom side. The socket must



now be formed with the hand-dummy, and the branch-pipe be fitted into it. The pipe should then be chalked, tarnished, and afterwards shaved and greased, when the joint is ready for soldering, as shown in fig. 229. The metal is splashed or thrown on the pipe, from the ladle, by the splash-stick or spitter,—a piece of wood of any convenient size and shape. The ends of the pipes are usually stopped up, to prevent a current of air from passing through and cooling the pipes. The pipes are so fixed that the fallen solder will remain in contact with the bottom part of the pipe, to assist in getting up the heat, and some of the molten solder is lifted up now and then and placed on the joint. When there is a good body of solder on the pipes, and it is molten at all parts, the heat is then “up”, and the plumber may take the hot plumbing-iron and shape it roughly all round; he must then commence to “wipe” from a point as far round the back as he can reach, bringing the surplus metal round the front, and on to the point where he first commenced to wipe. A good body of solder is necessary for the joint to be finished off smoothly, so that the joining cannot be seen. A poor wiper leaves his joints roughly finished, and of a bad colour near the point where the joint is finished off.

A branch joint may be made (as shown in fig. 230) to give the branch-pipe a good pitch. The method of making is the same as in the case already described. There are, of course, many different shapes of branch connections for the sides of main soil-pipes, some having short bends and others long. It will serve no good purpose to illustrate them, as all the branch joints are the same in so far as the practical work is concerned.

To make underhand and upright joints requires much more skill on the part of the plumber than to make the branch joints just described. Both these joints are prepared and socketed in the same way, the difference between them depending wholly on the position in which they are made. “Underhand” joints range from horizontal to an angle of  $45^\circ$ , and from this point to the perpendicular they may be termed “uprights”. These joints should be  $3\frac{1}{4}$  inches long. The spigot end should be shaved for a length of  $1\frac{7}{8}$  inches, and the socket end for  $1\frac{5}{8}$  inches, the depth of socket being from  $\frac{1}{4}$  inch to  $\frac{3}{8}$  inch. The ends of the pipes are shown prepared for putting together in fig. 231, and the joint is shown finished

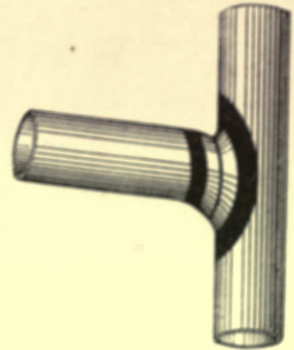

Fig. 229.—Wiped Branch Joint.

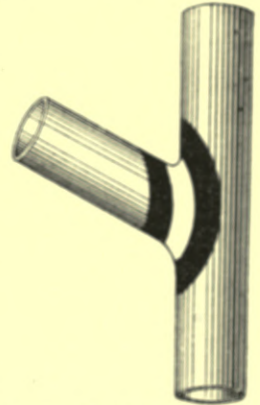

Fig. 230.—Wiped Branch Joint of quicker Pitch.

in fig. 232. In making the joint, the solder is poured over the pipes, and received in the solder-cloth, which is held beneath the pipe to keep a quantity of solder against the bottom of the joint, and also to regulate the quantity used. The solder is manipulated and pushed round the joint from one position



Fig. 231.—Wiped Underhand Joint: Pipes ready for joining.



Fig. 232.—Wiped Underhand Joint complete.

to another, until the pipes become so hot that there is some difficulty in keeping the requisite amount of solder on the pipes to make the joint. When the pipes are heated to this stage, the whole of the metal will be in a molten condition. The ladle may then be put down, the cloth taken in both hands, and the joint wiped. A good wiper will often change the position of the solder by bringing the bottom solder to the top, and pushing that at the top to the bottom, whilst he is shaping the joint, and regulating the quantity of solder on it, previous to wiping it. A much simpler and a better method of wiping is to use the plumbing-iron, by which the whole of the solder on the joint can be brought to a more even temperature, and the joint can be wiped in stages without the hurry and bustle of the other method. It is to be regretted that the use of the plumbing-iron is dying out, many plumbers having a foolish notion that he is only a poor wiper who uses the plumbing-iron.



Fig. 233.—  
Wiped Upright  
Joint.

The upright joint is made in exactly the same way as the underhand one. In fig. 233 the joint is shown ready for soldering, and the thickness of solder required for this and the underhand joint is also shown. A lead flange, and also a collar, may be placed beneath the joint to receive the solder falling from the pipes, and also to allow of some being lifted from it and placed on the joint. The solder which collects upon the collar assists to get up the heat. The difficulty in this case is to keep the solder from sliding down the pipe, when it is almost hot enough to be wiped. Most plumbers throw down the splash-stick as soon as this stage is reached, and taking up the cloth give a peculiar motion to the ladle, throwing some of the metal on the pipes, the surplus metal being caught by the cloth and incorporated with that already on the pipes. In this way a sufficient quantity of solder is kept on the pipes to make the joint. It is much better, however, to use the plumbing-iron, as it allows plenty of time to soften the whole of the solder, and the joint may be afterwards wiped in stages. The thickness of solder in the centre of both underhand and upright joints should be about  $\frac{3}{8}$  inch.

**Flange and block joints** for internal soil-pipes are shown in figs. 234 and 235. When in the angle of a room, the joints are usually made on each floor, and it depends upon the height between the floors whether there will be a joint between them. Flange and block joints carry the whole weight of the pipes, and stays are of little value and are rarely fixed. When the pipes are fixed in chases, the joints may be made anywhere, and are usually independent of the floors. The making of these joints is very simple. The solder is splashed on from the ladle, and pressed against the sides of the pipe by the use of the spitter. When a sufficient quantity of solder has been affixed, and it is all soft, the cloth may be drawn round, and the joint finished off at once without using the plumbing-iron. Some plumbers, however, use the iron, and by rubbing it round the joint the solder is heated and the surplus flows away, the joint being thus formed in a rough way by the iron. The wiping process is a little more difficult when the iron is used, as the metal is more fluid, and the wiping has to be repeated several times.

In **fixing lead soil-pipes** internally, the lead stays required are as shown in fig. 210, p. 316; but the main support is, as a rule, obtained by the use of flange joints, as shown in figs. 234 and 235. When upright wiped joints are made, the pipes must be wholly supported by lead stays, which may be single or double, and wiped to the back, front, or sides of the pipes. If the pipes are in an internal angle, the lead stays will be wiped to the sides of the pipe; if they are on the flat face of the wall, the stays will be soldered to the back; and if the pipes are in a chase, the stays will be wiped to the front. The method is shown in fig. 210.

For external work the pipes may be connected by the wiped plumbers' joint, and the lead stays, if of sheet-lead, will require to be cut and folded to some pattern to make them neat. Cast-lead stays are the best for outside work, and where the wiped plumbers' joint is made, no astragals are necessary. A good strong cast-lead clip and stay is shown in fig. 236. It consists of two ears, connected by two bands encircling the pipe. It may be used simply as a clip, or it may be wiped on the pipe as a stay or tack. The single cast stay or tack is shown in fig. 237; but it will



Fig. 234.  
Flange Joint.



Fig. 235.  
Block Joint.



Fig. 236.—Claughton's Cast-lead Double-banded Pipe-clip.

not look well unless fixed double, one on each side of the pipe. If the pipes are put up in 6-foot lengths, cast astragals and lugs may be used, and the soldered joint made by a lip joint, as shown at A in fig. 238. The astragals will not be alike, the lower one being made to correspond with the upper one after the joint has been made. The lugs are cast separately, and as they present a large surface to the side of the pipe, they may either be sweated on, or wiped.



Fig. 237. - Single Cast-lead Stay.

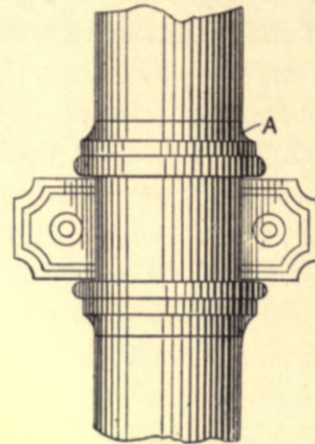

Fig. 238. - Pipe-stay with Lip Joint and Cast Astragals and Lugs.

The weight and thickness of lead soil-pipes usually correspond with the weight and thickness of sheet-lead, and this uniformity should always be adhered to, as it allows of the usual standard gauge being applied to the pipes in the same way as to sheet-lead. It is then an easy matter to calculate the weight of metal in any given size and length of pipe. The thickness of sheet-lead of various weights is as follows:—

5 lbs. per superficial foot,	...	...	0.085 inch thick.
6	"	"	0.101 "
7	"	"	0.118 "
8	"	"	0.135 "
10	"	"	0.169 "

As the diameters of the pipes made by different firms vary, the weight of each pipe requires to be worked out separately in order to arrive at a correct result. The inside diameter of the pipe and the gauged thickness of the metal should be ascertained and compared with the specification. The lead may prove to be the correct thickness while the pipe is too small, or the diameter may be full and the lead thinner than specified.

The effect of hot water on lead soil-pipes is serious, leading to cracks of various kinds (on account of the repeated expansion and contraction), and for this reason, fittings at which hot water is supplied should never be connected with lead soil-pipes. The joints, bends, and junctions of pipes to which hot water has had access, are usually the first to exhibit symptoms of distress, but

seamed pipes often give way along one side of the seam, the lead tearing away at this point owing to the seam being harder and stronger. Besides the effect already indicated, hot water appears to change the smooth slimy coating, which under ordinary conditions forms inside a soil-pipe, into a very rough surface, which catches and retains much more of the solid matters passed into the pipe.

**Urine** has practically no effect on lead pipes beyond discoloration, but it has a direct action on all soldered seams and joints. The finer the solder the more it will be corroded, and the coarser the solder the better it will stand, showing that it is the tin in the solder which is affected. For this reason the seams of soil-pipes and urinal waste-pipes are wiped to get a larger, coarser, and stronger body of solder on the seams. Urine will pass through the pores of badly-made joints and seams, and often a yellowish bead is seen on the face where there are porous places in the soldering.

**The effect of the sun** on lead pipes is small, when these are fixed in 6-foot lengths with socketed joints; but when solid-drawn pipes are used, and the joints wiped, making a continuous pipe, the heat of the sun has a considerable effect. Such pipes cannot be expected to keep in a vertical position when the sun is shining on one side only of the pipe. The movement is only slight, but if repeated often enough, it will probably lead to permanent irregularity or even to cracks. The effect of the sun on the astragals is more noticeable, as they become slack and droop, unless soldered all round the pipe, and even then the soldering is liable to crack on account of its lightness. The heat of the sun also causes the pipes to fall away slightly from the walls, often tearing the stays if they are of thin sheet-lead.

It has been customary to **protect external lead pipes** by encasing the bottom length in a heavy cast-iron pipe. These iron pipes were used because the lead pipes were unsuitable for the bottom lengths on account of being easily damaged. Similar attention has had to be paid to drawn-lead pipes recently fixed in exposed positions, the iron casings having been specially cast to match the lead pipes and to suit the position. Lead pipes are now generally turned into chases at the bottom, cast-iron guard-plates being fixed in front to protect them from damage. When this can be done, it is much better than having a length of iron pipe fixed. Cast-iron guards from 2 feet to 3 feet high are often fixed to protect the bottom lengths of soil-pipes in passages, yards, or other places where they are likely to be damaged.

**The advantages of lead** over all other metals for soil and waste pipes are undoubted. Even in the matter of cost, its use ultimately proves more economical

than that of iron, which is its only recognized competitor. Dilute acids have a slight action on lead soil-pipes when first put into use; but in a short time—from a week to a month—the action ceases, owing to the formation of a film or coating on the inside of the pipes, which serves to protect them from further attack. Externally, the action of the atmosphere is practically the same; the metal is soon oxidized on its exposed surface, and after this has taken place there is no further perceptible change. Lead soil-pipes of good quality are impervious, light (in comparison with iron pipes of good quality), durable, neat, compact, and suitable for fixing inside or out. They can be fixed in any position, the bends and junctions being made on the spot. Lead pipes do not fur up to the same extent as iron pipes, neither do they, to the same extent, retard the flow of discharges, or the currents of air through them. Lead requires no protective coating or lining, and this saving in painting must in fairness be considered when comparing its cost with that of iron. The first cost of lead may be two or three times that of light iron; but the first cost of iron is never the last, and in fifty years it may have cost, in repairs, renewals, painting, &c., several times the amount originally paid for it, whereas a stack of lead pipe would probably not have cost one penny during the same time.

---

## CHAPTER VI.

### CONNECTION OF WATER-CLOSETS WITH DRAINS AND SOIL-PIPES.

The connection of earthenware traps to earthenware drain-pipes is only admissible for outside water-closets. Such connections are, however, frequently

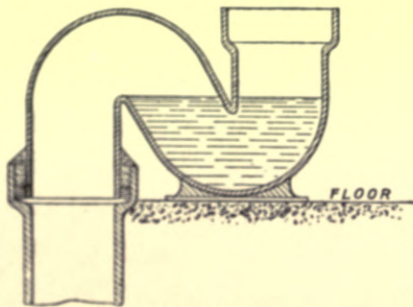

Fig. 239.—Connection of Earthenware Trap to Earthenware Drain.

made in the basements of houses; but as this necessitates the bringing of the drain into the house, it is advisable to disconnect the branch-drain outside, so that in the event of the joints giving way there will be no harmful results. The method of connection is shown in fig. 239. As the joint is an upright one, it is advisable to caulk it first with a ring of spun yarn saturated with cement, and afterwards to fill up the joint with good Portland cement. Where

only a small amount of fall is available between the closet and the sewer, a P-trap must be used, but the connection will be similar to that just described.

There are numerous methods of connecting earthenware traps to lead soil-pipes. The common socketed connections are shown in figs. 240 and 241, but these are the worst form of connection it is possible to make, and stringent rules

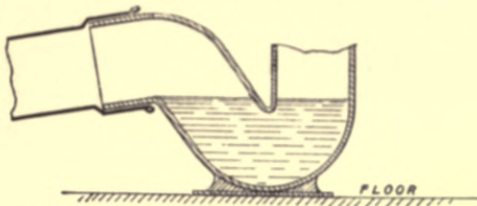

Fig. 240.—Connection of Earthenware Trap to Lead Soil-pipe by Socketed Joint.

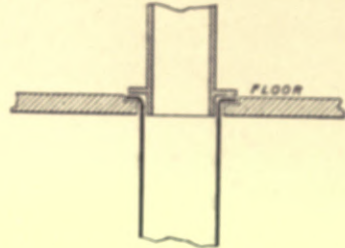

Fig. 241.—Connection of Earthenware Trap to Lead Soil-pipe by Socketed and Flanged Joint.

should be adopted by all Health Departments to secure their abolition. Of the two, the position of that shown in fig. 240 is the better, as it leaves the joint entirely exposed. The use of a socketed connection is solely due to the manufacturers of the commoner class of water-closets, who turn out the traps so that no other method of connecting is available. If they would even put a ring about 2 inches from the end of the trap, so that the lead could be fitted and worked round the ring,

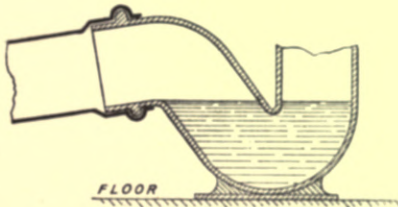

Fig. 242.—Improved Socketed Joint between Earthenware Trap and Lead Soil-pipe.

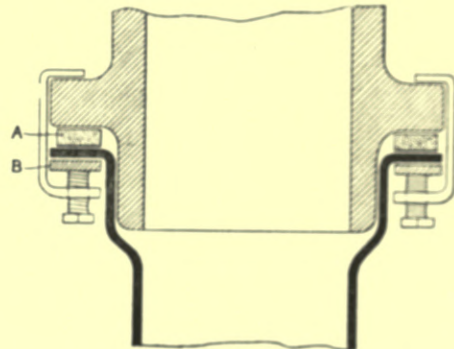

Fig. 243.—Socketed and Flanged Joint with India-rubber Ring, &c.

as in fig. 242, the joint would be much better and more durable, while the cost of manufacture would not be increased.

The connection shown in fig. 243 is a further improvement. The outgo of the trap is specially prepared by the formation of the spigot and flange, and the connection is made by means of an india-rubber ring, A, inserted between the lead and earthenware flanges, and bolted together by means of a brass collar, B, and hooked bolts with set-screws. It is a fairly good connection, having the valuable recommendation that it is not rigid and unyielding. This is an important point when floors or buildings are subject to vibration, but under

such circumstances the lead flange will be liable to give as well as the india-rubber ring, and the tighter the ring is screwed up, the greater the probability of the lead yielding. That the plain india-rubber ring is faulty, is proved by the introduction of an india-rubber ring covered with asbestos; this, however, will not stand the same amount of pressure even when screwed up tight, and has therefore been abandoned in favour of the old plan. It will be noted that the spaces between the india-rubber ring and the flange and the pipes, as well as the space between the socketed portion of the joint, cannot be filled with any kind of cement, so that a dangerous kind of fur can accumulate and find a permanent lodgment in and around the joint. This is undoubtedly a defect.

**Screwed connections** have also been devised. Messrs. Dimmock & Co. mould the outgo of the earthenware trap into the form of a screw, and make the connection to the soil-pipe by an ordinary brass nut and tail-pipe.

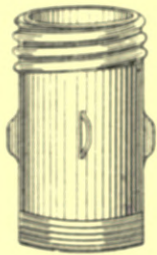

Fig. 244.—Freeman's "Grip" Joint.

In this joint there is no room for accumulations, the joint being tight, sound, and as permanent as earthenware will permit. Such a joint will remain tight until the earthenware breaks from vibration or pressure. Freeman's "Grip" joint (fig. 244) is a screwed connection on the same lines, but the connecting nut is of lead instead of brass, and the threads are much coarser.

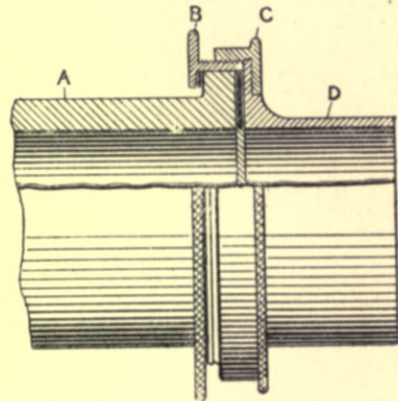

Fig. 245.—Quirk, Sharp, & Co.'s Joint.

Messrs. Quirk, Sharp, & Co. have a **patented connection** which deserves to be better known. It is shown in fig. 245 in elevation and section, and will be found a permanent and sound connection. The outgo of the earthenware trap, A, has a small bead at the end, behind which is placed the split collar, B. The union, C, when screwed up to the split collar, tightens the two small washers, one on each side of the bead. The brass tail-pipe, D, is connected with the soil-pipe by a wiped soldered joint. It will be seen that the connection is better than the one shown in fig. 243, as there are no spaces in which foul deposits can accumulate. The connection is of the permanent type, and cannot leak after it has been screwed up. It is also used for connecting the earthenware outgo to a cast-iron pipe by means of a caulked lead joint.

**Robinson's "Adaptable"** (fig. 246) is a suitable connection between water-



closets, urinals, or sinks, and lead or iron pipes. It consists of an earthenware collar covered outside with lead, so that a solder-joint can be made between it and the lead soil-pipe. The joint in the illustration is below the water-line, and the outgo of the closet may be turned in any direction, to suit the branch soil-pipes. The joint is slightly flexible. The connection is also used for the flushing-arm, as well as for connecting the trap-ventilating pipe with the trap.

The "Metallo-Keramic" joint (fig. 297, page 394) is very neat, and as perfect as can be expected, when such substances as lead and pottery are to be connected. The joint is not intended to be made by the plumber, but by one specially skilled in the work. The joint is a good one, but although the metal has undoubtedly a good grip of the pottery, it cannot be admitted that there is "an entire incorporation of the pottery and metal at the point of junction". Most people would conclude that the seam is a burned one; but it is plated with the copper-bit. The band of solder inside is necessary, as it is next to impossible for solder to flow down the socket in as solid a state as shown. Frequently the solder is found in wavy layers, partly separated from each other. The inside band is therefore necessary to make good the connection between the inside end of the trap and the inside edge of the soil-pipe. If this joint fails in use, the failure will be due to the soldered band inside the pipe giving way, or to slight corrosion of the tin, which may cause a water leakage inside the joint. This, at any rate, is what experienced plumbers would expect to take place in the course of time. If anything goes wrong with joint or basin, the whole has to be renewed, and this fact must be taken into consideration when comparing the cost of the joint with that of others. When placing the apparatus in its proper position, great care is necessary to prevent the end of the closet outgo from being knocked or shaken, for the metal is not incorporated with the pottery any more than glue is incorporated with the wood on which it is used. This is a very rigid connection, and the slightest movement will in time break either the basin or the joint.

The connection of an earthenware trap with an iron pipe may be made by a Portland-cement joint if the trap is unglazed. A rigid joint is formed, and it can be relied on when well made with good cement, but there is always some danger of the cement breaking. Messrs. Quirk and Sharp's joint (fig. 245) can

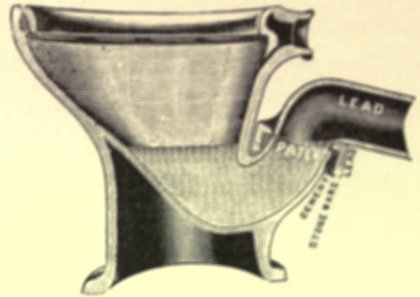

Fig. 246.—Robinson's "Adaptable" Joint.

also be used, and has the advantage of being a caulked lead joint, and slightly flexible, while it can also be unscrewed for the removal of the basin.

The connection between a lead trap and a lead soil-pipe is by means of a wiped soldered joint—the oldest, and in many respects the best, form of connection. It is shown in figs. 231, 232, and 233, p. 340.

The connection of a lead trap with an iron soil-pipe is made by means of a brass collar, which is passed over the lead pipe and wiped to it externally by the usual soldered joint, the bottom edge of the lead being turned and folded round the end of the brass collar. The usual caulked lead joint is used for the connection with the iron pipe. This also forms a good connection between a soil-pipe and an iron drain-pipe (fig. 221, p. 333). Another method of connect-

ing lead to iron (shown in fig. 247), is by using Robinson's "Enable" connecting collar, which is a double brass collar clipping the edge of the socket of the iron pipe. The socket is placed in the brass cup, which is then filled with molten lead and caulked. The flat top of the brass connection is tinned, and the lead pipe is fitted to it, when the usual wiped flange-joint can be made with the ordinary plumber's solder. The connection is more suitable for light pipes than the ordinary caulked lead joint, as there is no risk of the socket breaking, either while the joint is being made or afterwards.

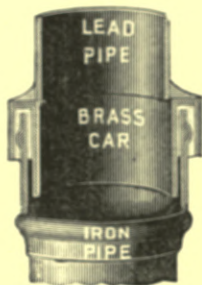

Fig. 247. — Robinson's "Enable" Connecting Collar for joining Iron and Lead Pipes.

The connection of a lead pipe with an earthenware or stone-ware drain-pipe has received but little attention from patentees. It is customary to wipe a lead flange to the pipe (as shown in fig. 248), the face of the flange being scored and afterwards bedded in red-lead cement, and the pipe-socket afterwards filled up with neat Portland cement. Robinson's

"Enable" connection for the same kind of joint is shown in fig. 249. The joint of cement between the fire-clay block and earthenware pipe will be as good as any other joint on the drain-pipes. The fire-clay block is lined with lead in one piece, which is turned round the top and bottom edges. The top of the block is specially shaped for the making of a good wiped flange-joint.

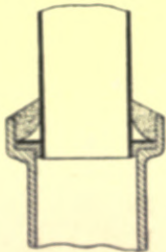

Fig. 248. — Flanged Joint between Lead Soil-pipe and Earthenware Drain.

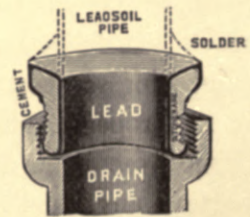

Fig. 249. — Robinson's "Enable" Connection between Lead Soil-pipe and Earthenware Drain.

The connections between iron traps and iron soil-pipes are the same as the joints on the stack of main soil-pipes, and will depend upon the class of iron pipe used. If the pipes have turned spigots and sockets, they may be connected

with neat cement. If the pipes and sockets are strong enough for caulked lead joints, the connection with the trap will be the same. They may also be connected by means of bolted flange-joints, or by any of the numerous patented connections. The best connection is probably the caulked lead joint, shown at c in fig. 222, page 334.

The connection between iron traps and lead soil-pipes should be by means of bolted flanges, the lead being tafted back to form a flange. This makes a tight joint when properly bolted to a corresponding flange on the iron trap.

## CHAPTER VII.

### WATER-CLOSET TRAPS AND THEIR VENTILATION.

Most water-closets of the wash-out and wash-down types are provided with traps of the same material as the basin, and frequently in one piece with it. The principal varieties of closet requiring lead traps are of the valve and syphonic patterns. The common hopper-closet is also sometimes fixed over a lead trap, but on account of the small area of the water at the bottom of the basin, the sides of this are soon fouled; for this reason the hopper-closet cannot be recommended. A lead trap is required beneath a pan-closet, but as this closet is now a thing of the past, at any rate in this country, nothing further need be said about it.

The **D-trap** is the form most commonly used in early water-closets, and may still be seen under pan-closets fixed a generation ago. It is a most insanitary contrivance, as its numerous angles retain the soil, and no amount of flushing can possibly cleanse it. The addition of a cap and screw, which can be removed for cleaning the trap (as shown in fig. 250), increases the already excessive cost of the trap, and is no remedy for the evil complained of. The sole advantage of a D-trap is that it does not lose its seal, either by syphonage or momentum; but as this property is also possessed, in a satisfactory degree, by other traps which are at the same time self-cleansing, the D-trap ought never to be used.

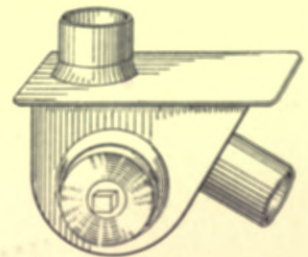

Fig. 250.—Lead D-trap, with 4-inch Cleaning Cap and Screw.

The hand-made round-pipe trap was a great improvement on the D-trap, and

is a safe and clean trap, if a sufficient depth of seal is provided to prevent syphonage. Fig. 251 illustrates the shape known as a P-trap; the shape of the S-trap is given in fig. 195, page 305. The round-pipe trap was formerly made with a slightly increased diameter at the bends, but this has long been proved to be a mistaken variation. About twenty years ago traps began to be made of equal bore throughout, and nowadays the tendency is to contract them at the

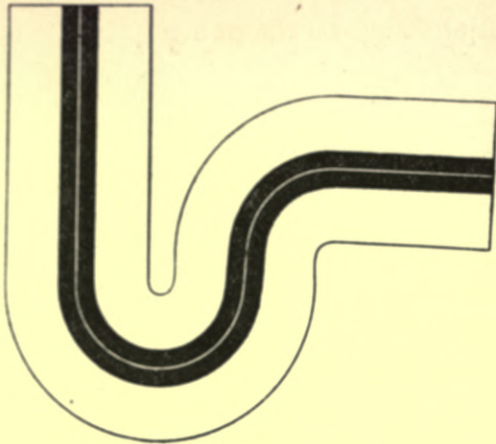

Fig. 251. —Hand-made Round-pipe P-trap.

bends so as to give greater velocity and scour at those places. The inlet and outgo legs of a

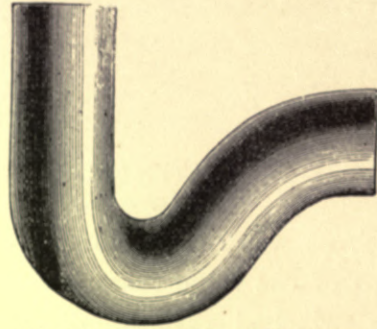

Fig. 252. —Cast-lead P-trap, with too easy Outgo.

round-pipe trap should be quite straight, and the space between the legs small. Fig. 197, page 306, illustrated an improved form of round-pipe trap, the shape of the dip and outgo increasing the velocity of the water through the trap, and the depth of the seal, and reducing the amount of sealing water required.

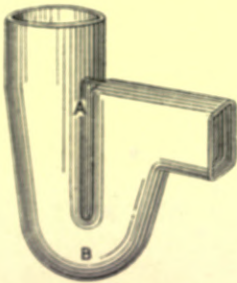
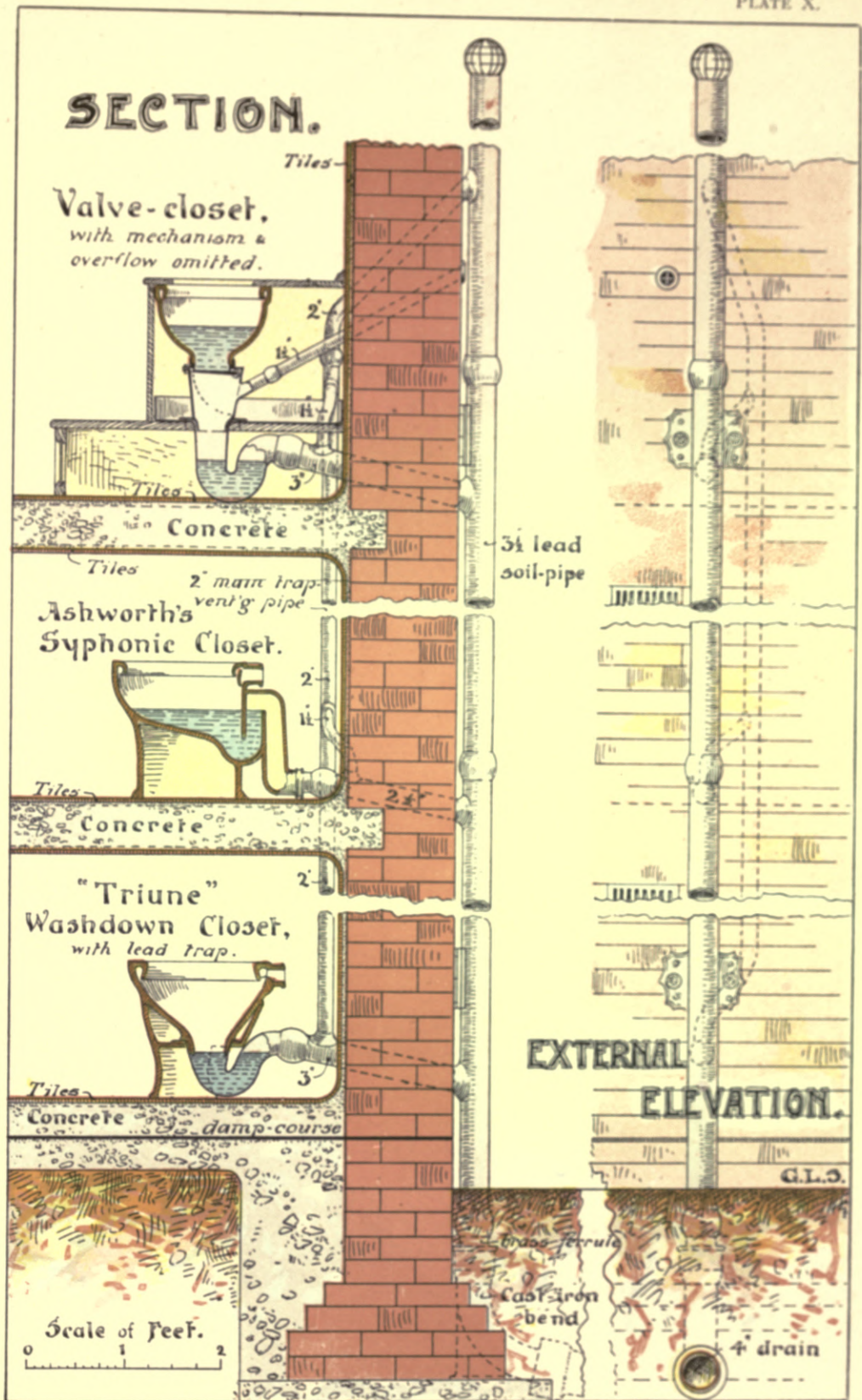

Fig. 253. —Cast-lead "Anti-D" Trap.

**Cast-lead round-pipe traps** are made in the P and S shapes, but in many of them the outgo is too easy, as shown in fig. 252, a fault which may lead to syphonage. The walls of these traps are also more liable to contain flaws than are those of "solid-drawn" lead traps.

The cast-lead "Anti-D" trap (fig. 253) is suitable only for valve-closets, as it requires a large quantity of water to overcome the frictional resistance offered by the trap. When there are no heavy discharges, the anti-D trap is not perhaps as clean as the round-pipe trap, or the one shown in fig. 197. It possesses, however, the great merit of being proof against syphonage in ordinary circumstances.

The "Dubois" round-pipe trap, shown in fig. 254, is made in the same way as lead pipe, the metal being forced through dies and bent to the required shape. It has the same bore throughout, and is a clean and safe trap to use, especially



SOIL-PIPE AND TRAP-VENTILATING PIPES FOR A TIER OF THREE CLOSETS.



when the dip and outgo are straightened. This trap is suitable for all classes of fittings. The 3-inch size should be used for water-closets in preference to 4-inch. The illustration shows "Claughton's" cast-lead socket and base attached to the drawn-lead trap, for the purpose of bringing the trap above the floor, and securing a perfect joint with the soil-pipe.

The thickness of lead for water-closet traps varies somewhat according to their shape and the form in which the material is used. D-traps were made from 6, 7, and 8 lbs. sheet-lead. Hand-made traps are usually made from 6 and 7 lbs. sheet-lead. Cast-lead traps are about equal to 8-lbs. sheet-lead, and drawn-lead traps to 6-lbs. and 8-lbs. sheet-lead. The smaller sizes range from 4½-lbs. to 6-lbs. The smaller anti-D traps are equal to about 9-lbs. sheet-lead.

The ventilation of water-closet traps is a matter of great importance, particularly when two or more closets are connected with one soil-pipe. The possibility of one trap being unsealed by the discharge through another trap connected with the same waste-pipe, has already been pointed out in connection with sinks, baths, &c., and the method of preventing such unsealing by means of ventilating pipes carried from the branch-pipes near the traps, has been explained and illustrated. The need for similar ventilation in the case of w.c. traps is much more urgent, as the air in the soil-pipe is, as a rule, fouler than that in an ordinary waste-pipe, and may indeed be the air from the drain or sewer. In Plate X. the soil-pipe and trap-ventilating pipes for a tier of three water-closets are shown.<sup>1</sup>

Where there are ranges of closets on each floor, all connected with the same soil-pipe, it is by some plumbers considered sufficient to ventilate only the trap furthest from the soil-pipe in each range, as at A in fig. 255; but this is a mistake. It is quite true that when the branches between the traps and branch soil-pipe are short, there is no necessity to ventilate them so far as the discharges from fittings on other floors are concerned, but there is every reason why they should be ventilated when discharges from other fittings on the same floor pass the ends of such branches. If there is only one such range connected with the soil-pipe, the trap-ventilating pipe will be connected with the main soil-pipe a little above the junction, as shown by the dotted lines, but if there are other closets on the



Fig. 254.—Dubois Drawn-lead Round-pipe Trap, with Claughton's Cast Base and socket.

<sup>1</sup> It should be pointed out that the joint between the three parts of the "Triune" closet is not a very good one.

upper floors, the ventilating pipe will be continued up as in Plate X., and connected with the soil-pipe above the highest closet.

The size of trap-ventilating-pipes will be determined by the size of the main

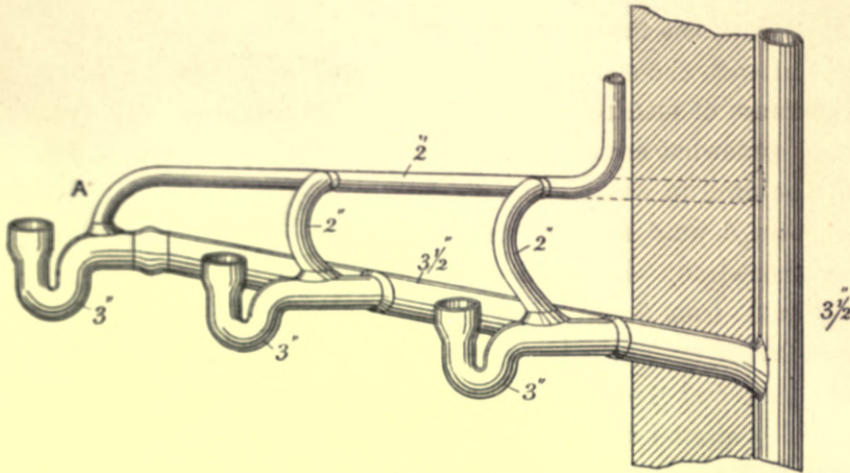

Fig. 255.—Soil-pipe and Trap-ventilating Pipes for one or more Ranges of three Water-closets.

soil-pipe and the height of the building. A 4-inch lead soil-pipe carried up a four-story building, and receiving a branch soil-pipe from a wash-down closet on each of the three upper floors, requires a 2-inch ventilating pipe, with  $1\frac{1}{2}$ -inch branches from the traps on the two upper floors. If valve-closets are fixed, the ventilating pipes would be much better if  $2\frac{1}{2}$  inches in diameter and the branches 2 inches. A similar stack of 3-inch lead soil-pipe should have  $2\frac{1}{2}$ -inch ventilating pipe, and 2-inch branches for wash-down closets; and for valve-closets, the size of the ventilating pipe should equal that of the soil-pipe, while the short branches should be 2 inches in diameter. The object to be attained is to hold a reserve of air in the ventilating pipes ready to supply the needs of the branches, and to assist the main soil-pipe. When the soil-pipe is reduced from 4 inches to 3 inches in diameter, the discharges more readily fill the pipe and form a plug, and therefore there is greater need for a trap-ventilating pipe of increased size. It is to replace the air-space lost by reducing the size of the soil-pipe that the size of the ventilating pipes is increased, as well as to enable them the more readily to withstand the extra strain of discharges passing through small soil-pipes.

No ventilating-pipe should be of a thinner substance than 6-lbs. sheet-lead, and where there are sharp bends in the pipe, it would be much better if equal to 7-lbs. sheet-lead. These weights apply to all sizes of ventilating pipes, just as 8-lbs. and 10-lbs. apply to all sizes of soil-pipes.



In dealing with **the waste-pipes from various fittings**, it has been made clear, that in no case should the waste-pipe from a sink, fixed for the purpose of receiving slops, be connected with the waste-pipes from lavatories, baths, or wash-up sinks. The pipes fixed for the conveyance of excremental matters, both liquid and solid, should not be connected with the ordinary soapy-water waste-pipes. On the other hand, no waste-pipe from bath, lavatory, or sink should be connected with the soil-pipe, or waste-pipe from slop-sink or urinal. There should be a complete severance between the two classes of waste-pipes. The waste-pipes from baths, lavatories, and sinks may be termed the hot soapy waste-pipes, and should be of small size and strong quality. The wastes from water-closets, slop-sinks, and urinals may be termed the cold-water waste-pipes, as hot water should never be allowed to pass through them, not only on account of the damage done to the pipes, but on account of the excessive amount of furring which takes place in the pipes when hot water and soap are allowed to pass through them. Slop-sink and urinal waste-pipes may be connected with soil-pipes, or they may be carried down separately if this is more convenient. Where possible they should be arranged to come near the soil-pipe, as long lengths of waste-pipe from such fittings in time become very foul. If the waste-pipes from slop-sinks or urinals are carried down separately, they should be treated like small soil-pipes.







1870

1870

178208      Art  
                 Sutchcliffe, G. Lister      ArchB  
                 S  
Title    The principles and practice of modern house-  
                 construction.    Vol.2.

University of Toronto  
Library

DO NOT  
REMOVE  
THE  
CARD  
FROM  
THIS  
POCKET

Acme Library Card Pocket  
Under Pat. "Ref. Index File"  
Made by LIBRARY BUREAU

I/1 • VANVM • LABORAVERT • QVI • ÆDIFICANT • EAM

