



# ADVANCES IN CARBOHYDRATE CHEMISTRY

Volume 1

W. W. Pigman &  
M. L. Wolfrom

# ADVANCES IN CARBOHYDRATE CHEMISTRY

*Edited by*

W. W. PIGMAN

*Corn Products Refining Co., Argo, Illinois,  
formerly with National Bureau of Standards*

M. L. WOLFROM

*The Ohio State University,  
Columbus, Ohio*

*Executive Committee*

WILLIAM L. EVANS

HERMANN O. L. FISCHER

C. S. HUDSON

R. MAX GOEPP, JR.

W. N. HAWORTH

VOLUME 1



1945

ACADEMIC PRESS INC. PUBLISHERS  
NEW YORK, N. Y.

**COPYRIGHT 1945, BY  
ACADEMIC PRESS INC.**

**PUBLISHED IN THE UNITED STATES OF AMERICA  
FOR ACADEMIC PRESS, INC.  
125 EAST 23<sup>RD</sup> STREET, NEW YORK 10, N. Y.**

Printed in the United States of America

---

**The Murray Printing Company  
Cambridge, Massachusetts**

## CONTRIBUTORS TO VOLUME I

ERNEST ANDERSON, *Department of Chemistry, University of Arizona, Tucson, Arizona.*

C. JELLEFF CARR, *Department of Pharmacology, School of Medicine, University of Maryland, Baltimore, Md.*

ROBERT C. ELDERFIELD, *Columbia University, New York, N. Y.*

CHARLES R. FORDYCE, *Eastman Kodak Co., Rochester, N. Y.*

C. S. HUDSON, *National Institute of Health, U. S. Public Health Service, Bethesda, Md.*

JOHN C. KRANTZ, JR., *Department of Pharmacology, School of Medicine, University of Maryland, Baltimore, Md.*

EUGENE PACSU, *Princeton University, Princeton, N. J.*

ALBERT L. RAYMOND, *G. D. Searle and Co., Chicago, Illinois*

NELSON K. RICHTMYER, *National Institute of Health, U. S. Public Health Service, Bethesda, Md.*

LILA SANDS, *Department of Chemistry, University of Arizona, Tucson, Arizona.*

THOMAS JOHN SCHOCH, *Corn Products Refining Company, Argo, Ill.*

R. STUART TIPSON, *Department of Research in Pure Chemistry, Mellon Institute, Pittsburgh, Pa.*

ROY L. WHISTLER, *Northern Regional Research Laboratory, Bureau of Agricultural and Industrial Chemistry, U. S. Department of Agriculture, Peoria, Illinois.*

This Page Intentionally Left Blank

## EDITORS' PREFACE

The increasing tempo of research and the consequent increased specialization of research workers make it desirable to provide frequent reviews of important developments in carbohydrate chemistry, not only for carbohydrate chemists, but also for research workers in other fields and industrial chemists and teachers. With this book there is begun the publication of a series of annual volumes entitled "Advances in Carbohydrate Chemistry." For each volume invitations will be extended to selected research workers to prepare critical reviews of special topics in the broad field of the carbohydrates, including the sugars, polysaccharides, and glycosides. It is also the intention to cover, as far as the available space will permit, biochemical, industrial, and analytical developments. It is our plan to have the individual contributors furnish *critical*, integrating reviews rather than mere literature surveys and to have the articles presented in such a form as to be intelligible to the average chemist rather than only to the specialist. Although the usual rules of the assignment of proper credit for developments will be followed, we do not believe it necessary to quote all past work done in a particular field and the contributions of a particular laboratory or group may be emphasized.

It may be found desirable to present several reviews of controversial subjects, particularly of those in fields undergoing a rapid state of development. In this way different points of view will find expression. In addition to the presentation of topics covering recent advances, we are providing occasional articles which will review thoroughly special fundamental topics in carbohydrate chemistry. These articles will cover fields which have matured and will be quite complete from the historical standpoint. After a number of years, it is hoped that the aggregate of these articles will provide a fairly complete summary of carbohydrate researches.

The general policies of the "Advances" have been formulated by an Executive Committee consisting of W. L. Evans, H. O. L. Fischer, R. Max Goepf, Jr., W. N. Haworth, C. S. Hudson and the two editors. It is a pleasure to announce that, beginning with the second volume, Dr. Stanley Peat of Birmingham University, England, will act as Associate Editor to solicit and edit contributions from the British Isles. It seems probable that an enlargement of the organization may be expected in the future.

Because the present volume is the first to be presented, we trust that the readers will not be too critical and will remember that the attainment of uniformity and the establishment of permanent policies will require some time and much consideration. The present international conflict has made the solicitation of manuscripts difficult and has provided many other difficulties. The cooperation shown by the contributors to the first volume is greatly appreciated.

We hope that the "Advances" will receive the whole hearted support of carbohydrate chemists in particular and of the chemical profession as a whole. Such support is necessary for the successful continuation of our work. We would be very glad to receive suggestions from the readers, of better ways in which we can serve the needs of carbohydrate chemists and of fields in need of review.

The support and encouragement given by the publishers in this undertaking are gratefully acknowledged. The index has been compiled by Dr. L. T. Capell. Mr. J. V. Karabinos has rendered valuable editorial assistance.

Chicago, Illinois  
Columbus, Ohio

THE EDITORS  
W. W. P.  
M. L. W.

## CONTENTS

CONTRIBUTORS TO VOLUME I.....	iii
EDITORS' PREFACE.....	v

### The Fischer Cyanohydrin Synthesis and the Configurations of Higher-carbon Sugars and Alcohols

By C. S. HUDSON, *National Institute of Health, U. S. Public Health Service,  
Bethesda, Maryland*

Introduction.....	2
I. The Cyanohydrins and the Corresponding Acids and Lactones.....	2
II. Emil Fischer's Discovery and Application of the Synthesis.....	3
1. Higher-carbon Sugars from D-Mannose.....	5
2. Higher-carbon Sugars from Rhamnose.....	7
3. Higher-carbon Sugars from D-Glucose.....	7
4. Higher-carbon Sugars from D-Galactose.....	8
III. The Configurations of the D-Mannoheptoses and the D-Galaheptoses.....	8
List of Configurations and Systematic Names for the Aldoheptoses from D-Glucose, D-Mannose and D-Galactose.....	9
IV. The Synthesis of Altrose and Allose from Ribose.....	10
V. The Synthesis of the D-Guloheptoses.....	11
VI. Mannoheptulose, Sedoheptulose, Perseulose, Perseitol and Volemitol.....	12
VII. The D-Perseitol and D-Mannitol Groups of Natural Carbohydrates.....	14
VIII. D-( $\alpha,\alpha,\alpha,\alpha$ )-Glucodecose and the Epimeric D-Glucodeconic Lactones.....	17
IX. Early Indications of Configurations by the Lactone Rule of Rotation.....	18
1. Rhamnose, Fucose, and the "Rhamnohexoses".....	19
2. "D-Glucoctose".....	20
X. The Configurations of Certain D-Glucoctoses and D-Galaoctoses.....	21
XI. Improvements in the Details of the Fischer Cyanohydrin Synthesis of Higher- carbon Sugars and the Identification of the Products.....	22
1. The Conversion of Aldonic Phenylhydrazides to Lactones.....	22
2. The Use of Calcium or Barium Salts with Sodium Cyanide.....	23
3. The Reduction of Sugars to Alcohols by Hydrogen and Raney Nickel.....	24
4. The Use of Various Solvents.....	24
5. Improvements in the Characterization of Osazones.....	24
XII. Similar Sugars.....	26
XIII. Nomenclature of Higher-carbon Sugars from Hexoses.....	28
XIV. Miscellaneous.....	
1. "Rhamnoheptose" and "Rhamnooctonic" Acid.....	28
2. "D-Glucononose" and "D-( $\alpha,\alpha,\alpha,\alpha$ )-Glucodecose".....	29
3. Fischer and Leuchs' Synthesis of Glucosamine.....	30
4. Levene and Compton's 6-Desoxy-D-gulose.....	30
5. The "Fucohexonic" Acids.....	30
6. Remarks concerning Certain Nonitol Configurations.....	31
7. Remarks concerning Synthetic D-Volemitol.....	32
8. Remarks concerning the Names "Volemose" and "Volemulose".....	32
9. A Simple Proof of Configurations in the Glucose and Galactose Series.....	33



XV. Data for the Identification of Various Higher-carbon Alcohols of the Sugar Group.....	34
---	----

### The Altrose Group of Substances

BY NELSON K. RICHTMYER, *National Institute of Health, U. S. Public Health Service, Bethesda, Maryland*

I. Introduction.....	37
II. Altrose from Ribose.....	38
III. Neolactose, Celtrobose, and Altrose.....	40
IV. Sedoheptulose and Sedoheptulosan.....	47
V. The Structure of D-Altrosan.....	50
VI. D-Altrose Derivatives from D-Altrosan.....	53
VII. D-Altrose from Methyl $\alpha$ -D-Glucoside.....	54
VIII. Epiglucoamine and Other Altrose Derivatives.....	57
IX. The 6-Desoxyaltroses.....	62
X. The Alluloses.....	64
XI. Calcium D-Altronate from D-Galactose and from Pectin.....	67
XII. Compounds Possibly Related to Altrose.....	71
XIII. Table I. D- and L-Altrose and Derivatives.....	72
XIV. Table II. Neolactose, Celtrobose, and Derivatives.....	76

### Carbohydrate Orthoesters

BY EUGENE PACSU, *Princeton University, Princeton, N. J.*

I. Definition and General Structure.....	78
II. Preparation and Properties.....	79
1. L-Rhamnose.....	79
2. Maltose.....	80
3. D-Mannose.....	83
4. D-Lyxose.....	84
5. 4- $\beta$ -D-Glucopyranosyl-D-mannose.....	85
6. D-Ribose and L-Ribose.....	86
7. D-( $\alpha$ )-Glucoheptose.....	88
8. 3- $\alpha$ -D-Glucopyranosyl-D-fructose (Turanose).....	89
9. D-Fructose.....	90
10. 4- $\beta$ -D-Glucopyranosyl-D-altrose (Celtrobose).....	91
11. D-Talose.....	92
12. L-Sorbose.....	93
13. D-( $\alpha$ )-Guloheptose.....	94
14. 4- $\beta$ -D-Galactopyranosyl-D-altrose (Neolactose).....	95
15. D-Galactose.....	96
16. 6-(ortho)-D-Mannopyranosyl-D-glucose.....	97
III. Rate and Mechanism of Hydrolysis.....	98
1. Acid-catalyzed Hydrolysis.....	98
2. Alkaline Hydrolysis.....	104
IV. Proof of Structure.....	107
1. Alkyl Orthoester.....	107
a. Physical Method.....	107
b. Chemical Method.....	107

2. Acidic Orthoester . . . . .	108
3. Orthoacyl Halide and Anhydride . . . . .	112
V. Mechanisms of Formation and Conversion . . . . .	113
1. Mechanism of Formation . . . . .	113
a. Aldose Alkyl Orthoester . . . . .	113
b. Aldose Orthoacyl Halide . . . . .	118
c. Ketose Alkyl Orthoester . . . . .	120
d. <i>aldehydo</i> -Aldose Alkyl Orthoester . . . . .	121
2. Mechanism of Conversion . . . . .	121
a. Hydrogen Chloride in Chloroform . . . . .	121
b. Titanium Tetrachloride in Chloroform . . . . .	122
c. Hydrogen Chloride in Methyl Alcohol . . . . .	122
VI. Conclusion . . . . .	124

### Thio- and Seleno-Sugars

BY ALBERT L. RAYMOND, *G. D. Searle & Co., Chicago, Illinois*

I. Thiosugars . . . . .	129
1. Natural Thioglycosides . . . . .	129
2. Synthetic Thioglycosides . . . . .	132
3. 1-Thioaldoses . . . . .	134
4. Thioglycosides from Mercaptals . . . . .	136
5. Thioaldoses (other than 1-Thioaldoses) . . . . .	141
II. Selenosugars . . . . .	144

### The Carbohydrate Components of the Cardiac Glycosides

BY ROBERT C. ELDERFIELD, *Columbia University, New York, N. Y.*

I. Introduction . . . . .	147
1. Occurrence and General Reactions of the Sugars of the Cardiac Glycosides . . . . .	148
II. Digitalose . . . . .	150
1. Chemistry . . . . .	150
2. Preparation . . . . .	156
3. Digitalonic Lactone . . . . .	158
III. Antiarose . . . . .	159
IV. Digitoxose . . . . .	159
1. Chemistry . . . . .	159
2. Preparation . . . . .	163
V. Cymarose . . . . .	164
1. Chemistry . . . . .	164
2. Preparation . . . . .	166
VI. Diginose . . . . .	167
1. Chemistry . . . . .	167
2. Preparation . . . . .	170
VII. Oleandrose . . . . .	171
1. Chemistry . . . . .	171
2. Preparation . . . . .	172
VIII. Sarmantose . . . . .	172
IX. Strophanthobiose . . . . .	173

### Metabolism of the Sugar Alcohols and Their Derivatives

BY C. JELLEFF CARR AND JOHN C. KRANTZ, JR., *Department of Pharmacology,  
School of Medicine, University of Maryland, Baltimore, Md.*

I. Introduction . . . . .	175
II. Methyl Alcohol . . . . .	176
III. Ethylene Glycol . . . . .	176
IV. Glycerol . . . . .	177
V. Tetrityls . . . . .	178
VI. Pentitols . . . . .	180
VII. Hexitols . . . . .	180
1. D-Mannitol and Anhydrides . . . . .	181
2. D-Sorbitol . . . . .	187
3. Polygalitol . . . . .	191
4. Dulcitol . . . . .	191
VIII. Summary . . . . .	192

### The Chemistry of the Nucleic Acids

BY R. STUART TIPSON, *Department of Research in Pure Chemistry,  
Mellon Institute, Pittsburgh, Pa.*

Introduction . . . . .	193
A. Ribosenucleic Acid . . . . .	196
I. Ribose Nucleosides . . . . .	198
1. Ribosylpurines . . . . .	198
2. Ribosylpyrimidines . . . . .	207
II. Ribose Nucleotides . . . . .	210
1. Ribosylpurine Nucleotides . . . . .	210
a. of Muscle . . . . .	210
b. of Ribosenucleic Acid . . . . .	214
2. Ribosylpyrimidine Nucleotides . . . . .	217
III. Ribosenucleic Acid . . . . .	219
1. Chemical Studies . . . . .	219
2. Enzymic and Physico-chemical Studies . . . . .	226
B. Desoxyribosenucleic Acid . . . . .	236
I. Desoxyribose Nucleosides . . . . .	238
1. Desoxyribosylpurines . . . . .	238
2. Desoxyribosylpyrimidines . . . . .	240
II. Desoxyribose Nucleotides . . . . .	241
1. Monophosphodesoxyribose Nucleotides . . . . .	241
2. Diphosphodesoxyribosyl-pyrimidines . . . . .	241
III. Desoxyribosenucleic Acid . . . . .	242

### The Fractionation of Starch

BY THOMAS JOHN SCHOCH, *Corn Products Refining Company, Argo, Illinois*

I. Introduction . . . . .	247
II. Older Methods of Starch Fractionation . . . . .	247
III. Recent Concepts in Starch Chemistry . . . . .	252
IV. Fractionation by Selective Precipitation . . . . .	258

V. Fractionation by Aqueous Leaching . . . . .	261
VI. Properties and Structures of the Fractions . . . . .	263
VII. Function of the Fractions in Starch Paste Behavior . . . . .	271
VIII. Pertinent Problems in Starch Chemistry . . . . .	275

### Preparation and Properties of Starch Esters

BY ROY L. WHISTLER, *Northern Regional Research Laboratory, Bureau of Agricultural and Industrial Chemistry, Agricultural Research Administration, U. S. Department of Agriculture, Peoria, Illinois*

I. Introduction . . . . .	279
II. Pretreatment of Starch for Esterification . . . . .	282
III. Preparation of the Starch Acetates . . . . .	284
1. Acetylation in the Presence of Pyridine . . . . .	284
2. Acetylation in the Presence of a Specifically Added Catalyst, Other than Pyridine . . . . .	286
3. Acetylation in the Absence of a Specifically Added Catalyst . . . . .	289
IV. Properties and Characteristics of Starch Acetate . . . . .	290
1. Acetyl Value and its Determination . . . . .	290
2. Solubility . . . . .	291
3. Properties of Starch Acetate Solutions . . . . .	292
4. Optical Rotation . . . . .	296
5. Fusion Temperature . . . . .	297
6. Mechanical Properties . . . . .	297
V. Preparation and Properties of Other Organic Esters of Starch . . . . .	300
1. Starch Formate . . . . .	300
2. Starch Propionate and Butyrate . . . . .	301
3. Starch Chloroacetates . . . . .	301
4. Starch Esters of Higher Fatty Acids . . . . .	301
5. Starch Tosylate . . . . .	302
6. Starch Benzoate and Cinnamate . . . . .	303
VI. Preparation and Properties of Inorganic Esters of Starch . . . . .	303
1. Starch Nitrate . . . . .	303
2. Starch Phosphate . . . . .	305
3. Starch Sulfate . . . . .	306
4. Starch Xanthate . . . . .	307

### Cellulose Esters of Organic Acids

BY CHARLES R. FORDYCE, *Eastman Kodak Co., Rochester, N. Y.*

A. Commercial Development . . . . .	309
B. Preparation . . . . .	310
I. Raw Materials . . . . .	310
II. Cellulose Acetate . . . . .	311
1. Acetylation Processes . . . . .	311
2. Modified Processes . . . . .	313
3. Partial Esterification . . . . .	314
4. Viscosity . . . . .	315
5. Salt Effect . . . . .	317
III. Mixed Esters . . . . .	317

IV. Other Organic Esters . . . . .	318
1. Esterification Methods . . . . .	318
2. Esters of Higher Aliphatic Acids . . . . .	319
3. Esters of Unsaturated Acids . . . . .	319
4. Esters of Substituted Aliphatic Acids . . . . .	319
5. Esters of Aromatic Acids . . . . .	320
6. Esters of Dibasic Acids . . . . .	320
7. Esters of Sulfonic Acids . . . . .	321
8. Carbamates . . . . .	321
C. Industrial Applications . . . . .	322
I. Production Trends . . . . .	322
II. Textiles . . . . .	322
III. Protective Coatings . . . . .	323
IV. Films . . . . .	325
V. Molding Compositions . . . . .	326

#### A Discussion of Methods of Value in Research on Plant Polyuronides

BY ERNEST ANDERSON AND LILA SANDS, *Department of Chemistry,  
the University of Arizona, Tucson*

I. Introduction . . . . .	329
II. Methods Used in Studying the Composition of Polyuronides . . . . .	331
1. Testing for Polyuronides . . . . .	331
2. Isolation of Polyuronides . . . . .	331
3. Purification of Polyuronides . . . . .	333
4. Analysis of Polyuronides . . . . .	334
5. Hydrolysis of Polyuronides . . . . .	335
6. Separating the Products of Hydrolysis . . . . .	337
III. Identifying the Units in the Polyuronic . . . . .	337
1. Methoxyl . . . . .	337
2. The Sugars . . . . .	338
3. The Uronic Acids . . . . .	338
IV. Methods for Determining the Structure of Polyuronic Molecules . . . . .	340
V. Some Results of Structural Investigation of the Polyuronides . . . . .	341

#### Errata

- Page 24, line 3 under section 4. For "z-propanol" read "2-propanol."
- Page 25, footnote 73. For "Diehls" read "Diels."
- Page 35, line 3 from bottom. For "D-Manno-L-manno-octitol" read "Manno-manno-octitol" since the structure is meso.
- Page 59, last line. For "trihydroxypyrazole" read "5-(D-erythro-1, 2, 3-trihydroxypropyl)pyrazole."
- Page 111, line 2 below formula. Reference number 56 should be 5, 6.
- Page 231, formula XI. Insert bond between P and OH at bottom.
- Page 275, line 13. For "hydroxymethyl" read "hydroxyethyl."
- Page 276, line 10 from bottom. For "carbonyl" read "carboxyl."

# THE FISCHER CYANOHYDRIN SYNTHESIS AND THE CONFIGURATIONS OF HIGHER-CARBON SUGARS AND ALCOHOLS

BY C. S. HUDSON

*National Institute of Health, U. S. Public Health Service, Bethesda, Maryland*

## CONTENTS

Introduction . . . . .	2
I. The Cyanohydrins and the Corresponding Acids and Lactones . . . . .	2
II. Emil Fischer's Discovery and Application of the Synthesis . . . . .	3
1. Higher-carbon Sugars from <i>D</i> -Mannose . . . . .	5
2. Higher-carbon Sugars from Rhamnose . . . . .	7
3. Higher-carbon Sugars from <i>D</i> -Glucose . . . . .	7
4. Higher-carbon Sugars from <i>D</i> -Galactose . . . . .	8
III. The Configurations of the <i>D</i> -Mannoheptoses and the <i>D</i> -Galaheptoses . . . . .	8
List of Configurations and Systematic Names for the Aldoheptoses from <i>D</i> -Glucose, <i>D</i> -Mannose and <i>D</i> -Galactose . . . . .	9
IV. The Synthesis of Altrose and Allose from Ribose . . . . .	10
V. The Synthesis of the <i>D</i> -Guloheptoses . . . . .	11
VI. Mannoheptulose, Sedoheptulose, Perseulose, Perseitol and Volemitol . . . . .	12
VII. The <i>D</i> -Perseitol and <i>D</i> -Mannitol Groups of Natural Carbohydrates . . . . .	14
VIII. <i>D</i> -( $\alpha,\alpha,\alpha,\alpha$ )-Glucodecose and the Epimeric <i>D</i> -Glucodeconic Lactones . . . . .	17
IX. Early Indications of Configurations by the Lactone Rule of Rotation . . . . .	18
1. Rhamnose, Fucose, and the "Rhamnohexoses" . . . . .	19
2. " <i>D</i> -Glucocotose" . . . . .	20
X. The Configurations of Certain <i>D</i> -Glucocotoses and <i>D</i> -Galaotoses . . . . .	21
XI. Improvements in the Details of the Fischer Cyanohydrin Synthesis of Higher-carbon Sugars and the Identification of the Products . . . . .	22
1. The Conversion of Aldonic Phenylhydrazides to Lactones . . . . .	22
2. The Use of Calcium or Barium Salts with Sodium Cyanide . . . . .	23
3. The Reduction of Sugars to Alcohols by Hydrogen and Raney Nickel . . . . .	24
4. The Use of Various Solvents . . . . .	24
5. Improvements in the Characterization of Osazones . . . . .	24
XII. Similar Sugars . . . . .	26
XIII. Nomenclature of Higher-carbon Sugars from Hexoses . . . . .	28

## XIV. Miscellaneous

1. "Rhamnoheptose" and "Rhamnooctonic" Acid . . . . .	28
2. "D-Glucononose" and "D-( $\alpha,\alpha,\alpha,\alpha$ )-Glucohexose" . . . . .	29
3. Fischer and Leuchs' Synthesis of Glucosamine . . . . .	30
4. Levene and Compton's 6-Desoxy-D-gulose . . . . .	30
5. The "Fucohexonic" Acids . . . . .	30
6. Remarks concerning Certain Nonitol Configurations . . . . .	31
7. Remarks concerning Synthetic D-Volemitol . . . . .	32
8. Remarks concerning the Names "Volemose" and "Volemulose" . . . . .	32
9. A Simple Proof of Configurations in the Glucose and Galactose Series . . . . .	33

XV. Data for the Identification of Various Higher-carbon Alcohols of the Sugar Group . . . . .	34
--	----

## INTRODUCTION

Demonstrations of the chemist's art in changing one sugar to another never fail to excite wonder, even among the initiated. Starting with either of the two most abundant carbohydrates in nature, starch or cellulose, he makes D-glucose by the very old and simple process of acid hydrolysis. From this D-glucose he can make today in the laboratory by other processes in yields that are actually practical, D-mannose (epimerization through the glycol), D-fructose (alkaline enolization), D-altrose (Walden inversions), D-arabinose and L-xylose (oxidative degradations) and D-ribose. In addition, a considerable number of sugars can be made from the sugars of the list by a process which is the subject of this review, namely, Emil Fischer's cyanohydrin synthesis of higher-carbon sugars. The importance of this synthesis in the historical development of the theoretical chemistry of the carbohydrates places it in the first rank of that field; the major role that its experimental results have played in the establishment of the van't Hoff-Le Bel theory of the asymmetric carbon atom extends its significance far beyond the carbohydrate group.

## I. THE CYANOHYDRINS AND THE CORRESPONDING ACIDS AND LACTONES

The synthesis of  $\alpha$ -hydroxy acids from carbonyl compounds by way of the cyanohydrin was an early discovery in organic chemistry.<sup>1</sup> In 1867 Simpson and Gautier,<sup>2</sup> working in Wurtz' laboratory, described the cyanohydrin from acetaldehyde and hydrocyanic acid, and its conversion to racemic lactic acid by strong hydrochloric acid.



<sup>1</sup> Mandelic acid from benzaldehyde cyanohydrin: F. W. Winckler, *Ann.*, **4**, 246 (1832); **18**, 310 and 319 (remarks by J. Liebig) (1836).

<sup>2</sup> M. Simpson and A. Gautier, *Compt. rend.*, **65**, 414 (1867); J. Wislicenus had accomplished the synthesis from acetaldehyde, hydrocyanic acid and hydrochloric acid without isolating the cyanohydrin, *Ann.*, **128**, 22 (1863).

The analogous reaction with a ketone is illustrated from the work of Staedeler<sup>3</sup> in 1859, who prepared  $\alpha$ -hydroxy-isobutyric acid from acetone, hydrocyanic acid and hydrochloric acid, without isolating the intermediate acetone cyanohydrin.

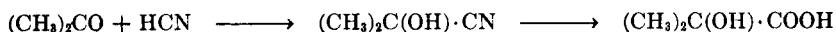

In a series of researches Kiliani<sup>4</sup> succeeded in applying this cyanohydrin reaction to reducing sugars; the resulting polyhydroxy acids, which contained one more carbon atom than the sugar from which each was derived, were then reduced by hydriodic acid and phosphorus to homologs of acetic acid, which were accurately identified. The results of this pioneering work are summarized below, using the names that were current then and appending the present ones.

#### Summary of Kiliani's Cyanohydrin Results

Arabinose [L-Arabinose]	→	Arabinosecarboxylic acid [L-Mannonic acid]	→	normal hexylic acid
Dextrose [D-Glucose]	→	Dextrosecarboxylic acid [D-Gluco-D-gulo-heptonic acid] <sup>6</sup>	→	normal heptylic acid
Galactose [D-Galactose]	→	Galactosecarboxylic acid [D-Gala-L-manno-heptonic acid]	→	normal heptylic acid
Levulose [D-Fructose]	→	Levulosecarboxylic acid [Full configuration unknown]	→	methyl-n-butyl-acetic acid

Kiliani accomplished the purpose of his plan of research; he established the aldopentose structure for arabinose and proved that glucose and galactose are aldohexoses and fructose a 2-keto-hexose. His discovery that these polyhydroxy acids lose water readily and pass to stable lactones of crystalline habit soon became of great significance.

## II. EMIL FISCHER'S DISCOVERY AND APPLICATION OF THE SYNTHESIS

In 1889 Fischer<sup>6</sup> discovered that the lactones of the acids of the sugar group can be reduced by sodium amalgam to yield the corresponding carbonyl compound, an aldose. The addition of this reaction to the cyanohydrin procedure of Kiliani made possible the first synthesis of

<sup>3</sup> Staedeler, *Ann.*, 111, 320 (1859) and W. Markownikoff, *ibid.*, 146, 339 (1868).

<sup>4</sup> H. Kiliani, (a) (fructose) *Ber.*, 18, 3066 (1885); 19, 221, 772 (1886); (b) (glucose) *ibid.*, 19, 767, 1128; (c) (arabinose) *ibid.*, 19, 3029 (1886); 20, 282, 339 (1887); (d) (galactose) *ibid.*, 21, 915 (1888); 22, 521 (1889).

<sup>6</sup> It is recommended that the reader refer at this point to p. 28, where this nomenclature is explained.

<sup>6</sup> E. Fischer, *Ber.*, 22, 2204 (1889). ["Untersuchungen über Kohlenhydrate und Fermente," vol. 1, p. 315. Verlag Julius Springer, Berlin (1909).]



higher-carbon sugars. Apparently the extent to which the sugar chain might be lengthened by successive applications of this synthesis would be limited only by experimental factors such as yield and crystallization of products. In the same year Fischer and Passmore<sup>7</sup> discovered that the phenylhydrazides of the aldonic acids crystallize well, a development which proved of fundamental importance for the isolation and purification of such acids. At that time Fischer was beginning to use the van't Hoff-Le Bel theory of the asymmetric carbon atom in the interpretation of experimental results, and in 1891, in the introduction to his classical proof of the configuration of glucose and related substances, he stated: "all previous observations in the sugar group are in such complete agreement with the theory of the asymmetric carbon atom that the use of this theory as a basis for the classification of these substances seems justifiable."<sup>8</sup> The theory predicts that two diastereoisomers should result from the addition of hydrocyanic acid to a reducing sugar; Fischer found that such is the case. Arabinose yielded in addition to Kiliani's arabinosecarboxylic acid [L-mannonic acid] also some L-gluconic acid, the isolation of which was accomplished through its phenylhydrazide.<sup>9</sup> From D-xylose there were prepared the new synthetic diastereoisomeric hexoses D-gulose<sup>10</sup> and D-idose.<sup>11</sup> In the continuation, such diastereoisomers will be designated "epimers," following usual practice. When two acids are found to result from the application of the cyanohydrin synthesis to a sugar it is naturally assumed that they are epimers. Fischer<sup>8</sup> established several methods for proving the relationship: (1) the acids are interconvertible through heating with aqueous pyridine; (2) the epimeric aldoses which result from the reduction of the lactones of the epimeric acids yield one and the same osazone; (3) each epimeric aldose reduces to a polyhydroxy alcohol, both of which alcohols are obtained in mixture when the related 2-ketose is reduced. This ketose can be recognized also through the observation that it yields the same osazone.

Using the van't Hoff-Le Bel theory as a guide, Fischer extended his cyanohydrin syntheses from the work with xylose and arabinose to researches on all the other aldoses that were available in quantity at that time; the list consisted of glucose, mannose, galactose, rhamnose, lactose and maltose. The experimental results with the disaccharides

<sup>7</sup> E. Fischer and F. Passmore, *Ber.*, **22**, 2728 (1889). ["Untersuchungen," p. 222.]

<sup>8</sup> E. Fischer, *Ber.*, **24**, 1836, 2683 (1891). ["Untersuchungen," pp. 417, 427.]  
The writer has reviewed the subject in the *Journal of Chemical Education*, **18**, 353 (1941).

<sup>9</sup> E. Fischer, *Ber.*, **23**, 2611 (1890). ["Untersuchungen," p. 362.]

<sup>10</sup> E. Fischer and R. Stahel, *Ber.*, **24**, 528 (1891). ["Untersuchungen," p. 389.]

<sup>11</sup> E. Fischer and I. W. Fay, *Ber.*, **28**, 1975 (1895). ["Untersuchungen," p. 526.]

were meager, due to the failure of the synthetic substances to crystallize.<sup>12</sup> The monoses led to brilliant developments.

### 1. Higher-carbon Sugars from D-Mannose

From D-mannose there was synthesized<sup>13</sup> one mannoheptose [it is D-manno-D-gala-heptose], the cyanide addition seeming to proceed so much in one direction that the epimer was not detected; the reduction of this mannoheptose gave an alcohol which proved to be identical with natural perseitol. Continuing the synthesis from the mannoheptose a mannooctose [it is D-manno-L-manno-octose], and from the latter a mannononose, were prepared. It was reported at that time that this mannononose was fermented readily by yeast; subsequently Fischer<sup>14</sup> mentioned that a research which Dr. Hagenbach had carried out under his direction confirmed the data concerning mannooctose but led to different results in the nonose series, in consequence of which he expected to study the subject again in order to determine the reason for the difference. As there is no later statement, it seems probable that Fischer's extensive activities in other lines of research left no opportunity for the resumption. Hermann O. L. Fischer has preserved most of his father's records, among which he has found Dr. Hagenbach's notebook, and he has kindly loaned it to the writer for study. With Dr. Fischer's permission the following data from the notebook are published in the belief that they can be helpful to future investigators.

*Data from R. Hagenbach's Research on D-Mannononose under the Direction of Emil Fischer.* The mannooctonic lactone of Fischer and Passmore was obtained again (m. p. 165–170°,  $[\alpha]_{D^{20}} -42^\circ$  in water, m. p. of the phenylhydrazide of the acid, 252°, the corresponding values from the older work being 167–170°,  $-44^\circ$  and 243°). The reduction of this lactone yielded an amorphous octose which formed a crystalline phenylhydrazone of low solubility, that appeared to be identical (m. p. 218–220°) with Fischer and Passmore's phenylhydrazone (212°). The two researches appear to be in agreement so far. In Hagenbach's first trial of the addition of hydrocyanic acid to his octose, he used 15 g. of octose that had been made from its phenylhydrazone by the usual benzaldehyde process. At room temperature the precipitation of amide began after three hours. The usual treatment with barium hydroxide was made eight days later. A nononic acid was isolated as a readily crystallizing phenylhydrazide, which began to appear even in the hot solution. The yield was small, about 5 g., m. p. 249°. This phenylhydrazide was converted to a lactone in the usual way (barium hydroxide) and crystallization took place on the water bath when high concentration was

<sup>12</sup> O. Reinbrecht, *Ann.*, **272**, 197 (1892). [“Untersuchungen,” p. 661.]

<sup>13</sup> E. Fischer and F. Passmore, *Ber.*, **23**, 2226 (1890). [“Untersuchungen,” p. 569.]

<sup>14</sup> E. Fischer, “Untersuchungen,” p. 582.

reached. The crystals were washed with alcohol and showed m. p. 178°, yield 2.8 g. They were recrystallized from 200 cc. 95% alcohol, as small needles, m. p. 177–178° and  $[\alpha]_D^{20} +42^\circ$ . The m. p. and magnitude of rotation agreed with the data of Fischer and Passmore (175–177°,  $-41^\circ$ ), but the direction of rotation was opposite. After two more recrystallizations this sample melted at 185°, but there is no record of a rotation; Hagenbach thought it probable that this lactone sample was an impure preparation of the higher melting lactone that was obtained in all later experiments. This first sample of lactone was reduced with sodium amalgam to an amorphous sugar not free of ash, which rotated  $[\alpha]_D -10.9^\circ$  (i.e. levorotatory) and was not fermented by yeast at 26° during 24 hours. The yeast fermented both glucose and galactose vigorously. In all later syntheses from the octose, a nononic lactone of much higher m. p. was obtained as needle crystals. It is much less soluble (12 parts of hot water) than the mannoheptonic and mannooctonic lactones and it forms a barium salt of low solubility; it is recrystallized best from solution in hot alcohol, in which it is difficultly soluble, and subsequent concentration. The best product showed  $[\alpha]_D +60^\circ$  (dextrorotation), m. p. 199.5° corr., and the carbon and hydrogen analyses were correct for a nononic lactone. The phenylhydrazide from it showed correct percentages of carbon, hydrogen and nitrogen, m. p. 254°, and was difficultly soluble in hot water, from which it crystallized as "mikroskopische Krystalle sechsseitig, fast rund." Twelve separate syntheses from the octose were made, varying the temperature (12° to 35°) and the concentration of hydrocyanic acid; the lower temperatures gave better yields and cleaner products. In total, 60 g. of octose was used, from which 40.9 g. of nononic phenylhydrazide was obtained; the lactone from every experiment except the first, always melted with decomposition at some point between 192° and 202°; the rotations of two samples are recorded ( $[\alpha]_D +55^\circ$  and  $+57^\circ$ , once recrystallized material). The reduction of this high melting lactone yielded an amorphous mannononose. It rotated  $[\alpha]_D^{20} -35^\circ$  (levorotatory) and it was not fermentable by yeast. It formed a phenylhydrazone which was only slightly soluble in water, m. p. 209° corr. (dec.); carbon, hydrogen and nitrogen percentages were correct. The nonose which Fischer and Passmore described formed a phenylhydrazone (m. p. 195–200° uncorr. (dec.)) of low solubility in water, but their nonose was a crystalline sugar, could be recrystallized from hot 96% alcohol (m. p. about 130°), showed an initial rotation  $[\alpha]_D$  about  $+50^\circ$  (mutarotation not recorded), and it was readily fermentable by yeast. There is no record of a nonose osazone in Hagenbach's notebook.

The writer makes the following comments. The mannooctonic lactone that Fischer, Passmore and Hagenbach had in hand was certainly *D*-manno-*L*-manno-octonic lactone; it was later made by Peirce (ref. 23, p. 8) and also by workers in the writer's laboratory in connection with the research of ref. 55 (p. 18). Our data, not published before, are m. p. 169–172°, and  $[\alpha]_D^{20}$  in water  $-44.8^\circ$  (initial) which did not change in 24 hours. The absence of any rapid mutarotation suggests that it is a  $\gamma$ -lactone. The phenylhydrazide of the acid showed m. p. 257°; it is so slightly soluble in cold water that its rotation could not be measured. Concerning the substances of the mannonononic series, if the same nononic phenylhydrazide was obtained in the two researches, the lactone from it may have crystallized in the earlier research as a levorotatory  $\delta$ -lactone and in the later as a dextrorotatory  $\gamma$ -lactone, or mixture of the two. Since the nononic acid probably has the *L*-galactonic acid end

configuration (see p. 31), the recorded signs of rotation seem probable because the  $\gamma$ -lactone of D-galactonic acid is levorotatory and the tetramethyl- $\delta$ -D-galactonolactone is dextrorotatory.<sup>15</sup> The recognition that aldonic acids can form two lactones, which are interconvertible, came first from Nef's<sup>16</sup> work in 1914; there is no date in Hagenbach's notebook, but Fischer states that Hagenbach's work was done "several years ago" and Fischer's book was published in 1909. Attractive as this view concerning a possible  $\gamma$ - and  $\delta$ -lactone may seem, it does not appear possible to reconcile it with the clear evidence that distinctly different nonoses were obtained in the two researches by the reduction of the respective lactones. No statement regarding a mutarotation of either lactone has been found. The identity and configuration of Fischer and Passmore's mannonose, the fermentability of which by yeast is of great biochemical interest, remain unknown.

### 2. Higher-carbon Sugars from Rhamnose

The addition of hydrocyanic acid to natural rhamnose<sup>17</sup> led to the isolation of two epimeric acids, which Fischer designated as  $\alpha$ - and  $\beta$ -rhamnohexonic acids. The oxidation of the  $\alpha$ -acid by nitric acid was found to produce mucic acid, a discovery which led to the establishment of the configuration of galactose and disclosed (except for carbon atom 5 of rhamnose) those of the methylpentose and its  $\alpha$ - and  $\beta$ -hexonic acids. The  $\alpha$ -acid was obtainable in good yield; from it was prepared a crystalline rhamnohexose, which led to an amorphous rhamnoheptose and a rhamno-octonic acid. The  $\beta$ -rhamnohexonic lactone was reduced to an amorphous sugar which gave the same phenylosazone as  $\alpha$ -rhamnohexose, proving the epimeric relationship. (The full formulas follow on p. 20; see also p. 28.)

### 3. Higher-carbon Sugars from D-Glucose

In this series<sup>18</sup> the crystalline  $\alpha$ -glucoheptose and amorphous  $\beta$ -glucoheptose were synthesized and their configurations established; the  $\alpha$ -heptose on reduction passed to an alcohol of meso configuration and the two heptoses gave the same osazone. Isbell<sup>19</sup> has succeeded in crystallizing  $\beta$ -glucoheptose in recent years. Continuing with the  $\alpha$ -glucoheptose, a glucooctose (crystalline) and from the latter a glucononose

<sup>15</sup> J. Pryde, *J. Chem. Soc.*, 1808 (1923); W. N. Haworth, D. A. Ruell and G. C. Westgarth, *ibid.*, 2468 (1924); H. D. K. Drew, E. H. Goodyear and W. N. Haworth, *ibid.*, 1237 (1927).

<sup>16</sup> J. U. Nef, *Ann.*, 403, 306 (1914).

<sup>17</sup> E. Fischer and O. Piloty, *Ber.*, 23, 3102 (1890); E. Fischer and R. S. Morrell, *Ber.*, 27, 382 (1894). ["Untersuchungen," pp. 584, 503.]

<sup>18</sup> E. Fischer, *Ann.*, 270, 64 (1892). ["Untersuchungen," p. 593.]

<sup>19</sup> H. S. Isbell, *J. Am. Chem. Soc.*, 56, 2789 (1934).

(amorphous), were synthesized. The extension of Fischer's work in the glucose series that was published nineteen years later by L.-H. Philippe is reviewed later (pp. 17 and 31).

#### 4. Higher-carbon Sugars from D-Galactose

Here the synthesis<sup>20</sup> led to an  $\alpha$ -galaheptose (amorphous) and from it a galaoctose (crystalline) was prepared. Many years later the  $\alpha$ -galaheptose was crystallized.<sup>21</sup> The  $\beta$ -galaheptose crystallized in Fischer's research, and the epimeric character of the two galaheptoses was made highly probable by his interconversion of their aldonic acids on heating with aqueous pyridine.

### III. THE CONFIGURATIONS OF THE D-MANNOHEPTOSES AND THE D-GALAHEPTOSES

Looking backward from the vantage ground of present knowledge it is clear that Fischer's recorded experimental data<sup>22</sup> would have justified a conclusion that his synthetic perseitol ("D-mannoheptitol") is the enantiomorph of his " $\alpha$ -galaheptitol" and that his "L-mannoheptitol" is indeed identical with " $\alpha$ -galaheptitol." The relationship was expressed by Peirce,<sup>23</sup> who inferred it from Fischer's data and confirmed it by further tests. He discovered the D- $\beta$ -mannoheptonic acid, isolating it through its phenylhydrazone, and reduced its lactone to crystalline D- $\beta$ -mannoheptose, from which he obtained crystalline D- $\beta$ -mannoheptitol. He oxidized Fischer's D- $\alpha$ -mannooctonic acid to a dibasic acid, for which no rotation could be detected; he concluded that it is probably a meso form, in which case the mannooctose would be D-manno-L-manno-octose, a conclusion that has been established subsequently (see p. 18, ref. 55). In the D-galactose series he described the crystalline D- $\beta$ -galaheptitol, which he prepared by the reduction of Fischer's D- $\beta$ -galaheptose. As will be apparent from the continuation, the results of this research by Peirce have proved of great importance to later workers; an example is the fact that his D- $\beta$ -mannoheptitol *was found later to be identical with natural volemitol* (see ref. 38, p. 12). It is a source of deep regret to all who knew Dr. George Peirce that his untimely death in 1919 in an

<sup>20</sup> E. Fischer, *Ann.*, **288**, 139 (1895). ["Untersuchungen," p. 626.]

<sup>21</sup> R. M. Hann, A. T. Merrill and C. S. Hudson, *J. Am. Chem. Soc.*, **56**, 1644 (1934); **57**, 2100 (1935). The galaoctose is believed to be D-gala-L-gala-octose (W. D. Maclay, R. M. Hann and C. S. Hudson, *J. Am. Chem. Soc.*, **60**, 1035 (1938)).

<sup>22</sup> Refs. 13 and 20; W. S. Smith, *Ann.*, **272**, 182 (1892). ["Untersuchungen," pp. 569, 626, 641.]

<sup>23</sup> G. Peirce, *J. Biol. Chem.*, **23**, 327 (1915).

accident ended his brilliant service to science.<sup>24</sup> With the publication of Peirce's article there were established the configurations of the two mannoheptoses and the two galaheptoses, to be added to those of the two glucoheptoses, which Fischer had determined. All the sugars and alcohols of the following list are now known in crystalline condition.

*List of Configurations and Systematic Names for the Aldoheptoses and Heptitols from D-Glucose, D-Mannose and D-Galactose*

"D- $\alpha$ -Glucoheptose"	HOH <sub>2</sub> C ·	H H OH H H C · C · C · C · C · C · CHO OH OH H OH OH	D-Gluco-D- <i>gulo</i> -heptose
" $\alpha$ -Glucoheptitol"	HOH <sub>2</sub> C ·	H H OH H H C · C · C · C · C · C · CH <sub>2</sub> OH OH OH H OH OH	( <i>meso</i> ) Gluco- <i>gulo</i> -heptitol
"D- $\beta$ -Glucoheptose"	HOH <sub>2</sub> C ·	H H OH H OH C · C · C · C · C · C · CHO OH OH H OH H	D-Gluco-D- <i>ido</i> -heptose
"D- $\beta$ -Glucoheptitol" (see p. 17)	HOH <sub>2</sub> C ·	H H OH H OH C · C · C · C · C · C · CH <sub>2</sub> OH OH OH H OH H	D-Gluco-D- <i>ido</i> -heptitol
"D- $\alpha$ -Mannoheptose"	HOH <sub>2</sub> C ·	H H OH OH H C · C · C · C · C · C · CHO OH OH H H OH	D-Manno-D- <i>gala</i> -heptose
"D- $\alpha$ -Mannoheptitol"	HOH <sub>2</sub> C ·	H H OH OH H C · C · C · C · C · C · CH <sub>2</sub> OH OH OH H H OH	D-Manno-D- <i>gala</i> -heptitol (D-Perseitol, see p. 8)
"D- $\beta$ -Mannoheptose"	HOH <sub>2</sub> C ·	H H OH OH OH C · C · C · C · C · C · CHO OH OH H H H	D-Manno-D- <i>talo</i> -heptose
"D- $\beta$ -Mannoheptitol"	HOH <sub>2</sub> C ·	H H OH OH OH C · C · C · C · C · C · CH <sub>2</sub> OH OH OH H H H	D-Manno-D- <i>talo</i> -heptitol (D-Volemitol, see p. 8, ref. 23)
"D- $\alpha$ -Galaheptose"	HOH <sub>2</sub> C ·	H OH OH H H C · C · C · C · C · C · CHO OH H H OH OH	D-Gala-L- <i>manno</i> -heptose
"D- $\alpha$ -Galaheptitol"	HOH <sub>2</sub> C ·	H OH OH H H C · C · C · C · C · C · CH <sub>2</sub> OH OH H H OH OH	D-Gala-L- <i>manno</i> -heptitol (L-Perseitol)
"D- $\beta$ -Galaheptose"	HOH <sub>2</sub> C ·	H OH OH H OH C · C · C · C · C · C · CHO OH H H OH H	D-Gala-L- <i>gluco</i> -heptose
"D- $\beta$ -Galaheptitol"	HOH <sub>2</sub> C ·	H OH OH H OH C · C · C · C · C · C · CH <sub>2</sub> OH OH H H OH H	D-Gala-L- <i>gluco</i> -heptitol

<sup>24</sup> A biographical record of Dr. Peirce was published in "The Colgate Clock," vol. 2, no. 3 (March 1919) by Colgate and Company; he was a member of its scientific staff from 1916 to the time of his death.

## IV. THE SYNTHESIS OF ALTROSE AND ALLOSE FROM RIBOSE

Fischer epimerized *L*-arabonic acid to *L*-ribonic acid<sup>25</sup> by his pyridine method and reduced *L*-ribonic lactone with sodium amalgam to the first synthetic pentose, *L*-ribose (amorphous). The reduction of the *L*-ribose yielded a crystalline alcohol<sup>26</sup> which proved to be identical with natural adonitol from *Adonis vernalis* L. When Levene and Jacobs<sup>27</sup> discovered *D*-ribose in nature as a constituent of nucleic acids they applied the cyanohydrin synthesis to 50 g. of the pure crystalline *D*-ribose<sup>28</sup> and discovered the hexoses *D*-allose and *D*-altrose. The amorphous sugars were recognized as epimers through conversion to their common phenyl-osazone, and the configuration of *D*-altrose was established by the oxidation of *D*-altronic acid to *D*-talomucic acid. Both hexoses have been crystallized subsequently.<sup>29</sup> The availability of *D*-altrose at the present time, either from *D*-glucose<sup>30</sup> or the *D*-galacturonic acid<sup>31</sup> of pectin, makes the synthesis of higher carbon sugars from it a practicable undertaking. The established configurations in the ribose series are the following:

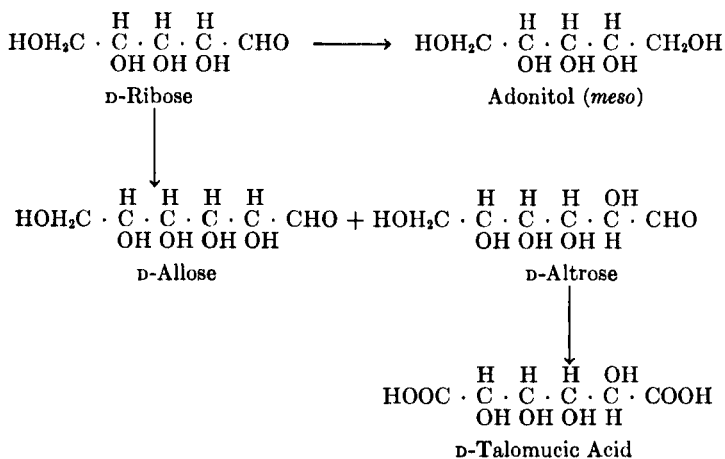

<sup>25</sup> E. Fischer and O. Piloty, *Ber.*, **24**, 4214 (1891). ["Untersuchungen," p. 440.]

<sup>26</sup> E. Fischer, *Ber.*, **26**, 633 (1893). ["Untersuchungen," p. 496.]

<sup>27</sup> P. A. Levene and W. A. Jacobs, *Ber.*, **42**, 2474, 3247 (1909); **43**, 3141 (1910).

<sup>28</sup> *L*-Ribose was crystallized by W. Alberda van Ekenstein and J. J. Blanksma, *Chem. Weekblad*, **6**, 373 (1909); **10**, 213, 664 (1913).

<sup>29</sup> F. P. Phelps and F. J. Bates, *J. Am. Chem. Soc.*, **56**, 1250 (1934) (*D*-allose); W. C. Austin and F. L. Humoller, *ibid.*, **55**, 2167 (1933), **56**, 1153 (1934) (*L*-allose and *L*-altrose); N. K. Richtmyer and C. S. Hudson, *ibid.*, **57**, 1716 (1935) (*D*-altrose).

<sup>30</sup> N. K. Richtmyer and C. S. Hudson, *J. Am. Chem. Soc.*, **65**, 740 (1943).

<sup>31</sup> P. P. Regna and B. P. Caldwell, *J. Am. Chem. Soc.*, **66**, 244 (1944).

## V. THE SYNTHESIS OF THE D-GULOHEPTOSES

The synthesis of D-gulose and D-idose from natural D-xylose by Fischer has been mentioned (p. 4). In 1920 La Forge<sup>32</sup> made the epimeric heptoses from D-gulose and reduced them to their alcohols, in connection with his studies on the structure of sedoheptulose. His D- $\alpha$ -guloheptose crystallized and the alcohol from it proved to be identical with Peirce's D- $\beta$ -galaheptitol (D-gala-L-*gluco*-heptitol), a fact which established the configuration of the heptose as that of D-gulo-L-*gala*-heptose. The D- $\beta$ -guloheptose did not crystallize but the reduction of its sirup yielded crystalline D- $\beta$ -guloheptitol. Conclusive proof that the two guloheptoses are epimers comes from Ettel's recognition (p. 12, ref. 38) that L- $\beta$ -guloheptitol and D-manno-D-*talo*-heptitol are jointly produced by the reduction of a ketose (sedoheptulose). Isbell<sup>33</sup> subsequently crystallized La Forge's D- $\beta$ -guloheptose. The configurations in the D-guloheptose series are the following:

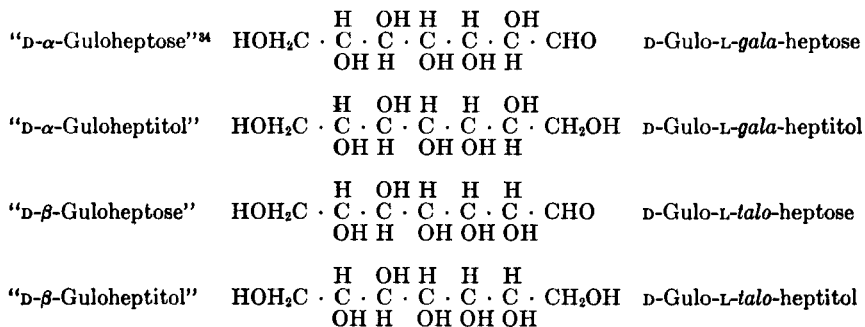

The D-gulo-L-*talo*-heptitol was reported by La Forge to melt at 128–129° and to show no rotation in borax solution. Recently it was prepared again (R. M. Hann, A. T. Merrill and C. S. Hudson, *unpublished data*), starting from the carefully purified D-gulo-L-*talo*-heptonic phenylhydrazide, proceeding through the lactone, which was reduced with sodium amalgam to the sirupy sugar, and reducing the sugar with hydrogen and Raney nickel to yield the crystalline heptitol. This alcohol was recrystallized from 35 parts of 95 per cent alcohol to constant melting point (128–129°); its rotation was  $[\alpha]_{D}^{20} = +0.95^{\circ}$  (*c*, 4.5) in water, and  $-4.6^{\circ}$  in saturated borax solution.

<sup>32</sup> F. B. La Forge, *J. Biol. Chem.*, **41**, 251 (1920).

<sup>33</sup> H. S. Isbell, *J. Research Natl. Bur. Standards*, **19**, 639 (1937).

<sup>34</sup> La Forge's  $\alpha$  and  $\beta$  names. In reading Isbell's articles one should bear in mind that he reverses La Forge's symbols.



It will be noticed that the future application of the Fischer cyanohydrin synthesis to D-altrose should lead to two heptitols, one of which (D-altro-D-*gluco*-heptitol) should be the enantiomorph of the known D-gulo-L-*talo*-heptitol, while the other (D-altro-D-*manno*-heptitol) should be identical with natural volemitol (D-manno-D-*talo*-heptitol, see p. 9).

## VI. MANNOHEPTULOSE, SEDOHEPTULOSE, PERSEULOSE, PERSEITOL AND VOLEMITOL

The discovery by La Forge<sup>36</sup> that a seven-carbon ketose exists in the free state in the fruit of the avocado tree (*Persea gratissima* Gaert.) opened a new vista in plant biochemistry. The configuration of this beautifully crystalline sugar was readily determined; its reduction by sodium amalgam yielded two heptitols, which were found to be D-manno-D-*gala*-heptitol (natural perseitol) and D-manno-D-*talo*-heptitol, the properties and configurations of both of which had been established by the earlier researches of Fischer<sup>13</sup> and of Peirce.<sup>23</sup> The ketoheptose is D-manno-D-*tagato*-heptose<sup>36</sup> (*syn.* D-mannoketoheptose, D-mannoheptulose).

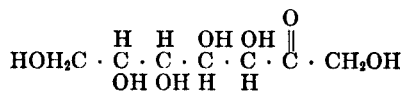

D-Manno-D-*tagato*-heptose (D-Mannoheptulose)

The ketose has been synthesized<sup>36a</sup> from D-manno-D-*gala*-heptose by the Lobry de Bruyn enolization reaction. The presence of both perseitol and the ketoheptose in the avocado fruit in the free state, and the absence of any fermentable sugar, seem to indicate that the carbohydrate metabolism of this tree is of a type not recognized previously.

A second ketoheptose was found<sup>37</sup> soon thereafter; it occurs in the free state in the herbaceous perennial *Sedum spectabile* Bor. and it was named sedoheptose, which later became sedoheptulose. Its reduction by sodium amalgam yielded two crystalline heptitols, the identification of which was finally established by Ettel,<sup>38</sup> after one of them had been found<sup>39</sup> to

<sup>36</sup> F. B. La Forge, *J. Biol. Chem.*, **28**, 511 (1917).

<sup>36</sup> This name, which has not been used before, follows the practice recently suggested by M. L. Wolfrom (*J. Am. Chem. Soc.*, **65**, 1021 (1943)) for higher-carbon 2-ketoses.

<sup>36a</sup> Edna M. Montgomery and C. S. Hudson, *J. Am. Chem. Soc.*, **61**, 1654 (1939).

<sup>37</sup> F. B. La Forge and C. S. Hudson, *J. Biol. Chem.*, **30**, 61 (1917).

<sup>38</sup> V. Ettel, *Collection Czechoslov. Chem. Commun.*, **4**, 504, 513 (1932).

<sup>39</sup> F. B. La Forge, *J. Biol. Chem.*, **42**, 375 (1920); F. B. La Forge and C. S. Hudson, *ibid.*, **79**, 1 (1928).

be identical with natural volemitol, of configuration then unknown.<sup>40</sup> Ettel proved that volemitol is Peirce's D-manno-D-*talo*-heptitol (pp. 8 and 9), and that the other alcohol is the enantiomorph of La Forge's D-gulo-L-*talo*-heptitol (p. 11) and must therefore be L-gulo-D-*talo*-heptitol. The configuration of sedoheptulose thus became established; the sugar is D-altroheptulose, or, following Wolfrom's practice,<sup>38</sup> D-altro-D-*fructo*-heptose. The oxidative degradation of sedoheptulose leads to D-altronic

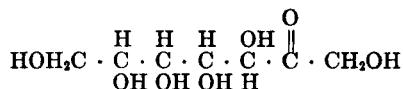

D-Altro-D-*fructo*-heptose (Sedoheptulose, D-Altroheptulose)

acid,<sup>41</sup> which confirms Ettel's formula. The synthesis and also the crystallization of sedoheptulose remain to be accomplished; fortunately the sugar is readily recognizable through the benzylidene derivative of its remarkable anhydride.<sup>41a</sup> Bertrand<sup>42</sup> oxidized D-manno-D-*talo*-heptitol (natural volemitol) by the action of *Bacterium xylinum* and obtained a solution of ketose which was not crystallized or identified; the ketose, which he named "volemulose," may have been D-mannoheptulose or sedoheptulose or a mixture of the two, since Bertrand's rule<sup>43</sup> for the action of this organism indicates the possibility of production of both ketoses. Later researches led to derivatives by which each of these sugars is readily identifiable.<sup>35,37</sup> Sedoheptulose and its relatives of the altriose group are reviewed by N. K. Richtmyer in another article of this volume (p. 37).

Perseulose has not been detected in any plant, but the fact that it is produced<sup>44</sup> in the laboratory by the action of oxidative microorganisms on natural perseitol may be regarded as placing it in the class of natural

<sup>40</sup> Volemitol was discovered by E. Bourquelot (*Bull. soc. mycologique France*, **5**, 132-163 (1889); *J. pharm. chim.*, [6] **2**, 385 (1895)) in a rather rare species of mushroom, *Lactarius volemus* Fr.; it was shown to be a heptitol by E. Fischer (p. 32, reference 89); J. Bougault and G. Allard (*Compt. rend.*, **135**, 796 (1902); *Bull. soc. chim.*, [3] **29**, 129 (1903)) found it in the roots of *Primula officinalis* Jacq., *elatior* Jacq., and *grandiflora* Lmk.; its occurrence in *Lactarius volemus* was confirmed by V. Ettel (*Coll. Czechoslovak Chem. Commun.*, **1**, 288 (1929)). Concerning the curious history of volemitol heptaacetate, see W. D. Maclay, R. M. Hann and C. S. Hudson, *J. Org. Chem.*, **9**, 293 (1944).

<sup>41</sup> N. K. Richtmyer, R. M. Hann and C. S. Hudson, *J. Am. Chem. Soc.*, **61**, 343 (1939).

<sup>41a</sup> C. S. Hudson, *J. Am. Chem. Soc.*, **60**, 1241 (1938).

<sup>42</sup> G. Bertrand, *Bull. soc. chim.*, [3], **19**, 348 (1898).

<sup>43</sup> G. Bertrand, *Compt. rend.*, **126**, 762 (1898).

<sup>44</sup> G. Bertrand, *Bull. soc. chim.*, [4], **5**, 629 (1909); Evelyn B. Tilden, *J. Bact.*, **37**, 629 (1939).

products. Its reduction yields two heptitols, one of which is perseitol<sup>45</sup> (D-manno-D-gala-heptitol); the other one was eventually proved<sup>46</sup> to be L-gala-D-gluco-heptitol, the enantiomorph of Peirce's D-gala-L-gluco-heptitol, and the configuration of perseulose that is disclosed by these results was confirmed by its oxidative degradation to L-galactonic acid.<sup>47</sup> Perseulose is L-gala-D-fructo-heptose, and it is to be designated therefore

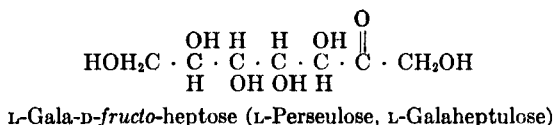

L-perseulose. The enantiomorph D-perseulose has been synthesized recently by Wolfrom, Brown and Evans (p. 12, ref. 36) from D-galactonyl chloride pentaacetate by Wolfrom's new method of higher-carbon ketose synthesis.

#### VII. THE D-PERSEITOL AND D-MANNITOL GROUPS OF NATURAL CARBOHYDRATES

Present knowledge of the heptoses and the heptitols that have been found in nature, including perseulose for the reason already stated, brings out several striking facts: (1) the sugars and the alcohols occur as free substances in the cell fluids of the plants, which suggests that they play a prominent role in the continuous active metabolism; (2) fermentable sugars are absent from the tissues in which sedoheptulose, mannoheptulose and perseitol occur (pertinent data regarding volemitol are not yet known), which suggests that the heptose metabolism is the chief carbohydrate metabolism in such tissues; (3) the chemical configurations of the naturally occurring members of this heptose group are closely related. Let us examine this last statement in detail, but first let the selection of the D-symbol for natural perseitol be explained.

Perseitol is one of the few polyhydroxy alcohols which, like sorbitol, can be designated either D- or L-, depending upon the arbitrary selection of one of the two aldoses from which it can be derived by reduction. Historically, the reduction of D-glucose to yield natural sorbitol is older than its synthesis by the reduction of L-gulose, and it seems advisable to the writer to use the historical order as the criterion in such cases, thus naming the natural hexitol D-sorbitol, which is in fact the generally accepted designation, first used by Fischer. The similarity of the names sorbitol and sorbose has given rise in

<sup>45</sup> G. Bertrand, *Compt. rend.*, **149**, 225 (1909).

<sup>46</sup> R. M. Hann and C. S. Hudson, *J. Am. Chem. Soc.*, **61**, 336 (1939).

<sup>47</sup> N. K. Richtmyer, R. M. Hann and C. S. Hudson, *J. Am. Chem. Soc.*, **61**, 340 (1939).

some quarters to the idea that natural sorbitol should be designated L-sorbitol because it is now known to be one of the reduction products from L-sorbose. The history of the subject does not support this view. The first reduction of a sugar to natural sorbitol was that of D-glucose by Meunier in 1890.<sup>48</sup> Sorbose was discovered in the fermented and bacterially oxidized juice of the berries of the mountain ash (*Sorbus aucuparia* L.) in 1852 by Pelouze; sorbitol was discovered in the fresh juice by Boussingault in 1872; both substances were named from *Sorbus*, no chemical relationship between them being involved. Sorbitol was not named from sorbose, nor sorbose from sorbitol. Natural perseitol is to be named D-perseitol because it was first synthesized through the reduction of D-manno-D-gala-heptose by Fischer.<sup>13</sup> D-Perseitol would surely result also from the reduction of L-gala-D-manno-heptose, which has not been carried out. In describing the transformation of D-perseitol to L-perseulose by oxidation, the idea that the change of symbol indicates some sort of Walden inversion is a superficial view; the change from D- to L- is solely a convention of nomenclature and it is a logical and necessary one. Natural volemitol must be designated D-volemitol since the aldoheptose from which it was obtained by reduction (Peirce<sup>23</sup>), D-manno-D-talo-heptose, and the other (now unknown) from which it can doubtless be produced, D-altro-D-manno-heptose, are both of the D-series.

Inspecting the formula for natural D-perseitol, one notices that oxida-

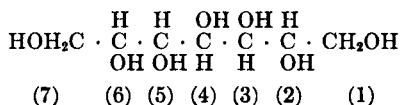

tion at carbon atom 2 leads to natural D-mannoheptulose, while oxidation at 6 leads to natural L-perseulose. Reduction of D-mannoheptulose leads back to D-perseitol and also to natural D-volemitol (formula on p. 9). The oxidation of D-volemitol at 2 leads back to D-mannoheptulose, but the oxidation of it at 6 leads to natural D-sedoheptulose. The reduction of L-perseulose leads back to D-perseitol and also to L-gulo-D-gala-heptitol. The oxidation of the latter at 2 leads to L-guloheptulose (an unknown ketose), and oxidation at 6 leads to L-perseulose. Ettel<sup>49</sup> showed some years ago by a diagram the closed character of the perseitol group. Such penultimate oxidations and reductions are commonly observed in the action of microorganisms. The joint occurrence of D-perseitol and D-mannoheptulose in the fruit of the avocado suggests the presence of an oxidation-reduction enzyme system. Such a type of system, restricted to  $\alpha$ -keto oxidations-reductions, could therefore account for the interconversions of the known ketoses and alcohols of this natural group of seven-carbon carbohydrates, a group which may be named after the oldest member as *the perseitol group of carbohydrates*. The

<sup>48</sup> J. Meunier, *Compt. rend.*, 111, 49 (1890); see also C. Vincent and Delachanal, *ibid.*, 111, 51 (1890).

<sup>49</sup> V. Ettel, *Collection Czechoslov. Chem. Commun.*, 4, 519 (1932).

facts and inferences which lead to this view have fairly close parallels in the case of a group of naturally occurring six-carbon sugars and alcohols. The oxidation of D-mannitol at either the 2 or 5 position leads solely to D-fructose, while the reduction of this ketose leads back to D-mannitol and also to D-sorbitol. The penultimate oxidation of D-sorbitol which certain bacteria accomplish leads to the ketose L-sorbose (the other penultimate oxidation would lead to D-fructose), and the reduction of L-sorbose leads to D-sorbitol and L-iditol, both of which occur in the fresh juice of the fruit of *Sorbus aucuparia* L.<sup>50</sup> This group of six-carbon ketoses and alcohols may be named after its oldest member as *the mannitol group of carbohydrates*. In terms of chemical configuration the members of the six-carbon group have as a common element the arrangement

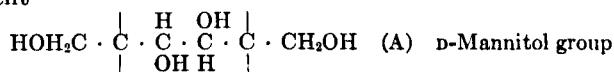

and for the seven-carbon group there applies the arrangement

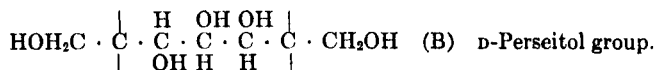

The foregoing classification of these carbohydrates to make the mannitol and the perseitol groups is essentially an assembling of facts. Starting from the idea that these groups have a biological basis one can draw some deductions and inferences which seem to deserve notice.

(1) The common structural elements (A) and (B) are not identical with their mirror-images. This corresponds with the observation that the enantiomorphous forms of the sugars and alcohols of the two groups have not been found in nature. Even if some such forms should be detected later, the conclusion that the structural elements (A) and (B) are the overwhelmingly preferred ones would not be changed. It is correct and more definite, therefore, to name the two sets of natural carbohydrates *the D-mannitol and D-perseitol groups*.

(2) The element (A) possesses a special symmetry which is absent from (B); turning (A) through 180° in the plane of the paper does not change it, but this is not true for (B). From (A) the configurations of D-fructose, L-sorbose, D-mannitol, D-sorbitol and L-iditol exhaust the possibilities; these five substances have been found in natural products but not their enantiomorphs. From (B) the configurations of four alcohols in total may be derived, which are D-perseitol, D-volemitol, L-gulo-D-gala-heptitol and L-gulo-D-talo-heptitol; the first two have been

<sup>50</sup> G. Bertrand, *Bull. soc. chim.*, [3], 33, 166 (1905); G. Bertrand and A. Lanzenberg, *ibid.*, [3], 35, 1073 (1906).

found in nature but not their enantiomorphs; no occurrence of the last two is now known. From (B) the configurations of four ketoses in total may be derived, which are D-manno-D-tagato-heptose (*syn.* D-manno-heptulose), D-altro-D-fructo-heptose (*syn.* D-sedoheptulose), L-gala-D-fructo-heptose (*syn.* L-perseulose) and L-gulo-D-tagato-heptose; the first three of these are classed as natural products but not their enantiomorphs; no occurrence of the last one is now known. The enantiomorph of the last substance would be expected by Bertrand's rule<sup>43</sup> as the oxidation product of the known D-gulo-L-talo-heptitol by *Bacterium xylinum*; a knowledge of the properties of its enantiomorph might lead to its detection in nature. According to a recently noticed rule<sup>51</sup> for the action of *Acetobacter suboxydans*, this organism would not be expected to act on D-gulo-L-talo-heptitol.

(3) One observes that there is no aldose now known in the D-perseitol natural group, whereas of the four aldoses that are possible from the element (A) of the D-mannitol group, namely D-glucose, D-mannose, L-gulose and L-idose, the first two are abundant in nature, and their enantiomorphs are either absent or of very minor occurrence.<sup>52</sup> Neither gulose nor idose have been found in nature. The phosphorylation of D-fructose, D-glucose and D-mannose in metabolic processes is a reaction which results in their easy interconversions; the absence so far of aldoses in the D-perseitol group is suggestive that the question of the metabolic phosphorylation of its ketoses deserves investigation. D-Mannoheptulose is utilized by the rabbit but apparently not by the rat.<sup>53</sup>

#### VIII. D-( $\alpha,\alpha,\alpha,\alpha$ )-GLUCODECOSE AND THE EPIMERIC D-GLUCODECONIC LACTONES

In a research lasting three years Philippe<sup>54</sup> repeated Fischer's syntheses in the glucose series, confirmed the data, supplemented them at several points, and continued the synthesis from Fischer's D-glucononose to produce two D-glucodeconic lactones, one of which he reduced to a crystalline D-glucodecose. He reduced the amorphous D- $\beta$ -glucoheptose of Fischer and discovered the corresponding crystalline D- $\beta$ -glucoheptitol (D-gluco-D-ido-heptitol, see p. 9). In naming the numerous substances, Philippe extended Fischer's empirical names of  $\alpha$ - and  $\beta$ -glucoheptose so

<sup>41</sup> R. M. Hann, Evelyn B. Tilden and C. S. Hudson, *J. Am. Chem. Soc.*, **60**, 1201 (1938).

<sup>52</sup> See footnote 4 of an article by N. K. Richtmyer and C. S. Hudson (*J. Am. Chem. Soc.*, **64**, 1609 (1942)) for references to several reported occurrences of L-glucose in nature; the evidence does not appear to be conclusive.

<sup>53</sup> J. H. Roe and C. S. Hudson, *J. Biol. Chem.*, **112**, 443 (1936); **121**, 37 (1937).

<sup>54</sup> L.-H. Philippe, *Ann. chim. phys.*, [8], **26**, 289-418 (1912).

that the genetic relationships of the octoses, nonoses and decoses are readily apparent; the forerunners of Philippe's D- $\alpha,\alpha,\alpha,\alpha$ -glucodecose are thus the  $\alpha$ -heptose, the  $\alpha,\alpha$ -octose and the  $\alpha,\alpha,\alpha$ -nonose. The  $\alpha$  name was given to that member of each epimeric pair which was obtained in the larger yield (p. 296 of ref. 54). The  $[\alpha]_D$  values for the epimeric gluco-deconic lactones were found to be  $-40^\circ$  for the D- $\alpha,\alpha,\alpha,\alpha$ -glucodeconic lactone and  $-35^\circ$  for the D- $\alpha,\alpha,\alpha,\beta$ -glucodeconic lactone, data which will be referred to later (p. 20). The crystalline D- $\alpha,\alpha,\alpha,\alpha$ -glucodecose showed an initial  $[\alpha]_D$  value of about  $+37^\circ$ , and the equilibrium value of  $+50^\circ$ .

#### IX. EARLY INDICATIONS OF CONFIGURATIONS BY THE LACTONE RULE OF ROTATION

In applying the theory of the asymmetric carbon atom to carbohydrate configurations Fischer made use of two mathematical theorems from it, namely, (1) a meso configuration is devoid of optical rotation because of internal compensation (e.g. xylitol and *xylo*-trihydroxyglutaric acid), and (2) in the case of some configurations two different aldoses can yield on reduction one and the same active alcohol (e.g. D-sorbitol comes from D-glucose and also from L-gulose). He used both of these theorems in his proof of the configuration of D-glucose, the first theorem in his proof of the configuration of D-gluco-D-gulo-heptose and the partial configuration of  $\alpha$ -rhamnohexose, and Peirce used the second theorem in his proof of the configurations of the mannoheptoses and galaheptoses. The first theorem was applied by Peirce to the limited data available concerning Fischer and Passmore's D-mannooctose, and his conclusion was established with certainty later<sup>55</sup>; the alcohol from this octose is of meso configuration and hence the sugar and alcohol have the formulas:

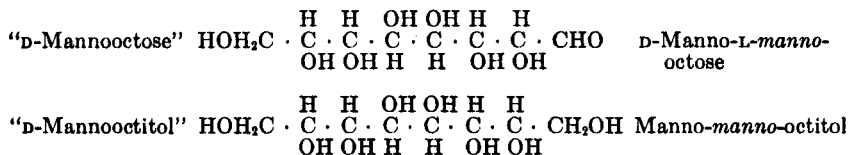

The full configurations of the other synthetic octoses, nonoses and Philippe's decose remained unknown because these aldoses led to no meso alcohols and none of their alcohols was obtained from two aldoses. If both epimers from each cyanohydrin synthesis in the glucose, mannose and galactose series had been obtainable readily, most configurations in

<sup>55</sup> R. M. Hann, W. D. Maclay, A. E. Knauf and C. S. Hudson, *J. Am. Chem. Soc.*, 61, 1268 (1939).

these series could have been established through the methods then in vogue; but the synthesis usually produced one isomer in large preponderance, which made only one course of further synthesis practicable.

### 1. *Rhamnose, Fucose and the "Rhamnohexoses"*

The discovery of empirical rules of rotation of derivatives of the aldonic acids which indicated the configuration of the  $\gamma$ -, and later the  $\alpha$ -carbon atoms, made possible an advance in the solution of the problem of establishing the configurations of the synthetic higher-carbon sugars and the naturally-occurring rhamnose and fucose. The lactone rule<sup>56</sup> was the earliest of these generalizations; it was inferred from very extensive data.

In 1911 E. Anderson<sup>57</sup> sought to select configurations of the synthetic sugars from the signs and approximate magnitudes of their equilibrium rotations. At that time the assumptions in his plan were broad because the rotations depended upon the proportions of isomeric forms of a sugar in equilibrium and upon the assumed similarity of higher-carbon sugars to hexoses. Only in much later years has it been possible to test these assumptions through extensive experimental data. It is now known that Anderson's predictions have proved correct in the cases where later researches have established the configurations, and the equilibrium rotations have now become valuable indications of configuration (see p. 26).

The first new result from the application of the lactone rule was the assignment of a complete configurational formula to natural rhamnose. The configuration of carbon atom 5 was indicated by the sign of rotation of the rhamnotetronic lactone,<sup>58</sup> and therefore the Fischer formula could now be made complete; it became

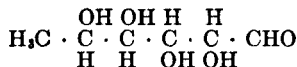

and natural rhamnose was very probably 6-desoxy-L-mannose. This configuration from the empirical lactone rule was verified through a conclusive proof two years later by Fischer and Zach.<sup>59</sup> It thus became

<sup>56</sup> C. S. Hudson, *J. Am. Chem. Soc.*, (a) **32**, 338 (1910); (b) **33**, 405 (1911); (c) **39**, 462 note 3 (1917); (d) **61**, 1525 (1939).

<sup>57</sup> E. Anderson, *J. Am. Chem. Soc.*, **33**, 1510 (1911).

<sup>58</sup> O. Ruff and H. Kohn, *Ber.*, **35**, 2362 (1902); C. S. Hudson and L. H. Chernoff, *J. Am. Chem. Soc.*, **40**, 1005 (1918). Concerning the analogous application of the lactone rule to indicate the configuration of fucose, see the second article of ref. 56 and E. P. Clark, *J. Biol. Chem.*, **54**, 65 (1922); the indicated configuration was established by K. Freudenberg and K. Raschig, *Ber.*, **60**, 1633 (1927).

<sup>59</sup> E. Fischer and K. Zach, *Ber.*, **45**, 3761 (1912). ["Untersuchungen. II (1922)," p. 374.]



possible to assign established full configurations to the "rhamnohexoses" of Fischer (p. 7).

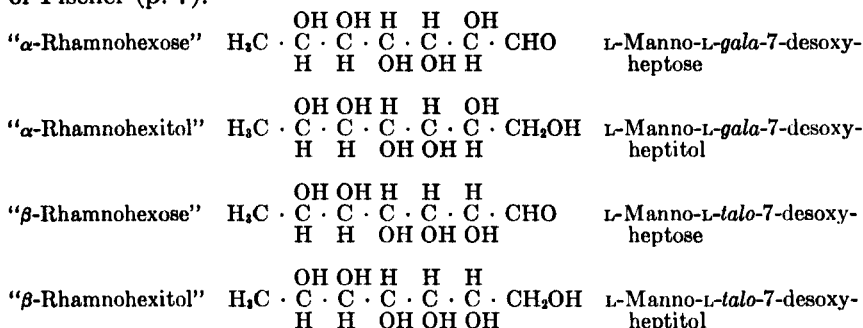

The sign of rotation of Fischer and Passmore's mannononic lactone ( $-41^\circ$ ) does not agree with the lactone rule, as the writer pointed out,<sup>56c</sup> but he called attention to Fischer's statement concerning Hagenbach's failure to obtain this lactone. Recently Elsner<sup>60</sup> has stated that this lactone is an exception to the lactone rule; it can now be stated that the rotation of the mannononic lactone which Hagenbach (p. 6) obtained ( $+60^\circ$ ) agrees with the lactone rule. One should not conclude that Fischer and Passmore made an error in the sign of their lactone; they and Hagenbach unquestionably had different lactones in hand, as is proved by the widely different melting points and solubilities of the substances (p. 6) and their reduction to different nonoses.

## 2. "D-Glucooctose"

Both the D-( $\alpha, \alpha, \alpha, \alpha$ )- and D-( $\alpha, \alpha, \alpha, \beta$ )-glucodeconic lactones of Philippe were strongly levorotatory (see p. 18); since their  $\gamma$ -carbon atom is the carbon atom 2 of the antecedent D- $\alpha$ -glucooctose the levorotations indicated that the full configurations of this octose and its octitol are the following:

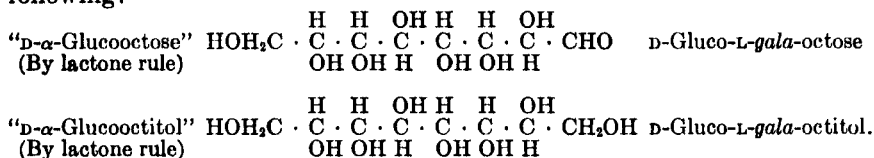

It then became probable<sup>56c</sup> that the "D- $\alpha$ -glucooctitol," which Fischer had discovered, should be obtainable from the reduction of one of the unknown D-galaoctoses that should be expected from Fischer's "D- $\beta$ -galaoctose," the configuration of which heptose had been established by Peirce

<sup>60</sup> Tollens-Elsner's "Kurzes Handbuch der Kohlenhydrate." J. A. Barth, Leipzig, 1935, p. 80.

(pp. 8 and 9). Unfortunately, the yield of this "D- $\beta$ -galaheptose" was low, the cyanohydrin syntheses of Fischer and Peirce having yielded principally its epimer, and in consequence no octose had been made from it. Its production in fair quantity was kept in view, but many years elapsed before the appropriate syntheses were performed.<sup>61</sup>

#### X. THE CONFIGURATIONS OF CERTAIN GLUCOOCTOSES AND GALAECTOSES

The phenylhydrazide and the amide rules<sup>62</sup> of rotation indicated<sup>63</sup> the same configuration for Fischer's D- $\alpha$ -glucooctose that had been disclosed by the lactone rule, and in confirmation they also indicated the epimeric configuration for the accompanying product of the cyanohydrin synthesis. When the benzimidazole rule of rotation was discovered recently<sup>64</sup> it was found that its indication of configuration for D- $\alpha$ -glucooctose agreed with the previous ones; thus the agreement of four empirical rules made this configuration almost certain. At this stage we undertook the appropriate synthesis in the D- $\beta$ -galaheptose [D-gala-L-*gluco*-heptose] series, the main result of which will now be described.<sup>65</sup>

Fischer's D- $\alpha$ -glucooctitol, which is Philippe's D- $\alpha$ , $\alpha$ -glucooctitol, lies in the main path of his syntheses in the glucose series and is obtainable readily. It crystallizes from aqueous alcohol with great ease as prisms, and the pure substance shows m. p. 153–154° and  $[\alpha]_D + 2.4^\circ$  in water. The pure octaacetate from it shows m. p. 88–89° and  $[\alpha]_D + 20.7^\circ$  in chloroform. It was thus seen that the substance is easily identifiable. The melting point that is recorded by Fischer (141°) is low; Philippe reported 156–158°; both of them reduced the octose by sodium amalgam, a process which often leads to the presence of a trace of the octitol from the epimeric aldose through enolization in alkaline solution. It is our experience that the reduction by means of hydrogen and Raney nickel in water produces the desired alcohol in almost pure condition and the yield is practically quantitative. In the D-galactose series two octonic acids were produced from D-gala-L-*gluco*-heptose; the opposed signs of rotation of their phenylhydrazides indicated that the acid which was more accessible was the one which we desired; the signs of rotation of its

<sup>61</sup> The cyanohydrin syntheses of higher-carbon sugars that were made in the writer's laboratory in earlier years were a part of the program for training chemists in the technique of general sugar researches; consequently they were pursued only intermittently in that period. During the past ten years it has been possible to give special attention to them, largely through the able assistance of Dr. Raymond M. Hann.

<sup>62</sup> P. A. Levene, *J. Biol. Chem.*, **23**, 145 (1915); C. S. Hudson, *J. Am. Chem. Soc.*, **39**, 462 (1917); **40**, 813 (1918).

<sup>63</sup> R. C. Hockett and C. S. Hudson, *J. Am. Chem. Soc.*, **60**, 622 (1938).

<sup>64</sup> N. K. Richtmyer and C. S. Hudson, *J. Am. Chem. Soc.*, **64**, 1612 (1942).

<sup>65</sup> R. M. Hann, Alice T. Merrill and C. S. Hudson, *J. Am. Chem. Soc.*, **66**, 1912 (1944).

amide and benzimidazole confirmed this indication. The reduction of the pure crystalline lactone of this acid by sodium amalgam yielded a crystalline D-galaoctose, and the reduction of the pure sugar by hydrogen and Raney nickel in water led to a D-galaoctitol which is identical with D- $\alpha$ -glucooctitol; it shows the same crystalline form, melting point and rotation, and its octaacetate showed m. p. 88-89° and  $[\alpha]_D + 20.5^\circ$  in chloroform. Mixed melting points confirmed the identity. This result establishes the configurations of two of the glucooctoses and two of the galaoctoses by Fischer's conclusive method. The work illustrates

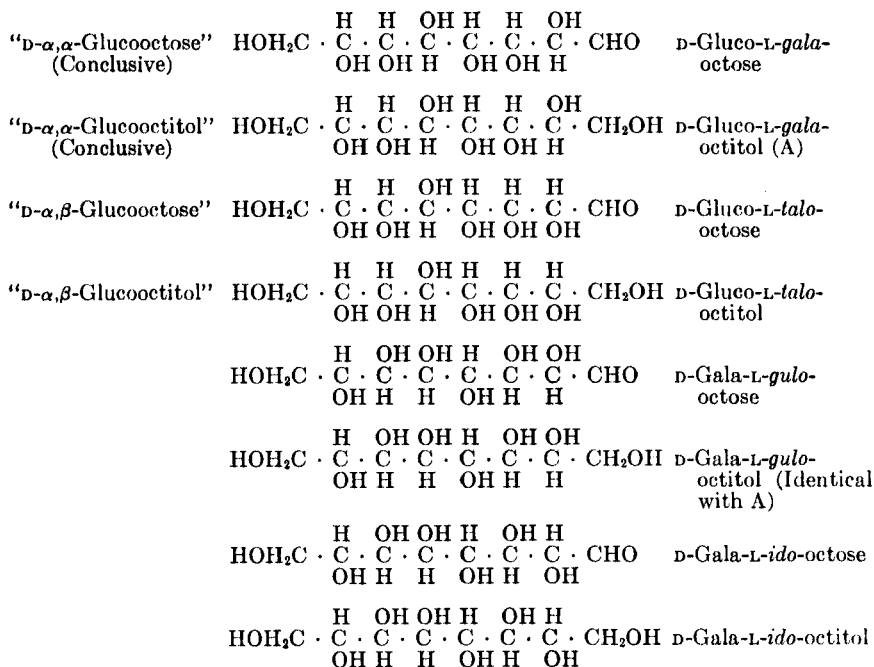

how the application of the empirical rules of rotation can act as a guide in enabling the investigator to choose the path that leads to a final proof by one of Fischer's conclusive methods.

## XI. IMPROVEMENTS IN THE DETAILS OF THE FISCHER CYANOHYDRIN SYNTHESIS OF HIGHER-CARBON SUGARS AND IN THE IDENTIFICATION OF THE PRODUCTS

### 1. The Conversion of Aldonic Phenylhydrazides to Lactones

The conversion of aldonic phenylhydrazides to acids was carried out in the earlier researches by boiling with solutions of barium hydroxide.

Some phenylhydrazides are very resistant and there is decomposition and possibly some epimerization in the alkaline solutions on long boiling. It has been found that boiling with a solution of copper sulfate is an advantageous procedure.<sup>66</sup> The following directions for preparing mannonic lactone from mannonic phenylhydrazide illustrate the method.

One hundred grams of pure mannonic phenylhydrazide, 80 g. of copper sulfate pentahydrate, one liter of water and 1 cc. of octyl alcohol (to control foaming) were boiled for five hours under reflux. The solution was cleared of copper as sulfide, of sulfuric acid as barium sulfate, and upon concentration to 75 cc. the lactone crystallized readily. Successive crops were obtained by concentration and treatment of the sirups with methyl alcohol. The total yield of pure lactone was 55.8 g. (90%). During the reaction there is a vigorous evolution of nitrogen and in the condenser droplets of benzene appear.

## 2. The Use of Calcium or Barium Salts with Sodium Cyanide

It is often convenient to use a mixture of calcium chloride (or a barium salt) and sodium cyanide for preparing the next higher aldonic acid from a sugar<sup>67</sup>; the preparation of *D*-gluco-*D*-gulo-heptonic lactone from *D*-glucose by this method can be used in even elementary instruction without danger.

Five liters of a filtered aqueous solution containing 200 g. of anhydrous calcium chloride (3.6 equivalents) and 163 g. of sodium cyanide (3.3 moles) was used to dissolve 540 g. of anhydrous glucose (3.0 moles). The temperature of the solution rose from 20 to 33° within an hour and after two hours 94% of the theoretical amount of ammonia could be expelled from a sample by distillation. Thus the formation of the glucoheptonic nitriles and their hydrolysis to calcium  $\alpha$ - and  $\beta$ -glucoheptonates and ammonia are quite rapid. The reaction was complete within twenty-two hours at ordinary temperature. Calcium hydroxide (222 g., 3 moles) was then dissolved in the solution and in a short while the basic calcium salts of the two glucoheptonic acids precipitated and were filtered off, washed with cold lime water until the filtrate showed only a faint chloride test, and decomposed with oxalic or sulfuric acid in the usual way. By concentrating the solution a yield of 42% of  $\alpha$ -glucoheptonic lactone was crystallized, and a yield of 11% of the crystalline lactone of the  $\beta$ -acid was obtained from the residue through the brucine salt. By working up mother liquors these yields were increased to 58 and 21%, respectively. It seems to be generally the case that the basic calcium and barium salts of the monobasic sugar acids are only sparingly soluble. In the case of mannose, barium chloride was used in place of calcium chloride and the neutral barium salt of  $\alpha$ -manno-heptonic acid, which is of low solubility and crystallizes well, could be obtained directly from the reaction mixture.

<sup>66</sup> R. M. Hann and C. S. Hudson, *J. Am. Chem. Soc.*, **56**, 957 (1934).

<sup>67</sup> C. S. Hudson, Olive P. Hartley and C. B. Purves, *J. Am. Chem. Soc.*, **56**, 1248 (1934); E. L. Jackson and C. S. Hudson, *ibid.*, **56**, 2455 (1934); R. C. Hockett and C. S. Hudson, *ibid.*, **60**, 622 (1938).

The use of this procedure has led<sup>68</sup> to the crystallization of one of the two possible epimeric lactose carboxylic acids (*cf.* ref. 12, p. 5), which proved to be D-glucosyl-D-galactosyl-heptonic acid with the  $\beta$ -D-galactopyranosido attachment at its carbon atom 5. Attempts so far to lactonize this acid have failed.

### 3. *The Reduction of Sugars to Alcohols by Hydrogen and Raney Nickel*

The advantage of reducing the sugars to alcohols by using hydrogen and Raney nickel instead of sodium amalgam, has been mentioned. The high yield and purity of the product have caused these alcohols to supersede the corresponding dibasic acids in most of the later configurational studies. In the case of  $\omega$ -desoxy sugars, however, nitric acid oxidation to dibasic acids is obviously still requisite.

### 4. *The Use of Various Solvents*

The use of glacial acetic acid in the crystallization of sugars and their derivatives is often advantageous.<sup>69</sup> The modern industrial manufacture of pure methanol and *n*-propanol at low prices has led to their more general use as solvents in sugar researches, often with welcome results in separations and crystallizations; an example is their recent use in the preparation of crystalline mannose.<sup>70</sup> Dioxane is a solvent for many carbohydrates; crystalline gluconic acid is conveniently obtained by its use.<sup>71</sup> The writer has found ethylene glycol monomethyl ether ("methyl cellosolve") a convenient solvent for use in measuring the rotations and mutarotations of phenylosazones and for crystallizing sugars; ethyl lactate is superior to ethyl acetate for crystallizing some glycosides and it may be used also for crystallizing some sugars.

### 5. *Improvements in the Characterization of Osazones*

Fischer's discovery of the phenylosazones of the sugars, a sequel to his discovery of phenylhydrazine itself, led him to his famous carbohydrate researches. He recognized that some of these osazones are difficult to characterize with exactness; their melting points are really decomposition temperatures. The need for attainment of better precision in the identification of osazones has been a matter of concern in

<sup>68</sup> R. M. Hann and C. S. Hudson, *J. Am. Chem. Soc.*, **56**, 1390 (1934).

<sup>69</sup> Wernicke and Pftzinger, U. S. Pat. 260,340 (1882); C. S. Hudson and J. K. Dale, *J. Am. Chem. Soc.*, **39**, 322, Note 2 (1917); C. S. Hudson and H. L. Sawyer, *ibid.*, **39**, 471 (1917).

<sup>70</sup> H. S. Isbell, *J. Research Natl. Bur. Standards*, **26**, 47 (1941).

<sup>71</sup> H. S. Isbell and Harriet L. Frush, *J. Research Natl. Bur. Standards*, **11**, 649 (1933).

many researches; Levene and La Forge<sup>72</sup> utilized the mutarotations; Fischer's anhydride of phenyllactosazone<sup>73</sup> and acetates<sup>74</sup> of osazones also have been recommended. A recent article<sup>75</sup> brings to light a group of unusually stable crystalline derivatives of the osazones which can be prepared from many osazones in good yields by a simple process. They are the corresponding osotriazoles; thus the change with phenyl-D-glucosazone that is brought about by boiling the substance with an aqueous copper sulfate solution is

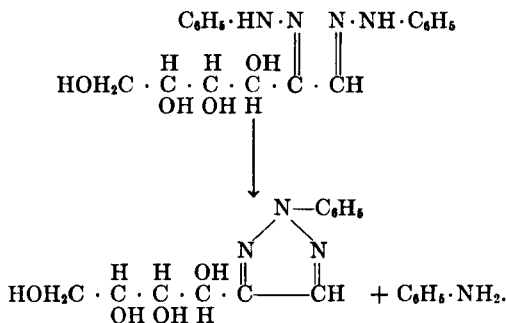

These sugar osotriazoles show sharp melting points and rotations (with no mutarotation) and give promise of aiding the precise characterization of osazones.

#### *Confirmatory Test for Phenyl-D-glucosazone*

A suspension of 0.2 g. powdered osazone in a solution composed of 18 cc. water, one cc. 0.5 N sulfuric acid, 0.6 g. copper sulfate pentahydrate and 12 cc. isopropyl alcohol, is refluxed for one hour, using a piece of porous plate to insure even boiling. The osazone dissolves within fifteen minutes and the solution shows a deep red color. During the next half hour the red fades to orange and finally to yellowish green. The solution is concentrated on the steam bath by an air current to about 5 cc.; crystallization of the osotriazole occurs during this operation and is increased by keeping the mixture three hours in the refrigerator. The tan colored precipitate is removed by filtration, washed with water, boiled with 30 cc. water and 0.1 g. decolorizing carbon, and the solution filtered while hot. On keeping the colorless filtrate cold overnight the long needle crystals of pure osotriazole separate; wt. 20-40 mg., m. p. 195-196° (with no decomposition); 18.3 mg. in 25 cc. pyridine solution rotated  $\alpha_D -0.23^\circ$  in a 4 dm. tube, the calculated value being  $-0.24^\circ$  from the  $[\alpha]_D^{20} -81.6^\circ$  value in pyridine for phenyl-D-glucosotriazole. Methyl alcohol

<sup>72</sup> P. A. Levene and F. B. La Forge, *J. Biol. Chem.*, **20**, 429 (1915).

<sup>73</sup> Edna M. Montgomery and C. S. Hudson, *J. Am. Chem. Soc.*, **52**, 2105 (1930). See also O. Diehls and R. Meyer, *Ann.*, **519**, 161 (1935), concerning the use of other osazone anhydrides.

<sup>74</sup> R. M. Hann and C. S. Hudson, *J. Am. Chem. Soc.*, **61**, 336 (1939).

<sup>75</sup> R. M. Hann and C. S. Hudson, *J. Am. Chem. Soc.*, **66**, 735 (1944).

may be substituted for isopropyl alcohol in these directions if the refluxing time is increased to two hours; yield, 56 mg., m. p. 195–196°, observed rotation for 50 mg. in 25 cc. pyridine solution, 4 dm. tube,  $-0.64^\circ$ , calculated  $-0.65^\circ$ . Obviously, the test would be applicable likewise to a small sample of phenyl-L-glucosazone, and dextrorotation would be observed for its osotriazole; any aid to the positive detection in nature of the L-forms of glucose, mannose or fructose seems worth mentioning because of the biological interest that is involved.

## XII. SIMILAR SUGARS

Fischer<sup>76</sup> noticed that the  $\alpha$ - and  $\beta$ -methyl xylosides and the methyl glucosides have similar rotations and he attributed this to the fact that the glucosides and xylosides have very similar configurations. The growth of this idea has been continuous with the ascertainment of further configurations in the sugar group. Many chemists have cited examples. Extensive data concerning substances of the mannose and  $\alpha$ -galaheptose [D-gala-L-manno-heptose] group led to the general conclusion<sup>77</sup> that "the physical and chemical properties (though not the biological<sup>78</sup>) of an aldose and most of its derivatives are conditioned in first measure by the space configurations of carbons one to five inclusive." This generalization is well founded and it has proved to be a very useful guide in the study of higher-carbon sugars. A good illustration can be taken from the higher-carbon sugars of the mannose series; mannonic acid is the favored epimer in the addition of hydrocyanic acid to arabinose, rather than the epimeric gluconic acid. The addition of hydrocyanic acid to mannose leads principally to the manno-gala-heptose rather than the epimeric manno-talo-heptose. The manno-gala-heptose yields mostly the manno-manno-octose rather than the manno-gluco-octose. An analogous relationship is found among the higher-carbon sugars of the galactose series; galactonic acid is favored over talonic acid in the addition of hydrocyanic acid to lyxose. Galactose yields gala-manno-heptose

<sup>76</sup> E. Fischer, *Ber.*, **28**, 1145 (1895). ["Untersuchungen," p. 746.]

<sup>77</sup> (a) R. M. Hann, Alice T. Merrill and C. S. Hudson, *J. Am. Chem. Soc.*, **57**, 2100 (1935); (b) C. S. Hudson, *ibid.*, **52**, 1695 (1930); R. M. Hann and C. S. Hudson, *ibid.*, **59**, 548 (1937); W. D. Maclay, R. M. Hann and C. S. Hudson, *ibid.*, **60**, 1035 (1938); (c) Edna M. Montgomery and C. S. Hudson, *ibid.*, **64**, 247 (1942). See also H. S. Isbell, *J. Research Natl. Bur. Standards*, **8**, 505 (1937). Some of the regularities that are noticeable in the cyanohydrin syntheses were pointed out by J. G. Maltby, *J. Chem. Soc.*, 1408 (1923); 1629 (1926); 2769 (1929).

<sup>78</sup> The statement does apply sometimes, however, in the borderland between reactions *in vivo* and *in vitro*; thus in studies of enzyme action, W. W. Pigman (*J. Am. Chem. Soc.*, **62**, 1371 (1940); *J. Research Natl. Bur. Standards*, **26**, 197 (1941)) has found that phenyl D-manno- $\beta$ -D-gala-heptoside is slowly hydrolyzed by the emulsin of sweet almonds, which also hydrolyzes phenyl  $\beta$ -D-galactoside. For literature references on the subject see an article by Mildred Adams, N. K. Richtmyer and C. S. Hudson, *J. Am. Chem. Soc.*, **65**, 1369 (1943).

principally and this passes largely to *gala-gala*-octose. One sees these regularities of preference in other series. Glucose yields *gluco-gulo*-heptose preferably to *gluco-ido*-heptose, *gluco-gulo*-heptose goes preferably to *gluco-gala*-octose and the indications (p. 29) lead to the belief that the preferred sugars from this octose are *gluco-manno*-nonose and *gluco-gala*-decese. Gulose is more accessible from xylose than is idose. Gulose leads largely to *gulo-gala*-heptose rather than to *gulo-talo*-heptose, and it may be predicted that the more accessible octose in this series (not yet prepared) will be *gulo-manno*-octose, and that this octose will form a phenylhydrazone of low solubility like mannose phenylhydrazone, and that the *gulo-manno*-octonic acid will form a phenylhydrazide of low solubility, leading to its easy isolation and purification. It is thus possible today to make important predictions concerning the behavior of an aldose during the cyanohydrin synthesis. Summarizing, the mannonic and galactonic configurations are highly preferred over those of their respective epimers, the gulonic configuration is somewhat more accessible than the idonic (as shown by the hydrocyanic acid addition to xylose, glucose, and *D-gala-L-gluco*-heptose), and in the allonic-altronic pair the data show about equal quantities of these epimers from ribose. More syntheses seem required before similar generalizations can be made in the series of higher-carbon sugars from allose and from talose; from present information solely, one would expect both to act like ribose. Presumably altrose will behave like arabinose and galactose, and idose will simulate xylose and glucose. It is evident that the correlation of configuration and properties applies not only to cyclic forms in the sugar group but also to many non-cyclic derivatives; the best example of this fact is the rule of rotation for the aldonic amides, which approaches a quantitative application. The existence of the crystalline cadmium bromide double salts of cadmium *D*-xylo-nate, cadmium *D*-idonate, cadmium 6-desoxy-*L*-idonate and cadmium *D*-gluco-*D-ido*-heptonate, respectively, is another example of a close correlation of physical and chemical properties with configuration.<sup>79</sup> The rotations of some derivatives of aldehydo forms of the aldoses also seem to exhibit correlations of rotation with configuration.<sup>80</sup> Correlations concerning peculiarities of mutarotation have often been noticed; a striking example is exhibited by  $\alpha$ -*D*-talose and *D*-gluco- $\alpha$ -*L*-talo-octose.<sup>81</sup>

<sup>79</sup> Edna M. Montgomery, N. K. Richtmyer and C. S. Hudson, *J. Am. Chem. Soc.*, **65**, 1852, note 17 (1943), data from work by Olive P. Hartley; T. Mueller and T. Reichstein, *Helv. Chim. Acta*, **21**, 253 (1938).

<sup>80</sup> M. L. Wolfrom and R. L. Brown, *J. Am. Chem. Soc.*, **65**, 951 (1943).

<sup>81</sup> H. S. Isbell and W. W. Pigman, *J. Research Natl. Bur. Standards*, **18**, 141 (1937); **19**, 189 (1937). Alice T. Merrill, R. M. Hann and C. S. Hudson, *J. Am. Chem. Soc.*, **65**, 994 (1943).



## XIII. NOMENCLATURE OF HIGHER-CARBON SUGARS FROM HEXOSES

Fischer's use of  $\alpha$  and  $\beta$  symbols in this group, and the extension of his plan by Philippe, were of course provisional. When the configurations of most of these synthetic aldoses became established later and it was found that each of them has properties closely resembling those of the hexose of like configuration for carbon atoms 1 to 5, it was shown that a system of nomenclature which is based upon these facts can be invented.<sup>82</sup> Taking " $\alpha$ -D-glucoheptose" as an example, it is derived from D-glucose and its carbon atoms 3,4,5,6 have in consequence the D-glucose configuration. Its carbon atoms 2,3,4,5 have the configuration of D-gulose, and its properties resemble those of this hexose; accordingly the name D-gluco-D-gulo-heptose seems appropriate, and it is unequivocal in designating the configuration. Some authors, who have adopted the plan in principle, have preferred D-glycero-D-gulo-heptose to the name that was suggested; the writer considered this alternative name in the original publication and rejected it for reasons which seem cogent, the strongest of which is the failure of the name to indicate emphatically the genetic relationship of the heptose to D-glucose. Dr. Pigman has made the suggestion, which the writer adopts, that the hexose syllable which refers to the carbon atoms nearer the carbonyl group be italicized.

## XIV. MISCELLANEOUS

1. "*Rhamnoheptose*" and "*Rhamnooctonic Acid*"

"*L-Rhamnoheptose*." Its configuration is known, except for its carbon atom 2, because of its synthesis from L-manno-L-gala-7-desoxy-heptose (p. 20). Fischer and Piloty<sup>17</sup> describe it as amorphous, of  $[\alpha]_D$  about  $+8.4^\circ$ , and its phenylhydrazone as of low solubility. Its preponderance in the synthesis, its rotation and the character of its phenylhydrazone lead to the surmise that it is of the D-mannose rather than the D-glucose type. It is therefore probably L-manno-D-manno-8-desoxy-octose, the configuration of which is

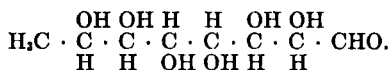

The reader will note that in the older literature rhamnose and fucose are classified as "methylpentoses"; preference is now given to their designation as desoxy-hexoses. The old name "rhamnoheptose" has thus become L-rhamnooctose and "rhamnooctonic" has become L-rhamnononic.

<sup>82</sup> C. S. Hudson, *J. Am. Chem. Soc.*, 60, 1537 (1938).

"*L-Rhamnooctonic Acid.*" The one "*L-rhamnooctonic acid*" which Fischer and Piloty made from the "*L-rhamnoheptose*" is probably the *L-manno-D-gala-9-desoxy-nononic acid*,

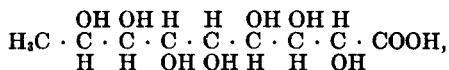

because its large preponderance in the synthesis, and the properties that they record for its lactone, amide and phenylhydrazone show that it resembles galactonic rather than talonic acid.

Both of the indicated configurations would become established if it should be found that the oxidation of "*L-rhamnooctonic acid*" by nitric acid yields a dibasic acid that is the enantiomorph of the one from the acid that is almost certainly *D-gala-L-gala-octonic acid*<sup>21</sup>; and such a result would also establish the configuration of the last named acid. Designating the dibasic acids of the sugar group by the suffix "aric," which Peirce<sup>23</sup> suggested, it seems probable therefore that the acid of the rhamnose series will be found to be *L-gala-D-gala-octaric acid*,

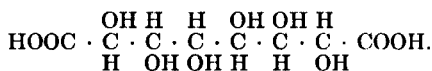

## 2. "*D-Glucononose*" and "*D-(\alpha,\alpha,\alpha)-Glucodecose*"

"*D-Glucononose*" (the *D-\alpha,\alpha,\alpha-Glucononose of Philippe*). The configuration of this amorphous sugar (p. 7) is now established, except for carbon atom 2, because it was made from *D-gluco-L-gala-octose*. Its preponderance in the synthesis, its weak dextrorotation and the low solubility of its crystalline phenylhydrazone indicate that it is like *D-mannose* rather than *D-glucose* and that therefore it is probably *D-gluco-D-manno-nonose*, of configuration

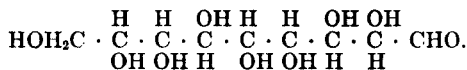

*Probable Configuration of Philippe's "D-\alpha,\alpha,\alpha-Glucodecose."* If the surmise of the configuration of *D-glucononose* from the preceding paragraph be correct, it becomes probable that the crystalline decose which Philippe obtained (p. 17) from this nonose is *D-gluco-D-gala-decose*,

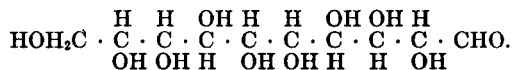

Its preponderance in the synthesis, high dextrorotation ( $[\alpha]_D + 50^\circ$ , equilibrium) and the low solubility of the phenylhydrazone of its aldonic acid are good signs that it resembles *D-galactose* rather than *D-talose*.

### 3. Fischer and Leuchs' Synthesis of Glucosamine

Some reference should be made in this review to Fischer and Leuchs'<sup>83</sup> synthesis of glucosamine from D-arabinose through the essential steps of the Fischer higher-carbon sugar process. However, the subject of the synthesis of amino sugars, which was later developed so extensively by P. A. Levene,<sup>84</sup> has been reviewed in his monograph.

### 4. Levene and Compton's 6-Desoxy-D-gulose

This sugar was made in crystalline form from 5-desoxy-D-xylose by way of Fischer's cyanohydrin synthesis.<sup>85</sup> The 5-desoxy-D-xylose was prepared through the following steps: Monoacetone-D-xylose → 5-tosyl-monoacetone-D-xylose → 5-iodo-monoacetone-D-xylose → 5-desoxy-D-xylose. An indication of the gulonic configuration was obtained through Levene's<sup>86</sup> empirical rule for the direction of shift of rotation of α-hydroxy acids on passing from the ionized state in their salts to the free acids, and also through the phenylhydrazide rule. Finally, this configuration was established by methylation, oxidation with nitric acid and the isolation of the crystalline dimethyl ester of *meso*-dimethoxy-succinic acid, a result which is compatible only with the gulonic configuration.

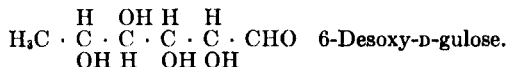

### 5. The "Fucohexonic Acids"

L-Fucose,<sup>88</sup> the configuration of which is

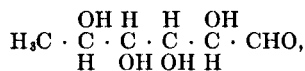

should yield by the Fischer cyanohydrin synthesis two heptonic acids, originally named "fucohexonic acids":

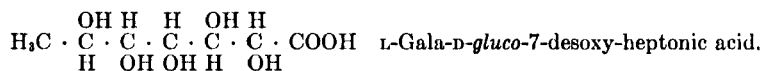
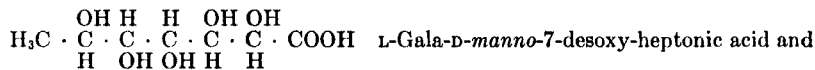

<sup>83</sup> E. Fischer and H. Leuchs, *Ber.*, **35**, 3787 (1902); **36**, 24 (1903).

<sup>84</sup> P. A. Levene, "Hexosamines and Mucoproteins," Longmans, Green and Co., 1925.

<sup>85</sup> P. A. Levene and J. Compton, *J. Biol. Chem.*, **111**, 325, 335 (1935); P. A. Levene and A. L. Raymond, *ibid.*, **102**, 317 (1933).

<sup>86</sup> P. A. Levene, *J. Biol. Chem.*, **23**, 145 (1915); P. A. Levene and G. M. Meyer, *ibid.*, **26**, 355 (1916).

Votoček<sup>87</sup> has prepared these acids and used the amide rule of rotation for identification of their respective configurations.

Referring to the observations of Krauz<sup>88</sup> in the D-fucose series, it is highly probable that the sugar of equilibrium rotation  $[\alpha]_D + 12^\circ$  has the configuration:

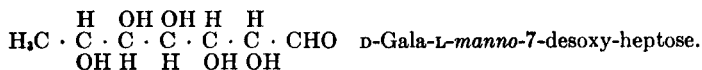

### 6. Remarks concerning Certain Nonitol Configurations

Reference has been made (p. 9) to the fact that D-manno-D-gala-heptitol (D-perseitol) and D-gala-L-manno-heptitol (L-perseitol) are enantiomorphs. They are the more accessible heptitols in each of these series and were prepared by Fischer. No mannooctitol configuration can be identical with any galaoctitol configuration. In the case of nonitols, one mannononitol solely (D-manno-L-gala-nonitol) can be identical with a galanonitol (D-gala-D-manno-nonitol), the configuration of this nonitol being

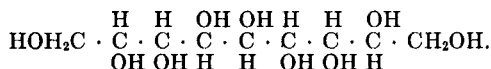

One observes that it lies in the more accessible course in both the D-mannose and D-galactose series; indeed, its parent octoses are known (D-manno-L-manno-octose and D-gala-L-gala-octose) and its preparation from the two series seems feasible.

D-Gluco-D-manno-nonitol, the configuration of which is

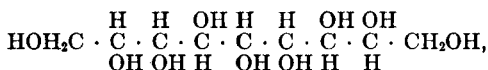

would be expected to lie in the more accessible course of the glucose series and therefore it may be the very crystalline alcohol of low solubility in water that both Fischer and Philippe described (m. p. 190–194°; 198°,  $[\alpha]_D = +1.5^\circ$ ); evidently their nonitol is readily identifiable. The configuration also lies in the D-mannose series (D-manno-L-gulo-nonitol); it is in the more accessible path in two of the three steps, and only the passage from the D-manno-D-gala-heptose to D-manno-L-gluco-octose might be expected to give a low yield.

<sup>87</sup> E. Votoček, *Collection Czechoslov. Chem. Commun.*, **6**, 528 (1934).

<sup>88</sup> C. Krauz, *Ber.*, **43**, 483 (1910).

### 7. Remarks concerning Synthetic D-Volemitol

It has been mentioned (p. 13) that D-manno-D-*talo*-heptitol is identical with natural volemitol. If one desires a supply of volemitol, probably the best procedure at the present time is its synthetic production from D-mannose; even though the D-manno-D-*talo*-heptose is the epimer of minor yield by the cyanohydrin addition, the synthetic method appears to be more practicable than the isolation of the alcohol in quantity from known natural sources. The use of barium cyanide or the equivalent mixture of a barium salt and sodium cyanide, in place of hydrocyanic acid appears<sup>77c</sup> to favor the yield of the desired heptonic acid. On the other hand, the possibility of starting with D-altrose, which is now no longer a particularly rare sugar, appears of interest because the desired heptose (D-*altro*-D-*manno*-heptose) should be the major product in that series if the generalizations that have been presented hold for altrose. This speculation has been offered because it seems to the writer that many carbohydrates that are now only laboratory curiosities, can be made at costs that are not prohibitive for the use of them in exploratory researches, especially in the bacteriological, physiological and biochemical fields.

### 8. Remarks concerning the Names "Volemose" and "Volemulose"

Fischer<sup>89</sup> oxidized volemitol, a sample of which had been sent by Bourquelot, with hypobromite and from the solution obtained a crystalline phenylosazone (m. p. 196° (dec.)), the analysis of which established its character as a phenylosazone of a *heptose* and proved that volemitol is a *heptitol*. He named it phenyl volemosazone as being the osazone from a hypothetical sugar "volemose," but it is clear that he understood the ambiguity of this name; it was he who had discovered that glucose, mannose and fructose yield one and the same osazone, and he discovered that hypobromite oxidation yields a mixture of aldoses and ketoses.<sup>90</sup> Subsequently many writers have assumed that "volemose" is as definite a name as glucose, mannose or fructose and have considered it as probably synonymous with sedoheptulose.<sup>91</sup> It is evident that Fischer's hypobromite oxidation of volemitol must be assumed to have produced two aldoses and two corresponding 2-ketoses, these pairs being D-manno-D-*talo*-heptose with D-mannoheptulose in one case and D-*altro*-D-*manno*-heptose with sedoheptulose in the other. The first pair would yield a

<sup>89</sup> E. Fischer, *Ber.*, 28, 1973 (1895). ["Untersuchungen," p. 653.]

<sup>90</sup> E. Fischer, *Ber.*, 27, 3189 (1894). ["Untersuchungen," p. 31.]

<sup>91</sup> V. Ettel, ref. 49; Tollens-Elsner's "Kurzes Handbuch der Kohlenhydrate" (1935), p. 405; Beilstein, 4th edition, vol. 31, part 1, p. 363 (1938).

single osazone, which is phenyl-D-mannoheptosazone (melting point, 200°), and from the second pair would come phenyl-D-althroheptosazone (melting point, 197°). The existing data do not distinguish which of these osazones is the phenyl-D-volemosazone, nor do they identify Bertrand's<sup>92</sup> phenyl volemulosazone (decomposition point, 205°). It seems to the writer that a repetition of Fischer's and Bertrand's oxidations of volemitol and an exact identification of the heptoses which yield the phenylosazones that come from the resulting solutions, is required before the names "volemose" and "volemulose" can be used without inherent ambiguity. Since Bertrand used the *Bacterium xylinum* for the oxidation of volemitol it is almost certain that "volemulose" is a 2-ketose but it could be either mannoheptulose or sedoheptulose (see p. 13) and his data do not lead to a distinction between them.

### 9. A Simple Proof of the Configurations in the Glucose and Galactose Series

Start with two facts, long known; dulcitol and gluco-gulo-heptitol are meso substances. Add to these the recently established fact that the optically active D-gluco-L-gala-octitol is the same substance as D-gala-L-gulo-octitol (p. 21, ref. 65). Write a skeleton formula for the octitol as shown in the accompanying sketch, and number above it the carbon atoms as in glucooctitol and below it as in gala-octitol. Mark the four CHOH carbon atoms of dulcitol as meso, likewise the five of the gluco-heptitol.

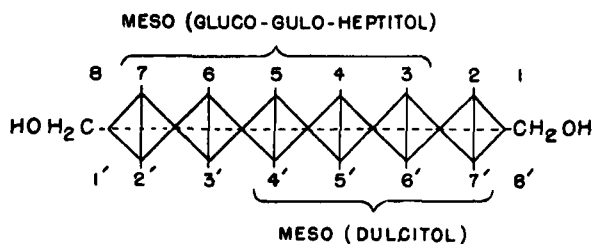

- Step 1. By Fischer's convention for D-glucose, OH is below C<sub>7</sub>.
- Step 2. By the heptitol meso relationship, OH must be below C<sub>3</sub>.
- Step 3. By the hexitol meso relationship, OH must be below C<sub>4</sub>.
- Step 4. By the heptitol meso relationship, OH must be below C<sub>6</sub>.
- Step 5. By the hexitol meso relationship, the OH's on C<sub>2</sub> and C<sub>5</sub> must be on one side.
- Step 6. The optical activity of the octitol requires that this side be the upper.

<sup>92</sup> See page 13 and reference 42.

The proof is now complete and the full configuration has become the one that is shown on p. 22 for this octitol. The configurations of *D*-glucose and natural galactose follow obviously, and it is seen that the symbol *D* is necessary for this form of galactose.

The configurations of most of the other monoses can be derived easily in sequence; thus the enantiomorphous relationship of *D*-manno-*D*-gala-heptitol (*D*-perseitol) and *D*-gala-*L*-manno-heptitol (*L*-perseitol) shows the configuration of *D*-mannose. The proof is presented as an exercise for students of stereochemistry *after* they have mastered the reasoning and the logic of Fischer's original proof, and appreciate its great historical importance as being the first proof that was possible from the facts that became known at the time, facts which resulted from his experimental researches.

#### XV. DATA FOR THE IDENTIFICATION OF VARIOUS HIGHER-CARBON ALCOHOLS OF THE SUGAR GROUP

Several years ago Dr. W. Dayton Maclay, Dr. Raymond M. Hann and the writer prepared authentic well-purified samples of many of the polyhydroxy alcohols and their fully acetylated derivatives; a summary of the data, and the recent results from the study of *D*-gala-*L*-gulo-octitol, are recorded in Table I. The alcohols were prepared by the reduction with hydrogen and Raney nickel of pure crystalline aldoses or the two ketoses *D*-manno-*D*-tagato-heptose and *L*-gala-*D*-fructo-heptose, except in the case of *D*-gluco-*D*-ido-heptitol; for it the pure crystalline lactone was reduced to the corresponding aldose by sodium amalgam, and the sirupy sugar was then reduced to the alcohol in the way indicated. Advantageous conditions for recrystallization to constant melting point and rotation, which usually required only one or two recrystallizations when an aldose was reduced, were determined. The aldoses yield a single alcohol; the members of the pairs of alcohols from the ketoses were separated with care; the details of separation and purification are obtainable from the references. The concentration (*c*) indicates grams per 100 cc. of solution. No difference beyond the limits of error was found between readings in U.S.P. chloroform and absolute chloroform for several of the substances. The only alcohol which gave considerable trouble at first was *D*-volemitol (*D*-manno-*D*-talo-heptitol) from the reduction of the ketose *D*-manno-*D*-tagato-heptose; the method which was found to separate it completely from the accompanying *D*-perseitol has been described recently (ref. 40, last citation). The heptabenzoates of two heptitols were prepared by the action of benzoyl chloride and pyridine; gluco-*gulo*-heptitol heptabenzoate, m. p. 147°, no rotation because of meso configura-

TABLE I

Data for the Identification of Various Higher-carbon Alcohols of the Sugar Group

	Alcohols			Alcohol Acetates			Remarks
	M.p. (corr.)	$[\alpha]_D^{20}$ (water) conc. (c)	Recrystal- lization	M.p. (corr.)	$[\alpha]_D^{20}$ (chloroform) conc. (c)	Recrystal- lization	
	Heptitols			Heptaacetates			
1. Gluco- <i>gulo</i> -heptitol	129°	meso	6 pts. 75% alc.	118°	meso	4 pts. 95% alc.	D-Perseitol D-Volemitol, by reduction of D- manno-D- <i>talato</i> - heptose. Ref. 40, last citation L-Perseitol Enantiomorph of 7 Enantiomorph of 6, by reduction of L-Perseulose. Ref. 46
2. D-GlucO-D- <i>ido</i> -heptitol	129°	+0.7° (c, 4)	16 pts. 90% alc.			amorphous	
3. D-Manno-D- <i>gala</i> -heptitol	187°	-1.1° (c, 5)	10 pts. 50% alc.	119.5°	-13.3° (c, 2.2)	5 pts. 95% alc.	
4. D-Manno-D- <i>talo</i> -heptitol (See p. 11 concerning D-Gulo-L- <i>talo</i> -heptitol)	153°	+2.1° (c, 4.1)	20 pts. 85% alc.	63°	+36.1° (c, 2)	150 pts. water	
5. D-Gala-L- <i>manno</i> -heptitol	187°	+1.1° (c, 4.8)	10 pts. 50% alc.	119°	+13.4° (c, 2.2)	5 pts. 95% alc.	
6. D-Gala-L- <i>gluco</i> -heptitol	141.5°	+2.4° (c, 3.8)	6 pts. 50% alc.	118°	+11.4° (c, 2.6)	2 pts. 95% alc.	
7. L-Gala-D- <i>gluco</i> -heptitol	141°	-2.4° (c, 3.9)	6 pts. 50% alc.	118°	-11.4° (c, 2.2)	2 pts. 95% alc.	
	Octitols			Octaacetates			
8. D-GlucO-L- <i>gala</i> -octitol	153°	+2.4° (c, 4)	5 pts. 75% alc.	88°	+20.7° (c, 3.8)	3 pts. 95% alc.	Identical with 12
9. D-GlucO-L- <i>talo</i> -octitol	161°	-0.8° (c, 4.1)	8 pts. 50% alc.	101.5°	+17.4° (c, 2.8)	3.5 pts. 95% alc.	
10. D-Manno-L- <i>manno</i> -octitol	262°	meso	100 pts. water	166°	meso	25 pts. 95% alc.	Octitol is not meso Identical with 8
11. D-Gala-L- <i>gala</i> -octitol	230°	0.0°	10 pts. water	141°	+40.4° (c, 1.2)	5 pts. 95% alc.	
12. D-Gala-L- <i>gulo</i> -octitol	153°	+2.4° (c, 1.6)	5 pts. 75% alc.	88°	+20.5° (c, 1.5)	3 pts. 95% alc.	



tion, recrystallization from 100 parts of 95% alcohol; *D*-gluco-*D*-ido-heptitol heptabenzate, m. p. 181°,  $[\alpha]_D^{20} +25.3^\circ$  (*c*, 2.5) in chloroform, recrystallization from 125 parts of 95% alcohol. The melting point of the latter substance agrees with Philippe's value<sup>84</sup>; the rotation is the first record. The heptabenzate of the meso alcohol is a new substance.

Pure allitol (meso configuration; m. p. 150–151°) was described for the first time by Lespieau and Wiemann,<sup>93</sup> who synthesized it by the hydroxylation of one of the stereoisomeric forms of divinylglycol. Its structure was established rigorously by Steiger and Reichstein<sup>94</sup> when they demonstrated its identity with the product obtained by the reduction of *D*-allose.

<sup>93</sup> R. Lespieau and J. Wiemann, *Compt. rend.*, 195, 886 (1932); *Bull. soc. chim.*, 53, 1107 (1933); J. Wiemann, *Ann. chim.*, [11], 5, 316 (1936).

<sup>94</sup> Marguerite Steiger and T. Reichstein, *Helv. Chim. Acta*, 19, 188 (1936).

# THE ALTROSE GROUP OF SUBSTANCES

BY NELSON K. RICHTMYER

*National Institute of Health, U. S. Public Health Service, Bethesda, Maryland*

## CONTENTS

I. Introduction . . . . .	37
II. Altrose from Ribose . . . . .	38
III. Neolactose, Celtrobose, and Altrose . . . . .	40
IV. Sedoheptulose and Sedoheptulosan . . . . .	47
V. The Structure of D-Altrosan . . . . .	50
VI. D-Altrose Derivatives from D-Altrosan . . . . .	53
VII. D-Altrose from Methyl $\alpha$ -D-Glucoside . . . . .	54
VIII. Epiglucosamine and Other Altrose Derivatives . . . . .	57
IX. The 6-Desoxyaltroses . . . . .	62
X. The Alluloses . . . . .	64
XI. Calcium D-Altronate from D-Galactose and from Pectin . . . . .	67
XII. Compounds Possibly Related to Altrose . . . . .	71
XIII. Table I. D- and L-Altrose and Derivatives . . . . .	72
XIV. Table II. Neolactose, Celtrobose, and Derivatives . . . . .	76

## I. INTRODUCTION

It was in 1910 that Levene and Jacobs<sup>1</sup> first applied the classical cyanohydrin synthesis<sup>2</sup> to D-ribose (I), a five carbon atom aldehyde sugar (aldopentose) which had become more readily available through their earlier research on nucleic acids. Two new aldohexoses were thus obtained in sirupy form, and characterized by suitable crystalline derivatives. To one of these sugars was given the name "allose," with configuration V, because it should be oxidizable readily to allomucic acid (VIII). The latter is an optically inactive, dibasic acid, described by

<sup>1</sup> P. A. Levene and W. A. Jacobs, *Ber.*, **43**, 3141 (1910).

<sup>2</sup> See C. S. Hudson, "The Fischer Cyanohydrin Synthesis and the Configurations of Higher-Carbon Sugars and Alcohols," this book, p. 1.

Fischer<sup>3</sup> as a rearrangement product of mucic acid, hence designated allomucic acid, from the Greek "αλλος," meaning "other." As the source of a name for the second new sugar, Levene and Jacobs<sup>4</sup> used the Latin "alter," also meaning "other." The name D-altrose and configuration IV were then assigned to that sugar whose corresponding acid, D-altronic acid (II), had been oxidized by them to the optically active, dibasic D-talomucic acid (VII); this compound was already known from the oxidation of D-talonic acid (VI) by Fischer.<sup>5</sup>

The following review of the sugars and their derivatives which have the altrose or a closely related configuration will include the aldohexoses D-altrose and L-altrose, the ketohexoses D-allulose and L-allulose, and a ketoheptose, sedoheptulose; also two 6-desoxyaltroses and two naturally-occurring 2,6-didesoxyaltroses, digitoxose and cymarose; and finally the disaccharides neolactose and celtribiose, which are 4-β-D-galactopyranosido-D-altrose and 4-β-D-glucopyranosido-D-altrose, respectively.

## II. ALTROSE FROM RIBOSE

Until very recently, D-ribose has been such a rare and expensive sugar that the addition of hydrocyanic acid to it and the conversion of the mixed nitriles to hexonic acids have been described only a few times. From the combined experiences of Levene and Jacobs,<sup>1</sup> of Phelps and Bates,<sup>6</sup> and of Steiger and Reichstein,<sup>7</sup> it appears that D-altronic and D-allonic acids are produced in about equal amounts, in a total yield of 70–80% of the theoretical. To separate the two acids, they were converted to calcium salts, and most of the calcium D-altronate was recovered as the characteristic hydrate containing three and one-half molecules of water of crystallization. The mother liquor was freed from calcium ions by the addition of oxalic acid, and evaporated to a sirup from which the D-allono-γ-lactone crystallized. Small additional amounts of the two compounds were obtained by further treatment of the mother liquors.

<sup>3</sup> E. Fischer, *Ber.*, **24**, 2136 (1891). Although Fischer assigned to his compound the formula VIII, he indicated that it was not with complete certainty [*ibid.*, **27**, 3214, 3220 (1894)]. Fischer's allomucic acid was identified as D,L-talomucic acid by T. Posternak [*Naturwissenschaften*, **23**, 287 (1935)], who prepared the true allomucic acid only by oxidation of D-allonic acid (III) [*Helv. Chim. Acta*, **18**, 1283 (1935)]. See also F. L. Humoller, W. F. McManus and W. C. Austin, *J. Am. Chem. Soc.*, **58**, 2479 (1936); **59**, 945 (1937).

<sup>4</sup> Private communication from Dr. Walter A. Jacobs, of the Rockefeller Institute for Medical Research, New York, N. Y.

<sup>5</sup> E. Fischer, *Ber.*, **24**, 3622 (1891).

<sup>6</sup> F. P. Phelps and F. J. Bates, *J. Am. Chem. Soc.*, **56**, 1250 (1934).

<sup>7</sup> Marguerite Steiger and T. Reichstein, *Helv. Chim. Acta*, **19**, 184 (1936).

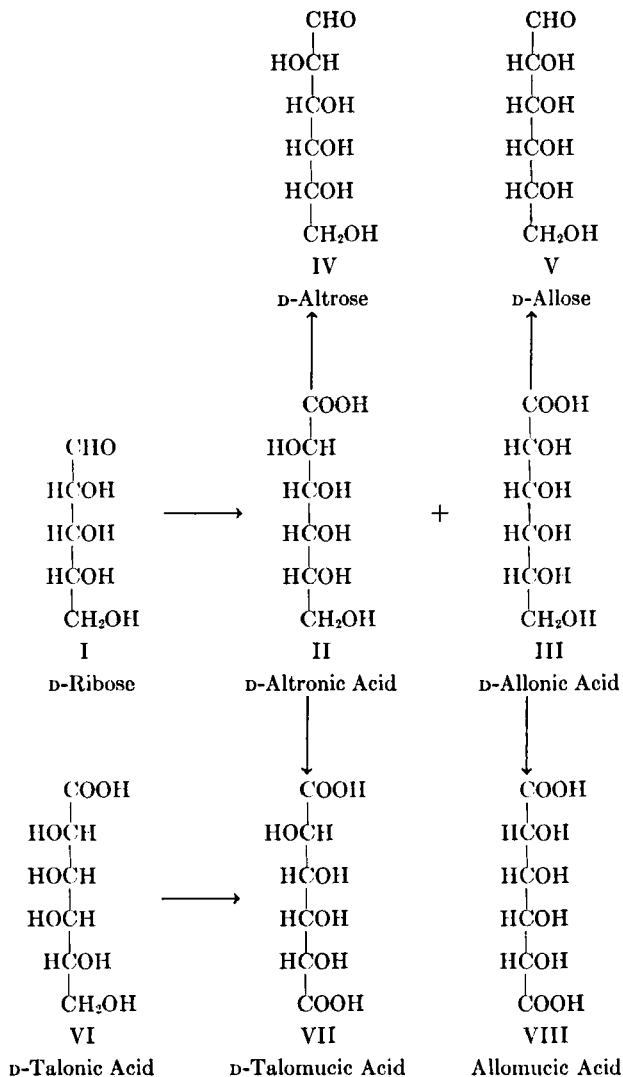

The conversion of calcium d-altronate to d-altrose follows the standard procedure of Fischer, which consists in liberating the aldonic acid, heating it to effect lactonization, and reducing the sirupy lactone with sodium amalgam. Levene and Jacobs<sup>1</sup> thus prepared d-altrose as a sirup, but did not record its rotation. It formed a crystalline phenylosazone, which is common to both d-altrose and d-allose, and a characteristic benzylphenylhydrazone. Pertinent data on these substances, and on

the crystalline phenylhydrazide and brucine salt of D-altronic acid which were described later by Levene and Meyer,<sup>8</sup> will be found in Table I.

### III. NEOLACTOSE, CELTROBIOSE, AND ALTROSE

Subsequent to the synthesis of D-altrose in 1910, no further work on altrose was reported until 1926. In the preceding year, Hudson and Kunz<sup>9</sup> had prepared acetochloro- $\alpha$ -lactose by boiling gently for one and one-half hours a mixture of 20 g. of octaacetyllactose in 100 ml. of chloroform with 10 g. of phosphorus pentachloride and 5 g. of anhydrous aluminum chloride; the pure product, isolated in the usual way, consisted of needles, m. p. 120–121°, and  $[\alpha]_D^{20} +83.9^\circ$  in chloroform. On one occasion, however, they noted that the addition of petroleum ether to the mother liquor of an original crystallization caused the separation of about 1 g. of a crystalline substance in the form of prisms, m. p. 160°, and  $[\alpha]_D^{25} +71.7^\circ$  in chloroform.

Kunz and Hudson,<sup>10</sup> finding that the prismatic crystals had the composition and properties of an acetochloro derivative of a new disaccharide, named the parent sugar neolactose to indicate its origin in the rearrangement of lactose. They improved the yield of acetochloro-neolactose by omitting the phosphorus pentachloride, and by using 200 g. of Stockhausen and Gattermann's powdered aluminum chloride for each 100 g. of octaacetyllactose, heated in one liter of absolute chloroform for two hours at 65°. The yield was 50 g. of a mixture of acetochloro derivatives from which the acetochloro- $\alpha$ -lactose could be extracted readily with cold ethyl acetate. The acetochloro- $\alpha$ -neolactose which remained weighed 20 g., and was purified with slight loss by a single recrystallization. It was transformed to octaacetyl- $\alpha$ -neolactose and to octaacetyl- $\beta$ -neolactose (see Table II); the difference of their molecular rotations,  $A_{Ac} = +20,500$ , had the normal value for an  $\alpha, \beta$  pair of sugar acetates.

The structure of neolactose was established in a second paper by Kunz and Hudson.<sup>11</sup> By deacetylation of the  $\alpha$ -octaacetate they obtained neolactose as a sirup, with  $[\alpha]_D$  about  $+35^\circ$  in water. Its phenylosazone differed from that of lactose, hence the new sugar could be neither lactose (4-galactosidoglucose) nor Bergmann's 4-galactosidomannose<sup>12</sup> which might have been formed by simple epimerization at

<sup>8</sup> P. A. Levene and G. M. Meyer, (a) *J. Biol. Chem.*, **26**, 355 (1916); (b) *ibid.*, **31**, 623 (1917).

<sup>9</sup> C. S. Hudson and A. Kunz, *J. Am. Chem. Soc.*, **47**, 2052 (1925).

<sup>10</sup> A. Kunz and C. S. Hudson, *J. Am. Chem. Soc.*, **48**, 1978 (1926).

<sup>11</sup> A. Kunz and C. S. Hudson, *J. Am. Chem. Soc.*, **48**, 2435 (1926).

<sup>12</sup> M. Bergmann, *Ann.*, **434**, 79 (1923).

carbon 2. The oxidation of neolactose by bromine water to a monobasic neolactobionic acid, followed by hydrolysis with hydrochloric acid, yielded crystalline *D*-galactose (XIII) and a hexonic acid which was identified as *D*-altronic acid (II) by its conversion to the crystalline brucine *D*-altronate described by Levene and Meyer.<sup>8a</sup> Conclusive proof that *D*-altrose was the second component hexose in neolactose was obtained by acid hydrolysis of that disaccharide. Crystalline *D*-galactose (XIII) was isolated in good yield, and the accompanying sirupy sugar was identified by its conversion to *D*-altrose phenylosazone,<sup>1</sup> and by its oxidation to *D*-talomucic acid (VII).<sup>5</sup> Neolactose, therefore, was a *D*-galactosido-*D*-altrose; the action of aluminum chloride had brought about the inversion of configuration at both carbon atoms 2 and 3 in the glucose moiety of lactose. These transformations are shown in formulas IX to XIV, and, written with our present knowledge of linkages, neolactose (XII) is 4- $\beta$ -*D*-galactopyranosido-*D*-altrose.

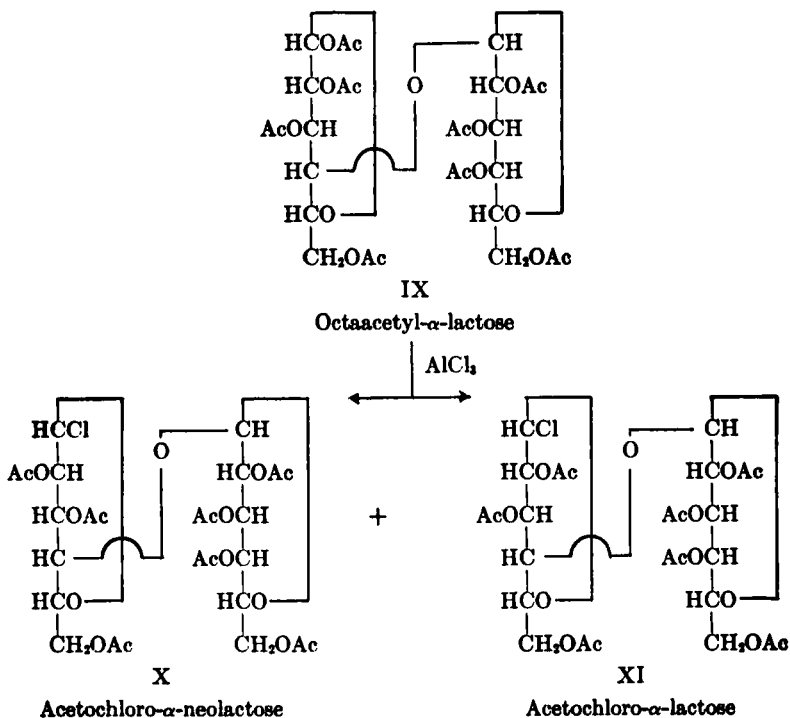

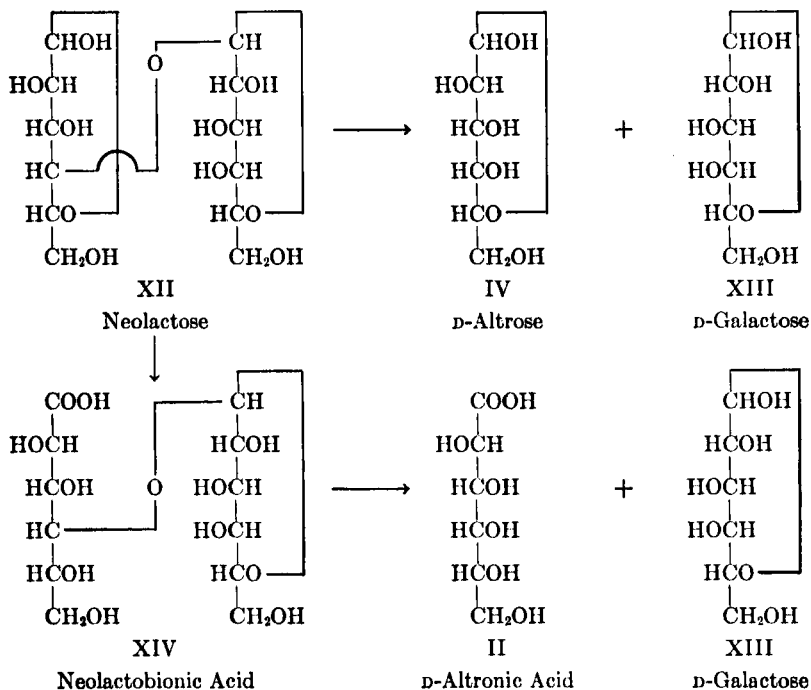

It had been found that the equimolecular mixture of *D*-galactose and *D*-altrose resulting from the acid hydrolysis of neolactose had a negative rotation, calculated as hexose, of  $[\alpha]_D - 8.95^\circ$  in water. Knowing the equilibrium rotation of *D*-galactose to be  $+80^\circ$ , Kunz and Hudson<sup>11</sup> estimated that *D*-altrose would have  $[\alpha]_D - 98^\circ$  in water.

Crystalline *L*-altrose was described in 1934 by Austin and Humoller.<sup>13</sup> After improving the methods for the preparation of *L*-ribose,<sup>14</sup> they applied the cyanohydrin synthesis to 30 g. of that sugar and obtained 17 g. of crystalline calcium *L*-altronate and 14.5 g. of crystalline *L*-allono- $\gamma$ -lactone. Reduction of the latter with sodium amalgam yielded crystalline *L*-allose.<sup>15, 13</sup> The calcium *L*-altronate, by appropriate reactions, was converted to *L*-altrose,<sup>13</sup> and the last of the sixteen theoretically possible aldohexoses had been prepared. Data on *L*-altrose and its derivatives are included in Table I.

Crystalline *L*-altrose, which had been obtained through the reduction of *L*-altronolactone with sodium amalgam in cold, weakly acid solution,

<sup>13</sup> W. C. Austin and F. L. Humoller, *J. Am. Chem. Soc.*, **56**, 1153 (1934).

<sup>14</sup> W. C. Austin and F. L. Humoller, *J. Am. Chem. Soc.*, **54**, 4749 (1932); **56**, 1152 (1934).

<sup>15</sup> W. C. Austin and F. L. Humoller, *J. Am. Chem. Soc.*, **55**, 2167 (1933).

had an initial  $[\alpha]_{D^{20-25}} -28.75^\circ$  changing to  $-32.3^\circ$  at equilibrium. D-Altrose would thus be expected to have a final  $[\alpha]_{D^{20}} +32.3^\circ$ , which is considerably different from the value  $-98^\circ$  estimated by Kunz and Hudson<sup>11</sup> for the D-altrose liberated by the hydrolysis of neolactose with warm acid. The cause of this disagreement was soon discovered.

In a new study of neolactose, Richtmyer and Hudson<sup>16</sup> improved the method of preparing acetochloroneolactose; a 35–40% yield of the recrystallized material was obtained consistently by heating each 50 g. of octaacetylactose in 350 ml. of absolute chloroform with 100 g. of powdered technical aluminum chloride and 50 g. of powdered phosphorus pentachloride for twenty minutes in a bath at 55–58°. By removing the chlorine atom with silver carbonate and aqueous acetone, and deacetylating the heptaacetates thus formed (see Table II), they isolated the parent disaccharide. Crystalline neolactose had a rotation  $[\alpha]_{D^{20}} +34.6 \rightarrow +35.5^\circ$ , which is in agreement with the equilibrium value  $+35^\circ$  reported by Kunz and Hudson<sup>11</sup> for sirupy neolactose.

Acid hydrolysis of pure neolactose yielded a mixture of D-galactose and D-altrose from which the former was removed by fermentation with yeast. The D-altrose sirup which remained had a high negative specific rotation in accordance with the value  $-98^\circ$  estimated in the earlier work. This material was converted to a crystalline dibenzyl mercaptal which agreed in melting point and in magnitude of rotation, although it was of opposite sign, with L-altrose dibenzyl mercaptal prepared from an authentic sample of Austin and Humoller's L-altrose. The pure D-altrose dibenzyl mercaptal was then treated with mercuric chloride and cadmium carbonate, and from the resulting mixture by suitable manipulations the free sugar was crystallized. D-Altrose thus became the eleventh of the sixteen aldohexoses to be secured in crystalline form.<sup>17</sup>

Although no mutarotation was observed with the first small sample of D-altrose, its  $[\alpha]_{D^{20}}$  value of  $+32.6^\circ$  in water was in agreement with the equilibrium rotation  $-32.3^\circ$  recorded by Austin and Humoller<sup>13</sup> for L-altrose. When a larger amount of the sugar became available, D-altrose was found to exhibit a complex mutarotation.<sup>18</sup> From calculations of the velocity coefficients it would appear that the mutarotation consists of a very rapid interconversion of furanose and pyranose modifications, followed by a slower interconversion of  $\alpha$  and  $\beta$  pyranose modifications.

<sup>16</sup> N. K. Richtmyer and C. S. Hudson, *J. Am. Chem. Soc.*, **57**, 1716 (1935); see also *ibid.*, **63**, 1727 footnote 3 (1941).

<sup>17</sup> R. C. Hockett and L. B. Chandler, *J. Am. Chem. Soc.*, **66**, 627 (1944) have described a modification of this method of preparing D-altrose; cf. N. K. Richtmyer and C. S. Hudson, *ibid.*, **62**, 963 footnote 15 (1940).

<sup>18</sup> N. K. Richtmyer and C. S. Hudson, *J. Am. Chem. Soc.*, **65**, 740 (1943).



It is possible that the crystalline  $\beta$ -D-altrose is a furanose form. Preliminary measurements of the extremely rapid change of rotation which occurs within the first three minutes after altrose is dissolved in water at 20° have indicated an initial highly negative rotation, although the extrapolated value  $[\alpha]_D^{20} - 69^\circ$  is necessarily uncertain.

When D-altrose was heated with hydrochloric acid under the same conditions as were used in the cleavage of neolactose, the specific rotation changed from +34° to -98°; similarly, L-altrose changed to +98°. This change in rotation was accompanied by a considerable loss in reducing power of the altrose solution, equilibrium being reached at about 43% of the original value.<sup>16</sup> Thus the discrepancy in the specific rotations reported for altrose was traced to its behavior toward acid. The product, which is generated to the extent of 57% from D-altrose, is a non-reducing, highly levorotatory anhydride, which has been named D-altrosan, and will be described later.

Hudson<sup>19</sup> extended the study of aluminum chloride as a rearranging agent for sugar acetates to include its action upon octaacetylcellobiose. In addition to a considerable yield of acetochlorocellobiose, he isolated 13% of an acetochloro derivative of a new disaccharide to which he gave the name celtrobiose. Richtmyer and Hudson<sup>20</sup> increased the yield of acetochloro- $\alpha$ -celtrobiose to 40-45% by using a mixture of aluminum chloride and phosphorus pentachloride. The  $\alpha$ - and  $\beta$ -octaacetates exhibited a normal value for the rotation of the end carbon atom,  $A_{A_0} = +20,700$ . By deacetylation, crystalline celtrobiose monohydrate was obtained, with  $[\alpha]_D^{20} + 13.6^\circ$  in water; no mutarotation was observed. Acetylation of celtrobiose at a low temperature with acetic anhydride and pyridine furnished evidence that the crystalline sugar is a  $\beta$ -form; the absence of mutarotation appears to indicate that the aqueous solution in equilibrium contains almost solely the  $\beta$ -modification. Additional data on celtrobiose and its acetates are recorded in Table II.

The structure of celtrobiose was established through its oxidation to celtrobionic acid and subsequent cleavage with *N* sulfuric acid to D-glucose and D-altronic acid. Since the biose linkage should not be affected by the aluminum chloride rearrangement, celtrobiose was thus proved to be 4- $\beta$ -D-glucopyranosido-D-altrose.

Experimental evidence for the presence of the  $\beta$ -linkage in neolactose and celtrobiose is based upon the enzymic hydrolysis of these sugars. Helferich and Pigman<sup>21</sup> reported that the  $\beta$ -D-galactosidase component of sweet almond emulsin cleaves neolactose (4- $\beta$ -D-galactosido-D-altrose),

<sup>19</sup> C. S. Hudson, *J. Am. Chem. Soc.*, **48**, 2002 (1926).

<sup>20</sup> N. K. Richtmyer and C. S. Hudson, *J. Am. Chem. Soc.*, **58**, 2534 (1936).

<sup>21</sup> B. Helferich and W. W. Pigman, *Ber.*, **72**, 212 (1939).

although only one-seventh as rapidly as it does lactose (4- $\beta$ -D-galactosido-D-glucose). Richtmyer and Hudson<sup>22</sup> found that the  $\beta$ -D-glucosidase component<sup>23</sup> of sweet almond emulsin cleaves cellobiose, although only one-seventh as rapidly as it does cellobiose. The great difference in the ease of hydrolysis of the two  $\beta$ -galactosides, and similarly of the two  $\beta$ -glucosides, is connected with the change from D-glucose to D-altrose in the aglycon portion of the glycosides. This has been interpreted as resulting in the hydroxyl group on carbon atom 3 becoming nearer spatially to the glycosidic union at carbon atom 4, and the steric hindrance to cleavage of the disaccharide linkage at carbon atom 4 has reduced the speed of hydrolysis to one-seventh of the original rate.

Pigman<sup>24</sup> has prepared crystalline D-altrose from neolactose by cleavage of the disaccharide with sweet almond emulsin, followed by removal of the D-galactose by fermentation with yeast. This procedure avoids the transformation of any D-altrose to D-altrosan, the non-reducing anhydride which is formed to the extent of 57% in the hydrolysis of neolactose by acids.

Orthoesters may be expected with considerable regularity in the altrose series according to the opposite-face concept of the mechanism of the Walden inversion, as discussed by Frush and Isbell.<sup>25</sup> (For a discussion of orthoesters, see the article by Dr. Eugene Pacsu, this volume, p. 77.) As a test, those authors stirred acetochloroneolactose with methyl alcohol, silver carbonate and "Drierite" at 0° for seventy-two hours. About 30% of methyl heptaacetyl- $\beta$ -neolactoside and about 70% of hexaacetylneolactose methyl 1,2-orthoacetate (XV) were isolated. The latter compound showed reactions and properties which are characteristic of the sugar methyl orthoacetates, namely, a smooth conversion to the acetochloro derivative by the action of hydrogen chloride in anhydrous chloroform, and stability of its orthoacetate group toward alkaline hydrolysis whereas all seven acetyl groups are hydrolyzed readily by acid. Richtmyer and Hudson<sup>20</sup> have suggested that their third heptaacetate of cellobiose may have an orthoester structure (XVI or XVII), although reactions which might have been expected to prove an orthoester linkage in this type of compound have led to derivatives of the normal type.

<sup>22</sup> N. K. Richtmyer and C. S. Hudson, *J. Am. Chem. Soc.*, **61**, 1834 (1939).

<sup>23</sup> It is uncertain whether the  $\beta$ -D-galactosidase and the  $\beta$ -D-glucosidase of sweet almond emulsin are the same or different enzymes. See B. Helferich, *Ergeb. Enzymforsch.*, **7**, 83 (1938).

<sup>24</sup> Personal communication from Dr. W. W. Pigman of the Corn Products Refining Co., Chicago, Ill.

<sup>25</sup> Harriet L. Frush and H. S. Isbell, *J. Research Natl. Bur. Standards*, **27**, 413 (1941).

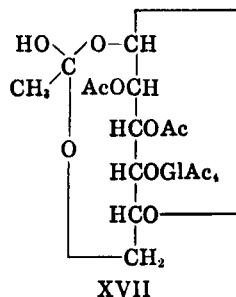
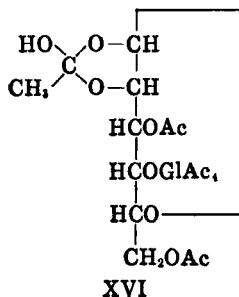
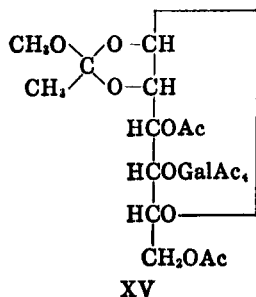

Concerning the mechanism of the rearrangement of sugar acetates by aluminum chloride, there is very little to be added at the present time. The reaction proceeds equally as well with the  $\alpha$ -octaacetate of cellobiose<sup>20</sup> as it does with the  $\beta$ -octaacetate of lactose.<sup>16</sup> Under the most favorable conditions so far discovered, it appears that octaacetyl-lactose is converted to about equal amounts of acetochlorolactose and acetochloroneolactose; similar results were obtained with octaacetyl-cellobiose. Although Kunz and Hudson<sup>10</sup> believed acetochlorolactose to be the primary reaction product, which was transformed subsequently to the isomeric neolactose derivative, later experiments by Richtmyer and Hudson<sup>16</sup> did not substantiate this view. In an uncompleted study of the action of a mixture of aluminum and phosphorus chlorides upon pentaacetyl-D-glucose, Richtmyer and Hudson<sup>26</sup> have demonstrated that both D-altrose and D-mannose derivatives are formed by rearrangement of the D-glucose molecule.

In a study of the asymmetric oxidation of sugars, Richtmyer and Hudson<sup>27</sup> have found that the D- and L-forms of altrose have the same reducing power, namely 80% of that of D-glucose, toward the optically inactive Hagedorn-Jensen-Hanes alkaline ferricyanide reagent, and toward an alkaline copper solution, the Shaffer-Hartmann-Somogyi Reagent 50, when it is prepared with optically inactive *meso* tartaric acid. If the latter reagent contains racemic tartaric acid, D- and L-altrose each have 69% of the reducing power of D-glucose. However, the usual copper reagent contains optically active D-tartaric acid; for comparison, a similar reagent was prepared with L-tartaric acid. D-Glucose reduces both D- and L-tartaric acid reagents to practically the same extent. However, D-altrose has only 53% of the reducing power of D-glucose toward the D-tartrate reagent, but it has 87% of the reducing power of D-glucose toward the L-tartrate reagent. On the other hand, L-altrose has only

<sup>26</sup> N. K. Richtmyer and C. S. Hudson, unpublished results.

<sup>27</sup> N. K. Richtmyer and C. S. Hudson, *J. Am. Chem. Soc.*, **58**, 2540 (1936).

53% of the reducing power of D-glucose toward the L-tartrate reagent, but it has 86% of the reducing power of D-glucose toward the D-tartrate reagent. Interpreted in a slightly different manner, the data show that D-altrose reduces the L-reagent 163% as much as it does the D-reagent, whereas L-altrose reduces the L-reagent only 61% as much as it does the D-reagent. These examples of the asymmetric oxidation of sugars in the presence of an optically active reagent have been equalled so far only by allose, although less striking values have been reported for arabinose, fucose and galactose, which are closely related to altrose in the configuration of their second, third and fourth carbon atoms.

#### IV. SEDOHEPTULOSE AND SEDOHEPTULOSAN

La Forge and Hudson<sup>28</sup> discovered in 1917 a new reducing sugar which occurs to the extent of 1% or more in the leaves and stems of *Sedum spectabile* Bor., a succulent, hardy, perennial herb of easy cultivation. Although isolated as a sirup, it was recognized through analyses of several crystalline derivatives as a seven carbon atom sugar, to which they gave the name sedoheptose. Its ketone nature was established by its failure to be oxidized by bromine, and by its reduction with sodium amalgam to two heptahydric alcohols which were designated as  $\alpha$ - and  $\beta$ -sedoheptitols. The modern term sedoheptulose indicates that it is a ketose.

Proner<sup>29a</sup> has proved the presence of sedoheptulose in *Sedum acre* L., *S. boloniense* Lois., and *S. reflexum* L. Bennet-Clark<sup>29b</sup> reported its presence in *S. praealtum* A. de C. Nordal<sup>30a</sup> identified sedoheptulose conclusively in *S. acre*, L., *S. album* L., *S. roseum* (L.) Scop., *S. spurium* M.-B., and *S. Telephium* L., and concluded from qualitative color reactions that sedoheptulose is widely distributed within the family Crassulaceae, but it is not always present. The experiments of Wolf<sup>30b</sup> have made it appear highly probable that sedoheptulose occurs in *Bryophyllum calycinum* Salisb. and *Sempervivum glaucum* Tenore.

The configuration of sedoheptulose was established through studies of the two sedoheptitols and their derivatives. La Forge<sup>31</sup> found  $\alpha$ -sedoheptitol to be identical with volemitol, which had been isolated first by Bourquelot<sup>32</sup> from the mushroom *Lactarius volemus* Fr. Vole-

<sup>28</sup> F. B. La Forge and C. S. Hudson, *J. Biol. Chem.*, **30**, 61 (1917).

<sup>29a</sup> M. Proner, *Bull. sci. pharmacol.*, **43**, 7 (1936); *Wiadomości Farm.*, **62**, 742 (1935).

<sup>29b</sup> T. A. Bennet-Clark, *New Phytologist*, **32**, 128 (1933).

<sup>30a</sup> A. Nordal, *Arch. Pharm.*, **278**, 289 (1940).

<sup>30b</sup> J. Wolf, *Planta*, **26**, 516 (1937).

<sup>31</sup> F. B. La Forge, *J. Biol. Chem.*, **42**, 375 (1920). See also ref. 28, and F. B. La Forge and C. S. Hudson, *J. Biol. Chem.*, **79**, 1 (1928).

<sup>32</sup> E. Bourquelot, *Bull. soc. mycologique France*, **5**, 132 (1889).

mitol was identified subsequently by Ettel<sup>33</sup> as *D*- $\beta$ -mannoheptitol (*D*-manno-*D*-*talo*-heptitol<sup>34</sup>) of known configuration (XIX).<sup>35</sup> Ettel<sup>36</sup> showed

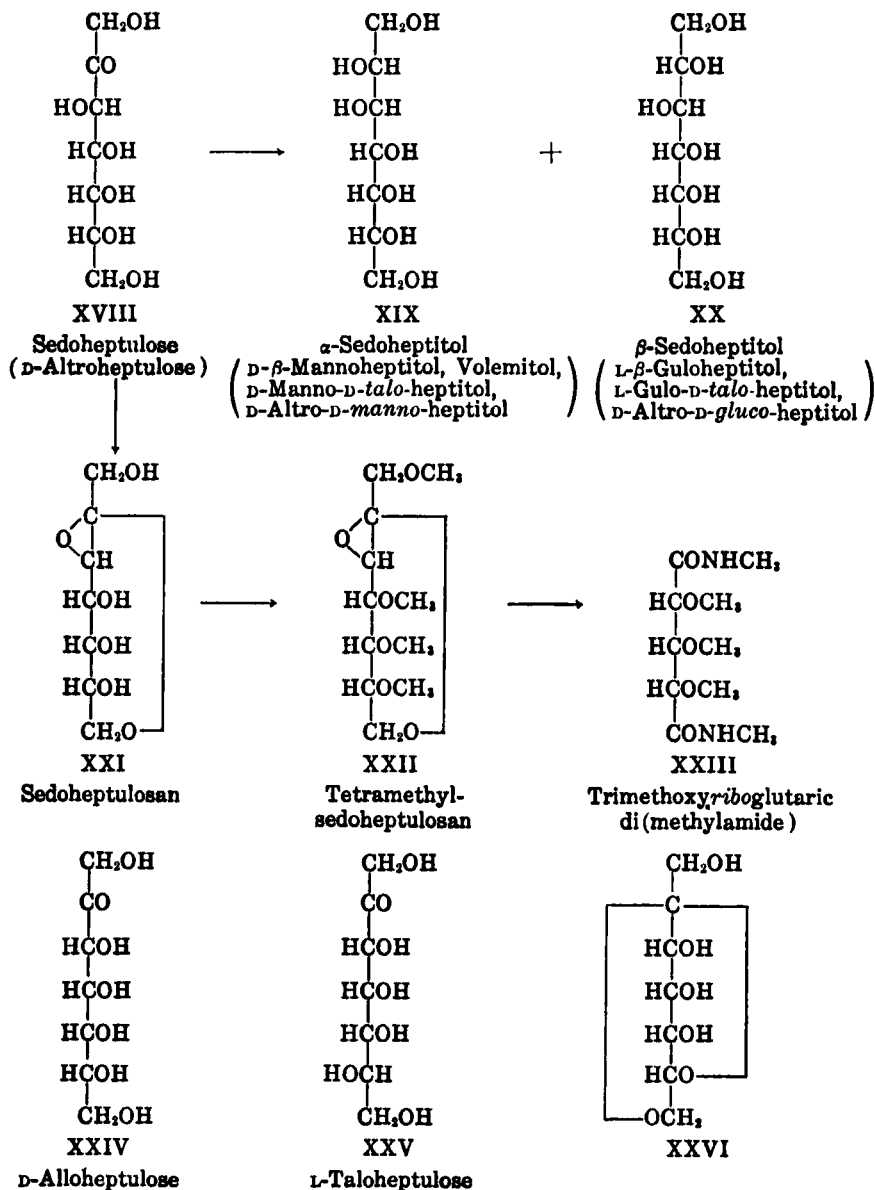

<sup>33</sup> V. Ettel, *Collection Czechoslov. Chem. Commun.*, **4**, 504 (1932).

<sup>34</sup> For nomenclature, see C. S. Hudson, *J. Am. Chem. Soc.*, **60**, 1537 (1938).

<sup>35</sup> G. Peirce, *J. Biol. Chem.*, **23**, 327 (1915); La Forge, *ibid.*, **28**, 521 (1917).

<sup>36</sup> V. Ettel, *Collection Czechoslov. Chem. Commun.*, **4**, 513 (1932).

also that  $\beta$ -sedoheptitol is the enantiomorph of the known D- $\beta$ -guloheptitol,<sup>37</sup> and hence must be L- $\beta$ -guloheptitol (L-gulo-D-talo-heptitol) (XX). From this evidence Ettel concluded that sedoheptulose could be formulated only as D-altroheptulose (XVIII).

Independent proof of the D-altroheptulose configuration was supplied by Richtmyer, Hann and Hudson<sup>38</sup> through the oxidative degradation of sedoheptulose (XVIII). The use of oxygen and an alkaline solution of the sugar, according to the general method of Spengler and Pfannenstiel,<sup>39</sup> eliminated carbon atom 1 and converted the carbonyl to a carboxylic acid group. D-Altronic acid (II) was then isolated as the characteristic hydrated calcium D-altronate.

La Forge and Hudson<sup>28</sup> had isolated sedoheptulose as a non-fermentable sirup with a small positive rotation in aqueous solution, and with a strongly reducing action toward Fehling solution. The sugar has not yet been crystallized, nor has any crystalline derivative been obtained from which the sugar can be regenerated in pure form. Sedoheptulose was soon found to occupy a unique position among the known members of the sugar group. In the presence of hot, dilute acids it lost 80% of its reducing power, and its rotation changed from weakly positive to strongly negative. The loss of reducing power suggested anhydride formation involving the glycosidic hydroxyl group. By shaking the transformed material, or the crude sugar sirup, with benzaldehyde and sulfuric acid, La Forge and Hudson<sup>28</sup> were able to separate a dibenzylidene derivative of an anhydro-sedoheptulose. The pure product crystallized from hot acetic anhydride in beautiful prisms, m. p. 245°. The benzylidene groups were removed by cautious hydrolysis, and the anhydro-sedoheptulose, later designated sedoheptulosan, was obtained as short, thick crystals of m. p. 155° and  $[\alpha]_D^{20} = -146^\circ$  in water. It was non-reducing, but with acid it developed reducing power to form the same equilibrium mixture that was generated by the action of acid upon sedoheptulose.

The ring structure of sedoheptulosan was investigated by Hibbert and Anderson.<sup>40</sup> Five successive methylations with methyl iodide and silver oxide furnished them with a non-reducing tetramethylsedoheptulosan of m. p. 48–49° and  $[\alpha]_D^{20} = -137^\circ$  in water. This compound was

<sup>37</sup> F. B. La Forge, *J. Biol. Chem.*, **41**, 251 (1920).

<sup>38</sup> N. K. Richtmyer, R. M. Hann and C. S. Hudson, *J. Am. Chem. Soc.*, **61**, 343 (1939); see also U. S. Pat. 2,207,738, July 16, 1940.

<sup>39</sup> O. Spengler and A. Pfannenstiel, *Z. Wirtschaftsgruppe Zuckerind.*, **85**, Tech. Tl. 547 (1935). See also N. K. Richtmyer, R. M. Hann and C. S. Hudson, *J. Am. Chem. Soc.*, **61**, 340 (1939); N. K. Richtmyer and C. S. Hudson, *ibid.*, **64**, 1609 (1942).

<sup>40</sup> H. Hibbert and C. G. Anderson, *Can. J. Research*, **3**, 306 (1930).

heated with concentrated nitric acid, and the resulting oxidation products were esterified and converted to methylamides in the usual manner. An optically inactive trimethoxyglutaric di(methylamide), m. p. 145–146°, was isolated. Since only two optically inactive trimethoxyglutaric acids are possible, and the trimethoxyxyloglutamic di(methylamide) was known<sup>41</sup> to melt at 167–168°, they concluded that their compound was the previously unknown trimethoxyriboglutaric di(methylamide) (XXIII). At that time, however, Ettel had not yet established the configuration of sedoheptulose. La Forge,<sup>42</sup> through a series of circumstances, had wrongly concluded that sedoheptulose must have either the D-alloheptulose (XXIV) or the L-taloheptulose (XXV) configuration. Consequently, although based on the only possible interpretation of the experimental data, the allocation by Hibbert and Anderson of 2,6 and 2,7 rings to sedoheptulosan, led to the incorrect formula XXVI.

In 1936, Levene and Compton<sup>43</sup> prepared from 2,3,4-trimethyl-D-ribose a trimethoxyriboglutaric di(methylamide) which agreed in its melting point of 145–146°, and in its optical inactivity, with the di(methylamide) which Hibbert and Anderson had obtained from sedoheptulosan. With this additional confirmatory evidence at hand, Hudson<sup>44</sup> then drew the following conclusion. "Assuming the correctness of XVIII for the configuration of sedoheptulose (from Ettel's work) and of the observation that tetramethylsedoheptulosan yields by oxidation trimethoxyriboglutaric acid (from the work of Hibbert and Anderson and of Levene and Compton) there is only one stereostructure that can apply to tetramethylsedoheptulosan, namely XXII, and there follows for sedoheptulosan necessarily the stereostructure XXI." This unusual structure contains an ethylene oxide ring and a septanoid ring, but no other interpretation is possible from the clearly established facts. Confirmatory evidence for the D-althroheptulose formula (XVIII) was supplied later by the oxidative degradation of sedoheptulose to D-altronic acid, as has been mentioned.<sup>38</sup> In conformity with formula XXI is also the fact that Hibbert and Anderson<sup>40</sup> could isolate only a monotrityl derivative of sedoheptulosan when they heated that substance in pyridine solution for one hour with two equivalents of trityl chloride.

## V. THE STRUCTURE OF D-ALTROSAN

Because sedoheptulose and altrose are converted to non-reducing anhydrides so readily in acid solution, and because sedoheptulose pos-

<sup>41</sup> W. N. Haworth and D. I. Jones, *J. Chem. Soc.*, 2352 (1927).

<sup>42</sup> F. B. La Forge, *J. Biol. Chem.*, **42**, 367 (1920).

<sup>43</sup> P. A. Levene and J. Compton, *J. Biol. Chem.*, **116**, 184 (1936).

<sup>44</sup> C. S. Hudson, *J. Am. Chem. Soc.*, **60**, 1241 (1938).

sesses the D-altrose configuration, it became of considerable interest to see whether D-altrosan also had an unusual ring system. Crystalline D-altrosan was prepared by Richtmyer and Hudson.<sup>46</sup> They oxidized the altrose component of an altrose-altrosan equilibrium mixture with bromine water in the presence of barium benzoate. After removal of benzoic acid, barium and bromine in the usual way, the D-altrosanic acid was separated as the calcium salt. The remaining material was a highly levorotatory sirup in which crystals first appeared after three years. The D-altrosan thus obtained melted between 80 and 90°, did not reduce Fehling solution, and when pure,<sup>46</sup> had  $[\alpha]_{D^{20}} - 213^\circ$  in water. A heated solution of D-altrosan in *N* hydrochloric acid became strongly reducing, and changed in rotation to  $[\alpha]_{D^{20}} - 98^\circ$ , calculated as altrose, in agreement with the rotation  $-98^\circ$  reported for D-altrose when heated with acid under the same conditions.

From the work of Robertson and his collaborators, which will be discussed in Section VII, evidence was already available to indicate that carbon atoms 2 and 3 were not involved in anhydride formation. Definitive proof of the ring structure of D-altrosan was presented by Richtmyer and Hudson.<sup>47</sup> Oxidation of this compound with periodic acid or with sodium metaperiodate consumed two equivalents of oxidizing agent and liberated one equivalent of formic acid. The resulting dialdehyde upon further oxidation with bromine water produced a dibasic acid which was isolated readily as a crystalline strontium salt of the composition  $C_5H_4O_6Sr \cdot 5H_2O$ . Of the many ring combinations possible for D-altrosan,  $C_6H_{10}O_6$ , only two could fulfill the requirements of reacting with two moles of periodic acid, with the elimination of one carbon atom as formic acid, and the subsequent formation of a dibasic acid containing the other five carbon atoms. These two possibilities are shown in formula XXVIII, analogous to formula XXVII for levoglucosan, and in formula XXIX, which has the unusual ring system of sedoheptulosan (XXI). The decision between formulas XXVIII and XXIX was easily made; the rotation of the aldehyde (XXX), the rotation of the strontium salt (XXXI) in water and in acid, the conversion of the strontium salt pentahydrate to the strontium salt monohydrate, and a determination of solubility of the monohydrate showed almost complete identity of data with those which Jackson and Hudson<sup>48</sup> had obtained by the oxidation of levoglucosan (XXVII) by periodic acid. The structure of the strontium salt (XXXI) from levoglucosan had been proved by Jackson and Hudson.

<sup>46</sup> N. K. Richtmyer and C. S. Hudson, *J. Am. Chem. Soc.*, **61**, 214 (1939).

<sup>46</sup> N. K. Richtmyer and C. S. Hudson, *J. Am. Chem. Soc.*, **62**, 963, footnote 16 (1940).

<sup>47</sup> N. K. Richtmyer and C. S. Hudson, *J. Am. Chem. Soc.*, **62**, 961 (1940).

<sup>48</sup> E. L. Jackson and C. S. Hudson, *J. Am. Chem. Soc.*, **62**, 958 (1940).



Although resistant to hydrolysis by acids, it could be degraded, with bromine water in the presence of strontium carbonate, to strontium oxalate and strontium D-glycerate (XXXII). Thus D-altrosan was found to have 1,5 and 1,6 rings like those in levoglucosan, in Micheel's galactosan, and in the more recently discovered mannosan.<sup>49</sup> To indicate that structure, it is named D-altrosan  $\langle 1,5 \rangle \beta \langle 1,6 \rangle$  or 1,6-anhydro-D-altropyranose.

The sedoheptulosan structure remains unique. Haskins, Hann and Hudson<sup>50</sup> have attempted to confirm formula XXI for that compound by oxidizing it with periodic acid and with sodium metaperiodate. Two equivalents of oxidant were consumed, one equivalent of formic acid was produced, and no formaldehyde could be detected in the oxidation mix-

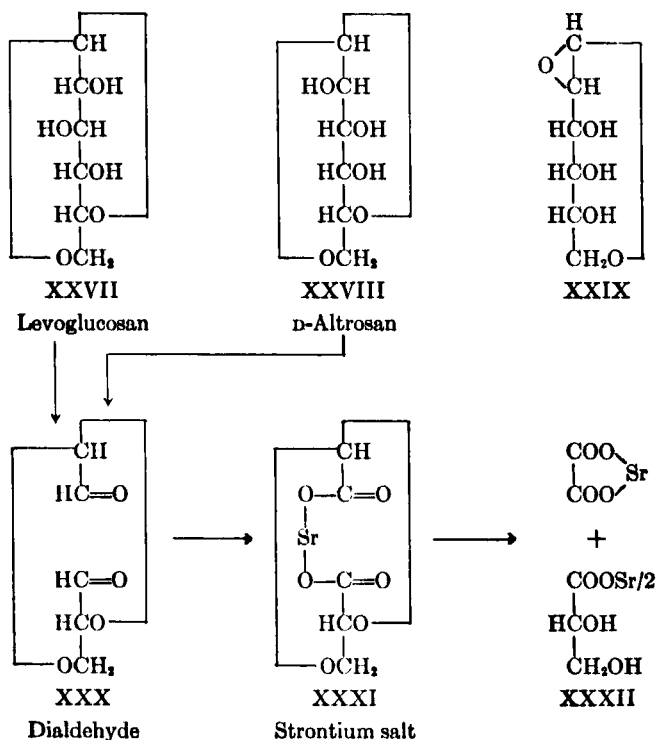

<sup>49</sup> A. E. Knauf, R. M. Hann and C. S. Hudson, *J. Am. Chem. Soc.*, **63**, 1447 (1941). Cf. G. Zemplén, Á. Gerecs and T. Valatin, *Ber.*, **73**, 575 (1940).

<sup>50</sup> W. T. Haskins, R. M. Hann and C. S. Hudson, unpublished results from the National Institute of Health, Bethesda, Maryland. The author is indebted to them for permission to summarize their experiments at this time. The study of the structure of sedoheptulosan is being continued.

ture. The dialdehyde was next oxidized with bromine water to a dibasic acid which crystallized as a calcium salt of the composition  $C_6H_6O_7Ca \cdot 3H_2O$ . These results allow only a combination of 2,3 and 2,7 or 2,6 and 2,7 rings. Unfortunately, no method has yet been found to distinguish between these possibilities. The acetal linkage in the oxidation products from sedoheptulosan is even more resistant to chemical agents than was the acetal linkage in XXXI from levoglucosan,<sup>48</sup> and neither the dialdehyde nor the dibasic acid appears to be hydrolyzed or degraded by any reagent which does not cause complete decomposition.

## VI. D-ALTROSE DERIVATIVES FROM D-ALTROSAN

Although D-altrose and its derivatives can now be made readily by the methods developed by Robertson and his collaborators, as will be described in the following section, some of these derivatives were prepared first from D-altrosan.<sup>51</sup> 2,3,4-Triacetyl-D-altrosan was obtained in a practically quantitative yield by the acetylation of D-altrosan with acetic anhydride in pyridine solution. The melting point and rotation of this compound, and of many other altrose derivatives, are recorded in Table I. Rupture of the 1,6-anhydride ring was next accomplished by acetolysis with a 2% solution of concentrated sulfuric acid in acetic anhydride. The product was an equilibrium mixture containing about 64%  $\alpha$ - and 36%  $\beta$ -pentaacetates. Pentaacetyl- $\alpha$ -D-altrose crystallized readily; the sirupy  $\beta$ -form could be rearranged to a similar equilibrium mixture and more crystalline  $\alpha$ -pentaacetate separated if desired.

Conversion of either pentaacetate to crystalline acetochloro- $\alpha$ -D-altrose was effected in good yield by the action of titanium tetrachloride in chloroform solution. Replacement of the chlorine atom by a hydroxyl group was accomplished by shaking the acetochloro compound with silver carbonate and aqueous acetone. The resulting tetraacetate appeared as the  $\beta$ -modification, mutarotating from  $[\alpha]_D^{20} - 6.0$  to  $+12.9^\circ$  in chloroform solution.

The  $\beta$ -tetraacetate, by etherification of the glycosidic hydroxyl group with methyl iodide and silver oxide, furnished a convenient source for the preparation of methyl tetraacetyl- $\beta$ -D-altroside; when mutarotation occurred before methylation, considerable methyl tetraacetyl- $\alpha$ -D-altroside was isolated. The latter was obtained also by rearrangement of the  $\beta$ -isomer with titanium tetrachloride. These methyl tetraacetylaltrosides do not contain orthoester linkages, and may be assumed to possess normal pyranoside rings. From the  $[\alpha]_D^{20}$  values of  $+66.0^\circ$  and  $-61.0^\circ$  in chloroform for the  $\alpha$ - and  $\beta$ -anomers, respectively, the value 2A for

<sup>51</sup> N. K. Richtmyer and C. S. Hudson, *J. Am. Chem. Soc.*, **63**, 1727 (1941).

the difference in molecular rotations was calculated as +46,000. The corresponding  $2A$  values for the other known pairs of methyl tetraacetyl-aldohexopyranosides are: glucose, +53,900; galactose, +53,500; gulose, +46,900; mannose, +36,100.

Methyl  $\alpha$ -D-altroside was first obtained in crystalline form, with m. p. 107–108°, and  $[\alpha]_D^{20} +126^\circ$  in water, by deacetylation of the tetraacetyl derivative described above. It is a pyranoside, for, upon oxidation according to the procedures of Jackson and Hudson,<sup>52</sup> it consumed two equivalents of periodic acid, liberated one equivalent of formic acid, and subsequent oxidation of the dialdehyde with bromine water and strontium carbonate produced the same strontium salt that had been obtained from the methyl  $\alpha$ -D-galactoside, glucoside, guloside and mannoside of known pyranoside ring structure.

### VII. D-ALTROSE FROM METHYL $\alpha$ -D-GLUCOSIDE

The late George J. Robertson and his collaborators have developed a very useful method of transforming glucose derivatives into altrose derivatives. In 1933, Mathers and Robertson,<sup>53</sup> in a projected synthesis of 4,6-dimethyl-D-glucose, attempted to remove the tosyl (*p*-toluene-sulfonyl) groups from methyl 2,3-ditosyl-4,6-dimethyl- $\alpha$ -D-glucoside. The hydrolysis of this compound with alcoholic alkali followed an unexpected course. One product was an anhydro derivative of a methyl dimethylhexoside; the other product likewise was not the expected methyl 4,6-dimethyl- $\alpha$ -D-glucoside, but an isomeric compound. For reasons set forth in the original article, the latter was judged to be methyl 4,6-dimethyl- $\alpha$ -D-altroside which had resulted from an inversion of configuration at the second and third carbon atoms of the glucose molecule.

In succeeding years a considerable number of papers have been written on Walden inversion and the formation of anhydro compounds in the sugar series. Since this material has been summarized fairly recently by Peat<sup>54</sup> and by Isbell,<sup>55</sup> the following discussion will be very limited in this respect.

With a view to the ultimate production of D-altrose in the free condition, Robertson and Griffith<sup>56</sup> in 1935 described the action of alkali upon methyl 2,3-ditosyl-4,6-benzylidene- $\alpha$ -D-glucoside (XXXIV), which is prepared readily from methyl  $\alpha$ -D-glucoside (XXXIII). The action of

<sup>52</sup> E. L. Jackson and C. S. Hudson, *J. Am. Chem. Soc.*, **59**, 994 (1937); **61**, 1532 footnote 8 (1939).

<sup>53</sup> D. S. Mathers and G. J. Robertson, *J. Chem. Soc.*, 1076 (1933).

<sup>54</sup> S. Peat, *Ann. Repts. Chem. Soc.*, **36**, 258 (1939).

<sup>55</sup> H. S. Isbell, *Ann. Rev. Biochem.*, **9**, 66 (1940).

<sup>56</sup> G. J. Robertson and C. F. Griffith, *J. Chem. Soc.*, 1193 (1935).

hot methyl alcoholic sodium methoxide produced a 35% yield of the primary product, of m. p. 200°, which they concluded must have the structure and configuration of methyl 2,3-anhydro-4,6-benzylidene- $\alpha$ -D-alloside (XXXV); the same compound was obtained in similar fashion from the corresponding 2-benzoyl-3-tosyl derivative. The general rule is that Walden inversion and ethylene oxide ring formation will occur only when the original two adjacent hydroxyl groups are *trans* to each other. The further action of sodium methoxide upon XXXV was to

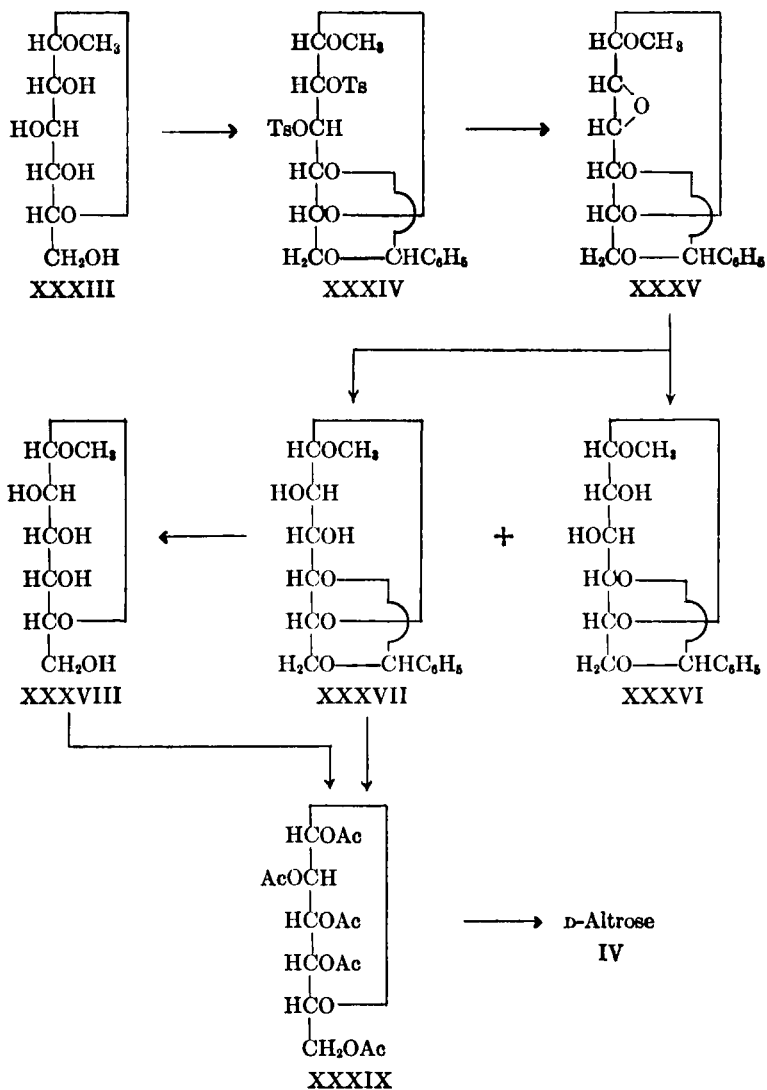

open the ethylene oxide ring with the simultaneous introduction of a methoxyl group. However, with hot, aqueous potassium hydroxide in a sealed tube, Robertson and Griffith were able to add H and OH to the oxide ring and to isolate methyl 4,6-benzylidene- $\alpha$ -D-altroside (XXXVII) in good yield. Later, Robertson and Whitehead<sup>57</sup> carried out this step simply by boiling with caustic alkali. Richtmyer and Hudson<sup>51</sup> have modified the preparation of the anhydro compound (XXXV) by using sodium methoxide and chloroform at refrigerator temperature, and the yield became practically quantitative. Working on a larger scale they showed that both altroside (XXXVII) and glucoside (XXXVI) derivatives are formed by opening the ethylene oxide ring with caustic potash. Fortunately, at least 85% of the total product is the desired altroside.

Robertson and Griffith removed the benzylidene group from XXXVII by mild acid hydrolysis and thus completed the first transformation of methyl  $\alpha$ -D-glucoside to methyl  $\alpha$ -D-altroside (XXXVIII), although the latter compound was not crystallized until later.<sup>51</sup> Removal of the altrosidic methyl group by hydrolysis with stronger acid did not lead to the free sugar, D-altrose (IV), but to a mixture which they recognized as containing an anhydro-sugar in equilibrium with a small amount of reducing sugar. The specific rotation of their solution,  $-98^\circ$  calculated as D-altrose, was identical with the value obtained independently and practically simultaneously by Richtmyer and Hudson<sup>16</sup> from the action of acid on crystalline D-altrose. Robertson and Griffith suggested that anhydride formation must involve position 4 or 6, since only these positions are available in 2,3-dimethylaltrose which also forms an anhydride. The suggestion was confirmed later<sup>58</sup> by the fact that methyl 4,6-dimethyl- $\alpha$ -D-altroside is hydrolyzed in normal fashion without anhydride formation. The choice of position 6, and conclusive proof of the ring structure of the anhydride, D-altrosan,<sup>47</sup> have been discussed in a preceding section.

Since acid hydrolysis of methyl  $\alpha$ -D-altroside leads principally to D-altrosan, it became necessary to resort to other devices in order to complete the transformation to the free sugar. The pioneer work of Robertson and his collaborators had established a clear route from D-glucose to many D-altrose derivatives. The final steps, as described by Richtmyer and Hudson,<sup>18</sup> are the acetylation of methyl  $\alpha$ -D-altroside (XXXVIII), or more simply of its benzylidene derivative (XXXVII), followed by catalytic deacetylation of the pentaacetyl- $\alpha$ -D-altrose thus produced. In this way crystalline D-altrose becomes readily available.

<sup>57</sup> G. J. Robertson and W. Whitehead, *J. Chem. Soc.*, 319 (1940).

<sup>58</sup> G. J. Robertson and H. G. Dunlop, *J. Chem. Soc.*, 472 (1938).

## VIII. EPIGLUCOSAMINE AND OTHER ALTROSE DERIVATIVES

As mentioned previously, Robertson and Griffith<sup>56</sup> found that alkali converts methyl 2-benzoyl-3-tosyl-4,6-benzylidene- $\alpha$ -D-glucoside (XL) to an anhydro compound, of m. p. 200°, to which they assigned the configuration of a 2,3-anhydroalloside (XXXV). On the other hand, methyl 2-tosyl-3-benzoyl-4,6-benzylidene- $\alpha$ -D-glucoside (XLII) was converted by alkali to an isomeric anhydro compound, of m. p. 147°; to this was assigned the 2,3-anhydromannoside configuration XLIII. It is now well established in such cases that Walden inversion occurs at the carbon atom which lost the tosyl group, and that the oxygen atom appears on the opposite side of the carbon chain. When both the 2- and 3-positions of the glucoside were occupied by tosyl groups in a *trans* relation as in XXXIV, it seems necessary to assume that with alkali the 2-tosyl is eliminated more readily, and that the resulting 3-tosyl derivative is then converted into the anhydroalloside (XXXV).

In opening the ethylene oxide ring of the methyl anhydroalloside (XXXV) with hot aqueous alkali, we recall that the principal product was the altroside (XXXVII), although a small amount of glucoside (XXXVI) was obtained also; an inversion had occurred at either the second or third carbon atom, depending upon the product formed. The same altroside (XXXVII) was also the principal product from the action of aqueous alkali upon the anhydromannoside (XLIII). However, when

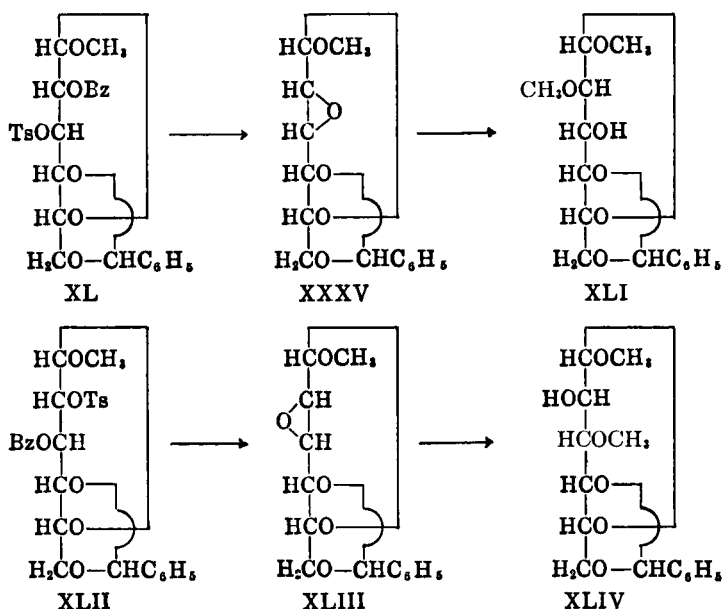

the ethylene oxide ring is opened by other reagents, only one free hydroxyl group is generated, the second potential hydroxyl being substituted or replaced. Thus, the action of sodium methoxide upon the anhydroalloside (XXXV) yielded principally the 2-methylaltroside (XLI); from the anhydromannoside (XLIII) the principal product was the 3-methylaltroside (XLIV).<sup>56</sup> In each case an altrose configuration is established preferentially, although we should expect to find small amounts of the corresponding 3-methylglucoside and 2-methylglucoside derivatives, respectively.

After this brief discussion of the formation and cleavage of ethylene oxide rings, we shall proceed to "methyl epiglucoamine," which is methyl 3-amino- $\beta$ -D-altroside<sup>58a</sup> (XLVII), the first altrose derivative to be produced from glucose by chemical transformations. Fischer, Bergmann and Schotte<sup>59</sup> had added chlorine to the ethylenic linkage of triacetylglucal, and then heated the dichloride with methyl alcohol and silver carbonate. Deacetylation of the resulting compound yielded a crystalline "methylglucoside-2-chlorohydrin," of  $[\alpha]_D^{18} - 12.1^\circ$  in water; from a consideration of its properties, manner of formation, and reactions, it may be represented as methyl 2-chloro- $\beta$ -D-glucoside<sup>58a</sup> (XLV). When the 2-chloroglucoside was heated at  $100^\circ$  under pressure with 25% aqueous ammonia for twelve to fifteen hours, and then concentrated, "methyl epiglucoamine hydrochloride," of  $[\alpha]_D^{19} - 147^\circ$  in water, was isolated in a 58% yield. Although the free base did not crystallize, it was characterized further as a crystalline hydrobromide and as a crystalline tetraacetate. These compounds being different from the known isomeric glucosamine derivatives, Fischer named them as derivatives of "epiglucoamine," with the reservation that the two bases need not be related as epimers in the usual sense. The authors suggested also that the first action of ammonia might be to eliminate the halogen acid, with carbon atom 2 forming an ethylene oxide type of ring with one of the other carbon atoms. Opening the new ring with ammonia might then result in the amino group being joined to a different carbon atom, *e.g.*, at position 3, with a hydroxyl group appearing on carbon atom 2.

Fischer, Bergmann and Schotte had reported that "methyl epiglucoamine" was hydrolyzed by acids to a reducing sugar only with great difficulty. Levene and Meyer<sup>60</sup> found that hydrolysis occurred readily enough, but the free sugar was transformed rapidly to a non-

<sup>58a</sup> Throughout this review the shorter terms 3-amino-, 2-chloro-, etc. have been used instead of 3-desoxy-3-amino-, 2-desoxy-2-chloro-, etc. to indicate the replacement of a hydroxyl group by the atom or group named.

<sup>59</sup> E. Fischer, M. Bergmann and H. Schotte, *Ber.*, **53**, 509 (1920).

<sup>60</sup> P. A. Levene and G. M. Meyer, *J. Biol. Chem.*, **55**, 221 (1923).

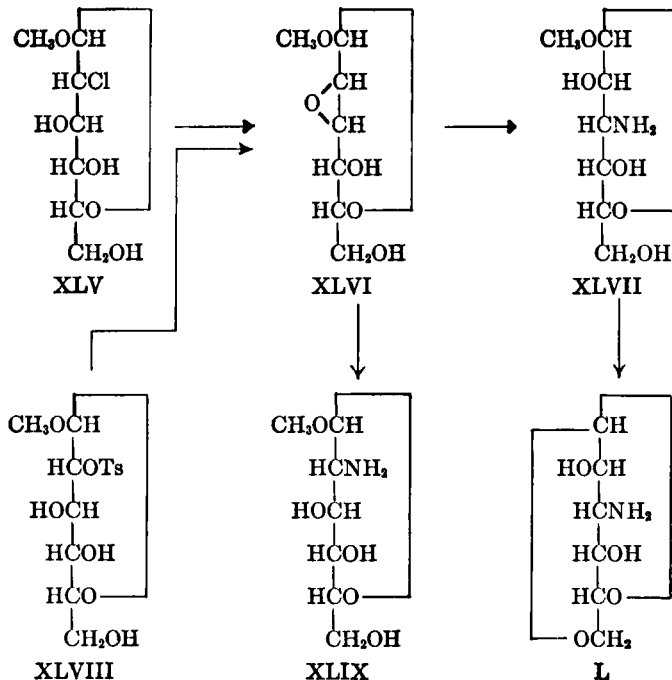

reducing "anhydro-epiglucosamine." On hydrolysis with dilute acid they obtained an equilibrium mixture which contained 60% of the free sugar, calculated as glucose. From this they prepared a phenylosazone with five atoms of nitrogen in the molecule. Hence, they concluded, the amino group is evidently in position 3, and "epiglucosamine" may have an allose, altröse, glucose or mannose configuration. "Anhydro-epiglucosamine" was isolated as a crystalline hydrochloride, of m. p. 216° and  $[\alpha]_D^{20} - 172^\circ$  in 2.5% hydrochloric acid.

Three years later, Freudenberg, Burkhart and Braun<sup>61</sup> heated 3-tosyl-1,2:5,6-diisopropylidene-D-glucufuranose with alcoholic ammonia at 170°, thereby replacing the tosyl group by an amino group. Since an ethylene oxide ring could not be formed, no inversion was expected and the compound liberated subsequently by mild acid hydrolysis was believed to be 3-amino-D-glucose. The allocation of the amino group to carbon atom 3 in "epiglucosamine" and the assumed unchanged configurations of carbon atoms 4 and 5 were confirmed by dissolving the analogous hydrazino derivative in concentrated hydrochloric acid. The resulting product was identical with the optically active trihydroxypyrazole which Freudenberg

<sup>61</sup> K. Freudenberg, O. Burkhart and E. Braun, *Ber.*, 59, 714 (1926).



berg and Doser<sup>62</sup> had obtained previously from 3-hydrazino-D-glucose. The phenylosazones of 3-amino-D-glucose and "epiglucosamine" were found not to be identical, hence those sugars must have opposite configurations at carbon 3, and "epiglucosamine" was believed to be 3-amino-D-allose or 3-amino-D-altrose. Freudenberg, Burkhart and Braun chose the altrose configuration with the following explanation. In the chlorohydrin (XLV) the configuration of carbon atom 3 is certain. The linkage between this atom and its oxygen atom is not attacked during the formation of the ethylene oxide, which, consequently, should have the mannose configuration XLVI. In the transformation of XLVI to XLVII, the ethylene oxide ring is opened at carbon atom 3; the configuration of carbon atom 2 is retained, while carbon atom 3 probably assumes the reverse arrangement, since ethylene oxide rings usually behave in this way. On the basis of this reasoning, "methyl epiglucosamine" could be written as methyl 3-amino- $\beta$ -D-altroside (XLVII); the  $\beta$ -configuration was not specified by any of the above authors, although such an assumption would be natural in view of its high levorotation and its method of preparation. If this derivation of the formula of "epiglucosamine" is correct, then the compound of Freudenberg, Burkhart and Braun, which differs from it only in the configuration of carbon 3, was formulated correctly as 3-amino-D-glucose.

The configuration of the glycosidic group in Brigl's methyl 3,4,6-triacetyl- $\beta$ -D-glucoside has been established through its degradation to methyl  $\beta$ -D-glucoside.<sup>63</sup> In 1934, Bodycote, Haworth and Hirst<sup>64</sup> transformed the triacetyl derivative, in two steps, to methyl 2-tosyl- $\beta$ -D-glucoside (XLVIII). By heating the tosyl compound with methyl alcoholic ammonia they obtained a sirup from which they isolated a 40% yield of "methyl epiglucosamine" as the crystalline hydrochloride. Thus the  $\beta$ -configuration of the glycosidic linkage in the amino compound also seems certain. Although they isolated no intermediate in the above reaction, they believed that it must proceed by way of the same methyl 2,3-anhydro- $\beta$ -D-mannoside (XLVI) as did the original transformation from methyl 2-chloro- $\beta$ -D-glucoside (XLV).

It is of interest to note that the second product to be expected from the addition of ammonia to the anhydromannoside (XLVI), by opening the ethylene oxide ring at carbon atom 2, would be methyl 2-amino- $\beta$ -D-glucoside (XLIX). In order to decide whether chitosamine (glucosamine) has a 2-aminoglucose or 2-aminomannose configuration, Haworth,

<sup>62</sup> K. Freudenberg and A. Doser, *Ber.*, **56**, 1243 (1923).

<sup>63</sup> P. Brigl, *Z. physiol. Chem.*, **122**, 245 (1922).

<sup>64</sup> E. W. Bodycote, W. N. Haworth and E. L. Hirst, *J. Chem. Soc.*, 151 (1934).

Lake and Peat<sup>65</sup> carried out the following investigation. The 4- and 6-OH groups in the anhydromannoside (XLVI) were protected by methylation, and the compound was then heated under pressure with methyl alcoholic ammonia. The resulting sirup contained two isomeric substances which could be separated by means of their crystalline N-acetyl derivatives. One of these, representing 90% of the total product, upon further methylation was identified as methyl 2,4,6-trimethyl-3-acetamino- $\beta$ -D-altroside by direct comparison with fully methylated N-acetyl "epiglucosamine." In accordance with the general theories of ring opening, the second substance, representing the other 10% of the total, must be a derivative of 2-amino-D-glucose. The fully methylated product, methyl 3,4,6-trimethyl-2-acetamino- $\beta$ -D-glucoside was identical with completely methylated N-acetyl-chitosamine (glucosamine). From this it follows that the parent sugar is 2-amino-D-glucose as implied by the original name, glucosamine.

Myers and Robertson,<sup>66</sup> and Robertson, Myers and Tetlow,<sup>67</sup> have reported a synthesis of "methyl epiglucosamine" starting with methyl 2,3-anhydro-4,6-benzylidene- $\alpha$ -D-mannoside (XLIII). By opening the ethylene oxide ring with ammonia they obtained a crystalline product, of m. p. 188° and  $[\alpha]_D^{19} + 88.9^\circ$  in chloroform, which was a mixture of two substances. Although these substances could not be separated at this stage, the product was proved to contain 99% of the methyl 3-amino-4,6-benzylidene- $\alpha$ -D-altroside and only 1% of the methyl 2-amino-4,6-benzylidene- $\alpha$ -D-glucoside. When the mixture was refluxed with aqueous 1% hydrochloric acid for eighteen hours, a constant rotation was reached, and the benzylidene group was removed. They reported that a 76% yield of a methyl 3-amino-D-altroside was isolated, and identified as "methyl epiglucosamine hydrochloride" by its m. p. of 209° (decomp.) and  $[\alpha]_D^{18} - 149^\circ$  in water. The compound appeared to be a  $\beta$ -altroside derivative which had been formed by heating an  $\alpha$ -altroside derivative with dilute aqueous hydrochloric acid. The reason for such a unique inversion of configuration at carbon atom 1 is not apparent. It is also not clear why the substituted methyl altroside did not lose its methyl group under such conditions of acid hydrolysis, inasmuch as Levene and Meyer<sup>60</sup> and also Bodycote, Haworth and Hirst<sup>64</sup> hydrolyzed "methyl epiglucosamine hydrochloride" to "epiglucosamine" by boiling with 0.5% hydrochloric acid for only eight hours.

The ring structure of "anhydro-epiglucosamine hydrochloride" has

<sup>65</sup> W. N. Haworth, W. H. G. Lake and S. Peat, *J. Chem. Soc.*, 271 (1939).

<sup>66</sup> W. H. Myers and G. J. Robertson, *J. Am. Chem. Soc.*, 65, 8 (1943).

<sup>67</sup> G. J. Robertson, W. H. Myers and W. E. Tetlow, *Nature*, 142, 1076 (1938).

not been determined. By analogy with *D*-altrosan (XXVIII), the "anhydro-epiglucosamine" may be presumed to be a 1,6-anhydride (L).

In addition to the transformations of *D*-glucose to *D*-altrose and its derivatives which have been described in most of the references between 53 and 67, similar transformations may be found in articles by Haworth, Hirst and Panizzon,<sup>68</sup> by Peat and Wiggins,<sup>69</sup> by Lake and Peat,<sup>70</sup> by Robertson and Myers,<sup>71</sup> and by Young and Elderfield.<sup>72</sup> Data on all these derivatives are reported in Table I.

### IX. THE 6-DESOXYALTROSES

Another type of transformation of one hexose into another was described in 1929 by Freudenberg and Raschig.<sup>73</sup> The 6-iodo derivative of diacetone galactose, written below as 1,2:3,4-diisopropylidene-6-iodo-*D*-galactose (LI), was heated with sodium methoxide at 130°, and a crystalline ethylenic compound (LII) was obtained. Hydrogenation of this substance in the presence of platinum black yielded a sirup which should contain the two isomers LIII and LV, the relative amount of each depending upon the way in which the hydrogen had been added to the double bond. After removing the acetone groups by gentle acid hydrolysis, they estimated that the resulting mixture contained 70–80% of *D*-fucose (6-desoxy-*D*-galactose) (LVI), which was isolated and identified through its *p*-toluenesulfonylhydrazone. The other 20–30% of the product was a new sugar, 6-desoxy-*L*-altrose (*L*-altromethylose) (LIV); it was separated as the *p*-bromophenylhydrazone, and characterized further by other hydrazone and osazone derivatives (see Table I). Regenerated from its hydrazone, the free 6-desoxy-*L*-altrose (LIV) was obtained as a sirup, with  $[\alpha]_D^{20} - 18^\circ$  in water.

The 2-methyl derivative of 6-desoxy-*D*-altrose has been prepared by Young and Elderfield<sup>72</sup> in connection with their studies on digitalose; the latter sugar was identified recently by Schmidt, Mayer and Distelmaier<sup>74</sup> as 3-methyl-6-desoxy-*D*-galactose (3-methyl-*D*-fucose). Young and Elderfield started with the methyl 2-methyl- $\alpha$ -*D*-altroside of Robertson and Griffith,<sup>56</sup> which is prepared readily from compound XLI, and, by tritylation and acetylation, converted it to the crystalline methyl 2-methyl-3,4-

<sup>68</sup> W. N. Haworth, E. L. Hirst and L. Panizzon, *J. Chem. Soc.*, 154 (1934).

<sup>69</sup> S. Peat and L. F. Wiggins, *J. Chem. Soc.*, (a) 1088 (1938); (b) 1810 (1938).

<sup>70</sup> W. H. G. Lake and S. Peat, *J. Chem. Soc.*, 1417 (1938); 1069 (1939).

<sup>71</sup> G. J. Robertson and W. H. Myers, *Nature*, **143**, 640 (1939).

<sup>72</sup> F. G. Young, Jr. and R. C. Elderfield, *J. Org. Chem.*, **7**, 241 (1942).

<sup>73</sup> K. Freudenberg and K. Raschig, *Ber.*, **62**, 373 (1929).

<sup>74</sup> O. T. Schmidt, W. Mayer and A. Distelmaier, *Naturwissenschaften*, **31**, 247 (1943); *Ann.*, **555**, 26 (1943).

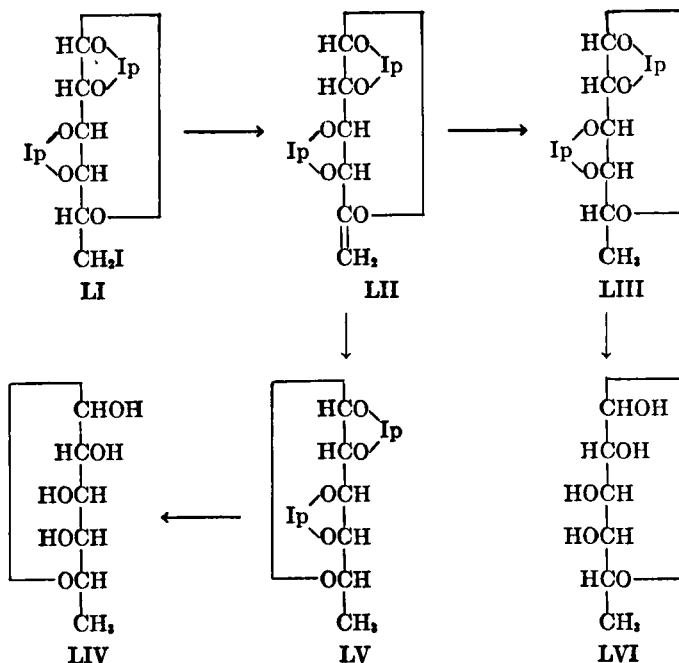

diacetyl-6-trityl- $\alpha$ -D-altroside. The 6-trityl group was removed, a 6-tosyl group was introduced, and this in turn was replaced by the usual methods to form the crystalline methyl 2-methyl-3,4-diacetyl-6-iodo- $\alpha$ -D-altroside. Deacetylation, followed by removal of the iodine by hydrogenation in the presence of Raney nickel and alkali, yielded methyl 2-methyl-6-desoxy- $\alpha$ -D-altroside as a colorless, hygroscopic sirup, with  $[\alpha]_{\text{D}}^{25} +91.1^\circ$  in water. The altroside was hydrolyzed with acid to the free sugar, 2-methyl-6-desoxy-D-altrose (2-methyl-D-altromethylose) (LVII), which was a strongly reducing sirup, with  $[\alpha]_{\text{D}}^{25} +11.8^\circ$  in water. Although five different hydrazones were prepared, none was obtained in crystalline form.

There are two other known sugars closely related to 6-desoxy-D-altrose; because they are at the same time 2-desoxy sugars, they are related equally to D-allose, and may be named accordingly. Digitoxose, a sugar component of several digitalis glycosides, was shown by Micheel<sup>76</sup> to be 2,6-dideoxy-D-allose (2,6-dideoxy-D-altrose; 2-desoxy-D-allomethylose; 2-desoxy-D-altromethylose) (LVIII). Cymarose occurs as a sugar component in several cardiac glycosides from other sources; Elder-

<sup>76</sup> F. Micheel, *Ber.*, **63**, 347 (1930).

field<sup>76</sup> has proved it to be 3-methyl-2,6-dideoxy-D-allose (LIX). Cymarose is thus the 3-methyl ether of digitoxose. An extended account of these substances appears in an accompanying review by Dr. Robert C. Elderfield (see p. 147).

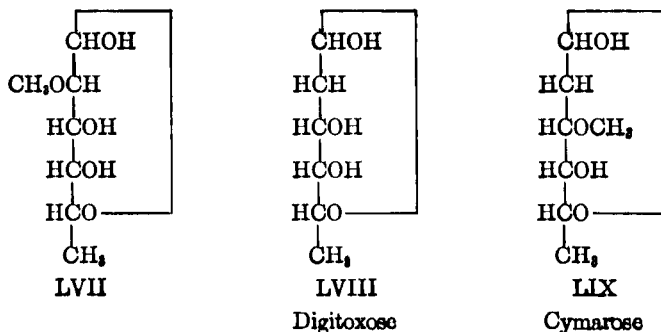

### X. THE ALLULOSES

Both D- and L-forms of the ketohexose related equally to altrose and allose are known. In conformity with the present system of nomenclature for ketone sugars, the name allulose is used in preference to the older terms pseudofructose,<sup>76a</sup> psicose, 2-ketoribohexose, etc.

L-Allulose (LXI) was prepared by Steiger and Reichstein<sup>77</sup> through the oxidative fermentation of allitol (LX) by the sorbose bacterium, *Acetobacter xylinum*. The product was isolated and purified by means of its crystalline diacetone derivative, of m. p. 57° and  $[\alpha]_{\text{D}}^{20} + 99^\circ$  in acetone. To the latter compound was assigned the 1,2:3,4-diisopropylidene-L-allulofuranose structure LXII because it could be oxidized by alkaline permanganate to a crystalline uronic acid (LXIII) which, from its behavior, must have the carboxyl group in the 6- and not the 1-position. After removal of the isopropylidene groups from LXII, the free sugar, L-allulose (LXI), was obtained as a colorless sirup with  $[\alpha]_{\text{D}}^{21} - 3.3^\circ$  in water. It is not fermented by yeast.

From L-allulose Steiger<sup>78</sup> prepared the phenylosazone (L-allose phenylosazone),<sup>18</sup> which was hydrolyzed to L-allosone (LXIV) by means of benzaldehyde. The addition of hydrocyanic acid to the osone, followed by saponification with hydrochloric acid, then yielded crystalline L-alloascorbic acid (LXV), of m. p. 177° (decomp.) and  $[\alpha]_{\text{D}}^{21} + 29.3^\circ$  in 0.01 N hydrochloric acid. The compound presumably had little if

<sup>76</sup> R. C. Elderfield, *Science*, **81**, 440 (1935); *J. Biol. Chem.*, **111**, 527 (1935).

<sup>76a</sup> C. A. Lobry de Bruyn and W. Alberda van Ekenstein, *Rec. trav. chim.*, **16**, 258, 274 (1897).

<sup>77</sup> Marguerite Steiger and T. Reichstein, *Helv. Chim. Acta*, **18**, 790 (1935).

<sup>78</sup> Marguerite Steiger, *Helv. Chim. Acta*, **18**, 1252 (1935).

any vitamin C activity since the author stated that the D-alloascorbic acid would be more interesting because it would be expected to show antiscorbutic activity.

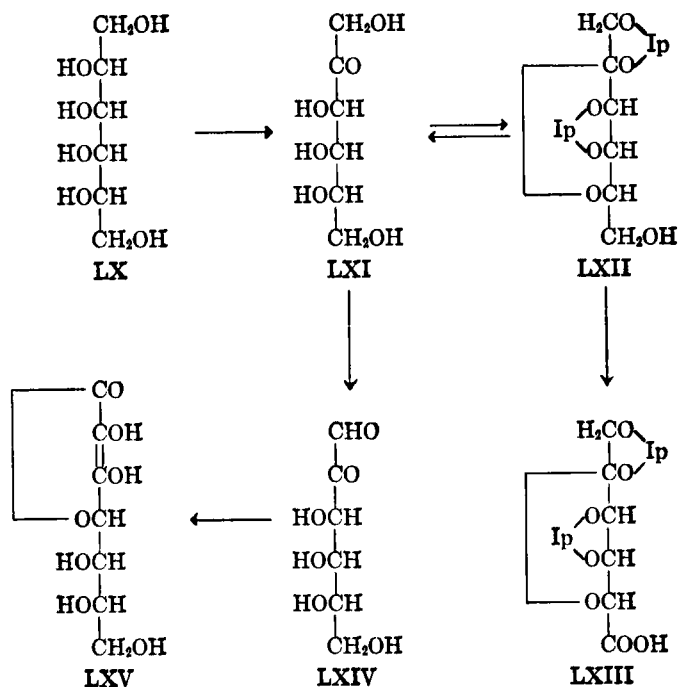

In the following year Steiger and Reichstein<sup>7</sup> reported also the preparation of D-allulose through the partial rearrangement of D-allose (V) in anhydrous pyridine according to the procedure developed by Fischer, Taube and Baer and by Danilow, Venus-Danilowa and Schantarowitsch.<sup>79</sup> An equilibrium mixture was thus obtained from which a part of the unchanged D-allose was recovered by crystallization, and the rest was removed by oxidation with bromine water and subsequent precipitation of the barium D-allonate. From the resulting sirup, D-allulose was isolated as the crystalline diisopropylidene-D-allulofuranose, of m. p. 58° and  $[\alpha]_{D^{20}} -98^\circ$  in acetone as would be expected for the enantiomorph of LXII. D-Allulose, regenerated by mild acid hydrolysis of the diisopropylidene derivative, was a sirup, not fermentable by yeast. Its specific rotation,  $[\alpha]_{D^{20}} +3.1^\circ$  in water, was in good agreement with the value  $-3.3^\circ$  for the enantiomorph LXI.

<sup>79</sup> H. O. L. Fischer, C. Taube and E. Baer, *Ber.*, **60**, 479 (1927); S. Danilow, E. Venus-Danilowa and P. Schantarowitsch, *ibid.*, **63**, 2269 (1930).

Zerban and Sattler<sup>80</sup> have isolated D-allulose from "distillery slop," the unfermentable residue remaining from the industrial fermentation of cane molasses to produce ethyl alcohol. After establishing the ketose nature of the unfermentable reducing sugar, the authors prepared from it a phenylosazone which was identical with the phenylosazones from D-allose and D-altrose. Consequently the ketose must be D-allulose. This was confirmed through preparation of an isopropylidene derivative which, although not crystalline, was hydrolyzed by dilute acid to a sirupy sugar whose  $[\alpha]_D^{20}$  value,  $+2.9^\circ$  in water, was in close agreement with the value  $+3.1^\circ$  recorded previously for D-allulose by Steiger and Reichstein.<sup>7</sup>

Wolfrom and Evans<sup>81</sup> have reported the synthesis of several unusual derivatives of D-allulose starting with the reaction of diazomethane with tetraacetyl-D-ribonyl chloride. The product was tetraacetyl-1-diazo-1-desoxy-*keto*-D-allulose, light yellow crystals with m. p.  $73-75^\circ$ , and  $[\alpha]_D^{28} +2.0^\circ$  in chloroform. Acetic acid eliminated the nitrogen atoms, and formed pentaacetyl-*keto*-D-allulose, m. p.  $63-65^\circ$  and  $[\alpha]_D^{29} -21.5^\circ$  in chloroform. Reduction of the diazo compound with hydriodic acid yielded tetraacetyl-1-desoxy-*keto*-D-allulose, m. p.  $75-77^\circ$  and  $[\alpha]_D^{28} -47^\circ$  in chloroform.

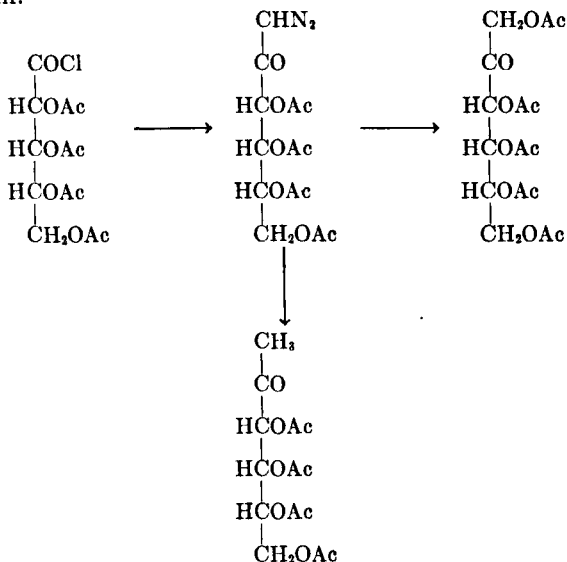

<sup>80</sup> F. W. Zerban and L. Sattler, *J. Assoc. Official Agr. Chem.*, **24**, 657 (1941); *J. Am. Chem. Soc.*, **64**, 1740 (1942); *Ind. Eng. Chem.*, **34**, 1180 (1942).

<sup>81</sup> M. L. Wolfrom and E. F. Evans, in a paper presented before the Division of Sugar Chemistry and Technology at the Pittsburgh meeting of the American Chemical Society, September 6-10, 1943. Also, E. F. Evans, Dissertation, The Ohio State University (1943).

## XI. CALCIUM D-ALTRONATE FROM D-GALACTOSE AND FROM PECTIN

In the synthesis of D-altrose from D-ribose, first effected by Levene and Jacobs,<sup>1</sup> the only crystalline intermediate was the characteristic calcium D-altronate  $\cdot 3.5 \text{ H}_2\text{O}$ . The sirupy lactone prepared from it was then reduced to D-altrose with sodium amalgam, as mentioned earlier in this review. Calcium D-altronate has been obtained from other sources also, such as the aluminum chloride rearrangement of the acetates of lactose, cellobiose and glucose and subsequent transformation of the neolactose, celtribiose and altrose derivatives thus produced (see Section III); and from the oxidative degradation of sedoheptulose (see Section IV). Calcium D-altronate may be converted not only to D-altrose, but it may serve also as a source of D-ribose if the cost of preparing ribose by other methods should make this desirable. The degradation of calcium D-altronate to D-ribose by means of hydrogen peroxide in the presence of ferric acetate as a catalyst has been described by Hudson and Richtmyer.<sup>82</sup>

In their transformation of D-galactose to calcium D-altronate, Steiger and Reichstein<sup>83</sup> heated D-galactonic acid (LXVI) in aqueous pyridine for two days, removed the unchanged D-galactonic acid as barium and cadmium salts, and then separated D-talonic acid (VI) as the crystalline potassium salt, according to Bosshard.<sup>84</sup> By the action of nitric acid, 128 g. of pure D-talonic acid was oxidized to D-talomucic acid (VII); of this, 16.5 g. was isolated as the crystalline acid, 11.5 g. as a dextrorotatory lactone, and 38.5 g. as a levorotatory lactone. The lactones were considered to be  $\gamma$ -lactones because of their slow mutarotation in aqueous solution; both lactones and the acid were interconvertible, and reached the same final equilibrium rotation in about 60 days at room temperature. The dextro-lactone was proved to be D-talomucic 3,6-lactone (LXVII) because it could be converted by energetic reduction with sodium amalgam to D-talonic acid (VI), presumably by way of the intermediate D-altruronic acid (LXX). Similarly, the levo-lactone must have been D-talomucic 1,4-lactone (LXVIII) because it was reduced, through the assumed D-taluronic acid (LXIX), to D-altronic acid (II); the latter was isolated as calcium D-altronate, and identified by its characteristic mutarotation in *N* hydrochloric acid.

<sup>82</sup> C. S. Hudson and N. K. Richtmyer, U. S. Pat. 2,162,721, June 20, 1939; see also reference 20, p. 2536.

<sup>83</sup> Marguerite Steiger and T. Reichstein, *Helv. Chim. Acta*, 19, 195 (1936).

<sup>84</sup> W. Bosshard, *Helv. Chim. Acta*, 18, 482 (1935).



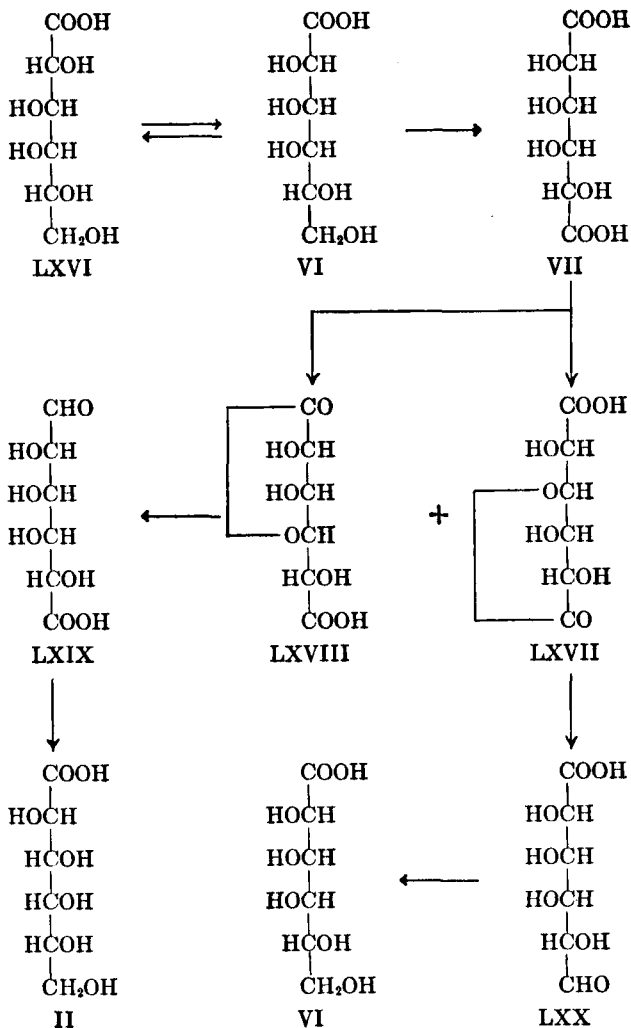

Another transformation of D-galactose to calcium D-altronate has been carried out by Reichstein and Bosshard.<sup>85</sup> They heated 100 g. of D-galactose (LXXI) in anhydrous pyridine for five hours to effect partial rearrangement.<sup>79</sup> From the mixture, they recovered 80 g. of crystalline D-galactose, removed the rest of it by fermentation, and obtained finally about 6.5 g. of pure D-tagatose (LXXII). This ketose formed a crystalline diisopropylidene derivative (LXXIII) which could be oxidized by alkaline permanganate to diisopropylidene-D-tagaturonic acid (LXXIV).

<sup>85</sup> T. Reichstein and W. Bosshard, *Helv. Chim. Acta*, 17, 753 (1934).

The removal of acetone by hydrolysis would then yield D-tagaturonic acid (LXXVa), which may also be named 5-keto-L-galactonic acid or 5-keto-D-altronic acid, as is shown readily by turning the formula 180° to LXXVb. Hydrogenation of the keto acid would be expected to furnish two isomeric hexonic acids, depending upon the way in which hydrogen added to the carbon-oxygen double bond. Reichstein and Bosshard heated the diisopropylidene derivative (LXXIII) with hydrogen and a nickel catalyst under pressure, so that the acetone groups were removed and hydrogenation occurred simultaneously. From the reaction mixture, L-galactonic acid (LXXVI) was isolated as the cadmium

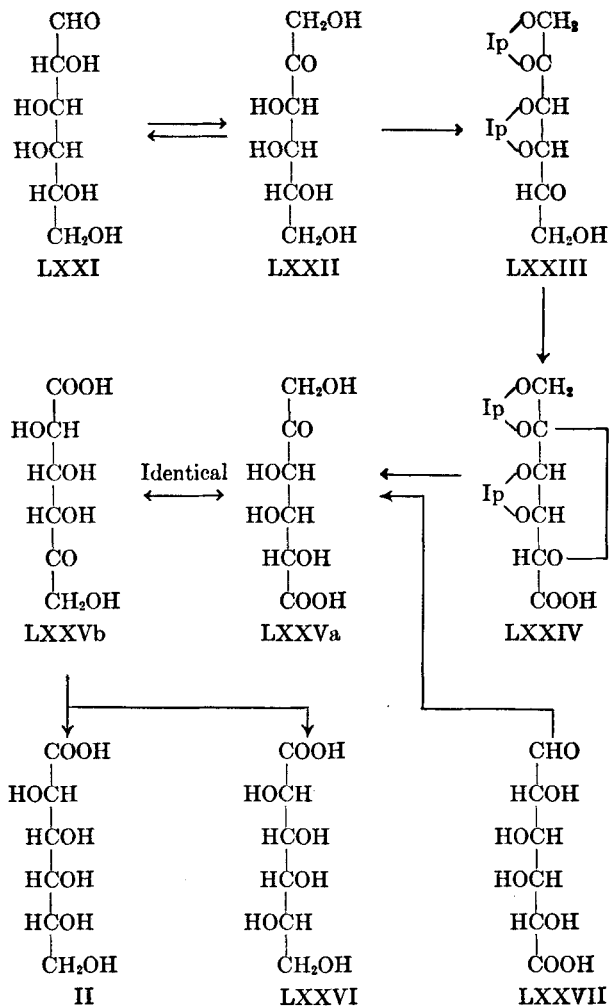

salt, which was decomposed with hydrogen sulfide and converted to the crystalline L-galactonic amide for further identification. The cadmium salts in the mother liquor were converted to calcium salts, and the resulting crystalline product was assumed to be the calcium salt of D-altronic acid (II).

The hydrogenation of free 5-keto-L-galactonic acid (LXXV) has been described in a patent issued to Hoffmann-La Roche and Co.<sup>86</sup> One part of the acid was dissolved in 3 parts of water, 7 parts of glacial acetic acid and 0.05 part of platinum oxide were added, and the hydrogenation was carried out in an autoclave with vigorous stirring for four hours at 120–140°, with an initial hydrogen pressure of about 50 atmospheres. The platinum was removed by filtration, the acid by distillation *in vacuo*, and the mixture of L-galactonic and D-altronic acids was separated as the cadmium and calcium salts, respectively.

Regna and Caldwell<sup>87</sup> have published a method for the preparation of large quantities of calcium D-altronate which appears to be more satisfactory than any of the methods described previously. Commercial citrus pectin, or other suitable pectin-containing material, was hydrolyzed with commercial pectinase by a modification of the methods of Mottern and Cole<sup>88</sup> and of Pigman.<sup>89</sup> The D-galacturonic acid (LXXVII) thus liberated was converted to the less soluble and readily crystallized sodium calcium D-galacturonate.<sup>90</sup> Ehrlich and Guttman<sup>91</sup> had found earlier that saturated limewater effects a Lobry de Bruyn rearrangement of D-galacturonic acid (LXXVII) to 5-keto-L-galactonic acid (D-tagaturonic acid) (LXXV); the yield of basic calcium 5-keto-L-galactonate is practically quantitative because the equilibrium readjusts itself continuously until the sparingly soluble calcium salt ceases to precipitate. Regna and Caldwell were successful in converting the basic calcium salt to a crystalline neutral calcium 5-keto-L-galactonate. Upon reduction of the latter with hydrogen and Raney nickel, the calcium salts of D-altronic acid (II) and L-galactonic acid (LXXVI) were obtained in good yield and in about equal amounts. The interest in L-galactonic acid also has been heightened by the recent announcement of its transformation to

<sup>86</sup> F. Hoffmann-La Roche and Co. Akt.-Ges. in Basel, Switzerland, German Pat. 618,907 (Sept. 19, 1935).

<sup>87</sup> P. P. Regna and B. P. Caldwell, *J. Am. Chem. Soc.*, **66**, 244 (1944).

<sup>88</sup> H. H. Mottern and H. L. Cole, *J. Am. Chem. Soc.*, **61**, 2701 (1939).

<sup>89</sup> W. W. Pigman, *J. Research Natl. Bur. Standards*, **25**, 301 (1940).

<sup>90</sup> R. Pasternack and P. P. Regna (to Charles Pfizer and Co.), U. S. Pat. 2,338,534 (Jan. 4, 1944). See also H. S. Isbell and Harriet L. Frush, *J. Research Natl. Bur. Standards*, **32**, 77 (1944); **33**, 389 (1944); Harriet L. Frush and H. S. Isbell, *ibid.*, **33**, 401 (1944).

<sup>91</sup> F. Ehrlich and R. Guttman, *Ber.*, **67**, 573 (1934).

ascorbic acid (vitamin C). The oxidation of L-galactonic acid<sup>92</sup> or of its lactone<sup>93</sup> to 2-keto-L-galactonic acid, followed by reaction of the methyl 2-keto-L-galactonate with sodium methoxide, yields ascorbic acid.

## XII. COMPOUNDS POSSIBLY RELATED TO ALTROSE

Several additional compounds described in the literature will be included here because of their possible relation to the altrose group of substances. The questions of identity of Fischer's "volemose"<sup>94</sup> with an altroheptose or with sedoheptulose, and of Bertrand's "volemulose"<sup>95</sup> with sedoheptulose, have been discussed in an accompanying review by Dr. C. S. Hudson.<sup>2</sup>

Steiger and Reichstein<sup>96</sup> have isolated a compound of m. p. 132° and  $[\alpha]_D^{18} -43.0^\circ$  in acetone (*c*, 1.7); it had the composition of, and was assumed to be, a methyl isopropylidene-anhydro-D-altroside, and was obtained as a by-product during the preparation of a diisopropylidene-D-altrose (see Table I) from a D-altrose sirup.

Haworth, Raistrick and Stacey<sup>97</sup> discovered that the action of *Penicillium varians* on glucose produces a polysaccharide which they named varianose. By the usual methylation procedures, varianose was found to be composed of about 70% D-galactose, 14% D-glucose, and 14% of a third hexose which they believed to be either D-idose or L-altrose; however, from the evidence presented by those authors, it is not clear to the reviewer how D-idose would be possible. The third component was isolated as a liquid methyl trimethylhexoside of  $[\alpha]_D^{21} -15.6^\circ$  in 2% aqueous hydrochloric acid. The sirupy trimethylhexose obtained by hydrolysis had an equilibrium value of about +31°. Oxidation with bromine water yielded a trimethylhexonolactone whose crystalline phenylhydrazide melted at 175°. The regenerated hexonolactone was a sirup of  $[\alpha]_D^{20} -62.4^\circ$  in water, changing to  $-42.4^\circ$  in eighteen days, and was therefore a 1,4-lactone. Oxidation of the trimethylhexonolactone with nitric acid yielded dimethyl-D-tartaric acid which was identified through its crystalline diamide of m. p. 284° (decomp.) and  $[\alpha]_D^{20} +93^\circ$ .

<sup>92</sup> P. P. Regna and B. P. Caldwell, *J. Am. Chem. Soc.*, **66**, 243 (1944), have disclosed the reactions with D-galactonic acid.

<sup>93</sup> H. S. Isbell, abstract of a paper presented before the Division of Sugar Chemistry and Technology at the Cleveland meeting of the American Chemical Society, April 5, 1944; *J. Research Natl. Bur. Standards*, **33**, 45 (1944).

<sup>94</sup> E. Fischer, *Ber.*, **28**, 1974 (1895).

<sup>95</sup> G. Bertrand, *Compt. rend.*, **126**, 764 footnote 1 (1898); *Bull. soc. chim.*, [3], **19**, 348 footnote 2 (1898); *Ann. chim.*, [8], **3**, 209, 287 (1904).

<sup>96</sup> Marguerite Steiger and T. Reichstein, *Helv. Chim. Acta*, **19**, 1011 (1936).

<sup>97</sup> W. N. Haworth, H. Raistrick and M. Stacey, *Biochem. J.*, **29**, 2668 (1935).

TABLE I  
D- and L-Altrose and Derivatives\*

Substance	Melting point	$[\alpha]_D$	Temp.	Concentration	Solvent	Reference
	°C.		°C.	g./100 ml.		
$\beta$ -D-Altrose	103-105	-69→+33.1	20	4	Water	18, 16
$\beta$ -L-Altrose	107-109	-28.7→-32.3	20-25	2-6	Water	13
D-Altrose benzylphenylhydrazone	151	ca. +13	—	1	Ale.	1, 96
L-Altrose benzylphenylhydrazone	147-148	—	—	—	—	13
D-Allose phenylosazone <sup>98a</sup>	173-174(d.)	-19	20	1	Abs. alc.	7, 98, 1, 11
L-Allose phenylosazone	173-174(d.)	+19	20	1	Abs. alc.	7, 13
D, L-Allose phenylosazone	204(d.)	—	—	—	—	7
D-Altrose dibenzyl mercaptal	121-122	+39.4	20	3	Pyridine	16
L-Altrose dibenzyl mercaptal	121-122	-39.2	20	2	Pyridine	16
D-Altrose oxime	143-144	-64.0→-9.8	25	2.4	Water	17
1,2:5,6(?) -Diisopropylidene-D-altrofuranose	89	+28.3	19	2	Acetone	96
6-Desoxy-L-altrose	—	-18	23	25	Water	73
Phenylhydrazone	132	ca. -1	—	—	Pyridine+alc.	73
p-Bromophenylhydrazone (two modifications)	178; 155	—	—	—	—	73
Phenylosazone	185	ca. +75	—	2	Pyridine	73
p-Bromophenylosazone	203	—	—	—	—	73
1-Chloro-2,3,4,6-tetraacetyl- $\alpha$ <sup>58a</sup>	101-102	+110	20	5.0	Chloroform	51
1,2,3,4,6-Pentaacetyl- $\alpha$	118-119	+63.0	20	5.0	Chloroform	51
1,6-Anhydro	80-90	-213	20	2.5	Water	45, 46
1,6-Anhydro-2,3,4-triacetyl	100-101	-172	20	1.0	Chloroform	51
1,6(?) -Anhydro-3-amino, hydrochloride <sup>58a</sup>	216(d.)	-172	20	1.0	2.5% HCl	60, 64
2-Methyl-3,6-anhydro	$n_D^{16}$ 1.4878	+106	16	1.0	Water	57
2-Methyl-6-desoxy	—	+11.8	25	3.5	Water	72

\* Where the name of the sugar is omitted, D-altrose is understood.

<sup>98</sup> P. A. Levene and F. B. La Forge, *J. Biol. Chem.*, **20**, 429 (1915). See F. E. Wright, *J. Am. Chem. Soc.*, **38**, 1653 (1916) for a tabulation of the optical properties of D-allose (D-altrose, D-allulose) phenylosazone.

<sup>98a</sup> D-Allose phenylosotriazole, of m.p. 134-135° and  $[\alpha]_D^{20}$  +28.0° in pyridine (c, 0.8), prepared by the action of copper sulfate on D-allose phenylosazone, has been described by W. T. Haskins, R. M. Hann and C. S. Hudson, *J. Am. Chem. Soc.*, **67**, 941 (1945); cf. R. M. Hann and C. S. Hudson, *ibid.*, **66**, 737 (1944).

TABLE I (Continued)

Substance	Melting point	$[\alpha]_D$	Temp.	Concentration	Solvent	Reference
	°C.		°C.	g./100 ml.		
2,3,4,6-Tetraacetyl- $\beta$	85-90	-6.0 $\rightarrow$ +12.9	20	4.0	Chloroform	51
2,3,4,6-Tetramethyl	$n_D^{22}$ 1.4600	+63.0	19	4.7	Chloroform	70a, 56; cf. 53
2,4,6-Trimethyl	$n_D^{15}$ 1.4765	+79.3; +38.2	15; 18	1.6; 1.7	Chloroform	58, 69b
3-Amino, phenylosazone	207; 227(d.)	-41	20	1	Pyridine + aq. methanol	60, 64
3-Amino, phenylosazone	—	$[\alpha]_{17.8} = -42$	18	0.1		61
3-Methyl, phenylosazone	168-169	—	—	—	—	56
3,4,6-Trimethyl	$n_D^{20}$ 1.4738	+53.0	20	2.1	Water	70a
4,6-Dimethyl- $\alpha$	158-160	+103 $\rightarrow$ +64.9	15	2.0	Water	58; cf. 69b
4,6-Dimethyl, phenylosazone	139-141	—	—	—	—	58
D-Altronic acid	Solution	+ 8.0	0	2.5	Water	99
L-Altronic acid	110	- 8.1	20-25	—	Water	100
D-Altronic phenylhydrazide	Not given	-15.8	20	1	Water	8b
L-Altronic phenylhydrazide	151-152	+18.4	20-25	—	Water	100
D-Altronolactone	Solution	+34.4	20	2.2	N HCl	20
L-Altronolactone	Sirup	-37.2	20-25	—	Water	13
3,4,6-Trimethyl-D-altronic 1,5-lactone	$n_D^{21}$ 1.4785	-9.6 $\rightarrow$ +10.8	19	1.7	Water	70a
2-[D- <i>altro</i> -Pentahydroxyamyl]-benzimidazole	198(d.)	-48.1	20	2	N HCl	101
Brucine D-altronate	158	-23.8	20	2.5	Water	8a
Brucine L-altronate	171-175	-21.4	20-25	—	Water	13
Sodium D-altronate	Solution	- 4.0	20	10	Water	8a
Calcium D-altronate $\cdot 3.5H_2O$	—	- 2.4	20	1.8	Water	20
Calcium D-altronate $\cdot 3.5H_2O$	—	+11.5 $\rightarrow$ +24.8	20	3	N HCl	20, 37, 87
Calcium L-altronate $\cdot 3.5H_2O$	—	+ 2.1	20	2.5	Water	102, 13

<sup>99</sup> P. A. Levene, *J. Biol. Chem.*, **59**, 123 (1924).<sup>100</sup> F. L. Humoller, W. F. McManus and W. C. Austin, *J. Am. Chem. Soc.*, **58**, 2479 (1936).<sup>101</sup> W. T. Haskins and C. S. Hudson, *J. Am. Chem. Soc.*, **61**, 1266 (1939).<sup>102</sup> H. S. Isbell, *J. Research Natl. Bur. Standards*, **14**, 308 (1935).

TABLE I (Continued)

Substance	Melting point	$[\alpha]_D$	Temp.	Concentration	Solvent	Reference
	°C.		°C.	g./100 ml.		
Methyl $\alpha$ -D-altroside	107-108	+126	20	3.0	Water	51, 56
2-Acetamino-3-acetyl	189(d.)	+ 7.3	16	4.1	Methanol	66
2-Acetamino-3-acetyl-4,6-benzylidene	184	+ 52.5	18	1.4	Chloroform	69b, 71
2-Acetamino-3,4,6-triacetyl	176	+110	20	1.7	Chloroform	66
2-Acetyl-3-acetamino	174	+106	16	1.1	Chloroform	66
2-Acetyl-3-acetamino-4,6-benzylidene	201	+ 14.6	12	2.3	Chloroform	66, 71
2-Amino	193	+107	20	0.3	Chloroform	66, 67
2-Amino, hydrochloride	—	+ 39.7	22	3.1	Chloroform	66
2-Amino-4,6-benzylidene, hydrochloride	96	+ 85.5	21	0.3	Chloroform	66; cf. 67
2-Hydrazino-4,6-benzylidene	144	+ 68.0	15	1.1	Chloroform	57
2-Methyl	81-83	+112	15	0.9	Chloroform	56
2-Methyl-3-benzoyl-4,6-benzylidene	135-136	+133	15	2.3	Chloroform	56
2-Methyl-3-tosyl	118	+ 88.1	15	1.0	Chloroform	57
2-Methyl-3-tosyl-4,6-benzylidene	166-167	+ 57.1	15	1.0	Chloroform	56
2-Methyl-3-tosyl-4,6-dibenzoyl	113	+ 94.7	16	1.1	Chloroform	57
2-Methyl-3-tosyl-4-acetyl-6-trityl	165	+ 72.4	15	1.0	Chloroform	57
2-Methyl-3,4-diacetyl	76-77	+128	25	1.8	Chloroform	72
2-Methyl-3,4-diacetyl-6-iodo	54-55	+ 76.2	25	1.2	Chloroform	72
2-Methyl-3,4-diacetyl-6-trityl	121	+ 63.4	25	2.0	Chloroform	72
2-Methyl-3,6-anhydro	107-108	+105	14	1.1	Chloroform	57
2-Methyl-4,6-benzylidene	98-99	+103	15	3.2	Chloroform	56, 72
2-Methyl-6-desoxy	$n_D^{25}$ 1.4632	+ 91.1	25	2.3	Water	72
2,3-Dimethyl	$n_D^{15}$ 1.4769	ca. 125	15	—	Aq. acetone	56
2,3-Dimethyl-4,6-benzylidene	83-85	+ 92.8	15	1.3	Chloroform	56
2,3-Ditosyl-4,6-benzylidene	179	+ 46.9	15	1.0	Chloroform	57
2,3-Ditosyl-4,6-dimethyl	132-134	+103	—	1.1	Chloroform	53
2,3,4,6-Tetraacetyl	88-89	+ 66.0	20	5	Chloroform	51

TABLE I (Continued)

Substance	Melting point	$[\alpha]_D$	Temp.	Concentration	Solvent	Reference
	°C.		°C.	g./100 ml.		
2,3,4,6-Tetramethyl	$n_D^{15}$ 1.4500	+129	15	1.1	Chloroform	58, 56, 53
2,4-Dimethyl-3,6-anhydro	$n_D^{16}$ 1.4720	+ 69.0	18	1.1	Chloroform	57
2,4,6-Triacetyl-3-acetamino	177	+ 34.1	18	1.2	Chloroform	66, 71
2,4,6-Trimethyl	$n_D^{15}$ 1.4580	+145	15	2.0	Chloroform	58
3-Amino-4,6-benzylidene, hydrochloride	183(d.)	+ 83.5	19	1	Water	66; cf. 67
3-Hydrazino-4,6-benzylidene	196	+ 53.7	17	0.5	Pyridine	57
3-Methyl	—	+140	15	2.4	Chloroform	56
3-Methyl-4,6-benzylidene	131-133	+103	15	3.6	Chloroform	56
4,6-Benzylidene	169-170	+115; +127	20	2	Chloroform	51, 56, 57
4,6-Dimethyl	—	+146	15	1.4	Chloroform	58, 53
Methyl $\beta$ -D-altroside	—	- 52	—	—	Water	64
2-Methyl-4,6-benzylidene	127-129	-48.0	18	1.9	Chloroform	69b
2,3,4,6-Tetraacetyl	94-95	- 61.0	20	5.0	Chloroform	51; cf. 64
2,3,4,6-Tetramethyl	$n_D^{20}$ 1.4468	- 38.0	17	6.1	Chloroform	70a; cf. 64
2,4,6-Triacetyl-3-acetamino	188	-119	20	13	Chloroform	59
2,4,6-Trimethyl	$n_D^{22}$ 1.4545	- 18.1	21	1.1	Chloroform	69b
2,4,6-Trimethyl-3-acetamino	116	- 97.7	20	3.5	Chloroform	65
2,6-Dimethyl-3,4-anhydro	$n_D^{21}$ 1.4552	- 21.0	19	2.1	Water	70b
3-Acetamino	169	-123	20	—	Methanol	65
3-Acetamino-4,6-dimethyl	150	-108	19	3.2	Methanol	65
3-Amino, acetate	214(d.)	-130	20	1	2.5% HCl	60
3-Amino, hydrobromide	215(d.)	-124	22	10	Water	59
3-Amino, hydrochloride	210-212(d.)	-145	20	0.9	Water	64, 59, 60, 66
3,4,6-Trimethyl	$n_D^{22}$ 1.4584	- 25.6	21	—	Chloroform	70a
4,6-Benzylidene	188	- 62.9	—	1.1	Acetone	69a
4,6-Dimethyl	118	- 49.3	19	1.5	Chloroform	69b



TABLE II  
Neolactose, Celtribiose and Derivatives

Substance	Melting point	$[\alpha]_D$	Temp.	Concentration	Solvent	References
	°C.		°C.	g./100 ml.		
$\beta$ -Neolactose	190(d.)	+33.8→+35.5	20	8	Water	103, 16
Neolactose phenylosazone	195(d.)	—	—	—	—	11
Acetochloro- $\alpha$ -neolactose	182(d.)	+71.2	25	1	Chloroform	10
Octaacetyl- $\alpha$ -neolactose	178	+53.4	24	0.9	Chloroform	10
Octaacetyl- $\beta$ -neolactose	148	- 7.1	24	1	Chloroform	10
Heptaacetyl- $\beta$ -neolactose	135-136	+10.0→+21.0	20	4-8	Chloroform	16
Heptaacetyl- $\alpha$ -neolactose·heptaacetyl- $\beta$ -neolactose	85-95	+23.3→+21.0	20	8	Chloroform	16
Methyl heptaacetyl- $\beta$ -neolactoside	179	-14.5	20	—	Chloroform	25
Hexaacetylneolactose methyl 1,2-orthoacetate	121-122	+25.3	20	—	Chloroform	25
$\beta$ -Celtribiose monohydrate	133-148(d.)	+13.6	20	5	Water	20
Acetochloro- $\alpha$ -celtribiose	141-142	+64.2	20	4	Chloroform	20, 19
Octaacetyl- $\alpha$ -celtribiose (two modifications)	112; 129-130	+48.0	20	4	Chloroform	20
Octaacetyl- $\beta$ -celtribiose (two modifications)	103-105; 113-114	-13.0	20	6	Chloroform	20
Octaacetyl- $\beta$ -celtribiose monohydrate	87-93	—	—	—	—	20
2 Octaacetyl- $\alpha$ -celtribiose·1 octaacetyl- $\beta$ -celtribiose·3(C <sub>2</sub> H <sub>5</sub> ) <sub>2</sub> O	70	+24.9	20	4	Chloroform	20
Heptaacetyl- $\alpha$ -celtribiose	130-131	+22.3→+15.1	20	5	Chloroform	20
Heptaacetyl- $\alpha$ -celtribiose·2(C <sub>2</sub> H <sub>5</sub> ) <sub>2</sub> O	60	—	—	—	—	20
Heptaacetyl- $\beta$ -celtribiose·(C <sub>2</sub> H <sub>5</sub> ) <sub>2</sub> O	80(d.)	+ 3.9→+15.1 <sup>a</sup>	20	10	Chloroform	20
Hexaacetyl- $\beta$ -celtribiose 1,2-orthoacetate(?)	216	+ 1.0	20	1	Chloroform	20

<sup>103</sup> H. S. Isbell and W. W. Pigman, in F. J. Bates and Associates, "Polarimetry, Saccharimetry and the Sugars," United States Government Printing Office, Washington, D. C., 1942, p. 749.

<sup>a</sup> Calculated on a solvent-free basis.

# CARBOHYDRATE ORTHOESTERS

BY EUGENE PACSU

*Princeton University, Princeton, N. J.*

## CONTENTS

I. Definition and General Structure . . . . .	78
II. Preparation and Properties . . . . .	79
1. L-Rhamnose . . . . .	79
2. Maltose . . . . .	80
3. D-Mannose . . . . .	83
4. D-Lyxose . . . . .	84
5. 4- $\beta$ -D-Glucopyranosyl-D-mannose . . . . .	85
6. D-Ribose and L-Ribose . . . . .	86
7. D-( $\alpha$ )-Glucoheptose . . . . .	88
8. 3- $\alpha$ -D-Glucopyranosyl-D-fructose (Turanose) . . . . .	89
9. D-Fructose . . . . .	90
10. 4- $\beta$ -D-Glucopyranosyl-D-altrose (Celtrobose) . . . . .	91
11. D-Talose . . . . .	92
12. L-Sorbose . . . . .	93
13. D-( $\alpha$ )-Guloheptose . . . . .	94
14. 4- $\beta$ -D-Galactopyranosyl-D-altrose (Neolactose) . . . . .	95
15. D-Galactose . . . . .	96
16. 6-(ortho)-D-Mannopyranosyl-D-glucose . . . . .	97
III. Rate and Mechanism of Hydrolysis . . . . .	98
1. Acid-catalyzed Hydrolysis . . . . .	98
2. Alkaline Hydrolysis . . . . .	104
IV. Proof of Structure . . . . .	107
1. Alkyl Orthoester . . . . .	107
a. Physical Method . . . . .	107
b. Chemical Method . . . . .	107
2. Acidic Orthoester . . . . .	108
3. Orthoacyl Halide and Anhydride . . . . .	112
V. Mechanisms of Formation and Conversion . . . . .	113
1. Mechanism of Formation . . . . .	113
a. Aldose Alkyl Orthoester . . . . .	113
b. Aldose Orthoacyl Halide . . . . .	118
c. Ketose Alkyl Orthoester . . . . .	120
d. <i>aldehydo</i> -Aldose Alkyl Orthoester . . . . .	121
2. Mechanism of Conversion . . . . .	121
a. Hydrogen Chloride in Chloroform . . . . .	121
b. Titanium Tetrachloride in Chloroform . . . . .	122
c. Hydrogen Chloride in Methyl Alcohol . . . . .	122
VI. Conclusion . . . . .	124

## I. DEFINITION AND GENERAL STRUCTURE

Although the orthocarboxylic acids,  $R-C(OH)_3$ , are unstable, many of their derivatives are known, stable compounds. The known carbohydrate orthoesters are all derived from the structure that results when two of the three hydroxyl groups of an orthoacid are involved in ester formation with two hydroxyl groups of the sugar molecule. General formula *A* represents those types which are of particular interest in the field of carbohydrates. The two adjacent carbon atoms of the five-membered ring constitute carbon atoms number 1 and 2 of an aldose and either 1 and 2, or 2 and 3 of a ketose. In certain instances it has been

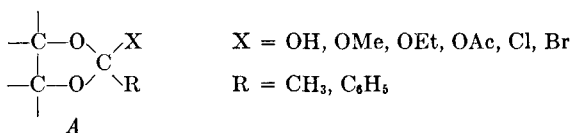

postulated that two non-adjacent carbon atoms of the sugar molecule may serve as anchorages for the two oxygen atoms of the ring, thus giving rise to the formation of larger rings.

There are four types of orthoester derivatives with this general structure. Acidic orthoesters result if the remaining hydroxyl group of the orthoacid is unsubstituted (*A*,  $X = OH$ ). A mixed type of compound which is simultaneously an acyl halide and an ester results when this hydroxyl group is substituted by a halogen (*A*,  $X = Cl, Br$ ). An acid anhydride type is possible when the third hydroxyl group is replaced by an acetoxy group (*A*,  $X = -O-CO-CH_3$ ). However, the best known carbohydrate orthoesters are those compounds which carry an alkoxy group (*A*,  $X = OMe, OEt$ ) in place of the third hydroxyl group of the orthoacid. These substances are of pure ester character, the true orthoesters of the carbohydrates. It is interesting to note that orthoesters of the type

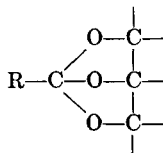

apparently do not exist, presumably because of steric influences.

Carbohydrate orthoesters were known for a long time before their correct structure was recognized. The first account of this type of compound is given in a posthumous article of Emil Fischer by Bergmann and Rabe,<sup>1</sup> who carried on the work after Fischer's death. The substance

<sup>1</sup> E. Fischer, M. Bergmann and A. Rabe, *Ber.*, **53**, 2362 (1920).

described in this article is a methyl L-rhamnoside triacetate, which on hydrolysis by alkali gives an "alkali-resistant acetate of a methyl rhamnoside." The authors named these substances  $\gamma$ -methyl rhamnoside monoacetate and triacetate. In 1924, Dale<sup>2</sup> also designated his new methyl D-mannoside tetraacetate by the prefix gamma ( $\gamma$ ). Haworth and his collaborators<sup>3,4</sup> referred to the "third variety" of methyl rhamnoside triacetate and put the prefix gamma in quotation marks (triacetyl-" $\gamma$ "-methylrhamnoside). Undoubtedly, this was done in order to differentiate these new isomeric glycosides from the so-called  $\gamma$ -glycosides, which are ring isomers of the "normal"  $\alpha$ - and  $\beta$ -glycosides. The true structure of these "cyclic acetates" was recognized independently by Freudenberg and Braun<sup>5</sup> and by Bott, Haworth and Hirst.<sup>6</sup> The details of this proof will be discussed later in this chapter.

## II. PREPARATION AND PROPERTIES

### 1. L-Rhamnose

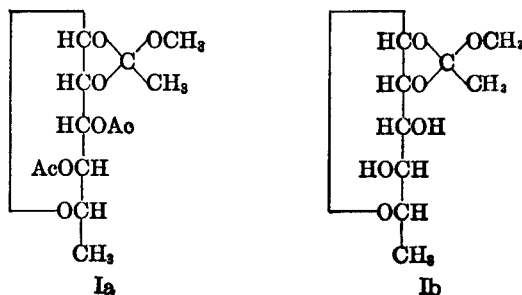

The application of Königs and Knorr's<sup>7</sup> method of glycoside synthesis to acetyl-L-rhamnosyl bromide by Fischer, Bergmann and Rabe<sup>1</sup> resulted in the formation of a mixture of one sirupy and two crystalline isomeric methyl rhamnoside acetates. When acetylramnosyl bromide was treated in anhydrous methyl alcohol with dry silver carbonate at room temperature, the solid part of the reaction product consisted of crystalline needles and cubes. The needles consisted of methyl  $\beta$ -L-rhamnoside triacetate with the expected normal behavior toward alkaline deacetylating agents. The cubes, consisting of " $\gamma$ -methyl L-rhamnoside triacetate"

<sup>2</sup> J. K. Dale, *J. Am. Chem. Soc.*, **46**, 1046 (1924).

<sup>3</sup> W. N. Haworth, E. L. Hirst and E. J. Miller, *J. Chem. Soc.*, 2469 (1929).

<sup>4</sup> W. N. Haworth, E. L. Hirst and H. Samuels, *J. Chem. Soc.*, 2861 (1931).

<sup>5</sup> K. Freudenberg, *Naturwissenschaften*, **18**, 393 (1930); K. Freudenberg and H. Scholz, *Ber.*, **63**, 1969 (1930); E. Braun, *ibid.*, **63**, 1972 (1930).

<sup>6</sup> H. G. Bott, W. N. Haworth and E. L. Hirst, *J. Chem. Soc.*, 1395 (1930).

<sup>7</sup> W. Königs and E. Knorr, *Ber.*, **34**, 957 (1901).

(Ia), melted at 83–85° and had a rotation of  $[\alpha]_D^{20} +35^\circ$ .<sup>8</sup> The substance exhibited a striking behavior when treated with alkaline deacetylating agents such as sodium hydroxide in alcohol or acetone solution, ammonium hydroxide, barium hydroxide, or liquid ammonia. In all cases, only two of the three acetyl groups were removed. The deacetylated product, described as crystalline “ $\gamma$ -methyl rhamnoside monoacetate” (Ib), showing m. p. 143–144° and  $[\alpha]_D^{16} +16.3^\circ$  in aqueous solution, was obtained by the use of a saturated solution of ammonia in ice-cold methyl alcohol. The presence of one acetyl group in the latter compound was proved by heating a sample of the substance with 0.1 *N* hydrochloric acid; titration of the reaction mixture with alkali indicated that one mole of acetic acid was set free during the hydrolysis. The acetic acid was detected as crystalline silver acetate. The “ $\gamma$ -methyl rhamnoside monoacetate” was without any action on hot Fehling solution but it was extremely sensitive toward dilute acid. When heated on a boiling water bath with 0.01 *N* hydrochloric acid for thirty minutes it was completely hydrolyzed, since it reduced the theoretical amount of Fehling solution. Reacetylation of the monoacetate by means of acetic anhydride and pyridine gave the original triacetate with m. p. 83–85°. In discussing the formation of the latter compound from acetyl rhamnosyl bromide and methyl alcohol, Fischer, Bergmann and Rabe suggested that the nature of the hydrogen bromide-binding agent played an important role with regard to the proportion of the different isomeric glycosides formed simultaneously in the reaction. They claimed that, when quinoline was employed instead of silver carbonate, methyl  $\beta$ -rhamnoside acetate was not found at all among the reaction products, but the yield of the  $\gamma$ -compound increased from about 20% to 40%. This was later confirmed by Haworth and co-workers<sup>3,4</sup> who found that the yield of the  $\gamma$ -compound varied from 20% to 50%.

## 2. Maltose

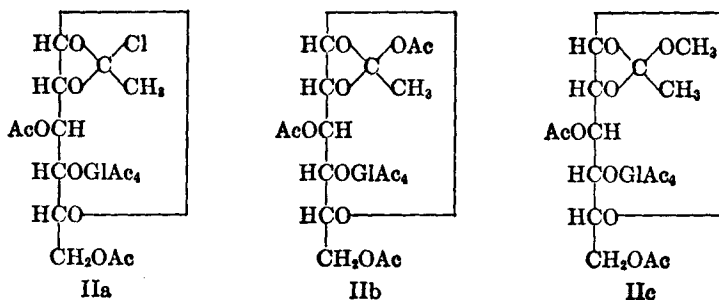

<sup>8</sup> Throughout this chapter, the solvent chloroform will be understood for rotations, unless otherwise specified. The abbreviation m. p. will be used for melting point.

In 1922 Freudenberg and Ivers<sup>9</sup> reported the preparation of a new and "exceedingly sensitive" chloride from maltose octaacetate. This chloro-compound was different from the two heptaacetylmaltosyl chlorides described in the literature. On the basis of the analytical results (C, H, Cl), which more nearly corresponded to an octaacetylmaltosyl chloride, Freudenberg and Ivers thought that the substance represented a new type of acetylglycosyl halide formed by the addition of one mole of hydrogen chloride to one mole of maltose octaacetate. It formed beautifully developed crystals (IIa) with m. p. 112–114° and  $[\alpha]_D +67.5^\circ$ . Because of its extraordinary reactivity the substance could not be recrystallized. In 1925 Freudenberg, v. Hochstetter and Engels<sup>10</sup> stated that the acetyl determination<sup>10a</sup> made on the new chloro-compound indicated the presence of only seven acetyl groups, and that consequently the substance must be a new heptaacetylmaltosyl chloride contaminated with a little maltose heptaacetate. In the presence of moisture the chloro-compound changed rapidly into the well-known maltose heptaacetate. The latter substance was prepared in good yield by allowing the chloro-compound to stand either in moist pyridine or benzene. The chloro-compound on treatment with silver acetate in benzene yielded a new, amorphous octaacetate (IIb). Methyl alcohol, in the presence of pyridine, yielded a new, crystalline, easily hydrolyzable methyl maltoside heptaacetate (IIc) with m. p. 163–164° and  $[\alpha]_{578} +101.6^\circ$  in tetrachloroethane solution, together with a considerable quantity of maltose heptaacetate. A similar reaction with ethyl alcohol gave the corresponding ethyl maltoside heptaacetate with m. p. 142–143°. On deacetylation of the methyl maltoside heptaacetate by means of liquid ammonia a sirupy product with  $[\alpha]_{578} +117.1^\circ$  in water solution was obtained. Freudenberg, Dürr and v. Hochstetter<sup>10b</sup> found that this new "methyl maltoside" was hydrolyzed in twenty hours to the extent of 74% in a buffer solution of pH 4.8 at 20°.

When the true structure of these orthoester derivatives was finally recognized, Freudenberg and Scholz<sup>5</sup> reported that the new crystalline methyl maltoside heptaacetate contained one acetyl group bound differently from the other six; on distillation of the substance with potassium stearate in alcoholic solution only six acetyl groups were removed in the form of ethyl acetate, which was determined quantitatively in the distillate. The presence of the seventh acetyl group was revealed by the

<sup>9</sup> K. Freudenberg and O. Ivers, *Ber.*, **55**, 929 (1922).

<sup>10</sup> K. Freudenberg, H. v. Hochstetter and H. Engels, *Ber.*, **58**, 666 (1925).

<sup>10a</sup> K. Freudenberg and M. Harder, *Ann.*, **433**, 230 (1923); *Z. angew. Chem.*, **38**, 280, note 2 (1925).

<sup>10b</sup> K. Freudenberg, W. Dürr and H. v. Hochstetter, *Ber.*, **61**, 1735 (1928).

toluenesulfonic acid method of acetyl estimation. Also, the sirupy "methyl maltoside," in which the presence of an acetyl group was previously overlooked, gave the correct analysis for the recalcitrant acetyl group by means of toluenesulfonic acid. Its previously reported methoxyl content, 7.8%, which is very low for a methyl maltoside (8.7%), agrees exactly with the theoretical value calculated for a methyl maltoside monoacetate. Freudenberg and Scholz<sup>5</sup> also claimed that the new chloride, on standing in pyridine solution, seemed to change into a ketene

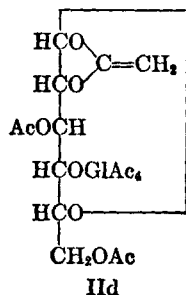

acetal (IIId) and pyridine hydrochloride, since the pyridine solution, although initially stable toward an acetone solution of potassium permanganate, reduced the latter after standing at 20° for a few days.

Pacsu and Rich<sup>11</sup> discovered a new method, by which it was possible to obtain the new methyl maltoside heptaacetate in one step and in fairly good yield. The procedure consisted in the treatment of  $\beta$ -maltose octaacetate in chloroform solution with aluminum chloride at room temperature. Freudenberg and Ivers' chloro-compound was not isolated but the reaction mixture was treated with methyl alcohol in the presence of pyridine; hexaacetylmaltose methyl 1,2-orthoacetate with m. p. 164° and  $[\alpha]_D^{20} +98.8^\circ$  was obtained in 30% yield. Pacsu and Rich attempted to apply this method to both lactose and cellobiose octaacetates, but, in contrast to the maltose octaacetate, no appreciable reaction could be detected.

Pacsu and Cramer<sup>12</sup> treated a chloroform solution of hexaacetylmaltose methyl 1,2-orthoacetate with titanium tetrachloride and obtained the normal heptaacetyl- $\alpha$ -maltosyl chloride. In like manner, when dry hydrogen bromide in glacial acetic acid was employed, a rapid formation of the normal heptaacetyl- $\alpha$ -maltosyl bromide resulted. Obviously, the replacement of the methoxyl group of the methyl orthoacetate by a halogen atom was accompanied by a rearrangement of the orthoester

<sup>11</sup> E. Pacsu and F. V. Rich, *J. Am. Chem. Soc.*, **57**, 587 (1935).

<sup>12</sup> E. Pacsu and F. B. Cramer, *J. Am. Chem. Soc.*, **59**, 1059 (1937).

molecule, as had been found previously by Isbell<sup>13</sup> for the methyl orthoacetate of 4- $\beta$ -D-glucopyranosyl-D-mannose.

### 3. D-Mannose

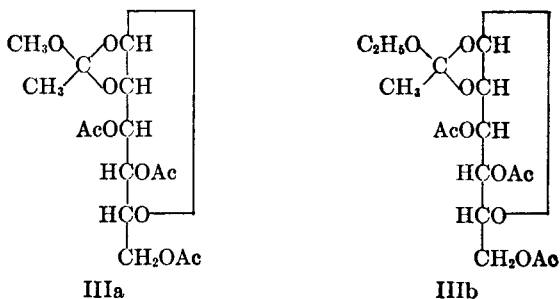

In 1924 Dale<sup>2</sup> published the results of his experiments, which he had carried out in the summer of 1918<sup>14</sup> at the Carbohydrate Laboratory of the Bureau of Chemistry, U. S. Department of Agriculture. At the time of his investigation, only one methyl glycoside of D-mannose, the  $\alpha$ -compound, was known. According to Dale's experiments, when a solution of the sirupy acetylmannosyl bromide in methanol was shaken with freshly prepared silver carbonate, a crystalline methyl D-mannoside tetraacetate (IIIa), designated by the prefix gamma, with m. p. 105° (corr.) and  $[\alpha]_D^{20}$  -26.6° was obtained. This substance showed a remarkable optical behavior in methanol solution containing hydrogen chloride; the rotation changed very rapidly, reaching a constant value in a few minutes. When at this point of constant rotation, or equilibrium, the solution was neutralized with silver carbonate and worked up in the usual manner, the sirupy product partly crystallized, giving rise to methyl  $\beta$ -D-mannoside tetraacetate. Although the yield of this compound was only 7%, it apparently was not possible to obtain more crystalline material from the mother liquor. Dale also noticed a second exceptional reaction of the  $\gamma$ -compound. When shaken with dilute alkali in the cold, the new glycoside lost only three of its four acetyl groups, the result being the same whether the strength of the alkali was 0.1 N or 0.5 N, and whether the period of hydrolysis was two hours, four hours, or even twenty hours. On the other hand, boiling with dilute sulfuric acid readily effected hydrolysis of all four acetyl groups. Dale remarked on the close parallel in the properties of the three methyl L-rhamnoside triacetates and the three methyl D-mannoside tetraacetates.

<sup>13</sup> H. S. Isbell, *J. Research Natl. Bur. Standards*, **7**, 1115 (1931).

<sup>14</sup> Private communication from Dr. J. K. Dale.



Levene and Sobotka<sup>15</sup> repeated Dale's experiments using crystalline acetylmannosyl bromide as the starting material. Their product was identical with the "γ-form" of Dale's new methyl mannoside acetates. Deacetylation by alkali led to a "dry, hygroscopic mass," which gave the correct analysis for D-mannose methyl 1,2-orthoacetate. From the crystalline acetylmannosyl bromide, on treatment with ethyl alcohol and silver carbonate, they prepared the analogous ethyl orthoacetate (IIIb) with m. p. 81–82° and  $[\alpha]_D -28^\circ$ . On saponification, it behaved in a manner analogous to the methyl derivative prepared from the same source. For the deacetylation of the triacetyl-D-mannose methyl 1,2-orthoacetate, Bott, Haworth and Hirst<sup>6</sup> employed 0.5 N sodium hydroxide in ethanol at 0°.

#### 4. D-Lyxose

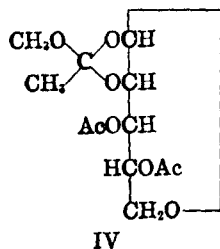

Levene and Wolfrom<sup>16</sup> treated sirupy acetyllyxosyl bromide with methyl alcohol and quinoline at room temperature for ninety minutes. After removal of the bromide with silver carbonate, diacetyl-D-lyxose methyl 1,2-orthoacetate (IV) was obtained in about 6% yield, having a m. p. of 90° and  $[\alpha]_D^{22} -103.5^\circ$ . Sodium methylate was also used for the neutralization, yielding only the orthoester. However, direct treatment of the bromo-compound with silver carbonate in methanol gave rise to a mixture of the orthoester and the methyl α-D-lyxoside triacetate. The formation of an α-glycoside in the Königs-Knorr reaction, even in such a small quantity as 0.1 g. from 45 g. of the bromo-compound, is very unusual and it deserves to be noted as a significant observation with regard to the interpretation of the solvolytic reactions of the acetyl-glycosyl halides.

The behavior of the orthoester toward methyl alcohol containing 0.1% hydrogen chloride showed great similarity to that of the corresponding mannoside acetate; the optical rotation rose in ten minutes

<sup>15</sup> P. A. Levene and H. Sobotka, *J. Biol. Chem.*, **67**, 759, 771 (1926).

<sup>16</sup> P. A. Levene and M. L. Wolfrom, *J. Biol. Chem.*, **78**, 525 (1928).

from the initial value of  $[\alpha]_D -98.3^\circ$  to  $-16^\circ$ . Analytical results indicated that at the end of twenty minutes an almost complete deacetylation of the orthoester had taken place.

5. 4- $\beta$ -D-Glucopyranosyl-D-mannose

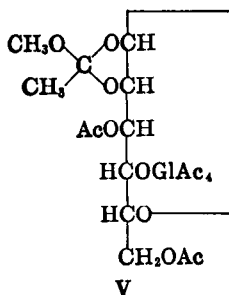

In 1930 Isbell<sup>17</sup> reported the formation of three new crystalline methyl 4- $\beta$ -D-glucosyl-D-mannoside heptaacetates in the Königs and Knorr reaction. One of these isomers, designated as the  $\gamma$ -compound (V) with m. p.  $167^\circ$  and  $[\alpha]_D^{20} -12.7^\circ$ , exhibited the reactions characteristic of the methyl glycoside acetates which have become known as orthoesters. The second of the isomers represented the  $\beta$ -glycoside which normally forms in the Königs-Knorr reaction, but the third was the  $\alpha$ -glycoside, the presence of which in the reaction products is just as unusual as the formation of methyl  $\alpha$ -D-lyxoside in the work of Levene and Wolfrom. The experiment<sup>13</sup> was carried out by shaking the acetyl-sugar bromide at  $0^\circ$  for thirty minutes in anhydrous methyl alcohol with dry, freshly prepared silver carbonate to yield about 60% of the orthoester.

When the orthoester was treated for ten minutes with dry hydrogen chloride in cold methyl alcohol, and then with a paste consisting of silver carbonate and water, Isbell obtained in good yield 4- $\beta$ -D-glucosyl-D-mannose hexaacetate previously<sup>17</sup> designated 4- $\beta$ -D-glucosyl-D-mannose heptaacetate. The structure of this new derivative was not rigidly determined. Since it gave a good yield of 4- $\beta$ -D-glucosyl- $\alpha$ -D-mannose octaacetate on acetylation with acetic anhydride and pyridine at low temperature, Isbell first suggested that it was a normal hexaacetate instead of an orthoacetate. Later, however, Pigman and Isbell<sup>18</sup> expressed the belief that possibly 4-glucosyl mannose hepta- and hexa-acetate may possess 1,2- and 1,6-orthoacetic acid structures, respectively.

<sup>17</sup> H. S. Isbell, *J. Am. Chem. Soc.*, **52**, 5298 (1930).

<sup>18</sup> W. W. Pigman and H. S. Isbell, *J. Research Natl. Bur. Standards*, **19**, 189 (1937).

The hexaacetate was also obtained by the addition of water to the solution of the methyl orthoacetate, which had been previously treated with dry hydrogen chloride in methanol. But when the methyl orthoacetate was treated with an aqueous methanol solution of hydrogen chloride, no crystalline hexaacetate was obtained. The reaction was presumably incomplete, since it was claimed that a portion of the methyl orthoacetate was recovered unchanged.

When a chloroform solution of hexaacetyl-4- $\beta$ -D-glucosyl-D-mannose methyl 1,2-orthoacetate was treated with hydrogen chloride, a rapid change in rotation occurred in that the initial specific rotation of  $-12.7^\circ$  became constant in six minutes,  $[\alpha]_D^{20} +29.8^\circ$ . This change in rotation was similar to that observed with alcoholic solutions. On evaporation, the chloroform solution gave a dextro-rotatory heptaacetyl-4- $\beta$ -D-glucosyl-D-mannosyl chloride with the structure of the common type of acetylglycosyl halides.

Another reaction of the methyl orthoester, somewhat analogous to that with hydrogen chloride, was observed by Isbell in an attempt to prepare the acetylated methyl  $\alpha$ -glycoside. On treatment of a chloroform solution of the substance with titanium tetrachloride in the manner which Pacsu<sup>19</sup> used to transform  $\beta$ -glycosides into the corresponding  $\alpha$ -isomers, Isbell obtained heptaacetyl-4- $\beta$ -D-glucosyl-D-mannosyl chloride. Thus it is evident that the methyl orthoesters on treatment with titanium tetrachloride do not give the reactions characteristic of the true methyl glycoside acetates.

#### 6. D-Ribose and L-Ribose

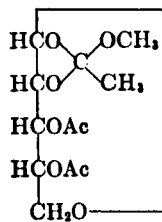

VIa

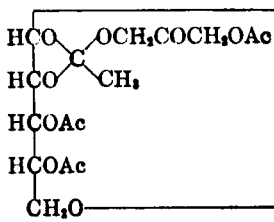

VIb

Levene and Tipson<sup>20</sup> studied the behavior of acetyl-D-ribosyl bromide in the Königs-Knorr reaction. The reaction of methanol upon acetyl-D-ribosyl bromide in the presence of freshly prepared silver carbonate took place at room temperature in thirty minutes. The crystalline bromo-

<sup>19</sup> E. Pacsu, *Ber.*, **61**, 1508 (1928); *J. Am. Chem. Soc.*, **52**, 2563, 2568, 2571 (1930).

<sup>20</sup> P. A. Levene and R. S. Tipson, *J. Biol. Chem.*, **92**, 109 (1931).

compound behaved similarly to the acetobromo derivatives of L-rhamnose, D-mannose and D-lyxose in forming about 22% of diacetyl-D-ribose methyl 1,2-orthoacetate (VIa) with m. p. 77–78° and  $[\alpha]_D^{26} + 2.7^\circ$ . On alkaline hydrolysis only two acetyl groups were removed. When a solution of the orthoester in absolute ethyl alcohol was diluted with 0.02 N aqueous hydrochloric acid, the rotation was  $[\alpha]_D^{23} + 17.8^\circ$ . The solution was then heated in a sealed glass tube at 98° for ninety minutes, after which the rotation of the cooled, strongly reducing solution decreased to  $[\alpha]_D^{23} - 19.3^\circ$ .

According to Klingensmith and Evans,<sup>21</sup> either of the enantiomorphous acetylribosyl bromides reacts with dihydroxyacetone monoacetate,  $\text{AcOCH}_2\text{CO}\cdot\text{CH}_2\text{OH}$ , in benzene solution, under conditions established by Reynolds and Evans,<sup>22</sup> using iodine as a catalyst after the manner of Helferich, Bohm and Winkler.<sup>23</sup> The reaction gave rise to needle-like clusters of 3,4-diacetyl-D-ribose 3'-acetoxyacetyl 1,2-orthoacetate (VIb), with m. p. 97–98° (corr.) and  $[\alpha]_D^{24} - 11.6^\circ$ , or the corresponding L-compound with the same m. p. and  $[\alpha]_D^{25} + 11.8^\circ$ .

The presence of the acetoxyacetyl group made it impossible for the authors to demonstrate the stability of one acetyl group to alkaline hydrolysis. Acetyl estimations gave values which were 9.4% high for four acetyl groups or 46% high for three acetyl groups. The probable reason for this was that the dihydroxyacetone portion of the molecule was susceptible to alkaline hydrolysis by virtue of its rearrangement to the enediolic structure.<sup>24</sup> Consequently, the ribose 3'-hydroxyacetyl 1,2-orthoacetate, formed by the removal of the three normal acetyl groups in the alkaline hydrolysis of the acetate may change to ribose 1,2-orthoacetic acid and the triose enediol,  $\text{CH}_2\text{OH}-\text{C}(\text{OH})=\text{CHOH}$ , which, according to Evans and Cornthwaite,<sup>25</sup> is converted in alkaline solution into lactic acid, acetic acid and formic acid as well as other substances. The ribose 1,2-orthoacetic acid is further hydrolyzed to ribose.

The behavior of the acetylated ribose 3'-hydroxyacetyl 1,2-orthoacetates in dry, alcohol-free chloroform containing dry hydrogen chloride was analogous to the behavior<sup>13, 18</sup> of the methyl glycoside acetates with an orthoester structure; a large change in rotation took place in a few minutes after solution. Upon evaporation a sirup was obtained, which gave a positive test for halogen and evolved acid fumes after standing for several weeks at room temperature. According to Klingensmith and

<sup>21</sup> C. W. Klingensmith and W. L. Evans, *J. Am. Chem. Soc.*, **61**, 3012 (1939).

<sup>22</sup> D. D. Reynolds and W. L. Evans, *J. Am. Chem. Soc.*, **60**, 2559 (1938).

<sup>23</sup> B. Helferich, E. Bohm and S. Winkler, *Ber.*, **63**, 990 (1930).

<sup>24</sup> H. Gehman, L. C. Kreider and W. L. Evans, *J. Am. Chem. Soc.*, **58**, 2388 (1936).

<sup>25</sup> W. L. Evans and W. R. Cornthwaite, *J. Am. Chem. Soc.*, **50**, 486 (1928).

Evans this behavior indicated the presence of acetylribosyl chloride. Since the isomeric D-arabinosyl-dihydroxyacetone tetraacetate of Kreider and Evans,<sup>26</sup> which does not possess an orthoester structure, showed no reaction with hydrogen chloride in chloroform solution, it was concluded by Klingensmith and Evans that the behavior of the ribose derivatives is to be attributed to an orthoester structure.

### 7. D-( $\alpha$ )-Glucoheptose

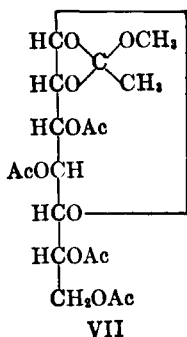

Haworth, Hirst and Stacey<sup>27</sup> showed that when either pentaacetyl- $\alpha$ -D-( $\alpha$ )-glucoheptosyl bromide or pentaacetyl- $\alpha$ -D-( $\alpha$ )-glucoheptosyl chloride, was refluxed for ten minutes in dry ether containing freshly prepared "activated" silver chloride,<sup>28</sup> pentaacetyl- $\beta$ -D-( $\alpha$ )-glucoheptosyl chloride was obtained in almost quantitative yield. The transformations were somewhat capricious and their course could not always be predicted with certainty. The crystalline acetyl- $\beta$ -glycosyl chloride was heated for five hours at 70° with methyl alcohol and quinoline and maintained overnight at room temperature. Tetraacetyl-D-( $\alpha$ )-glucoheptose methyl 1,2-orthoacetate (VII) with m. p. 112° and  $[\alpha]_D +43^\circ$  was obtained in excellent yield. It is interesting to note that the same acetyl- $\beta$ -glycosyl chloride gave only the normal methyl  $\alpha$ -glycoside pentaacetate in quantitative yield when its methyl alcoholic solution was shaken with silver oxide for two hours at 15°. Four of the five acetyl groups of the methyl orthoester were removed in less than two hours at room temperature when the substance was hydrolyzed in acetone solution with 0.1 *N* sodium hydroxide. Prolonged treatment (six hours) under similar conditions failed to hydrolyze the fifth group.

<sup>26</sup> L. C. Krieder and W. L. Evans, *J. Am. Chem. Soc.*, **58**, 797 (1936).

<sup>27</sup> W. N. Haworth, E. L. Hirst and M. Stacey, *J. Chem. Soc.*, 2864 (1931).

<sup>28</sup> H. H. Schlubach and R. Gilbert, *Ber.*, **63**, 2295 (1930); H. H. Schlubach, *ibid.*, **59**, 877 (1926); H. H. Schlubach, P. Stadler and I. Wolf, *ibid.*, **61**, 290 (1928).

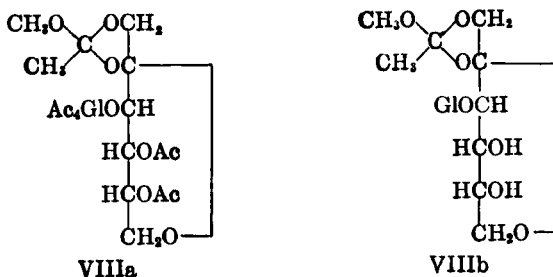
8. 3- $\alpha$ -D-Glucopyranosyl-D-fructose (Turanose)

Pacsu<sup>29</sup> found that the methoxyl replacement of the halogen in the crystalline acetylturanosyl bromide, when carried out either at 0° or at room temperature and according to the Königs-Knorr method, gave rise to a mixture of turanose heptaacetate and a methyl turanoside heptaacetate. The latter substance (VIIIa) with m. p. 162–167° and  $[\alpha]_{\text{D}}^{20} + 80^\circ$  represented a structural isomer of the normal methyl  $\beta$ -turanoside heptaacetate, and was obtained in about 35% yield. It possessed unique properties characteristic of glycosides with an orthoester structure. Although the turanose heptaacetate obtained as a by-product in the Königs-Knorr reaction was at first regarded by Pacsu as probably an orthoester, it is now believed that it possesses a normal structure. The structures originally assigned to the methyl orthoacetate and to the crystalline acetylturanosyl halides were also revised<sup>30</sup> as a result of revisions in the formula of turanose.

On removal of the six acetyl groups from hexaacetylturanose methyl 1,2-orthoacetate, either by alcoholic ammonia or by a trace of sodium methoxide according to the method of Zemplén and Pacsu,<sup>31</sup> crystalline turanose methyl 1,2-orthoacetate (VIIIb) was obtained. It crystallized from ethanol in the form of tabular crystals with m. p. 137° and  $[\alpha]_{\text{D}}^{20} + 114.6^\circ$  in aqueous solution. Hydrolysis with alkali did not eliminate the remaining acetyl group until the methyl glycosidic group with which it was linked in the orthoester formation had been removed. The instability of the turanose methyl 1,2-orthoacetate in aqueous solution was illustrated by a gradual decrease in rotation in water from  $[\alpha]_{\text{D}}^{20} + 113.3^\circ$  to a constant value of  $[\alpha]_{\text{D}}^{20} + 72.7^\circ$  in sixty-four hours.

The formation of a ketene acetal similar to that suggested by Freudenberg and Scholz<sup>5</sup> was also assumed by Pacsu<sup>32</sup> in order to explain the appearance of crystalline pyridine hydrobromide in the pyridine solu-

<sup>29</sup> E. Pacsu, *J. Am. Chem. Soc.*, **55**, 2451 (1933).

<sup>30</sup> E. Pacsu, E. J. Wilson, Jr. and L. Graf, *J. Am. Chem. Soc.*, **61**, 2675 (1939).

<sup>31</sup> G. Zemplén and E. Pacsu, *Ber.*, **62**, 1613 (1929).

<sup>32</sup> E. Pacsu, *J. Am. Chem. Soc.*, **54**, 3649 (1932).

tion of the crystalline acetylturanosyl bromide and the gradual increase of reduction toward potassium permanganate. However, it was found by Cramer and Pacsu<sup>33</sup> that this behavior is closely paralleled by a pyridine solution of acetylfructosyl bromide for which a normal structure is generally accepted. Consequently, as was pointed out by Pacsu and Cramer,<sup>12</sup> the ability of pyridine solutions of certain acetylglycosyl halides to reduce potassium permanganate after standing for several days, might be due to slight decomposition, since some coloration always occurs during that period of time. Therefore, unless ketene acetals are actually isolated, their assumed formation in pyridine solution cannot be used as evidence for the presence of orthoester structures in the suspected acetylglycosyl halides.

### 9. D-Fructose

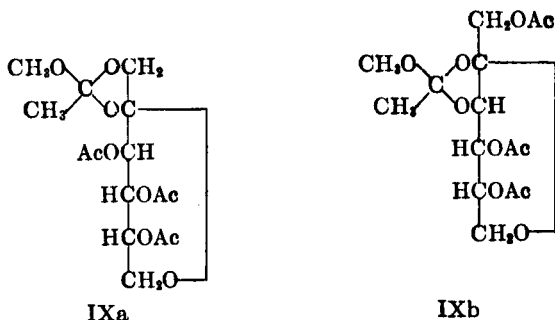

In 1935 Pacsu<sup>34</sup> found that the replacement of the chlorine atom in acetylfructosyl chloride by a methoxyl group is not a simple exchange reaction. When acetylfructosyl chloride was treated according to Brauns<sup>35</sup> with commercial silver carbonate in methanol for two hours at room temperature and then refluxed for fifteen minutes, a sirupy reaction product was obtained. For removal of a trace (2%) of fructose tetraacetate formed in the reaction as a by-product, a benzene solution of the sirup was extracted about twelve times with water until the aqueous extract did not reduce Fehling's solution. The sirupy residue from the dried benzene solution consisted of the dextrorotatory, crystalline methyl  $\alpha$ -D-fructopyranoside tetraacetate (34%) of Schlubach and Schröter<sup>36</sup> as well as 64% of a new isomer possessing the orthoester structure (IXa or b). A complete separation of the latter from the accompanying normal fructoside tetraacetate could not be accomplished. The best result was

<sup>33</sup> F. B. Cramer and E. Pacsu, *J. Am. Chem. Soc.*, **59**, 711 (1937).

<sup>34</sup> E. Pacsu, *J. Am. Chem. Soc.*, **57**, 745 (1935).

<sup>35</sup> D. H. Brauns, *J. Am. Chem. Soc.*, **42**, 1849 (1920).

<sup>36</sup> H. H. Schlubach and G. A. Schröter, *Ber.*, **61**, 1216 (1928).

obtained by seeding the sirup in absolute ether with the crystalline fructoside tetraacetate and maintaining at  $0^\circ$  for several days, then at  $-5^\circ$  for one week. During this time most of the normal fructoside tetraacetate crystallized from the solution and was removed by filtration. From the filtrate, a colorless, nonreducing glassy substance was obtained, this being the new methyl orthoacetate derivative with  $[\alpha]_{D^{20}} - 13.6^\circ$ . An acetyl determination corresponded to the saponification of three acetyl groups. However, when the substance was treated with dilute acid, four acetyl groups were removed. When a dry, ethereal solution of acetylfructosyl chloride was treated with silver nitrate in methanol and pyridine according to a slightly modified procedure of Schlubach and Schröter,<sup>36</sup> about 2% of fructose tetraacetate, 18% of crystalline methyl fructopyranoside tetraacetate and 80% of the methyl orthoacetate derivative were obtained.

On deacetylation of the latter compound by the method of Zemplén and Pacsu,<sup>31</sup> a water-soluble, non-reducing, crystalline mass with  $[\alpha]_{D^{20}} - 12.7^\circ$  in aqueous solution, was obtained. Although it could not be recrystallized from any solvent, the substance gave the correct analysis for a methyl fructoside monoacetate. Hydrolysis with alkali did not liberate the acetyl group. Crystalline acetylfructosyl bromide gave essentially the same results in the Königs-Knorr reaction as were obtained with the chloro-compound.

Although Pacsu regarded these substances as "(3)-monoacetyl- $\beta$ -methylfructoside (2,6) with orthoester structure" and its triacetate (IXb), their true structure has not yet been rigidly determined. The alternate structures of 3,4,5-triacetyl-D-fructose methyl 1,2-orthoacetate (IXa) and D-fructose methyl 1,2-orthoacetate are still to be considered.

A study of the action of titanium tetrachloride on the triacetylfructose methyl orthoacetate was made by Pacsu and Cramer.<sup>12</sup> The reaction yielded only pure acetylfructosyl chloride. Similarly, rapid formation of acetylfructosyl bromide resulted when the methyl orthoacetate was treated with hydrogen bromide in glacial acetic acid.

10. 4- $\beta$ -D-Glucopyranosyl-D-altrose (Celtribiose)

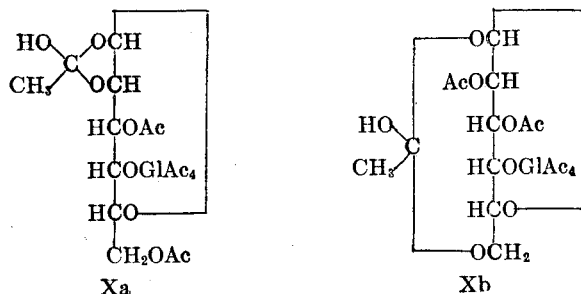



Richtmyer and Hudson<sup>37</sup> obtained a new heptaacetate of cellobiose in 5% yield, by treating crystalline acetylcellobiosyl chloride with silver carbonate in aqueous acetone. Since it was very sparingly soluble in ether it was separated from the more soluble normal heptaacetates by extraction in a Soxhlet apparatus. It melted (216°) at a considerably higher temperature than the other heptaacetates and, unlike the  $\alpha$ - and  $\beta$ -forms, which mutarotate to the equilibrium value of  $[\alpha]_D^{20} + 15.1^\circ$ , this hexaacetylcellobiose 1,2- (Xa) or 1,6-orthoacetic acid (Xb) showed  $[\alpha]_D^{20} + 1.0^\circ$  with no evidence of mutarotation on standing for eight days. On cautious acetylation with acetic anhydride and pyridine, it was transformed quantitatively to  $\beta$ -cellobiose octaacetate. These properties, combined with the fact that the normal  $\alpha$ - and  $\beta$ -heptaacetates are known, led the authors to the belief that the acetate may well have an orthoester structure involving the 1,2- or 1,6-positions of the cellobiose molecule.

### 11. D-Talose

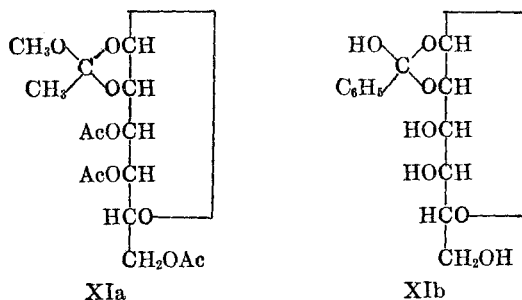

Pigman and Isbell<sup>18</sup> found that crystalline tetraacetyl-D-talosyl bromide reacted with ice-cold methyl alcohol in the presence of silver carbonate to give, besides  $\alpha$ -D-talose tetraacetate, a compound in 24% yield and m. p. 91.5–92.5°, with the same empirical formula as methyl taloside tetraacetate but containing only three alkali-labile acetyl groups (XIa). It reacted with hydrogen chloride in chloroform so rapidly that the rate of change could not be measured polarimetrically. While the specific rotation in chloroform was  $[\alpha]_D^{20} + 3.7^\circ$ , chloroform containing hydrogen chloride gave  $[\alpha]_D^{21} + 73^\circ$  after three minutes, and on solvent removal crystals were obtained which were probably acetyltalosyl chlorides. By treatment of the methyl orthoacetate with aqueous alcoholic hydrogen chloride, D-talose tetraacetate was obtained.

<sup>37</sup> N. K. Richtmyer and C. S. Hudson, *J. Am. Chem. Soc.*, **58**, 2534 (1936).

In the synthesis of D-talose, Pigman and Isbell succeeded in separating a small quantity of talose monobenzoate from the action of perbenzoic acid on galactal. It gave a positive color test for benzoic acid only after acid hydrolysis and was therefore not a molecular compound of talose and benzoic acid. The method used for the preparation of talose monobenzoate eliminated any position for the benzoyl residue other than carbon atoms 1 and 2, but the properties of the monobenzoate were different from those which might be anticipated for a normal talose 1- or 2-monobenzoate. Thus, in contrast to the  $\beta$ -glucose 1-benzoate of Zervas,<sup>38</sup> the talose monobenzoate underwent a rapid reaction with methyl alcohol, was quickly decomposed by very dilute (0.001 *N*) alkali (and even by distilled water over a long period of time), and did not have a distinct melting point. The lack of mutarotation in acid solution did not correspond to the properties expected of a talose 2-benzoate. According to Pigman and Isbell, these data are best explained by an orthoester structure and for the present the talose monobenzoate is assigned the formula of D-talose 1,2-orthobenzoic acid (XIb). The substance was probably produced by the addition of benzoic acid to an intermediate ethylene oxide derivative formed by the action of perbenzoic acid on galactal.

## 12. L-Sorbose

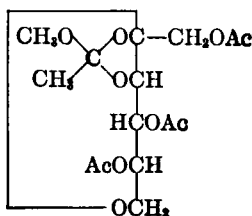

XIIa

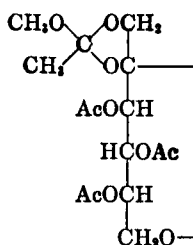

XIIb

Pacsu<sup>39</sup> observed the formation of a new methyl (XIIa or b) and ethyl sorboside tetraacetate possessing the orthoester structure when acetylsorbosyl chloride was shaken either with absolute methyl or ethyl alcohol and silver carbonate for several hours at room temperature. The normal crystalline methyl and ethyl sorboside tetraacetates were obtained as by-products. The acetylsorbosyl chloride used in these experiments was prepared either according to the method of Schlubach

<sup>38</sup> L. Zervas, *Ber.*, **64**, 2289 (1931).

<sup>39</sup> E. Pacsu, *J. Am. Chem. Soc.*, **61**, 2669 (1939).

and Graefe<sup>40</sup> by treating sorbose tetraacetate with liquid hydrogen chloride in an autoclave at 0°, or by allowing the tetraacetate to stand in a pressure bottle at 0° with absolute ether previously saturated with dry hydrogen chloride at -70°. In either case the acetylsorbosyl chloride was obtained as a sirup.

Since they were obtained as sirups, the acetylated L-sorbose methyl and ethyl orthoacetates have not been investigated further. Their true formulas are unknown at present.

### 13. D-( $\alpha$ )-Guloheptose

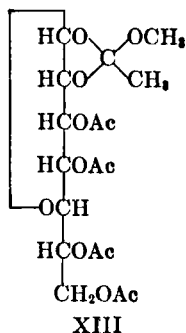

Miss Frush and Isbell<sup>41</sup> applied the Königs-Knorr reaction<sup>7</sup> to their crystalline pentaacetyl- $\alpha$ -D-( $\alpha$ )-guloheptosyl bromide and succeeded in isolating the tetraacetyl-D-( $\alpha$ )-guloheptose methyl 1,2-orthoacetate (XIII) in nearly quantitative yield. The operation was carried out by shaking a mixture of powdered Drierite (anhydrous calcium sulfate), freshly prepared silver carbonate and the crystalline bromide in methanol at 0° for forty-four hours. The reaction was studied by analysis of the final solution. The difference between the results obtained by acid (0.1 *N*) and by alkaline (0.1 *N*) hydrolysis determined the amount of orthoacetate. Within experimental error the reaction product consisted exclusively of the orthoacetate.

In the preparation of the orthoacetate the crystalline product, which separated upon evaporation of the methyl alcohol, was recrystallized several times from ethyl alcohol by the addition of petroleum ether. The chunky, truncated prisms had m. p. 106° and  $[\alpha]_D^{20} +3.2^\circ$ .

When heated with 0.1 *N* hydrogen chloride in chloroform, the compound reacted rapidly in a manner characteristic of orthoesters.<sup>13</sup> After

<sup>40</sup> H. H. Schlubach and G. Graefe, *Ann.*, **532**, 211 (1937).

<sup>41</sup> Harriet L. Frush and H. S. Isbell, *J. Research Natl. Bur. Standards*, **27**, 413 (1941).

four minutes, the specific rotation of the solution became constant at  $-38.1^\circ$ , whereas the specific rotation of the orthoester in pure chloroform was  $+3.2^\circ$ . Upon evaporation, the solution gave a semicrystalline residue that presumably was pentaacetyl- $\alpha$ -D-( $\alpha$ )-guloheptosyl chloride.

14. *4- $\beta$ -D-Galactopyranosyl-D-altrose (Neolactose)*

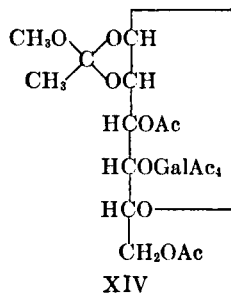

Miss Frush and Isbell<sup>41</sup> used crystalline heptaacetyl- $\alpha$ -neolactosyl chloride<sup>42</sup> in the Königs-Knorr reaction<sup>7</sup> under conditions identical with those described for pentaacetyl- $\alpha$ -D-( $\alpha$ )-guloheptosyl bromide, with the exception that the reaction time was increased to seventy-two hours. Acid and alkaline hydrolysis of the reaction solution showed that only about 70% of the original sugar was present, and that this was almost completely in the form of the orthoester. By extraction of the silver residues with chloroform, a halogen-free sirup was obtained, from which short rectangular crystals separated upon addition of methyl alcohol. This substance was methyl  $\beta$ -neolactoside heptaacetate, which exhibited the expected normal behavior.

The acetylated neolactose methyl 1,2-orthoacetate was isolated in crystalline form when the original methanol solution was evaporated in air to a sirup and triturated with ethanol. After several recrystallizations the compound (XIV) had m. p.  $121-122^\circ$  and  $[\alpha]_D^{20} +25.3^\circ$ . It showed the reactions and properties which characterize the sugar methyl orthoacetates, including stability of the orthoacetate group toward alkaline hydrolysis. When the new compound was treated with an anhydrous 0.1 *N* solution of hydrogen chloride in chloroform, it was converted into the crystalline heptaacetyl- $\alpha$ -neolactosyl chloride. Alkaline hydrolysis also indicated the presence of six acetyl groups, whereas dilute acid removed seven.

<sup>41</sup> N. K. Richtmyer and C. S. Hudson, *J. Am. Chem. Soc.*, **57**, 1716 (1935); *cf.*, A. Kunz and C. S. Hudson, *ibid.*, **48**, 1978, 2435 (1926).

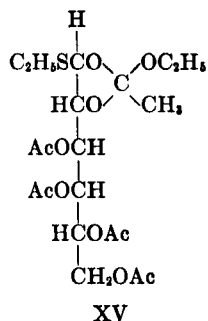
15. *D-Galactose*

A new type of orthoester was reported by Wolfrom and Weisblat.<sup>43</sup> The substance, designated 1-thioethoxy-*aldehydo-D-galactose* ethyl 1,2-orthoacetate 3,4,5,6-tetraacetate (XV), m. p. 125–126° and  $[\alpha]_{\text{D}}^{24} + 54^\circ$ , represents the first orthoester derivative of an open-chain sugar. By the reaction of a mixture of acetyl chloride and phosphorus oxychloride upon *D-galactose* diethyl mercaptal pentaacetate, pure 1-chloro-1-thioethoxy-*aldehydo-D-galactose* pentaacetate was obtained.<sup>44</sup> The same chloride was prepared<sup>45</sup> from the interaction of 1-thioethoxy-*aldehydo-D-galactose* hexaacetate with dry hydrogen chloride in anhydrous ether. Whether or not this chloride possesses an orthoester structure is not known; its recorded slow change of rotation from  $[\alpha]_{\text{D}} - 27^\circ$  to  $-13^\circ$  in chloroform solution would seem to indicate great sensitivity toward moisture, which is characteristic of the hexaacetylmaltose 1,2-orthoacetyl chloride of Freudenberg and Ivers.<sup>9</sup> In any case, the crude chloride from the second procedure under the conditions of the Königs-Knorr reaction yielded a small quantity of the new ethyl orthoacetate as well as a large amount of the expected normal product, previously obtained<sup>44</sup> from the pure chloride and designated *D-galactose* diethyl monothioacetal pentaacetate. The structure of the new orthoester rests upon the difference between alkaline and acid acetyl analyses; the former method indicated the presence of only four acetyl groups in the molecule, whereas the latter demonstrated the presence of five.

<sup>43</sup> M. L. Wolfrom and D. I. Weisblat, *J. Am. Chem. Soc.*, **66**, 805 (1944).

<sup>44</sup> M. L. Wolfrom and D. I. Weisblat, *J. Am. Chem. Soc.*, **62**, 879 (1940).

<sup>45</sup> M. L. Wolfrom, D. I. Weisblat and A. R. Hanze, *J. Am. Chem. Soc.*, **62**, 3248 (1940).

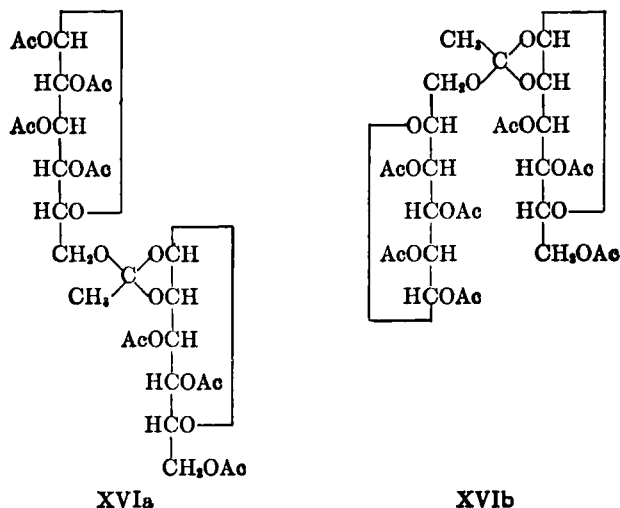
16. 6-(*ortho*)-D-Mannopyranosyl-D-glucose

Talley, Reynolds and Evans<sup>46</sup> synthesized a new type of disaccharide derivative in which the primary hydroxyl group of the glucose component and the acid hydroxyl group of the D-mannose 1,2-orthoacetic acid component are involved in the formation of the biosidic linkage. These compounds (XVIa, XVIIb) were designated *d*- and *l*- ( $\beta$ -D-glucose 1,2,3,4-tetraacetate-D-mannose 3',4',6'-triacetate 6,1',2'-orthoacetate). Talley, Reynolds and Evans believe that these two orthoesters are diastereoisomers differing only in the configuration of the groups around the new asymmetric carbon atom formed during the condensation and represent *d*- and *l*-forms with respect to this particular asymmetric carbon atom. Both of these substances, along with a third isomer possessing the expected normal biosidic linkage, were isolated from the reaction product obtained when  $\beta$ -D-glucose 1,2,3,4-tetraacetate and tetraacetyl- $\alpha$ -D-mannosyl bromide were combined in alcohol-free chloroform in the presence of silver oxide and Drierite. Yields as high as 23% of the disaccharide orthoacetates were obtained. The pure (*d*-ortho)-disaccharide octaacetate had m. p. 169° and  $[\alpha]_D^{30} +17.1^\circ$  and the pure (*l*-ortho)-derivative had m. p. 174° and  $[\alpha]_D^{30} -27.6^\circ$ . Both compounds are disaccharide orthoester octaacetates since only seven acetyl groups were hydrolyzed by alkali, whereas eight acetyl groups were removed by acid. In addition, chloroform containing dry hydrogen chlo-

<sup>46</sup> E. A. Talley, D. D. Reynolds and W. L. Evans, *J. Am. Chem. Soc.*, **65**, 575 (1943).

ride changed the specific rotations of both isomers to the almost identical values of  $[\alpha]_{\text{D}}^{28} +44^{\circ}$  (*d*-form) and  $[\alpha]_{\text{D}}^{28} +43^{\circ}$  (*l*-form). This rapid initial rise was followed by a gradual decrease in rotation. However, when either form was treated with hydrogen bromide in chloroform, the rapid initial rise in rotation was followed by a slower rise. According to Talley, Reynolds and Evans, the new orthoesters gave rise to a molecular mixture of  $\beta$ -D-glucose 1,2,3,4-tetraacetate and tetraacetyl- $\alpha$ -D-mannosyl halide in the rapid phase of the mutarotation. However, attempts to isolate the products in crystalline condition were unsuccessful. They believed that the second phase of the mutarotation was related in some way to the behavior of  $\beta$ -D-glucose 1,2,3,4-tetraacetate in the hydrogen halide-chloroform solution. This was shown to be true when separate samples of  $\beta$ -D-glucose 1,2,3,4-tetraacetate were treated with hydrogen chloride (or bromide) in chloroform. The rate of change in rotation was a function of the hydrogen halide concentration as was also the case for the orthoester. From these observations Talley, Reynolds and Evans concluded that the decrease in rotation observed during the action of hydrogen chloride on the disaccharide orthoester was caused by the action of hydrogen chloride on the  $\beta$ -D-glucose 1,2,3,4-tetraacetate formed in the reaction. Likewise, the secondary slow rise in rotation was due to the action of hydrogen bromide on the glucose tetraacetate.

### III. RATE AND MECHANISM OF HYDROLYSIS

#### 1. *Acid-catalyzed Hydrolysis*

Although the instability of the sugar alkyl orthoacetates in acidic medium was recognized as soon as the first of these compounds was prepared, there are only a few cases known where the rates of acid-catalyzed hydrolysis of the orthoesters have been determined. Such measurements are of importance since they may throw light on the reaction mechanism and on the nature of the products under investigation. Haworth, Hirst and Samuels<sup>4</sup> were the first to follow the course of acid-catalyzed hydrolysis of an orthoester by recording the change in rotation. They submitted the polarimetric data so obtained to mathematical analysis. Two consecutive reactions were apparently initiated by the action of 0.01 *N* or 0.0015 *N* acid at 20° on the crystalline L-rhamnose methyl 1,2-orthoacetate (XVIIa) with  $[\alpha]_{\text{D}}^{20} +16^{\circ}$  in aqueous solution. The first of these is the hydrolysis of the methoxyl of the orthoacetic ester group, catalyzed by hydrogen ion. The value of the velocity coefficient  $k_1$  was approximately 5.5, in terms of minutes and natural logarithms for

0.01 *N* acid. The specific rotation of the product given by this reaction was calculated to be  $[\alpha]_{D^{20}} +47^{\circ}$ . For the second reaction, which was influenced by the hydrogen ion concentration to a much smaller extent, the velocity coefficient  $k_2$  was approximately 0.11, in terms of minutes and natural logarithms. From the figures given by Moelwyn-Hughes<sup>47</sup> for the ordinary glucosides, the first reaction proceeds  $10^{11}$  times as rapidly as the hydrolysis of methyl  $\alpha$ -D-glucopyranoside under comparable conditions. Once the above consecutive reactions are initiated they proceed simultaneously. The authors also believed that at the end of the second reaction, an alkali-labile acetyl group was still largely intact at position 2 (XVIIc) and that the second stage was followed by mutarotation. These changes are represented by the following formulas:

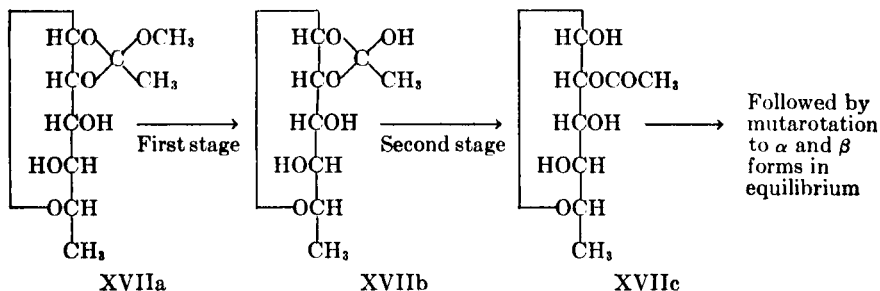

The fall in rotation from the maximum value ( $+45^{\circ}$ , first stage) to the observed final value  $+28^{\circ}$  (second stage) could not be arrested by neutralizing the solution, or rendering it alkaline. When the acid concentration, in another experiment, was reduced to 0.0015 *N*, hydrolysis of the methyl glycosidic group was still extremely rapid. The specific rotation reached a maximum value of  $+36.5^{\circ}$  in five minutes and then fell to the final observed value of  $+28^{\circ}$  in twenty-five minutes.

Similar results were obtained with 3,4-dimethyl-L-rhamnose methyl 1,2-orthoacetate. Hydrolysis of the glycosidic group took place so quickly in acid solution that the first stage of the reaction could not be followed polarimetrically. The rotation of the substance in pure water,  $[\alpha]_{D^{20}} +36^{\circ}$ , changed within one minute after addition of the acid to the maximum value of  $+78^{\circ}$  (first stage), followed by a drop in rotation to  $+29^{\circ}$  in eighteen minutes (second stage).

Pacsu<sup>29</sup> measured the rate of hydrolysis of the methyl glycosidic group of the hexaacetylturanose methyl 1,2-orthoacetate at  $20^{\circ}$  in a

<sup>47</sup> E. A. Moelwyn-Hughes, *Trans. Faraday Soc.*, 25, 81 (1929).



0.0632 *N* solution of hydrogen chloride in 95% alcohol. Since the velocity coefficient of this transformation, calculated for a unimolecular reaction, was constant,  $k = 0.0114$  in terms of minutes and decimal logarithms, it was concluded that only the methoxyl group was removed. When 0.009 *N* acid in 75% alcohol was employed,  $k$  decreased to 0.00829. The gradual development of the reducing power in these experiments seemed to indicate that the observed phase of the reaction taking about three hours corresponded to the very rapid first stage, the loss of methoxyl, in the hydrolysis of the rhamnose derivatives. The cause of the slow rate was attributed mainly to the difference in the solvents employed in the experiments on the rhamnose and turanose orthoesters. A significant difference, however, remained; it was the apparent absence of the second stage of the reaction which, according to the interpretation of Haworth and coworkers, should involve the rearrangement of the orthoacetic acid derivative into a substance containing a normal acetyl group. The absence of a second stage was also noticeable in the acid-catalyzed hydrolysis of turanose methyl 1,2-orthoacetate when carried out at 20° in 0.002 *N* and 0.00033 *N* aqueous hydrochloric acid. In both cases, constant rotations were reached in about thirty to thirty-five minutes. Considering the low acid concentration, this time interval, not determined with accuracy, may very well have corresponded to that required for the first stage of reaction of the rhamnose derivatives. The lack of a second stage in these hydrolytic reactions was construed as evidence in favor of an orthoacid structure of turanose heptaacetate. This conclusion might appear to be supported by the fact that similarly constituted substances have been isolated as stable, crystalline compounds, such as celtribiose heptaacetate,<sup>37</sup> talose monobenzoate<sup>18</sup> and, perhaps, 4- $\beta$ -D-glucopyranosyl-D-mannose hepta- and hexaacetate.<sup>18</sup>

The problem of the acid-catalyzed hydrolysis of the carbohydrate orthoesters was brought nearer to the final solution by Pacsu's<sup>48</sup> experiments on the hydrolysis of maltose methyl 1,2-orthoacetate. Since two adjacent hydroxyl groups on the same side of the plane are necessary for the formation of orthoester derivatives, the maltose methyl orthoacetate must have an  $\alpha$ -configuration. Hydrolytic experiments with very dilute hydrochloric acid confirmed this. Two consecutive reactions took place at a *pH* of 4. In the first reaction, the original specific rotation,  $[\alpha]_D^{23} + 103.7^\circ$  in pure water, increased to  $+134.6^\circ$  within two minutes. The latter figure corresponds to the specific rotation of  $\alpha$ -maltose 2-acetate. The second reaction ( $k = 0.0095$ ) corresponded to the downward mutarotation of  $\alpha$ -maltose 2-acetate. When the hydrogen-ion concentration,

<sup>48</sup> E. Pacsu, *J. Am. Chem. Soc.*, **57**, 537 (1935).

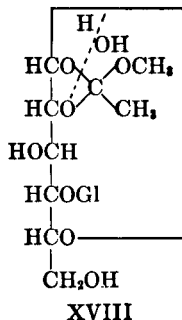

in a second experiment, was decreased to a  $pH$  of 4.8, the rate of the first reaction became measurable, and  $k$  (0.0560) was only slightly influenced by the mutarotation of the liberated  $\alpha$ -maltose 2-acetate proceeding in the opposite direction. From these experiments, two conclusions may be drawn: first, that the maltose orthoester possesses the  $\alpha$ -configuration; and second, that hydrolysis of the orthoester occurs between the central carbon atom and the oxygen atom which is linked to carbon atom 1 of the orthoester ring. This process is accompanied by an immediate loss of methyl alcohol from the orthoacetyl group liberated at position 2, and is characterized by the slow downward mutarotation of the  $\alpha$ -maltose 2-acetate formed in this manner.

These conclusions do not comply with the explanation given by Haworth, Hirst and Samuels and by Pacsu for the reaction mechanism of the acid-catalyzed hydrolysis of the rhamnose and turanose orthoesters, respectively. It seems, however, that the experimental data of these authors can be re-interpreted without difficulty, to fit into the picture given for the reaction mechanism of the maltose orthoester. The first and very rapid reaction, which Haworth and coworkers associated with the removal of a methoxyl residue, would, as in the maltose orthoester, involve the rupture of the bond between the central carbon atom and that oxygen atom which is linked to carbon atom 1. This process liberates the  $\beta$ -form of L-rhamnose substituted at position 2 by a methyl hydrogen orthoacetate residue. However, since this intermediate is

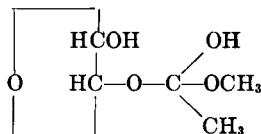

also very susceptible to acid hydrolysis, it will hydrolyze immediately into methyl alcohol and  $\beta$ -L-rhamnose 2-acetate. This is a first order

reaction, the rate-determining step being the first phase involving the rupture of the original orthoester ring. Since the L-rhamnose 2-acetate liberated in this hydrolysis must possess the  $\beta$ -configuration, it mutarotates downward to an equilibrium mixture of  $\alpha$  and  $\beta$  forms. Therefore, the "second reaction" of Haworth and coworkers may in reality represent the mutarotation of  $\beta$ -L-rhamnose 2-acetate and not the supposed rearrangement of the orthoacid derivative (XVIIb) into rhamnose 2-acetate. A very significant fact in this re-interpretation is that L-rhamnose in pure water exhibits a comparatively rapid mutarotation so that  $k = 0.040$ . The rate constant of Haworth, Hirst and Samuels, when recalculated for minutes and decimal logarithms, becomes  $k_2 = 0.048$ . Considering the slight catalytic effect of the hydrogen ions on the mutarotation, the agreement between the two rate constants is very satisfactory. In addition, the specific rotation of the product given by the first reaction was calculated by Haworth and coworkers to be  $[\alpha]_D^{20} +47^\circ$ , whereas the initial rotation of  $\beta$ -L-rhamnose was calculated by Hudson and Yanovsky<sup>49</sup> to be  $+54^\circ$  and by Pacsu<sup>50</sup> to be  $+41.0^\circ$ ; Fischer<sup>51</sup> gave  $+31.5^\circ$  for the  $\beta$ -form of a sample which probably was not quite pure. Since it may be safely assumed that the presence of an acetyl group at position 2 will not alter the rotational values of the unsubstituted sugars considerably, the product of the first reaction in Haworth, Hirst and Samuels' experiment was probably  $\beta$ -L-rhamnose 2-monoacetate. This would also explain the otherwise puzzling fact that the rate of the second reaction was fifty times slower than that of the first reaction.

In the light of this interpretation, Pacsu's experimental results on the turanose derivatives are also clarified. The gradual development of reducing power is caused by the rupture of the orthoester ring, a comparatively slow process under the experimental conditions employed. The absence of a second stage in the hydrolysis of the acetylated turanose orthoester should not be surprising since normal turanose heptaacetate, the expected product of the reaction, has a constitution similar to fructose tetraacetate, which is known to show no mutarotation. The hydrolysis of turanose methyl 1,2-orthoacetate was carried out in such low acidity that the prolonged first stage of reaction was more than sufficient for the mutarotation of the turanose 1-acetate which was gradually liberated during this time.

Regarding the detailed mechanism of the acid-catalyzed hydrolysis of carbohydrate orthoesters in general, the reaction may probably best

<sup>49</sup> C. S. Hudson and E. Yanovsky, *J. Am. Chem. Soc.*, **39**, 1013 (1917).

<sup>50</sup> E. Pacsu, *J. Am. Chem. Soc.*, **61**, 2669 (1939).

<sup>51</sup> E. Fischer, *Ber.*, **29**, 324 (1896).

be represented as a ternary reaction between ester, water, and the catalyzing acid. For such reactions, involving the ordinary carboxylic esters, the following steps are suggested by Remick.<sup>52</sup>

*First step:*

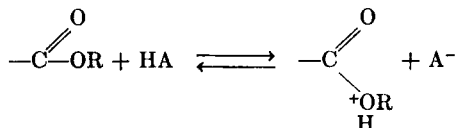

*Second step:*

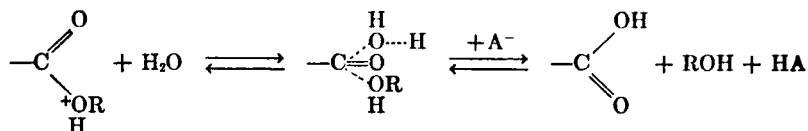

"The hydrogen ion from the acid coordinates with the oxygen atom of the OR group (first step) while the oxygen atom of the water molecule leads a nucleophilic attack on the central carbon atom, causing the stretching and the eventual rupture of the C— $\overset{+}{\text{O}}\text{R}$  bond (second step)

which has already been weakened by the positive charge conferred by the proton."

Application of this simple and clear concept to the acid hydrolysis of carbohydrate orthoesters leads to a reaction sequence initiated by the coordination of the first proton to the most strongly basic<sup>53</sup> dicovalent oxygen atom (first step).

*First step:*

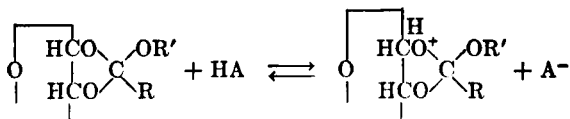

<sup>52</sup> A. E. Remick, "Electronic Interpretations of Organic Chemistry," John Wiley and Sons, Inc., New York, 1943, p. 400.

<sup>53</sup> In the system  $\begin{array}{c} \text{O}- \\ | \\ -\text{O}-\text{C}-\text{O}-\text{C} \\ | \quad \diagup \\ \text{O} \quad \text{O} \\ \quad \quad \diagdown \\ \quad \quad \text{O}- \end{array}$  the oxygen atom marked with an asterisk

may retain its complement of electrons, since the two flanking carbon atoms are well supplied with electrons by the oxygen atoms linked to them. Consequently, this oxygen atom appears to be the most basic and the one which the proton will attack first.

Second step:

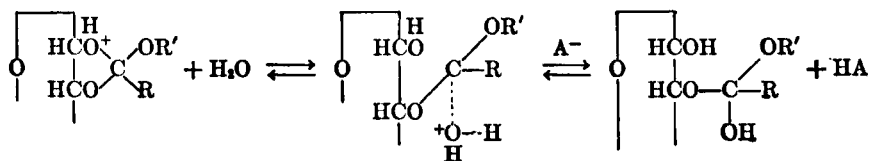

Third step:

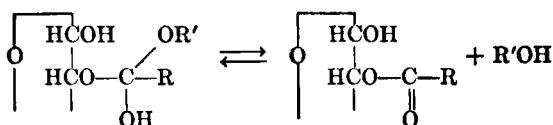

The second step controls the rate of the reaction and involves the rupture of the orthoester ring with the production of a *cis* configuration of the groups attached to carbon atoms 1 and 2. This step is followed by the loss of the alcohol molecule, R'OH, from the liberated alkyl hydrogen orthoester group on carbon atom 2 (third step). Either the loss occurs directly, or it takes place indirectly by the mechanism just described for the acid hydrolysis. In either case its rate is at least of the same order of magnitude as that of the second step. These steps are then followed by the comparatively slow mutarotation of the pure  $\alpha$  or  $\beta$  modification of the 2-mono-acyl-sugar which is now present in the solution. The rate of this mutarotation is only slightly influenced by the low hydrogen ion concentration usually employed for the hydrolysis of the orthoesters or by the rapid rate of the second step in the reaction. The mutarotation, however, can be entirely eliminated by rendering the solution sufficiently alkaline after the second step of the reaction.

## 2. Alkaline Hydrolysis

In general, the alkaline hydrolysis is a second order reaction between ester and hydroxyl ion and involves the rupture of the C—OR link. Remick<sup>52</sup> gives the following mechanism for the alkaline hydrolysis of esters: a nucleophilic attack on the carbonyl carbon atom by the hydroxyl ion (first step) simultaneously with, or followed by, an electrophilic attack of the water molecule (second step), which, by a displacement mechanism, breaks the C—OR linkage which has already been weakened by the repulsive effect of the free negative pole.

First step:

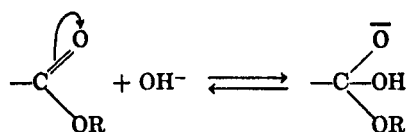

Second step:

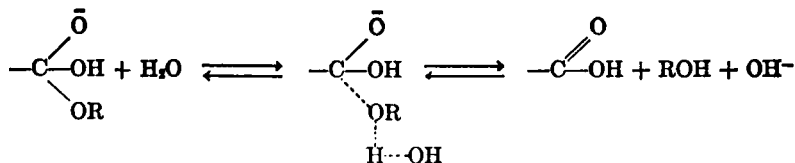

On the basis of this mechanism it can safely be predicted that neutral orthoesters will not suffer alkaline hydrolysis, since they do not contain the necessary carbonyl group. Indeed, the stability of the orthoesters in basic solutions is one of the characteristic properties of these substances. However, it is conceivable that under drastic conditions such as high temperature, fairly high hydroxyl ion concentration, or a long period of time, a nucleophilic attack on one of the R's by hydroxyl ion will result in a typical three-center displacement reaction:

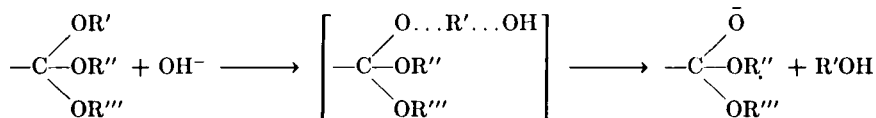

The first observation of the instability of carbohydrate orthoesters toward alkali came from Haworth, Hirst and Miller<sup>3</sup> in connection with their experiments on the simultaneous deacetylation and methylation of L-rhamnose methyl 1,2-orthoacetate. These authors noticed that methylation by methyl iodide and silver oxide in the presence of solid sodium hydroxide resulted in the formation of crystalline methyl trimethyl-β-L-rhamnopyranoside. A similar result was obtained by Bott, Haworth and Hirst<sup>6</sup> on the simultaneous deacetylation and methylation of triacetyl-D-mannose methyl 1,2-orthoacetate by the use of excessive quantities of dimethyl sulfate and alkali. The reaction produced a mixture of α and β forms of methyl tetramethyl-D-mannopyranoside but the yield was only 40%. When the acetylated orthoester was submitted to methylation with silver oxide and methyl iodide in the presence of sodium hydroxide, the product was mainly trimethyl-rhamnose methyl 1,2-orthoacetate. This result indicates that for the alkaline hydrolysis of orthoesters, hydroxyl ions are necessary. Such ions are present in the dimethyl sulfate-alkali process, but are absent in the methyl iodide treatment except when the reaction mixture contains a little water either by accident or from the decomposition of the sugar molecule. Haworth, Hirst and Samuels<sup>4</sup> examined the behavior of dimethyl-L-rhamnose methyl 1,2-orthoacetate in alkaline solution. When the substance was heated under various conditions with 0.1 N alkali at 70° there was no appreciable hydrolysis at the end of ninety minutes, whereas at 80° for

three hours, hydrolysis proceeded to the extent of 67% and at 100° it was complete in thirty minutes.

All of these experiments strongly indicate that the alkaline hydrolysis of the sugar orthoacetates is a nucleophilic displacement reaction. Any one of the three carbon atoms of the five-membered ring may be attacked. Since the hydroxyl ion must approach the tetrahedron of the attacked carbon atom in the direction of the center of the face opposite the vertex occupied by the group to be displaced, it is evident that the reaction must be accompanied by the inversion of configuration of the attacked carbon atom. It is quite certain that the attack does not take place on carbon atom 2, because in such a case the reaction product would be the epimeric sugar derivative. Therefore, either carbon atom 1 or the central carbon atom of the orthoester group is attacked. In the first case, the reaction is as follows.

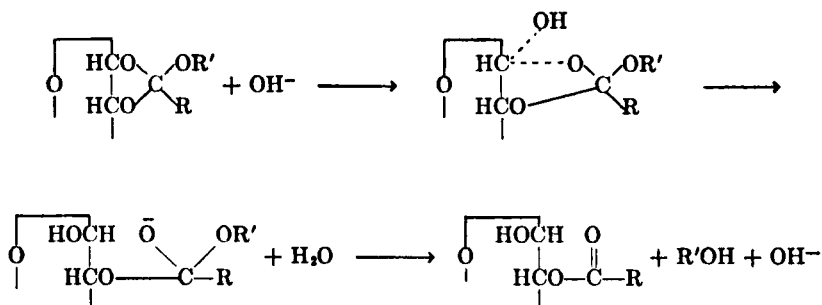

In the second case, the negative ion of an acidic orthoester is formed as an intermediate (*A*), which must decompose rapidly through *B*, into the normal 2-acyl-sugar.

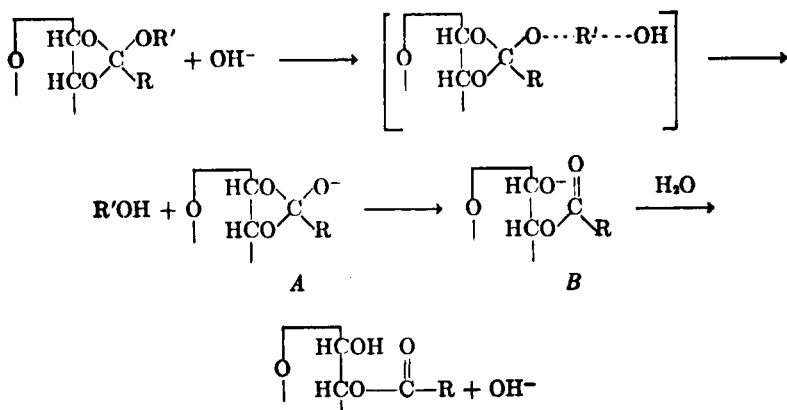

In either case, the sugar is liberated in its reducing form and is subject to all of the reactions which may occur in a strongly alkaline medium.

#### IV. PROOF OF STRUCTURE

##### 1. *Alkyl Orthoester*

*a. Physical Method.* Acetic acid and its esters with non-absorbing alcohols have a characteristic absorption in the ultraviolet which is ascribed to the carbonyl group. If the double bond in the carbonyl group is opened up by addition of water or by orthoester formation, this characteristic absorption should disappear or at least be quite different. According to Braun<sup>5</sup> if methyl L-rhamnoside monoacetate is an orthoester derivative, it should possess a shorter absorption wave length than methyl acetate. The absorption coefficient,  $\chi$ , of methyl acetate in hexane solution in the region measured by Braun was almost 10 times as large as that of L-rhamnose methyl 1,2-orthoacetate in alcoholic solution. This effect cannot be explained by difference in the solvents or by other physical influences. For diacetyl-L-rhamnose methyl 1,2-orthoacetate with two ordinary acetyl groups, the curve for the  $\log \chi$  was about 0.30 unit higher than that for methyl acetate, corresponding to two molecules of methyl acetate ( $\log 2 = 0.30$ ). For L-rhamnose methyl 1,2-orthoacetate and mono-isopropylidene-glucose, which differ only in that the former contains a methoxyl group instead of a methyl group, the absorption curves in aqueous solution almost coincided between 2100 Å and 1950 Å, and differed only in the longer wave lengths. These results indicated that the methyl rhamnoside monoacetate and, therefore, also the triacetate, are derivatives of orthoacetic acid.

*b. Chemical Method.* Haworth, Hirst and Miller<sup>3</sup> furnished the very important proof that L-rhamnose methyl 1,2-orthoacetate contained a six-membered ring; hence, the orthoester is a pyranose derivative. These authors submitted this crystalline compound to the methylation procedure by heating it in methyl alcohol with methyl iodide in the presence of silver oxide. The product, 3,4-dimethyl-L-rhamnose methyl 1,2-orthoacetate, crystallized in long, colorless needles, m. p. 67°. This substance was then hydrolyzed by treatment with 2% aqueous hydrochloric acid to the 3,4-dimethyl-L-rhamnose, which, on three subsequent methylations by the action of methyl iodide and silver oxide, gave rise to crystalline methyl 2,3,4-trimethyl- $\beta$ -L-rhamnopyranoside. The structure of the latter was proved by its ultimate conversion to (*levo*)-trimethoxyglutaric acid. The conclusion is therefore reached that the ring system of L-rhamnose methyl 1,2-orthoacetate is six-membered.



Likewise, experiments by Bott, Haworth and Hirst<sup>6</sup> resulted in the elucidation of the ring system present in D-mannose methyl 1,2-orthoacetate. This substance, which was obtained by the elimination of three acetyl groups from its acetate with cold alkali, behaved in a manner similar to that of the rhamnose methyl orthoacetate, so there could be no profound change of structure during the partial deacetylation process. It gave, on methylation, 3,4,6-trimethyl-D-mannose methyl 1,2-orthoacetate. The acetyl group in this substance also exhibited the same resistance toward alkaline reagents which was observed in the original acetate. The trimethyl derivative lost both the mannosidic methyl group and the acetyl group with 2% acid at 100° and yielded crystalline 3,4,6-trimethyl- $\alpha$ -D-mannopyranose, a substance of known structure. From these experiments, it was inferred that D-mannose methyl 1,2-orthoacetate possessed a six-atom ring.

Simultaneous deacetylation and methylation of the acetylated orthoesters under strongly alkaline conditions as discussed previously in the paragraph on alkaline hydrolysis, also gives rise to pyranosides. Although transitory formation of reducing sugar derivatives occurs under such conditions, there is no disturbance of the pyranose ring structure, since methyl groups already occupy positions linked with the normal acetyl groups before the removal of the orthoacetic ester group is initiated.

Evidence in favor of the 1,2-position of the orthoacetate group in 3,4-diacetyl-L-rhamnose methyl 1,2-orthoacetate was obtained by MacPhillamy and Elderfield.<sup>64</sup> The starting material, on treatment with hydrogen chloride in methanol after the manner of Isbell,<sup>13</sup> produced the expected mixture of the known<sup>3</sup> methyl  $\beta$ -L-rhamnopyranoside triacetate and, presumably, L-rhamnose 3,4-diacetate. The former compound was easily isolated by crystallization from water. The latter, excessively soluble in water, could not be crystallized and decomposed on attempted distillation. However, on direct methylation it yielded methyl 2-methyl-L-rhamnopyranoside 3,4-diacetate with a boiling point of 116–118° at 0.2 mm. pressure. This sirup, on deacetylation followed by hydrolysis of the glycosidic methyl group, gave 2-methyl-L-rhamnose. The location of the methyl group was shown by formation of L-rhamnose-*p*-nitrophenylosazone with loss of the methyl group at carbon atom 2, a characteristic behavior of 2-methyl-sugars.

## 2. Acidic Orthoester

At the present time there is very little information available concerning the existence and properties of acidic orthoesters. It appears that

<sup>64</sup> H. B. MacPhillamy and R. C. Elderfield, *J. Org. Chem.*, **4**, 150 (1939).

their eminent role is that of an intermediate postulated in the mechanism of the so-called "acyl-migration," which occurs frequently on partially substituted carbohydrates and other polyhydric compounds. The main difficulty is that no good method exists by means of which the structure of a supposed acidic orthoester can be established beyond any reasonable doubt. From the various compounds with alleged acidic orthoester structures only a few exhibit a behavior which cannot be interpreted equally well by the assumption of a normal structure. Among the compounds to be considered in this group is the glucose tetraacetate which can be prepared from the  $\beta$ -D-glucose 1,2,3,4-tetraacetate of Oldham<sup>55</sup> and of Helferich and Klein<sup>56</sup> by the action of very dilute alkali. Helferich and Klein observed that the rotation of the 1,2,3,4-tetraacetate in aqueous solution varied with the different polarimeter tubes employed and that a change in rotation also occurred when the crystalline substance was previously melted in a vessel of platinum or common glass, but not in a Jena-glass or quartz container. For the preparation of the new isomer the starting material was dissolved in 0.001 *N* aqueous alkali, or, after the manner of Ohle,<sup>57</sup> in alcohol containing very little alkali.<sup>58</sup> The solution was then extracted with chloroform or evaporated under diminished pressure. From the pyridine solution of the residue the new isomer crystallized with one molecule of pyridine of crystallization, which was expelled by heating under reduced pressure for several hours at 70°. The pyridine-free compound melted at 134° and had  $[\alpha]_D^{21} -33^\circ$ . Helferich and Klein tentatively suggested that in the alkaline medium the acetyl group at carbon atom 4 in the 1,2,3,4-tetraacetate had wandered to position 6 and, therefore, that the structure of the new tetraacetate was  $\beta$ -D-glucopyranose 1,2,3,6-tetraacetate. They demonstrated that the pyranose ring remained undisturbed during this change since both the original material and the new isomer gave  $\beta$ -D-glucopyranose pentaacetate on acetylation with acetic anhydride and pyridine. They also recognized that a further transposition of acetyl residues must occur since, on methylation with methyl iodide and silver oxide, the supposed 1,2,3,6-tetraacetate was converted, although in slight yield, to the common methyl  $\beta$ -D-glucopyranoside 2,3,4,6-tetraacetate. However, Haworth, Hirst and Teece<sup>59</sup> contended that position 4 is remote from position 6 since these hydroxyl groups are situated in different planes in the  $\beta$ -glucopyranose configuration. This would make the formation of

<sup>55</sup> J. W. H. Oldham, *J. Chem. Soc.*, 127, 2840 (1925).

<sup>56</sup> B. Helferich and W. Klein, *Ann.*, 450, 219 (1926); 455, 173 (1927).

<sup>57</sup> H. Ohle, E. Euler and R. Lichtenstein, *Ber.*, 62, 2890 (1929).

<sup>58</sup> B. Helferich and A. Müller, *Ber.*, 63, 2142 (1930).

<sup>59</sup> W. N. Haworth, E. L. Hirst and E. G. Teece, *J. Chem. Soc.*, 1405 (1930).

an acidic orthoester intermediate between these positions improbable. Furthermore, methylation experiments carried out on glucopyranose 1,2,3,4-tetraacetate and Fischer and Delbrück's<sup>60</sup>  $\beta$ -D-glucopyranose 2,3,4,6-tetraacetate resulted in both cases in the formation of the common methyl  $\beta$ -D-glucopyranoside 2,3,4,6-tetraacetate. This led the authors to the view that in the isomerization of the 1,2,3,4-tetraacetate, the hydroxyls involved are those at 1 and 6, and that the converted glucose tetraacetate should be formulated as 2,3,4-triacetyl- $\beta$ -D-glucose 1,6-orthoacetic acid (XIX).

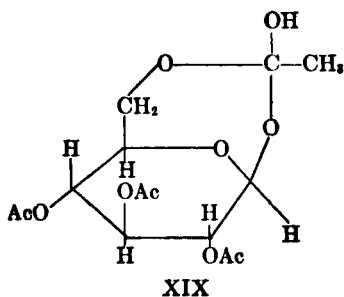

While the existence of such molecules would clarify the formation and the observed mutarotation of the pyridine compound, it would also seem that in the usual acetylation and methylation reactions an acidic orthoester would behave as though it possessed a normal structure. This would make impossible the exact proof of the structure of the acidic orthoesters by means of chemical transformations. The situation concerning this problem was not further clarified by Helferich and Müller's<sup>61</sup> contention that, contrary to the opinion of Haworth and coworkers, it is possible to construct a strainless orthoacid ring between positions 4 and 6 in the pyranose ring.

Another substance which may be considered to be an acidic orthoester derivative is Ohle's<sup>61</sup> 1,2-isopropylidene-D-glucufuranose mono-benzoate. This substance was prepared from 1,2-5,6-diisopropylidene-D-glucufuranose 3-benzoate by the careful removal of the 5,6-isopropylidene residue under acidic conditions. A slight alkalinity of the reaction mixture during any stage of the experiment caused the formation of Fischer and Noth's<sup>62</sup> 6-benzoyl-derivative. The new substance was isolated in sirupy form. Attempted distillation in high vacuum or the addition of one drop of dilute alkali or ammonia to its aqueous solution

<sup>60</sup> E. Fischer and K. Delbrück, *Ber.*, **42**, 2778 (1909).

<sup>61</sup> H. Ohle, *Ber.*, **57**, 403 (1924); H. Ohle and E. Dickhäuser, *ibid.*, **58**, 2593 (1925).

<sup>62</sup> E. Fischer and H. Noth, *Ber.*, **51**, 324 (1918).

caused this sirup to rearrange rapidly to Fischer and Noth's crystalline compound. It is a significant experimental fact that, unlike the equally alkali-sensitive 1,2-isopropylidene-D-glucofuranose 3-monoacetate of Josephson,<sup>63</sup> this 3-benzoyl-derivative could not be reconverted into the starting material by the action of acetone and anhydrous copper sulfate.<sup>57</sup> This is in harmony with Ohle's<sup>64</sup> view that in the new benzoyl-derivative the benzoyl group in position 3 is in some manner connected with the terminal group as shown in formula XX.

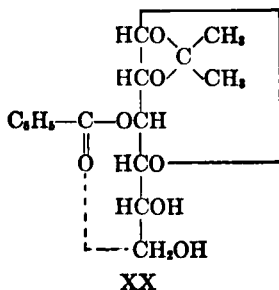

Ohle's formula essentially expressed the same features as are embodied in the orthoester formulas proposed<sup>66</sup> six years later for this type of sugar derivative. Unlike Helferich and Klein's glucose tetraacetate, this new benzoyl-derivative may very well possess an orthoacid structure, since the slightest alkalinity of the medium causes a rapid rearrangement of the compound into the normal 6-derivative.<sup>62</sup> On the other hand, the new glucose tetraacetate of Helferich and Klein<sup>66</sup> probably possesses a normal structure, since it is comparatively stable in alkaline medium, in fact, it is obtained from the 1,2,3,4-tetraacetate by the action of dilute alkali.

Of the other partly acylated sugars and sugar derivatives, Pigman and Isbell's<sup>18</sup> D-talose 1,2-orthobenzoic acid behaves in a similar manner to Ohle's benzoyl derivative. It is fairly stable toward acid but is unstable toward alkali. Apparently the alkalinity of pyridine and, perhaps, traces of alkalinity present in water and methyl alcohol are sufficient to produce irreversible changes that manifest themselves in the optical behavior of the respective solutions; these changes in rotation have not been investigated further.

Transitory formation of an orthoacid derivative during acyl migration undoubtedly occurs in the conversion<sup>63, 64</sup> of 1,2-isopropylidene-D-

<sup>63</sup> K. Josephson, *Ann.*, **472**, 217 (1929).

<sup>64</sup> H. Ohle, *Ber.*, **57**, 406 (1924).

glucofuranose 3-acetate to the 6-acetate derivative and in numerous other cases,<sup>65-68</sup> sometimes even in a strongly acidic medium.<sup>69</sup>

Regarding the new celtribiose heptaacetate of Richtmyer and Hudson,<sup>37</sup> the allocation of an orthoacid structure to this compound seems to be justified not so much by the absence of mutarotation as by the fact that it represents a surplus isomer which demands a chemical formula. However, such a formula need not necessarily be of an acidic orthoester type.

In conclusion, it can be stated that the lack of chemical reactions which are suitable for proving an acidic orthoester structure leaves the absorption measurements in the ultraviolet as the most promising method for the determination of structure. It would be very desirable if such measurements could be made on Ohle's monobenzoyl-derivative and on Pigman and Isbell's monobenzoyl-talose, since these molecules do not contain carbonyl groups in their orthoester forms.

### 3. *Orthoacyl Halide and Anhydride*

The only authentic orthoacyl halide known at the present time appears to be Freudenberg and Ivers'<sup>9</sup> acetylmaltosyl chloride. Its structure, however, has not yet been proved by direct evidence. From its extreme sensitivity toward water, which is an unusual behavior if the substance be of normal structure, and from the fact that it represents a surplus isomer, the allocation of an orthoacyl halide structure to this compound seems to be justified. Its easy conversion to alkyl orthoacetates, however, is not definitive evidence of its orthoacyl halide structure, first, because certain acylglycosyl halides with normal structures will give rise to such alkyl orthoacetates, and, secondly, because it reacts with water to give rise to normal maltose heptaacetate. Neither can the assumed<sup>5</sup> formation of a ketene acetal from the halogen compound be regarded as evidence of an orthoester structure.<sup>12</sup> The conversion of the chloro-compound to a new octaacetate, presumably an orthoacetic anhydride, appears to be a genuine reaction of an orthoacyl halide. Unfortunately, the substance obtained from the transformation is amorphous, and its properties and chemical behavior have not yet been studied.

<sup>65</sup> K. Josephson, *Ber.*, **62**, 316 (1929).

<sup>66</sup> W. N. Haworth, E. L. Hirst and E. G. Teece, *J. Chem. Soc.*, 2858 (1931).

<sup>67</sup> P. Brigl and H. Grüner, *Ann.*, **495**, 66 (1932).

<sup>68</sup> L. v. Vargha, *Ber.*, **67**, 1223 (1934).

<sup>69</sup> P. Brigl and R. Schinle, *Ber.*, **65**, 1890 (1932).

## V. MECHANISMS OF FORMATION AND CONVERSION

## 1. Mechanism of Formation

*a. Aldose Alkyl Orthoester.* When Fischer, Bergmann and Rabe<sup>1</sup> first observed the formation of three isomeric methyl L-rhamnoside triacetates from pure acetyl-L-rhamnosyl bromide in the Königs and Knorr<sup>7</sup> reaction, they recognized at once that the process could not be a simple exchange reaction between halogen and alkoxy as appears to be the case with acetylglucosyl bromide. In order to explain the simultaneous formation of isomers they proposed a complex mechanism for the Königs-Knorr process, based on what at that time appeared to be reasonable assumptions. According to their picture, the formation of a glycoside is initiated by the addition of the alcohol to the acetylglucosyl halide with the opening of the ring, as shown in formulas XXIa and XXIb:

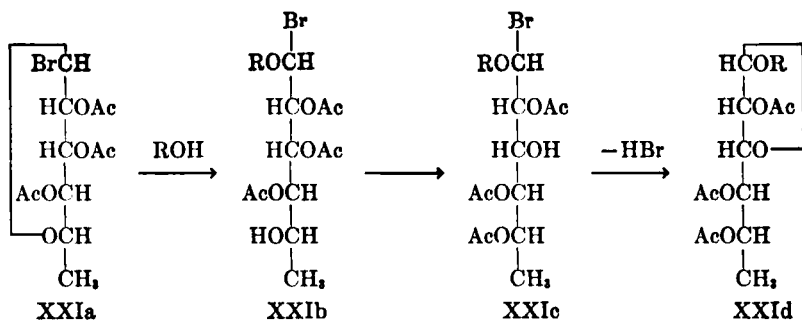

The addition product (XXIb) is essentially a partly acetylated alcohol. Consequently, it shows a pronounced tendency to rearrange with the migration of any of its acetyl groups to the free hydroxyl group at carbon atom 5. If the wandering acetyl group is the one at position 3, then the structure of the rearranged product is expressed by formula XXIc. If the hydrogen halide binding agent—silver carbonate in this case—exerts its action at this stage, a four-membered ring will be formed between carbon atom 1 and the free hydroxyl group at position 3 (XXId). The whole process may occur with the migration of an acetyl group other than the one at position 3. If, however, the silver carbonate exerts its action before the wandering of an acetyl group, the product will be a rhamnoside with normal pyranoid structure. These competitive reactions result in the formation of a mixture of ring-isomeric glycosides. Among the isomers the one with a four-membered ring structure was supposed to possess the distinctive property of containing at position 2 a sheltered acetyl group which, by virtue of "structural hindrance,"

was resistant toward alkali. When Haworth, Hirst and Miller<sup>3</sup> established that this methyl rhamnoside triacetate possesses a pyranoid structure, they concluded that its acetoxy group at carbon atom 2 was stabilized or obstructed by the interlocking effect of the adjacent groups (A), whereas in the easily hydrolyzable isomer no such obstruction prevailed (B).

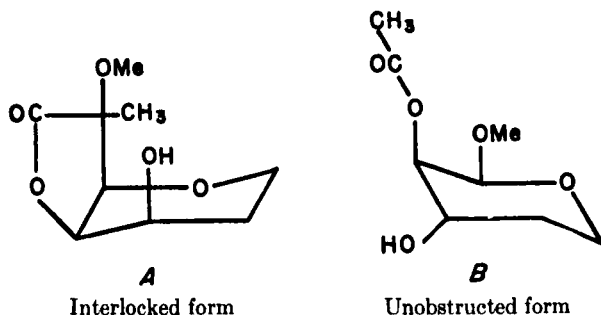

This novel form of stereoisomerism was based on the supposed existence of various conformations which a strainless pyranose ring may conceivably assume.<sup>70</sup> Although the true structure of these new varieties of glycosides was finally recognized,<sup>5, 6</sup> no serious effort has been put forth to elucidate the mechanism of the reaction which leads from the normal halides of certain acetylated sugars to orthoester derivatives. Neither have the structural requirements for such conversions been examined sufficiently to allow the prediction of the formation or non-formation of orthoesters in the Königs-Knorr procedure. The formation of orthoesters was looked upon as an anomaly which may arise whenever adjacent hydroxyl groups congregate in clusters on the same side of the six-atom ring.<sup>71</sup>

From his studies on models, Brauns<sup>72</sup> arrived at the conclusion that the arrangement of the groups of carbon atoms 1 and 2 in the acetylmannosyl halides is such that they can interact to yield derivatives with an orthoacetic acid ring formation. He illustrated with models how the acetyl group on the second carbon is directed to the hydrogen atom of the

<sup>70</sup> However, cf. E. Pacsu, *J. Am. Chem. Soc.*, **61**, 2673 (1939); A. Scattergood and E. Pacsu, *ibid.*, **62**, 903 (1940).

<sup>71</sup> W. N. Haworth, "Rapports sur les Hydrates de Carbon," *Xième Conférence de l'Union Internationale de Chimie, Liège, 1930.*

<sup>72</sup> D. H. Brauns, *J. Research Natl. Bur. Standards*, **7**, 573 (1931).

first carbon atom, which brings the double-bonded oxygen atom in the vicinity of the halogen. However, the solution of the problem of orthoester formation perforce had to wait until the general theory of displacement reactions had reached its present development.<sup>73</sup> In a meritorious publication by Miss Harriet Frush and Isbell,<sup>41</sup> the current principles relating to the mechanism of the Walden inversion are applied advantageously to the Königs-Knorr reaction to illuminate the problem of orthoester formation. Brauns' early conclusion concerning the important role of the acetoxy group at position 2 has gained complete justification through Winstein and Buckles'<sup>74</sup> results on the role of the neighboring groups in displacement reactions. In the light of all of these contributions it has become possible to have a clear and detailed picture of the mechanism of orthoester formation.

The nucleophilic displacement reaction taking place at a saturated carbon atom is either a bimolecular substitution,  $S_N2$  type, with complete Walden inversion, or a solvolytic reaction, characterized as a nucleophilic substitution of the first order,  $S_N1$  type, with predominant inversion.

In the first case, the nucleophilic displacing ion or molecule,  $Y^-$ , must approach the  $CR_1R_2R_3X$  tetrahedron in the direction of the center of the face opposite the vertex occupied by the X atom, or group of atoms:

*S<sub>N</sub>2 Type*

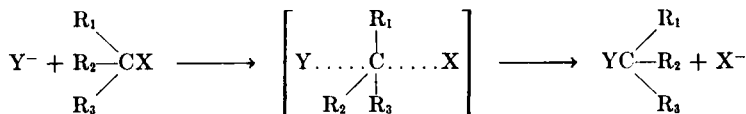

The attack is on the carbon atom; the driving force is the affinity of the nucleophilic reagent,  $Y^-$ , for carbon. In the transition state the R groups lie in a plane with the central carbon atom, and in the final product, on the opposite side of the carbon atom. The result is complete inversion, the rate of which is proportional to the concentration of the displacing ion or molecule,  $Y^-$ .

In the second case the reaction consists of two steps, the rate-determining step being the formation of a carbonium ion intermediate (A), and the second step, the reaction of this carbonium ion with a solvent molecule:

<sup>73</sup> L. P. Hammett, "Physical Organic Chemistry," McGraw-Hill Book Co. Inc., New York, N. Y., 1940, Chapters V and VI.

<sup>74</sup> S. Winstein and R. E. Buckles, *J. Am. Chem. Soc.*, **64**, 2780, 2787 (1942).

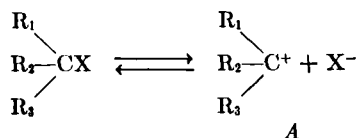
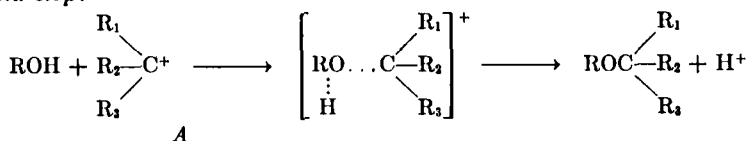

*S<sub>N</sub>1 Type**First step:**Second step:*

The attack is on the  $X^-$  ion; the driving force is the affinity of the solvent molecules for such ion, or the affinity of the electrophilic reagent for the  $X^-$  electrons. The reaction of the carbonium ion intermediate and the solvent molecule occurs after the ionization has taken place but while the two ions are still so close together that the  $X^-$  ion shields the carbonium ion against attack on the side from which the  $X^-$  has separated. Hence, the solvent molecule must approach the carbonium ion opposite the departing  $X^-$  and inversion will be the result. If reaction of the carbonium ion intermediate and solvent molecule takes place after the departure of  $X^-$ , a racemized product is the result.

The normal Königs-Knorr reaction is a  $S_N1$  type reaction with complete inversion on carbon atom 1:

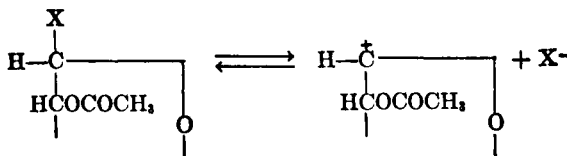
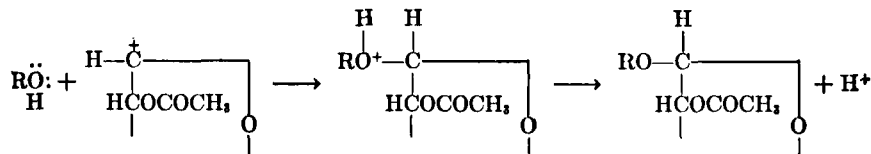
*First step:**Second step:*

Complication, however, is caused by the presence of a neighboring acetoxyl group, when the latter is situated on the side of the ring

opposite to the halogen atom. In such a case, the acetoxy group can participate in the replacement process by a  $S_N2$  type mechanism. This participation involves bond formation to the carbon atom that is being substituted, simultaneously with the removal of the halide ion, resulting in the formation of the carbonium ion intermediate (*B*).

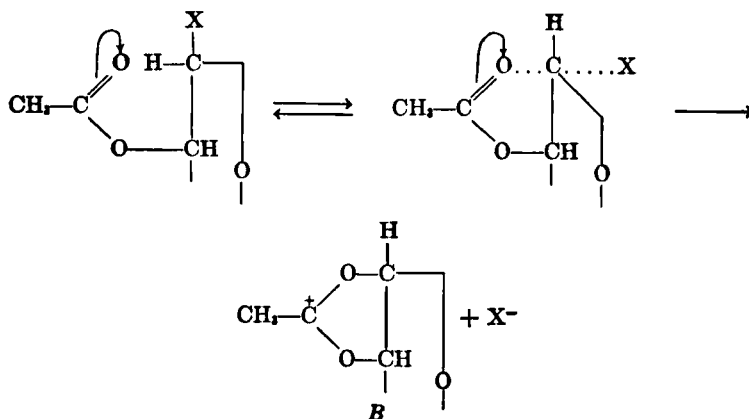

The solvent molecule may react with the intermediate *B* at either side of the positively charged carbon atom, thus giving rise to a possible mixture of conjugate acids of two diastereoisomeric orthoacetates which, by loss of protons, give rise to the orthoacetates themselves.

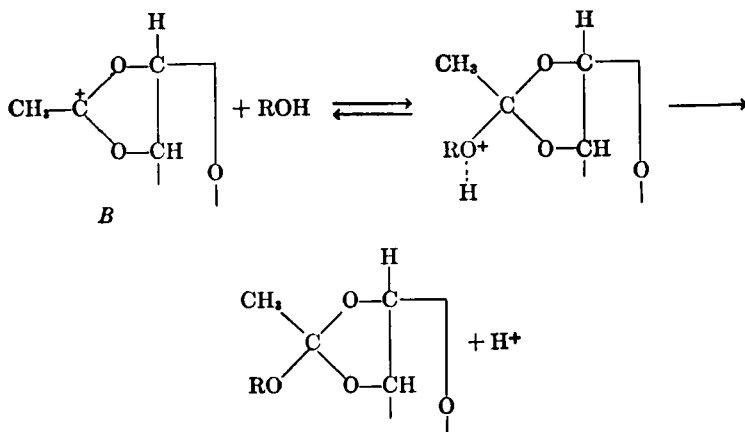

Because of resonance between the two possible forms, *B* and *B'*, of intermediate *B*,

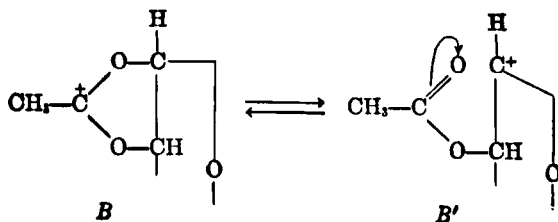

the solvent molecule may also react with  $B'$ . In such case, it is free to approach the unshielded carbonium ion on either side and the product of this side reaction is a mixture of the two normal glycosides with the  $\alpha$ - and  $\beta$ -configuration, respectively.

The net result of all these competitive reactions is a possible mixture of normal  $\alpha$ -<sup>16,17</sup> and  $\beta$ -glycosides and a possible mixture of two diastereoisomeric orthoesters.<sup>46</sup> In the course of the Königs-Knorr procedure, water is usually formed from the reaction between hydrogen halide and silver oxide. The water formed, or deliberately employed, may take the part of the solvent alcohol, thus giving rise to products such as acidic orthoesters<sup>37</sup> and normal tetra- and heptaacetates (for a disaccharide) of the sugars, and these compounds are subject to further changes, such as acyl migration.

The crucial requirement for the orthoester formation of the aldoses in the Königs-Knorr reaction is the presence of an acetoxy group at carbon atom 2 in a *trans*-position to the halogen atom at carbon atom 1. Consequently, the formation or non-formation of orthoesters constitutes a reliable chemical method of determination of the configurations of the groups around carbon atoms 1 and 2. Since the position of the groups around carbon atom 2 is known for every aldose, the position of the halogen in an acetylaldosyl halide may be determined. It must be *trans* to the acetoxy group at position 2 for all acetylaldosyl halides which give rise to orthoesters, and it must be *cis* to the acetoxy group at position 2 for all acetylaldosyl halides which do not give rise to orthoesters. According to this conclusion the "ordinary" form of acetyl-D-( $\alpha$ )-glucoheptosyl chloride<sup>27</sup> has a *cis* relationship between the halogen atom and the neighboring acetoxy group, because no orthoester is formed in the Königs-Knorr reaction. However, the "unstable" acetyl-D-( $\alpha$ )-glucoheptosyl chloride, prepared from the ordinary form by contact with silver chloride, has a *trans* relationship between the halogen atom and the neighboring acetoxy group, because it gives rise to tetraacetyl-D-( $\alpha$ )-glucoheptose methyl 1,2-orthoacetate in excellent yield.

*b. Aldose Orthoacyl Halide.* The common tetraacetyl-D-glucosyl chloride belongs to the *cis* series, since it does not give orthoesters, whereas

Freudenberg and Ivers<sup>9</sup> heptaacetylmaltosyl chloride, which is a 4- $\alpha$ -glucosyl-D-glucose derivative, does give orthoesters. However, the formation of the alkyl orthoacetates of maltose involves the displacement of the chlorine atom in a structure which is already of the orthoester type. The preparation of this acetylmaltose 1,2-orthoacetyl chloride from maltose octaacetate requires methods different from those employed for the preparation of the ordinary acetylaldosyl halides. Thus Freudenberg and Ivers<sup>9</sup> carried out the conversion in benzene solution by means of a moisture-free ether, hydrogen chloride reagent prepared at 0°. Under these experimental conditions, the proton presumably associates with the dicovalent oxygen atom<sup>53</sup> of the first acetoxy group. The addition of the proton must displace the electron system in such a way as to weaken the bond between this oxygen and carbon atom 1 and favor the rupture. The effect is, therefore, an electrophilic displacement of the carbonium ion from combination with oxygen by a proton, the driving force being the affinity of the proton for the oxygen electrons.

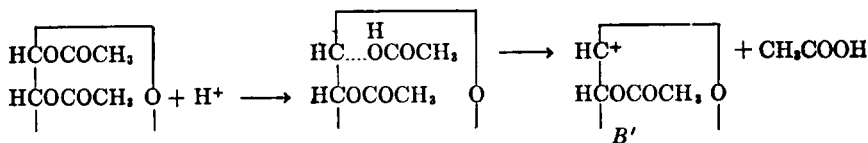

The subsequent attack of the nucleophilic chloride ion occurs either on the original carbonium ion (B'), or on its isomeric orthoester form (B), which can easily arise through the participation of the neighboring acetoxy group.

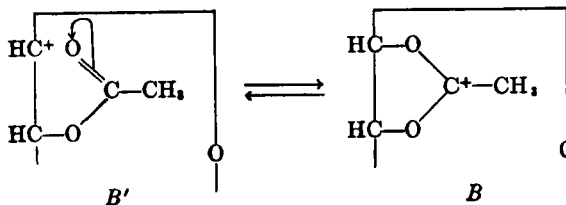

Since the original carbonium ion in this reaction is not shielded by a negative ion, the neighboring acetoxy group participating in the transformation may occupy either side of the plane and thus, under the experimental conditions of the Freudenberg-Ivers procedure, any reducing sugar might give rise to orthoacetyl halides. This conclusion, however, needs experimental verification.

Aluminum chloride has also been used<sup>11</sup> for the preparation of acetylmaltose 1,2-orthoacetyl chloride. This reagent is a powerful electro-

philic substance, the driving force being its tendency to make up an octet of shared electrons by attacking the unshared pairs of available atoms. Attaching itself to the divalent oxygen atom of the first acetoxy group, it claims the available electrons so strongly as to cause the rupture of the bond between that oxygen and the first carbon atom. The result is a combination of the carbonium ion intermediate with the

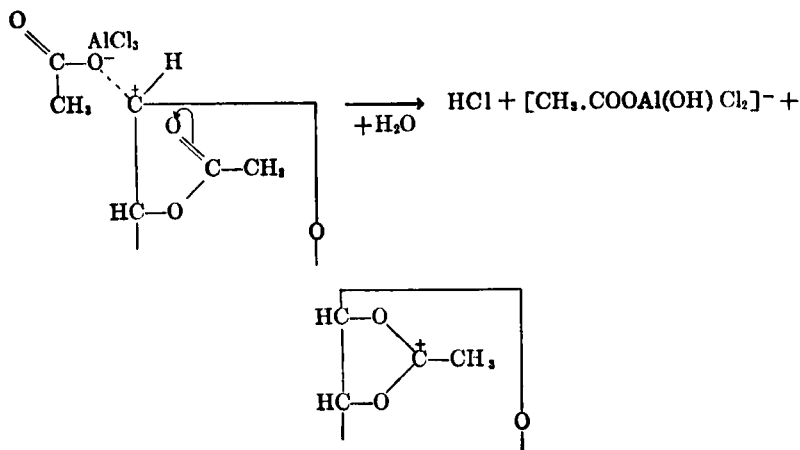

[CH<sub>3</sub>.COOAlCl<sub>2</sub>]<sup>-</sup> negative ion. The complex is insoluble in chloroform, consequently traces of moisture are necessary for breaking up the solid. This is a slow process and requires prolonged standing at moderate temperature. The nucleophilic chloride ions originating from the action of traces of water on the complex negative aluminum ion then attack either form of the carbonium ion as discussed in the previous case. Obviously, any successful result by means of this method depends on the right quantity of water present, an important condition which has not yet been studied with thoroughness. Also, the quantity of aluminum chloride employed appears to be of importance, because a large excess will promote its association with the divalent oxygen atoms of other acetoxy groups present in the molecule, thus causing complications which may result in the inversion of one or more of the asymmetric centers of the sugar.<sup>37</sup>

c. *Ketose Alkyl Orthoester.* The formation of orthoesters in the ketose series does not exclusively require a *trans*-orientation of the acetoxy group at position 3. It has already been pointed out by Isbell<sup>41, 76</sup> that carbon atom 1 of the ketoses is free to rotate about the carbon-carbon axis, consequently the acetoxy group of carbon atom 1 can always be brought into a favorable position for the orthoester reaction, and all of the ketoses

<sup>76</sup> H. S. Isbell, *Ann. Rev. Biochem.*, 9, 65 (1940).

are therefore capable of orthoester formation. Of course, the acetoxy group at position 3 may also be in a favorable position to participate in the reaction. Therefore, with the exception of the crystalline orthoesters of turanose,<sup>29,30</sup> which is a 3-glucosyl-D-fructose, the sirupy orthoesters of the other ketoses<sup>34,39</sup> represent mixtures and their structures at present are unknown. The formation of orthoesters in the ketose series does not determine the configurational relationship between the acetoxy group at position 3 and the halogen atom at position 2. The mechanism is the same as that of the aldose analogues.

*d. aldehydo-Aldose Alkyl Orthoester.* The conversion of Wolfrom and Weisblat's<sup>42</sup> 1-chloro-1-thioethoxy-aldehydo-D-galactose pentaacetate to 1-thioethoxy-aldehydo-D-galactose ethyl 1,2-orthoacetate 3,4,5,6-tetraacetate is in harmony with the view that whenever the two adjacent carbon atoms carrying the halogen atom and the acetoxy group are free to rotate about their axis, orthoester formation may occur in the Königs-Knorr reaction, irrespective of the configuration of the sugar employed.

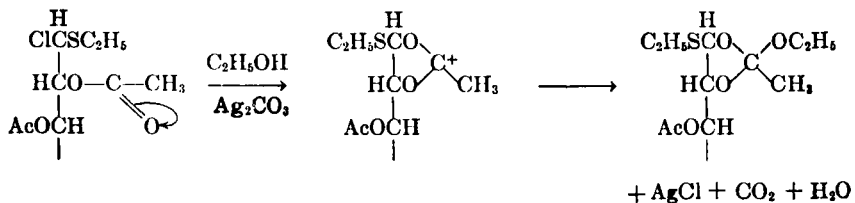

## 2. Mechanism of Conversion

*a. Hydrogen Chloride in Chloroform.* The mechanism of the conversion<sup>13, 18, 21, 41, 46</sup> of carbohydrate alkyl orthoacetates to normal acetylglucosyl halides in anhydrous chloroform solution saturated with dry hydrogen chloride, is presumably similar to that discussed in connection with the Freudenberg-Ivers<sup>9</sup> reaction. It is an electrophilic displacement of the carbonium ion by a proton at position 1. The addition of the proton displaces the electron system in such a way as to weaken the bond between the most basic<sup>53</sup> oxygen atom and carbon atom 1, eventually causing the scission. The process is fundamentally different

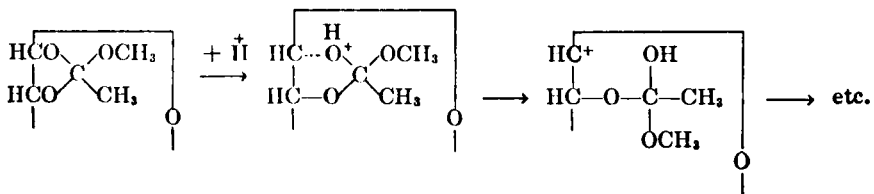

from the mechanism of the acid-catalyzed hydrolysis of the orthoesters, where the oxygen atom of the solvent molecule can carry out a nucleophilic attack on the central carbon atom (second step), causing the

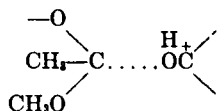

rupture of the bond. There is no water molecule present in this experiment. The unshielded carbonium ion intermediate is subsequently attacked by the nucleophilic chloride ion on either side, while the acidic orthoester group at position 2 changes into the normal acetoxy group by loss of methyl alcohol. Because of the formation of alcohol in the process, further secondary conversions are possible, hence the expected acetylglycosyl halide in most cases cannot be isolated in crystalline form.

*b. Titanium Tetrachloride in Chloroform.* The same picture applies to the reaction between titanium tetrachloride<sup>12,13</sup> and an orthoester in anhydrous chloroform solution. The reagent is a very powerful electrophilic substance, the driving force being its tendency to use its free 3*d* orbitals by attacking the unshared electron pairs of available atoms. It adds to the most basic<sup>63</sup> divalent oxygen atom with instantaneous formation of deeply colored halochromic salts. Water in sufficient

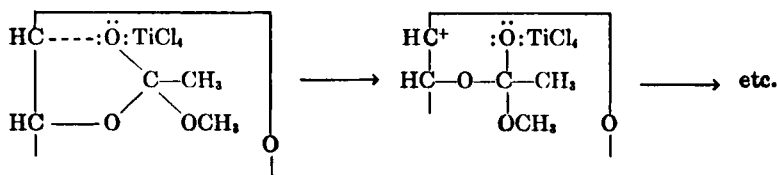

quantity for the decomposition of the negative ion is necessary. This

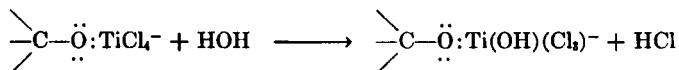

process usually requires prolonged heating of the heterogeneous reaction mixture, during which time the nucleophilic chloride ion associates with the unshielded carbonium ion on either side of the plane. The subsequent treatment of the reaction mixture with cold water results in the decomposition of the titanium-acetoxy complex at position 2, and the formation of the stable acetylglycosyl chloride.

*c. Hydrogen Chloride in Methyl Alcohol.* The behavior of a carbohydrate orthoester with hydrogen chloride in methyl alcohol does not indicate a simple reaction. The reagent itself can hardly be considered

uniform since anhydrous methyl alcohol reacts fairly rapidly with anhydrous hydrogen chloride to give water and methyl chloride. The latter, being volatile at ordinary temperature, escapes from the mixture, but water remains in the supposedly anhydrous medium and may also react with the orthoester. The concentration of the chloride ion in the reagent is usually not large enough to cause more than a small amount of displacement on the first carbon atom. This results in a slight amount of acetylglycosyl chloride, which subsequently reacts with methyl alcohol and silver carbonate to give the normal acetylated methyl  $\beta$ -glycoside.<sup>2, 13</sup> The main reaction probably is an acid-catalyzed methanolysis or ester interchange which may affect all of the acetoxy groups present in the molecule with the production of the deacetylated sugar,<sup>16</sup> or, if the time of interaction is sufficiently short, it may affect only the cyclic orthoester part of the molecule, resulting in a partly deacetylated product.<sup>13, 54</sup> The mechanism of methanolysis should be similar to that of acid-catalyzed hydrolysis with the exception that in this case it is the oxygen atom of the methyl alcohol molecule which leads the nucleophilic attack on the central carbon atom.

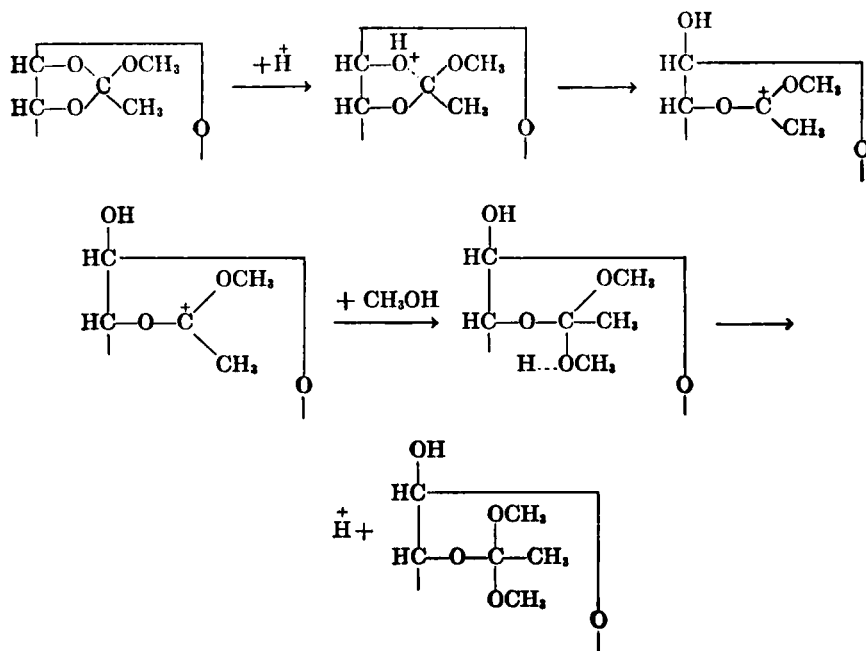

The first product of the ester interchange is another orthoester which, on further methanolysis, gives a partly acetylated sugar with free hydroxyl groups at positions 1 and 2, and trimethyl orthoacetate.



In the presence of a sufficient quantity of water, the first product may suffer hydrolysis into the partly deacetylated sugar, methyl acetate and methyl alcohol. Of course, the reagent may contain enough water for a direct hydrolysis, the rate of which, however, will be slower in such aqueous alcoholic medium, than in pure aqueous hydrochloric acid.<sup>29</sup>

## VI. CONCLUSION

Although the presence of an orthoester structural grouping in the third varieties of methyl rhamnoside and mannoside acetates was firmly established by chemical and physical methods, one important question remained unanswered: what configurations and conditions are necessary for the formation of orthoesters? Haworth suggested that congregation in clusters of adjacent hydroxyl groups on the same side of the six-atom ring as in  $\beta$ -mannose,  $\beta$ -lyxose and  $\beta$ -rhamnose would give rise to orthoesters in the Königs-Knorr process. In such configurations, it was supposed, interlocking of groups occurs at positions 1, 2 and 3 to restrict vibrational movement of the components of the ring or rotation of the addenda. It became quite evident that the steric position of the acetoxy group at carbon atom 2 must have a significant role in orthoester formation. Brauns, by studies on models (1931), arrived at the conclusion that in the acetylmannosyl halides the hydrogen atom of the first asymmetric carbon atom, to which the halogen atom is attached, is influenced by atoms of the second acetyl group in such manner that the groups of the first and second carbon atoms can interact to give an orthoacetic acid ring. Interesting as these early explanations are they have failed in one important point, namely, in giving a comprehensive understanding of the process so as to enable one to make intelligent predictions in untried cases. A comprehensive picture, however, could not be offered as long as the basic factors which control the mechanism of orthoester formation have not been taken into consideration. Among these factors are the mechanisms of the various types of replacement reactions, the role of the neighboring groups in such reactions and the mechanism of the Walden inversion. The first application by Isbell and Miss Frush of the opposite-face concept for the Walden inversion to orthoester formation resulted in the virtual solution of the problem. The concept was tested by application of the Königs and Knorr reaction to two new cases with gratifying result; both acetylglycosyl halides, as predicted, have yielded the corresponding orthoesters. The picture is quite clear today. The Königs and Knorr reaction is a solvolytic process, consequently it is initiated by the ionization of the halogen atom on the first carbon atom. Orthoester formation will occur whenever the oxygen atom of the neighboring acyl group can approach the carbonium ion intermediate from

the face which is opposite to the shielding halogen atom. Clearly, this can occur only if the halogen atom and the neighboring acetoxy group are in the *trans* position. Since the configuration of the second carbon atom for all of the aldoses is known with certainty, the configuration of the first carbon atom in the acetyldosyl halides employed is thereby determined; the halogen atom must be *cis* to the acetyl group at position 2 for those acetyldosyl halides which do not give orthoesters and *trans* for those which do give orthoesters.

Of the two diastereoisomeric forms of every acetyglycosyl halide either in the D- or L-series, for reasons yet unknown, only one form seems to be stable under ordinary conditions. These are the "normal" or "stable" acetyglycosyl halides, which are usually employed in the Königs and Knorr reaction. It is also an experimental fact that in every epimeric pair of the pentoses or hexoses only one member of the pair gives orthoester derivatives. If all of the "normal" acetyldosyl halides in the D-series would have a like configuration on the first carbon atom, then only those would give orthoesters which would have their acetyl group at position 2 *trans* to the fixed position of the halogen atom. This appears to be the case in the hexose series, where the three epimeric pairs so far investigated must carry their halogen atoms on the right side of the first carbon atom as shown in the customary projection formula. This follows from the fact that glucose, galactose and allose have no orthoester cyclic derivatives, whereas mannose, talose and altrose (neolactose) do have such derivatives. An unambiguous desig-

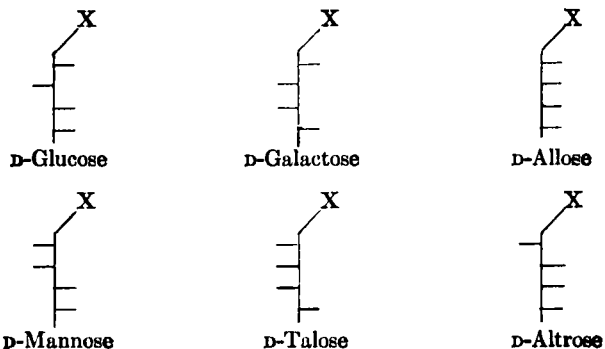

nation of these substances would require the use of the symbols "1,2-*cis*" and "1,2-*trans*" before the names of the compounds, thus 1,2-*cis*-2,3,4,6-tetraacetyl-D-glucosyl bromide, 1,2-*trans*-2,3,4,6-tetraacetyl-D-mannosyl chloride. The gulose-idose pair has so far not been investigated. Although "unstable" acetyl-D-( $\alpha$ )-glucoheptosyl chloride with its potential

glucose configuration gives rise to orthoesters it does not necessarily follow that a "normal" acetyl-D-gulosyl halide will behave similarly.

However, in the pentose series not all of the "normal" acetylglycosyl halides have a like configuration on the first carbon atom. This follows from the fact that in the arabinose-ribose epimeric pair it is the ribose and not the arabinose which has orthoester derivatives. Consequently, in the "normal" halides of these two pentoses, the halogen atoms must occupy the left side positions of the first carbon atoms and the names of these substances are, respectively, 1,2-*trans*-2,3,4-triacetyl-D-ribose halide and 1,2-*cis*-2,3,4-triacetyl-D-arabinosyl halide.

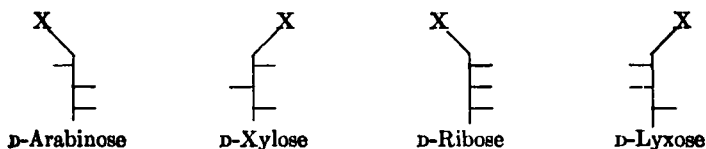

The same situation prevails regarding the positions of the halogen atoms in the two acetylheptosyl halides which have so far been investigated; the halogen atoms occupy the left sides of the first carbon atoms.

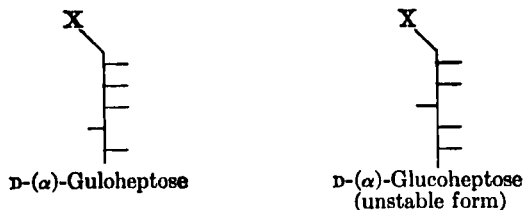

However, it should be noted with great interest that in the case of the acetyl-D-( $\alpha$ )-glucoheptosyl chlorides it is the "unstable" form which gives an orthoester. The "normal" form, therefore, must have the halogen atom on the right side of the first carbon atom and thus be a 1,2-*cis*-compound. Consequently, one may predict that in the "unstable" series of the acetylalidosyl halides, orthoesters will be obtained from those sugars which do not give rise to orthoesters when their "normal" halides are employed in the Königs and Knorr procedure.

Regarding the orthoester formation in the ketose series, any acetyl-ketosyl halide may give at least a 1,2-orthoester because the acetyl group at position 1 is always free to approach, from the opposite side, the halogen atom at position 2 in either modification of the halide.

In conclusion, it should be emphasized that the elucidation of the true configurations of the groups around the first two carbon atoms in the

aldoses by means of orthoester formation rests on the general principles of the mechanism of displacement reactions. The configurations which have been shown to follow from this method of determination are entirely independent of any system of nomenclature that may be devised as a convention for classifying D and L sugars and their  $\alpha$  and  $\beta$  anomeric forms. The configurations represent geometrical relationships in space and are not influenced by names that may be given to them.

This Page Intentionally Left Blank

# THIO- AND SELENO-SUGARS

BY ALBERT L. RAYMOND

*G. D. Searle & Co., Chicago, Illinois*

## CONTENTS

I. Thiosugars . . . . .	129
1. Natural Thioglycosides . . . . .	129
2. Synthetic Thioglycosides . . . . .	132
3. 1-Thioaldoses . . . . .	134
4. Thioglycosides from Mercaptals . . . . .	136
5. Thioaldoses (other than 1-Thioaldoses) . . . . .	141
II. Selenosugars . . . . .	144

## I. THIOSUGARS

### 1. *Natural Thioglycosides*

In view of the rarity of this group of sugars, it is interesting that the first example was observed over a hundred years ago. Henry and Garot<sup>1</sup> in 1825 had reported that white mustard seed, on treatment with alcohol, yields a crystalline compound containing nitrogen and sulfur, which they named sulfosinapisin. Somewhat later, Robiquet and Boutron-Charlard<sup>2</sup> isolated a second substance, sinalbin, which differed chemically from sulfosinapisin and was a glycoside, liberating a reducing sugar on acid hydrolysis. Still later v. Babo and Hirschbrunn<sup>3</sup> described a good method of preparing sinalbin in small quantities and also identified sulfosinapisin as the sulfocyanate of a new compound, sinapin. Will and Laubenheimer<sup>4</sup> improved the preparation of sinalbin and investigated its structure. By subjecting it to hydrolysis by an enzyme, myrosin, first described by Bussy,<sup>5</sup> they were able to secure, as products of the reaction, a sinalbin thiocarbamide, sinapin sulfate and a sugar.

Another glycoside belonging in the same category as sinalbin is sinigrin, which is the potassium salt of a complex acid, myronic acid. It

<sup>1</sup> Henry and Garot, *J. chem. medicale*, **1**, 439, 467 (1825).

<sup>2</sup> P. J. Robiquet and Boutron-Charlard, *J. pharm.*, **17**, 288 (1831).

<sup>3</sup> L. v. Babo and M. Hirschbrunn, *Ann.*, **84**, 10 (1852).

<sup>4</sup> H. Will and A. Laubenheimer, *Ann.*, **199**, 150 (1879).

<sup>5</sup> A. Bussy, *J. pharm.*, **26**, 39 (1840); *Ann.*, **34**, 223 (1840).

was probably first detected by Boutron and Robiquet<sup>6</sup> and by Fauré<sup>7</sup> who showed that while mustard seed does not originally contain an ethereal oil, such a substance is developed in the presence of water. Sinigrin was apparently first isolated by Bussy<sup>8</sup> along with the myrosin mentioned above. Although Bussy's work was disputed, it was eventually confirmed in its entirety by Will and Körner<sup>8</sup> who did preliminary work on the structure of the compound.

The problem was resolved by Gadamer<sup>9</sup> who further improved the preparation of the glycosides and then subjected them to hydrolysis. Both substances are split by the enzyme myrosin, D-glucose being liberated in each case. Sinigrin, in addition, yields allyl isothiocyanate and potassium acid sulfate. On hydrolysis of sinigrin with barium hydroxide solution, sulfuric acid is first split off but the intermediate thus formed is unstable, and on further hydrolysis, gives D-glucose and allyl isothiocyanate. On the basis of these and related reactions, Gadamer assigned the structure:

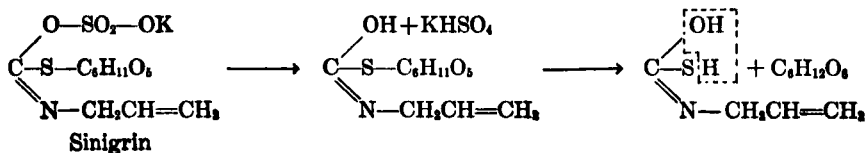

Schneider and Wrede,<sup>10</sup> using potassium methoxide as the hydrolytic agent in place of myrosin, isolated thioglucose and merosinigrin. The latter results by closure of a new ring, after removal of the sulfuric acid group.

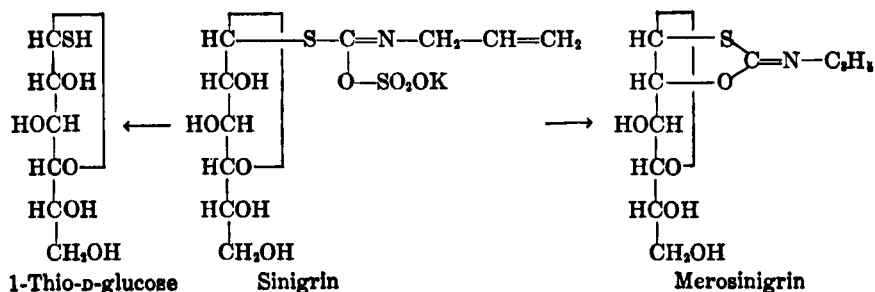

<sup>6</sup> F. Boutron and P. J. Robiquet, *J. pharm.*, **17**, 294 (1831).

<sup>7</sup> Fauré, *J. pharm.*, **17**, 299 (1831).

<sup>8</sup> H. Will and W. Körner, *Ann.*, **125**, 257 (1863).

<sup>9</sup> J. Gadamer, *Arch. Pharm.*, **235**, 44, 83 (1897); *Ber.*, **30**, 2322, 2327 (1897).

<sup>10</sup> W. Schneider and F. Wrede, *Ber.*, **47**, 2225 (1914).

Schneider and Wrede<sup>10</sup> assumed a furanose ring for the merosinigrin in conformity with the general practice of that time, but appreciated that the second ring need not necessarily be in position (2). This structure does not appear to have been further investigated or confirmed.

Sinalbin undergoes hydrolysis by myrosin to give sinapin (as the bisulfate), *p*-hydroxybenzyl isothiocyanate and D-glucose. Sinapin, in turn, hydrolyzes readily to choline and sinapinic acid. The structure of the latter was ascertained<sup>11</sup> by oxidation to known reference substances.

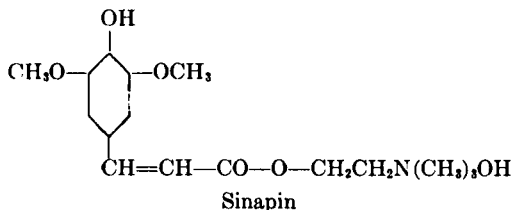

On the basis of these and other data, sinalbin was assigned the structure:

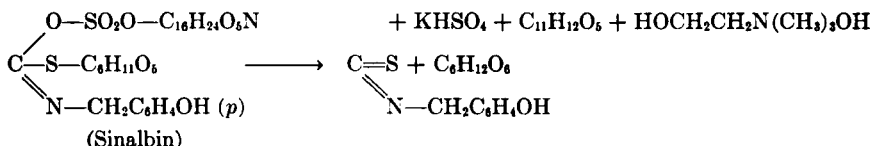

Two additional glucosides of this same series are glucotropaeolin and gluconasturtiin. Hofmann<sup>12</sup> had obtained benzyl isothiocyanate among other hydrolytic products, but it was Gadamer<sup>13</sup> who assigned the structures. These were based upon analogy with sinalbin and sinigrin and upon identification of the respective isothiocyanates.

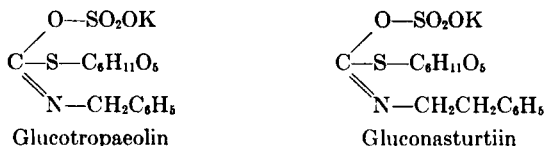

A final example of this unusual series of compounds is the glucoside, glucocheirolin, first reported by Wagner<sup>14</sup> and investigated in considerable detail by Schneider and co-workers.<sup>15</sup> Like the previous examples, it

<sup>11</sup> J. Gadamer, *Arch. Pharm.*, **235**, 92 (1897); *Ber.*, **30**, 2328, 2330 (1897).

<sup>12</sup> A. W. Hofmann, *Ber.*, **7**, 518, 520 (1874).

<sup>13</sup> J. Gadamer, *Arch. Pharm.*, **237**, 111, 507 (1899); *Ber.*, **32**, 2338 (1899).

<sup>14</sup> P. Wagner, *Chem.-Ztg.*, **32**, 76 (1908).

<sup>15</sup> W. Schneider, *Ber.*, **41**, 4466 (1908); W. Schneider, *Ann.*, **375**, 207 (1910); W. Schneider and W. Lohmann, *Ber.*, **45**, 2954 (1912); W. Schneider and L. A. Schütz, *Ber.*, **46**, 2634 (1913).



is completely hydrolyzed by myrosin, giving D-glucose, potassium acid sulfate and cheirolin,  $\text{CH}_3 \cdot \text{SO}_2 \cdot \text{CH}_2 \cdot \text{CH}_2 \cdot \text{CH}_2 \cdot \text{NCS}$ . From these data, and by analogy with sinigrin, its structure was assigned:

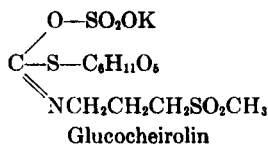

## 2. Synthetic Thioglycosides

Extending his studies in this series, Schneider, with various co-workers, next undertook the synthetic approach. Fischer and Delbrück<sup>16</sup> in 1909 had synthesized a thiophenyl D-glucoside by the reaction of acetobromo-D-glucose with sodium thiophenoxide. Schneider and co-workers<sup>17</sup> substituted the silver salt of thiourethans for the sodium thiophenoxide, and in this way prepared, first as the acetates, and then, after hydrolysis, as the free glucosides, *N*-allyl, *N*-benzyl and *N*-phenyl urethan glucosides. Following this same procedure, but using silver cheirolin urethan (I), obtained by starting from glucoscheirolin, they succeeded in securing the glucoside (II).

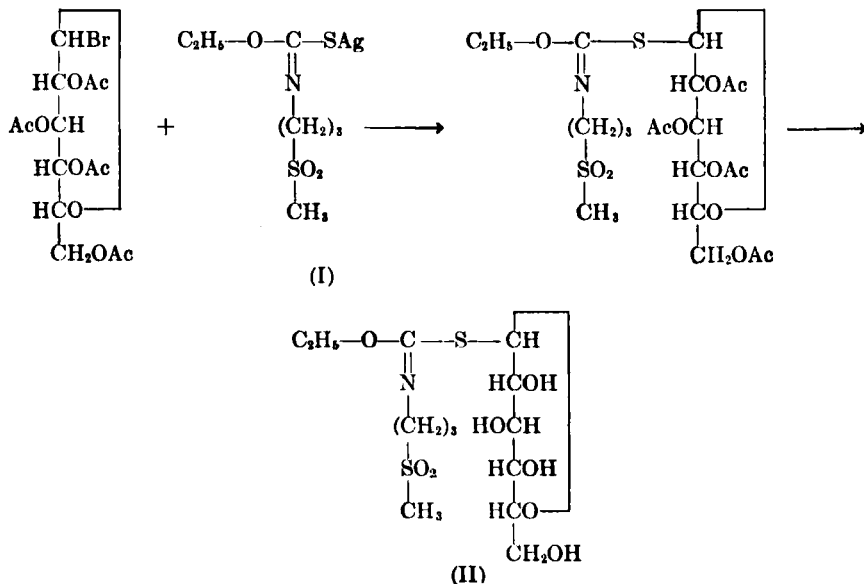

<sup>16</sup> E. Fischer and K. Delbrück, *Ber.*, **42**, 1476 (1909). See also P. Karrer, Rosa Baumgarten, S. Günther, W. Harder and Lina Lang, *Helv. Chim. Acta*, **4**, 130 (1921); C. B. Purves, *J. Am. Chem. Soc.*, **51**, 3619, 3631 (1929).

<sup>17</sup> W. Schneider, D. Clibbens, G. Hüllweck and W. Steibelt, *Ber.*, **47**, 1258 (1914).

From their method of preparation these compounds are evidently  $\beta$ -pyranosides, so it is of interest that, unlike all the natural thioglycosides, they are not hydrolyzed by the enzyme myrosin. The latter, therefore, must be either an  $\alpha$ -thiopyranosidase or a thiofuranosidase.

At about this same time, Schneider and Wrede<sup>18</sup> prepared an acetylated glucoside (III) using the silver salt of the O-phenyl ester of thio-

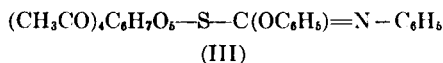

carbanilic acid and still later, Schneider and Eisfeld<sup>19</sup> obtained the glucoside tetraacetates of isothiurea (IV) and phenylisothiurea (V):

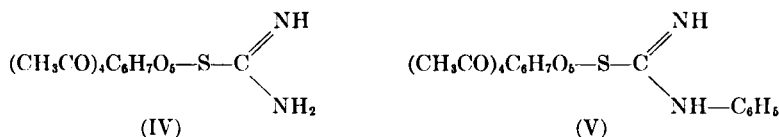

It was not found possible to obtain the unacetylated compounds in these cases, since hydrolysis split the molecule and gave 1-thio-D-glucose.

In 1914, Fischer<sup>20</sup> had treated acetobromo-D-glucose with silver thiocyanate and had obtained, as the acetyl derivative, the isothiocyanate. This work was later extended by Fischer and by others<sup>21</sup> and, fairly recently, by Müller and Wilhelms<sup>22</sup> and by Wilhelms.<sup>23</sup> These authors substituted potassium thiocyanate for the silver salt and, under the conditions employed, the product was the thiocyanate. However, when this was heated, it isomerized and the isothiocyanate, identical with that obtained by Fischer, resulted.

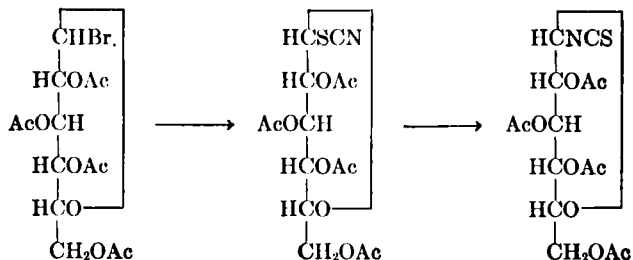

<sup>18</sup> W. Schneider and F. Wrede, *Ber.*, **47**, 2038 (1914).

<sup>19</sup> W. Schneider and K. Eisfeld, *Ber.*, **61**, 1260 (1938).

<sup>20</sup> F. Fischer, *Ber.*, **47**, 1378 (1914).

<sup>21</sup> E. Fischer, B. Helferich and P. Ostmann, *Ber.*, **53**, 873 (1920); K. M. Haring and T. B. Johnson, *J. Am. Chem. Soc.*, **55**, 395 (1933); T. B. Johnson and W. Bergmann, *J. Am. Chem. Soc.*, **60**, 1916 (1938).

<sup>22</sup> A. Müller and Adrienne Wilhelms, *Ber.*, **74**, 698 (1941).

<sup>23</sup> Adrienne Wilhelms, *Magyar Biol. Kutató Intézet Munkái*, **13**, 525 (1941).

Another series of interesting thiosugars was prepared by Schubert<sup>24</sup> by the action of cysteine on the aldoses. By analogy with the structure assigned<sup>25</sup> by this same author to the reaction product of cysteine with ordinary aldehydes, these new compounds may be formulated as the open chain forms:

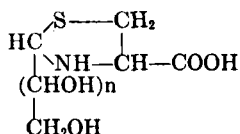

Fructose gave no isolable derivative in this same reaction.

### 3. 1-Thioaldoses

Thioglucose, mentioned above, is in general formed from all of the natural thioglucosides by the action of ammoniacal silver solutions. Thioglucose was further investigated by Schneider, Gille and Eisfeld<sup>26</sup> who used a procedure for its preparation, devised by M. Bergmann (unpublished), which consists of the reaction between acetobromoglucose and potassium xanthogenate, followed by hydrolysis:

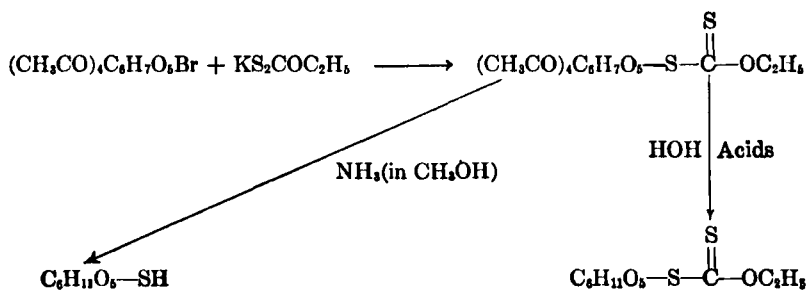

The thioglucose as thus prepared never had as high a sulfur content as that previously reported by Wrede<sup>27</sup> who had obtained it by first forming diglycosyl disulfide (VI), then reducing to thioglucose tetraacetate (VII) and finally removing the acetyl groups with ammonia.

<sup>24</sup> M. P. Schubert, *J. Biol. Chem.*, **130**, 601 (1939).

<sup>25</sup> M. P. Schubert, *J. Biol. Chem.*, **114**, 341 (1936).

<sup>26</sup> W. Schneider, R. Gille and K. Eisfeld, *Ber.*, **61**, 1244 (1928).

<sup>27</sup> F. Wrede, *Ber.*, **52**, 1756 (1919); *Z. physiol. Chem.*, **119**, 46 (1922).

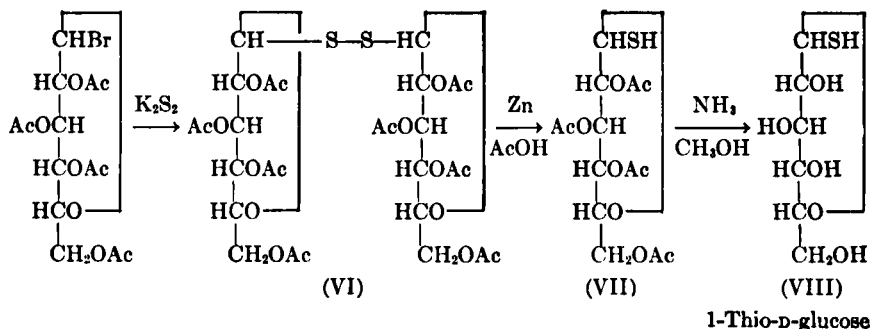

The later authors<sup>26</sup> explained the low sulfur content of their compounds on the assumption that a hydrate is formed. They also proposed that compounds, such as the one in question (VIII), which possess a labile thio group on the carbonyl carbon, be known as glycothioses, and that those where a secondary or primary hydroxyl group is replaced by the SH linkage be designated thioglycoses. This distinction has not been widely adopted, is confusing, and is best replaced by numerical designations. Thioglucose (1-thio-D-glucose; VIII) reduces Fehling's solution in the cold, mutarotates in normal fashion, and with phenylhydrazine forms phenylglucosazone with the elimination of the thiol group. Thioglucose yields a crystalline sodium salt and pentaacetate and may be re-oxidized by iodine to the disulfide.<sup>28</sup>

The question of the ring form of thioglucose has been the subject of but little study. The best evidence is derived from the work of Richtmeyer, Carr and Hudson,<sup>29</sup> who prepared thioglucose tetraacetate (IX) from acetobromoglucose and subjected it to catalytic reduction. The product was polygalitol tetraacetate (X), polygalitol having been shown earlier to have a 1,5 ring:

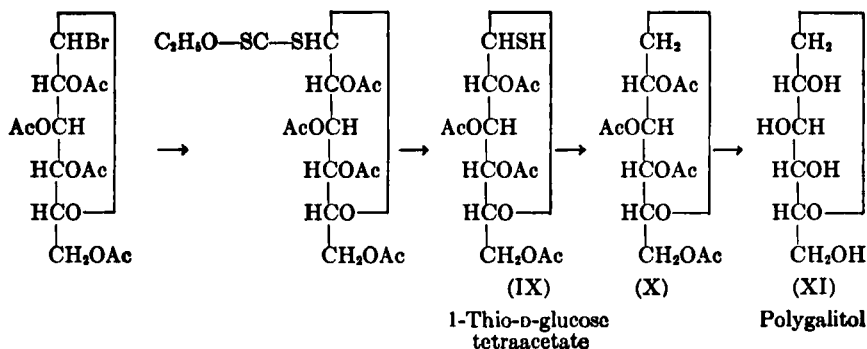

<sup>28</sup> W. Schneider and H. Leonhardt, *Ber.*, **62**, 1384 (1929).

<sup>29</sup> N. K. Richtmeyer, C. J. Carr and C. S. Hudson, *J. Am. Chem. Soc.*, **65**, 1477 (1943).

Assuming that there is no migration of acetyl groups, and granting that the polygalitol (XI) has been assigned the correct structure, it follows that thioglucose tetraacetate must possess a pyranose ring. Whether the unacetylated sugar has this same ring form, or whether there may be a tautomerization between ring forms in the free sugar, appears not to have been proven.

In addition to thioglucose, syntheses of thiocellobiose,<sup>30</sup> thiogalactose and a trithiodigalactose<sup>31</sup> have been reported:

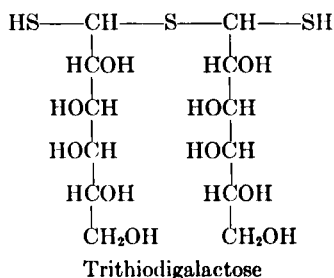

A wide variety of sulfides and disulfides have been synthesized<sup>28, 30, 31, 32</sup> and, in addition, three of the sulfides have been oxidized with permanganate to the corresponding sulfones<sup>33</sup>:

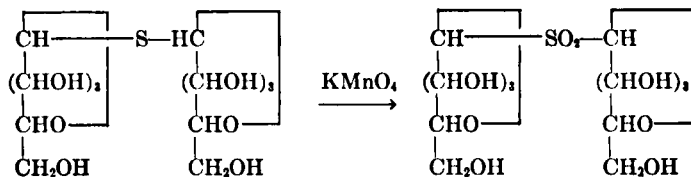

#### 4. Thioglycosides from Mercaptals

A different type of sulfur-containing sugar derivative had been obtained by Fischer many years earlier<sup>34</sup> by the interaction of various aldoses with mercaptans. The sugars react, as aldehydes, with two moles of mercaptan and the mercaptal or thioacetal is formed. (These compounds will not be reviewed herein in detail.) In 1916 Schneider and Sepp<sup>35</sup> made the important observation that these mercaptals would

<sup>30</sup> F. Wrede and O. Hetteche, *Z. physiol. Chem.*, **172**, 169 (1927).

<sup>31</sup> W. Schneider and Anne M. Beuther, *Ber.*, **52**, 2135 (1919).

<sup>32</sup> W. Schneider and F. Wrede, *Ber.*, **50**, 793 (1917); F. Wrede, *Ber.*, **52**, 1756 (1919); *Z. physiol. Chem.*, **108**, 115 (1919); **112**, 1 (1920).

<sup>33</sup> F. Wrede and W. Zimmermann, *Z. physiol. Chem.*, **148**, 65 (1925).

<sup>34</sup> E. Fischer, *Ber.*, **27**, 673 (1894).

<sup>35</sup> W. Schneider and Johanna Sepp, *Ber.*, **49**, 2054 (1916).

react stepwise in the presence of aqueous mercuric chloride, splitting off first one and then both thioalkoxyl groups. The first reaction product was the corresponding thioglycoside.

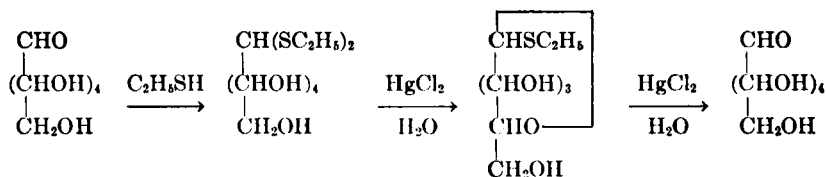

As previously mentioned, Fischer and Delbrück<sup>16</sup> had, in the meantime, synthesized two thiophenyl glycosides, but Schneider was the first to synthesize an alkyl thioglycoside. Extending the observation, Schneider and coworkers<sup>36</sup> concluded that the glucosides prepared by partial cleavage of the mercaptal were the alpha forms, but found that the corresponding beta derivatives could be obtained by the original Fischer method, reaction of the potassium mercaptide with acetobromoglucose. It is perhaps worth noting that the sodium salt of thioglucose with ethyl iodide<sup>26</sup> gives ethyl  $\beta$ -thioglucose, identical with that prepared from acetobromoglucose and potassium ethyl mercaptide.

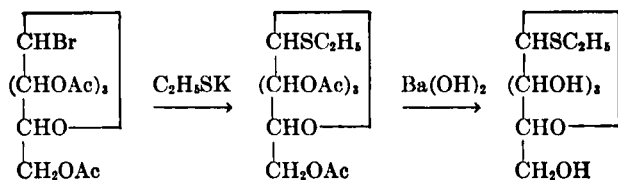

Still another method of synthesis of thioglycosides is due to Wolfrom and Thompson. Brigl and Schinle<sup>37</sup> had found that treating the benzoates of the open chain or the furanose forms, with a mercaptan and hydrogen chloride, led to formation of the thioacetal. In the open chain form this occurred without loss of benzoyl groups; in the furanose ring form a benzoyl group was replaced, while the pyranose form did not react unless the carbonyl group was free, as in the 2,3,4,6-tetrabenzoate. Wolfrom and Thompson,<sup>38</sup> employing sugar acetates and substituting zinc chloride for the hydrogen chloride, found that with the fully acetylated pyranoses, an acetyl group was split out and the thioglycoside was

<sup>36</sup> W. Schneider, Johanna Sepp and Otilie Stiehler, *Ber.*, **51**, 220 (1918).

<sup>37</sup> P. Brigl and R. Schinle, *Ber.*, **65**, 1890 (1932); **66**, 325 (1933).

<sup>38</sup> M. L. Wolfrom and A. Thompson, *J. Am. Chem. Soc.*, **56**, 880, 1804 (1934).

obtained :

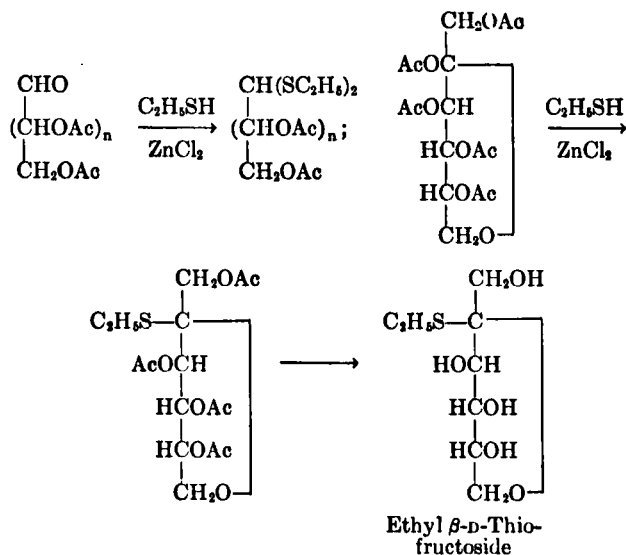

In these various ways, the anomeric forms of methyl, ethyl and benzyl thioglucosides and *n*-propyl  $\alpha$ -thioglucoside were all prepared in pure crystalline form. They are typical glucosides, non-reducing, stable toward alkalis, hydrolyzed by acid, but not by emulsin,<sup>39</sup> myrosin or yeast maltase.

There seems to be little doubt as to the ring form of the glucosides prepared from acetobromoglucose, for with the exception of certain glycosides accompanying the formation of the anomalous " $\gamma$ " glycosides (actually orthoacetates), the products formed from acetobromo-aldoses are all known to be  $\beta$ -pyranosides.<sup>39a</sup> The ring forms of Schneider's  $\alpha$ -thioglucosides are not as well established, since for these substances the starting materials have an open chain, and a ring form has to be created in the reaction. Green and Pascu,<sup>40</sup> in further studies on reactions of the mercaptals, discovered that, with mercuric chloride in alcoholic solution and in the presence of mercuric oxide to maintain neutrality of the solution,  $\alpha$ -glycofuranosides were obtained.

<sup>39</sup> W. W. Pigman, *J. Research Natl. Bur. Standards*, **26**, 197 (1941).

<sup>39a</sup> See pages 84, 85 and 118.

<sup>40</sup> J. W. Green and E. Pascu, *J. Am. Chem. Soc.*, **59**, 1205, 2569 (1937).

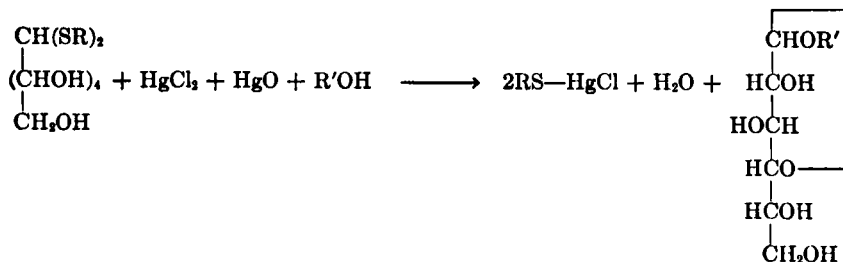

It was the belief of these authors that this might be a general procedure for the preparation of  $\alpha$ -furanosides; they were therefore disconcerted to find that when glucose mercaptal was shaken with mercuric chloride and mercuric oxide in aqueous solution (water in place of alcohol in the above), the compound which resulted was the original thioglucoside characterized by Schneider as ethyl  $\alpha$ -thioglucopyranoside. Applying Hudson's rules of isorotation they concluded that Schneider was in error and that the compound was in fact the  $\alpha$ -furanoside. Carrying the study still further, Pacsu and Wilson<sup>41</sup> showed that the ethyl  $\alpha$ -thioglucopyranoside, heated with 0.01 *N* hydrochloric acid, gave first ethyl  $\beta$ -thioglucopyranoside and finally ethyl  $\alpha$ -thioglucopyranoside. It was their interpretation that, when one thioalkoxyl group is hydrolyzed from the glucose mercaptal, ring closure occurs so as to form the  $\alpha$ -furanoside and this, in the presence of even the weakest acid, changes ring form and gives the pyranoside.

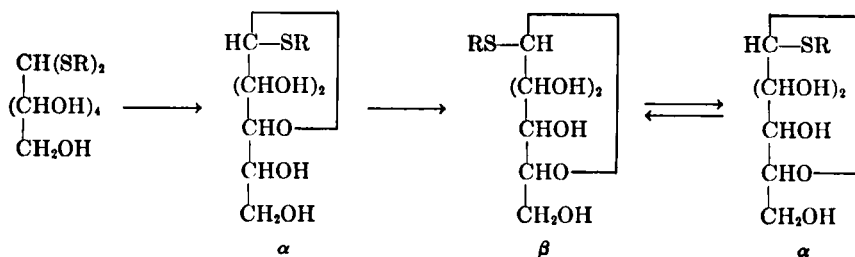

It is desirable to have these ring forms confirmed by the methylation or other technics, particularly since the  $\alpha$ -pyranoside exhibits an entirely abnormal rotation. This same  $\alpha$ -pyranoside had, however, been prepared at about the same time by Brigl and coworkers<sup>42</sup> and they had independently assigned the same structure. They also attempted to confirm the furanoside nature of the original  $\alpha$ -thioglucoside of Schneider by introducing one acetone group and then removing the mercaptal

<sup>41</sup> E. Pacsu and E. J. Wilson, Jr., *J. Am. Chem. Soc.*, **61**, 1450, 1930 (1939).

<sup>42</sup> P. Brigl, G. Gronemeier and A. Schulz, *Ber.*, **72**, 1052 (1939).



groups under carefully controlled conditions. The authors believed that the study proved the isopropylidene group to be in the 5,6 positions and that the glucoside must therefore have been a furanoside. Actually, under the conditions of the experiment, migration of an isopropylidene group is not inconceivable, so that the proof cannot be considered rigorous. More recently, Wolfrom and coworkers,<sup>42a</sup> by means of periodate oxidation, have clearly established Schneider's original  $\alpha$ -thio-glucoside as a furanoside.

In summary, it seems desirable to record Pacsu's own interpretation of the mechanism of the reaction. He pointed out<sup>43</sup> that the above results may be explained on the assumption that the first product is the mixed acetal which then undergoes further reaction:

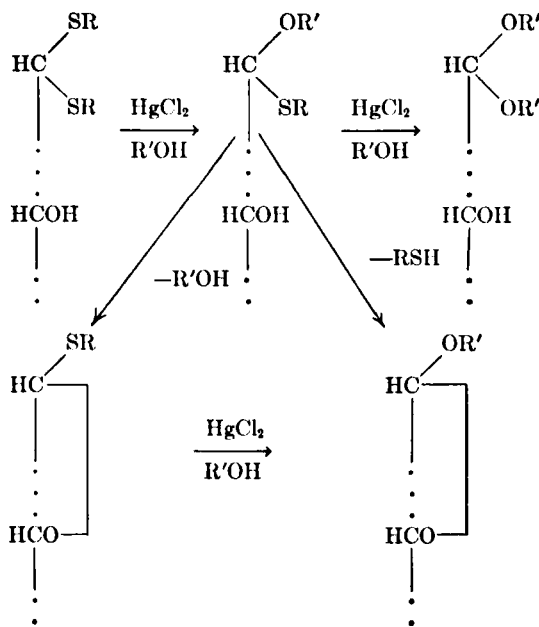

Using ingenious synthetic procedures and starting with the open-chain aldehyde pentaacetates, Wolfrom and coworkers<sup>44</sup> were actually able to synthesize, from both glucose and galactose, the mixed acetals postulated above. From a rather detailed study of the reactivity of these two mixed acetals, Wolfrom, Weisblat and Hanze<sup>44</sup> have concluded that the

<sup>42a</sup> M. L. Wolfrom, S. W. Waisbrot, D. I. Weisblat and A. Thompson, *J. Am. Chem. Soc.*, **66**, 2063 (1944).

<sup>43</sup> E. Pacsu, *J. Am. Chem. Soc.*, **61**, 1671 (1939); J. W. Green and E. Pacsu, *ibid.*, **60**, 2288 (1938).

<sup>44</sup> M. L. Wolfrom and D. I. Weisblat, *J. Am. Chem. Soc.*, **62**, 878 (1940); M. L. Wolfrom, D. I. Weisblat and A. R. Hanze, *ibid.*, **62**, 3246 (1940); **66**, 2065 (1944).

D-glucose mixed acetal, at least in the anomeric form employed, is not the probable intermediate in the formation of ethyl  $\alpha$ -thio-D-glucofuranoside from D-glucose diethyl mercaptal but that the mixed acetal is the probable intermediate in the formation of ethyl  $\beta$ -D-galactofuranoside from D-galactose diethyl mercaptal.

It is unfortunate that no one has reported the effects of myrosin on these four ethyl thioglucosides. Had this been done, it might be possible to correlate the structure of the naturally-occurring thioglucosides (which are uniformly hydrolyzed by myrosin) with one of the four thioglucosides reported above.

#### 5. Thioaldoses (other than 1-Thioaldoses)

Each of the compounds discussed thus far is characterized by having the sulfur attached to the carbonyl carbon atom. A single compound has been described, from a natural source, in which the sulfur is on a non-carbonyl carbon; this is the thiomethylpentose which occurs in yeast in the form of its adenine glycoside. According to Falconer and Gulland,<sup>45</sup> the sugar is attached to position 9 of the adenine. The sugar itself has been the subject of several studies, but its structure has not been definitely established. Suzuki, Odaki and Mori<sup>46</sup> had shown that it could be reduced to a thiopentitol while Levene and Sobotka<sup>47</sup> found that the sulfur was retained during osazone formation, thereby excluding positions 1 and 2. A paper by Wendt,<sup>48</sup> based on oxidation by lead tetraacetate, confirms the conclusion of the earlier authors that the substance is a thiomethyl derivative, concludes that this group cannot be in position 3, and suggests that the substance is 5-thiomethylribose. Raymond<sup>49</sup> had synthesized 5-thiomethylxylose, and found that the osazone of this compound differed from that of the natural compound, thereby excluding 5-thiomethylxylose, 5-thiomethyllyxose and 5-thiomethylxylulose as possible structures. In view of all these data, the natural substance must either have the thiomethyl group in position 4, or else be 5-thiomethylribose, 5-thiomethylarabinose or 5-thiomethylribulose. Further work is needed to settle the question.

Along synthetic lines, the preparation of the first thiosugar with the sulfur attached to a non-carbonyl carbon appears to be due to Wrede.<sup>50</sup> He had obtained di(glucosyl-6) sulfide by treating methyl 6-bromo- $\beta$ -D-

<sup>45</sup> R. Falconer and J. M. Gulland, *J. Chem. Soc.*, 1912 (1937).

<sup>46</sup> U. Suzuki, S. Odake and T. Mori, *Biochem. Z.*, **154**, 278 (1924); U. Suzuki and T. Mori, *ibid.*, **162**, 413 (1925).

<sup>47</sup> P. A. Levene and H. Sobotka, *J. Biol. Chem.*, **65**, 551 (1925).

<sup>48</sup> G. Wendt, *Z. physiol. Chem.*, **272**, 152 (1942).

<sup>49</sup> A. L. Raymond, *J. Biol. Chem.*, **107**, 85 (1934).

<sup>50</sup> F. Wrede, *Z. physiol. Chem.*, **115**, 284 (1921).

glucoside triacetate with potassium hydrogen sulfide, followed by deacetylation and hydrolysis:

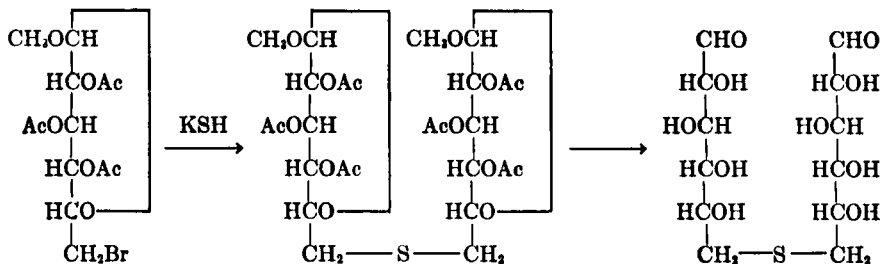

A little later, Freudenberg and Wolf<sup>51</sup> synthesized a 3-thio- and 3-thiomethylglucose (the configuration is open to slight question due to the possibility of Walden inversion) by preparing the xanthate from diacetone glucose, isomerizing, hydrolyzing and methylating:

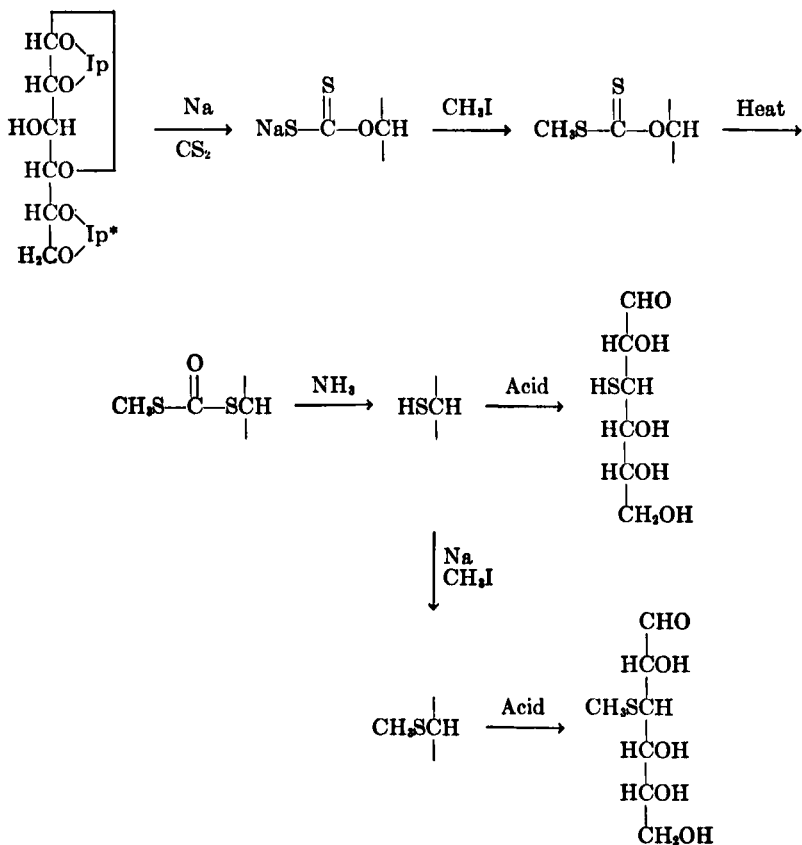

\* Ip denotes isopropylidene.

<sup>51</sup> K. Freudenberg and A. Wolf, *Ber.*, **60**, 232 (1927).

The thiodiacetone compound was also hydrolyzed to the free sugar, and it was oxidized to the bis(diacetoneglucose) disulfide which in turn was hydrolyzed to the free sugar.

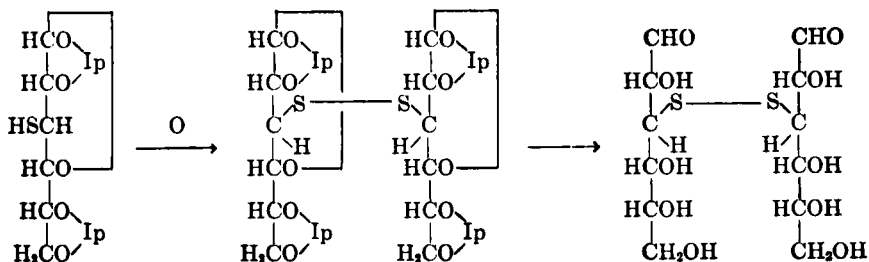

These same authors also prepared the xanthates from diacetone mannose and diacetone galactose, but in no case were they able to effect the unsaturation of the xanthate according to the method of Chugaev.<sup>52</sup> This was the original purpose of the investigation; they had hoped for a better preparation of unsaturated compounds, as, for example:

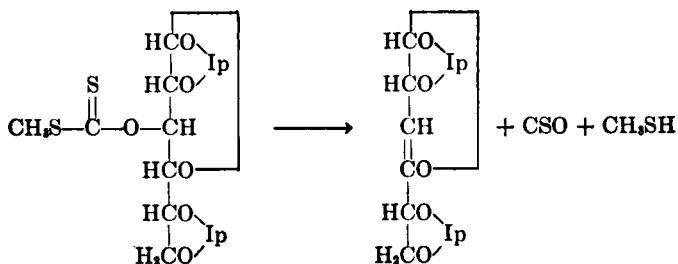

Compounds with thioethyl groups attached to non-carbonyl carbons were obtained both by Brigl and Schinle<sup>37</sup> and by Wolfrom and Thompson.<sup>38</sup> In their experiments, wherein certain benzoates and acetates were treated with ethyl mercaptan in the presence of hydrogen chloride or zinc chloride, it was found that free hydroxyl groups were replaced by the thioethoxyl group, the replacement in some cases being preceded by migration of the acyl radicals. In this work, 2-thioethyl-D-glucose was obtained in crystalline form.<sup>37</sup> This substance underwent osazone formation with loss of the thioethoxyl group.

Raymond,<sup>49</sup> as mentioned above, had synthesized 5-thiomethylxylose in an attempt to clarify the structure of the natural thiomethylpentose. In the same paper this author reported the preparation of 5-thioethyl-

<sup>52</sup> L. Chugaev, *Ber.*, 32, 3332 (1899).

xylose and of 6-thiomethylglucose, all these syntheses proceeding from the tosyl (*p*-toluenesulfonate) acetone derivatives:

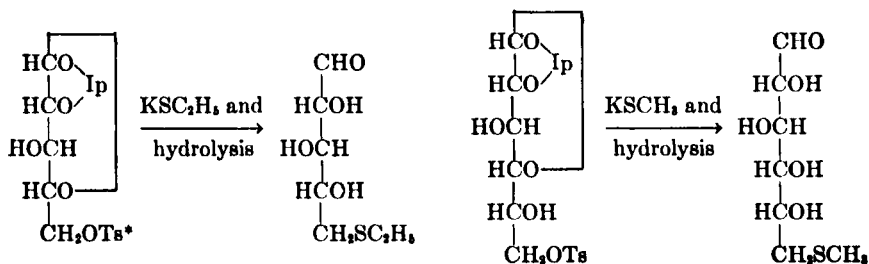

• Ts denotes tosyl.

In each case it was assumed, without attempt at experimental verification, that no Walden inversion had occurred and that the product had the configuration of the parent sugar. Since an anhydro compound is the probable intermediate, this assumption is open to some question. This same author treated potassium methyl mercaptide with one (denoted by E. Fischer as form I) of the two isomeric methyl 2-bromo- $\beta$ -D-glucosides and obtained a nicely crystalline thiomethyl compound which was hydrolyzed to the free sugar.

A paper by Müller and Wilhelms<sup>22</sup> describes the simple introduction of thiocyanate residues into the primary alcohol groups by the reaction of potassium thiocyanate with the tosyl derivative, or onto the carbonyl carbon by using the acetobromo compound. Tosyl esters of the secondary alcohols do not react under these conditions. The isothiocyanates, on treatment with sodium methoxide, yield the disulfides.

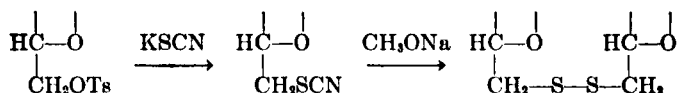

## II. SELENOSUGARS

A few sugars containing selenium have been described in the literature, and because of their close relationship to the thiosugars, they may be included at this point. The first of them was obtained by Schneider and Wrede<sup>53</sup> who secured selenoisotrehalose by the interaction of acetobromoglucose and hydrogen selenide, followed by deacetylation.

<sup>53</sup> W. Schneider and F. Wrede, *Ber.*, 50, 793 (1917).

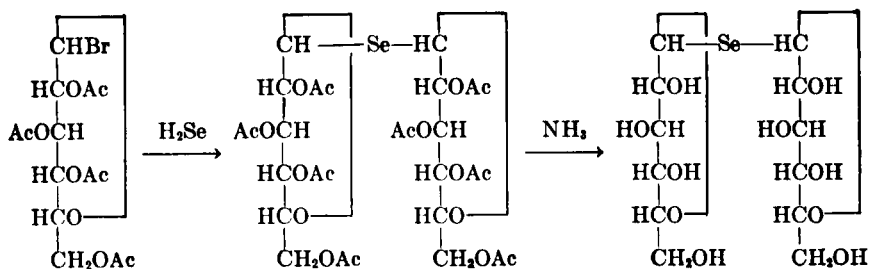

The same method was later employed by Wrede<sup>54</sup> and by Schneider and Beuther<sup>31</sup> who obtained a series of compounds in this manner. Two derivatives were synthesized by Wrede<sup>55</sup> in which the selenium is attached to the non-carbonyl carbon, the reactants in this case being methyl 6-bromo- $\beta$ -D-glucoside triacetate and potassium hydrogen selenide or di-potassium selenide. One of the above compounds was oxidized by Wrede and Zimmermann<sup>33</sup> to give the selenoxide.

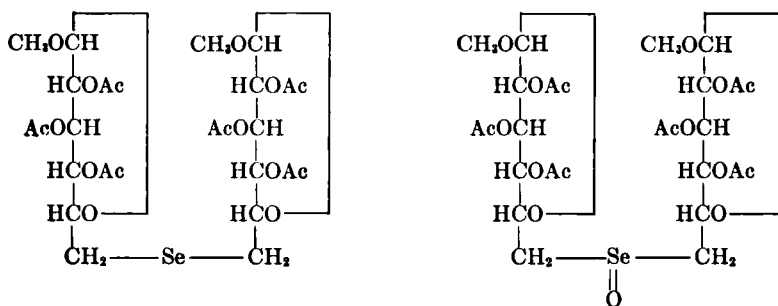

It will be observed that all of these are exact counterparts of the thiosugars and that the methods of synthesis are in each case identical. Little work appears to have been done on the pharmacology of these compounds<sup>56</sup> despite the fact that they offer rather interesting possibilities.

<sup>54</sup> F. Wrede, *Ber.*, **52**, 1756 (1919); *Z. physiol. Chem.*, **112**, 1 (1920).

<sup>55</sup> F. Wrede, *Z. physiol. Chem.*, **115**, 284 (1921).

<sup>56</sup> F. Wrede, *Deut. med. Wochschr.*, **50**, 1611 (1925); **51**, 148 (1925).

This Page Intentionally Left Blank

# THE CARBOHYDRATE COMPONENTS OF THE CARDIAC GLYCOSIDES

BY ROBERT C. ELDERFIELD

*Columbia University, New York, N. Y.*

## CONTENTS

I. Introduction . . . . .	147
1. Occurrence and General Reactions of the Sugars of the Cardiac Glycosides . . . . .	148
II. Digitalose . . . . .	150
1. Chemistry . . . . .	150
2. Preparation . . . . .	156
3. Digitalonic Lactone . . . . .	158
III. Antiarose . . . . .	159
IV. Digitoxose . . . . .	159
1. Chemistry . . . . .	159
2. Preparation . . . . .	163
V. Cymarose . . . . .	164
1. Chemistry . . . . .	164
2. Preparation . . . . .	166
VI. Diginose . . . . .	167
1. Chemistry . . . . .	167
2. Preparation . . . . .	170
VII. Oleandrose . . . . .	171
1. Chemistry . . . . .	171
2. Preparation . . . . .	172
VIII. Sarmentose . . . . .	172
IX. Strophanthobiose . . . . .	173

## I. INTRODUCTION

The naturally occurring substances known as the cardiac glycosides comprise a relatively widespread group, the members of which occur as glycosides of aglycons which are derivatives of the lactone of 21-hydroxy- $\Delta^{20}$ -norcholeonic acid. As far as is known the carbohydrate components are joined to the aglycon in glycosidic linkage through a hydroxyl group in the 3-position of the cyclopentanoperhydrophenan-



threne ring system of the aglycon. It is beyond the scope of the present treatment to discuss the chemistry of the aglycons—a subject which has been adequately treated on several previous occasions.<sup>1</sup> Likewise, the chemistry of the glycosides themselves, particularly those which have been the subject of intensive study, has been adequately treated elsewhere.<sup>2</sup> Rather the primary emphasis will be placed on the chemistry of the carbohydrate components of the cardiac glycosides.

### 1. Occurrence and General Reactions of the Sugars of the Cardiac Glycosides

In addition to relatively common sugars, for example glucose and rhamnose, the molecules of the cardiac glycosides are frequently characterized by the occurrence of much rarer sugars, the structures and chemical behavior of which are not without interest. Thus in investigations within this group one frequently encounters the relatively rare 2-desoxyhexoses and the still rarer hexose monomethyl ethers. The principal sources of the sugars under discussion are summarized in Table I. Details concerning their actual isolation and characterization

TABLE I  
*Sugars of the Cardiac Glycosides*

<i>Sugar</i>	<i>Glycosides in Which it Occurs</i>
D-Glucose	Thevetin, Uzarin, Neriantin, Strophanthin, and others
1-Rhamnose	Ouabain, $\beta$ -Antiarrin, Convallatoxin, Scillaren A
Digitoxose	Digitalis glycosides
Digitalose	<i>Digitalinum verum</i> , Emicymarin
Cymarose	Cymarin, Periplocymarin
Diginose	Diginin
Oleandrose	Adynerin, Oleandrin
Sarmentose	Sarmentocymarin

together with literature references will be found in the following pages.

In the ensuing discussion, no space will be devoted to glucose and rhamnose. For purposes of classification the other sugars may be divided into two broad groups: (1) one consisting of hexomethyloses and (2) one consisting of 2-desoxyhexomethyloses, the majority of which also contain methyl ether groupings. In the first group may be placed digitalose and presumably antiarose, the former of which is also methylated. The second and larger group consists of digitoxose, cymarose, diginose, oleandrose and sarmentose, of which only digitoxose is unmethylated.

<sup>1</sup> W. H. Strain in "Organic Chemistry," H. Gilman, editor, 2nd ed.; Vol. II, John Wiley and Sons, Inc., New York (1943) p. 1341; R. Tschesche, *Ergeb. Physiol.*, **38**, 31 (1936); R. C. Elderfield, *Chem. Revs.*, **17**, 187 (1935).

<sup>2</sup> A. Stoll, "The Cardiac Glycosides," Pharmaceutical Press, London (1937),

The members of the first group show no distinguishing chemical properties other than those usually associated with the common hexoses. Those of the second group, on the other hand, display several reactions which, while characteristic of the 2-desoxy sugars as a whole, are nevertheless sufficiently striking to warrant comment. Perhaps the most characteristic property of the 2-desoxy sugars is the extreme ease with which hydrolysis of their glycosides occurs, and conversely the extreme ease with which glycoside formation occurs. In the case of the formation of the methyl glycosides of two of these, digitoxose and cymarose, quantitative rate data are available and are shown graphically in Fig. 1<sup>3</sup>. Such

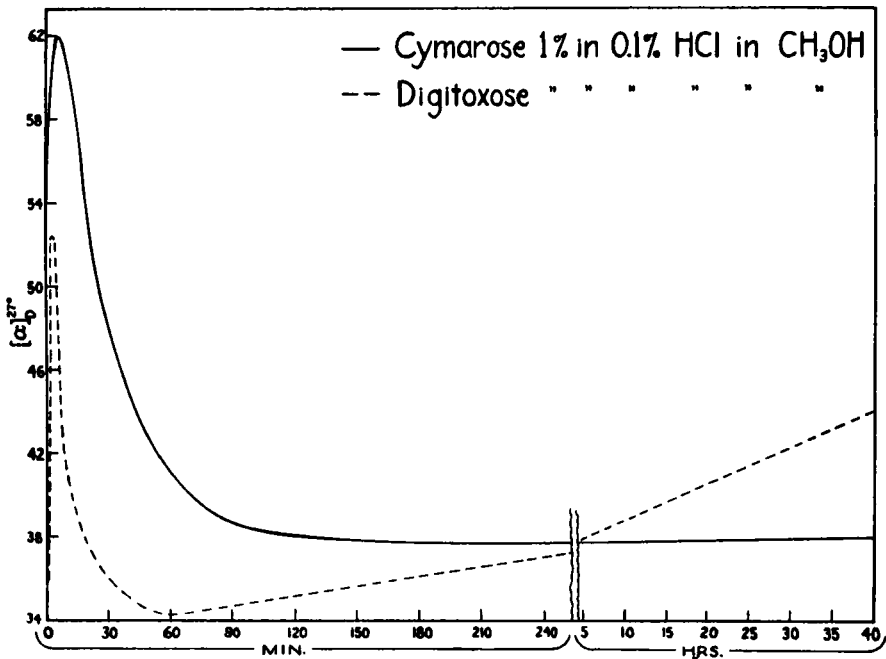

FIG. 1.

ease of hydrolysis of the glycosides is of importance in the isolation of the sugars, for, as  $\beta$ -hydroxyaldehydes, they are quite sensitive to the influence of strong acids, and therefore it is doubtful whether they would withstand the relatively severe conditions required for the hydrolysis of the glycosides of normal sugars. A second characteristic of the 2-desoxy sugars, and one of value in diagnosing their presence either as such or in

<sup>3</sup> R. C. Elderfield, *J. Biol. Chem.*, 111, 527 (1935).

glycosidic union, is the positive Keller-Kiliani test displayed by them as a class. As usually carried out, this test consists in layering concentrated sulfuric acid below a solution of a few milligrams of the substance in glacial acetic acid containing ferrous iron. The production of a deep blue ring at the interface, with the color gradually diffusing into the upper layer, is taken as a positive test. It should be emphasized that this test is not specific for 2-desoxy sugars, but is also given by other types of substances, notably certain indole derivatives, which fortunately are not likely to be confused with a carbohydrate derivative.

In addition to the simple sugars noted above, one disaccharide has been isolated from a cardiac glycoside. It should be emphasized, however, that in many cases the drugs consist of polyglycosides, frequently containing glucose in addition to the rarer sugars. The fact that only one such oligosaccharide has been isolated is not to be taken to indicate that such do not exist in the natural substances.

## II. DIGITALOSE

### 1. Chemistry

Digitalose was first obtained by Kiliani<sup>4</sup> in 1892 from the products of hydrolysis of *Digitalinum verum*, a glycoside of gitoxigenin with glucose and digitalose. As obtained by Kiliani, the sugar was a sirup and could not be crystallized. More recently, Lamb and Smith<sup>5</sup> succeeded in obtaining the sugar in crystalline form by hydrolysis of a glycoside isolated from the seeds of *Strophanthus emini*. Kiliani succeeded in obtaining a crystalline derivative of the sirupy sugar by oxidation with bromine water to form digitalonic lactone of the formula  $C_7H_{12}O_6$ . From this, the sugar itself must have the formula  $C_7H_{14}O_6$ , corresponding to a monomethyl ether of a hexomethylose. The presence of a terminal methyl group was further indicated by the formation of acetic acid on oxidation of either the sugar or its lactone with silver oxide. The presence of a methyl ether was definitely demonstrated by Kiliani,<sup>6</sup> who isolated a dihydroxymethoxyglutaric acid on oxidation of digitalonic lactone with nitric acid. The position of the methyl ether was indicated by the observation of Kiliani that digitalose presumably formed a phenylhydrazone, but not a phenylosazone.

The chemistry of digitalose rested at this point until Schmidt and

<sup>4</sup> H. Kiliani, *Ber.*, **25**, 2116 (1892).

<sup>5</sup> I. D. Lamb and S. Smith, *J. Chem. Soc.*, 442 (1936).

<sup>6</sup> (a) H. Kiliani, *Ber.*, **38**, 3621 (1905); (b) **55**, 92 (1922); (c) **64**, 2027 (1931).

Zeiser<sup>7</sup> found that on complete methylation the dihydroxymethoxyglutaric acid obtained by Kiliani gave *L-arabo*-trimethoxyglutaric acid (V or VI), thus establishing its steric configuration. From this work it follows that digitalose must have the configuration of one of the following hexomethyloses, leaving the position of the methoxyl group in abeyance for the time being: *D*-gulomethylose (I), *L*-rhamnose (II), *D*-fucose (III), or *L*-altromethylose (IV).

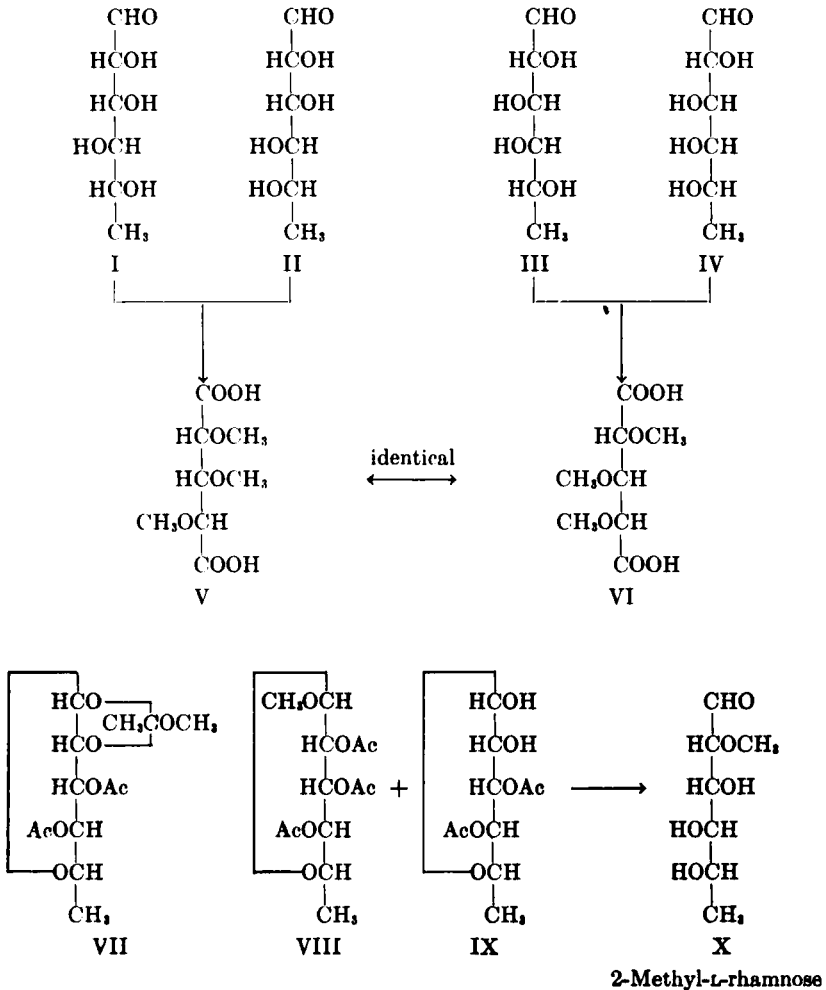

<sup>7</sup> O. T. Schmidt and H. Zeiser, *Ber.*, 67, 2127 (1934).

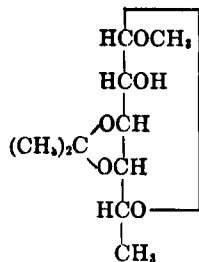

XI

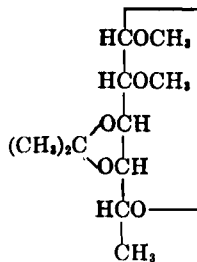

XII

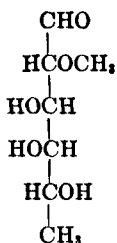

XIII

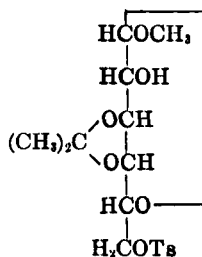
2-Methyl-*n*-fucose

XIV

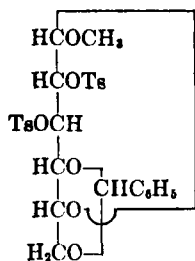
Ts = *p*-toluenesulfonyl group

XV

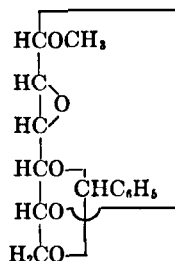

XVI

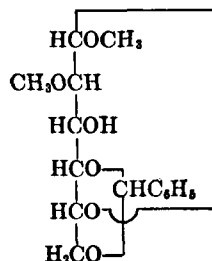

XVII

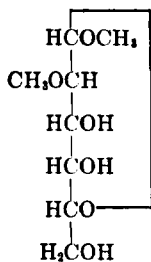

XVIII

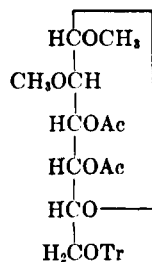

XIX

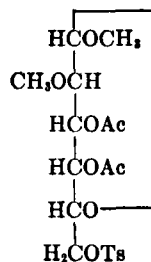

XX

Tr =  $-\text{C}(\text{C}_6\text{H}_5)_3$

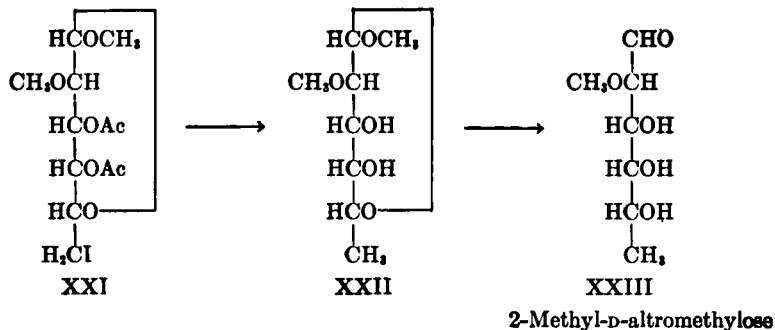

In view of the extreme difficulty in securing adequate amounts of digitalose for the determination of its configuration by conventional means, the method of synthesis of the four possibilities on the assumption that the methyl ether is in the 2-position has been adopted in order to settle the question of the structure of the sugar. MacPhillamy and Elderfield<sup>8</sup> synthesized two of the four possibilities: namely, 2-methyl-L-rhamnose and 2-methyl-D-fucose.

2-Methyl-L-rhamnose was synthesized by the steps shown in formulas VII-X, and was obtained as a sirup which eventually crystallized after standing for some years.<sup>9</sup> In the synthesis of 2-methyl-L-rhamnose, the primary problem was to block the hydroxyl groups of rhamnose, with the exception of the 2-hydroxyl group. In order to accomplish this, advantage was taken of a typical reaction of sugar 1,2-orthoacetates, which are formed on treatment of some acetobromo sugars with quinoline or similar bases in methyl alcoholic solution.<sup>10</sup> Isbell,<sup>11</sup> in a study of the action of methyl alcoholic hydrogen chloride on heptaacetyl-4-glucosidomannose 1,2-orthoacetate obtained hexaacetyl-4-glucosidomannose, presumably by selective hydrolysis of the orthoester group. However, beyond the facts that this substance contained no methoxyl and that it gave on acetylation the known octaacetyl-4-glucosidomannose, the position of the free hydroxyl groups was not further demonstrated. When the above reactions were applied to the corresponding rhamnose derivatives, analogous compounds were formed and the correctness of Isbell's interpretation was shown. On treatment of methyl 3,4-diacetyl-L-rhamnopyranose 1,2-orthoacetate (VII) with methyl alcoholic hydro-

<sup>8</sup> H. B. MacPhillamy and R. C. Elderfield, *J. Org. Chem.*, **4**, 150 (1939).

<sup>9</sup> F. G. Young, Jr. and R. C. Elderfield, *J. Org. Chem.*, **7**, 241 (1942).

<sup>10</sup> E. Fischer, M. Bergmann and A. Rabe, *Ber.*, **53**, 2362 (1920).

<sup>11</sup> H. S. Isbell, *J. Research Natl. Bur. Standards*, **7**, 1115 (1931); W. W. Pigman and H. S. Isbell, *ibid.*, **19**, 189 (1937).

gen chloride, a mixture of the previously known methyl 2,3,4-triacetyl- $\beta$ -L-rhamnopyranoside (VIII)<sup>12</sup> and 3,4-diacetyl-L-rhamnose (IX) was obtained. The former compound was easily isolated by crystallization from water. The latter, excessively soluble in water, could not be crystallized, decomposed on distillation, and was therefore methylated directly, yielding methyl 2-methyl-3,4-diacetyl-L-rhamnopyranoside, which on deacetylation and hydrolysis of the glycosidic methyl group gave 2-methyl-L-rhamnose (X).

The synthesis of 2-methyl-D-fucose was carried out first directly from D-fucose. Methylation of methyl 3,4-isopropylidene-D-fucopyranoside (XI) and hydrolysis of the glycosidic methyl group in the product (XII) led directly to the desired sugar (XIII).

The alternate method started from methyl  $\alpha$ -D-galactopyranoside, which upon unimolecular tosylation gave the 6-tosyl derivative. After blocking the 3 and 4-hydroxyl groups by condensation with acetone (XIV), the open 2-hydroxyl group was methylated. Conversion of the 6-tosyl group to methyl in the usual manner by replacement with iodine and reduction, followed by hydrolysis of the acetone and glycosidic methyl groups led to 2-methyl-D-fucose.

The synthesis of 2-methyl-D-altromethylose (XXIII) has been accomplished by Young and Elderfield.<sup>9</sup> The D-isomer was chosen rather than the L-form, which corresponds to digitalose, in view of the accessibility of the former from D-glucose. The method used was based on the work of Robertson and co-workers<sup>13</sup> who converted methyl  $\alpha$ -glucoside to a methyl 2-methyl- $\alpha$ -D-altroside by inversion of the configuration about carbon atom 3 as shown in formulas XV-XVIII. Successive tritylation and acetylation of methyl 2-methyl- $\alpha$ -D-altroside (XVIII) yielded methyl 2-methyl-3,4-diacetyl-6-trityl- $\alpha$ -D-altroside (XIX), the trityl group of which was removed selectively by the action of hydrogen bromide and acetic acid. Tosylation of the liberated 6-hydroxyl group was then carried out and the tosyl group converted to methyl by the usual reactions (XIX-XXII).

Alternately, methyl 2-methyl- $\alpha$ -D-altroside (XVIII) was unimolecularly tosylated, yielding the 6-tosyl derivative. After conversion of the latter to methyl 2-methyl-6-iodo- $\alpha$ -D-altroside, acetylation led to methyl 2-methyl-3,4-diacetyl-6-iodo- $\alpha$ -D-altroside (XXI), which was converted to 2-methyl-D-altromethylose (XXIII) by the usual reactions.

The physical constants of the 2-methyl sugars thus prepared together with those previously reported in the literature are given in Table II.

<sup>9</sup> W. N. Haworth, E. L. Hirst and E. J. Miller, *J. Chem. Soc.*, 2469 (1929).

<sup>13</sup> G. J. Robertson and C. F. Griffith, *J. Chem. Soc.*, 1193 (1935); G. J. Robertson and W. Whitehead, *ibid.*, 319 (1940).

TABLE II  
*Specific Rotations of Sugars and Their 2-Methyl Derivatives<sup>a</sup>*

Sugar	Specific Rotation	Specific Rotation of 2-Methyl Derivative
D-Glucose	+ 52.5 <sup>b</sup>	+ 65.3 <sup>c</sup>
D-Galactose	+ 81.7 <sup>d</sup>	+ 82.6 <sup>e</sup>
D-Xylose	+ 19 <sup>f</sup>	+ 35.9 <sup>g</sup>
D-Arabinose	-105 <sup>h</sup>	-102 <sup>h</sup>
L-Rhamnose	+ 8.9 <sup>i</sup>	+ 31 <sup>k</sup>
D-Fucose	+ 76.3 <sup>j</sup>	+ 87.0 <sup>k</sup>
D-Altromethylose	+ 18 <sup>l</sup>	+ 11.8 <sup>m</sup>

<sup>a</sup> All values are for the equilibrated aqueous solutions, sodium D-line. <sup>b</sup> B. Tollens, *Ber.*, 17, 2234 (1884). <sup>c</sup> R. Schinle, *Ber.*, 64, 2361 (1931). <sup>d</sup> C. Tanret, *Bull. Soc. Chim.*, [3], 15, 195 (1896). <sup>e</sup> D. J. Bell and S. Williamson, *J. Chem. Soc.*, 1196 (1938); J. W. H. Oldham and D. J. Bell, *J. Am. Chem. Soc.*, 60, 323 (1938). <sup>f</sup> C. S. Hudson and E. Yanovsky, *J. Am. Chem. Soc.*, 39, 1013 (1917). <sup>g</sup> G. J. Robertson and T. H. Speedie, *J. Chem. Soc.*, 824 (1934). <sup>h</sup> O. T. Schmidt and A. Simon, *J. prakt. Chem.*, 152, 190 (1939). <sup>i</sup> C. S. Hudson and E. Yanovsky, *J. Am. Chem. Soc.*, 39, 1032 (1917). <sup>j</sup> E. Votoček and F. Valentin, *Collection Czechoslov. Chem. Commun.*, 2, 36 (1930). <sup>k</sup> H. B. MacPhillamy and R. C. Elderfield, *J. Org. Chem.*, 4, 150 (1939). <sup>l</sup> Based on  $[\alpha] - 18^\circ$  for L-altromethylose by K. Freudenberg and K. Raschig [*Ber.*, 62, 373 (1929)]. <sup>m</sup> F. G. Young, Jr. and R. C. Elderfield, *J. Org. Chem.*, 7, 241 (1942).

From a study of the specific rotations, it is seen that methylation of a simple sugar in the 2-position does not produce a striking change in optical activity. Since the specific rotation of none of the three 2-methylhexomethyloses prepared above corresponds to the value for digitalose, the question of identity of the latter with 2-methyl-D-gulomethylose remains. Young and Elderfield<sup>9</sup> in a discussion of this point raised doubt as to whether such identity actually exists. The specific rotation of D-gulomethylose is  $-35.7^\circ$ ,<sup>14</sup> and the specific rotation of digitalose is  $106^\circ$ .<sup>5</sup> It is obvious, then, that a change of some  $140^\circ$  in the value of the specific rotation of D-gulomethylose should accompany methylation in the 2-position, a shift that is unlikely in the light of similar changes noted in Table II. This point in turn raises a doubt as to the position occupied by the methyl ether group in digitalose. As already mentioned, Kiliani<sup>6b</sup> based his assumption that the methyl ether is in the 2-position on the failure of digitalose to yield an osazone on treatment with phenylhydrazine. However, the experiment on which this conclusion was based was performed on a mixture of glucose and digitalose obtained by hydrolysis of *Digitalinum verum*, and phenylglucosazone was the only product isolated in an analytically pure state. An impure substance, considered to be the phenylhydrazone of digitalose

<sup>14</sup> P. A. Levene and J. Compton, *J. Biol. Chem.*, 111, 335 (1935).



was isolated from the mother liquors. Under the conditions of Kiliani's experiment, it is surprising that an osazone of the parent sugar of digitalose was not formed by elimination of the methyl group, if this is actually in the 2-position. All of the 2-methyl sugars described by MacPhillamy and Elderfield, and Young and Elderfield, as well as several others appearing in the literature, lose their methyl group when treated with a hydrazine under conditions which normally lead to osazone formation. It appears, therefore, that Kiliani's assumption that the methyl group is in the 2-position in digitalose is open to question.

Very recently, conclusive evidence not only for the structure but also for the configuration of digitalose has been supplied by Schmidt, Mayer and Distelmaier.<sup>15</sup> It is now found that digitalose, freed from glucose by fermentation with brewers' yeast, yields a phenylosazone which still contains the methoxyl group. This fact eliminates the 2-position as the site of the methoxyl group. Since position 5 has been clearly eliminated on the basis of Kiliani's oxidation of digitalonic lactone to a dihydroxy-methoxyglutaric acid (confirmed by Schmidt and Zeiser<sup>7</sup>), position 3 and 4 remain. Schmidt and co-workers place the group in question at position 3 on the basis of the rate of hydrolysis of the lactone of digitalonic acid the curve for which resembles closely that for a  $\gamma$ -sugar lactone rather than that for a  $\delta$ -lactone.

The configuration of digitalose was shown to be that of D-fucose. Complete methylation of L-fucose yielded 2,3,4-trimethyl- $\alpha$ -L-fucose monohydrate which showed a value for  $[\alpha]_D^{20}$  of  $-169^\circ$ , becoming constant at  $-118^\circ$ . Similarly, complete methylation of digitalose gave the mirror image of the above sugar which showed the same values for rotation but the opposite sign. Digitalose is, therefore, 3-methyl-D-fucose.

## 2. Preparation

For the preparation of the sugar in crystalline form, at best a tedious procedure, isolation and hydrolysis of emicymarin from *Strophanthus emini* seeds is the only method known at present.<sup>5</sup>

The ground seeds are defatted by extraction with gasoline and then thoroughly extracted with 90% alcohol. After precipitation of saponins and tannins with basic lead acetate and removal of excess lead with hydrogen sulfide, the resulting solution is concentrated nearly to dryness under reduced pressure. The residue is taken up in water and the solution is extracted with chloroform, which removes some chloroform-soluble cymarin. The aqueous solution is then saturated with am-

<sup>15</sup> O. T. Schmidt, W. Mayer and A. Distelmaier, *Naturwissenschaften*, **31**, 247 (1943); *Ann.*, **555**, 26 (1943).

monium sulfate, which precipitates the amorphous glycosides as a sticky mass. This in turn is extracted with absolute alcohol for removal of the alcohol-insoluble ammonium sulfate, and the alcoholic extract is concentrated to dryness under reduced pressure, leaving a residue of amorphous glycosides amounting to about 4.2% of the defatted seeds.

In order to isolate emicymarin, it is now necessary to hydrolyze the glucose from the polyglycosides enzymically. For this purpose an enzyme, prepared from the seeds according to Jacobs and Hoffmann,<sup>16</sup> which removes glucose from the polyglycosides but leaves sugars such as cymarose and digitalose attached to the aglycon, is used.

Completely defatted seeds (500 g.) are covered with 2 l. of distilled water saturated with thymol and left for eight hours at room temperature and then for sixteen hours at 0°. The pap is then pressed in a tincture press, and the cloudy extract is treated with 5 volumes of 95% alcohol. The flocculent precipitate is collected in the centrifuge. The crude precipitate is redissolved in 400 cc. of water, centrifuged clear, and the supernatant solution precipitated with 5 volumes of 95% alcohol. The precipitate is centrifuged, then suspended and centrifuged successively in 80%, 95%, and finally twice in absolute alcohol. After collection with dry acetone, it is thoroughly dried in a vacuum desiccator over calcium chloride. The pink fluffy powder containing the enzyme weighs about 15 g.

For partial hydrolysis of the amorphous glycosides, a mixture of 10 g. of glycosides obtained as above, 5 g. of crude enzyme and 700 cc. of water is allowed to stand at pH 5.6 at 37° for nine days. The mixture is treated with 5 volumes of alcohol, filtered through kieselguhr, and concentrated to a small volume under reduced pressure. The residue is extracted with chloroform. The chloroform-soluble glycosides (4.3 g.) are crystallized from methanol, yielding a first crop (2.1 g.) of a mixture of glycosides and crude emicymarin (0.55 g.) from the mother liquors. After repeated crystallization from methanol, emicymarin forms rosettes of stout needles which sinter at 160° and melt at about 207°. The value of  $[\alpha]_D^{20}$  for the anhydrous substance is +12.8° (c. 2.5, absolute alcohol).

Digitalose is obtained by dissolving 3 g. of emicymarin in 6 cc. of warm alcohol, adding 184 cc. of water and 10 cc. of 10% hydrochloric acid. After refluxing for two and one-half hours, the aglycon which separates as an oil is extracted with chloroform. After removal of chloride ion with silver carbonate in the usual way, the solution is concentrated and the residue (0.75 g.) crystallized from ethyl acetate as rosettes of needles. Originally the sugar melted at 106° after sintering at 101°, but the melting point rose to 115° on storing for three days, and

<sup>16</sup> W. A. Jacobs and A. Hoffmann, *J. Biol. Chem.*, 69, 157 (1926).

to  $119^\circ$  after four months. The specific rotation rose from  $[\alpha]_{5461}^{27} + 109^\circ$  (fifteen minutes after solution) to  $[\alpha]_{5461}^{22} + 126^\circ$ ,  $[\alpha]_D^{22} + 106^\circ$  (c. 1.7, water) in seventeen hours and was then constant. By the Bertrand micro-method, 1 mg. of digitalose has the same reducing power as 0.32 mg. of anhydrous glucose.

### 3. Digitalonic Lactone

The problem of securing crystalline digitalonic lactone is somewhat simpler than is the case with the parent sugar, provided one has *Digitalinum verum*, a substance usually commercially available in normal times. The preparation and purification of the glycoside from digitalis seeds has been described by Kiliani.<sup>17</sup> The same worker has provided a method for the isolation of digitalonic lactone<sup>18</sup> which represents a substantial improvement over earlier procedures.

For hydrolysis of the glycoside an acid mixture prepared from 35 cc. of glacial acetic acid, 10 cc. of hydrochloric acid (sp. gr. 1.19) and 55 cc. of water is used. Such a mixture contains 4.2% HCl and 34.5% acetic acid. *Digitalinum verum* is heated under reflux with the above acid mixture in the proportion of 10 cc. of acid to 1 g. of glycoside on a steam bath with initial shaking. Solution of the glycoside occurs rapidly and heating is continued for one hour at the end of which time a dark oil separates on the walls of the flask. The oil (digitaligenin) does not completely solidify on standing for twenty-four hours. The supernatant liquid is decanted through a gravity filter, and the resin thoroughly washed with water. The combined filtrate and water washings are extracted with chloroform, and the material extracted by the chloroform is combined with the resinous aglycon remaining on the filter to be processed for digitaligenin.

The aqueous solution from the chloroform extraction which contains digitalose and glucose, is freed from chloride ion with silver carbonate and concentrated to a sirup, which is oxidized directly with bromine water. The sirup is dissolved in an amount of water equal to 3 times the weight of the *Digitalinum verum* originally used. To this solution is added 0.2 cc. of bromine for each gram of *Digitalinum verum*. After shaking until the bromine is all dissolved, the solution is allowed to stand for twenty-four hours at room temperature, then diluted with 0.5 volume of water. Excess bromine is removed by aeration and bromide ion by silver carbonate in the usual manner. After removing any silver with hydrogen sulfide, the solution is concentrated under reduced pressure to a sirup. The sirup is shaken twice with 3 volumes of a mixture of

<sup>17</sup> H. Kiliani, *Arch. Pharm.*, **252**, 30 (1914).

<sup>18</sup> H. Kiliani, *Ber.*, **63**, 2866 (1930).

alcohol and ether (1:4). On evaporation of the alcohol-ether extract, digitalonic lactone crystallizes. The material insoluble in the alcohol-ether consists for the most part of gluconic acid. If this is heated with barium carbonate suspension, barium gluconate can be isolated. The mother liquors from the barium gluconate, after being freed from barium yield a further amount of digitalonic lactone. The yield of the lactone is 40–50% of the theory. On recrystallization from alcohol, it forms rhombic needles which melt at 137–138° and show  $[\alpha]_{5461}^{19} - 102^\circ$ ,  $[\alpha]_D^{19} - 83^\circ$  (c 3.23, water).<sup>5</sup>

### III. ANTIAROSE

Practically nothing is known concerning this sugar obtained by Kiliani<sup>19</sup> on hydrolysis of  $\alpha$ -antiarin, one of two glycosides isolated from the sap of the deadly upas tree, *Antiaris toxicaria*. The sugar has been obtained only as a sirup, but crystalline antiaronic acid has served to characterize it as a hexomethylose isomeric with rhamnose, which is found in the hydrolysis products of  $\beta$ -antiarin.

### IV. DIGITOXOSE

#### 1. Chemistry.

Digitoxose occurs as the sugar component of the glycosides digitoxin,<sup>20</sup> gitoxin,<sup>21</sup> and digoxin,<sup>22</sup> from any of which it is easily obtained on very mild acid hydrolysis.

Kiliani, in a series of papers arrived at the conclusion that digitoxose is a 2-desoxy-hexamethylose to which the structure XXIV was assigned, the configuration of the C-5 hydroxyl group being left open. In support of this configuration, the following evidence can be presented. From the ease of hydrolysis of its glycosides<sup>3</sup> as well as from the positive Keller-Kiliani color test, a 2-desoxy sugar was indicated, a conclusion substantiated by the failure of the sugar to form an osazone<sup>23</sup> and by the formation of an  $\alpha,\beta$ -dihydroxyglutaric acid along with *meso*-tartaric acid on oxidation with nitric acid.<sup>24</sup> An aldose was indicated by the formation

<sup>19</sup> H. Kiliani, *Arch. Pharm.*, **234**, 438 (1896); *Ber.*, **46**, 667 (1913).

<sup>20</sup> M. Cloetta, *Arch. expl. Path. Pharmacol.*, **88**, 113 (1920); A. Windaus and G. Stein, *Ber.*, **61**, 2436 (1928).

<sup>21</sup> M. Cloetta, *Arch. expl. Path. Pharmacol.*, **250**, 126 (1912); A. Windaus, K. Westphal and G. Stein, *Ber.*, **61**, 1847 (1928).

<sup>22</sup> S. Smith, *J. Chem. Soc.*, 508 (1930); 23 (1931); C. Mannich, P. Mohs and W. Mauss, *Arch. Pharm.*, **268**, 453 (1930).

<sup>23</sup> H. Kiliani, *Arch. Pharm.*, **234**, 487 (1896).

<sup>24</sup> H. Kiliani, *Ber.*, **48**, 339 (1915).

of an acid, digitoxonic acid (XXV), of the same number of carbon atoms as digitoxose,<sup>25</sup> and the presence of a terminal methyl group was shown by the formation of acetic acid on oxidation with silver oxide.<sup>26</sup>

From the formation of *meso*-tartaric acid, it was concluded that the relative configuration of the hydroxyl groups on C-3 and C-4 of digitoxose was also *meso*. Further, on the basis of Hudson's lactone rule<sup>27</sup> as applied to digitoxonic lactone and of Hudson's phenylhydrazide rule<sup>28</sup> as applied to digitoxose carboxylic acid obtained from digitoxose by the cyanohydrin reaction, Kiliani<sup>29</sup> placed the two hydroxyl groups in question on the left of the chain. A striking fact at variance with the above and on which Kiliani comments is the dextro rotation shown by the lactone of the dihydroxyglutaric acid, XXVI, in contrast to the levo rotation of digitoxonic lactone. Nevertheless Kiliani preferred the structure XXIV for digitoxose, with the question of the configuration of the C-5 hydroxyl group remaining open.

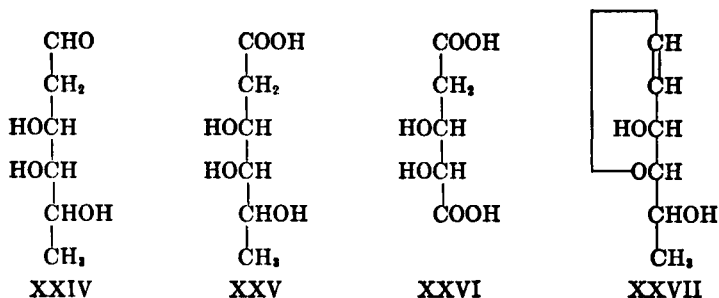

The configuration of the C-5 hydroxyl group was apparently definitely settled by Windaus and Schwarte,<sup>30</sup> who showed that the sublimate previously obtained by Cloetta<sup>20</sup> by heating the glycoside digitoxin, in a high vacuum is an anhydro derivative of digitoxose (XXVII) of the glycal type. As such it did not reduce Fehling's solution, but rapidly absorbed bromine and decolorized permanganate. On oxidation of the glycal XXVII (digitoxal) with perbenzoic acid, an aldo-hexamethyllose was obtained which must have one of the configurations XXVIII-XXXI,

<sup>25</sup> H. Kiliani, *Ber.*, **38**, 4041 (1905).

<sup>26</sup> H. Kiliani, *Ber.*, **32**, 2197 (1899).

<sup>27</sup> C. S. Hudson, *J. Am. Chem. Soc.*, **32**, 338 (1910).

<sup>28</sup> C. S. Hudson, *J. Am. Chem. Soc.*, **40**, 813 (1918).

<sup>29</sup> H. Kiliani, *Ber.*, **55**, 88 (1922).

<sup>30</sup> A. Windaus and G. Schwarte, *Nachr. Ges. Wiss. Göttingen, Math-phys. Klasse*, **1** (1926).

on the basis of Kiliani's conclusions. XXVIII, D-talomethylose, and XXIX, D-fucose, are excluded on the basis of the constants of the sugars and their phenylosazones. This leaves only 2-desoxy-L-alto-(or allo)-methylose, derived in turn from XXX or XXXI, as representing digitoxose. Kiliani's structure for the sugar may therefore be completed as shown in XXXII.

Three years later, serious doubt was cast on the structure XXXII for digitoxose. Freudenberg and Raschig<sup>31</sup> prepared L-altromethylose, XXXI, by hydrogenation of diacetone galactososen (5,6) and removal of the isopropylidene groups, a method which leaves no doubt as to the configuration present. The values for the specific rotation of L-altromethylose ( $-17^\circ$ ) and its phenylosazone ( $+75^\circ$ ) contrasted strongly with those for the hexomethylose ( $-0.8^\circ$ ) and its phenylosazone ( $-70^\circ$ ) obtained by Windaus and Schwarte from digitoxal. Furthermore, the constants of other known hexomethyloses and their osazones did not agree with those of the substance obtained by Windaus and Schwarte.

In order to reconcile the conflicting evidence as to the configuration of digitoxose, Micheel<sup>32</sup> reopened the entire question with a careful reinvestigation of all the hitherto published observations on both digitoxose and digitoxal and confirmed them. The conflicting interpretations were, however, cleared up by an extension of the work on digitoxal (XXVII). On oxidation of the double bond with ozone, a pentomethylose, which was characterized as the *p*-bromophenylosazone, was obtained.

From the four possible D-structures (XXXIII-XXXVI) for the pentomethylose, two bromophenylosazones are possible: one from D-lyxomethylose (XXXIII) or from D-xylomethylose (XXXIV), and one from D-arabomethylose (XXXV) or from D-ribomethylose (XXXVI). Of these, the former is excluded on the basis of its melting point ( $143-144^\circ$ ),<sup>33</sup> which is lower than that of the substance in question ( $160-161^\circ$ ). Formulas XXXIII and XXXIV and their antipodes are thus excluded for the pentomethylose from digitoxose. Likewise XXXV and its antipode may be excluded, since the C-2 and C-3 hydroxyl groups (corresponding to the C-3 and C-4 hydroxyl groups of digitoxose) bear a *trans*-relationship to one another. This leaves XXXVI, D-ribomethylose, or its mirror image, as the only permissible arrangement for the methylpentose from digitoxose.

<sup>31</sup> K. Freudenberg and K. Raschig, *Ber.*, 62, 373 (1929).

<sup>32</sup> F. Micheel, *Ber.*, 63, 347 (1930).

<sup>33</sup> E. Votoček, *Ber.*, 50, 40 (1917).

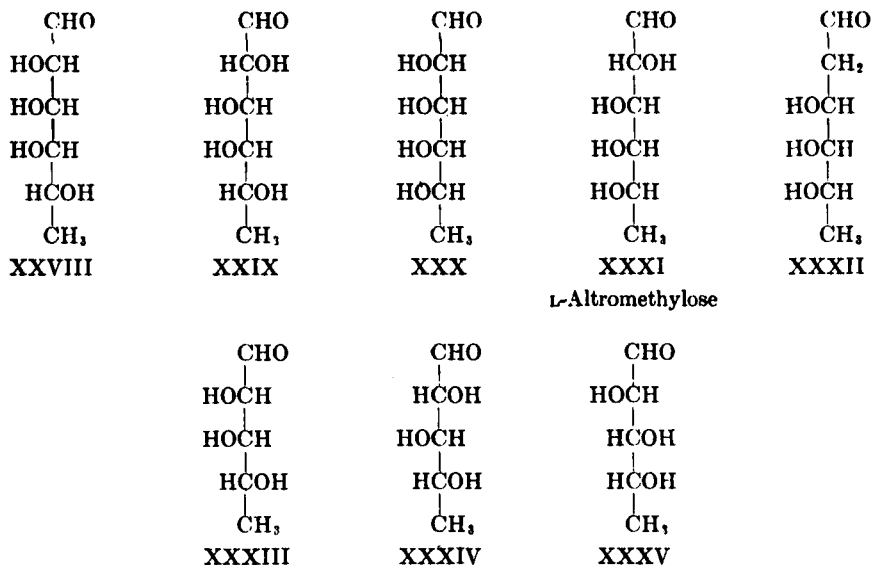

In order to confirm this conclusion, both D- and L-arabomethylose, which would give the same osazones as D- and L-ribomethylose, were prepared by ozonization of D- and L-rhamnal. Physical constants of derivatives of all pentomethyloses concerned in the argument are shown in Table III. From these data, as well as from mixed melting point

TABLE III

*Physical Constants of the Phenylsazones of the Pentomethyloses*

	<i>Phenylsazone</i>		<i>p-Bromophenylsazone</i>	
	<i>M.p.</i> , °C.	$[\alpha]_D^{25}$	<i>M.p.</i> , °C.	$[\alpha]_D^{25}$
D-Lyxomethylose			143-144 <sup>a</sup>	
L-Arabomethylose	173-4 <sup>b</sup>	<i>ca.</i> + 66.0°	160-161	0°
D-Arabomethylose	172-4	<i>ca.</i> - 65.0	160-161	0
Pentomethylose from digitoxose	173-4	<i>ca.</i> - 63.2	160-161	0

<sup>a</sup> E. Votoček, *Ber.*, 50, 40 (1917). <sup>b</sup> E. Fischer, *Ber.*, 29, 1382 (1896); O. Ruff and H. Kohn, *Ber.*, 35, 2364 (1902). <sup>c</sup> In pyridine:ethanol 2:3.

determinations, the pentomethylose in question was established as D-ribomethylose.

Digitoxose, therefore, is 2-desoxy-D-altro- (or allo)-methylose and is represented by by Formula XXXVII, and digitoxal by Formula XXXVIII.

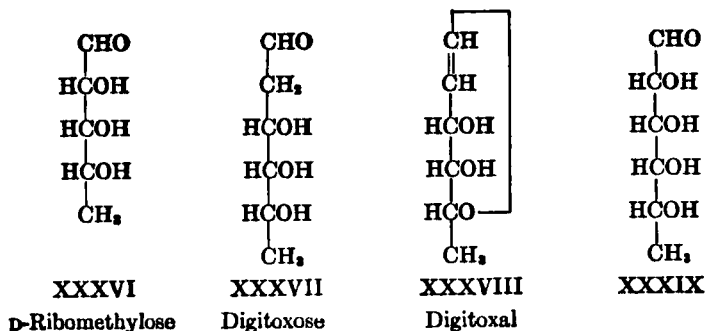

Further substantiation for this interpretation was obtained by Micheel<sup>32</sup> by characterization of the hexomethylose (XXXIX) formed when digitoxal is oxidized with perbenzoic acid. The phenylosazone of XXXIX showed the same melting point as that of L-altromethylose and the rotation was of equal value but of opposite sign. The product of the perbenzoic acid oxidation of digitoxal possesses the configuration demanded by the theory later advanced by Levene and Tipson<sup>34</sup> in the case where the C-3 hydroxyl group is unsubstituted.

Digitoxose, therefore, represents a case wherein the Hudson lactone rule fails insofar as the lactones of digitoxonic and digitoxosecarboxylic acids are concerned, a behavior paralleled by D-allonic acid lactone<sup>35</sup> of which digitoxose is a derivative. At the same time, the diamide of the glutaric acid obtained on oxidation of digitoxose now obeys Hudson's amide rule in the light of the above observations and also the lactone of this acid obeys the lactone rule.

## 2. Preparation

The procedure of Cloetta<sup>20,21</sup> for hydrolysis of either digitoxin or gitoxin represents the most convenient means of obtaining the sugar. Digitoxin is usually available commercially and the so-called "insoluble by-product" obtained by some manufacturers forms a convenient source of gitoxin. Either of the glycosides may be extracted from digitalis leaves by the procedures of Krafft<sup>36</sup> or Cloetta.

For hydrolysis of digitoxin, 1 g. of pure digitoxin is dissolved in 25 cc. of warm alcohol, and after cooling, 2 cc. of water and 3 cc. of concentrated hydrochloric acid (sp. gr., 1.19) are added to the solution. After standing for twenty-four hours at room temperature, the solution is

<sup>32</sup> P. A. Levene and R. S. Tipson, *J. Biol. Chem.*, **93**, 631 (1931).

<sup>34</sup> P. A. Levene and W. A. Jacobs, *Ber.*, **43**, 3146 (1910).

<sup>36</sup> F. Krafft, *Arch. Pharm.*, **250**, 126 (1912).



diluted and the precipitate of digitoxigenin is collected. The acid filtrate is neutralized with silver carbonate, excess silver is removed with hydrogen sulfide, and the resulting clear solution is extracted with chloroform for removal of any digitoxigenin remaining. The aqueous solution is then concentrated under reduced pressure at room temperature to a sirup, from which digitoxose usually crystallizes. As thus obtained, it is contaminated by an oil. The sugar is purified by crystallization from ethyl acetate, in which the oil is soluble. The yield of digitoxose is about 35% of the digitoxin taken. The sugar melts at 110° and shows  $[\alpha]_D^{20} +46.4^\circ$ .

Hydrolysis of gitoxin proceeds similarly except that because of its relative insolubility, it is necessary to reflux the glycoside in about 40 volumes of 60% alcohol containing 0.3–1.5% hydrochloric acid for forty-five to sixty minutes. The reaction mixture is processed as in the above case.

## V. CYMAROSE

### 1. Chemistry

Cymarose, the 3-methyl ether of digitoxose, has been obtained as a hydrolytic product of a number of cardiac glycosides as isolated from *Apocynum cannabinum*, *Apocynum androsaemifolium* and *Apocynum venetum*,<sup>37</sup> *Strophanthus kombé*, *Periploca graeca*,<sup>38</sup> and *Strophanthus emini*.<sup>5</sup> It was first isolated in crystalline form by Windaus and Hermanns.<sup>37</sup> From the observations that it gave no phenylosazone, that it yielded acetic acid on oxidation with silver oxide, and from the similarity of many of its color reactions to those of digitoxose, they suggested that it probably was a methyl ether of the latter 2-desoxyhexomethylose. Attempts to demethylate cymarose to digitoxose were unsuccessful, and the position occupied by the methyl group as well as the precise configuration of the sugar remained undetermined by Windaus and Hermanns.

The position of the methyl ether group as well as the direct establishment of the configuration of cymarose (XL) as identical with that of digitoxose were subsequently conclusively proved.<sup>39</sup> When cymarose is oxidized with 50% nitric acid, the lactone of a hydroxymethoxyglutaric acid (XLI) results. From the formation of a lactone from the primary product of the reaction, hydroxymethoxyglutaric acid, it follows that the hydroxyl group of the latter must be located on one of the  $\alpha$ -carbon atoms. This leaves only the  $\beta$ -carbon atom as the position occupied by the methoxyl group, since otherwise the highly improbable assumption of

<sup>37</sup> A. Windaus and L. Hermanns, *Ber.*, **48**, 979 (1915).

<sup>38</sup> W. A. Jacobs and A. Hoffmann, *J. Biol. Chem.*, **67**, 609 (1926); **79**, 519 (1928).

<sup>39</sup> R. C. Elderfield, *J. Biol. Chem.*, **111**, 527 (1935).

the presence of a  $\beta$ -lactone must be made. By reference to the cymarose formula (XL), it is seen that the methoxyl group in all probability is on carbon atom (3).

This conclusion was strengthened by the preparation of two different fully methylated cymaronic lactones. Cymarose was oxidized to cymaronic lactone, which was then methylated to give 5-methyl-cymaronic lactone (1,4) (XLII), a sirup which was characterized by the phenylhydrazide of the corresponding acid. On the other hand, methyl cymaropyranoside was completely methylated to methyl 4-methyl-cymaropyranoside. The latter, after hydrolysis of the glycosidic methyl group and oxidation, yielded 4-methylcymaronic lactone (1,5) (XLIII), also a sirup, but which differed in rotation from the 1,4-lactone and formed a different phenylhydrazide. Further, the assignment of a 1,5 structure to XLIII was supported by the formation of a dimethoxyglutaric acid on oxidation of XLIII with nitric acid.

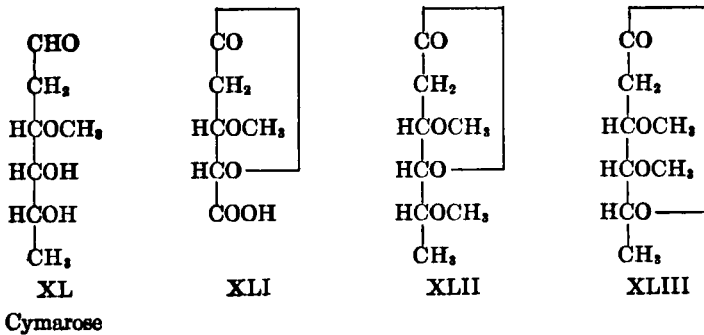

The production of two different fully methylated lactones at once proves that both of the hydroxyl groups at positions (4) and (5) of the hexose chain of cymarose are open, which leaves only position (3) for the methyl ether group, thus confirming the interpretation of the results of the oxidation of cymarose with nitric acid.

For a rigid proof of the configurational relationship of cymarose to digitoxose, methyl digitoxoside was prepared. For this purpose very mild conditions, the action of 0.1% methyl alcoholic hydrogen chloride, are necessary because of the extreme susceptibility of digitoxose to acidity. The glycoside thus obtained was completely methylated to give methyl dimethyldigitoxoside. When the latter, after hydrolysis of the glycosidic methyl group, was oxidized, about one-half of the resulting lactone was obtained as dimethyldigitoxonic lactone (1,4) (XLII), from which the phenylhydrazide of the corresponding acid was obtained and was found to be identical with the phenylhydrazide prepared from methylcymaronic lactone (1,4) (XLII).

In order to explain the formation of the relatively large amounts of  $\gamma$ -lactone from digitoxose, the course of glycoside formation at room temperature of both cymarose and digitoxose has been followed polarimetrically. The curves thus obtained are shown in Fig. 1 (page 149). That for digitoxose indicates a rapid initial reaction followed by a slower reaction. Following the work of Levene, Raymond and Dillon,<sup>40</sup> the rapid initial reaction is interpreted as indicative of furanoside formation. The polarimetric curve for cymarose shows only a single rapid reaction. However, as noted by Levene, Raymond, and Dillon,<sup>40</sup> the absence of a break in the curve is not to be taken as evidence for the absence of furanoside formation. The digitoxoside which was used in these experiments was obtained by stopping the reaction at the first disappearance of the Fehling test, which point corresponds to that of maximum furanoside formation as shown by the curve. In the case of cymarose, the glycoside used was prepared at the boiling point of methyl alcohol, which would naturally lead to the formation of pyranoside in preponderating amount.

Cymarose is, therefore, 3-methyldigitoxose. Since Micheel<sup>82</sup> has shown digitoxose to possess the configuration of 2-desoxy-D-allomethylose (2-desoxy-D-altromethylose), cymarose is represented by formula XL.

## 2. Preparation

In the United States, Canadian hemp (*Apocynum cannabinum*) is probably the most convenient source of cymarins, the glycosides from which cymarose is most easily obtained.

One thousand parts of the ground root of *Apocynum cannabinum* is percolated with boiling carbon tetrachloride as long as the root retains its strongly bitter taste. The percolate is concentrated to a sirup under reduced pressure and the sirupy residue is dissolved in 1000 parts of alcohol. To the alcohol solution at 50° is added water, also at 50°, until precipitation of resinous material is complete. The resin is removed by filtration and the filtrate clarified by use of basic lead acetate solution. The filtrate from the lead precipitate is freed from lead with hydrogen sulfide, and the filtrate from the lead sulfide is concentrated under reduction pressure to about one-hundredth of its volume. The residual solution is extracted with chloroform, in which cymarins are freely soluble. After drying with anhydrous sodium sulfate, contaminating impurities are precipitated by the addition of ether and removed by filtration. On addition of petroleum ether to this chloroform-ether solution, cymarins are precipitated as an amorphous solid. On recrystallization from methanol, the glycoside forms glistening prisms containing

<sup>40</sup> P. A. Levene, A. L. Raymond and R. T. Dillon, *J. Biol. Chem.*, **95**, 699 (1932).

methanol of crystallization. The very bitter tasting and highly poisonous substance melts indistinctly at 130–138° and shows  $[\alpha]_D^{20} +23.5^\circ$  in chloroform.

In addition to the above source of cymarín, the glycoside may also be conveniently obtained from *Strophanthus kombé* seeds, which are generally commercially available.<sup>16</sup> If an aqueous solution of the water soluble glycosides is extracted with chloroform, some cymarín may generally be obtained. For larger amounts, it is best to subject the seeds to the action of an enzyme as given above under the preparation of digitalose, followed by extraction of the concentrate with chloroform.

For hydrolysis of the glycoside, 3 g. of cymarín is dissolved in 12 cc. of absolute alcohol. After addition of a mixture of 12 cc. of water and 6 cc. of concentrated hydrochloric acid (sp. gr. 1.19), the solution is allowed to stand for five to six hours in the cold. After the addition of 3 volumes of water, the alcohol is removed under reduced pressure, care being taken that the temperature does not rise above 30°. Crystallization of the strophanthidin begins shortly and is completed on standing overnight. The strophanthidin (2 g.) is collected and washed with water.

The filtrate from the strophanthidin is then extracted with 5 portions of chloroform, and chloride ion is removed from the aqueous solution with silver carbonate. The resulting clear solution is concentrated at a temperature not exceeding 35° to a sirup. The sirup is repeatedly extracted with hot ether and crude cymarose precipitated from the ether extracts by the addition of petroleum ether. The crude sugar is dissolved in water, filtered from a little contaminating strophanthidin, the solution concentrated again to a sirup, and the extraction and precipitation repeated.

Alternately, the hydrochloric acid solution from the removal of the strophanthidin may be buffered with sodium acetate until it is no longer acid to Congo Red. The solution is then concentrated to dryness under reduced pressure at a temperature not exceeding 35° and the residue thoroughly extracted with hot ether. Further purification proceeds as above.

As thus obtained, cymarose forms fine needles which melt at 91°. It shows slight mutarotation in water, the final value for  $[\alpha]_D^{21}$  being  $+53.4^\circ$  (c 2.245, water<sup>16</sup>).

## VI. DIGINOSE

### 1. Chemistry

W. Karrer<sup>41</sup> reported the isolation of a hitherto unknown glycoside from *Digitalis purpurea* L., which is characterized by its well crystallizing

<sup>41</sup> W. Karrer, "Festschrift Emil C. Borell," Friedrich Reinhardt A. G., Basel, 238 (1936).

properties, but which is physiologically inactive at the usual dosage of other cardiac drugs. Shoppee and Reichstein<sup>42</sup> showed that on hydrolysis with very dilute acid, the glycoside, to which the name "diginin" was given, decomposed in accordance with the following equation, yielding an aglycon, diginigenin, and a sugar diginose:

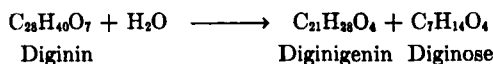

Diginose is soluble in ether and distills unchanged under high vacuum, in which behavior it closely resembles cymarose. This resemblance to cymarose was accentuated by the positive Keller-Kiliani test, characteristic of 2-deoxy sugars, and more strikingly by the physical properties of the new sugar, diginose. Like cymarose, on the basis of analytical data, diginose appeared to be a methyl ether of a 2-deoxyhexomethyllose. Furthermore, diginose as crystallized from ether, melted at 90–92° and showed a final value for  $[\alpha]_D^{22}$  in water of  $+60^\circ \pm 1^\circ$ , which compares with the corresponding values of 93° and  $+52^\circ$  for cymarose. However, mixed melting point determinations with cymarose showed a distinct depression, a difference which was substantiated by the failure of diginose to yield a crystalline phenylhydrazide of the corresponding acid after

TABLE IV

*Physical Properties of Methyl-2-deoxy-hexamethylsoses*

	Free sugar (H <sub>2</sub> O)		Phenyl- hydrazide of the acid. M.p., °C.	S-Benzylthiuronium salt of the acid.	
	M.p., °C.	$[\alpha]_D(\text{H}_2\text{O})$		M.p., °C.	$[\alpha]_D(\text{CH}_3\text{OH})$
Cymarose	93 <sup>a</sup>	+52° <sup>a</sup>	154 <sup>b</sup>	130°	0 ± 2°
Diginose	90–92 <sup>d</sup>	+55° <sup>e</sup>	amorphous <sup>d</sup>	137°	-9.2 ± 2°
Sarmentose	78–79°	+15.8°	?	146°	+6.5 ± 2°
Oleandrose	68–70 <sup>f</sup>	? <sup>f</sup>	136°	130°	+5.8 ± 2°

<sup>a</sup> W. A. Jacobs, *J. Biol. Chem.*, **88**, 519 (1930); W. A. Jacobs and R. C. Elderfield, *ibid.*, **91**, 625 (1931); M. Hartmann and E. Schlittler, *Helv. Chim. Acta*, **23**, 548 (1940).

<sup>b</sup> R. C. Elderfield, *J. Biol. Chem.*, **111**, 527 (1935). <sup>c</sup> C. W. Shoppee and T. Reichstein, *Helv. Chim. Acta.*, **25**, 1611 (1942). <sup>d</sup> C. W. Shoppee and T. Reichstein, *Helv. Chim. Acta.*, **23**, 975 (1943). <sup>e</sup> W. A. Jacobs and N. M. Bigelow, *J. Biol. Chem.*, **96**, 355 (1932).

<sup>f</sup> W. Neumann, *Ber.*, **70**, 2264 (1937). <sup>g</sup> R. Tschesche, K. Bohle and W. Neumann, *Ber.*, **71**, 1927 (1938).

oxidation of the sugar with bromine water, whereas cymarose under similar reaction conditions readily yields the phenylhydrazide of cymaronic acid.<sup>39</sup>

<sup>39</sup> C. W. Shoppee and T. Reichstein, *Helv. Chim. Acta*, **23**, 975 (1940).

In a later paper, the same authors<sup>43</sup> further pursue the chemistry of diginose. Diginonic acid was obtained in the form of its crystalline *S*-benzylthiuronium salt, and at the same time, similar salts of other 3-methyl-2-desoxy-hexamethyloses were prepared for comparison. Physical constants for these derivatives, as well as for the phenylhydrazides and free sugars are shown in Table IV, from which the non-identity of diginose with any of the other sugars is apparent.

A closer approach to the constitution and configuration of diginose was obtained by a study of the products of the oxidation of the sugar by potassium permanganate.<sup>43</sup> Model experiments on the relatively accessible cymarose showed that under the action of aqueous permanganate in sufficient amount to furnish four moles of oxygen, the oxidation proceeded in accordance with the following equation:

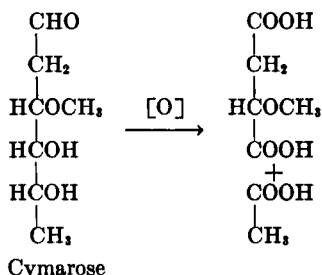

From the reaction products, there was isolated acetic acid as the *p*-phenylphenacyl ester, and (*levo*)-methoxysuccinic acid<sup>44</sup> as the diamide. When the same reaction was applied to diginose, acetic acid was isolated together with (*dextro*)-methoxysuccinic acid, the amide of the latter showing the same melting point as that obtained by the oxidation of cymarose but an equal rotation of opposite sign.

From the above it is concluded that diginose possesses the same structure as cymarose and has one of the configurations XLIV–XLVII. Of these formulas, XLVII can be eliminated, since it would correspond to *L*-cymarose, a configuration which is excluded on the basis of the physical constants of the sugar and its derivatives. Shoppee and Reichstein favor XLIV as the most probable possibility of the other three structures.

In an attempt to settle this point, the periodic acid glycol splitting reaction<sup>45</sup> was applied to cymarose in model experiments. The reaction

<sup>43</sup> C. W. Shoppee and T. Reichstein, *Helv. Chim. Acta*, 25, 1611 (1942).

<sup>44</sup> T. Purdie and G. W. Neave, *J. Chem. Soc.*, 97, 1519 (1910).

<sup>45</sup> F. Rappaport, J. Reifer and H. Weinmann, *Mikrochim. Acta* 1, 290 (1937).

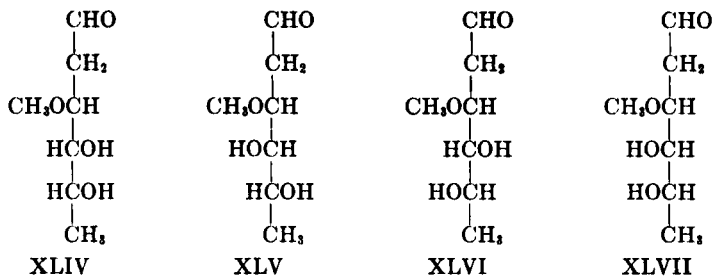

was slow and without a sharp endpoint, from which it was concluded that the periodic acid titration method is not applicable to all 2-desoxyhexoses.

## 2. Preparation

In the preparation of diginose it will be presupposed that diginin is available. The procedure for hydrolysis of the glycoside here given is that of Shoppee and Reichstein.<sup>42</sup>

To a solution of 1 g. of diginin in 30 cc. of methanol is added a solution of 3 g. of concentrated sulfuric acid in 30 cc. of water. The mixture is heated under reflux for thirty minutes on the steam bath. The solution is then concentrated under reduced pressure to about 30 cc. to remove the methanol, and extracted several times with chloroform for removal of the aglycon. The resulting aqueous solution is freed from chloroform by evacuation and sulfate ion is precipitated with barium carbonate. After filtering from barium salts, a drop of sodium carbonate is added to the filtrate, which is then treated with barium chloride solution until no further precipitate is obtained. Without filtration, the solution is then concentrated to dryness under reduced pressure at room temperature. The residue is thoroughly extracted with several small portions of acetone, the combined extracts filtered and concentrated to dryness under reduced pressure. The sirupy residue is then treated with ether, the solution allowed to stand for thirty minutes and then decanted from a small amount of insoluble resinous material, which is in turn extracted several times with ether. The combined ether solutions of the sugar are concentrated to a sirup which weighs 102 mg. After standing for several weeks in a desiccator over calcium chloride, the sirup deposits crystals melting at 75–80°. The crude diginose is distilled in a molecular still at 0.02 mm. pressure and a bath temperature of 80°. The distillate is crystallized from its anhydrous, concentrated ether solution by the addition of pentane. The pure sugar melts at 88–89° and shows  $[\alpha]_D +64.5^\circ \pm 1^\circ$  after 10 min.,  $+59.8^\circ \pm 1^\circ$  after 24 hrs. (*c* 0.8466, water).

*S-Benzylthiuronium Salt of Diginonic Acid.*<sup>43</sup> Thirty-five milligrams of diginonic lactone prepared by bromine oxidation of the sugar is saponified in 3 cc. of 0.1 *N* barium hydroxide solution by refluxing for thirty minutes on the steam bath. After cooling, the solution is neutralized with carbon dioxide, boiled for two minutes, filtered, and the filtrate is concentrated to dryness. The residue is taken up in 4 cc. of hot methanol and treated with a hot solution of 48 mg. of *S*-benzylthiuronium sulfate in 1 cc. of methanol. After centrifuging from barium sulfate, the clear solution is concentrated to dryness. The residue crystallizes on the addition of acetone. The salt is purified by solution in the minimum amount of hot methanol followed by addition of 3 volumes of hot acetone. If necessary, the hot solution thus obtained is filtered, concentrated and seeded, with addition of more acetone if necessary. The salt crystallizes in rosettes of fine plates and melts at 137–138° after several recrystallizations in the same manner.

The other *S*-benzylthiuronium salts, the constants of which are given above, are prepared in an analogous manner.

## VII. OLEANDROSE

### 1. Chemistry

From the leaves of the oleander (*Nerium Oleander*) various workers have isolated glycosides. Schmiedeberg<sup>46</sup> reported an amorphous glycoside, oleandrin. Windaus and Westphal<sup>47</sup> obtained the glycoside in crystalline form, and Windaus<sup>48</sup> postulated that on hydrolysis oleandrin gave gitoxigenin and a sugar thought to be digitalose. Fleury and Neumann<sup>49</sup> reported the isolation of a glycoside from oleander to which the name folinerin was given. Tschesche<sup>50</sup> showed the identity of oleandrin and folinerin. Neumann<sup>51</sup> in an investigation of the hydrolysis products of folinerin and of a second glycoside, adynerin, obtained the sugar component of the glycoside in crystalline form, although it was not brought to a state of analytical purity. The sugar proved to be not identical with digitalose as suggested by Windaus, but rather to be a methoxy-2-desoxy-sugar, presumably an isomer of cymarose,  $C_7H_{14}O_4$ , to which the name oleandrose was given. In accordance with this view, oleandrose shows a positive Keller-Kiliani test, and forms a 2,4-

<sup>46</sup> O. Schmiedeberg, *Arch. exptl. Path. Pharmacol.*, **16**, 149 (1882).

<sup>47</sup> A. Windaus and P. Westphal, *Nachr. Ges. Wiss. Göttingen, Math.-Physik. Kl.*, **78** (1925).

<sup>48</sup> A. Windaus, *Arch. exptl. Path. Pharmacol.*, **135**, 253 (1928).

<sup>49</sup> F. Fleury and W. Neumann, *Klin. Wochschr.*, **14**, 562 (1935).

<sup>50</sup> R. Tschesche, *Ber.*, **70**, 1554 (1937).

<sup>51</sup> W. Neumann, *Ber.*, **70**, 1547 (1937).



dinitrophenylhydrazone, which while not entirely pure, melts at 155–169°, but forms no osazone.<sup>52</sup> Tschesche and coworkers<sup>53</sup> have contributed somewhat more to the knowledge of oleandrose, although information on the sugar is still far from complete. By oxidation of oleandrose to oleandronic lactone and methylation of the latter, a methyl-oleandronic acid was formed and characterized as the phenylhydrazone. This was not identical with the phenylhydrazone of either 4-methyl- or 5-methylcymaronic acid<sup>54</sup> from which it is concluded that, on the assumption that oleandrose is a 3-methyl-2-desoxyhexomethylose, its configuration is different from that of cymarose.

## 2. Preparation<sup>51, 52, 53</sup>

For the isolation of oleandrose, either oleandrin or adynerin is satisfactory. In order to avoid excessive formation of an anhydroderivative of oleandrose, it is best to hydrolyze the glycoside in 10% methyl alcoholic hydrochloric acid at room temperature for a period of ten to twelve hours. The reaction mixture is then diluted, and after precipitation of the aglycon is complete, the latter is removed by filtration. Oleandrose may be extracted from the filtrate by ether in three hours in a continuous extractor, and crystallized from acetone with difficulty.

*Oleandronic Acid:* For purposes of oxidation to oleandronic acid, the sirupy sugar may be used. A solution of 2 g. of the sugar in 30 cc. of water containing 9 g. of barium benzoate is shaken with 1.3 cc. of bromine for two days. After removal of the excess bromine by aeration, filtration from benzoic acid, and removal of halide ion by silver carbonate, the sugar acid is extracted with ether in a continuous extractor. The acid is thus obtained as a sirup.

## VIII. SARMENTOSE

This sugar is obtained on hydrolysis of sarmentocymarín, a glycoside isolated from *Strophanthus sarmentosus* seeds by the enzymic method described above under the discussion of digitalose.<sup>54</sup> The sugar is a methyl ether of a 2-desoxyhexomethylose, isomeric with cymarose. It crystallizes from ether-petroleum ether as prisms or plates, melts at 78–79° and shows  $[\alpha]_D^{20} +12^\circ$ , 20 min. after solution, becoming constant after 24 hrs. at 15.8° (*c* 1.08, water). Beyond the preparation of the lactone, nothing further is known concerning sarmentose.

<sup>52</sup> G. Hesse, *Ber.*, 70, 2264 (1937).

<sup>53</sup> R. Tschesche, K. Bohle and W. Neumann, *Ber.*, 71, 1927 (1938).

<sup>54</sup> W. A. Jacobs and M. Heidelberger, *J. Biol. Chem.*, 81, 765 (1929); W. A. Jacobs and N. M. Bigelow, *ibid.*, 96, 355 (1932).

## IX. STROPHANTHOBIOSE

This sugar has been obtained only as a sirup by the careful hydrolysis of K-Strophanthin- $\beta$ , a glycoside of strophanthidin containing cymarose and glucose, isolated from *Strophanthus kombé* seeds.<sup>55</sup> The sugar is a disaccharide of cymarose and glucose, in which the reducing group of the former is considered to be free. The formation of this disaccharide is of interest in illustrating the ease of hydrolysis of the 2-desoxyglycosidic linkage compared with the more resistant normal glycosidic linkage.

<sup>55</sup> W. A. Jacobs and A. Hoffmann, *J. Biol. Chem.*, 69, 153 (1926).

This Page Intentionally Left Blank

# METABOLISM OF THE SUGAR ALCOHOLS AND THEIR DERIVATIVES

C. JELLEFF CARR AND JOHN C. KRANTZ, JR.

*Department of Pharmacology, School of Medicine, University of Maryland, Baltimore, Md.*

## CONTENTS

I. Introduction.....	175
II. Methyl Alcohol.....	176
III. Ethylene Glycol.....	176
IV. Glycerol.....	177
V. Tetritols.....	178
VI. Pentitols.....	180
VII. Hexitols.....	180
1. D-Mannitol and Anhydrides.....	181
2. D-Sorbitol.....	187
3. Polygalitol.....	191
4. Dulcitol.....	191
VIII. Summary.....	192

## I. INTRODUCTION

Owing to the close chemical relationship existing between the sugar alcohols and other carbohydrates and the conversion of the former into glycogen in the animal, the fate of the sugar alcohols in the animal body is of signal importance. In addition, the occurrence of the sugar alcohols in many edible plants warrants the study of their metabolic patterns. Besides, in recent years, the synthesis of such members of this class as sorbitol and mannitol as inexpensive commercial chemicals has opened new areas of application and usefulness for these substances. This applies not only to the sugar alcohols but also to a multiplicity of their derivatives which are appearing in ever increasing abundance as solvents and as emulsifying and dispersing agents for foods and vitamins.

The sugar alcohols or carbohydrate alcohols may be classified as a group of compounds obtained as reduction products of ketoses or aldoses or homologous compounds. Further, they may be considered as compounds of carbon, hydrogen and oxygen, containing typically one hydroxyl group for each carbon atom present in the molecule. Such a

classification in the aliphatic series of hydrocarbons would begin with methyl alcohol and ascend in the series through ethylene glycol and glycerol to mannoheptitol and higher alcohols. The names saccharols, glycitols and polyols may be assigned to this class of compounds.

In this review of the metabolism of the sugar alcohols emphasis will be centered mainly on the isomeric hexitols. Substances such as methyl alcohol and ethylene glycol are studied under categories other than the sugar alcohols. Furthermore, in common parlance, the term, sugar alcohol, as a rule, refers to the hexahydric alcohols and their availability as food in the human diet warrants special study of their metabolic patterns.

## II. METHYL ALCOHOL

Methyl alcohol is readily absorbed from the gastrointestinal tract, but is very slowly oxidized by the tissues. Approximately 30 percent of the absorbed alcohol remains unoxidized in the tissues 48 hours after ingestion. Roughly 40 percent of the compound is oxidized to formaldehyde and formic acid and a considerable quantity escapes in the exhaled air unchanged. Much of the formic acid formed is excreted in the urine as its sodium and ammonium salts. In addition to the depressant action of methyl alcohol upon the central nervous system, characteristic of the aliphatic alcohols, the compound elicits a definite toxic specificity for the optic nerve.

## III. ETHYLENE GLYCOL

As early as 1907 Dakin<sup>1</sup> reported that ethylene glycol followed the metabolic pattern in the animal body set forth by the following formulas:

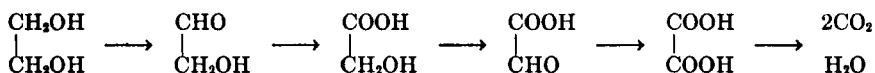

Dakin demonstrated the presence of oxalic acid in the urines of animals which ingested the glycol. He assumed the complete oxidation of the compound in the animal body. Later workers challenged this view and although, in many species of animals including man, a portion of ingested ethylene glycol is converted into oxalic acid, the glycol is not vigorously oxidized and in sufficient quantity will cause nausea, somnolence, prostration, coma and death owing to respiratory paralysis.<sup>2</sup>

<sup>1</sup> H. D. Dakin, *J. Biol. Chem.*, **3**, 57 (1907).

<sup>2</sup> J. H. Page, *J. Pharmacol.*, **30**, 313 (1927).

Shapiro,<sup>3</sup> working in Deuel's laboratory, showed in quantitative experiments on rats that ethylene glycol was neither a precursor of glycogen nor an antiketogenic agent. Likewise, in the phloridzinized dog, ethylene glycol was found by Page<sup>2</sup> to be incapable of producing extra sugar. In the series of sugar alcohols, ethylene glycol is the first compound to exhibit a definitely sweet taste. It was found by Carr<sup>4</sup> to be 1.3 times sweeter than sucrose.

#### IV. GLYCEROL

The occurrence of glycerol (glycerin) as a normal constituent of edible fats and its close chemical relationship to glyceric aldehyde, an intermediate metabolite of glucose, have made it the subject of exhaustive metabolic study. *In vitro*, glycerol is oxidized to dihydroxyacetone by hydrogen peroxide as shown by Dakin.<sup>5</sup> It is also oxidized by the *Acetobacter suboxydans* to dihydroxyacetone *in vitro*. When administered to phloridzinized dogs, glycerol is excreted in the urine as extra glucose. Likewise, it was demonstrated by Cremer<sup>6</sup> that diabetics excreted additional sugar when glycerol was ingested. Voegtlin<sup>7</sup> and his associates showed in 1925 that 20 percent solutions of glycerol were capable of relieving insulin shock either upon intraperitoneal or intravenous injection. In the earlier insulin days, it was believed that this condition did not obtain and that glycerol was ineffective against the convulsions and postural eccentricities caused by insulin hypoglycemia in the mouse. In the authors' opinion, the divergence of view results from the fact that glycerol is not so rapidly effective in combating insulin hypoglycemia as glucose and exhibits a time lag in its activity, for it must be first converted into glycogen to exhibit this effect.

Glycerol is an effective and efficient precursor of glycogen when administered to the rat by stomach tube. Catron and Lewis<sup>8</sup> showed that the content of glycogen in the liver rose from a fasting value of approximately 0.15 percent to 3 percent. In fact, glycogen formation from glycerol in the white rat is comparable to that obtained from the feeding of an equivalent amount of glucose.

<sup>3</sup> J. Shapiro, *J. Biol. Chem.*, **108**, 373 (1935).

<sup>4</sup> C. J. Carr, F. F. Beck and J. C. Krantz, Jr., *J. Am. Chem. Soc.*, **58**, 1394 (1936).

<sup>5</sup> H. D. Dakin, "Biological Oxidations and Reductions in the Animal Body," p. 10. Longmans, Green, London, 2nd ed. (1922).

<sup>6</sup> M. Cremer, *Münch. Wochschr.*, **49**, 944 (1902).

<sup>7</sup> G. Voegtlin, E. R. Dunn and J. W. Thompson, *J. Pharmacol., Proc.*, **25**, 168 (1925).

<sup>8</sup> L. F. Catron and H. B. Lewis, *J. Biol. Chem.*, **84**, 553 (1929).

Thus, one observes in the ascending order of carbon atoms in the sugar alcohols, the addition of (CH·OH) to ethylene glycol converting it to glycerol, converts the former into a completely utilizable compound. Almost all of the toxicity is obliterated. It serves as an efficient source of glycogen and hence from a metabolic standpoint behaves as a utilizable carbohydrate.

Glycide alcohol or glycidol, which is 1,2-anhydro glycerol, is not available as a precursor of glycogen in the white rat and it cannot serve as a substrate from which acid and gas can be formed by various microorganisms.<sup>9</sup>

#### V. TETRITOLS

The fourth group in ascending the series of sugar alcohols is the tetrیتols, of which the most available compound is erythritol. This compound is *meso*-butanetetrol-1,2,3,4 and was assigned the name, erythrite, by Berthelot in 1860. The present names of the compound, erythrol and erythritol, are modifications of erythrite. Erythritol is a white crystalline powder, with a sweetness more than twice that of sucrose.<sup>4</sup>

Lichens, fungi and algae, since they serve as natural sources of erythritol, might be expected to metabolize the alcohol. Some species are reported to utilize erythritol as a carbohydrate. Bacteria, with few exceptions, do not metabolize erythritol. Many species of intestinal bacteria fail to use erythritol as a nutrient for the production of gas and acid.<sup>9</sup> Certain bacteria found in "hay water" are capable of utilizing erythritol. Sorbose bacteria (*Acetobacter xylinum* Brown), which vigorously attack secondary alcohol groups, oxidize erythritol to a reducing sugar. Acetic acid bacteria are capable of multiplying in a medium containing erythritol as the only carbohydrate but they do not destroy the alcohol as evidenced by the amount recovered from the media at the end of the experiment. Yeast is totally incapable of metabolizing erythritol.

Other than an early report by Pfüger<sup>10</sup> that erythritol feeding lowered the liver-glycogen content of chickens, no reports on the fate of erythritol in the animal body have appeared until the studies of Beck, Carr and Krantz<sup>11</sup> in 1938. These investigators studied extensively the fate of

<sup>9</sup> K. P. Dozois, C. J. Carr, F. Hachtel and J. C. Krantz, Jr., *J. Bact.*, **32**, 499 (1936).

<sup>10</sup> Das Glykogen und seine Beziehung zur Zuckerkrankheit. Pfüger, Bohn (1905).

<sup>11</sup> F. F. Beck, C. J. Carr, J. C. Krantz, Jr., *Quart. J. Pharm. Pharmacol.*, **11**, 234 (1938).

erythritol and its anhydride, erythritan, in the white rat. The structures of the compounds are shown by the following formulas:

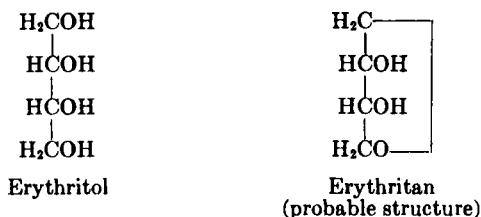

Erythritol is a white crystalline solid with a melting point of 121°C. (uncorrected). The anhydride, erythritan, prepared from erythritol by treatment with sulfuric acid is an almost colorless, mobile liquid which is water-soluble.

Beck found that erythritol and its anhydride were absorbed readily from the gastrointestinal tract of white rats and excreted in the urine in large quantities. Using the open circuit method of Haldane for the determination of respiratory quotients, it was shown that neither erythritol nor erythritan raised the respiratory quotient of the white rat, when administered by stomach tube. Likewise the administration of neither compound changed significantly the oxygen consumption of the rat. Külz<sup>10</sup> had shown previously that erythritol was not a precursor of glycogen in the liver of the fasting hen. Beck confirmed this in the liver of the rat and showed further that the anhydride behaved like the sugar alcohol in this respect.

Beck studied the acute toxicity, upon intraperitoneal injection, to mice of each compound. The anhydride was definitely less toxic. Erythritol in doses of 0.8 to 0.9 g. per 100 g. of mouse caused definite hypersensitivity, later convulsions, followed by death in two to three hours. Doses of 1.8 g. per 100 g. of mouse of erythritan produced convulsions followed by a lingering depression, ending usually in the death of the animal.

The tetranitrate of erythritol like the trinitrate of glycerol is a potent vasodilator and enjoys widespread use in the treatment of hypertension.

One observes from the studies conducted by Beck that although the three carbon atom sugar alcohol, glycerol, is completely metabolized, neither erythritol nor erythritan is available as a food to the animal body and each is refractory to biologic decomposition.

There appears to be no metabolic study in the literature concerning



the fate of the two optical isomers of erythritol. These compounds are:

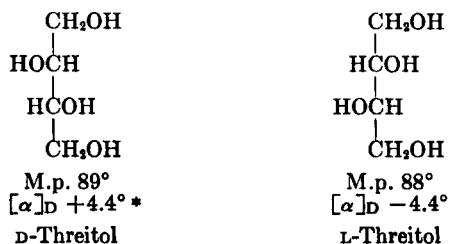

\* All rotations noted in this chapter refer to water solutions unless otherwise specified.

Although metabolic studies have not been conducted on these compounds, it is the opinion of the authors that these substances will be found refractory to metabolism by the animal body.

## VI. PENTITOLS

The following formulas show the structures of the four pentahydric alcohols or pentitols:

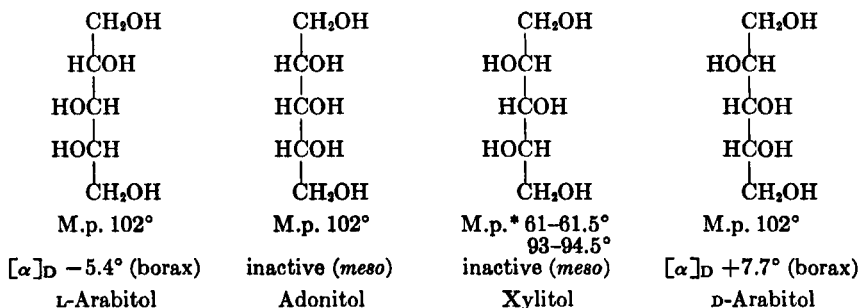

\* Dimorphous.

The sugar alcohols with five carbon atoms have never been studied physiologically. These compounds have not been readily available in quantities sufficient to warrant metabolic study. This remains, therefore, an unexplored field.

## VII. HEXITOLS

The following formulas show the structures of the various hexahydric sugar alcohols:

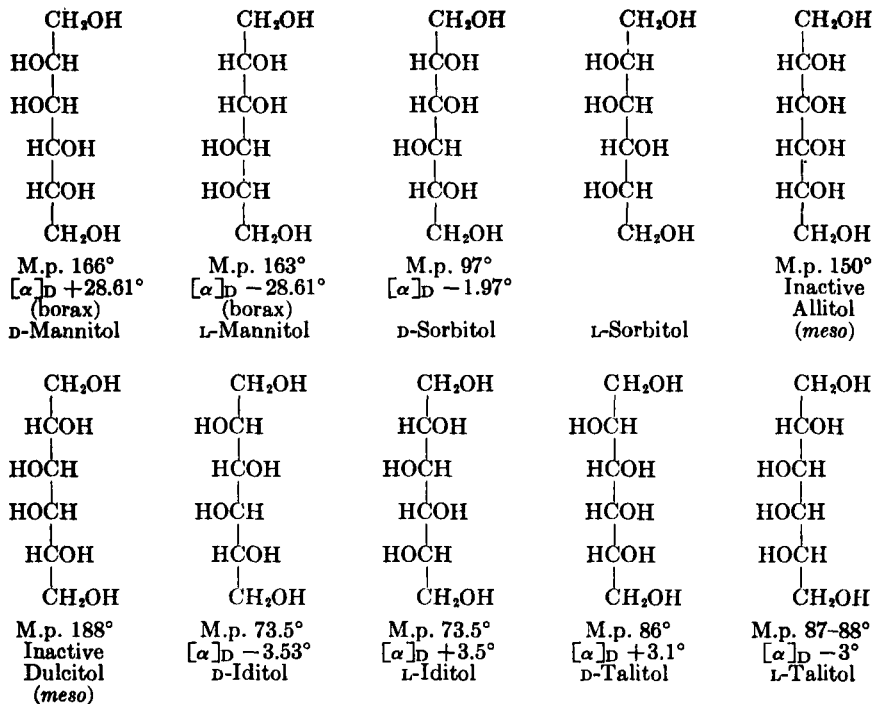

As these compounds approximate more closely D-glucose than the other sugar alcohols, those which are readily available have been the subjects of intensive metabolic study.

### 1. D-Mannitol and Anhydrides

D-Mannitol, mannite or manna sugar is the name applied to this hexahydric alcohol widely distributed throughout the vegetable kingdom. It comprises as much as 75% of the medicinal saccharin exudation known as manna, *Fraxinus ornus*. The compound was isolated first by Proust in 1806. The early metabolic studies on mannitol were carried out with the naturally occurring alcohol in manna, which is D-mannitol.

In 1883 Jaffe<sup>12</sup> showed that D-mannitol could be fed to dogs and recovered unchanged in large quantities from the urine. In rabbits the compound was partially metabolized. Sollmann<sup>13</sup> suggests the use of mannitol as a sweetening agent in the diabetic diet. In 1919 Field<sup>14</sup>

<sup>12</sup> M. Jaffe, *Z. physiol. Chem.*, **7**, 297 (1883).

<sup>13</sup> "A Manual of Pharmacology," Sollmann, T. R., Saunders, Philadelphia, 4th ed., 112 (1932).

<sup>14</sup> C. W. Field, *Proc. Soc. Exptl. Biol. Med.*, **17**, 29 (1919).

studied the effect of feeding 100 g. of mannitol and certain other compounds respectively on the blood-sugar curves of colored males. The maximum rise with glucose was 40 mg. per 100 cc.; with mannitol the maximum rise was 10 mg. per 100 cc. The failure of mannitol to relieve insulin shock in white rats was observed by Voegtlin et al.<sup>15</sup> In 1929 Ariyama and Takahashi<sup>16</sup> studied the growth curves of white rats on an adequate diet with various carbohydrates. Mannitol was found to be inferior to glycerol or ethyl alcohol. Early work on bacterial decomposition of mannitol is abundant. This subject was reviewed comprehensively by Eitel<sup>17</sup> in 1920. There appears to be no exhaustive study of the fate of mannitol in the animal body until 1933 when Carr et al.<sup>18</sup> began an extensive investigation of the metabolic patterns of mannitol and its anhydrides mannitan, mannide and isomannide.

Carr et al. used mannitol obtained from natural sources. It was shown that this compound was capable of serving as a precursor of glycogen in the liver of the white rat. Animals were fasted for twenty-four hours and then divided into two groups. The experimental animals were fed a ration of one-third mannitol and two-thirds cacao butter for a period of eighty hours. The rats were killed by exsanguination and the liver-glycogen content determined. The average percentage of glycogen in the livers of the control animals was 0.14; that of the mannitol-fed group was 1.23.

Mannitol was found to be incapable of significantly increasing the respiratory quotient of the white rat when administered in solution by stomach tube. In the fasting rabbit, blood-sugar levels were definitely elevated by the administration of mannitol by stomach tube. The increase in blood-sugar level was not nearly so great as that produced by an equal weight of glucose.

Silberman and Lewis<sup>19</sup> in 1933 published data contrary to the findings of the former investigators to indicate that mannitol behaved as an inert substance in the metabolic pattern of the white rat and was incapable of serving as a precursor of glycogen. They administered the mannitol by stomach tube. Later, Carr and Krantz<sup>20</sup> confirmed the work of Silberman and Lewis, showing that when mannitol is fed over comparatively long

<sup>15</sup> C. E. Voegtlin, E. R. Dunn and J. W. Johnson, *J. Pharmacol.*, **25**, 168 (1925).

<sup>16</sup> T. Ariyama and K. Takahashi, *J. Agr. Chem. Soc. (Japan)*, **5**, 674 (1929); *C. A.* **24**, 2166 (1930).

<sup>17</sup> E. H. Eitel, *Ind. Eng. Chem.*, **12**, 1202 (1920).

<sup>18</sup> C. J. Carr, R. Musser, J. S. Schmidt and J. C. Krantz, Jr., *J. Biol. Chem.*, **102**, 721 (1933).

<sup>19</sup> A. K. Silberman and H. B. Lewis, *Proc. Soc. Exptl. Biol. Med.*, **31**, 263 (1933).

<sup>20</sup> C. J. Carr and J. C. Krantz, *J. Biol. Chem.*, **124**, 221 (1938).

periods of time, it is absorbed and converted (partially at least) into glycogen. On the other hand, acute experiments on the administration of the sugar alcohol by mouth failed to produce the same results. In this series of experiments, Carr and Krantz showed that over a sufficiently long period of time, mannitol was capable of slightly increasing the respiratory quotient of the white rat. These data indicate to the authors that mannitol is converted partially into glycogen and glucose in the body and serves as a source of carbohydrate. The evidence indicates that it is not utilized directly.

Todd and coworkers<sup>21</sup> showed that mannitol did not elevate the blood-sugar level of dogs upon intravenous injection, but its isomer, sorbitol, served as a precursor of glucose under the same conditions. Smith and coworkers<sup>22</sup> found that upon intravenous injection of mannitol in man, 85 percent of the sugar alcohol was recoverable unchanged from the urine.

Ellis and Krantz,<sup>23</sup> using *Macacus rhesus* monkeys, administered 8 g. of mannitol per kilo of body weight by stomach-tube. Three hours later the animals were anesthetized with sodium pentobarbital and two or three portions of the liver were taken from different lobes of each animal for individual glycogen determinations. In four animals used as controls, the mean liver-glycogen value was 0.28 percent; with mannitol, in six animals, the value was 0.53 percent. This is not a definitely significant increase considering the wide variations in the control values. Sorbitol under the same conditions gave a mean value of 0.72 percent.

These investigators fed monkeys 3 g. of mannitol daily over a period of three months and found no histopathological changes in the important metabolic viscera of the animals. In man, the ingestion of 10 g. daily of mannitol over a period of one month produced no significant changes in the non-protein nitrogen, carbon dioxide-combining power of the blood, or red blood cell count. The phenolsulfonephthalein test indicated no kidney damage. In these experiments, the laxative threshold for mannitol in man was found to be between 10 and 20 g. ingested at one time. Over a period of two hours, the administration of 25 g. of mannitol to man neither increased the respiratory quotient, nor raised the blood-sugar level.

To summarize, the fate of mannitol in the animal body appears to proceed along the following pattern: absorption from the alimentary tract; partial conversion to glycogen in the liver; and the elimination of much of the sugar alcohol unchanged in the urine.

<sup>21</sup> W. R. Todd, J. Myers and E. S. West, *J. Biol. Chem.*, **127**, 275 (1939).

<sup>22</sup> W. W. Smith, N. Finklestein, H. W. Smith, *J. Biol. Chem.*, **135**, 231 (1940).

<sup>23</sup> F. Ellis and J. C. Krantz, *J. Biol. Chem.*, **141**, 147 (1941).

The first anhydride of mannitol is mannitan. Its relationship to the parent substance may be seen by the following formulas:

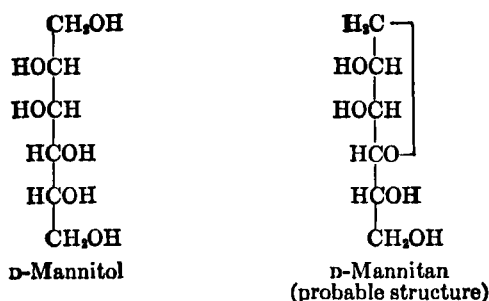

This anhydride is prepared from mannitol by dehydration with sulfuric acid according to the method of Vignon.<sup>24</sup> The fate of mannitan in the animal body was studied by Carr and coworkers.<sup>18</sup> These investigators observed that mannitan was incapable of serving as a precursor of glycogen in the liver of the white rat. It failed to raise the blood-sugar level of the rabbit or to relieve insulin shock in mice. Much of the compound was recovered unchanged from the urine of animals receiving it. It was observed, however, that mannitan significantly increased the respiratory quotient of the white rat. This was found to be due to the mobilization of tissue and liver glycogen stores and not to the utilization of mannitan either directly or through the medium of glucose. The minimum lethal dose by stomach tube per 100 g. of rat is 1.3 g. for mannitol and the value for mannitan is identical with it.

There are two double anhydrides of mannitol, namely, isomannide and  $\beta$ -mannide; the following formulas have been assigned to these compounds.

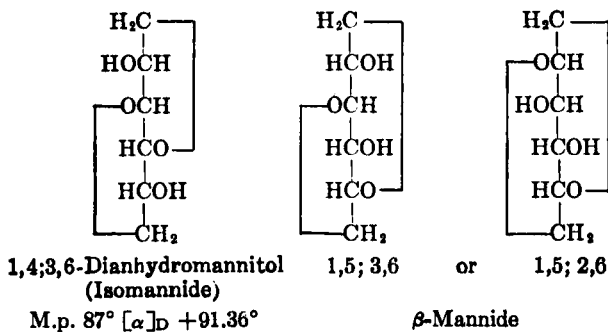

<sup>24</sup> L. Vignon, *Ann. chim. phys.*, [5], 2, 458 (1874).

The fate of these two derivatives of mannitol in the animal body was studied by Krantz and coworkers.<sup>26</sup> Neither compound was capable of serving as a precursor of glycogen in the liver of the white rat. Although isomannide exhibited no influence on the respiratory quotient of the rat,  $\beta$ -mannide, like mannitan, showed a slight but significant increase. Neither compound was capable of relieving insulin shock in mice or of raising the blood-sugar level of rabbits.

Isomannide, in an unaltered form, was found to be excreted in very large amounts in the urines of various animals. This prompted Krantz and Carr<sup>26</sup> to study the compound as a molecular species, osmotic pressure diuretic. Large quantities, 15 to 30 g., administered orally to man produced no untoward effects and elicited diuresis. Like urea, isomannide permeates the red blood cells, eliciting the characteristic osmotic phenomenon. The diuretic activity of isomannide is likely due to the failure of tubule reabsorption, thus increasing the osmotic pressure of the fluid upon which the water-absorbing cells act and thereby enhancing the volume of urine excreted. A method for the quantitative determination of isomannide in urine and blood filtrates was developed by these workers. The method depends upon the oxidation of isomannide with an excess of standard ceric sulfate solution, the reaction of the excess of oxidizing agent with potassium iodide, and the titration of the liberated iodine with standard sodium thiosulfate solution.

Isomannide contains two free hydroxyl groups: the compound is easily nitrated, producing a white crystalline compound. This compound produces a reduction of the arterial tension in many species of animals and man. It was studied extensively by Krantz and associates<sup>27</sup> and has had limited use in therapeutics. The hexanitrate of mannitol, the tetranitrate of erythritol, and glycerol trinitrate readily decompose when treated with dilute alkali. The dinitrate of isomannide is refractory to hydrolysis and by means of this, it was demonstrated that the depressor responses elicited by the nitrates of the sugar alcohols were due to the effect of their intact molecules and not to the products of hydrolytic cleavage and reduction.<sup>28,29</sup>

Owing to a shortage of glycerol in England toward the close of the first world war, fats without this polyhydric alcohol were prepared for

<sup>26</sup> J. C. Krantz, W. E. Evans and C. J. Carr, *Quart. J. Pharm. Pharmacol.*, **8**, 213 (1935).

<sup>26</sup> J. C. Krantz and C. J. Carr, *Proc. Soc. Exptl. Biol. Med.*; **39**, 577 (1938).

<sup>27</sup> J. C. Krantz, C. J. Carr, S. E. Forman and F. Ellis, *J. Pharmacol.*, **67**, 191 (1939).

<sup>28</sup> J. C. Krantz, C. J. Carr, S. E. Forman and F. Ellis, *J. Pharmacol.*, **70**, 323 (1940).

<sup>29</sup> M. M. Rath and J. C. Krantz, *J. Pharmacol.*, **76**, 33 (1942).

study. Halliburton and coworkers<sup>30</sup> studied the effect of the oleic acid ester of mannitol in a balanced ration for rats and observed that it possessed the same nutritional value as butter fat and was devoid of toxicity upon prolonged feeding. Recently mannide mono-oleate was studied by Evans and coworkers<sup>31</sup> as a substitute fat.

Mannide mono-oleate is a viscid, oily liquid with a yellow color. Its solubilities in various common solvents are similar to those of edible fixed oils and its odor is characteristic, resembling that of vegetable fixed oils.

Evans, and those associated with him, found that mannide mono-oleate was neither acutely nor chronically toxic in the diet of the white rat or in the diet of the *Macacus rhesus* monkey. The ester was shown to be absorbed from the intestinal tract of the rat. It was not re-excreted into the gut. Evidence of metabolism was produced by the isolation of crystals of isomannide from the urines of rats ingesting the compound.

Carr and Forman<sup>32</sup> prepared styracitol by the method of Zervas<sup>33</sup> who believed it to be 1,5-anhydro-D-sorbitol. Later Richtmyer and coworkers<sup>34</sup> showed by unequivocal evidence that it is 1,5-anhydro-D-mannitol. Styracitol was found to be a precursor of glycogen in the liver of the white rat. Its storage capacity as glycogen exceeds that of mannitol. However, styracitol neither elevates the respiratory quotient of the fasting white rat nor the blood-sugar level of the rabbit. This 1,5-anhydro-D-mannitol enjoys a fate in the animal body similar to D-mannitol but is distinctly more readily metabolized than either D-mannitan or D-isomannide.<sup>35</sup>

Roe and Hudson<sup>36</sup> demonstrated that D-mannoheptulose is physiologically available to the rabbit, which has a high tolerance for this heptose. This prompted Hiatt and coworkers<sup>37</sup> to study the capacity of the corresponding polyol, D-volemitol, which occurs in mushrooms and *Primula* species, as a precursor of glycogen in the liver of the white rat. Through a series of feeding experiments, Hiatt et al. concluded that

<sup>30</sup> W. D. Halliburton, J. C. Drummond and R. K. Cannan, *Biochem. J.*, **13**, 301 (1919).

<sup>31</sup> W. E. Evans, H. Wollenweber, M. Ruppertsberger and J. C. Krantz, *Proc. Exptl. Biol. Med.*, **51**, 222 (1942).

<sup>32</sup> C. J. Carr and S. E. Forman, *J. Biol. Chem.*, **128**, 425 (1939).

<sup>33</sup> L. Zervas, *Ber.* **63**, 1689 (1930).

<sup>34</sup> N. K. Richtmyer, C. J. Carr and C. S. Hudson, *J. Am. Chem. Soc.*, **65**, 1477 (1943).

<sup>35</sup> C. J. Carr and J. C. Krantz, *J. Biol. Chem.*, **124**, 221 (1938).

<sup>36</sup> J. H. Roe and C. S. Hudson, *J. Biol. Chem.*, **112**, 443 (1936).

<sup>37</sup> E. P. Hiatt, C. J. Carr, W. E. Evans and J. C. Krantz, *Proc. Soc. Exptl. Biol. Med.*, **38**, 356 (1938).

volemitol, unlike the hexahydric alcohol mannitol and unlike the heptose D-mannoheptulose, is not capable of serving as a precursor of glycogen in the liver of the rat.

Recently a series of compounds resulting from the reaction of mannitol esters with a varying number of moles of ethylene oxide have been made available commercially. These compositions serve as dispersion agents. One of these, mannitan monolaurate which is combined with 20 moles of ethylene oxide is employed as a dispersing agent for volatile oils, oil-soluble vitamins and many other edible and drug products. This product is an oily liquid, miscible in all proportions with water and alcohol; it is soluble in cotton seed oil and insoluble in ether.

The precise fate of this composition in the body has not yet been established. The authors have fed this substance to rats throughout their life span<sup>38</sup> in quantities representing 0.5 to 1 percent of their entire food intake, with impunity. Likewise, the compound was innocuous in the diet of the *Macacus rhesus* monkey over a two-year feeding period.

## 2. D-Sorbitol

D-Sorbitol is perhaps the most abundantly used of the hexahydric alcohols. The cost of sorbitol obtained from natural sources limited considerably its early metabolic studies in this country. However, European investigators have carried on rather extensive clinical studies with sorbitol during the last fifteen years. European methods of producing sorbitol in commercial quantities seem to antedate ours by several years. Sorbitol was introduced into therapeutics in Europe under the name of "Sionin" by Thannhauser and Meyer in 1929.<sup>39</sup>

Since 1929, various workers have investigated the value of sorbitol as a substitute carbohydrate in diabetes with findings which were polemic. Typical examples of the results of various European clinicians are cited as follows. Reinwein<sup>40</sup> administered sorbitol to diabetics and observed an increase in the respiratory quotient without a concomitant hyperglycemia. Contrariwise, Roche and Raybaud<sup>41</sup> observed no increase in the respiratory quotient under the same experimental conditions and Donhoffer and Donhoffer<sup>42</sup> observed a rise in blood sugar upon the administration of sorbitol to diabetics. Kaufmann<sup>43</sup> reported that sorbitol

<sup>38</sup> Unpublished reports of the authors.

<sup>39</sup> S. J. Thannhauser and K. H. Meyer, *Munch. med. Wochschr.*, **76**, 356 (1929).

<sup>40</sup> H. Reinwein, *Deut. Arch. klin. Med.*, **164**, 61 (1929).

<sup>41</sup> A. Roche and A. Raybaud, *Compt. rend. soc. biol.*, **113**, 320 (1933).

<sup>42</sup> S. Donhoffer and M. Donhoffer, *Deut. Arch. klin. Med.*, **167**, 257 (1930).

<sup>43</sup> E. Kaufmann, *Klin. Wochschr.*, **8**, 66 (1929).



exhibited a protein-sparing action and was a useful adjunct in the diabetic diet. Gottschalk<sup>44</sup> ascribed an "insulin-enticing" action to this compound and strongly recommended its use in diabetes.

The distinguished European clinician, von Noorden<sup>45</sup> recommended the use of sorbitol in the diets of mild and moderately severe diabetics. Furthermore, Bertrand and coworkers<sup>46</sup> observed that sorbitol was efficiently utilized in diabetics with and without insulin in their respective regimens.

The English workers, Payne and coworkers,<sup>47</sup> contrary to the findings of the continental investigators, reported that sorbitol was not directly metabolized, and they recommended it as an inert condiment in the diabetic diet. One of the first accounts of the metabolism of sorbitol in America was written by Silver and Reiner.<sup>48</sup> These workers found that the ingestion of the hexahydric alcohol produced hyperglycemia in a diabetic patient.

When sorbitol became available commercially in this country many laboratory workers set forth unequivocal evidence to show that in the rabbit, mouse and rat the compound was a precursor of glycogen. Ellis and Krantz<sup>23</sup> confirmed this observation with respect to the liver of the *Macacus rhesus* monkey. Todd and coworkers<sup>49</sup> made the observation that intravenous injections of sorbitol elevated the blood-sugar level of dogs, but similar doses of mannitol did not influence the glycemic state of the animal. These workers found approximately 50 percent of the dose of intravenous sorbitol solutions in the dog utilized and the remainder excreted in the urine unchanged. Waters<sup>50</sup> showed that intravenous solutions of sorbitol produced only a mild and transient hyperglycemia in dogs and furthermore, the administration of the sugar alcohol markedly depressed the glucose tolerance curve of the normal and depancreatized animal. Smith and coworkers<sup>22</sup> found that after the intravenous injections of solutions of mannitol or sorbitol into normal human beings, 85 percent of the mannitol was excreted in the urine unchanged and 32 percent of the sorbitol failed to undergo metabolism and appeared in the urine. The large number of experiments conducted on the fate of sorbitol in the body upon intravenous injection originated from the use of a 50 per-

<sup>44</sup> A. Gottschalk, *Ergeb. inn. Med. Kinderheilkunde*, **36**, 56 (1929).

<sup>45</sup> K. H. von Noorden, *Deut. med. Wochschr.*, **55**, 483 (1929).

<sup>46</sup> G. Bertrand, R. Radais and M. Labbé, *Bull. acad. méd.*, **8**, 112 (1934).

<sup>47</sup> W. W. Payne, R. D. Lawrence and R. A. McCance, *Lancet*, **225**, 1257 (1933).

<sup>48</sup> S. Silver and M. Reiner, *Arch. Intern. Med.*, **54**, 412 (1934).

<sup>49</sup> W. R. Todd, J. Myers and E. S. West, *J. Biol. Chem.*, **127**, 275 (1939).

<sup>50</sup> E. T. Waters, *Proc. XVI. Internat. Physiol. Cong., Zürich*, **122** (1938).

cent sorbitol solution intravenously in man as an acute diuretic. Sorbitol enjoys a rather wide use in this field today. In addition, Bellows and coworkers<sup>51</sup> found that the intravenous injection of sorbitol was useful in reducing intraocular tension in glaucoma. These workers used 100 cc. of a 50 percent solution intravenously and repeated every twenty-four hours.

Although certain investigators have claimed<sup>52</sup> that sorbitol failed to serve as a precursor of glycogen in the liver of the white rat, the preponderance of evidence points to the contrary. Carr and Forman,<sup>52</sup> and Johnston and Deuel<sup>53</sup> have set forth convincing evidence to show that sorbitol is readily converted into glycogen in the liver of the rat and that in this capacity its efficiency is approximately three times greater than mannitol.

Owing to the fact that sorbitol represents possibilities in normal and diabetic individuals as a substitute for other carbohydrates, chronic feeding studies were conducted by Ellis and Krantz<sup>23</sup> in *Macacus rhesus* monkeys and man. Later Ellis and coworkers<sup>54</sup> extended these studies through three successive generations of white rats. It was observed that the feeding of 3 g. of sorbitol a day to monkeys over a period of three months produced no histopathological findings in the metabolic viscera or any gross toxicologic symptoms. In man, the ingestion of 10 g. of sorbitol daily over a period of one month produced no significant changes in the non-protein nitrogen, carbon dioxide combining power of the blood or red blood cell count. The phenolsulfonephthalein test indicated no functional kidney impairment. In the white rat, diets consisting of 5 percent sorbitol did not affect deleteriously the rate of growth, liver-glycogen storing capacity or important metabolic viscera of the rat through three successive generations.

Extending these foregoing studies to the controversial problem of the value of sorbitol in the diabetic diet, Ellis and Krantz<sup>23</sup> carried out typical tolerance tests with the compound. In normal human subjects, 50 g. of sorbitol increased the respiratory quotient above the normal basal level. Within an observation period of two hours, the effect was similar to that produced by an equal quantity of D-glucose. The blood-sugar level was not significantly altered by the administration of sorbitol but was markedly elevated by D-glucose. In thirteen moderately severe diabetic

<sup>51</sup> J. Bellows, I. Puntney and J. Cohen, *Arch. Intern. Med.*, 20, 1036 (1938).

<sup>52</sup> N. R. Blatherwick, P. J. Bradshaw, M. E. Ewing, H. W. Larson, S. D. Sawyer, *J. Biol. Chem.*, 134, 549 (1940).

<sup>53</sup> C. Johnston and H. J. Deuel, *J. Biol. Chem.*, 149, 117 (1943).

<sup>54</sup> F. W. Ellis, C. J. Carr, E. J. Wiegand and J. C. Krantz, *Proc. Soc. Exptl. Biol. Med.*, 52, 260 (1943).

individuals, Ellis and Krantz<sup>56</sup> carried out tolerance studies using 50 g. of sorbitol and D-glucose, respectively. The following chart showing the average values for blood-sugar levels and respiratory quotients is clearly indicative of the fate of sorbitol in the diabetic. Obviously, in these

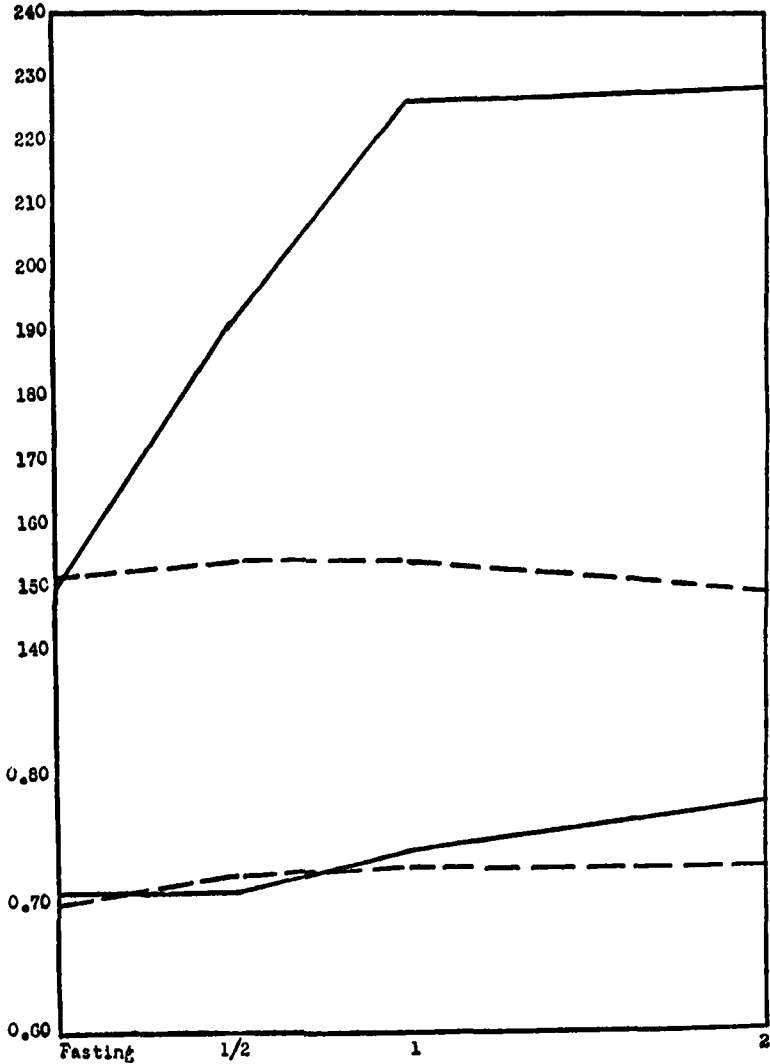

FIG. 1. Influence of D-glucose and sorbitol on the blood sugar and respiratory quotient of diabetics. Average of 13 cases. Solid line, D-glucose; broken line, sorbitol.

<sup>56</sup> F. W. Ellis and J. C. Krantz, *Ann. Intern. Med.* 18, 792 (1943).

thirteen cases of diabetes, sorbitol failed to raise the respiratory quotient. In the authors' opinion, it owes its value in diabetes to the fact that it is capable of being stored as glycogen and that its subsequent depolymerization and utilization fail to supply to the blood a plethora of glucose which would produce hyperglycemia. The authors point out that, although the ingestion fails to produce a hyperglycemia, there can be no question about the presence of a sorbitolemia. The question, therefore, which remains unanswered, is the relative effect on the impaired islet tissue of a hyperglycemia or a high blood-sorbitol level.

### 3. Polygalitol

Polygalitol is 1,5-anhydro-D-sorbitol<sup>54</sup>; it occurs naturally in *Polygala amara* and also in the American plant *Polygala senega*. The metabolism of this anhydride of sorbitol was studied by Carr and Krantz.<sup>55</sup> Unlike its precursor sorbitol, polygalitol was shown to be incapable of giving rise to additional liver glycogen in the rat. The compound does not relieve insulin shock in mice or raise the respiratory quotient of the rat. Although the oral administration of sorbitol significantly raises the blood-sugar level of the rabbit, polygalitol fails to produce this result. Thus, in general, one observes that the 1,4-anhydromannitol or mannitan and the 1,5-anhydrosorbitol, polygalitol, follow the same metabolic pattern of refractoriness. To our knowledge, no metabolic studies have been conducted on the other sorbitol anhydrides.

### 4. Dulcitol

This isomer of sorbitol and mannitol is less soluble and less sweet than the other two compounds. Also it is less available for the multiplicity of uses which mannitol and sorbitol have enjoyed. Dulcitol was first designated as the mannite of Madagascar manna and was shown by Laurent<sup>56</sup> in 1850 to be an isomer of mannitol. It is a meso form. In 1871 Bouchardat<sup>57</sup> synthesized the compound by reducing D-galactose with sodium amalgam. Until ten years ago, the only biological studies available on dulcitol were of a bacteriological nature. At that time the authors<sup>58</sup> studied the fate of dulcitol and dulcitan in the animal body.

It was observed that dulcitol was a precursor of glycogen in the liver of the white rat, although its capacity to produce glycogen upon repetitious feeding was less marked than that of mannitol and far less marked than that of sorbitol. Dulcitol neither elevated the respiratory

<sup>54</sup> A. Laurent, *Compt. rend.*, **30**, 41 (1850).

<sup>57</sup> G. Bouchardat, *Compt. rend.*, **73**, 199 (1871); *Ann. chim. phys.*, [4], **27**, 68 (1872).

<sup>58</sup> C. J. Carr and J. C. Krantz, Jr., *J. Biol. Chem.*, **107**, 371 (1934).

quotient of the rat nor the blood-sugar level of the rabbit. Dulcitan, consisting mainly of mono-anhydro-dulcitol, appeared to be completely refractory to biological processes.

The three hexitols, mannitol, sorbitol and dulcitol, have for more than a half century enjoyed a place of prominence in bacteriological culture media for the purpose of differentiating various types of organisms. More recently these hexitols and their anhydrides were studied as nutrient materials for the organisms of the colon-aerogenes group by Dozois and coworkers.<sup>59</sup> In general the results observed in the animal body obtain in bacterial cultures of this group of microorganisms, namely, that acid and gas are formed from hexitols as such, but not from their respective anhydrides. Many other organisms of the alimentary tract such as the lactobacillus, so prevalent in the oral cavity, fail to decompose the hexitols rapidly.

#### VIII. SUMMARY

In summary of the metabolic studies extant on the sugar alcohols, the following generalizations may be set forth.

1. Biological metabolic processes attack most of the sugar alcohols studied.
2. Glycerol, sorbitol and mannitol are non-toxic precursors of glycogen and hence are metabolizable in the animal body.
3. Generally speaking, the respective anhydrides of the sugar alcohols studied are not metabolized in the animal body.

<sup>59</sup> K. P. Dozois, C. J. Carr and J. C. Krantz, *J. Bact.*, **36**, 599 (1938).

# THE CHEMISTRY OF THE NUCLEIC ACIDS

BY R. STUART TIPSON

*Department of Research in Pure Chemistry,  
Mellon Institute, Pittsburgh, Pa.*

## CONTENTS

Introduction . . . . .	193
A. Ribosenucleic Acid . . . . .	196
I. Ribose Nucleosides . . . . .	198
1. Ribosylpurines . . . . .	198
2. Ribosylpyrimidines . . . . .	207
II. Ribose Nucleotides . . . . .	210
1. Ribosylpurine Nucleotides . . . . .	210
a. of Muscle . . . . .	210
b. of Ribosenucleic Acid . . . . .	214
2. Ribosylpyrimidine Nucleotides . . . . .	217
III. Ribosenucleic Acid . . . . .	219
1. Chemical Studies . . . . .	219
2. Enzymic and Physico-chemical Studies . . . . .	226
B. Desoxyribosenucleic Acid . . . . .	236
I. Desoxyribose Nucleosides . . . . .	238
1. Desoxyribosylpurines . . . . .	238
2. Desoxyribosylpyrimidines . . . . .	240
II. Desoxyribose Nucleotides . . . . .	241
1. Monophosphodesoxyribose Nucleotides . . . . .	241
2. Diphosphodesoxyribosyl-pyrimidines . . . . .	241
III. Desoxyribosenucleic Acid . . . . .	242

## INTRODUCTION

In the second half of the nineteenth century, biologists first enlisted the cooperation of the chemist to delve into those mysteries of the living cell which the microscope is incapable of revealing. Inspired by an anatomist named His, F. Miescher (a young biochemist of Basel) attempted chemical extraction from the cell of the substance having the characteristics of chromatin, the building unit of the chromosomes. He subjected pus cells to the action of dilute hydrochloric acid for several

weeks and then shook the product with ether; part of the solid material gathered at the ether-water interface, and the rest settled at the bottom of the aqueous layer. The latter consisted of practically pure nuclear material, which he named "nuclein." It was found to contain carbon, hydrogen, nitrogen, and phosphorus but no sulfur. It was insoluble in water, organic solvents, and dilute acids. However, it was more acidic than any known protein, being soluble in dilute alkalis.

In 1869, Miescher submitted to Hoppe-Seyler a manuscript describing this separation of the nuclear substance from the other constituents of pus cells, but the properties ascribed to nuclein seemed so startling and incredible to Hoppe-Seyler that he delayed its publication for two years while he and two of his students tested Miescher's methods on other promising materials. Miescher's conclusions having been verified, five papers on the subject appeared in 1871. Two were by Miescher,<sup>1</sup> the first embodying the work mentioned, the second describing an apparently similar material from egg-yolk which he had studied in the meantime; one by Hoppe-Seyler<sup>2</sup> on the nuclein from yeast-cells; one by Plosz<sup>3</sup> on the nuclein from the red cells of birds and reptiles; and one by Lubavin<sup>4</sup> on a seemingly similar material from casein. The properties of these substances resembled those of Miescher's nuclein, but the elementary composition depended on the source of the nuclein.

Miescher had been handicapped by the difficulty of isolating nuclein in amounts adequate for further study, but he now turned his attention to the nuclear material from a source readily accessible in Basel—the ripe spermatozoa of the salmon. He discovered that this nuclein is a compound of a polybasic organic acid with a basic substance. In 1889, Altmann<sup>5</sup> introduced the term "nucleic acid" to describe the acidic constituent, and furnished a general method for its isolation.

After years of work it has become possible to make the generalization that the nucleus of every cell invariably consists largely of nucleoproteins\*—compounds of nucleic acids and proteins. A few of the most important and interesting materials containing nucleoproteins are the chromosomes,<sup>6</sup> the genes, and certain viruses, bacteriophages, and antigens. Yeast and

<sup>1</sup> F. Miescher, in Hoppe-Seyler's *Med.-chem. Untersuch.*, 441, 502 (1871).

<sup>2</sup> F. Hoppe-Seyler, in Hoppe-Seyler's *Med.-chem. Untersuch.*, 486 (1871).

<sup>3</sup> P. Plosz, in Hoppe-Seyler's *Med.-Chem. Untersuch.*, 461 (1871).

<sup>4</sup> N. Lubavin, in Hoppe-Seyler's *Med.-chem. Untersuch.*, 463 (1871).

<sup>5</sup> R. Altmann, *Arch. Anat. Physiol., Physiol. Abt.*, 524 (1889).

\* For an excellent review, see J. P. Greenstein, "Nucleoproteins," in *Advances in Protein Chemistry*, 1, 209. Academic Press, New York, (1944).

<sup>6</sup> T. Caspersson, *Naturwissenschaften*, 23, 527 (1935); 24, 108 (1936); T. Caspersson and J. Schultz, *Proc. Natl. Acad. Sci. U. S.*, 26, 507 (1940).

such glandular tissues as thymus and pancreas are especially rich in nucleoprotein and are the principal sources of nucleic acids, which are liberated by enzymic or mild chemical hydrolysis of the nucleoproteins.

In 1891, Kossel<sup>7</sup> reported the first study of the hydrolysis of a protein-free nucleic acid. Mainly as a result of his work, it was recognized that there are *two* nucleic acids, similarly constituted but differing in certain components. The nucleic acid readily isolated from yeast is of one type; that from thymus gland and fish sperm is of the other. It is possible that other nucleic acids exist; in fact, there have been indications from time to time that there *are* other nucleic acids, but only the two types under discussion have been adequately characterized.

Later investigators completed the identification of the products of hydrolysis of the two nucleic acids, which are now known to be the substances shown in Table I. By 1903 all the nitrogenous bases had

TABLE I  
*Composition of Nucleic Acids*

<i>Nucleic Acid from Yeast</i>	<i>Nucleic Acid from Thymus</i>
Phosphoric acid	Phosphoric acid
Adenine <sup>a</sup>	Adenine <sup>a</sup>
Guanine <sup>b</sup>	Guanine <sup>b</sup>
Cytosine <sup>c</sup>	Cytosine <sup>c</sup>
Uracil <sup>d</sup>	Thymine (5-methyluracil)
D-Ribose <sup>e</sup>	2-Desoxy-D-ribose <sup>f</sup>

(a) Formula on p. 200; (b) p. 200; (c) p. 208; (d) p. 208; (e) p. 199; (f) p. 239.

been recognized, and in 1909 Levene identified the sugar of "yeast nucleic acid," but the nature of the sugar of "thymus nucleic acid" remained a mystery until 1929, when it was identified by Levene.

Thus the two nucleic acids differ in composition as regards the constituent sugar and one pyrimidine base. The striking difference in the chemical and physical properties of the two acids is occasioned by the properties of the *sugar* component, so that they are known as *ribose-nucleic acid* and *desoxyribose-nucleic acid*, respectively.

An earlier distinction made between *plant* nucleic acid and *animal* nucleic acid has been abandoned with the definite identification of a ribosenucleic acid occurring concomitantly with desoxyribosenucleic acid in certain animal tissues (*e.g.*, in pancreas<sup>8</sup> and in chicken embryos<sup>9</sup>),

<sup>7</sup> A. Kossel, *Arch. Anat. Physiol., Physiol. Abt.*, 181 (1891).

<sup>8</sup> E. Hammarsten and E. Jorpes, *Z. physiol. Chem.*, **118**, 224 (1922); W. Jones and M. E. Perkins, *J. Biol. Chem.*, **62**, 291 (1924); E. Jorpes, *Acta Med. Scand.*, **68**, 503 (1928); *Biochem. J.*, **28**, 2102 (1934); P. A. Levene and E. Jorpes, *J. Biol. Chem.*, **86**, 389 (1930).

<sup>9</sup> H. O. Calvery, *J. Biol. Chem.*, **77**, 489 (1928).



and of desoxyribosenucleic acid together with ribosenucleic acid in plants.<sup>10</sup> Furthermore it has been found that ribosenucleic acid occurs in the metachromatic granules of yeast cells<sup>11,12</sup> and in the cytoplasm of the rye germ,<sup>13</sup> whereas desoxyribosenucleic acid resides in the nuclei of these cells. Feulgen believed that desoxyribosenucleic acid may be a constituent of all cell nuclei and that ribosenucleic acid is a cytoplasmic constituent, but Caspersson and Schultz<sup>6</sup> have found that ribosenucleic acid is present in both the cytoplasm and the nucleus of a variety of cells.

### A. Ribosenucleic Acid

Yeast is the chief source of ribosenucleic acid, one of the simplest methods of isolation being that of Levene.<sup>14,15</sup> It consists in adding, with grinding, an aqueous solution of potassium hydroxide to a thick paste of pressed yeast, till faintly alkaline to litmus; saturated aqueous picric acid solution is now added and the mixture filtered. The filtrate contains nucleic acid, which is precipitated by adding hydrochloric acid.

The same nucleic acid may be prepared<sup>16</sup> from wheat embryo and was formerly called "triticonucleic acid." A ribosenucleic acid<sup>8</sup> from pancreas, which has been named "allonucleic acid," has not been well characterized.

On hydrolyzing ribosenucleic acid with very dilute ammonia at 115° for one hour,<sup>17,18</sup> or with cold alkali,<sup>19</sup> there is obtained an equimolecular mixture of four *nucleotides* known, respectively, as adenylic, guanylic, cytidylic, and uridylic acids.

Complete hydrolysis (with mineral acid) of each of these nucleotides gives the appropriate purine or pyrimidine base, phosphoric acid, and a pentose or furfural (its degradation product). Since the nucleotides

<sup>10</sup> R. Feulgen and H. Rossenbeck, *Z. physiol. Chem.*, **135**, 203 (1924); A. N. Belozerskii and S. D. Chigirev, *Biokhimiya*, **1**, 134 (1936); A. N. Belozerskii and I. I. Dubrovskaya, *Biokhimiya*, **1**, 665 (1936); A. N. Belozerskii and N. V. Cheburkina, *Biokhimiya*, **2**, 752 (1937).

<sup>11</sup> B. Delaporte and N. Roukhelman, *Compt. rend.*, **206**, 1399 (1938).

<sup>12</sup> This is the readily isolable "yeast nucleic acid."

<sup>13</sup> R. Feulgen, M. Behrens and S. Mahdihassan, *Z. physiol. Chem.*, **246**, 203 (1937); M. Behrens, *Z. physiol. Chem.*, **253**, 185 (1938).

<sup>14</sup> P. A. Levène, in P. A. Levene and L. W. Bass, "Nucleic Acids," p. 301. Chemical Catalog Company, New York (1931).

<sup>15</sup> P. A. Levene, *Biochem. Z.*, **17**, 120 (1909).

<sup>16</sup> T. B. Osborne and I. F. Harris, *Z. physiol. Chem.*, **36**, 85 (1902); P. A. Levene and F. B. La Forge, *Ber.*, **43**, 3164 (1910).

<sup>17</sup> P. A. Levene, *J. Biol. Chem.*, **33**, 425 (1918).

<sup>18</sup> P. A. Levene, *J. Biol. Chem.*, **40**, 415 (1919).

<sup>19</sup> P. A. Levene, *J. Biol. Chem.*, **55**, 9 (1923).

are non-reducing to Fehling's solution it was concluded that either the phosphoric acid or the base is bound to carbon atom (1) of the sugar.

Mild acid hydrolysis of the deaminated purine nucleotides, xanthic acid and inosinic acid, gives the purine bases (xanthine<sup>20,21</sup> and hypoxanthine,<sup>22</sup> respectively) and a *reducing* sugar phosphate. The same hydrolytic products are obtained by use of a specific pancreatic enzyme.<sup>23</sup>

On the other hand, mild alkaline hydrolysis<sup>24</sup> of a nucleotide, or treatment with the appropriate enzyme,<sup>25,26</sup> liberates free phosphoric acid and a non-reducing compound of base and sugar, known as a *nucleoside*. (Hydrolysis of ribonucleic acid<sup>27,28</sup> with fairly dilute ammonia under pressure, during 3.5 hours at a bath temperature of 175 to 180°, gives an equimolecular mixture of four nucleosides).

It is therefore obvious that in the *nucleotides* the base (B) is attached to the reducing group of the phosphosugar, so their general formula may be written thus:

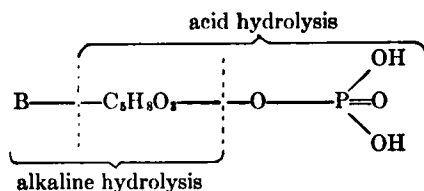

Historically, this method of stepwise hydrolysis seems to have been first applied to a nucleotide by Levene and Jacobs, in determining the structure of "muscle inosinic acid."

The general formula of nucleotides having been established, complete knowledge of the structure of each nucleotide involved the determination of (a) the nature of the base; (b) the nature of the sugar; (c) the stereochemical disposition of the sugar-base link; (d) the position of the union of the sugar to the base; (e) the ring structure of the sugar residue; and (f) the position of the phosphoryl ("phospho") group on the sugar chain.

<sup>20</sup> P. A. Levene and A. Dmochowski, *J. Biol. Chem.*, **93**, 563 (1931).

<sup>21</sup> P. A. Levene and S. A. Harris, *J. Biol. Chem.*, **95**, 755 (1932).

<sup>22</sup> P. A. Levene and S. A. Harris, *J. Biol. Chem.*, **101**, 419 (1933).

<sup>23</sup> H. Ishikawa and Y. Komita, *J. Biochem. (Japan)*, **23**, 351 (1936); Y. Komita, *ibid.*, **25**, 405 (1937); **27**, 23 (1938).

<sup>24</sup> P. A. Levene and W. A. Jacobs, *Ber.*, **42**, 2469 (1909).

<sup>25</sup> F. Bielschowsky, *Z. physiol. Chem.*, **190**, 15 (1930); F. Bielschowsky and F. Klemperer, *ibid.*, **211**, 69 (1932); H. Bredereck, H. Beuchelt and G. Richter, *ibid.*, **244**, 102 (1936); H. Bredereck, *Ber.*, **71**, 408 (1938).

<sup>26</sup> J. M. Gulland and T. F. Macrae, *J. Chem. Soc.*, 662 (1933).

<sup>27</sup> P. A. Levene and W. A. Jacobs, *Ber.*, **42**, 2474 (1909).

<sup>28</sup> P. A. Levene and W. A. Jacobs, *Ber.*, **43**, 3150 (1910).

Knowledge concerning the first five of these points was obtained through a study of the corresponding nucleosides and the results were confirmed by study of the nucleotides; they will be discussed in the order mentioned.

## I. RIBOSE NUCLEOSIDES

*Nature of the Bases.* The bases were readily, and hence early, identified as the purines adenine and guanine; and the pyrimidines cytosine and uracil. They were isolated first by complete hydrolysis of nucleic acid, and later from the individual nucleosides. Levene<sup>15</sup> showed that the two purine and the two pyrimidine bases occur in ribosenucleic acid in equimolecular proportions, and for the purines this conclusion has been confirmed.<sup>28a</sup>

As regards the next four details of structure, let us first consider the *purine* nucleosides from ribosenucleic acid.

### 1. *Ribosylpurines*

The purine nucleosides from ribosenucleic acid are adenosine and guanosine. Historically, guanosine was the first ribose nucleoside to be discovered, having been isolated from plant extracts by Schulze<sup>29</sup> in 1885 and named "vernine." In 1909 it was prepared from ribosenucleic acid by Levene and Jacobs,<sup>27</sup> who also isolated adenosine<sup>30</sup> from the same source. These two nucleosides are readily hydrolyzed by dilute mineral acid to give the respective bases and the same sugar.

*Nature of the Sugar.* The identity of the sugar portion of these purine nucleosides puzzled investigators for many years. Hammarsten,<sup>31</sup> in 1894, had shown that the sugar of ribosenucleic acid is a pentose, but some fifteen years elapsed before Levene and Jacobs<sup>32, 33, 34</sup> succeeded in isolating the sugar in crystalline form and identifying it as D-ribose, a sugar then unknown. Its specific rotation and melting point were different from those of the known pentoses, yet the melting point and numerical value (but not the sign) of the specific rotation of its osazone and *p*-bromophenylosazone were the same as for those derivatives of L-arabinose. However it was not D-arabinose<sup>35a</sup> since, as mentioned,

<sup>28a</sup> S. Graff and A. Maculla, *J. Biol. Chem.*, **110**, 71 (1935).

<sup>29</sup> E. Schulze and E. Bosshard, *Z. physiol. Chem.*, **9**, 420 (1885); **10**, 80 (1886).

<sup>30</sup> P. A. Levene and W. A. Jacobs, *Ber.*, **42**, 2703 (1909).

<sup>31</sup> O. Hammarsten, *Z. physiol. Chem.*, **19**, 19 (1894).

<sup>32</sup> P. A. Levene and W. A. Jacobs, *Ber.*, **41**, 2703 (1908).

<sup>33</sup> P. A. Levene and W. A. Jacobs, *Ber.*, **42**, 1198 (1909).

<sup>34</sup> P. A. Levene and W. A. Jacobs, *Ber.*, **44**, 746 (1911).

<sup>35a</sup> A. Wohl, *Ber.*, **26**, 730 (1893); O. Ruff, *Ber.*, **32**, 550 (1899).

its specific rotation was different, and its benzylphenylhydrazone differed from that of *D*-arabinose.<sup>35b</sup> Furthermore, on gentle oxidation it gave *D*-ribonic acid, enantiomorphous with that prepared synthetically by Fischer and Piloty<sup>36</sup>; and on further oxidation it yielded an inactive trihydroxyglutaric acid. Its identity was finally and completely verified when Alberda van Ekenstein and Blanksma succeeding in synthesizing,

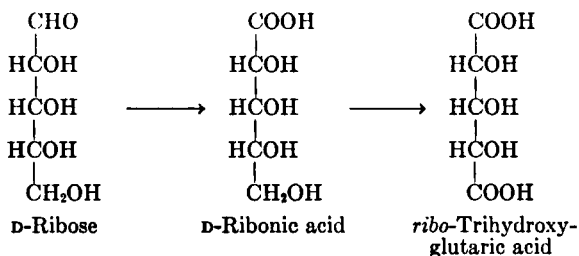

and crystallizing, first *L*-ribose<sup>37</sup> and later *D*-ribose.<sup>38</sup> The crystalline, synthetic *D*-ribose proved to be identical with the crystalline, natural *D*-ribose of Levene and Jacobs.

Gulland and coworkers<sup>38a</sup> recently confirmed the finding that the sugar component of the four mononucleotides of yeast pentosenucleic acid is *D*-ribose through the isolation of *D*-ribonic benzimidazole and they also reported that a small amount of *L*-lyxonic benzimidazole was detected; how this latter result is to be interpreted is not yet clear.

*Stereochemical Configuration.* Deamination by means of nitrous acid transforms adenosine into inosine<sup>28, 39, 40</sup> (ribosyl-hypoxanthine), and guanosine into xanthosine<sup>26, 28, 41</sup> (ribosyl-xanthine). These four purine nucleosides are hydrolyzed rapidly, and with equal ease, by dilute mineral acids. They are also all hydrolyzed by the same enzyme, so it is reasonable to presume that they are similarly constituted as regards the stereochemical disposition at the sugar-base link. Whether this is of the  $\alpha$ - or  $\beta$ -configuration is still unknown.

*Position of Attachment of Ribosyl Group to Base.* For the same reason (see above), it is also assumed that the position of union of sugar to base is the same for all four purine nucleosides.

<sup>35b</sup> O. Ruff and G. Ollendorff, *Ber.*, **32**, 3234 (1899).

<sup>36</sup> E. Fischer and O. Piloty, *Ber.*, **24**, 4214 (1891).

<sup>37</sup> W. Alberda van Ekenstein and J. J. Blanksma, *Chem. Weekblad*, **6**, 373 (1909).

<sup>38</sup> W. Alberda van Ekenstein and J. J. Blanksma, *Chem. Weekblad*, **10**, 664 (1913).

<sup>38a</sup> J. M. Gulland and G. R. Barker, *J. Chem. Soc.*, 625 (1943); J. M. Gulland, *ibid.*, 208 (1944); G. R. Barker, Kathleen R. Cooke and J. M. Gulland, *ibid.*, 339 (1944).

<sup>39</sup> P. A. Levene and R. S. Tipson, *J. Biol. Chem.*, **111**, 313 (1935).

<sup>40</sup> J. M. Gulland and E. R. Holiday, *J. Chem. Soc.*, 765 (1936).

<sup>41</sup> P. A. Levene, *J. Biol. Chem.*, **55**, 437 (1923).



position (1') nor (3') is the point of union to the base; nor is position (8'), as then he would have obtained a trimethyl derivative.

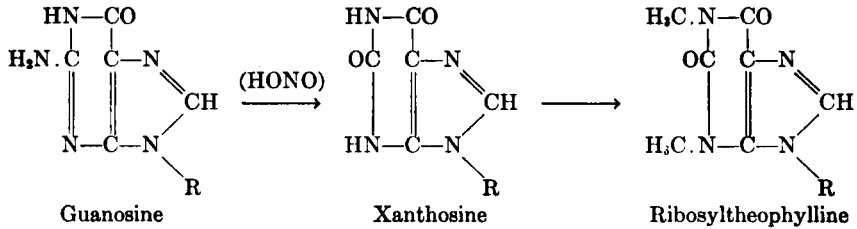

No chemical method of deciding between positions (7') and (9') presented itself, and there the matter stood until 1933, when Gulland and Holiday<sup>43,44</sup> turned to a physical method. They studied the ultraviolet absorption spectra of the purine nucleosides and then compared them with those of the various authentic monomethylated purines. Their results with xanthosine, for example, showed that it resembles 9-methylxanthine but is unlike 1-, 3-, or 7-methylxanthine (see Fig. 1). Hence,

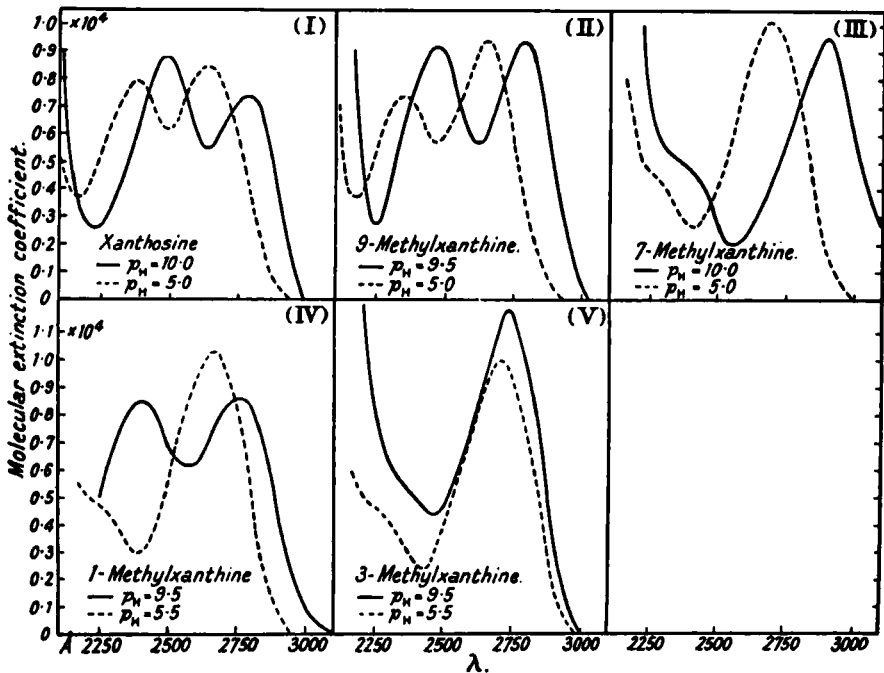

FIG. 1.—Ultraviolet absorption spectra of xanthosine and monomethylxanthines.

(Taken from J. M. Gulland, E. R. Holiday, and T. F. Macrae, *J. Chem. Soc.*, 1639 (1934).)

<sup>43</sup> J. M. Gulland and E. R. Holiday, *Nature*, 132, 782 (1933).

<sup>44</sup> J. M. Gulland, E. R. Holiday, and T. F. Macrae, *J. Chem. Soc.*, 1639 (1934).

knowing that the effect of the carbohydrate group on such spectra is negligible,<sup>45</sup> and assuming that when the spectrum of a methylpurine resembles that of a ribosylpurine, the methyl group and the ribosyl radical occupy the same position on the purine, Gulland decided that xanthosine is 9'-ribosylxanthine.

He examined adenosine,<sup>40</sup> inosine,<sup>40</sup> and guanosine<sup>46</sup> in the same manner, and found each to have spectra more nearly resembling those of the corresponding 9-methyl than of the 7-methyl derivative. Consequently, if we can accept these physical analogies as proof, the purine nucleosides are all 9'-ribosylpurines.

*The Ring-Structure of the Sugar Component.* The ribose-purine nucleosides are not, strictly speaking, purine ribosides but ribosyl-purines or "nitrogen glycosides." This is evident on comparing the glycosyl radical with that of a glycoside, in which union to the aglycon proceeds through an oxygen atom.

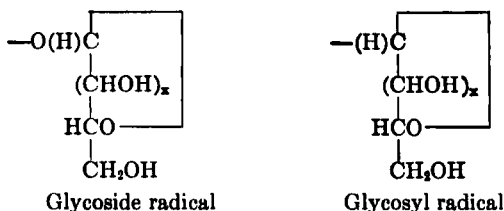

As in the case of glycosides, the sugar residue of a nucleoside is presumed to have either the furanose or the pyranose ring-structure.

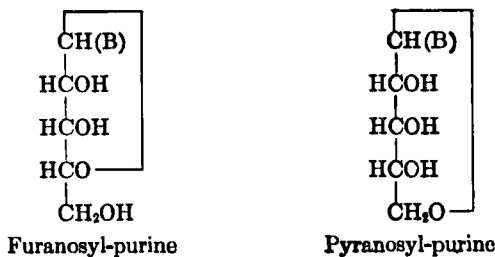

(a) *Methylation and Oxidation.* Now, in order to determine the ring-structure of a glycoside, the substance is completely methylated and then hydrolyzed; from the nature of the resulting methylated sugar, and of the substances to which it gives rise on stepwise oxidation, the

<sup>45</sup> F. Goos, H. H. Schlubach and G. A. Schroeter, *Z. physiol. Chem.*, **186**, 148 (1930).

<sup>46</sup> J. M. Gulland and L. F. Story, *J. Chem. Soc.*, 692 (1938).

ring-structure may be deduced. Consequently Levene and Tipson<sup>47</sup> first prepared authentic, crystalline trimethyl-D-ribofuranose as a reference substance and showed that, on oxidation with bromine water, it gave trimethyl- $\delta$ -D-ribonolactone which, on oxidation with nitric acid, yielded (meso) *ribo*-trimethoxyglutaric acid.

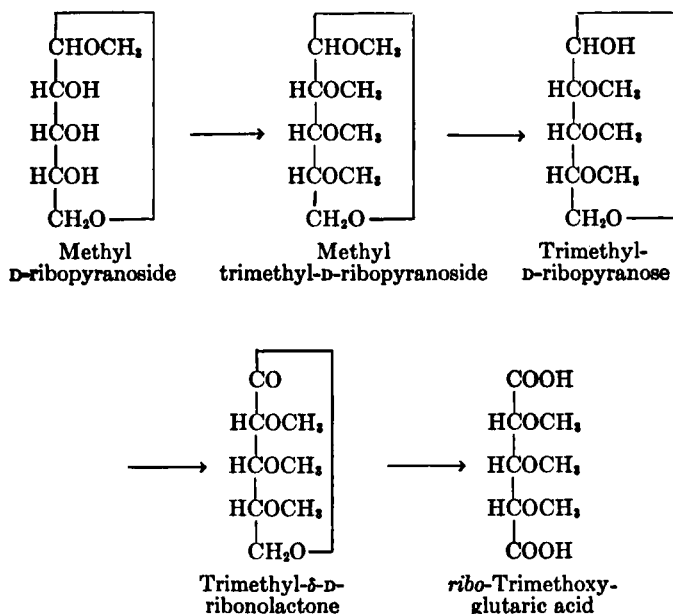

They then prepared the completely methylated derivatives of adenosine<sup>48, 49</sup> and guanosine<sup>50</sup> by simultaneous deacetylation and methylation of the acetylated nucleosides. In this way, trimethyl-*N*-methyl adenosine and trimethyl-*N*-methyl guanosine were formed, and isolated as the hydrochlorides. On hydrolysis of the adenosine derivative by means of dilute hydrochloric acid, 6-*N*-methyladenine and trimethyl-D-ribofuranose were isolated. The same trimethyl sugar was isolated from the methylated guanosine and was identified in each case by oxidation, first to trimethyl- $\gamma$ -D-ribonolactone and then to meso-dimethoxy succinic acid. It follows that the sugar component has the furanose ring-structure.

<sup>47</sup> P. A. Levene and R. S. Tipson, *J. Biol. Chem.*, **93**, 623 (1931).

<sup>48</sup> P. A. Levene and R. S. Tipson, *Science*, **74**, 521 (1931).

<sup>49</sup> P. A. Levene and R. S. Tipson, *J. Biol. Chem.*, **94**, 809 (1932).

<sup>50</sup> P. A. Levene and R. S. Tipson, *J. Biol. Chem.*, **97**, 491 (1932).



Trimethyl-D-ribofuranose, having the same properties, has since been synthesized by Levene and Stiller.<sup>51</sup>

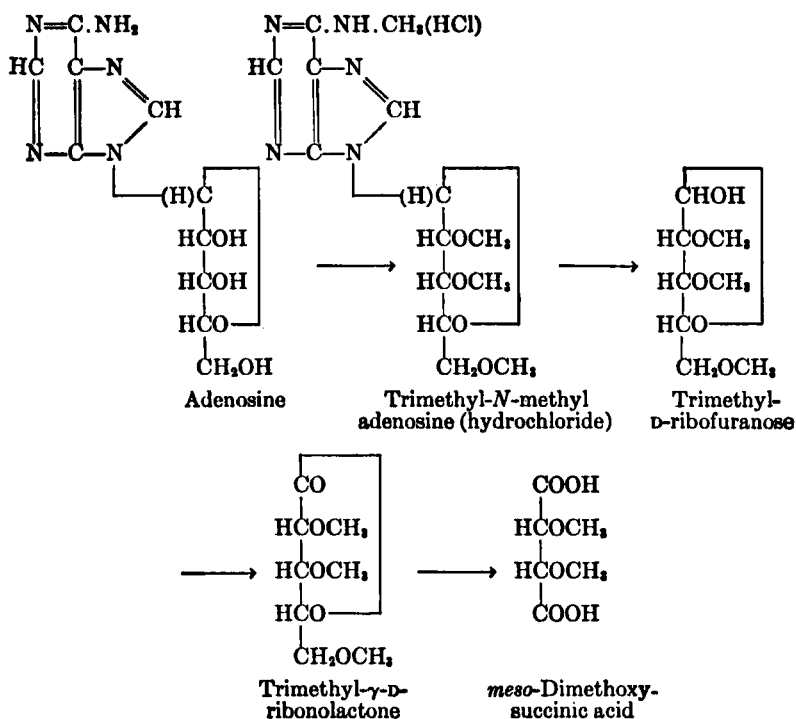

(b) *Interaction with Trityl Chloride.* It is well known that triphenylmethyl ("trityl") chloride will react *preferentially* with the primary alcoholic group of a sugar or sugar derivative.<sup>52</sup> It is not true, however, that secondary alcohol groups are immune to the action of this reagent,<sup>53</sup> particularly if an excess of the chloride be employed and the reaction allowed to proceed for a long time or at an elevated temperature. Hence, of itself, the isolated observation that a sugar or sugar derivative is able to react with trityl chloride to form a mono-trityl ether obviously cannot be regarded as evidence that the sugar or sugar derivative possesses a free primary hydroxyl group. This is even more true in the case of nucleosides where, as will be shown, the trityl group may attach itself to the nitrogenous base. If, however, the position of union of the trityl

<sup>51</sup> P. A. Levene and E. T. Stiller, *J. Biol. Chem.*, **102**, 187 (1933).

<sup>52</sup> B. Helferich, *Z. angew. Chem.*, **41**, 871 (1928).

<sup>53</sup> R. C. Hockett and C. S. Hudson, *J. Am. Chem. Soc.*, **53**, 4456 (1931).

group can be conclusively demonstrated, the method becomes of value in elucidating the structure of the sugar or sugar derivative.

In 1933, Bredereck<sup>54, 55</sup> discovered that adenosine reacts with trityl chloride to give a monotrityl-adenosine which, without direct experimental evidence, he assumed to be 5-trityl-adenosine. In support of this formulation he presented the observation<sup>56</sup> that no reaction between trityl chloride and a mixture of  $\alpha$ - and  $\beta$ -methyl ribopyranosides (having no primary hydroxyl group) could be detected polarimetrically.

On repeating the preparation of monotrityl adenosine, Levene and Tipson<sup>57</sup> discovered that a quantity of a *di*-trityl adenosine is invariably formed at the same time. They were able to separate the two products and showed their structures in the following manner.

Treatment of monotrityl-adenosine with *p*-toluenesulfonyl ("tosyl") chloride in dry pyridine gave a tritosyl-trityl-adenosine from which the trityl group could be hydrolyzed by means of boiling 80% acetic acid (a reagent which only slowly hydrolyzes the linkage between ribose and purine) to give a crystalline tritosyl-adenosine.

Now it has been established that when a tosyl group is attached to the primary alcoholic group in aldohexoses<sup>58</sup> and aldopentofuranoses<sup>59</sup> the *tosyloxy* group is readily substituted by iodine on treating the substance with sodium iodide dissolved in acetone, under standard conditions, whereas tosyloxy groups attached at other positions are unaffected.

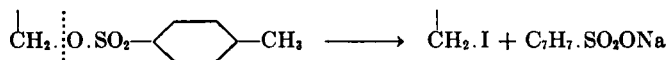

The tosyloxy groups of tritosyl adenosine were not replaced<sup>57</sup> by iodine on treatment with sodium iodide, showing the absence of a tosyl group at position (5). Hence monotrityl-adenosine is 5-trityl-adenosine, and adenosine must have a furanose structure.

The *di*trityl-adenosine was acetylated to give diacetyl-*di*trityl-adenosine which, on hydrolysis by means of boiling 80% acetic acid, yielded the *same* diacetyl-adenosine (having a *free amino group*) as was obtained by hydrolysis of *N*-acetyl-2,3-diacetyl-5-trityl-adenosine under the same conditions. It follows that the diacetate is 2,3-diacetyl-adenosine and that *di*trityl-adenosine is 9'-(5-trityl-ribofuranosyl)-6'-*N*-trityl-adenine.

<sup>54</sup> H. Bredereck, *Ber.*, **66**, 198 (1933).

<sup>55</sup> H. Bredereck, *Z. physiol. Chem.*, **223**, 61 (1934).

<sup>56</sup> H. Bredereck, *Ber.*, **65**, 1830 (1932).

<sup>57</sup> P. A. Levene and R. S. Tipson, *J. Biol. Chem.*, **121**, 131 (1937).

<sup>58</sup> J. W. H. Oldham and J. K. Rutherford, *J. Am. Chem. Soc.*, **54**, 366 (1932).

<sup>59</sup> P. A. Levene and A. L. Raymond, *J. Biol. Chem.*, **102**, 317 (1933).

These formulations were confirmed by treatment of the diacetyl-adenosine with *p*-toluenesulfonyl chloride, giving a ditosyl-diacetyl-adenosine, only one tosyloxy group of which was substituted by iodine on treatment with sodium iodide. Hence the ribose residue of adenosine has the furanose ring structure.

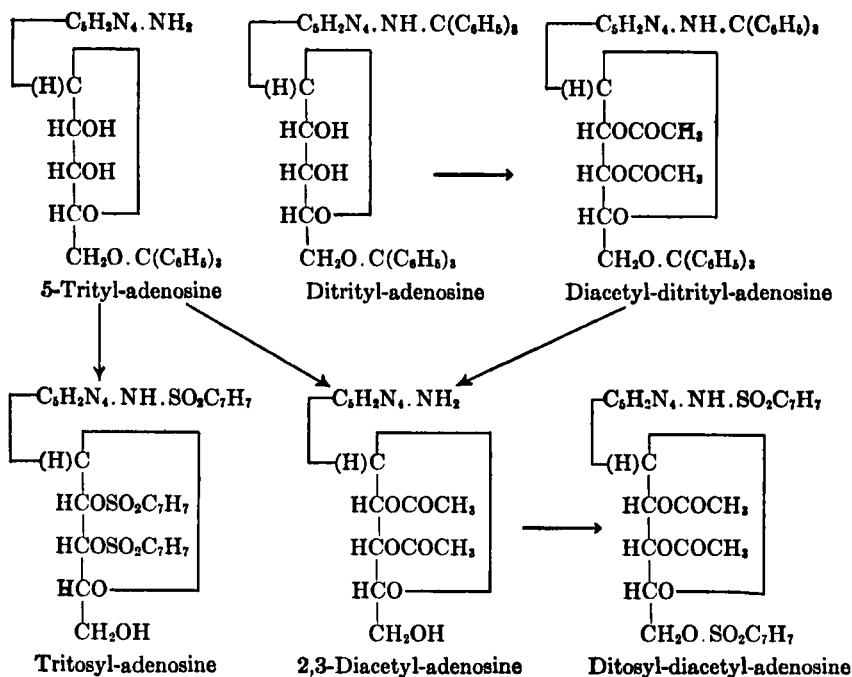

(c) *Interaction with Acetone.* As is well known, sugars and their derivatives which possess two adjacent *cis* hydroxyl groups can condense with acetone to give cyclic acetals, the isopropylidene derivatives.

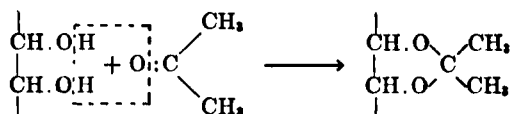

Levene and Tipson<sup>39</sup> discovered that inosine will condense with acetone in the presence of zinc chloride to give a mono-isopropylidene-inosine, the structure of which was demonstrated as follows. On treatment with *p*-toluenesulfonyl chloride in pyridine it gives a monotosyl-isopropylidene-inosine which reacts readily with sodium iodide in acetone to give mono-iodo-isopropylidene-inosine, showing that the tosyl group

is at position (5) of the sugar chain. Hence the isopropylidene derivative is 2,3-isopropylidene-inosine with a furanose ring-structure, and inosine is ribofuranosyl-hypoxanthine.

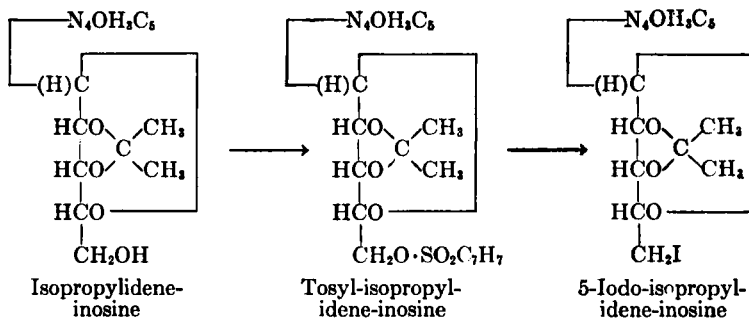

On phosphorylation of isopropylidene-inosine, followed by hydrolysis of the acetone residue, "muscle inosinic acid" (which, as will be seen later, is definitely known to be 5-phospho-inosine) is formed. This confirms the above formulations for isopropylidene-inosine and inosine.

Mono-isopropylidene derivatives of adenosine and guanosine have also been prepared by Levene and Tipson.<sup>57</sup> They are probably, likewise, the 2,3-isopropylidene derivatives, but their structures have not yet been proved.

## 2. Ribosylpyrimidines

The two pyrimidine nucleosides of ribosenucleic acid are cytidine and uridine. Since cytidine is readily transformed to uridine by deamination,<sup>58</sup> the two substances have the same sugar ring structure, point of union of sugar to base, and stereochemical configuration at carbon atom (1) of the sugar.

The task of solving the problem of their structure has been beset with great difficulties. Unlike the ribosylpurines, they cannot be hydrolyzed by dilute mineral acids, and when treated with more concentrated acid the nitrogenous base is readily isolated but the sugar is destroyed. However, although they give only a faint orcinol test for pentose, on prolonged distillation with hydrochloric acid there is formed a quantity of furfural consistent with the assumption of equimolecular proportions of base and pentose. Furthermore, by simultaneous hydrolysis and oxidation of cytidine with hydrobromic acid and bromine, bromo-uracil and D-ribonic acid were obtained,<sup>60</sup> indicating that the constituent sugar is D-ribose.

<sup>60</sup> P. A. Levene and F. B. LaForge, *Ber.*, **45**, 608 (1912).

Levene and LaForge also made the remarkable discovery that on *hydrogenation* the uniquely stable bond between base and sugar is weakened and the resulting dihydro derivative is susceptible to hydrolysis under conditions comparable with those employed for the hydrolysis of the ribosylpurines. Thus, hydrogenation of uridine (for example) gives dihydro-uridine which is readily hydrolyzed to dihydro-uracil and D-ribose.

Now, since there is a free primary group in cytosine (and cytidine) at position (6'), there can be no replaceable hydrogen atom at position (1'), so that positions (1') and (6') are excluded as points of union of the ribose to the base, both in cytidine and in uridine (despite the presence of a replaceable hydrogen atom at position (1') in uracil).

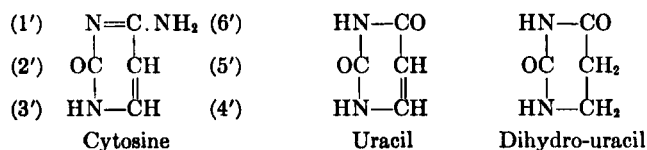

Direct experimental confirmation of the conclusion that position(1') is not the point of union was provided in 1934 by Levene and Tipson,<sup>61</sup> who succeeded in methylating the pyrimidine residue without methylating the ribose residue. The methylating agent employed was diazomethane in dry ether and the uridine derivative chosen for methylation was 2,3-diacetyl-5-trityl-uridine (since all its sugar hydroxyls are substituted and it is soluble in dry ether). On hydrolysis of the acetyl and trityl groups from the product a monomethyl-uridine was obtained. This proved to be *N*(1')-methyl-uridine since on hydrolysis 1-methyl-uracil, identical with the synthetic product,<sup>62</sup> was isolated.

This leaves positions (3'), (4'), and (5') as possible points for the union. However, position (5') is excluded because bromine reacts<sup>60</sup> with uridine to give 5'-bromo-uridine, and nitric acid gives a 5'-nitro derivative which, on hydrolysis, yields 5'-nitro-uracil. Position (4') is excluded because treatment of bromo-uridine with phenylhydrazine gives 4'-5'-diphenylhydrazino-uridine.<sup>63</sup> Hence in both uridine and cytidine the ribose residue is situated at position (3') of the base. This conclusion has been verified by indirect methods.<sup>64</sup>

<sup>61</sup> P. A. Levene and R. S. Tipson, *J. Biol. Chem.*, **104**, 385 (1934).

<sup>62</sup> T. B. Johnson and F. W. Heyl, *Am. Chem. J.*, **37**, 628 (1907).

<sup>63</sup> P. A. Levene, *J. Biol. Chem.*, **63**, 653 (1925).

<sup>64</sup> T. B. Johnson and S. H. Clapp, *J. Biol. Chem.*, **5**, 163 (1908); P. A. Levene and L. W. Bass, *ibid.*, **71**, 167 (1926).

The ring structure of the ribose residue was ascertained<sup>65</sup> in the same general manner as for adenosine and guanosine. Triacetyl-dihydro-uridine was prepared by the hydrogenation of triacetyl-uridine. On simultaneous deacetylation and methylation this was transformed to the fully methylated dihydro-uridine. By simultaneous hydrolysis and oxidation of this product, with hydrobromic acid and bromine, trimethyl- $\gamma$ -D-ribonolactone was formed, its identity being confirmed by oxidation to *meso*-dimethoxy-succinic acid. It follows that the ribose component has the furanose ring structure, and that uridine is 3'-D-ribofuranosyl-uracil.

This formulation has been confirmed by a study of trityl-uridine, a substance first isolated (in a highly impure state) by Bredereck<sup>66</sup> in 1932 and assumed by him, without direct experimental evidence, to be 5-trityl-uridine. Levene and Tipson<sup>61,66</sup> succeeded in separating the crude material into two crystalline substances, one a monotrityl- and the other a ditrityl-uridine. Furthermore they found that treatment of the monotrityl-uridine with trityl chloride gives the ditrityl derivative. The structure of the monotrityl-uridine was determined as follows. On

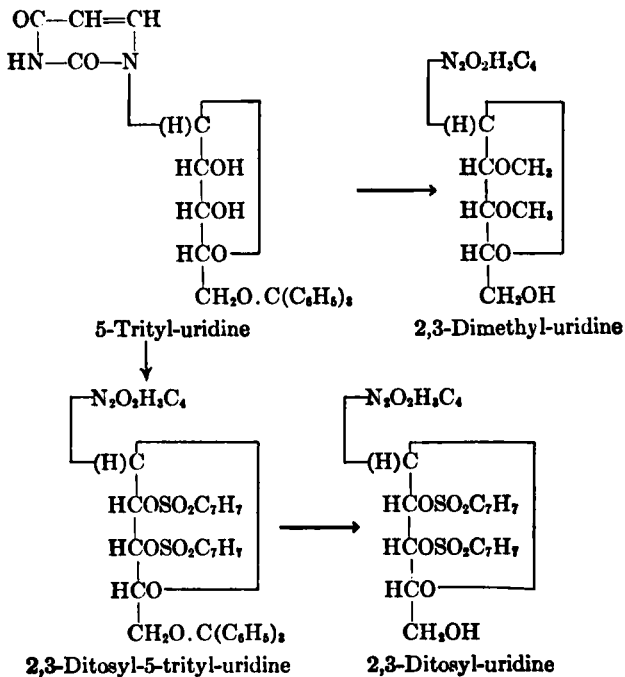

<sup>65</sup> P. A. Levene and R. S. Tipson, *J. Biol. Chem.*, **101**, 529 (1933).

<sup>66</sup> P. A. Levene and R. S. Tipson, *J. Biol. Chem.*, **105**, 419 (1934).

methylation by means of Purdie's reagents followed by hydrolysis, a dimethyl-uridine was obtained. This was treated with *p*-toluenesulfonyl chloride, yielding a tosyl-dimethyl-uridine which reacted readily with sodium iodide in acetone to give a crystalline monoiodo-dimethyl-uridine. On the other hand, tosylation of monotrityl-uridine gave a ditosyl-trityl-uridine which was readily hydrolyzed to a ditosyl-uridine which did not react with sodium iodide in acetone. It follows that the tosyl derivatives are 5-tosyl-2,3-dimethyl-uridine and 2,3-ditosyl-uridine respectively, and that monotrityl-uridine is 3'-(5-trityl-D-ribofuranosyl)-uracil. Hence the ribose residue of uridine (and cytidine) has the furanose ring structure.

Furthermore Levene and Tipson<sup>67</sup> discovered that uridine will condense with acetone in the presence of sulfuric acid and anhydrous copper sulfate to give a mono-isopropylidene-uridine. On treatment with tosyl chloride it gave a tosyl-isopropylidene-uridine which reacted readily with sodium iodide in acetone to give a crystalline monoiodo-isopropylidene-uridine, showing that the tosyl group is at position (5) of the sugar chain. Hence the isopropylidene derivative is 2,3-isopropylidene-uridine with a furanose ring structure, and uridine is D-ribofuranosyl-uracil.

## II. RIBOSE NUCLEOTIDES

*The position of attachment of the phosphoric acid to the ribose residue in the ribosenucleotides.* In order to understand the historical development of this aspect of the subject it is necessary first to discuss the chemistry of two ribose nucleotides which, although of great biochemical importance, are not components of ribosenucleic acid. They are both purine nucleotides and both occur free in Nature.

### 1. Ribosylpurine Nucleotides

(a) *Ribosylpurine Nucleotides of Muscle. Muscle Inosinic Acid (5-Phospho-inosine).* The first nucleotide to be discovered was named "inosinic acid" by Liebig<sup>68</sup> who, in 1847, isolated it from beef extract. It has also been obtained from the herring, and from the muscles of the fowl and the duck.

On neutral hydrolysis of the barium salt it gives<sup>69</sup> barium phosphate and inosine. On hydrolysis with 0.1 *N* hydrochloric acid (during 1 hour at 100°), it gives rise<sup>32, 34</sup> to hypoxanthine and a phospho-D-ribose. The structure of this phosphoribose was readily shown<sup>34</sup> by oxidation with

<sup>67</sup> P. A. Levene and R. S. Tipson, *J. Biol. Chem.*, **106**, 113 (1934).

<sup>68</sup> J. Liebig, *Ann.*, **62**, 257 (1847).

<sup>69</sup> P. A. Levene and W. A. Jacobs, *Ber.*, **42**, 335 (1909).

nitric acid, a phosphoribonic acid being obtained. Since, by oxidation with this reagent, a pyranose form of phosphoribose [whether substituted in position (2), (3), or (4)] would, if not hydrolyzed, give rise to a phosphoribotrihydroxyglutaric acid, it follows that position (5) of the sugar chain is protected by the phosphoryl group and that the phosphoribose is 5-phospho-D-ribofuranose. (Its barium salt was obtained in crystalline condition and so it may be regarded as the first furanose sugar ester ever obtained crystalline.)

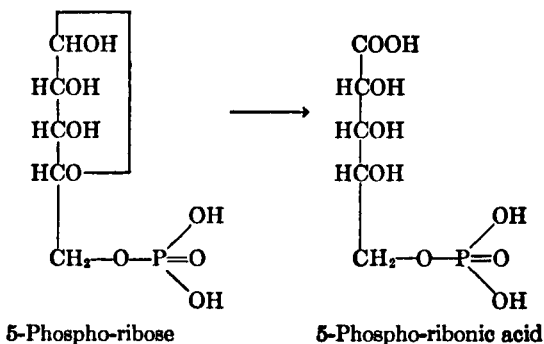

This conclusion was confirmed<sup>70</sup> by an investigation of the rate of lactone formation of the phosphoribonic acid. (Levene and Simms<sup>71</sup> had previously shown that if hydroxyls (4) and (5) are both free the formation of both the  $\gamma$ - and the  $\delta$ -lactone can be detected; if position (4) is substituted and (5) is free, the  $\delta$ -lactone is formed at a relatively rapid rate; if position (5) is substituted and (4) is free, the  $\gamma$ -lactone is slowly formed.) The transformation of the phosphoribonic acid to its lactone in aqueous solution was found to proceed smoothly and very slowly, a property of sugar acids so substituted that they can only give rise to  $\gamma$ -lactones. The formation of  $\delta$ -lactone was not observed, as was to be expected if position (5) of the sugar is substituted.

Further confirmation resulted from the discovery<sup>72</sup> that the phosphoribose condenses with methyl alcohol in the presence of dry hydrogen chloride to give a furanoside only. Also, on reduction of the phosphoribose, an optically active phosphoribitol is formed,<sup>72</sup> showing that the phosphoryl group is not at position (3).

This formulation for the phosphoribose was finally substantiated beyond doubt by the synthesis<sup>73</sup> of 5-phosphoribose. It had been dis-

<sup>70</sup> P. A. Levene and T. Mori, *J. Biol. Chem.*, **81**, 215 (1929).

<sup>71</sup> P. A. Levene and H. S. Simms, *J. Biol. Chem.*, **65**, 31 (1925).

<sup>72</sup> P. A. Levene, S. A. Harris, and E. T. Stiller, *J. Biol. Chem.*, **105**, 153 (1934).

<sup>73</sup> P. A. Levene and E. T. Stiller, *J. Biol. Chem.*, **104**, 299 (1934).



covered<sup>61</sup> that D-ribose condenses with a mixture of methyl alcohol and acetone (in the presence of sulfuric acid and anhydrous copper sulfate) to give methyl 2,3-isopropylidene-ribofuranoside, in which the only free hydroxyl group is at position (5). This was phosphorylated with phosphorus oxychloride in pyridine, and the isopropylidene and methyl groups were then hydrolyzed, yielding 5-phosphoribose which was identical with the phosphoribose from muscle inosinic acid.

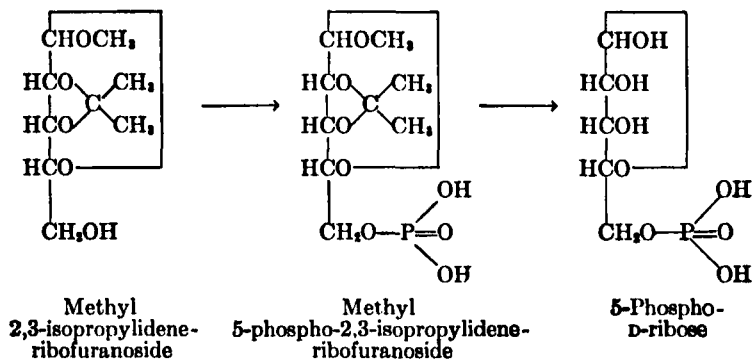

Finally, muscle inosinic acid itself was synthesized by Levene and Tipson.<sup>39</sup> This was the first (partial) synthesis of a naturally occurring nucleotide. Phosphorylation of 2,3-isopropylidene-inosine, the structure of which has already been discussed, gave the corresponding 5-phospho derivative, from which the isopropylidene group was cautiously hydrolyzed, yielding 5-phosphoinosine which proved to be identical with muscle inosinic acid.

Hence muscle inosinic acid is 9'-(5-phospho-D-ribofuranosyl)-hypoxanthine.

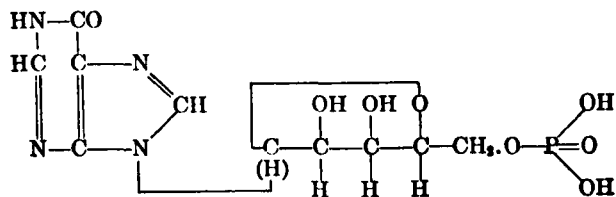

Muscle inosinic acid

*Muscle Adenylic Acid (5-Phospho-adenosine).* Embden<sup>74</sup> discovered in muscle extracts an adenylic acid which has since been isolated from heart muscle and from the brain. Since it was already known that an

<sup>74</sup> G. Embden and M. Zimmermann, *Z. physiol. Chem.*, **167**, 137 (1927).

inosinic acid occurs in muscle tissue, the possibility of a relationship between the two acids immediately suggested itself. Schmidt<sup>75</sup> established this relationship, isolating from muscle tissue an enzyme capable of transforming the adenylic to the inosinic acid. It was further shown<sup>76</sup> that the two acids had the same rate of phosphate-hydrolysis and that, on dephosphorylation<sup>40</sup> by means of bone phosphatase, muscle adenylic acid gives adenosine. Muscle adenylic acid is therefore 9'-(5-phospho-D-ribofuranosyl)-adenine.

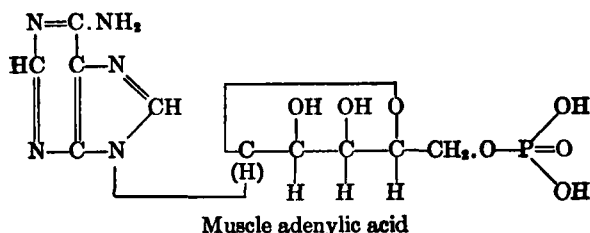

In confirmation of this structure, Klimek and Parnas<sup>77</sup> found that muscle adenylic acid forms a complex with boric acid. Such a complex has been shown by Boeseken<sup>78</sup> to be formed only by polyhydroxy compounds having two adjacent *cis* hydroxyl groups.

Jachimowicz<sup>79</sup> claimed to have synthesized 5-phosphoadenosine (in poor yield) by direct phosphorylation of adenosine with phosphorus oxychloride in pyridine, but Bredereck<sup>80</sup> showed that a mixture of phosphoric esters of adenosine actually results, as might have been anticipated. Levene and Tipson<sup>57</sup> succeeded in synthesizing 5-phospho-adenosine (in poor yield) by phosphorylation of 2,3-diacetyl-adenosine to give *N*-phospho-5-phospho-2,3-diacetyl-adenosine, followed by deacetylation by alkali, and removal by acid-hydrolysis of the labile phospho group attached to nitrogen. (This synthesis was confirmed by Bredereck, *et al.*<sup>80</sup>) In a similar manner they<sup>57</sup> phosphorylated 2,3-isopropylidene-adenosine to *N*,5-di-phospho-2,3-isopropylidene-adenosine from which the acid-labile *N*-phospho and isopropylidene groups were hydrolyzed, giving 5-phospho-adenosine.

5-Phospho-adenosine enters into the structure of cozymase, and plays a very important part in phosphate transfer in muscle and in alcoholic fermentation by yeast.

<sup>75</sup> G. Schmidt, *Z. physiol. Chem.*, **179**, 243 (1928).

<sup>76</sup> G. Embden and G. Schmidt, *Z. physiol. Chem.*, **181**, 130 (1929).

<sup>77</sup> R. Klimek and J. K. Parnas, *Biochem. Z.*, **252**, 392 (1932).

<sup>78</sup> J. Boeseken, *Ber.*, **46**, 2612 (1913).

<sup>79</sup> T. Jachimowicz, *Biochem. Z.*, **292**, 356 (1937).

<sup>80</sup> H. Bredereck, E. Berger and J. Ehrenberg, *Ber.*, **73**, 269 (1940).

(b) *Purine Nucleotides of Ribosenucleic Acid.* The two purine nucleotides from ribosenucleic acid are adenylic and guanylic acids. The preparation and properties of crystalline adenylic acid were described almost simultaneously by Jones and Kennedy,<sup>81</sup> Thannhauser,<sup>82</sup> and Levene<sup>18</sup> in 1919. In the same year, Levene<sup>83, 84</sup> succeeded in isolating and crystallizing the guanylic acid from ribosenucleic acid.

Now a guanylic acid occurring in animal tissues was already known. As early as 1894, Hammarsten<sup>81</sup> had obtained indications of the presence in pancreas of a nucleic acid different from "thymus nucleic acid"; Bang<sup>85</sup> isolated from the pancreas a substance which he named "guanylic acid" since, on hydrolysis, it gives rise to guanine, phosphoric acid, and a pentose (later identified as D-ribose). Steudel<sup>86</sup> showed that, on extracting the pancreas with boiling water, the aqueous extract contains guanylic acid and the residue contains "thymus nucleic acid." Guanylic acid has also been isolated from the liver and the spleen. Levene and Jorpes<sup>87</sup> showed that it has the same rate of phosphate-hydrolysis as has the guanylic acid from ribosenucleic acid, and they decided that the two guanylic acids are identical.

On neutral or slightly alkaline hydrolysis,<sup>24, 27, 88</sup> or by treatment with bone phosphatase,<sup>26</sup> guanylic acid is dephosphorylated to guanosine. Hence Levene perceived that guanylic acid is a phospho-guanosine, but many years elapsed before he was able to show the position of attachment of the phosphoryl group.

*Xanthylic and Guanylic Acids.* On deamination with nitrous acid, guanylic acid is readily transformed<sup>20, 89</sup> to xanthylic acid. Consequently, determination of the structure of the latter will serve to show that of guanylic acid also.

In 1931, Levene<sup>20, 21</sup> made the remarkable discovery that if an aqueous solution of xanthylic acid (which has pH 1.9) is allowed to stand at 50° the acid will hydrolyze itself, forming xanthine and a phosphoribose with properties quite different from those of the 5-phosphoribose discovered many years earlier by him.<sup>32, 34</sup>

<sup>81</sup> W. Jones and R. P. Kennedy, *J. Pharmacol.*, **13**, 45 (1919).

<sup>82</sup> S. J. Thannhauser, *Z. physiol. Chem.*, **107**, 157 (1919).

<sup>83</sup> P. A. Levene, *J. Biol. Chem.*, **40**, 171 (1919).

<sup>84</sup> P. A. Levene, *J. Biol. Chem.*, **41**, 483 (1920).

<sup>85</sup> I. Bang, *Z. physiol. Chem.*, **26**, 133 (1898).

<sup>86</sup> H. Steudel, *Z. physiol. Chem.*, **53**, 539 (1907).

<sup>87</sup> P. A. Levene and E. Jorpes, *J. Biol. Chem.*, **81**, 575 (1929); Y. Kobayashi, *J. Biochem. (Japan)*, **15**, 261 (1932).

<sup>88</sup> P. A. Levene and W. A. Jacobs, *Biochem. Z.*, **28**, 127 (1910).

<sup>89</sup> M. Knopf, *Z. physiol. Chem.*, **92**, 159 (1914).

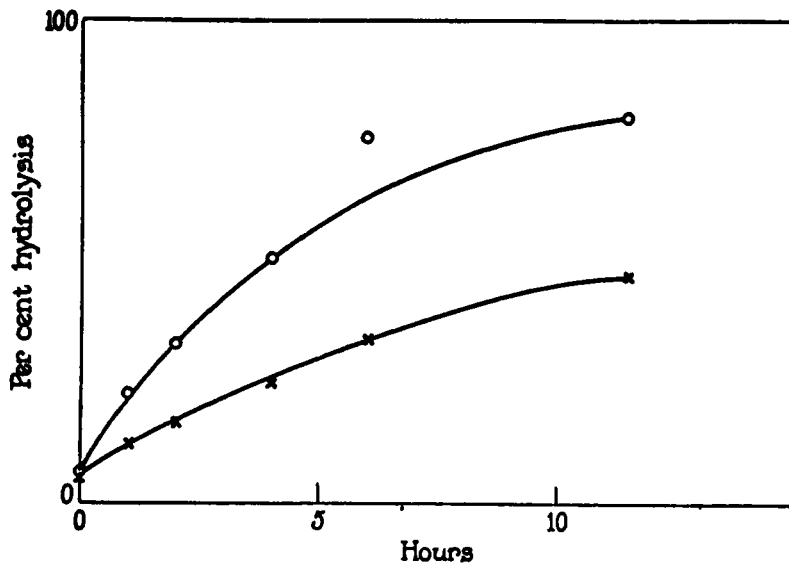

FIG. 2.—Rates of phosphate hydrolysis of the phosphoribonic acids.

○, phosphoribonic acid from xanthylic acid; x, 5-phosphoribonic acid.

(Taken from P. A. Levene and S. A. Harris, *J. Biol. Chem.*, 95, 763 (1932)).

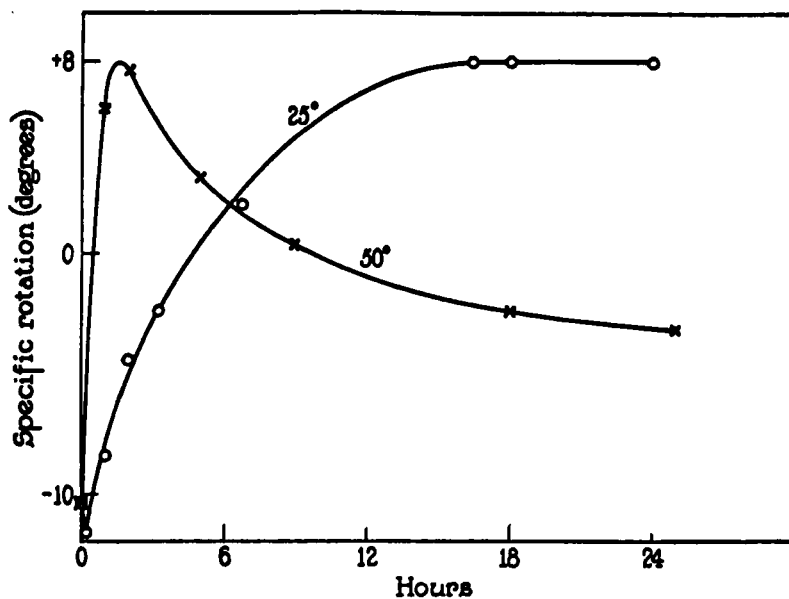
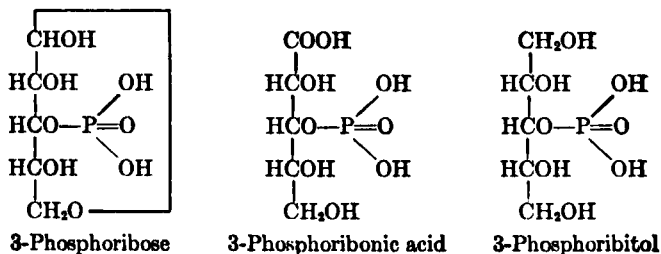

FIG. 3.—Glycoside formation of phosphoribose from xanthylic acid.

(Taken from P. A. Levene and S. A. Harris, *J. Biol. Chem.*, 95, 763 (1932)).

In the first place, cautious oxidation gives a phosphoribonic acid which lactonizes at a different rate, and from which the phosphoryl group is hydrolyzed twice as rapidly<sup>21</sup> as from 5-phosphoribonic acid (see Fig. 2). Secondly, on condensation with methanol in the presence of dry hydrogen chloride it gives rise to both the furanoside and pyranoside forms of glycoside (see Fig. 3). Hence the phosphoryl group cannot be attached at either position (4) or (5), but must be at (2) or (3).

Levene and Harris<sup>20</sup> now hit upon a most ingenious method of settling between positions (2) and (3). Upon reduction with hydrogen in the presence of Adams' catalyst, the phosphoribose gave an optically *inactive* phosphoribitol. Since 2-phosphoribitol would be optically active whereas 3-phosphoribitol would be inactive, it follows that the phosphoryl group is situated at position (3).



Hence the phosphosugar is 3-phospho-D-ribose; xanthylic acid is 9'-(3-phospho-D-ribofuranosyl)-xanthine; and guanylic acid is 9'-(3-phospho-D-ribofuranosyl)-guanine.

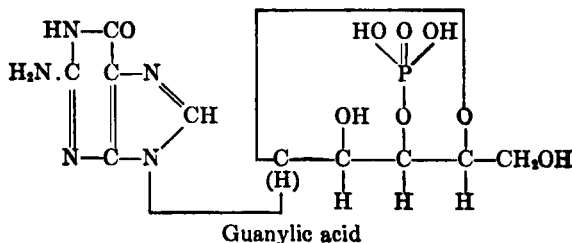

Guanylic acid has been synthesized<sup>21</sup> by direct phosphorylation of guanosine with phosphorus oxychloride in the presence of barium hydroxide solution, but this method of synthesis is valueless as regards confirming the above structure.

<sup>20</sup> P. A. Levene and S. A. Harris, *J. Biol. Chem.*, **98**, 9 (1932).

<sup>21</sup> J. M. Gulland and G. I. Hobday, *J. Chem. Soc.*, 746 (1940).

*Inosinic and Adenylic Acids.* Similarly, Levene and Harris<sup>92</sup> found that the adenylic acid from ribosenucleic acid can be deaminated to an inosinic acid which undergoes hydrolysis at its own pH to give hypoxanthine and 3-phosphoribose. On the other hand, Thannhauser<sup>93</sup> had shown that ammoniacal hydrolysis of the adenylic acid gives adenosine and phosphoric acid.

The inosinic acid is therefore 9'-(3-phospho-D-ribofuranosyl)-hypoxanthine and the adenylic acid is 9'-(3-phospho-D-ribofuranosyl)-adenine.

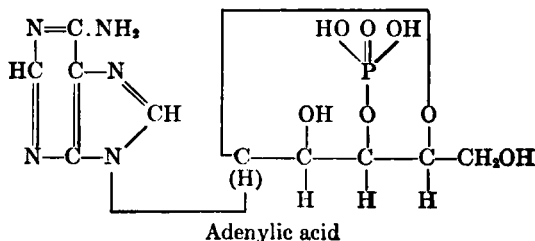

Synthetic 3-phospho-adenosine, identical with that from ribosenucleic acid, has been prepared<sup>92</sup> by direct phosphorylation of adenosine with phosphorus oxychloride in the presence of barium hydroxide, but this method of synthesis affords no confirmation of the above formulation.

## 2. Ribosylpyrimidine Nucleotides

Levene discovered<sup>15, 93</sup> that, on hydrolyzing ribosenucleic acid with boiling 2% sulfuric acid under reflux during two hours, the purine nucleotides are decomposed but the two pyrimidine nucleotides, namely uridylic and cytidylic acids, are resistant to this treatment. He succeeded<sup>94</sup> in separating the mixture of pyrimidine nucleotides, through the barium salts, into crystalline barium uridyate and amorphous barium cytidylate, in the same year that Thannhauser<sup>95</sup> crystallized brucine uridyate. Finally, in 1920, Levene reported<sup>94, 96</sup> the crystallization of the free pyrimidine nucleotides. On neutral hydrolysis<sup>98</sup> they yield uridine and cytidine, respectively.

Like their parent nucleosides, uridylic and cytidylic acids give only a faint orcinol test owing to the stability of the union between sugar and pyrimidine. In addition, the phosphoryl group adheres to the pentose

<sup>92</sup> G. R. Barker and J. M. Gulland, *J. Chem. Soc.*, 231 (1942).

<sup>93</sup> P. A. Levene and W. A. Jacobs, *Ber.*, **44**, 1027 (1911).

<sup>94</sup> P. A. Levene, *Proc. Soc. Exptl. Biol. Med.*, **15**, 21 (1917).

<sup>95</sup> S. J. Thannhauser and G. Dorfmueller, *Z. physiol. Chem.*, **100**, 121 (1917).

<sup>96</sup> P. A. Levene, *J. Biol. Chem.*, **41**, 1, 19 (1920).

much more tenaciously than in the 3-phosphoribosylpurines. Indeed, the rate of phosphate-hydrolysis is comparable to that of 5-phosphoinosine, and so, for many years, uridylic and cytidylic acids were considered to be 5-phospho derivatives.

On hydrogenation to dihydrouridylic and dihydrocytidylic acids, however, the characteristic stability is lost; both phosphoric acid and base are readily hydrolyzed<sup>87</sup> from the dihydro derivatives. The rate of hydrolysis of the phosphoryl group is, indeed, now comparable with that of the 3-phosphoribosylpurines. Consequently it seemed probable that the phosphoryl group is *not* attached at position (5) of the ribose component. This conclusion was confirmed in 1934 by Levene and Tipson<sup>87</sup> through the synthesis of 5-phosphouridine, a substance which was found to possess properties quite different from those of uridylic acid.

In order to prepare this compound, with the phosphoryl group definitely situated at position (5) of the ribose chain, it was first necessary to obtain a uridine derivative in which the hydroxyl group at position (5) is free and the other two are substituted by groups capable of subsequent hydrolysis, after phosphorylation, without splitting off the phosphoryl group. Such a substance was found in 2,3-isopropylidene-uridine, the structure of which has been previously discussed.

This was phosphorylated with phosphorus oxychloride in pyridine, and the resulting 5-phospho-isopropylidene-uridine hydrolyzed to give 5-phospho-uridine, a substance whose phosphoryl group is hydrolyzed off at a lower rate than that of any other known ribose nucleotide. Hence uridylic acid is not 5-phospho-uridine.

By analogy with the purine nucleotides of ribonucleic acid it seems probable that the phosphoryl group is situated at position (3) of the ribose chain, but no direct experimental evidence has yet appeared. Uridylic acid has been synthesized<sup>91</sup> by the action of phosphorus oxychloride on uridine in the presence of barium hydroxide solution and by phosphorylation of 5-trityl-uridine<sup>97</sup> but, unfortunately, these syntheses shed no light on the question. Furthermore, the fact that uridylic acid condenses<sup>97</sup> with trityl chloride to give a trityl-uridylic acid does not prove its structure, though it suggests that position (5) of uridylic acid is free. This tentative conclusion is strengthened by the observation<sup>97</sup> that neither of the pyrimidine nucleotides forms a complex with boric acid.

Phosphorylation of trityl-cytidine, followed by detritylation, allegedly gives<sup>80</sup> cytidylic acid, but this synthesis merely indicates that cytidylic

<sup>87</sup> H. Bredereck, *Z. physiol. Chem.*, **224**, 79 (1934); H. Bredereck and E. Berger, *Ber.*, **73**, 1124 (1940).

acid is *not* 5-phosphocytidine; it fails to reveal whether it is the 2-phospho or the 3-phospho ester.

In fine, it can only be stated that uridylic acid is 3'-(3-(or 2-)phospho-D-ribofuranosyl)-uracil, and cytidylic acid is 3'-(3-(or 2-)phospho-D-ribofuranosyl)-cytosine.

It would seem a simple matter to isolate the phosphoribose of these nucleotides, by mild acid hydrolysis of the dihydro derivatives, and to compare its properties with those of 3-phosphoribose.

### III. RIBOSENUCLEIC ACID

#### 1. Chemical Studies

Since mild alkaline hydrolysis of ribosenucleic acid gives *directly* an *equimolecular* mixture of the *four* mononucleotides, formulas proposed for ribosenucleic acid before this fact was definitely established will be ignored unless they show the union of *four* mononucleotides.

Combination between any two individual mononucleotides, having the general formula

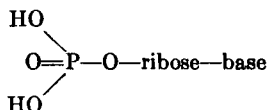

might be visualized as taking place in at least four different ways: (a) through a pyrophosphate link, one phosphoryl group being combined

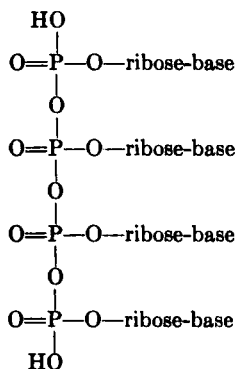

Pyrophosphate  
I

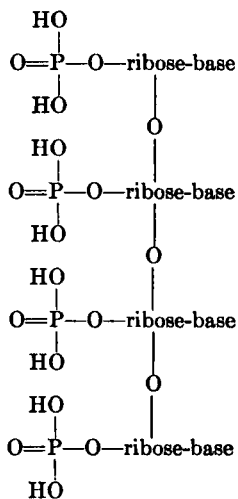

Ether  
II

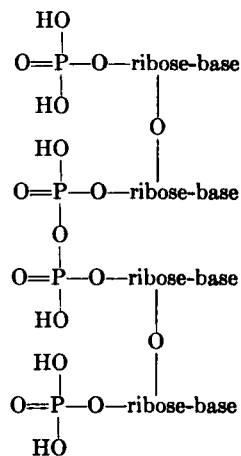

Pyrophosphate and ether  
III



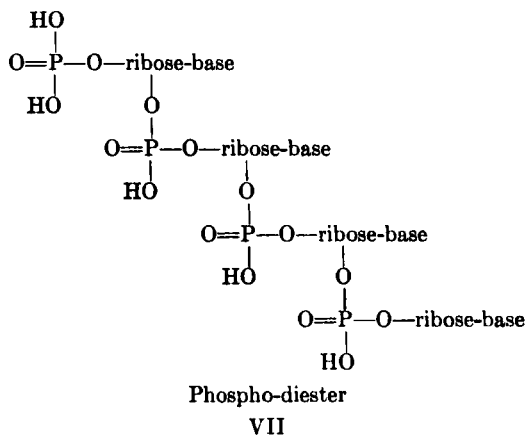
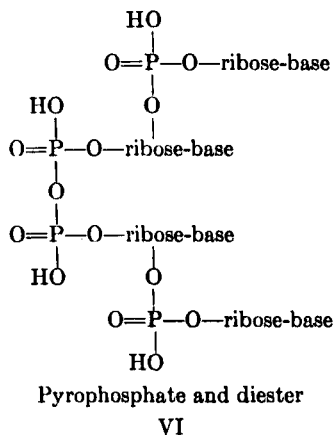
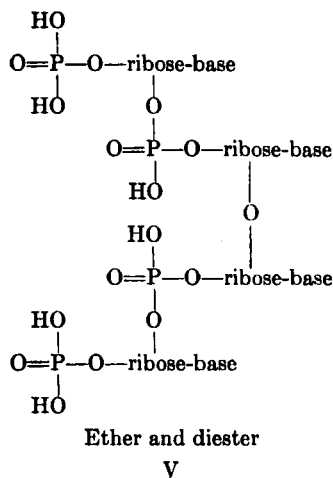
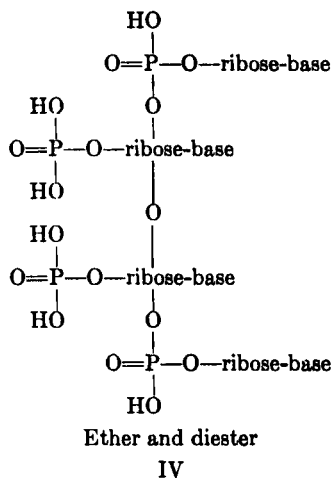

with that of the other nucleotide; (b) through an ether link, from a hydroxyl group of one ribose residue to one of the other ribose residue; (c) through an ester linkage, the phosphoryl group of one nucleotide uniting with a hydroxyl group of the ribose residue of the other nucleotide, or with a lactim hydroxyl of one of the nitrogenous bases; or (d) through a phosphoamide link, the phosphoryl group of one nucleotide uniting with the amino group of the other (adenylic, guanylic, or cytidylic acid). At one time or another, every one of these modes of union (together with various combinations of them) has been advocated.

However, it has proved possible to exclude certain of these formulations on the basis of the number of phosphoric acid dissociations they would possess and the types of hydrolysis products they would yield. By

electrometric titration, Levene and Simms<sup>98</sup> found that ribosenucleic acid exhibits one secondary and four primary phosphoric dissociations, a conclusion confirmed by Stearn.<sup>99</sup> (One sample of acid studied actually displayed about 4.5 acid dissociations for each four phosphorus atoms; more recent work suggests that this was a partially depolymerized sample.)

Formula I depicts Levene's suggestion<sup>15</sup> of 1909, the first formulation which recognized that ribosenucleic acid is composed of four mononucleotides. It was based on his discovery that the two purine and two pyrimidine bases are present in equimolecular proportions. However a nucleic acid of this structure would possess but two phosphoric dissociations. Formula IV, based on a second early formula of Levene's<sup>100</sup> (for desoxyribosenucleic acid), together with those of Jones<sup>101,102</sup> (II and V), based on an early (erroneous) belief that a dinucleotide is formed on hydrolysis of ribosenucleic acid, not only have the wrong numbers of phosphoric dissociations but possess ether linkages. Now an ether linkage is hydrolyzed with difficulty, whereas the base and the phosphoric acid are rather readily hydrolyzed from the purine nucleotides. Consequently, for example, hydrolysis of a substance having formula II might be expected to give rise to a molecule composed of four ribose residues, two pyrimidine bases, and two phosphoryl groups. Such a substance has not been isolated. Furthermore, since alkaline hydrolysis of ribosenucleic acid (to the four mononucleotides) results in the neutralization of some of the alkali, it is obvious that some or all of the phosphoryl groups are involved in the interunion of the mononucleotides. A nucleic acid of formula VI, based on a structure proposed by Feulgen<sup>103</sup> for desoxyribosenucleic acid, should be readily hydrolyzed by cold alkali to two dinucleotides. Hence formulas I through VI have been discarded.

As a result of Levene's painstaking researches<sup>18,19</sup> it was definitely established, after years of controversy, that mild hydrolysis of ribosenucleic acid gives directly the four mononucleotides. The tetranucleotide structure has since been substantiated<sup>104</sup> by comparison of the heats of combustion of the separate components of nucleic acid with that of nucleic acid itself. Levene therefore suggested<sup>105,98</sup> that the fundamental molecule of ribosenucleic acid is a tetranucleotide, in which there are

<sup>98</sup> P. A. Levene and H. S. Simms, *J. Biol. Chem.*, **70**, 327 (1926).

<sup>99</sup> A. E. Stearn, *J. Biol. Chem.*, **91**, 325 (1931).

<sup>100</sup> P. A. Levene and W. A. Jacobs, *J. Biol. Chem.*, **12**, 411 (1912).

<sup>101</sup> W. Jones and B. E. Read, *J. Biol. Chem.*, **29**, 111, 123 (1917); **31**, 39 (1917).

<sup>102</sup> W. Jones and M. E. Perkins, *J. Biol. Chem.*, **55**, 557 (1923).

<sup>103</sup> R. Feulgen, *Z. physiol. Chem.*, **101**, 288 (1918).

<sup>104</sup> J. Ellinghaus, *Z. physiol. Chem.*, **164**, 308 (1927).

<sup>105</sup> P. A. Levene, *J. Biol. Chem.*, **48**, 119 (1921).

three di-ester phosphoric linkages between the individual mononucleotide residues as shown in formula VII. A tetranucleotide of formula VII should display one secondary<sup>4</sup> and four primary phosphoric dissociations; this is not in complete agreement with experimental observations<sup>98, 99</sup> on partially polymerized material, as will be seen later.

Further progress was naturally delayed until the ribose ring structure and the position of attachment of the phosphoryl group in the individual mononucleotides had been ascertained. As previously indicated, it is now known that position (4) is occupied by the oxygen ring, and that the phosphoryl group is at position (3) in the purine nucleotides and at either position (2) or (3) in the pyrimidine nucleotides. When this had been established, Levene and Tipson<sup>106</sup> suggested that each of the three linking phosphoryl groups is shared by position (2) of one ribose residue and position (3) of the adjacent ribose residue as in the following formula.

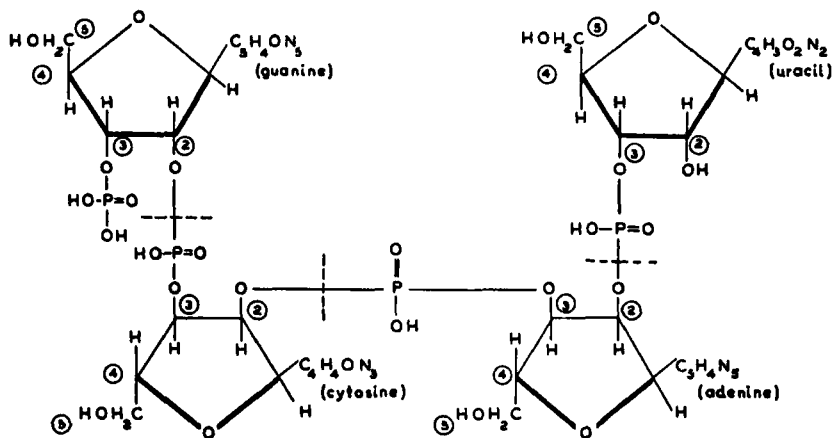

Tetranucleotide Unit of Ribonucleic Acid ( $C_{28}H_{46}O_{23}N_{15}P_4$ )

(Taken from P. A. Levene and R. S. Tipson, *J. Biol. Chem.*, 109, 623 (1935).)

They pointed out that the phosphoryl group in 5-phosphoribose is more resistant to acid hydrolysis than that in 3-phosphoribose, so that if any mononucleotide units in the nucleic acid were joined through position (5) of a ribose residue, these units would surely survive acid hydrolysis in preference to a union at position (3). However, since no 5-phosphoryl derivatives are isolated it may be assumed that the hydroxyl groups at position (5) are *not* substituted. (It would seem that this is susceptible to experimental verification, for example, by appro-

<sup>106</sup> P. A. Levene and R. S. Tipson, *J. Biol. Chem.*, 109, 623 (1935).

priate alkylation or acylation of ribosenucleic acid with subsequent hydrolysis to mono-alkyl or mono-acyl ribose derivatives.) They also pointed out that, since substituents at position (2) are characterized by greater instability than substituents in other positions, it is the 2-phosphoryl group which undergoes hydrolysis by alkali, thus accounting for the isolation of mononucleotides having the phosphoryl group situated at position (3).

Up to this time, little attention had been paid to the possibility of phosphoamide links because, in 1910, Levene and Jacobs<sup>28</sup> had shown that the (three) primary amino groups (of the purines and the cytosine) are presumably not substituted in the nucleic acid since they can be determined<sup>28, 107</sup> by van Slyke's method.<sup>108</sup> However, in 1936, Bredereck<sup>109</sup> hydrolyzed ribosenucleic acid (Boehringer) by boiling an aqueous solution of the substance, and isolated a very small amount of material which was described as amorphous, monobasic, and readily hydrolyzed to guanine and uridylic acid. He therefore decided it was a "guanine-uridylic acid" and assigned it the following structure.

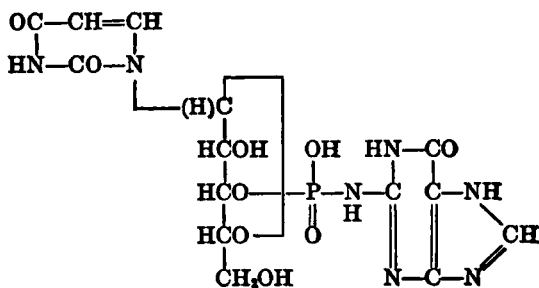

At first he maintained that this supports the idea that a phosphorus-nitrogen linkage exists in ribosenucleic acid, between the amino group of guanylic acid and the phosphoryl group of uridylic acid. However, he soon found<sup>110</sup> that, on deamination with nitrous acid,<sup>28</sup> ribosenucleic acid retains its polynucleotide structure (with no cleavage to mononucleotides) and he consequently withdrew the suggestion that guanine-uridylic acid is a structural unit of the nucleic acid. Instead, he decided that it is an artifact, formed during the hydrolysis. (Since it was now

<sup>107</sup> R. Falconer, J. M. Gulland, G. I. Hobday and E. M. Jackson, *J. Chem. Soc.*, 907 (1939).

<sup>108</sup> D. D. van Slyke, *Ber.*, 43, 3170 (1910).

<sup>109</sup> H. Bredereck and G. Richter, *Ber.*, 69, 1129 (1936).

<sup>110</sup> H. Bredereck, M. Koethnig, G. Lehmann, *Ber.*, 71, 2613 (1938); H. Bredereck, E. Berger, F. Richter, *ibid.*, 74, 338 (1941).

found that the guanine-uridylic acid undergoes deamination by nitrous acid it was decided<sup>111</sup> that the union between uridylic acid and guanine is an ester linkage between the phosphoryl radical and the hydroxyl group of the lactim form of guanine.)

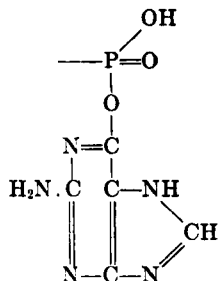

By following Bredereck's directions, Tipson and Levene<sup>112</sup> were able to isolate, from ribosenucleic acid (Boehringer), material having about the same elementary composition as Bredereck's guanine-uridylic acid. However, it gave a strong orcinol test, and on hydrolysis was strongly reducing to Fehling's solution. Furthermore it readily underwent deamination by nitrous acid, about 20% of its total nitrogen being amino nitrogen. It was found to be a complex mixture which contained, besides other substances, guanosine and purine nucleotides.

Gulland, *et al.*<sup>107, 113</sup> made exhaustive attempts to isolate guanine-uridylic acid from British ribosenucleic acid but "neither guanine-uridylic acid nor any pyrimidine nucleotide was found. These results . . . agree closely with the observations of Tipson and Levene." Instead of guanine-uridylic acid they usually isolated guanosine and guanylic acid in the ratio 30:70, a mixture having approximately the analytical composition required by guanine-uridylic acid. However, when the same technique was applied to German ribosenucleic acid (Boehringer) they were able to isolate a small amount of guanine-uridylic acid. The only possible explanation seems to be that one (or both) of the nucleic acids becomes "altered" during isolation, and that the German acid varies from batch to batch. In confirmation of this conclusion, Bredereck, Berger and Richter<sup>110</sup> could only isolate guanine-uridylic acid from *Boehringer's* ribosenucleic acid, and *some* specimens supplied by this

<sup>111</sup> H. Bredereck, "Nucleinsäuren," *Fortschr. Chem. org. Naturstoffe*, 1938, I, p. 121. Springer, Vienna.

<sup>112</sup> R. S. Tipson and P. A. Levene, *J. Biol. Chem.*, 127, 105 (1939); R. S. Tipson and P. A. Levene, *Chemistry & Industry*, 58, 1010 (1939).

<sup>113</sup> J. M. Gulland, *Chemistry & Industry*, 59, 321 (1940).

firm failed to yield it (possibly because of variations in the type of yeast employed).

This lack of agreement between different schools is characteristic of investigations concerning nucleic acid itself. Many studies seem to be performed on materials of questionable homogeneity and unknown heritage, the sole criteria of purity apparently being the percentages of nitrogen and phosphorus which they contain. Until some acceptable standard of identity is agreed upon, it would seem that such conflicting results will continue to swell the literature.

Gulland confirmed<sup>107</sup> that guanine-uridylic acid is deaminated by nitrous acid, but thinks this takes place through rupture of a phosphoamide link. In support of this hypothesis he finds that phenyl-phos-

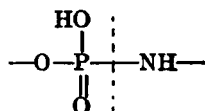

phoryl-guanine is deaminated by nitrous acid. However he does not appear to have proved that in this compound the phenylphosphoryl group is attached to the amino rather than to the lactim hydroxyl group of guanine, nor did he isolate and identify the deamination product. If nitrous acid really does cause fission of the phosphoamide link it should be possible to show the presence or absence of such a link in ribosenucleic acid by electrometric titration of ribosenucleic acid before and after deamination. Brederick<sup>110</sup> claims that there is no change in acidity; the ratio of phosphorus to nitrogen in the deaminated acid agreed with that for an acid containing no combined amino groups (of adenosine, guanosine, or cytidine).

On the other hand, guanine-uridylic acid is hydrolyzed by keeping it for 24 hours at pH 8.6 to 12, with liberation of one additional acid group, whereas phosphoamides are stable under similar conditions. Furthermore, cold sodium hydroxide solution (1%) splits phenylphosphoryl-guanine into phenol and a phosphorylguanidine. These findings by Gulland obviously support the lactim-phosphoester structure for guanine-uridylic acid.

It should be a simple matter to decide between the two proposed structures by deaminating a larger sample of guanine-uridylic acid and determining whether the product is xanthine or xanthine-uridylic acid.

It would seem that, to date, no sufficient evidence has been furnished in support of the view that any of the mononucleotides are united through phosphorus-nitrogen linkages. Since uracil has no amino group, uridylic

acid obviously cannot be bound in this manner, and some other type of linkage must be sought for this nucleotide. No mention of simultaneous formation of an adenine-cytidylic acid has been made by any investigator, yet such a phosphoamide compound might be expected to be liberated concomitantly with a guanine-uridylic acid if the latter is a phosphoamide.

## 2. Enzymic and Physico-chemical Studies\*

Following the discovery of methods for the preparation of nucleic acids, Iwanoff<sup>114</sup> studied the action of various molds on desoxyribose-nucleic acid, and the results led to his postulating the existence of a specific nucleoclastic enzyme, or enzymes, which he termed "nuclease."

During the next decade the ribosenucleosides and some of the nucleotides were discovered and characterized, enabling Levene<sup>115</sup> to distinguish between three different types of nucleoclastic enzyme: (a) *nucleinase*, which causes fission of the polynucleotides to mononucleotides; (b) *nucleotidase* (or nucleophosphatase), which dephosphorylates the mononucleotides<sup>25, 26</sup>; and (c) *nucleosidase*, which causes hydrolysis of nucleosides to sugar and base but is devoid of action on the nucleic acids. Nucleosidases are of two kinds, purinenucleosidases<sup>116</sup> and pyrimidine-nucleosidases.<sup>117</sup>

Levene and Dillon<sup>118</sup> discovered that the gastro-intestinal secretions of the dog contain a polynucleotidase and a non-specific nucleotidase. Whereas uridylic acid is the most stable of the natural ribosenucleotides as regards hydrolysis with mineral acids, it is more readily dephosphorylated by nucleotidase<sup>118</sup> than is any other nucleotide.

In 1912, Jones<sup>102, 119</sup> isolated, from pig's pancreas, a supposed nucleinase which was stable to heat. On treating a solution of ribosenucleic acid with this enzyme, the acid underwent a change which was presumed to be fission to the individual *mononucleotides* but no change in the acidity of the solution was detected. Jones interpreted this as indicating that

\* We are indebted to Dr. Gerhard Schmidt for his kindness in reading and criticizing this section.

<sup>114</sup> L. Iwanoff, *Z. physiol. Chem.*, **39**, 31 (1903).

<sup>115</sup> P. A. Levene and F. Medigreceanu, *J. Biol. Chem.*, **9**, 65, 375, 389 (1911); P. A. Levene, W. A. Jacobs and F. Medigreceanu, *ibid.*, **11**, 371 (1912); P. A. Levene and F. B. La Forge, *ibid.*, **13**, 507 (1913).

<sup>116</sup> P. A. Levene and I. Weber, *J. Biol. Chem.*, **60**, 717 (1924); P. A. Levene, M. Yamagawa, I. Weber, *ibid.*, **60**, 693 (1924).

<sup>117</sup> W. Deutsch and R. Laser, *Z. physiol. Chem.*, **186**, 1 (1930).

<sup>118</sup> P. A. Levene and R. T. Dillon, *J. Biol. Chem.*, **88**, 753 (1930); **96**, 461 (1932).

<sup>119</sup> W. Jones, *J. Biol. Chem.*, **12**, 31 (1912); *Am. J. Physiol.*, **52**, 203 (1920); *J. Biol. Chem.*, **50**, 323 (1922).

the number of phosphoric dissociations is not increased on fission to the mononucleotides, and he therefore proposed formula II (p. 219) for ribosenucleic acid.

Levene<sup>120</sup> mentioned in 1931 that he had been unable to hydrolyze the polynucleotide to the mononucleotides with this enzyme, and in 1937 Dubos<sup>121</sup> continued the study of the enzyme. Schmidt and Levene<sup>122</sup> came to the conclusion that the phenomenon is one of *depolymerization* of polytetranucleotides to the tetranucleotide state. They were unable to detect any reaction-product of small enough molecular size to diffuse through cellophane membranes, and found the freezing point of the solution remained unchanged during action of the enzyme. However, a mixture of the four mononucleotides dialyzed rapidly through cellophane and caused a considerable depression of the freezing point.

On the other hand Kunitz,<sup>123</sup> who succeeded in crystallizing the enzyme, found that about half of the ribosenucleic acid is broken into fragments small enough to diffuse readily through suitably-chosen cellophane or collodion membranes, and that free acid groups (but no inorganic phosphoric acid) are liberated by the digestion. He did not state whether the product consists of tetranucleotides or mononucleotides. Loring and coworkers<sup>123a</sup> confirmed that "a relatively large proportion" of the yeast ribonucleic acid is resistant to the action of ribonuclease, showing that the "acid must contain at least two different types of linkages, one of which is labile and one of which is resistant" to the action of ribonuclease.

There would appear to be at least two possible explanations for the discrepancy between the results of Schmidt and Levene and those of Kunitz regarding the dialyzability of the end-products. The first is that Schmidt used as enzyme a *boiled* solution of commercial pancreatin, whereas Kunitz employed crystalline ribonuclease which had not been exposed to heat. The second possibility has been pointed out by Loring and Carpenter.<sup>123b</sup> They consider that dialysis in the presence of the enzyme preparation, which probably contained an appreciable amount of inert protein, is not comparable with dialysis of a mixture of the four mononucleotides in the absence of the enzyme preparation. Simple control experiments would surely serve to establish the truth or falsity of these speculations.

<sup>120</sup> P. A. Levene, ref. 14, p. 312.

<sup>121</sup> R. J. Dubos, *Science*, **85**, 549 (1937); R. J. Dubos and R. H. S. Thompson, *J. Biol. Chem.*, **124**, 501 (1938).

<sup>122</sup> G. Schmidt and P. A. Levene, *J. Biol. Chem.*, **126**, 423 (1938).

<sup>123</sup> M. Kunitz, *Science*, **90**, 112 (1939); *J. Gen. Physiol.*, **24**, 15 (1940).

<sup>123a</sup> F. H. Carpenter, P. M. Roll, and H. S. Loring, *Ann. Rev. Biochem.*, **13**, 300 (1944).

<sup>123b</sup> H. S. Loring and F. H. Carpenter, *J. Biol. Chem.*, **150**, 381 (1943).





formulas (II and V), and Levene's formula VII (having one monoester grouping) are untenable. However, Klein and Rossi<sup>126</sup> decided that Takahashi's formula has no experimental justification. Even if Takahashi's results are correct they could be explained by assuming that the nucleic acid is a polymer consisting of many tetranucleotide units appropriately united. Formula VIII, as such, cannot represent ribosenucleic acid since its molecular weight is somewhat less than that of a simple tetranucleotide (owing to the elimination of one mole of water in the cyclization); actually, the molecular weight of ribosenucleic acid is many times that of a simple tetranucleotide.

Makino<sup>127</sup> adduced evidence supporting formula VIII since, on titrating ribosenucleic acid with alkali in the presence of phenolphthalein as indicator, he claimed to have observed only four primary phosphoric dissociations, a conclusion confirmed by Gulland<sup>128</sup> by electrometric titration. Gulland, therefore, had made his observations on a form of nucleic acid in which the secondary acidic group is involved in some type of union, either to give a cyclic structure as in VIII or as a phosphoamide, etc. Makino's experimental technique is, however, to be viewed with some skepticism since in the same year he averred<sup>129</sup> (on the basis of titration with alkali in the presence of phenolphthalein) that thymidine reacts with boric acid, a conclusion proved groundless by Levene and Tipson.<sup>130</sup> It should be mentioned that Thomas and Dox<sup>131</sup> had employed a similar technique and found *eight* titratable acidic groups in ribosenucleic acid. As pointed out by Levene,<sup>132</sup> at pH 10 (alkaline to phenolphthalein) the range of dissociation of the "phenolic" groups of the bases has been reached, so that the number of ionizable phosphoric groups is less than eight.

It is obviously true that a cyclic tetranucleotide (VIII) would have only four acid groups. On the other hand, if a number of tetranucleotide units (VII, having five acid dissociations) are joined in a chain, through the *secondary* phosphoric acid groupings, there will only be one (terminal) phosphoric group present as a monophosphate; if the chain is long, it will be difficult to estimate the presence of this single group either enzymically or titrimetrically. (The situation may be likened to that obtaining in the polysaccharides, in which there is one "end-group" differing from

<sup>126</sup> W. Klein and A. Rossi, *Z. physiol. Chem.*, **231**, 104 (1935).

<sup>127</sup> K. Makino, *Z. physiol. Chem.*, **236**, 201 (1935); **232**, 229 (1935).

<sup>128</sup> J. M. Gulland, *J. Chem. Soc.*, 1722 (1938).

<sup>129</sup> K. Makino, *Z. physiol. Chem.*, **233**, 186 (1935).

<sup>130</sup> P. A. Levene and R. S. Tipson, *Z. physiol. Chem.*, **234**, v (1935).

<sup>131</sup> A. Thomas and A. W. Dox, *Z. physiol. Chem.*, **142**, 1 (1925).

<sup>132</sup> P. A. Levene, ref. 14, p. 283.

the other units as regards the number of alcoholic hydroxyl groups.) The longer the chain, the closer will the number of acid dissociations experimentally ascertained approach four, provided that the secondary phosphoric group of one tetranucleotide unit does not engage a phospho group of the adjacent tetranucleotide unit.

In addition to reporting on a sample of yeast ribonucleic acid having 4.5 acid dissociations per tetranucleotide unit, Levene and Simms<sup>98</sup> had described a sample having 3.0 acid dissociations per tetranucleotide unit (at pH 8, at which point the titration of primary and secondary dissociating groups of phosphoric acid is complete). They ascribed this to the formation of anhydride linkages; obviously, if inter-tetranucleotide linkage occurs through *primary* groups, the polymer will possess (approximately) one secondary and three primary dissociations per tetranucleotide unit. However, it is perfectly possible that both types of inter-tetranucleotide linkage are present (namely, through secondary *and* through primary groups); there may even be cross-linkages from one chain to another. Furthermore, if a secondary phosphoric group of one tetranucleotide unit engages a primary phosphoric group of the adjacent tetranucleotide unit, and this process is repeated, Levene's formula (VII) would give a polymer having (approximately) three primary phosphoric dissociations.

Now, Gulland and coworkers<sup>132a</sup> have found, by electrometric titration, that yeast ribonucleic acid possesses four acid dissociations per tetranucleotide unit, *three* of which are primary dissociations, and one a secondary dissociation of phosphoric acid. (It was verified that deaminated yeast ribonucleic acid is constituted similarly, thus eliminating the possibility of phosphoamide links.) In addition, they found that mild alkaline hydrolysis diminishes the molecular weight of the poly-tetranucleotide, and the titration results for the product suggested that *a further secondary dissociation* of phosphoric acid is set free; that is, that if it were possible to isolate the fundamental tetranucleotide, the pentabasic product should have three primary and two secondary phosphoric acid dissociations.

Thus, as with ribonuclease hydrolysis, chemical hydrolysis of the polymer causes fission of a link involving a secondary acidic group of a phosphoryl radical; it is not yet known (a) whether the products are identical, and (b) whether the same phospho groups are split in each type of depolymerization. Accepting Gulland's titration results, possible formulas for the tetranucleotide (in which polymerization takes place at A or B) are as follows.

<sup>132a</sup> W. E. Fletcher, J. M. Gulland and D. O. Jordan, *J. Chem. Soc.*, 33 (1944).

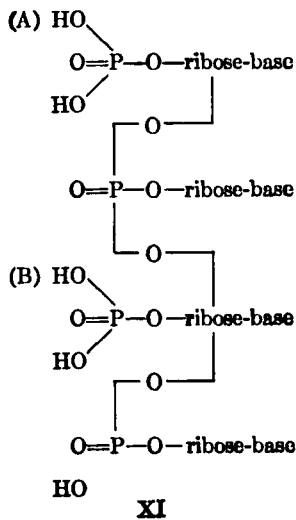
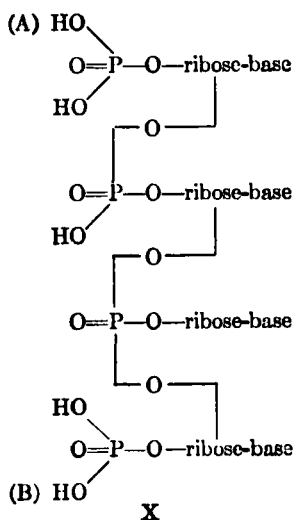
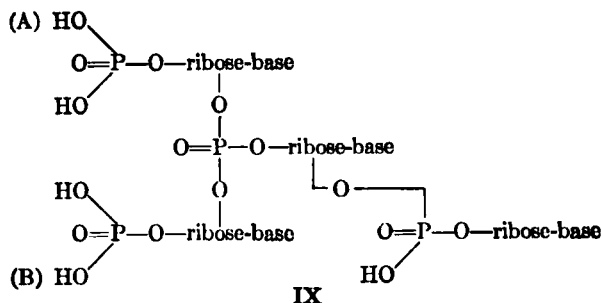

If polymerization involves groupings at A and B, or from A or B of one tetranucleotide unit to a different phospho group of another unit, these formulas would give the wrong number of dissociations for the polymer.

Bolomey and Allen<sup>124</sup> found that a non-specific phosphatase preparation (Bredereck<sup>25</sup>) containing a small amount of ribonuclease hydrolyzes ribonucleic acid in such a manner that guanosine is liberated faster than adenosine, in the early stages of the hydrolysis; the equivalent amount of free phosphoric acid is simultaneously formed. After hydrolysis of the purine nucleotide constituents has reached a maximum, hydrolysis of the pyrimidine nucleotides becomes appreciable. (If the ribonucleic acid is subjected to the action of ribonuclease before treatment with the phosphatase, the reaction is much more rapid.) They therefore tentatively suggested that guanylic acid is the first mononucleotide liberated and adenylic acid the second. Hence, provided that

dephosphorylation is not preceded by disruption to the *four* mononucleotides, guanylic acid is probably at one end of the chain, and adenylic acid is either next to it or at the other end. However, in view of the discovery by Loring and Carpenter<sup>123b</sup> that mononucleotides *are* set free, to some extent, by ribonuclease it seems much more likely that such liberated mononucleotides are then split, at different rates, by the non-specific phosphatase.

It would be of interest to halt the hydrolysis when liberation of guanosine and adenosine approaches a maximum, and determine whether the pyrimidine nucleotides are present as a dinucleotide or as the two *mononucleotides*. It is not clear whether the action of the non-specific phosphatase on an artificially-prepared, equimolecular mixture of the four mononucleotides has been studied (although the individual mononucleotides have been so examined by Bredereck, Beuchelt and Richter<sup>26</sup>), but Kobayashi<sup>87</sup> has found that guanylic acid is hydrolyzed more readily than adenylic acid which, in turn, is hydrolyzed more readily than the pyrimidine nucleotides. Furthermore, Bredereck, *et al.*<sup>110</sup> have shown that mild *chemical* hydrolysis of ribosenucleic acid with aqueous pyridine at 100° gives guanylic acid (G) plus a "trinucleotide" composed of adenylic (A), cytidylic (C), and uridylic (U) acids. On further hydrolysis in aqueous pyridine, adenylic acid is split off. Hence, in ribosenucleic acid, (G) is at one end of the molecule and, in the trinucleotide, (A) is at one end of the molecule. Possible formulas for the tetranucleotide are therefore



Gulland and Jackson<sup>133</sup> confirmed that phosphomonoesterase<sup>134</sup> liberates 7%, or less, of the phosphoric acid from ribosenucleic acid. They therefore concurred with Takahashi that this kind of ribosenucleic acid contains no phosphomonoester group and that each phosphorus atom is present as a disubstituted phosphoryl group, but they pointed out that this is not necessarily a di-*ester* group. The liberation of 7%, or less, of the total phosphorus is in accord with the idea of a polymerized tetranucleotide; 25% of the phosphorus in the simple tetranucleotide (VII) should be hydrolyzable by phosphatase.

They also found<sup>133</sup> that phosphodiesterase<sup>134</sup> does not liberate phosphoric acid from ribosenucleic acid.

On the other hand, they discovered that whereas British ribosenucleic acid is *completely* dephosphorylated by various *mixtures* of phos-

<sup>123</sup> J. M. Gulland and E. M. Jackson, *J. Chem. Soc.*, 1492 (1938).

<sup>134</sup> J. M. Gulland and E. M. Jackson, *Biochem. J.*, 32, 590, 597 (1938); J. Reis, *Bull. soc. chim. biol.*, 16, 385 (1934); *Enzymologia*, 2, 183 (1937).

phomonoesterases with phosphodiesterases, German ribonucleic acid was only dephosphorylated to the extent of 75%, a phenomenon previously encountered<sup>26, 135</sup> in enzymic hydrolysis of the acid. They suggested that, in the German acid, one phosphate group may be constituted differently from the other three, or that the four groups are similarly constituted but the specificity of the enzyme does not permit fission of one of them. They later obtained evidence<sup>136</sup> that the phosphatase-resistant group is associated with the adenylic and cytidylic acid units, and is not that of guanine-uridylic acid.

Schmidt and Thannhauser<sup>136a</sup> have shown that alkaline intestinal phosphatase (Armstrong<sup>136b</sup>) has diesterase activity. It completely releases the phosphoric acid radicals of yeast nucleic acid as inorganic phosphate. King and Delory<sup>136c</sup> had reported that several diesters of phosphoric acid are hydrolyzed by Armstrong's phosphatase. Schmidt and Thannhauser<sup>136a</sup> confirmed that it splits diphenylphosphoric acid. They suggested that this hydrolysis is caused by the action of the phosphatase itself and not by the presence of contaminating amounts of a hypothetical "phosphodiesterase." They indicated that "it appears that the term 'phosphomonoesterase,' sometimes used in the literature for phosphatase, is misleading," and emphasized that "alkaline phosphatase offers no simple possibilities for the structural differentiation of the various phosphorus radicals in ribonucleic acid."

Gulland and Jackson<sup>133</sup> performed some experiments with 5-nucleotidase, a highly specific enzyme which dephosphorylates<sup>134</sup> 5-phosphoadenosine and -inosine but not<sup>91</sup> 5-phospho-guanosine and -uridine; it is apparently not yet known whether the enzyme dephosphorylates 5-phospho-cytidine. They found that a mixture of phosphodiesterase with 5-nucleotidase liberates 35% of the total phosphorus as inorganic phosphate, and therefore decided that "two or more" of the phosphoryl groups may be attached at position (5) of the ribose units. The 35% dephosphorylation, intermediate between 25 and 50%, was explained as the result of simultaneous, competitive diesterase action at A and B, on two or more phosphoryl groups:

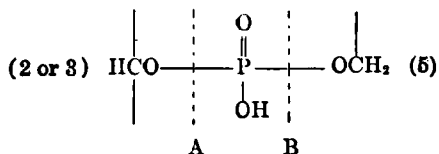

<sup>133</sup> W. Klein, *Z. physiol. Chem.*, **207**, 125 (1932).

<sup>134</sup> J. M. Gulland and E. M. Jackson, *J. Chem. Soc.*, 1842 (1939).

<sup>136a</sup> G. Schmidt and S. J. Thannhauser, *J. Biol. Chem.*, **149**, 369 (1943).

<sup>136b</sup> A. R. Armstrong, *Biochem. J.*, **29**, 2020 (1935).

<sup>136c</sup> E. J. King and G. E. Delory, *Biochem. J.*, **33**, 1185 (1939).

Scission of a tetranucleotide at A would give two (to four) 5-phosphonucleosides susceptible to dephosphorylation by 5-nucleotidase; scission at B would give a nucleoside and two phosphonucleosides unaffected by 5-nucleotidase, together with a diphosphonucleoside. It would seem that more light could be thrown on this problem by ascertaining (a) the nature of the product still retaining 65% of organically-bound phosphorus; and (b) the nature of the product formed by diesterase alone.

Faced with the problem of reconciling these findings with the fact that the nucleotides actually isolated on chemical hydrolysis are not 5-phosphonucleosides, Gulland<sup>128</sup> has envisioned a system of phosphate transfer from position (2) or (3) to position (5) prior to dephosphorylation by 5-nucleotidase, or from position (5) to position (3) on chemical fission to the mononucleotides. The results of experiments designed to test the validity of one or other of these theories are awaited with interest.

In attempting to assess the value of such results it should be borne in mind that the phenomena observed in enzyme experiments may not necessarily be caused by the enzyme supposedly under investigation but by some unknown or unforeseen enzyme in the enzyme mixture. It is to be hoped that more energetic attempts will be made to isolate the enzymes under consideration in unequivocally pure condition.

In addition, more detailed investigation of the molecular size of different samples of ribonucleic acid is desirable, particularly in view of the differences between British and German ribonucleic acids. Myrbäck and Jorpes<sup>127</sup> found, by a diffusion method, that the molecular weight of yeast ribonucleic acid lies between 1300 and 1700, indicating a simple tetranucleotide, not a polymer. On the other hand, pancreas ribonucleic acid had about double this molecular weight. Using the diffusion method of Northrop and Anson, Kunitz<sup>128</sup> obtained results indicating that yeast ribonucleic acid has a molecular weight considerably larger than that of a tetranucleotide. By the same method Loring<sup>127a</sup> found that the nucleic acid of tobacco mosaic virus has a molecular weight of 37,000 and is therefore made up of about 29 tetranucleotide units, whereas yeast ribonucleic acid has a molecular weight of 17,000 and is formed from 14 to 22 tetranucleotide units. Also using a dialysis method, Fischer and coworkers<sup>128c</sup> decided that yeast ribonucleic acid (Boehringer) has a molecular weight of 10,300; but according to Gulland and collaborators,<sup>127b</sup> the molecular size varies from 8 to 17-18 tetranucleotide units, depending on the commercial source of the acid. Two

<sup>127</sup> K. Myrbäck and E. Jorpes, *Z. physiol. Chem.*, **237**, 159 (1935).

<sup>127a</sup> H. S. Loring, *J. Biol. Chem.*, **128**, lxi (1939).

<sup>127b</sup> W. E. Fletcher, J. M. Gulland, D. O. Jordan, and H. E. Dibben, *J. Chem. Soc.*, **30** (1944).

samples of the British acid had molecular weights of 15,830 and 22,550, respectively, whereas a sample of the Boehringer acid had a molecular weight of 10,280. Deamination of the British acid did not diminish the molecular weight, confirming the conclusion "that phosphoamide groups do not play an essential part in linking nucleotides in the acid from that source."

Bredereck<sup>137c</sup> found, by a dialysis method, that the product isolated after mild alkaline hydrolysis of yeast ribonucleic acid had an average molecular weight of 1,177 and was, presumably, the fundamental tetranucleotide unit. It had the correct analysis for such a molecule and exhibited five phosphoric acid dissociations. However, Gulland and collaborators<sup>132a</sup> have been unable to repeat the work of Bredereck and Hoepfner precisely; instead, they isolated a material having a higher average molecular weight (5,810) and greater acidity. They decided that both products were mixtures having an indefinite composition, and that there is no evidence, on these grounds, for the belief that a simple ribosetetrannucleotide has, as yet, been prepared. However, there are reasons for suspecting the reliability of the diffusion method, and all these diffusion results should be checked by other methods.

Such a comprehensive investigation has been performed by Cohen and Stanley<sup>137d</sup> on the ribonucleic acid from tobacco mosaic virus. They present data on the electrophoresis, partial specific volume, diffusion, sedimentation, viscosity, electron microscopy, osmotic pressure, optical properties, and elementary composition of the material and its derivatives. They conclude that the freshly isolated nucleic acid has an average particle size of 300,000 and is highly asymmetric. It decomposes spontaneously to form asymmetric particles having a molecular weight of approximately 61,000. On treatment with cold alkali it gives particles having a molecular weight of 15,000 (about 45 mononucleotides per molecule). They consider that there is, at present, no evidence that a unit smaller than that of molecular weight of 15,000 and larger than a mononucleotide exists as a fundamental unit of the virus ribonucleic acid. Micellar disaggregation may be the explanation of the *spontaneous* diminution in molecular weight.

By absorption spectrum measurements, Butenandt and collaborators<sup>137e</sup> have demonstrated that, in the *native* virus acid, the purine and pyrimidine units are located in planes perpendicular to the axis of the ribonucleic acid molecule.

<sup>137c</sup> H. Bredereck and E. Hoepfner, *Ber.*, **75**, 1086 (1942).

<sup>137d</sup> S. S. Cohen and W. M. Stanley, *J. Biol. Chem.*, **144**, 589 (1942).

<sup>137e</sup> A. Butenandt, H. Friedrich-Freksa, S. Hartwig, and G. Scheibe, *Z. physiol. Chem.*, **274**, 276 (1942).



It seems probable that, as with desoxyribonucleic acid, the size of the particles of ribonucleic acid depends upon the treatment to which the acid has been subjected, the size being smaller when less mild methods of isolation are applied. Bawden and Pirie<sup>137f</sup> had pointed out that the size of the tobacco mosaic virus ribonucleic acid particles is larger than that of the particles of yeast ribonucleic acid as usually prepared. Loring<sup>137g</sup> has now found that purified, commercial yeast ribonucleic acid solutions have about the same specific viscosity as have solutions of the *alkali-treated* ribonucleic acid of tobacco mosaic virus; hence, their molecular sizes are probably of the same order (about 15,000).

Finally, there seems good reason to believe that, in *native* ribonucleic acid, there are labile linkages of a nature as yet unknown; electrophoretic studies by Cohen<sup>137h</sup> show that both ribonucleic acid and desoxyribonucleic acid may possess either four or five acidic groups per tetranucleotide unit, depending upon the previous treatment. It would be of interest to ascertain if the material endowed with a secondary phosphoric dissociation is a simple tetranucleotide, and if this is the material which can be *completely* dephosphorylated by a mixture of monoesterase and diesterase.

### B. Desoxyribonucleic Acid

Sources from which desoxyribonucleic acid has been isolated include<sup>138</sup> fish sperm, thymus, spleen, pancreas, testicles, placenta, mammary glands, brain, liver, kidney, blood cells, thyroid, intestines, lungs, lymphatic glands, bacteria, and tumor tissue. It is difficult to obtain a uniform product, free from protein; the first serviceable method was that of Neumann,<sup>139</sup> which has been improved upon by later workers. The nucleic acid from thymus glands may be isolated<sup>140</sup> in the following manner:

The hashed glands are mixed with 5% aqueous sodium chloride solution and the suspension heated until boiling. A few cc. of acetic acid are then added, and the boiling continued during five minutes. Sodium acetate and sodium hydroxide are now added, and the mixture boiled until most of the tissue has dissolved (a further five minutes). The hot mixture is rendered neutral by the addition of glacial acetic acid; colloidal iron and more glacial

<sup>137f</sup> F. C. Bawden and N. W. Pirie, *Proc. Roy. Soc. (London)*, **B**, 123, 274 (1937).

<sup>137g</sup> H. S. Loring, "The Biochemistry of the Nucleic Acids, Purines and Pyrimidines," *Ann. Rev. Biochem.*, **13**, 297 (1944).

<sup>137h</sup> S. S. Cohen, *J. Biol. Chem.*, **146**, 471 (1942).

<sup>138</sup> See ref. 14, p. 294.

<sup>139</sup> A. Neumann, *Arch. Anat. Physiol., Physiol. Abt.*, 374 (1898); suppl. 552 (1899).

<sup>140</sup> P. A. Levene, *J. Biol. Chem.*, **53**, 441 (1922); see ref. 14, p. 299.

acetic acid are added, and the mixture is filtered while hot. The nucleic acid is then precipitated from the filtrate by the addition of twice its volume of ethyl alcohol.

In the early attempts to identify the nitrogenous bases of desoxy-ribosenucleic acid, some confusion arose for two reasons. At first, the products obtained by hydrolysis of nucleoprotein were studied, and there was no assurance that any particular base came from the nucleic acid rather than from the protein. Then, when the nucleic acid itself became available, the hydrolytic agents at first employed were sufficiently drastic to cause some deamination of the amino-purines (with the production of some xanthine and hypoxanthine) and some demethylation of thymine to uracil. In 1874, Piccard<sup>141</sup> isolated guanine (and hypoxanthine) from sperm nuclein. Kossel and Neumann discovered in the hydrolyzate of thymus nucleic acid two new pyrimidine bases which they named *thymine*<sup>142</sup> and *cytosine*<sup>143</sup> but they assigned incorrect empirical formulas to them. In 1894, they correctly described<sup>143</sup> thymine as  $C_5H_6O_2N_2$ , but cytosine was not purified and characterized till much later.<sup>144,145</sup> Levene now analyzed a series of nucleic acids from a variety of sources and found<sup>146,146</sup> that they all contained guanine and adenine. By mild hydrolysis of thymus nucleic acid, Steudel<sup>147</sup> obtained guanine and adenine as the *sole* purine bases and demonstrated that they occur in equimolecular proportions. Levene and Mandel<sup>148</sup> confirmed this result and showed that the two purine bases and the two pyrimidine bases (thymine and cytosine) all occur in thymus nucleic acid in equimolecular proportions.

Desoxyribosenucleic acid is readily hydrolyzed by mineral acids but is more resistant to alkaline fission than is ribosenucleic acid. Owing to the nature of the constituent sugar, the purine nucleotides are even more unstable than those of ribosenucleic acid. Hence, by acid hydrolysis of thymus nucleic acid, only the two pyrimidine nucleotides<sup>100,149,150</sup> can be isolated.

All chemical methods of hydrolyzing desoxyribosenucleic acid, with-

<sup>141</sup> J. Piccard, *Ber.*, **7**, 1714 (1874).

<sup>142</sup> A. Kossel and A. Neumann, *Ber.*, **26**, 2753 (1893).

<sup>143</sup> A. Kossel and A. Neumann, *Ber.*, **27**, 2215 (1894).

<sup>144</sup> A. Kossel and H. Steudel, *Z. physiol. Chem.*, **37**, 177 (1902).

<sup>145</sup> P. A. Levene, *Z. physiol. Chem.*, **37**, 402 (1903); **38**, 80 (1903).

<sup>146</sup> P. A. Levene, *Z. physiol. Chem.*, **32**, 541 (1901); **45**, 370 (1905).

<sup>147</sup> H. Steudel, *Z. physiol. Chem.*, **49**, 406 (1906).

<sup>148</sup> P. A. Levene and J. A. Mandel, *Biochem. Z.*, **10**, 215 (1908).

<sup>149</sup> P. A. Levene and J. A. Mandel, *Ber.*, **41**, 1905 (1908).

<sup>150</sup> S. J. Thannhauser and B. Ottenstein, *Z. physiol. Chem.*, **114**, 39 (1921).

out destroying the purine nucleotides, proved futile<sup>100</sup> as they were too drastic. Consequently, Levene turned to the use of enzymes.

### I. DESOXYRIBOSE NUCLEOSIDES

The hydrolysis of desoxyribosenucleic acid to the constituent nucleosides was achieved by Levene and London<sup>151</sup> in 1929, by the action of the enzymes of intestinal juice. They passed a solution of the acid through a segment of the gastro-intestinal tract of a dog, and collected it from an intestinal fistula. The solution was then covered with a layer of toluene and incubated in a thermostat during four to seven days, small portions of gastro-intestinal secretion being added daily. The digestion mixture was now poured into twice its volume of 95% ethyl alcohol, filtered, and the nucleosides isolated from the filtrate.

This procedure gave the desoxyribose nucleosides of guanine, cytosine, thymine, and *hypoxanthine*. It was later discovered by Klein<sup>152</sup> that the desoxyribosylhypoxanthine had been formed from desoxyribosyladenine by the action of a deaminase of the intestine. He found that silver ions selectively inhibit this deaminase, and so was enabled to isolate the adenine nucleoside.

#### 1. *Desoxyribosylpurines*

The two desoxyribosylpurines isolated from thymus nucleic acid are nucleosides of adenine and guanine. The identification of the nitrogenous bases has already been discussed.

Extreme difficulty was experienced in isolating and identifying the sugar component since it was found to be much less stable than D-ribose or any other sugar then known. In addition, it forms a very soluble hydrazone and no osazone, so that these means of isolating a derivative from the hydrolysis product were barred. For many years the sugar was thought to be a hexose since, on hydrolysis, levulinic acid was invariably isolated. It remained for Levene, one of the world's great biochemists, to establish the identity of the sugar.

In 1929, after many years of persevering endeavor, Levene<sup>151, 153</sup> succeeded in isolating the sugar in crystalline condition by extremely mild hydrolysis of very pure guanine nucleoside. The nucleoside was treated with very dilute mineral acid (effective acidity, 0.01 N) during 10 minutes

<sup>151</sup> P. A. Levene and E. S. London, *J. Biol. Chem.*, **81**, 711 (1929); **83**, 793 (1929); F. Bielschowsky and W. Klein, *Z. physiol. Chem.*, **207**, 202 (1932).

<sup>152</sup> W. Klein, *Z. physiol. Chem.*, **224**, 244 (1934); **255**, 82 (1938); T. G. Brady, *Biochem. J.*, **35**, 855 (1941).

<sup>153</sup> P. A. Levene and T. Mori, *J. Biol. Chem.*, **83**, 803 (1929).

in a boiling water-bath; on removal of the acid and purine base, and evaporation of the filtrate, a crystalline sugar was isolated.

This new sugar had the formula  $C_5H_{10}O_4$ . In other words, it possesses one atom of oxygen less than does a pentose. Analysis of its benzyl-phenylhydrazone, of its guanine and hypoxanthine nucleosides, and of its thymine and cytosine nucleosides, confirmed this composition. It therefore appeared probable that the sugar might be a desoxypentose.

At that time certain 2-desoxyhexoses had been fairly extensively studied, but the only known 2-desoxypentose was 2-desoxy-L-arabinose<sup>154</sup> the specific rotation of which had not been reported. Levene therefore synthesized 2-desoxy-D-xylose<sup>155</sup> and 2-desoxy-L-arabinose.<sup>155</sup>

Synthetic 2-desoxy-L-ribose (-L-arabinose), prepared<sup>155</sup> by the action of dilute sulfuric acid on L-arabinal (L-ribal), had the same numerical values of initial and equilibrium specific rotation (but opposite sign) as had the sugar of thymus nucleic acid. Hence the sugar was identified as 2-desoxy-D-ribose. On treatment with dilute sul-

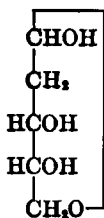

furic acid, both the natural and the synthetic sugars gave levulinic acid,  $\text{CH}_3\text{CO}\cdot\text{CH}_2\cdot\text{CH}_2\cdot\text{COOH}$ . The natural sugar gives all the qualitative tests common to 2-desoxysugars: a positive Kiliani test, a positive Schiff's test, and a positive "pine-splinter" test.

The general arguments which had been advanced to show the position of union of sugar to base in the ribosylpurines hold also for the desoxy-ribosylpurines. Gulland and Story<sup>156, 156</sup> examined their ultraviolet absorption spectra and showed that they are both 9-substituted purine derivatives.

The ring-structure of the sugar moiety of the desoxyribosylpurines is still unknown; by analogy with that of thymidine, and of the ribosylpurines, it is probably furanose.

<sup>154</sup> J. Meisenheimer and H. Jung, *Ber.*, **60**, 1462 (1927).

<sup>155</sup> P. A. Levene, L. A. Mikeska, T. Mori, *J. Biol. Chem.*, **85**, 785 (1930).

<sup>156</sup> J. M. Gulland and L. F. Story, *J. Chem. Soc.*, 259 (1938).

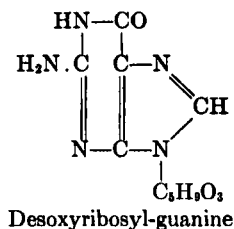
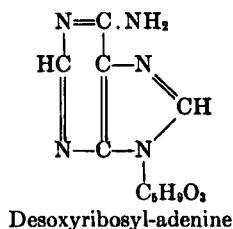

## 2. Desoxyriboseylpyrimidines

The two desoxyriboseylpyrimidines isolated from thymus nucleic acid are nucleosides of thymine and of cytosine. On treatment with 5% sulfuric acid, hydrolysis takes place giving the readily recognizable pyrimidine, but the sugar liberated is immediately transformed to levulinic acid. This fact, combined with the results of elementary analysis of the two pyrimidine nucleosides, indicates that the sugar is a 2-desoxypentose. There is no proof that it is 2-desoxy-D-ribose. Attempts to hydrogenate thymidine by the method used for uridine<sup>60</sup> have not been successful.

The arguments used in allocating the ribosyl radical in the ribosylpyrimidines at position (3') of the base hold good for the desoxyriboseylpyrimidines, *i.e.*, they are probably 3'-desoxyriboseylthymine and 3'-desoxyriboseylcytosine.

To date, the sugar ring structure of only one desoxyriboseyl nucleoside (namely, thymidine) is known. In 1935, Levene and Tipson<sup>106, 107</sup> found that thymidine condenses with trityl chloride in the presence of dry pyridine to give a crystalline monotrityl-thymidine. From their previous proof of the structure of monotrityl-uridine as the 5-trityl ether, it seemed probable that the thymidine ether is 5-trityl-thymidine. This was confirmed by tosylation, to give tosyl-trityl-thymidine, followed by treatment with sodium iodide in acetone under standard conditions.

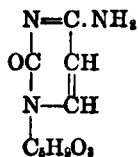
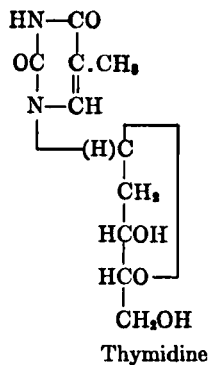

<sup>107</sup> P. A. Levene and R. S. Tipson, *Science*, **81**, 98 (1935).

There was practically no reaction with sodium iodide, indicating that the tosyl group was not situated at position (5) and that the tosylation product was 3-tosyl-5-trityl-thymidine. Hence, the ether is 5-trityl-thymidine, and thymidine can be assigned a furanose ring. This conclusion received confirmation from their observation<sup>180</sup> that, unlike guanosine and inosine, thymidine does not react with boric acid and therefore does not possess two adjacent *cis* hydroxyl groups.

## II. DESOXYRIBOSE NUCLEOTIDES

### 1. *Monophosphodesoxyribose Nucleotides*

As previously mentioned, Levene was able to isolate the pyrimidine nucleotides of desoxyribosenucleic acid by chemical hydrolysis but, owing to their instability, the purine nucleotides were destroyed.

In 1933, Klein<sup>158</sup> discovered that sodium arsenate inhibits the action of the nucleotidase<sup>118, 135</sup> of intestinal mucosa. Consequently, Klein and Thannhauser<sup>159</sup> were enabled to hydrolyze thymus nucleic acid by means of intestinal desoxyribonucleinase without subsequent dephosphorylation of the liberated nucleotides. Making use, also, of Klein's discovery<sup>162</sup> of the deaminase-inhibiting activity of silver ions, they were successful in isolating the adenine nucleotide. Hence the phosphodesoxyribosyl nucleotides of adenine, guanine, thymine, and cytosine were isolated and characterized.

The position of attachment of the phosphoryl group is unknown. However, it is probably either at position (3) or position (5). It cannot be at position (2) and if, as appears likely, the desoxyribosyl radical is furanose it cannot be at position (4).

### 2. *Diphospho-desoxyribosyl-pyrimidines*

In 1912, Levene and Jacobs<sup>100</sup> discovered that, on hydrolysis of thymus nucleic acid by means of boiling 2% sulfuric acid during two hours, diphosphoric esters of thymidine<sup>160</sup> and of "desoxyribosyl"-cytosine may be isolated.<sup>105, 160</sup>

On catalytic hydrogenation, diphosphothymidine gave diphosphodihydrothymidine which is readily hydrolyzed by mineral acid to dihydrothymine and a reducing diphospho-sugar. Hence both phosphoryl groups are attached to the sugar component and, since thymidine is furanose, they must be situated at positions (3) and (5).

Hence these two nucleotides may be represented as follows.

<sup>158</sup> W. Klein, *Z. physiol. Chem.*, **218**, 164 (1933).

<sup>159</sup> W. Klein and S. J. Thannhauser, *Z. physiol. Chem.*, **218**, 173 (1933); **224**, 252 (1934); **231**, 96 (1935).

<sup>160</sup> P. A. Levene, *J. Biol. Chem.*, **126**, 63 (1938).

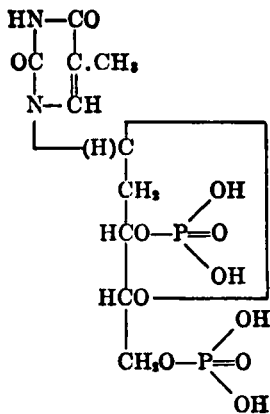

Diphosphothymidine

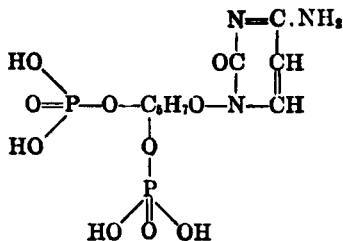

Diphospho-"desoxy-ribozyl"-cytosine

The diphosphosugar should be studied further, since it offers the chance of identifying the sugar of the pyrimidine nucleosides of desoxyribonucleic acid. There is every reason to believe that the sugar is 2-desoxy-D-ribose, but no definite proof is yet forthcoming.

### III. DESOXYRIBOSENUCLEIC ACID

Since partial hydrolysis of desoxyribonucleic acid gives rise to four nucleotides, and complete hydrolysis gives the four nitrogenous bases in equimolecular proportions, the fundamental molecule of the acid may be regarded as a tetranucleotide.

According to Miescher,<sup>100a</sup> the acid is tetrabasic. However, Levene and Simms<sup>98, 101</sup> found that desoxyribonucleic acid\* has one secondary and four primary phosphoric dissociations, a conclusion since confirmed by Bredereck.<sup>102</sup> Levene<sup>106</sup> proposed a formula of type VII for desoxyribonucleic acid; however, since the acid gives rise to two diphosphodesoxyribosylpyrimidines on hydrolysis, he was able<sup>101</sup> to extend that formula by showing alternating purine and pyrimidine residues as follows.

<sup>100a</sup> F. Miescher, "Die histochemischen und physiologischen Arbeiten," Vol. II, Leipzig (1897).

<sup>101</sup> P. A. Levene and H. S. Simms, *J. Biol. Chem.*, **65**, 519 (1925).

\* From the determinations of molecular weight performed later, this was probably a partially depolymerized sample.

<sup>102</sup> H. Bredereck and M. Koethnig, *Ber.*, **72**, 121 (1939).

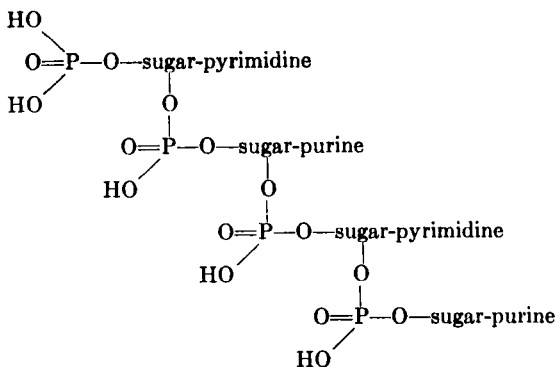

In 1935, Levene and Tipson<sup>157, 106, 130</sup> established the furanose structure of thymidine and suggested that the other nucleosides of desoxyribonucleic acid are likewise furanose. On this assumption the phosphoryl groups must be situated at positions (3) and (5), and they therefore suggested<sup>106</sup> the following formula for the tetranucleotide of desoxyribonucleic acid.

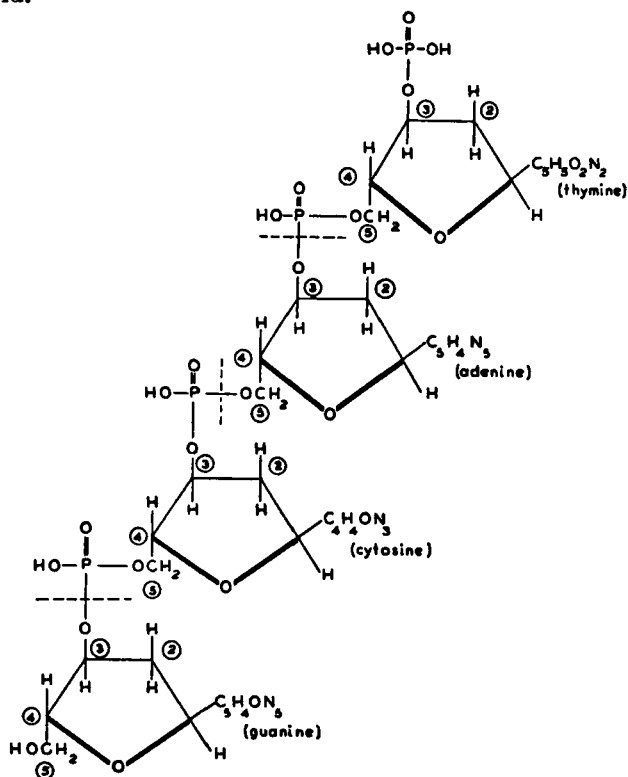

Tetranucleotide Unit of Desoxyribonucleic Acid ( $\text{C}_{20}\text{H}_{51}\text{O}_{28}\text{N}_{15}\text{P}_4$ )



This formulation is confirmed by the fact that, on deamination,<sup>110</sup> it retains its tetranucleotide structure and pentabasicity, and hence contains no phosphoamide links. Bredereck and collaborators<sup>162a</sup> completely methylated thymonucleic acid, obtaining a product possessing seven *N*-methyl and three methoxyl groups to each four phosphorus atoms. On stepwise hydrolysis, this material gave 1,6-dimethyladenine, 1,6-dimethyleytosine, and 1-methylthymine. This confirms the previously-mentioned conclusion, that the sugar is attached to position 9 of the adenine and to position 3 of the pyrimidines.

It is now recognized that native desoxyribosenucleic acid exists in the polymerized form. Miescher<sup>160a</sup> mentioned that it will not dialyze through parchment and hence is probably of high molecular weight. Levene<sup>163</sup> has shown, by sedimentation experiments and by enzymic dephosphorylation, that the molecular weight of different specimens depends on the method used for their isolation. Their data showed that, depending on the mode of preparation, the acid may have a molecular weight varying from about 1,500 to over 1 million; the more drastic methods of isolation yield materials having smaller particle size. Similarly, Tennent and Vilbrandt<sup>163a</sup> determined the rates of sedimentation and diffusion of five different samples of desoxyribosenucleic acid (sodium salt); the molecular weight ranged from 5,000 to 500,000. According to Pedersen,<sup>163b</sup> the acid prepared by Hammarsten's method has an average molecular weight of about 200,000.

The polymerized acid possesses about four acidic groups per tetranucleotide<sup>124, 127, 128, 164</sup> unit, but an exact correlation of average basicity with average molecular weight does not appear to have been obtained. The degree of polymerization of the product is listed in descending order, according to the originator of the method of isolation: (a) Hammarsten<sup>164</sup>; (b) Neumann<sup>159</sup> as modified by Feulgen<sup>165</sup>; (c) Levene<sup>140</sup>; and (d) Feulgen.<sup>166</sup>

Signer, *et al.*<sup>167</sup> have studied the viscosity and double refraction of flow of one of the more highly polymerized specimens of desoxyribosenucleic acid, and conclude that the molecular weight lies between 5 times

<sup>162a</sup> H. Bredereck, G. Mueller and E. Berger, *Ber.*, **73**, 1058 (1940).

<sup>163</sup> G. Schmidt and P. A. Levene, *Science*, **88**, 172 (1938); G. Schmidt, E. G. Pickels, P. A. Levene, *J. Biol. Chem.*, **127**, 251 (1939).

<sup>163a</sup> H. G. Tennent and C. F. Vilbrandt, *J. Am. Chem. Soc.*, **65**, 424 (1943).

<sup>163b</sup> K. O. Pedersen, in T. Svedberg and K. O. Pedersen, "The Ultracentrifuge," p. 443. Oxford University Press, Oxford (1940).

<sup>164</sup> E. Hammarsten, *Biochem. Z.*, **144**, 383 (1924).

<sup>165</sup> R. Feulgen, *Z. physiol. Chem.*, **90**, 261 (1914).

<sup>166</sup> R. Feulgen, *Z. physiol. Chem.*, **238**, 105 (1936).

<sup>167</sup> R. Signer, T. Caspersson and E. Hammarsten, *Nature*, **141**, 122 (1938).

$10^5$  and a million. This result was confirmed<sup>168</sup> by X-ray fiber photographs on the same specimen, and indicates that at least 2,000 mononucleotides are united to form a molecule of the sample studied. Greenstein and Jenrette<sup>168a</sup> also examined the viscosity and streaming birefringence of solutions of the acid. That prepared by Hammarsten's method<sup>164</sup> had about four times the viscosity and streaming birefringence displayed by the acid prepared by the Feulgen-Levene<sup>168b</sup> method.

Cohen's studies<sup>137h</sup> of electrophoretic mobility of samples of desoxyribonucleic acid isolated in different ways, indicate that the acid may possess either four or five acidic groups per tetranucleotide unit, depending upon the previous treatment. Indeed, according to Bredereck,<sup>169</sup> depolymerization to the pentabasic tetranucleotide state can be induced by treatment of the polymer with dilute sodium hydroxide at 60°, followed by neutralization with acetic acid and two precipitations with alcoholic hydrochloric acid at 10°. This supposed tetranucleotide did not form a gel or exhibit streaming birefringence; it had a molecular weight of 1,196 to 1,274.

A desoxyribonucleo-depolymerase is present<sup>166, 170</sup> in ox pancreas and calf thymus, and in extracts<sup>168a</sup> of the germs of Lima bean, sunflower, maize, wheat, and pumpkin. It is not the same as the crystalline ribonucleo-depolymerase, which is devoid of action on desoxyribonucleic acid. Action of this depolymerase on desoxyribonucleic acid causes<sup>128d</sup> an increase of acidity and conductivity; titration of the extra acidity liberated indicates that the final product is a pentabasic tetranucleotide. Greenstein and Jenrette<sup>168a</sup> found that the depolymerase also destroys the structural or anomalous viscosity.

By means of a phosphate-liberating nucleotidase Lehmann-Echternacht<sup>171</sup> and Fischer, Lehmann-Echternacht and Boettger<sup>128d</sup> have dephosphorylated this supposed simple tetranucleotide; the nucleosides liberated first were desoxyribosyl-adenine and thymidine. They therefore suggested that these nucleotides are at the end, or ends, of the tetranucleotide chain. The same objections which obtain for such experiments on ribonucleic acid may perhaps also be raised in this connection.

<sup>168</sup> W. T. Astbury and F. O. Bell, *Nature*, **141**, 747 (1938).

<sup>168a</sup> J. P. Greenstein and W. V. Jenrette, *J. Natl. Cancer Inst.*, **2**, 301 (1941); *Cold Spring Harbor Symposia Quant. Biol.*, **9**, 236 (1941).

<sup>168b</sup> P. A. Levene, ref. 14, p. 295.

<sup>169</sup> H. Bredereck and I. Jochmann, *Ber.*, **75**, 395 (1942).

<sup>170</sup> R. Feulgen, *Z. physiol. Chem.*, **237**, 261 (1935).

<sup>171</sup> H. Lehmann-Echternacht, *Z. physiol. Chem.*, **269**, 201 (1941).

This Page Intentionally Left Blank

# THE FRACTIONATION OF STARCH

BY THOMAS JOHN SCHOCH

*Corn Products Refining Company, Argo, Illinois*

## CONTENTS

I. Introduction . . . . .	247
II. Older Methods of Starch Fractionation . . . . .	247
III. Recent Concepts in Starch Chemistry . . . . .	252
IV. Fractionation by Selective Precipitation . . . . .	258
V. Fractionation by Aqueous Leaching . . . . .	261
VI. Properties and Structures of the Fractions . . . . .	263
VII. Function of the Fractions in Starch Paste Behavior . . . . .	271
VIII. Pertinent Problems in Starch Chemistry . . . . .	275

## I. INTRODUCTION

According to prevailing theories, starch contains two carbohydrate substances, both polymers of glucose but differing markedly in properties and structure. The minor component (for present purposes designated as the "A-fraction") appears to consist of long chain-like molecules with an average length of some 200-300  $\alpha$ -D-glucopyranoside units. This fraction is unstable in a colloidal sense and is responsible for the gelation and so-called "retrogradation" of starch. It is characterized by the production of a blue color with iodine. The major component (here termed the "B-fraction") is presumed to have a very large and ramified molecular structure, possibly a tree-like configuration with short linear branches. It yields reddish colorations with iodine. This fraction is stable and functions as a protective colloid for the A-fraction.

This survey will compare the various modes of starch fractionation, with particular emphasis on selective precipitation methods recently developed in these laboratories. The evidence for linear and branched structures of the fractions will be discussed, and the behavior of starch and its various modifications will be interpreted on that basis.

## II. OLDER METHODS OF STARCH FRACTIONATION

The heterogeneity of starch was recognized in the early literature by such investigators<sup>1</sup> as Guerin-Varry (1834-36), Naegeli (1862-81),

and A. Meyer (1881-95). It may seem strange that subsequent progress has been so slow and confused, but it is only within the past few years that new concepts and improved methods of study have been applied to the problem. Arguments have been advanced for the existence of only one constituent substance in starch,<sup>2</sup> or for two or three components, or for a graded series of innumerable molecular types. Opinions regarding the molecular size of the constituent carbohydrates have run the entire gamut of speculation, from the consideration of starch as composed of simple associated di- and tri-hexosan molecules<sup>3</sup> to the concept of the starch granule itself as a single chemical entity. This confusion is attributed to a variety of causes, among which may be enumerated the following:

1. Use of poor quality or degraded starches in experimental investigations.
2. Inadvertent degradation of the starch through drastic chemical treatment.
3. Difficulties in dispersing starch to give homogeneous sols, due to persistence of the swollen granule.
4. Physical instability of starch sols.
5. Failure to appreciate the status and effect of the non-carbohydrate substances associated with the starches in nature.
6. Absence of any satisfactory quantitative criteria for evaluating the purity of the fractions.
7. Confused nomenclature for the fractions.
8. Slow development of theoretical colloid chemistry, especially as applied to high polymers.
9. The difficulties in describing and evaluating the physical properties of the fractions in precise and tangible terms (as solubility, retrogradation, viscosity, gelation, etc.).

It is not the purpose of this survey to review in detail the voluminous literature on starch fractionation<sup>4</sup>. However, consideration must be given the above points in order to indicate the precautions which must

<sup>1</sup> E. T. Reichert, "Differentiation and Specificity of Starches in Relation to Genera, Species, etc.," Carnegie Institution of Washington, Publication No. 173 (1913), Part I. This monograph presents an excellent survey of early starch investigations.

<sup>2</sup> N. P. Badenhuizen, *Protoplasma*, **33**, 440-65 (1939).

<sup>3</sup> H. Pringsheim, in "A Comprehensive Survey of Starch Chemistry," edited by R. P. Walton, pp. 35-50. Reinhold Publishing Company, New York (1928).

<sup>4</sup> R. P. Walton, Editor, "A Comprehensive Survey of Starch Chemistry." Reinhold Publishing Company, New York (1928); J. A. Radley, "Starch and Its Derivatives." 2nd Edition, Chapman and Hall, London (1943); R. W. Kerr, Editor, "Chemistry and Industry of Starch." Academic Press, New York (1944).

be observed in starch research and to establish preferred methods of fractionation.

Except in rare instances, preparation of natural primitive starch from its botanical source is not practicable in the laboratory, and high grade commercial starches are usually satisfactory for fundamental studies. However, it must be borne in mind that the cereal starches are manufactured by alkali steeping of the grain, or by use of small quantities of sulfur dioxide to facilitate separation of associated protein. The commercial root and tuber starches are usually prepared by methods which involve the use of such adjuncts as hypochlorite, calcium hydroxide or sulfur dioxide. It is problematical whether any change is thereby engendered in the starch, either by hydrolysis or oxidation, or through the agency of natural enzymes released during storage and processing of grain or tuber. Scott viscosity values<sup>5</sup> of 250–300 have been obtained on starches experimentally isolated by alcohol steeping of corn meal, as compared with viscosities of 90–120 for commercial corn starch. It is recognized that the clarity of starch is impaired by successive wetting and air-drying of the ungelatinized granules, indicating certain physical changes in the starch. In addition, starch adsorbs heavy metal ions, silica, protein, fatty acid and other polar materials which may be present during growth or processing. These trace substances modify its properties to an appreciable degree, and their presence may be either ignored or over-emphasized in describing the properties of the fractions. It is thus important to be discriminating in the choice of raw starch for fundamental studies.

To avoid the high viscosity and persistent granule structure of unmodified starch, acid-hydrolyzed or heat-dextrinized starches of the Lintner<sup>6</sup> or Zulkowski<sup>7</sup> types have occasionally been employed for separation studies. Similarly, starch has been treated with hot alcoholic hydrogen chloride preliminary to fractionation,<sup>8</sup> to enhance its solubility in hot water. Prolonged dry-grinding in a pebble mill has been used to disintegrate granule structure and facilitate solution of the starch.<sup>9</sup> It is now recognized that these treatments produce extensive chemical degradation of the starch. Formerly, no adequate criterion existed by which to detect such degradation, and it was tacitly assumed that the

<sup>5</sup> This is an empirical measurement of "paste" viscosity, expressing the time (in seconds) for 50 ml. of hot gelatinized 4.7% starch paste to flow through a standard orifice.

<sup>6</sup> C. J. Lintner, *J. prakt. Chem.*, **34**, 378–94 (1886).

<sup>7</sup> K. Zulkowski, *Ber.*, **13**, 1395–98 (1880).

<sup>8</sup> T. C. Taylor and J. M. Nelson, *J. Am. Chem. Soc.*, **42**, 1726–38 (1920).

<sup>9</sup> T. C. Taylor and C. O. Beckmann, *J. Am. Chem. Soc.*, **51**, 294–302 (1929).

starch substance was unchanged if it still produced a blue color with iodine.

Starch is likewise physically unstable. Pastes and sols tend to become less soluble on standing, as evidenced by increase in viscosity and opacity and the eventual precipitation of a solid phase. This phenomenon has been termed "retrogradation," and is attributed specifically to the A-fraction. Since most separations are based on differential solubility of the several components, retrogradation may seriously disturb the amount and character of the fractions. This is particularly true of those methods where the starch is maintained in solution for extended periods of time.

The nomenclature of starch components has become highly confused through the indiscriminate use of such terms as  $\alpha$  and  $\beta$ -amylose, amylose and amylopectin, amyloamylose and erythroamylose, etc. It does not seem advisable to apply any of these older terms to the new and unique fractions obtained by selective precipitation methods. It is therefore proposed that the term "A-fraction" be applied to that portion of the starch which is preferentially precipitated by various alcohols or by higher fatty acids, and which exhibits a high affinity for iodine. Correspondingly, the residual non-precipitated portion of the starch, which possesses low iodine affinity, is termed the "B-fraction." These designations apply to laboratory-prepared samples, and do not carry any *a priori* connotations of purity, homogeneity, or structure.

The various modes of fractionation employed in the past have all accomplished a partial separation of starch components, though usually with attendant physical deterioration and frequently with chemical degradation. One portion of the starch has been characterized by the production of a pure blue color with iodine, high yields of maltose by  $\beta$ -amylase conversion, and a tendency to retrograde spontaneously to an insoluble state. This undoubtedly corresponds to the linear A-fraction. To the other component have been attributed purple or blue-black colorations with iodine, low maltose yields with  $\beta$ -amylase, and (in the case of potato starch) the presence of small amounts of phosphate esterified with the carbohydrate. These properties identify this component as the branched B-fraction. There has been little or no agreement on the relative proportions of these two components. This diversity of opinion can be traced to imperfect separation, due either to retrogradation effects or to incomplete disintegration of granule structure. Fractionation methods can be roughly grouped into the following general types. The various products are classified as A-fraction or B-fraction, in order to show their relationship to the fractions obtained by selective precipitation.

*Aqueous Leaching of Gelatinized Starch*<sup>10, 11, 12</sup>

This method involves extraction of the swollen but intact granules with successive portions of water, until no further solubles are removed. Separation is effected by sedimentation, filtration or centrifugation. The soluble extract represents a crude A-fraction, and the residue of swollen granules approximates the B-fraction. The procedure is tedious and protracted, sterile conditions are difficult to maintain, and the separation is very imperfect. Its sole advantage lies in the mild treatment accorded the starch; high temperatures and the use of chemicals are avoided. In view of its widespread use, the method has been thoroughly investigated in the author's laboratory, and results will be presented later in this survey.

*Electrophoresis*

When dilute starch sols are subjected to electromigration, the presence of non-carbohydrate substances imparts polarity to one or the other of the fractions. In the case of potato starch, the presence of organic phosphate esterified with the B-fraction causes the latter to migrate toward the anode, leaving the A-fraction in the supernatant solution.<sup>13</sup> Corn starch, however, contains fatty acid but very little phosphate. In this case, it appears to be primarily the A-fraction which migrates,<sup>14</sup> due to adsorption of fatty acid. Thus no separation can be effected with defatted corn starch. The use of electrophoresis erroneously assumes that the non-carbohydrate substances which impart polarity are associated solely and uniformly with one component of the starch. Separations are slow and incomplete, with considerable retrogradation. Also, local conditions of acidity or alkalinity may be generated in the starch sol by electrolysis, with consequent degradation of the starch.

*Selective Retrogradation*<sup>15, 16</sup>

When a starch sol is allowed to stand, the A-fraction slowly retrogrades and precipitates from solution. Numerous attempts have been made to effect a fractionation by this means, usually on starches solubilized by hydrolytic action. Several investigators have reported the

<sup>10</sup> Z. Gatin-Gruzewska, *Compt. rend.*, **146**, 540-42 (1908).

<sup>11</sup> M. E. Baldwin, *J. Am. Chem. Soc.*, **52**, 2907-19 (1930).

<sup>12</sup> K. H. Meyer, W. Brentano and P. Bernfeld, *Helv. chim. Acta*, **23**, 845-53 (1940).

<sup>13</sup> M. Samec and H. Haerdtl, *Kolloidchem. Beihefte*, **12**, 281-300 (1920); M. Samec and A. Mayer, *ibid.*, **13**, 272-88 (1921).

<sup>14</sup> T. C. Taylor and H. A. Iddles, *Ind. Eng. Chem.*, **18**, 713-17 (1926).

<sup>15</sup> L. Maquenne, *Compt. rend.*, **137**, 88-90, 797-99 (1903).

<sup>16</sup> Z. Gatin-Gruzewska, *Compt. rend.*, **152**, 785-88 (1911).



slow deposition of crystalline aggregates from autoclaved starch sols. At best, such fractionations are superficial, since the protective colloid effect of the B-fraction impedes precipitation of the A-fraction. Also, considerable co-precipitation occurs.

#### *Selective Adsorption*<sup>17, 18</sup>

When a cold starch sol is treated with adsorbents (usually cotton), the A-fraction is preferentially removed. Subsequently, it may be stripped from the adsorbent with hot water. This method of fractionation involves no chemical degradation and yields a relatively pure B-fraction. However, the A-fraction is apt to be badly contaminated, both with B-fraction and with incompletely dispersed granules. Only small amounts of starch can be processed and quantitative evaluation of the fractions does not appear to be feasible.

#### *Enzymic Methods*

Attempts have been made to estimate the proportion of B-fraction by removal of the A-fraction through hydrolysis with various enzymes.<sup>19</sup> Since it is now recognized that the B-fraction undergoes partial conversion, these estimates are of little value. Treatment of gelatinized cereal starches with certain amylases gives a flocculent precipitate, variously termed "hemicellulose"<sup>20</sup> or "amylocellulose."<sup>21</sup> This appears to be a degraded A-fraction, rendered insoluble through adsorption of fatty acids present in the substratum and also by deterioration of the protective colloid action afforded by the B-fraction.

#### *Selective Precipitation with Polar Organic Substances*

This method has been developed by the author and his associates during the past several years and is believed to afford the two fractions at maximum purity, without chemical degradation or impairment of physical state. The operation and fundamental aspects of the method will be discussed in detail in the present survey.

### III. RECENT CONCEPTS IN STARCH CHEMISTRY

Fractionation studies must be considered as part of a broad program to understand the structure and behavior of starch. Certain general

<sup>17</sup> C. Tanret, *Compt. rend.*, **158**, 1353-56 (1914).

<sup>18</sup> E. Pacsu, *J. Am. Chem. Soc.*, **63**, 1168 (1941).

<sup>19</sup> A. R. Ling and D. R. Nanji, *J. Chem. Soc.*, **123**, 2666-88 (1923).

<sup>20</sup> S. B. Schryver and E. M. Thomas, *Biochem. J.*, **17**, 497-500 (1923).

<sup>21</sup> J. Wolf and A. Fernbach, *Compt. rend.*, **137**, 718-19 (1903); *ibid.*, **138**, 819-21 (1904).

concepts in starch chemistry required clarification before a satisfactory and reliable fractionation could be developed. From the author's viewpoint, the more important elements of this preliminary research were (1) recognition of the role of granule structure in starch pastes, (2) the concept of alkali lability as a measure of starch degradation, (3) clarification of the adsorptive action of starch toward polar organic molecules, and (4) the development of a quantitative evaluation of iodine adsorption.

#### *Persistence of Granule Structure*

When an aqueous starch suspension is heated above the so-called gelatinization temperature, the individual granules undergo progressive swelling until their identity becomes obscure. In the past, it was assumed that the granule swelled beyond its elastic limit, then burst, emptying its interior substance into the substratum in a dissolved state. Earlier investigators attributed the high viscosity of boiled starch pastes to this interior substance. Alsberg<sup>22</sup> has challenged this concept, claiming that the granules still persist as enormously swollen but still intact masses and that paste "viscosity" is due to frictional effects between these swollen granules. This viewpoint seems eminently reasonable, since a gelatinized potato starch paste can be reduced virtually to water-thinness by vigorous shearing action on the swollen granules, as in a colloid mill or in a high-speed mixer such as a Waring "Blendor."

Taylor<sup>23</sup> contended that optimum fractionation could only be realized after complete dissolution of granule structure to give a physically homogeneous starch sol. On this basis, there are two separate phases to the problem of fractionation; first, a satisfactory method for dispersing the starch without chemical degradation and, second, the isolation of one or the other of the starch components from this homogeneous sol.

#### *Alkali Lability*

If starch is composed of linear and branched chains of glucopyranose units, there should be a potential free aldehyde group at one terminus of the molecule. The slight reducing action of starch toward alkaline ferricyanide<sup>24</sup> or copper salts<sup>25</sup> reflects the presence of this terminal aldehyde, though these methods have not had satisfactory quantitative application to starch.

<sup>22</sup> C. L. Alsberg, *Plant Physiology*, **13**, 295-330 (1938).

<sup>23</sup> T. C. Taylor, in "A Comprehensive Survey of Starch Chemistry," edited by R. P. Walton, pp. 62-65. Reinhold Publishing Company, New York (1928).

<sup>24</sup> F. F. Farley and R. M. Hixon, *Ind. Eng. Chem., Anal. Ed.*, **13**, 616-17 (1941).

<sup>25</sup> W. A. Richardson, R. S. Higginbotham and F. D. Farrow, *J. Textile Inst.*, **27**, 131-57 (1936).

Evans and his co-workers<sup>26</sup> have shown that the degradation of an aldose sugar in hot aqueous alkali gives a mixture of formic, acetic and lactic acids. This action is initiated through enolization of terminal aldehyde and subsequent splitting of acidic fragments. If starch is digested in hot dilute sodium hydroxide solution, there is a continuous formation of these simple acids. Since the maltose linkage is not ruptured to any significant degree by hot alkali,<sup>27</sup> it is presumed that the alkaline decomposition proceeds from the terminal aldehyde, progressively destroying the glucose residues in the starch molecule. Taylor<sup>28</sup> has employed this action to exaggerate the presence of terminal aldehyde to the point where it is a measurable quantity. While unmodified starch has vanishing reducing power against hypiodite, the reducing substances generated by hot alkali digestion are determinable and constitute a relative index of aldehyde groups. Thus any starch which has suffered hydrolysis will decompose in hot alkali at a significantly higher rate, due to the greater number of aldehyde groups exposed to attack by alkali.

A simplified alkali lability method has been employed in the author's laboratory,<sup>29</sup> whereby the rate of alkali degradation is estimated from the amount of acidic substances produced by alkali degradation. This is expressed as "alkali number," and represents the ml. of 0.1 *N* acid formed from 1 g. of the starch substance under specified conditions of alkali digestion. It is entirely an arbitrary value, and cannot be construed as an absolute measurement of aldehyde content or of molecular weight. It serves only to indicate whether the aldehyde content of the starch has remained constant, or whether it has increased or decreased. Farley and Hixon<sup>24</sup> have found that the alkali number detects hydrolytic changes in the starch before they are measurable by copper or ferricyanide reduction.

Through alkali lability evaluation, it becomes apparent that chemical degradation is occasioned by many of the methods employed in the past to solubilize the starch preparatory to fractionation. Thus, prolonged dry-grinding of starch in a pebble mill causes a progressive rise in alkali lability and eventually yields a product which is colored red by iodine. It is quite possible that sufficient local heat is generated by impact of

<sup>26</sup> W. L. Evans and Marjorie P. Benoy, *J. Am. Chem. Soc.*, **52**, 294-307 (1930); W. L. Evans, *Chem. Revs.*, **31**, 537-560 (1942).

<sup>27</sup> T. J. Schoch, E. J. Wilson, Jr. and C. S. Hudson, *J. Am. Chem. Soc.*, **64**, 2871-72 (1942).

<sup>28</sup> T. C. Taylor, H. H. Fletcher and M. H. Adams, *Ind. Eng. Chem., Anal. Ed.*, **7**, 321-24 (1935).

<sup>29</sup> T. J. Schoch and C. C. Jensen, *Ind. Eng. Chem., Anal. Ed.*, **12**, 531-32 (1940).

the pebbles to cause dextrinization. However, it appears that some type of hydrolytic or oxidative action is also involved. With large molecules, where the aggregate van der Waals forces may exceed the energy of a primary chemical linkage, it is conceivable that the latter may be "sheared" by purely mechanical means. In this connection, Staudinger and Heuer<sup>29a</sup> have demonstrated the molecular degradation of solid polystyrenes by ball-milling. Cohen<sup>29b</sup> presumes that the dry-grinding of proteins occasions peptide splitting, deamination, and scission of disulfide bonds.

The use of acid-modified starches must likewise be avoided, if the fractions are to be isolated in undegraded state. Heat peptization (as by prolonged boiling or preferably by autoclaving) may be employed to disperse the starch paste to a physically homogeneous sol. However, careful attention must be given to the acidity. Starch pastes may be heated at 100° for eight or ten hours provided the pH of the system is not below 4.4. More rapid and effective dispersion of the granule is achieved by cooking the starch paste in an autoclave under 18–20 lb. pressure. If the pH is maintained within the narrow limits of 5.9–6.3, the alkali number is unchanged.<sup>29</sup> Substantially complete dissolution of granule organization can be effected by autoclaving 1–3% starch pastes for two to three hours under these conditions, as indicated by the attainment of a constant minimum viscosity. This provides an effective and satisfactory method for dispersing the starch preliminary to fractionation.

#### *Adsorption of Polar Materials by Starch*

The instability of starch sols can be traced primarily to the presence of the linear A-fraction. The adsorptive affinity of this component is manifest in all the reactions of starch pastes and sols. It is responsible for retrogradation, the blue coloration with iodine, and the adsorption of various polar materials. The latter reaction has been utilized to effect a quantitative precipitation of the A-fraction. Thus, when a starch sol is treated with polar organic substances containing a hydrophilic group (such as hydroxyl or carboxyl) attached to a hydrophobic residue, the A-fraction adsorbs this material by polar attraction for the hydrophilic group. The resulting adsorption complex is insoluble by reason of its hydrophobic loading and consequently separates from solution.

For a long time, these adsorption effects of starch were misconstrued. This was particularly evident in the case of the fatty acids associated with the cereal starches. Taylor and Iddles<sup>14</sup> observed that corn, wheat

<sup>29a</sup> H. Staudinger and W. Heuer, *Ber.*, **67B**, 1159–64 (1934).

<sup>29b</sup> H. R. Cohen, *Arch. Biochem.*, **4**, 145–50, 151–54 (1944).

and rice starches contain lipid material which cannot be removed by extraction with the usual fat solvents such as ether and carbon tetrachloride. When dispersions of these starches are ultra-filtered or electromigrated, the A-fraction is obtained as an insoluble product, partly by reason of its adsorption of lipid material and partly because of retrogradation. It was therefore assumed that this fraction was a carbohydrate fatty ester.

This misconception was clarified when it was found that the fatty material could be removed from starch by extraction with fat solvents which possess sufficient hydrophilic loading (e.g., the lower aliphatic alcohols, aqueous dioxane, the Cellosolves, etc.).<sup>30</sup> Thus starch adsorbs methanol and simultaneously discharges the associated fatty acids, which can then be removed by the extractant. *It is imperative that all cereal starches should be exhaustively defatted before use in any fundamental studies.* Standard practice in the author's laboratory is to reflux the starch for several hours with 85% methanol, five such extractions reducing the lipid content to the vanishing point. Although these fatty materials constitute only 0.5–0.8% of the cereal starches, their removal markedly alters the character of the starch. Pastes of the defatted starches are less opaque, more readily dispersed and exhibit greater gel strength than those of the corresponding raw cereal starch. As will be shown, the action of this small amount of fatty acid is to bind a considerable portion of the A-fraction as an insoluble complex.

Starch likewise adsorbs fatty acid from an alcohol medium but not from a hydrocarbon medium,<sup>30</sup> and Lehrman<sup>31</sup> has shown that this action follows a typical Freundlich adsorption isotherm. It is possible that fatty acid can be carried into the interior of the granule only by those solvents which are sufficiently hydrophilic to penetrate the carbohydrate lattice; or the mechanism may involve the replacement of adsorbed water in the granule by alcohol, and the subsequent replacement of this alcohol by fatty acid.

These effects suggest that the A-fraction may be preferentially separated from the sol state through adsorption of certain polar materials. Obviously, if this component is to be recovered as an insoluble precipitate, the granule must be completely dispersed, as by autoclaving. This constitutes the essence of an improved fractionation technique.

#### *Iodine Adsorption*

At least in theory, the specific color reactions of the several starch components toward iodine have long been recognized. However iso-

<sup>30</sup> T. J. Schoch, *J. Am. Chem. Soc.*, **64**, 2954–56 (1942).

<sup>31</sup> L. Lehrman, *J. Am. Chem. Soc.*, **64**, 2144–46 (1942).

lated, the A-fraction gave an intense blue coloration with iodine, while the B-fraction reputedly tended toward the black or purple. It has been variously assumed that the blue color was due to definite compound formation, or to some type of adsorption complex, or to a solid solution of iodine in the A-fraction.<sup>31a</sup>

Previously, the degree of affinity between starch and iodine could only be approximated from the depth of the blue color produced. Bates, French and Rundle<sup>32</sup> have recently developed a potentiometric technique which affords an accurate quantitative evaluation of the iodine adsorbed by starch and its various derivatives. In brief, the starch sample is dissolved in dilute potassium hydroxide solution, then neutralized with hydriodic acid and titrated potentiometrically with a solution of iodine and potassium iodide. By plotting the potential of the system against the iodine titer, or preferably by calculating and plotting free iodine against adsorbed iodine, the iodine affinity of the starch sample can be precisely determined. Several modifications of this technique have been suggested. It is somewhat more convenient to neutralize the alkaline starch solution with hydrochloric acid, then titrate with a solution containing iodine, potassium iodide and potassium chloride.<sup>33</sup> Low results will be obtained if the starch does not dissolve to a perfectly limpid solution in the alkali. Difficulty may be encountered with unmodified starches, since these swell in the alkaline medium without complete solution. This can be avoided by autoclaving the sample in distilled water, then cooling and treating with alkali in the usual manner.<sup>34</sup> It is also important that no other materials be present which are capable of being adsorbed on the starch, since these will prevent the adsorption of iodine.<sup>34a</sup> This is particularly true of the fatty acids normally associated with the cereal starches; hence the starch must be exhaustively defatted before analysis, most conveniently by Soxhlet-extraction with the constant-boiling mixture of 81% dioxane and 19% water.

These values represent the amount of iodine adsorbed by the starch under the conditions of the test, in the presence of fixed concentrations

<sup>31a</sup> Dr. H. T. Beans of Columbia University has advised the author of the use of A-fraction as an indicator in iodometry. The indicator solution (prepared by dissolving 0.5% of recrystallized A-fraction in 15% potassium chloride solution) is stable over long periods of time and is immune to mold growth. It is highly sensitive toward iodine and affords sharp end points, without the reddish colorations characteristic of most soluble starches.

<sup>32</sup> F. L. Bates, D. French and R. E. Rundle, *J. Am. Chem. Soc.*, **65**, 142-48 (1943).

<sup>33</sup> E. J. Wilson, Jr., T. J. Schoch and C. S. Hudson, *J. Am. Chem. Soc.*, **65**, 1380-83 (1943).

<sup>34</sup> T. J. Schoch, C. B. Williams and N. F. Schink, to be published.

<sup>34a</sup> T. J. Schoch and C. B. Williams, *J. Am. Chem. Soc.*, **66**, 1232 (1944).

of potassium iodide and chloride. While the method is arbitrary, it affords a valuable and unique index for differentiating the starch fractions and determining their relative purity.

#### IV. FRACTIONATION BY SELECTIVE PRECIPITATION

When a cold, dilute, autoclaved starch sol is overlaid with *n*-butyl alcohol, a cloudiness develops in the aqueous sol at the alcohol interface. Eventually, a microcrystalline precipitate settles out, appearing as minute "dumb-bell" shaped particles under the microscope. The particle size can be substantially increased by slowly cooling a hot starch sol in contact with butyl alcohol, in which case the precipitate appears as slender needles, or more usually as birefringent six-petalled crystalline rosettes, some 15–50 microns in diameter with corn starch and 50–80 microns with potato starch. This is the A-fraction.

The formation of crystalline precipitates from starch sols by treatment with alcohol has been repeatedly mentioned in the literature. Alsberg<sup>35</sup> describes birefringent crystal clusters obtained in this manner from autoclaved starch sols. Wiegel<sup>36</sup> has recently reported crystalline formations obtained by treating starch pastes with various aliphatic alcohols, dioxane or ethylene chloride. However, the significance of these crystalline formations as a definite starch component has not been generally recognized, and little attempt has been made to isolate and purify this material.

As originally reported,<sup>37</sup> selective precipitation of the A-fraction was accomplished by saturating a starch paste with butyl alcohol, then autoclaving for 2–3 hours at 18–20 lb. pressure. On cooling to room temperature, the A-fraction separated in characteristic crystalline form and could be collected by supercentrifuging. The yield was 22–23% from either corn or potato starch. The iodine adsorption of the crude precipitated A-fraction was 16.5%; for the non-precipitated B-fraction it was 1.5–1.7%.

It was recognized that other alcohols might likewise effect a separation of starch components. Development of the iodine adsorption analysis has made it possible to evaluate the effectiveness of other precipitants as fractionating agents. According to recent tests,<sup>34</sup> almost any monohydroxy alcohol will accomplish a separation under suitable conditions, and several of these are preferred to butyl alcohol. It is difficult to assign relative fractionating efficiencies to the various alcohols, since the

<sup>35</sup> C. L. Alsberg, *Proc. Soc. Exptl. Biol. Med.*, **23**, 728–30 (1926); see also H. G. Bungenberg de Jong, *Proc. Acad. Sci. Amsterdam*, **38**, 426–34 (1935).

<sup>36</sup> E. Wiegel, *Z. physik. Chem.*, **A188**, 137–59 (1941); *Kolloid-Z.*, **102**, 145–54 (1943).

<sup>37</sup> T. J. Schoch, *J. Am. Chem. Soc.*, **64**, 2957–61 (1942).

purity and recovery of each of the fractions must be considered independently. As an arbitrary classification, the alcohols may be rated in the following manner:

Preferred: *n*-amyl alcohol, Pentasol<sup>38</sup>

Excellent: *n*-propyl alcohol (30% by volume aqueous solution), *n*-hexyl alcohol, 2-ethyl-1-butanol, 2-ethyl-1-hexanol, lauryl alcohol, cyclohexanol

Good: *n*-propyl alcohol (20%), *n*-butyl alcohol, 3-pentanol, 4-methyl-2-pentanol, *dl*-borneol,  $\alpha$ -terpineol

Fair: *n*-propyl alcohol (40%), isobutyl alcohol, *sec.*-butyl alcohol, 2-methyl-1-butanol, isoamyl alcohol, *tert.*-amyl alcohol, menthol

Poor: ethyl alcohol (30%), benzyl alcohol

Of these, Pentasol gives optimum results and is employed in the author's laboratory as a standard fractionating agent. The various amyl alcohols develop acidity during autoclaving, possibly from traces of chloropentanes in the alcohol. It is therefore necessary to add these precipitants to the starch sol after the autoclaving operation. In fractionating the various cereal starches, it is important to use defatted starch, since the presence of fatty acid markedly interferes with granule swelling and disintegration. Also, the acidity imparted by the fatty acid is sufficient to hydrolyze the starch during autoclaving.

While specifically developed for fractionating corn starch with Pentasol, the following procedure<sup>34</sup> is applicable to any starch and to any of the precipitants indicated above:

A 2-3% suspension of defatted corn starch is gelatinized on the steam-bath, then autoclaved for three hours at 18-20 lb. pressure. The pH before and after autoclaving should be between 5.9-6.3. Subsequent to autoclaving, the hot starch sol may be passed through a Sharples or DeLaval continuous-flow supercentrifuge, to remove traces of cellular material and impurities. These should not exceed 0.5% of the starch. To the hot sol is then added 10% by volume of Pentasol, and the mixture allowed to cool slowly to room temperature. Especially with the less soluble alcohols, it is necessary to stir the mixture continuously during the cooling period, to insure intimate contact between the alcohol and the starch sol. Subsequent refrigeration may be advantageous. The A-fraction separates as rosettes or needle clusters, which may be collected with the supercentrifuge. The yield of crude A-fraction from corn starch is 28-29%, and its iodine adsorption is 16.3-16.5%. The non-precipitated B-fraction may be recovered from the centrifugate by flocculation with excess methanol, then dehydrated with fresh methanol, filtered, and dried. Its iodine adsorption is only 0.5-0.8%. This represents a purity of 96-97%, substantially better than can be accomplished with butyl alcohol.

<sup>38</sup> This is a commercial mixture of various primary amyl alcohols, marketed by Sharples Solvents Corporation. The mixture is more effective as a starch fractionating agent than any of the components alone.



The moist A-fraction as removed from the rotor of the supercentrifuge can be washed by suspension in cold water saturated with butyl alcohol, without impairing its crystalline character. If treated with cold water alone, it loses its optical birefringence and gives insoluble lumps and clots. However, it dissolves readily in boiling water, such solutions giving hard irreversible gels when cooled to room temperature, even at concentrations as low as 1.5%. The crude A-fraction may be recrystallized as minute flat plates by dissolving in boiling water and cooling in the presence of butyl alcohol. Further recrystallizations accomplish a slight additional purification as judged by iodine adsorption. In one specific instance, the crude Pentasol precipitated A-fraction adsorbed 16.5% iodine; successive recrystallizations with butyl alcohol gave values of 18.4%, 18.8%, 18.8%, and 19.0%. If the moist A-fraction is oven-dried, it loses its solubility in hot water, presumably by retrogradation in the presence of moisture. If the product is thoroughly dehydrated by successive treatments with methanol, then dried in the vacuum oven, it retains its crystallinity and its solubility in hot water.<sup>34</sup>

The yields of A-fraction by the above method are substantially higher than the 22–23% previously reported by butyl alcohol fractionation, since the latter method does not give as complete a separation. From the iodine adsorption of raw corn starch and of the purified A-fraction, Bates, French and Rundle<sup>32</sup> have calculated the content of A-fraction in corn starch as 22%. This low value is due to the use of incompletely defatted starch, and its agreement with the yield by butyl alcohol precipitation is purely coincidental. Under preferred methods of testing, exhaustively defatted corn starch adsorbs 5.3% iodine. Dividing this latter value by the 19.0% iodine adsorption for the recrystallized A-fraction, a theoretical content of 28% is calculated for corn starch, in agreement with the yields by Pentasol fractionation.

The A-fraction can be separated most satisfactorily by supercentrifugal equipment. Precipitation with mixed butyl and isoamyl alcohols permits separation at ordinary centrifuge speeds.<sup>33</sup> However, this variation is somewhat tedious and is limited to relatively small quantities.

No satisfactory method has been found for removing the 3–4% of A-fraction presumably remaining in the Pentasol non-precipitated B-fraction. Bates, French and Rundle<sup>32</sup> have suggested that this may be removed by repeated treatment with cotton. Attempts to apply this purification have not been successful. Various grades of cotton, cellulose pulp, charcoal, activated alumina, precipitated aluminum hydroxide, bentonite and fuller's earth have been tested, without any significant improvement in the purity of the B-fraction.<sup>34</sup> It is possible that Rundle's cotton treatment may introduce traces of lipid material (fatty acids or sterols) which mask the iodine adsorption.

Several other starches have been fractionated, though the results must be considered as preliminary. Thus butyl alcohol gives 21% of

crude precipitated A-fraction from tapioca starch, somewhat higher than the theoretical content of 18%, as calculated from the iodine adsorptions of 3.30% and 18.6% for raw tapioca starch and its twice-recrystallized A-fraction, respectively. Rundle and co-workers<sup>32</sup> have recently estimated 32% A-fraction in the starch from Easter lily bulbs. While this starch possesses high iodine adsorption (6.35%), Pentasol fractionation gives only 25% of precipitated A-fraction.<sup>34</sup> A careful survey must be made of the various starches, to establish the content and iodine adsorption of the A-fraction in each case, by the best procedure now available. It is thought that the various starches may differ not only in their content of A-fraction, but likewise in the ultimate iodine adsorption of that fraction.

Starches from the so-called waxy or glutinous cereals are characterized by the production of a red color with iodine. Waxy maize and waxy sorghum are the principal domestic examples of this genetic variety, and these starches have received considerable attention by reason of their stability and freedom from retrogradation.<sup>39,40</sup> The iodine adsorption of waxy maize starch is negligible,<sup>32</sup> and it has been suggested that this starch is composed entirely of branched carbohydrate, organized into typical starch granules. This is confirmed by the absence of any precipitate with butyl alcohol or Pentasol.

The use of autoclaving to effect dispersion of the starch has been criticized on the grounds that it may occasion some sort of hydrolytic degradation. No apparent change is occasioned if the starch is maintained within the proper pH limits. Moreover, the separate fractions may be subjected to prolonged autoclaving without change in viscosity, iodine adsorption or alkali lability. Potato starch can be dissolved by stirring for several days in 5% potassium hydroxide solution (as suggested by C. S. Hudson), then neutralized and fractionated with butyl alcohol.<sup>34</sup> While some alkaline degradation probably occurs, the separate fractions so obtained correspond in quantity and properties with those derived from autoclaved sols.

## V. FRACTIONATION BY AQUEOUS LEACHING

Recently, K. H. Meyer and his co-workers<sup>12,41</sup> have discussed the constitution of starch and the molecular structures of the fractions. Their method of fractionation involves successive leaching of corn starch

<sup>39</sup> R. M. Hixon and G. F. Sprague, *Ind. Eng. Chem.*, **34**, 959-62 (1942).

<sup>40</sup> H. H. Schopmeyer, G. E. Felton and C. L. Ford, *Ind. Eng. Chem.*, **35**, 1168-72 (1943).

<sup>41</sup> K. H. Meyer, in "Advances in Colloid Science," pp. 143-82. Interscience Publishers, New York (1942).

at 70°, just above the gelatinization temperature. This dissolves the A-fraction (Meyer's "Amylose") from the swollen granule, leaving the B-fraction as the insoluble residue (Meyer's "Amylopectin"). Since this method has been employed more widely than any other for the separation of starch components, a careful study of various leaching procedures was made, to compare their relative efficiencies with butanol and Pentasol precipitation.<sup>34</sup> Iodine adsorption provides a suitable basis for comparison.

Defatted corn starch was employed, since the presence of fatty acid markedly impedes solution and extraction of the A-fraction. A 2.5% aqueous suspension of the starch was heated to the indicated temperature and maintained at that point for one hour, with gentle stirring to keep the swollen granules suspended without producing mechanical disintegration. The paste was then centrifuged, the supernatant solution decanted, and the residue of swollen granules similarly extracted three additional times with fresh portions of water. This sufficed to remove all soluble material. The insoluble residue and the combined soluble extracts were recovered by alcohol precipitation and analyzed for iodine adsorption. Duplicate runs showed excellent agreement.

<i>Extraction Temperature</i>	<i>Yield of Solubles, %</i>	<i>Iodine Adsorption</i>		<i>Fractionation Efficiency<sup>b</sup></i>
		<i>Solubles</i>	<i>Residue<sup>a</sup></i>	
70°	14.3	14.3	2.98	39%
75°	18.3	14.5	2.52	50%
80°	20.9	13.9	2.22	55%
85°	25.8	12.0	1.98	58%
90°	27.1	12.4	1.79	63%

<sup>a</sup> These samples could not be completely dissolved in alkali, due to retrogradation of unremoved A-fraction. Consequently, their iodine adsorption values are undoubtedly low.

<sup>b</sup> Fractionation efficiency represents the percentage of the total A-fraction recovered in the soluble extract. It is calculated as  $[(\% \text{ yield of A-fraction} \times \text{iodine adsorption of A-fraction}) + 5.3]$ , where 5.3 is the iodine adsorption of defatted corn starch.

Yields of the A-fraction by leaching at 70° agree with figures reported by Meyer, Brentano and Bernfeld.<sup>12</sup> It appears that this mode of fractionation effects only a partial separation of the starch components. The soluble material is rather badly contaminated by B-fraction, especially at higher extraction temperatures.<sup>42</sup> Correspondingly, a considerable portion of the A-fraction retrogrades to the insoluble condition and resists removal from the swollen residue. In comparison, fractionation

<sup>a</sup> By  $\beta$ -amylase conversion studies, R. W. Kerr of this laboratory has reached similar conclusions regarding the effectiveness of aqueous leaching methods.

by butyl alcohol and by Pentasol precipitation can be rated as 72% and 90% efficient, respectively.

Kerr and Severson<sup>43</sup> have superimposed selective precipitation on aqueous extraction technique, by treating the soluble extract with butyl alcohol. This gives an A-fraction (designated by Kerr as "crystalline amylose") of exceptionally high iodine adsorption, but in yields amounting to only 5–6% of the starch. The products from corn and tapioca starches analyze 20.5% and 20.7% iodine adsorption respectively, as compared with a maximum value of 19.0% after four recrystallizations of the Pentasol-precipitated A-fraction from corn starch. This suggests that the A-fraction may be somewhat diversified in molecular size, and that aqueous extraction preferentially dissolves the shorter linear chains. It is not to be expected that all the molecules of a natural high polymer should be of uniform size.

Wiegel<sup>36</sup> has reported the isolation of A-fraction in approximately 10% yield by leaching potato starch with boiling 30–35% ethyl alcohol. On treating the soluble extract with such precipitants as butyl or isobutyl alcohol, the A-fraction separates in characteristic crystalline form.

The action of various alcohol adjuncts on aqueous leaching of the A-fraction has been studied in the author's laboratory. In the presence of certain specific amounts of the lower aliphatic alcohols, the degree of granule swelling is increased and the gelatinization temperature is substantially lowered. Reverse effects have been observed at higher alcohol concentrations. However, separation of starch components is not improved by use of such adjuncts. Thus, extraction of corn starch at 60° in the presence of 10% butyl alcohol parallels extraction in hot water at 85°. Higher alcohols such as lauryl alcohol or cyclohexanol restrict granule swelling and prevent solution of the A-fraction. For example, when a starch suspension was gelatinized and autoclaved in the presence of cyclohexanol, then centrifuged hot, only 11% of the starch substance was rendered soluble, and this product adsorbed only 1.28% iodine. Thus it is the B-fraction which is preferentially extracted in the presence of cyclohexanol. Where higher alcohols were used for selective precipitation of the A-fraction, they were added subsequent to autoclaving and hence the granule structure had already been disaggregated.

## VI. PROPERTIES AND STRUCTURES OF THE FRACTIONS

### *Solubility and Retrogradation*

The solubility of the several starch components is determined not only by their respective structural configurations, but also by the associa-

<sup>43</sup> R. W. Kerr and G. M. Severson, *J. Am. Chem. Soc.*, **65**, 193–98 (1943).

tive forces operating between the individual molecules and between the carbohydrate and the dispersion medium. Thus, it is impossible to characterize either fraction as the more soluble or less soluble component, since its behavior will depend on circumstances.

K. H. Meyer<sup>41</sup> has regarded the A-fraction as a linear chain polymer of some 200 glucose units. By reason of its extended length and its high content of hydrophilic groups, such a molecule sets up a zone of attractive influence for hydrophilic substances. It is immaterial whether these forces are labelled secondary valence, hydrogen bonding, or molecular cohesion forces—the distinctions are vague. These linear molecules are presumed to aggregate in parallelwise fashion, until the resulting particle exceeds colloidal dimensions and precipitates from solution. This is considered as retrogradation. It is a relatively slow process, occurring over a period of hours or days. In contrast, gelation of a solution of the A-fraction is rapid and might be attributed to the formation of an interlacing network of randomly oriented linear molecules. When a solution of the A-fraction is cooled, it gels as soon as the kinetic energy of the linear molecules is sufficiently reduced to permit points of contact. C. B. Purves has suggested that water may be involved in this association, as a sort of intermolecular bridge of the type  $-\text{CH}_2\text{OH}\cdots\text{HOH}\cdots\text{HOCH}_2-$ .

When an aqueous solution of the A-fraction is cooled in contact with butyl alcohol, it satisfies its associative tendencies through the formation of an alcoholate. Since butyl alcohol is probably adsorbed via its hydroxyl group, the alcoholate then presents a hydrophobic surface to the medium and precipitates from solution.<sup>42a</sup> The crystalline precipitate can be washed with cold water saturated with butyl alcohol, since this will not dissolve alcohol from the alcoholate and therefore does not disturb the crystal lattice. When the crystals are dried in the absence of water, the crystal structure is frozen without the establishment of intermolecular bonding. Consequently, the product can be dissolved in hot water. With cold water, the molecules immediately associate to give an insoluble gel.

The B-fraction is conceived as a ramified molecule branched either in an orderly pattern or else in random "maple tree" fashion.<sup>41</sup> In

<sup>42a</sup> Unpublished work by R. L. Whistler and G. E. Hilbert shows that the linear component of starch can be precipitated in microcrystalline form by a wide variety of reagents, including various fatty acids, esters, ketones, and nitro-compounds. Nitrobenzene is preferred for routine separations. The fractionation technique employed is similar to that described for butyl alcohol, and the yield of precipitated fraction from corn starch runs 26–29%. To explain the selective precipitation of the linear component, these investigators presume a simple association through hydrogen bonding with the polar reagent, the latter acting as electron donor.

neither case could the molecules line up parallelwise, nor would the associative forces be dominant. Hence this fraction should exhibit little tendency to retrograde. However, the persistence of granule structure in gelatinized pastes (especially of the waxy starches) would indicate some type of cohesion between the branched molecules, perhaps merely by mechanical enmeshment of the branches. Thus a starch sol may be considered as a solution of the unstable A-fraction peptized by the presence of the colloiddally stable B-fraction.

### *X-Ray Diffraction*

The application of X-ray methods to starch is complicated by the variety of diffraction patterns obtained, depending on the physical condition and treatment of the sample. Katz<sup>44</sup> has described the so-called "A" and "B" patterns, characteristic of cereal and tuber starches respectively, either in granular or retrograded state. The significance of these diagrams is uncertain, and it can only be stated that they represent an orderly packing of the starch molecules. While the diffused and characteristically amorphous pattern of glycogen is attributed to a highly branched configuration, waxy maize starch gives a strong "A" type diffraction.<sup>45</sup>

The "V" diagram is obtained only with the A-fraction in complex formation with iodine or such precipitants as butyl alcohol. Bear<sup>46</sup> and also Rundle and his coworkers<sup>47</sup> attribute this pattern specifically to a helical configuration of the A-fraction, with iodine or butyl alcohol located inside the helix, as suggested by Hanes<sup>48</sup> and by Freudenberg and coworkers.<sup>49</sup> Unit cell dimensions derived from diffraction data agree with values computed for a helix containing six glucose residues per turn. While the butyl alcohol molecule might fit within such a helix, it is questionable whether such varied precipitants as oleic acid, terpineol, or lauryl alcohol could be similarly accommodated. At least in the case of the crystalline alcohol complexes, surface adsorption of oriented polar molecules offers a simple and adequate explanation.

It is significant that no "V" diagram is obtained with ungelatinized granules or with retrograded starch. Hence Rundle presumes that the

<sup>44</sup> J. R. Katz and Th. B. van Itallie, *Z. physik. Chem.*, A 150, 90-99 (1930); J. R. Katz and J. C. Derksen, *ibid.*, A 167, 129-36 (1933).

<sup>46</sup> R. S. Bear and D. French, *J. Am. Chem. Soc.*, 63, 2298-2305 (1941).

<sup>47</sup> R. S. Bear, *J. Am. Chem. Soc.*, 64, 1388-92 (1942).

<sup>48</sup> R. E. Rundle and D. French, *J. Am. Chem. Soc.*, 65, 1707-10 (1943); R. E. Rundle and F. C. Edwards, *ibid.*, 65, 2200-3 (1943).

<sup>49</sup> C. S. Hanes, *New Phytologist*, 36, 101-41, 189-239 (1937).

<sup>49</sup> K. Freudenberg, E. Schaaf, G. Dumpert and T. Ploetz, *Naturwissenschaften*, 27, 850-53 (1939).

linear A-fraction must be normally stretched or extended, assuming a helical configuration only in the presence of iodine or alcohol precipitants.

As further evidence of the linear character of the A-fraction, Whistler and Schieltz<sup>60</sup> have shown that stretched films of its triacetate give typical fiber patterns on X-ray analysis. This is the first reported instance of oriented fiber structure from starch.

#### *Dichroism of Flow*

Rundle and Baldwin<sup>61</sup> have shown that solutions of the iodine complex of the A-fraction exhibit dichroism when subjected to high speed shearing action. This phenomenon is associated with rod-like molecules, orienting in the direction of flow, as logs in a rapidly flowing stream. Neither the B-fraction, nor waxy maize, nor glycogen shows this effect, presumably because of their irregular branched structure.

Rundle and Baldwin attribute the dichroism to a helical coiling of the A-fraction around iodine, in such fashion that the long axis of the iodine molecule coincides with that of the helix. Freudenberg and co-workers<sup>62</sup> have suggested that the interior surface of the helix may be hydrophobic in character and hence the iodine assumes the violet or purple colorations characteristic of its solution in hydrocarbon media. This similarity may be fortuitous, since numerous unrelated substances give purple or blue colorations with iodine,<sup>62</sup> including cellulose in zinc chloride solution and polyvinyl alcohol; in these cases helical configurations do not appear probable.

#### *Viscosity*

The solution viscosity of the B-fraction is substantially higher than that of the A-fraction. Coupled with sedimentation data and alkali lability, it appears fairly certain that the branched component possesses a higher molecular weight than the linear fraction.

Viscosity has undoubtedly been over-emphasized as a tool in starch research. Greatly swollen granule fragments, supermolecular aggregates and hydration effects have all conspired to give fictitiously high viscosities. If the molecular weights and limiting viscosities ( $\eta_{sp}/C$  extrapolated to zero concentration) are known for a homologous series of chain polymers, then the molecular weight for any intermediate member can be derived by interpolation. Obviously, it is not possible to set

<sup>60</sup> R. L. Whistler and N. C. Schieltz, *J. Am. Chem. Soc.*, **65**, 1436-37 (1943).

<sup>61</sup> R. E. Rundle and R. R. Baldwin, *J. Am. Chem. Soc.*, **65**, 554-58 (1943).

<sup>62</sup> G. Barger, "Some Applications of Organic Chemistry to Biology and Medicine." McGraw-Hill Book Co., New York (1930).

up such standards for the linear starch fraction. However, Foster and Hixon<sup>33</sup> have employed the limiting viscosities in ethylenediamine solution to compare the chain lengths of the A-fractions from various starches. Thus, potato starch may be presumed to have the longest linear fraction, tapioca intermediate, and corn the shortest. These comparisons are valid only if each A-fraction is composed of relatively uniform linear molecules.

#### *Ultracentrifuge Studies*

Beckmann and coworkers<sup>34</sup> have utilized ultracentrifugal methods to evaluate particle weights of the fractions obtained by hot water extraction of corn starch. Sedimentations were conducted on the acetates in methyl acetate medium. Sedimentation constants of the soluble A-fraction indicate a particle weight of 88,000 (a degree of polymerization of 540). The insoluble residue appeared to contain two substances, one of 400,000–700,000 particle weight (D.P. = 3400), the other of 3,000,000–11,000,000 particle weight (D.P. = 43,000). In the opinion of the author, these high particle weights are suggestive of aggregation. Hot water extraction permits retrogradation and affords only a partial separation; these factors may possibly carry over to the acetylated fractions.

#### *Alkali Lability*

Alkali lability supplied the first positive evidence of chemical differences between the starch fractions as separated by butyl alcohol.<sup>37</sup> The alkali number of defatted corn starch is 10–11; values for the crude A and B fractions are 25 and 5.5, respectively. The observed alkali lability of the original starch coincides with the value calculated from the percentage composition and alkali numbers of the individual fractions (viz.,  $23\% \times 25 + 77\% \times 5.5 = 10$ ). These values are in agreement with the presumed structure of the A and B fractions as linear and branched glucose polymers respectively. Alkali decomposition of the A-fraction should be more extensive than with the B-fraction, since the latter possesses a lower aldehyde content. Also, a branched structure may impede the decomposition in hot alkali.

Potato starch has an alkali number of approximately 7 while values for the A and B fractions are 10 and 6, respectively. Hence there must be positive structural differences between the A-fractions of corn and potato starches. Alkali lability and ferricyanide reducing values indicate a larger molecular weight for the linear component of potato starch.

<sup>33</sup> J. F. Foster and R. M. Hixon, *J. Am. Chem. Soc.*, **65**, 618–22 (1943).

<sup>34</sup> T. G. Fox, Jr. and C. O. Beckmann: Paper presented at the Pittsburgh meeting of the American Chemical Society, September, 1943.



This is in agreement with evidence from viscosity data. With increasing chain length, it might be expected that the A-fraction would possess greater gelation and retrogradation tendencies. But potato and tapioca starches and their A-fractions are less prone to retrograde than is corn starch. Several possible explanations can be advanced for this anomalous behavior. Kerr<sup>55</sup> has suggested that the A-fractions from potato and especially tapioca starches may deviate slightly from true linearity, as by a forked or "V" configuration. Anomalous viscosity and gelation behavior may possibly be due to distribution of molecular lengths. Thus a linear polymer of uniform molecular length might exhibit a lower viscosity and higher gelation than a highly diverse mixture of chain lengths having the same average molecular size.

### *Hydrolysis*

As measured by ferricyanide reducing values, the rates of acid hydrolysis of the A-fractions from either corn or potato starch are slightly but consistently higher than those of the corresponding B-fractions. Reducing values of the fractions isolated by butyl alcohol separation of acid-modified, thin-boiling starches also indicate that the A-fraction is hydrolyzed somewhat more rapidly. It is a matter of speculation whether this is due to the presence of resistant types of glucosidic linkages in the B-fraction, or whether the spatial complexity of the latter somehow impedes hydrolytic scission.

### *Methylation*

Haworth's classical methylation assay of starch indicated that one in every 25 glucose residues was an end-group, possessing free hydroxyls on carbon 4. This was originally interpreted as representing a molecular weight corresponding to 25 glucose units. However, each molecule of the branched fraction must contain a number of end-groups, while the linear molecule should contain only one. Through methylation analysis of the "amylose" and "amylopectin" obtained by electrophoresis of potato starch sols, Hess and Krajnc<sup>56</sup> estimated 0.42% and 4.3% of end-groups respectively. Hassid and McCready<sup>57</sup> have obtained similar values. For the "amylose" and "amylopectin" obtained by leaching corn starch at 70°, Meyer, Wertheim and Bernfeld<sup>58</sup> estimated 0.32% and 3.7% of end-groups respectively. These results probably constitute the

<sup>55</sup> R. W. Kerr, *Paper Trade J.*, Dec. 3, 1942.

<sup>56</sup> K. Hess and B. Krajnc, *Ber.*, **73 B**, 976-9 (1940).

<sup>57</sup> W. Z. Hassid and R. M. McCready, *J. Am. Chem. Soc.*, **65**, 1157-61 (1943).

<sup>58</sup> K. H. Meyer, M. Wertheim and P. Bernfeld, *Helv. Chim. Acta*, **23**, 865-75 (1940).

most substantial evidence for linear and branched configuration, especially when considered in conjunction with alkali lability and viscosity. However, these methylation results must not be considered as final, since the fractions were far from pure. The presence of relatively small amounts of B-fraction would greatly disturb the end-group assay of the linear component. There is profound need for precise methylation data on the purified Pentasol-separated fractions.

Considerable discussion has arisen over the significance of dimethylglucose occurring in the hydrolyzate of fully methylated starch. This material might arise from those glucose residues which participate in branching, or it might be due to incomplete methylation or to demethylation. This point likewise could be clarified by methylation of the purified fractions. If an absolute method could be devised for evaluating terminal aldehyde, then the degree of branching might be determined from the ratio of non-aldehydic end-groups to terminal aldehyde content.

#### *Conversion with $\beta$ -Amylase*

Maquenne and Roux<sup>59</sup> originally proposed the convertibility with diastase to differentiate between the fractions. Presumably, the amylase attacks the non-aldehydic end of the linear component, progressively splitting maltose units until the chain is completely destroyed. Thus the yield of maltose should be substantially 100%. In the case of the branched component, amylolytic action is presumably stopped at the point of branching, leaving an unattacked residue of "limit dextrin."<sup>60</sup> By mathematical probability, half of the total carbohydrate substance of the branched component should be protected behind points of branching. Thus the yields of maltose and limit dextrin should each approximate 50%, either with regular or with random types of branching. Tests on the several fractions have been complicated by contamination with other and less specific enzymes and by the fact that pure starch fractions were not available. However, the yield of maltose approaches 100% from the A-fraction<sup>48</sup> and approximates 52–54% from the B-fraction.<sup>55, 61, 62</sup>

#### *Schardinger Dextrins*

The several nonreducing crystalline dextrins obtained by Schardinger through the action of *B. macerans* on starch have long been a source of

<sup>59</sup> L. Maquenne and E. Roux, *Compt. rend.*, **140**, 1303–8 (1905).

<sup>60</sup> K. Freudenberg, W. Kuhn, W. Dürr, F. Bolz and G. Steinbrunn, *Ber.*, **63**, 1530 (1930); K. Freudenberg, *J. Soc. Chem. Ind.*, **50**, T287–94 (1931).

<sup>61</sup> K. H. Meyer and P. Bernfeld, *Helv. Chim. Acta*, **23**, 875–85 (1940).

<sup>62</sup> R. M. McCready and W. Z. Hassid, *J. Am. Chem. Soc.*, **65**, 1154–57 (1943).

speculation, both as regards their structure as well as the mechanism of their formation. By use of the enzyme of *B. macerans*, Tilden and Hudson<sup>63</sup> greatly increased the yields of these products from starch. Freudenberg and coworkers<sup>69</sup> have proposed cyclic structures for the principal alpha and beta dextrins, containing five and six  $\alpha$ -glucopyranoside groups respectively. From X-ray evidence, French and Rundle<sup>64</sup> have estimated six and seven glucose residues per ring.

Kerr<sup>65</sup> has found that highly purified A-fraction ("crystalline amylose") will yield as much as 70% of Schardinger dextrin, the latter being estimated as the crude product precipitated from the digest by trichloroethylene. This same A-fraction gives 93% maltose by beta-amylase conversion. On the assumption that these amylases act from the non-reducing terminus of the starch molecule and that their action is blocked by the presence of side-chains, then the A-fraction should be of relatively linear character. Further studies<sup>38</sup> confirm the high yield of Schardinger dextrin (69–72%) from the A-fractions of corn and potato starches, as separated by butyl alcohol precipitation. In contrast, the B-fractions of these starches give only 47–51% of crude Schardinger dextrin, and waxy maize (comprised solely of branched-chain carbohydrate) gives 43%. The limit dextrins (or unconverted residues) from *B. macerans* conversion of the A and B fractions amount to 10% and 43% respectively.

While the enzymic approach must be refined and rationalized, present evidence is completely in accord with the concept of linear and branched structures for the two starch components. The theory has been advanced that the individual alpha and beta Schardinger dextrins originate from specific starch fractions, but this appears to be untenable. No satisfactory mechanism has been proposed to account for the production of the several crystalline dextrins.

#### *Synthetic Starch and the Role of Phosphorus*

Samec and coworkers<sup>13</sup> have differentiated between the fractions on the basis of phosphorus content. Undoubtedly, organic phosphate is associated primarily with the B-fraction of potato starch, contributing polarity to that component. In the case of corn starch, the distinction is not as sharp, since the total phosphorus content is very much lower. Also, it is possible to separate the B-fraction of corn starch into sub-fractions of high and low phosphorus content, and these do not differ materially in solubility behavior or alkali lability.<sup>37</sup> Thus phosphorus is believed to constitute only a minor difference between the fractions.

<sup>63</sup> Evelyn B. Tilden and C. S. Hudson, *J. Am. Chem. Soc.*, **61**, 2900–2902 (1939).

<sup>64</sup> D. French and R. E. Rundle, *J. Am. Chem. Soc.*, **64**, 1651–3 (1942).

<sup>65</sup> R. W. Kerr, *J. Am. Chem. Soc.*, **65**, 188–93 (1943).

It appears that phosphorus is related to the formation of starch in the plant. Thus Hanes<sup>66</sup> has synthesized a linear polysaccharide from  $\alpha$ -D-glucopyranose 1-phosphate (Cori ester) through the action of potato phosphorylase. Dunlap and Beckmann<sup>67</sup> and likewise Cori<sup>68</sup> have found that the B-fraction activates this enzymic synthesis, while the A-fraction is inactive. It has not been established whether this effect is due to the branched character of the B-fraction or to the presence of phosphate in its structure.

#### VII. FUNCTION OF THE FRACTIONS IN STARCH PASTE BEHAVIOR

The physical behavior of starch and its various modifications may be traced primarily to two factors: the organization of the total starch substance into discrete granules, and the specific effects of the component fractions. Granule characteristics obviously influence the nature of a starch paste. Thus, large-granule starches such as potato and canna gelatinize in hot water to give pastes of high superficial "viscosity," due to crowding of the tremendously swollen granules. Such pastes are relatively fragile and may be greatly thinned by vigorous stirring which partially disintegrates the granule structure. A small-granule starch such as rice gives pastes of lower but more stable paste viscosity.

The various industrial uses of starch depend in large measure on the properties of the individual fractions. A starch paste may function in two ways: it may be used for its flocculating, its adsorptive, or its gel qualities; or it may act as a sol or protective colloid. These properties derive directly from the A and B fractions, respectively. In many instances, it appears that only one action is required, and that the presence of the other starch component may even be detrimental. Thus, Hixon and Sprague<sup>69</sup> have reported superior qualities for waxy maize starch in those applications for which stability and protective colloid action are requisite.

Boiled starch pastes tend to gel on cooling. This action must be attributed primarily to the linear A-fraction which has been partially leached from the swollen granules and which subsequently sets up an interlacing network within and about the granules. The various starches exhibit different gelation tendencies; thus, corn starch (especially when defatted) gives a firm gel, while potato and tapioca pastes are weak and "slimy." These variations may be due in part to differences in content

<sup>66</sup> C. S. Hanes, *Nature*, **145**, 348 (1940); W. T. Astbury, F. O. Bell and C. S. Hanes, *ibid.*, **146**, 558 (1940); C. S. Hanes, *Proc. Roy. Soc. (London)*, **B129**, 174 (1941).

<sup>67</sup> R. I. Dunlap and C. O. Beckmann: Paper presented at the Pittsburgh meeting of the American Chemical Society, September, 1943.

<sup>68</sup> Gerty T. Cori and C. F. Cori, *J. Biol. Chem.*, **151**, 57 (1943).

of A-fraction. Of more importance is the fact that the linear A-fractions differ in molecular constitution, and such structural considerations influence gelation. Thus, the recrystallized A-fraction from corn starch will gel at concentrations of 1.5–2.0%, while the corresponding fractions from potato and tapioca starches remain relatively fluid. Kerr's concept of a forked structure for the A-fraction from tapioca starch<sup>55</sup> would explain its lower gelation tendency.

In this survey, gelation is considered as a rapid and random association of linear molecules, while retrogradation is comparatively slow and crystalline. The differentiation is an arbitrary one, since the same forces are responsible. Thus corn and wheat starches are prone to retrograde as compared with tapioca and potato, while waxy maize is completely stable.

The action of fatty acid should be considered in this connection, both as regards the natural lipids associated with the cereal starches as well as the addition of fatty material to modify the character of starch pastes. The defatted cereal starches give pastes which are relatively transparent, less "short" in consistency, and more prone to gel than the raw cereal starches. Also, pastes of the defatted starches are more sensitive toward mechanical disintegration of the granule, as by boiling or stirring. In reverse, various fatty materials (as sulfonated oils) are added to textile sizes to decrease gelation. Formerly, this action was thought to be one of lubrication. It is now apparent that polar fatty substances preferentially adsorb on the linear A-fraction, rendering it insoluble and cancelling its effect on the starch paste. Such polar materials as lauryl alcohol, cyclohexanol and oleic acid restrict granule swelling by adsorbing on the A-fraction, thereby "waterproofing" the partially swollen granules. Similar effects can be produced with the tuber starches by the addition of fatty acid.

When the A-fraction from corn starch is potentiometrically titrated with iodine, its affinity for the latter is sharply reduced in the presence of small amounts of fatty acid. Thus the iodine adsorption of recrystallized A-fraction (originally 18.7%) is reduced to 12.4%, 3.5% and 0% by the addition respectively of 2%, 5% and 10% of palmitic acid.<sup>34a</sup> Raw corn starch contains approximately 0.65% of fatty acids,<sup>30</sup> corresponding to approximately 2% on the basis of the linear A-fraction. Thus, a third of the linear component in raw corn starch is inactivated. In a sense, Taylor and coworkers<sup>8</sup> were correct in assuming an association between " $\alpha$ -amylose" and fatty acid, but they erred in presuming the combination to be an ester.

The higher fatty acids act as fractional precipitants for the A-fraction.<sup>34a</sup> Thus when an autoclaved sol of defatted corn starch is cooled

in contact with oleic acid, 29% of the total starch substance is flocculated. After supercentrifugal separation and exhaustive extraction with methanol, this precipitated fraction gives 14.5% iodine adsorption. The non-precipitated B-fraction possesses no measurable iodine adsorption (less than 0.2%). While oleic acid affords excellent separation of the starch components, it is not recommended as a fractional precipitant, due to the difficulty of removing the last traces of adsorbed fatty material from the fractions. Volatile alcohols are preferred.

In many starch applications, retrogradation is an undesirable feature. This is particularly true when a coating or film of starch paste is applied and then allowed to dry. A typical instance is the use of starch during textile weaving, to coat the warp threads and prevent fuzz. Retrogradation of the starch weakens the continuity of this film and also interferes with its subsequent removal after the weaving operation. Thus the B-fraction is found to give excellent results as a warp size, particularly as regards cohesion to the yarn and subsequent ease of removal. As another instance may be cited the staling of bread, which Katz<sup>69</sup> has attributed to retrogradation of the starch. Were a waxy type of wheat known, Hixon<sup>70</sup> has suggested that bread from such a flour would not be susceptible to staling.

In reduced degree, the characteristics of the linear fraction follow through the various types of modified starch. Most commercial methods of starch modification have as their purpose the formation of a more soluble product of reduced viscosity. Undoubtedly, molecular break-down is occasioned by dextrinization, oxidation or acid conversion. However, the particular qualities of the product will still reflect the fate of the individual fractions. So-called thin-boiling starches are produced by suspending raw starch in dilute mineral acid at a temperature below the gelatinization point. Depending on the time of treatment, modified starches of progressively decreasing paste viscosity will be obtained. Subsequent iodine adsorption analysis and fractionation studies show that the identity of the fractions is not lost by this treatment. Only in the later stages of conversion does the proportion of linear A-fraction decrease. Both fractions suffer considerable hydrolytic break-down as indicated by alkali number and ferricyanide reducing value, and the A-fraction appears to be hydrolyzed at a slightly higher rate. Yet it retains in considerable degree its ability to adsorb iodine and to retrograde and to gel.

In the production of commercial dextrans, dry starch is treated with

<sup>69</sup> J. R. Katz, in "A Comprehensive Survey of Starch Chemistry," edited by R. P. Walton, pp. 100-17. Reinhold Publishing Company, New York (1928).

<sup>70</sup> R. M. Hixon, *Bakers Digest*, April, 1943.

a small amount of mineral acid, then heated at 150°–200° until the desired solubility and viscosity are attained. Caesar and Cushing<sup>71</sup> have shown that the alkali lability rises during the initial stages of conversion, as the starch is partially hydrolyzed in the presence of acid and moisture. When the latter are removed, a secondary reaction occurs, with progressive reduction in alkali lability and ferricyanide reducing value. When dry acid-modified starches are heated under neutral conditions at 105°, there is a sharp decline in alkali number.<sup>29</sup> These observations indicate a reduction in terminal aldehyde content. Brimhall<sup>72</sup> has pictured this secondary reaction as involving a repolymerization of linear chain fragments through 1,6-glucosidic linkage to give a branched type of structure. This theory seems very plausible, since the iodine affinity declines very sharply during the latter stages of dextrinization. In general, the iodine adsorption of the dextrans is low or even vanishing, whether the product has been manufactured under acidic conditions ("dextrans"), or under neutral or alkaline conditions ("gums").

Some dextrans still show evidence of retrogradation, and this is attributed to undestroyed linear material. Since dextrans are usually employed at high concentrations in aqueous solution and since the protective colloid action of the B-fraction has been reduced by hydrolysis, slight retrogradation tendencies may be exaggerated. Thus dextrin solutions may thicken and cloud on standing. When used as a remoistening adhesive (as on postage stamps), retrogradation of linear material will interfere with subsequent adhesive qualities. Recent claims have been made that dextrans from the waxy starches do not exhibit these tendencies.<sup>40</sup>

Oxidation has been employed extensively to produce modified starches which possess colloidal characteristics superior to those of the acid-modified starches. It is presumed that oxidation does not reduce the molecular size of the starch to the same degree as acid hydrolysis. Rather, the effect is to decrease those properties which are attributed to the A-fraction, and the oxidized starches give stable sols showing little tendency to gel or retrograde. The iodine affinity of corn starch decreases rapidly and progressively with increasing degree of hypochlorite oxidation. Yields of precipitated A-fraction are in agreement. Farley<sup>73</sup> has suggested that alkaline oxidation of starch may produce ketonic groups on carbons 2 or 3 of the glucose residue, or may open the glucopyranose ring at this point by glycol scission, or oxidize the primary

<sup>71</sup> G. V. Caesar and M. I. Cushing, *Ind. Eng. Chem.*, **31**, 921–24 (1939).

<sup>72</sup> B. Brimhall, *Ind. Eng. Chem.*, **36**, 72–75 (1944).

<sup>73</sup> F. F. Farley, in "Starch and Its Derivatives," by J. A. Radley, pp. 180–211. Chapman and Hall, London, 2nd Edition (1943).

alcohol group on carbon 6. Naturally, both fractions would be similarly oxidized, yet the physical effect should be more pronounced in the case of the A-fraction. It seems reasonable to suppose that the latter may be warped and twisted by oxidation of a relatively small proportion of its glucose residues. Thus the chain molecule would lose its linearity and could no longer associate in side-by-side manner.

Similarly, the solubility characteristics of starch may be enhanced, and gelation and retrogradation prevented by partial methylation. In a particular instance, starch was dissolved in a quaternary base and treated with methyl sulfate to introduce 0.47 methoxyl group per glucose residue. Such a product is readily soluble in water, shows no retrogradation or gelation effects, and possesses no affinity whatsoever for iodine. Similarly prepared hydroxymethyl and hydroxyisopropyl starches exhibit parallel characteristics, indicating that the diminished hydroxyl content of the methyl starches is not the factor responsible for their enhanced solubility. Degradation of molecular size is not probable under these conditions, and the stable character of the ethers is attributed to decreased intermolecular association occasioned by warping of the linear A-fraction.

#### VIII. PERTINENT PROBLEMS IN STARCH CHEMISTRY

It is hoped that the development of improved fractionation methods will provide fresh stimulus to starch research. There are innumerable problems which require clarification, and this survey would scarcely be complete without mention of some typical outstanding points.

*Botanical aspects of the fractions.* Questions naturally arise regarding the development and function of the individual fractions in the plant. Examination of immature corn starch during various stages of ripening indicates no substantial variation in the content of A-fraction. Also, the smaller granules obtained by sedimentation give the same yield of A-fraction as does the parent corn starch.<sup>34</sup> A study might be made of the effect on the fractions of genetic strain, growing conditions, etc. It may be possible to alter the proportion of A-fraction by such means.

*Construction of the starch granule.* It is unlikely that the several fractions are haphazardly thrown together to form the granule. Three types of granule structure have been proposed: (1) Location of one fraction as a surface "hull-substanz," (2) alternate onion-like layers of the fractions, and (3) arrangement in radial or "trichitic" fashion. The orientation of the individual molecules must also be considered.

*Hydration and gelatinization.* There is still no clear picture of the mechanism of granule gelatinization, despite the voluminous literature



on the subject. It seems reasonable that the individual fractions will have an important influence on the sorption of water and on the swelling and disaggregation of the granule. The waxy starches should be of value in clarifying this problem.

*Retrogradation.* This has been employed as an "omnibus term," to cover almost any type of desolvation. Methods should be devised to evaluate retrogradation on a more exact basis. Light scattering methods may have application to indicate particle size and molecular aggregation.

*Fractionation of various starches.* A wide variety of starches should be separated by Pentasol precipitation, to determine the distribution of the fractions. Comparison of the physical properties of the purified fractions from typical starches (especially corn, wheat, rice, potato, tapioca, canna, lily and arrowroot) should clarify specific differences in chemical structure.

*Sub-fractionation.* It is believed that selective precipitation affords a sharp separation between linear and branched components. These in turn are probably diversified in character, representing either a graded series of homologous substances or else containing several sharply defined molecular species. This possible diversity should be investigated.

*Fractionation methods.* There is need for a simple method of starch fractionation which will effect sharp separation without the necessity for elaborate supercentrifugal equipment. Selective leaching offers most promise, if retrogradation can be prevented and the separation substantially improved.

*Molecular weight.* It is hoped that such physical methods as sedimentation and diffusion can be applied to the purified fractions and possible sub-fractions, to evaluate size and shape characteristics of the molecules.

*Aldehyde content.* The most logical evaluation of molecular weight by chemical means would be the estimation of terminal aldehyde, either by an absolute reducing value or by derivatization (as osazone formation or characterization as a carbonyl derivative following oxidation).

*Methylation.* Methylation methods should be applied to the purified fractions, particularly as an end-group assay, but also for whatever information may be gained relative to the degree of branching.

*Branching.* It is hoped that branching can be definitely established by purely chemical means, and that the type of linkage can be identified by isolation of the disaccharide involved.

*Amylase action.* The isolation of relatively pure fractions should facilitate the study of enzyme action, especially to clarify the mechanism of amylolytic scission.

*Modified starches.* Previously, it has been necessary to conduct hydrolysis, oxidation and dextrinization studies on the whole starch. Use of the purified fractions should simplify such investigations.

*Type polymers.* If the linear and branched configurations of the fractions can be positively established, then these materials should serve as type substances for physical and colloidal research. They are unique in that they are composed of the same structural unit; thus such phenomena as adsorption, coacervation, gelation, etc. can be related to molecular configuration.

This Page Intentionally Left Blank

# PREPARATION AND PROPERTIES OF STARCH ESTERS

BY ROY L. WHISTLER

*Northern Regional Research Laboratory, Bureau of Agricultural and Industrial Chemistry,  
Agricultural Research Administration, U. S. Department of Agriculture, Peoria, Illinois*

## CONTENTS

I. Introduction . . . . .	279
II. Pretreatment of Starch for Esterification . . . . .	282
III. Preparation of the Starch Acetates . . . . .	284
1. Acetylation in the Presence of Pyridine . . . . .	284
2. Acetylation in the Presence of a Specifically Added Catalyst, Other than Pyridine . . . . .	286
3. Acetylation in the Absence of a Specifically Added Catalyst . . . . .	289
IV. Properties and Characteristics of Starch Acetate . . . . .	290
1. Acetyl Value and its Determination . . . . .	290
2. Solubility . . . . .	291
3. Properties of Starch Acetate Solutions . . . . .	292
4. Optical Rotation . . . . .	296
5. Fusion Temperature . . . . .	297
6. Mechanical Properties . . . . .	297
V. Preparation and Properties of Other Organic Esters of Starch . . . . .	300
1. Starch Formate . . . . .	300
2. Starch Propionate and Butyrate . . . . .	301
3. Starch Chloroacetates . . . . .	301
4. Starch Esters of Higher Fatty Acids . . . . .	301
5. Starch Tosylate . . . . .	302
6. Starch Benzoate and Cinnamate . . . . .	303
VI. Preparation and Properties of Inorganic Esters of Starch . . . . .	303
1. Starch Nitrate . . . . .	303
2. Starch Phosphate . . . . .	305
3. Starch Sulfate . . . . .	306
4. Starch Xanthate . . . . .	307

## I. INTRODUCTION

Starch is capable of ester formation with either organic or inorganic acids. Reaction may, in general, be effected by any of the well-known esterification procedures after their adaptation and modification to fit the special requirements of the starch macromolecules. The esters pro-

duced are derivatives of high polymers, and as such portray many properties commonly met with in this field. For the most part, attention in the past has been directed toward the preparation and properties of derivatives from whole starch. Ordinary starch, however, is a mixture of at least two types of architecturally different molecules, and, for this reason, the properties of its esters must be interpreted with care and without too far-reaching conclusions as to their ultimate structural significance. With the recent advent of fractionation methods capable of resolving starch into relatively pure molecular fractions, a new and promising field for starch derivative studies has been opened; unfortunately, the published data on the esters of purified fractions are scanty and most of the present discussion must accordingly be devoted to older work on whole starches or unpurified fractions.

The preparation and composition of the two starch fractions are discussed (see page 247) by T. J. Schoch in the preceding article. In the present discussion it should be understood that "starch" refers to the natural material, comprised of variable proportions of the two fractions, and for which no separation of the component fractions has been carried out. The term amylose is employed to represent the starch substances which are believed to be composed of linear, unbranched molecules, and the term amylopectin for the molecules which are believed to be composed of branched chains. When the butanol-precipitation method (or similar methods) has been employed in the preparation of specific materials, this fact will be indicated; in such cases, the amylose is equivalent to Schoch's fraction "A" and the amylopectin to Schoch's fraction "B." In other instances, when the authors have named their fractions as "amylose" and "amylopectin," but when it is probable that the two fractions have only received a partial separation, the names will be given in quotation marks, and the method of preparation will be indicated.

Structural investigations have proved that starch consists of chains of glucopyranose units joined together, for the most part, by  $\alpha$ -1,4-linkages. Each of these glucose units along the starch chain has unsubstituted hydroxyl groups on carbon atoms 2, 3, and 6. The hydroxyl groups may partake in esterification reactions to form starch esters of varying degrees of substitution up to the triester. Starch triesters are the only esters for which the properties and methods of preparation have been investigated extensively. Undoubtedly, some difference exists in the rate of esterification among the three esterifiable hydroxyl groups, but as yet there is little information available concerning their relative reactivity.

Preparative methods for starch esters ordinarily involve the treatment of starch with acids, acid anhydrides, or acid chlorides and a promoting agent. The promoting agent may be a catalyst; in the case of acid anhydrides and acid chlorides it may be a tertiary organic base, and in the case of acid chlorides it may be an alkali hydroxide. Use of substituted acid anhydrides as impelling agents to promote esterification by higher fatty acids has received little attention in the starch field. *Direct esterification of starch by an acid alone produces, in most instances, only a minor degree of substitution and is not often used for preparing starch esters.*

Development of esterification reactions for starch requires consideration of the natural physical aspects of starch, particularly the occurrence of starch as discrete masses called granules. The granules resist penetration by most organic esterification mixtures and tend to react slowly toward all but the most drastic esterification reagents. Under drastic conditions, the molecules on the periphery of the starch granules are first esterified, and, by remaining in prolonged contact with the reagents, are subject to degradation. Molecules lying in the interior of the granules come into contact with weakened reagents and may be incompletely or unevenly esterified. Products from such reactions do not represent derivatives of starch, but rather derivatives of a partially degraded carbohydrate. To avoid this difficulty, the granules are often swollen or disintegrated prior to the esterification of the starch. Because of the advantages gained in using properly prepared starch for esterification, a brief discussion of several pretreatment procedures will be given in Section II.

Starch acetates have been extensively investigated both as to manner of preparation and as to properties. This is in contrast to the other organic esters of starch of which only a few have been prepared, and, of these, only a few characterized. Among the inorganic esters, the starch nitrates have received the most attention and have risen to industrial importance because of their use in explosives. Partly because of this use and the secrecy attending their manufacture, a full disclosure of the preparation and properties of starch nitrates has not been published.

Much helpful information on starch esterification methods and on the probable properties of starch esters may be obtained by examining similar reactions and esters in the cellulose field. This is because both starch and cellulose consist of polymerized glucose units capable of esterification to the triester stage, and because the superior ability of the cellulose esters to form plastics, films, fibers, and lacquers has promoted an accumulation of information on cellulose esters which far exceeds the present knowledge of starch esters.

In applying cellulose esterification methods to starch, it must be remembered that starch is much more easily hydrolyzed than cellulose. Many esterification procedures for cellulose are too drastic to be applied to starch unless milder reaction conditions are provided.

This review does not presume to encompass a complete coverage of all the published work in the field of starch esters. Some difficulty arises in the interpretation of properties of starch esters in those cases where authors have failed to list the type of starch investigated. Where possible, however, the type of starch used is stated in the following discussion.

Information on many parts of the starch ester field is decidedly inadequate. It is hoped that future investigations will extend and round out the knowledge of starch esters, not only from the theoretical aspect but also from the view of the commercial utilization of these potentially low-cost products.

## II. PRETREATMENT OF STARCH FOR ESTERIFICATION

Starch, as ordinarily prepared either in the laboratory or commercially, requires very little additional purification. It is one of the few natural organic substances that can be obtained readily in a high state of purity. A typical analysis of a standard grade of commercial corn starch shows that it contains, on a dry basis, approximately 99.0% starch, 0.05–0.07% nitrogen, 0.02% phosphorus, 0.08–0.10% ash, and 0.5–1.0% fatty substance. Normally, the starch contains 10–12% moisture. The fatty material and a part of the phosphorus can be removed by extraction with 85% methanol<sup>1, 2, 2a</sup> or by extraction with ethanol containing a small amount of nitric acid,<sup>2b</sup> although the latter treatment may cause some degradation of the starch.

Numerous methods have been developed for destroying the natural compactness of the starch granules and thereby bringing the starch into a more readily esterifiable condition. The most satisfactory methods employ a swelling or disorganization of the starch granules in reagents which produce little or no degradation of the starch molecules. Suitable reagents are: water,<sup>3, 4</sup> aqueous chloral hydrate,<sup>5</sup> or aqueous pyridine.<sup>6–9</sup>

<sup>1</sup> T. J. Schoch, *J. Am. Chem. Soc.*, **64**, 2954 (1942).

<sup>2</sup> R. W. Kerr, *Cereal Chem.*, **20**, 299 (1943).

<sup>2a</sup> R. L. Whistler and G. E. Hilbert, *J. Am. Chem. Soc.*, **66**, 1721 (1944).

<sup>2b</sup> K. P. Link, C. G. Niemann and R. H. Roberts, U. S. Pat. 2,121,919 (1938).

<sup>3</sup> E. Peiser, *Z. physiol. Chem.*, **161**, 210 (1926).

<sup>4</sup> W. N. Haworth, E. L. Hirst and J. I. Webb, *J. Chem. Soc.*, 2681 (1928).

<sup>5</sup> K. H. Meyer, P. Bernfeld and H. Hohenemser, *Helv. Chim. Acta*, **23**, 885 (1940).

<sup>6</sup> H. Friese and F. A. Smith, *Ber.*, **61B**, 1975 (1928).

<sup>7</sup> R. S. Higginbotham and W. A. Richardson, *J. Soc. Chem. Ind.*, **57**, 234 (1938).

<sup>8</sup> E. Pacsu and J. W. Mullen, *J. Am. Chem. Soc.*, **63**, 1487 (1941).

<sup>9</sup> J. W. Mullen and E. Pacsu, *Ind. Eng. Chem.*, **34**, 807 (1942).

Starch granules, when heated in water or aqueous chloral hydrate, are not only greatly swollen, but, depending on the temperature and length of treatment, may be more or less disintegrated or dissolved. This disorganized starch, if isolated in a finely divided state, is highly suited for esterification reactions. However, unless special precautions are employed during the isolation, a horny product results which is even less reactive than the original starch.<sup>10</sup>

Alcohol has ordinarily served to precipitate starch from its aqueous dispersions. In some cases, the precipitated starch has been subjected to esterification while still wet with alcohol,<sup>11</sup> but this procedure requires excessive amounts of esterifying agent to react with the alcohol and is therefore not completely satisfactory. The successful isolation of starch as a dry fluffy powder can be accomplished by alcohol precipitation of a starch dispersion if the following precautions are observed:<sup>12</sup>

(1) The starch paste is poured with vigorous stirring into at least five times its volume of alcohol, (2) the filtered precipitate is freed of water by stirring several times with fresh portions of alcohol, (3) the condensation of atmospheric moisture on the starch is prevented at all times. For the latter reason, the alcohol is removed from the starch by drying over calcium chloride in a vacuum desiccator.

Meyer<sup>5</sup> has employed acetone successfully for the precipitation of starch from aqueous chloral hydrate solutions.

Aqueous pyridine is often used to swell starch in those instances where pyridine is to serve as a component of the esterification mixture. While the greatest swelling of starch occurs in 30% aqueous pyridine solution,<sup>13</sup> more concentrated pyridine solutions are ordinarily used in order that a minimum of water will be present for the subsequent esterification. An anhydrous mixture of gelatinized starch and pyridine has been prepared by Mullen and Pacsu,<sup>9</sup> who swelled starch in 60% pyridine and then distilled the water as a pyridine-water azeotrope (60/40% composition).

Some starch pretreatments, although they transform starch to a more easily esterifiable product, undoubtedly cause chemical degradation or alteration of the starch molecules. This appears to be the case in those treatments utilizing sodium peroxide,<sup>14</sup> hot glycerol,<sup>15</sup> alcoholic

<sup>10</sup> G. Hughes, A. Macbeth and F. Winzor, *J. Chem. Soc.*, 2026 (1932).

<sup>11</sup> E. L. Hirst and G. T. Young, *J. Chem. Soc.*, 951 (1939).

<sup>12</sup> R. L. Whistler, Allene Jeanes and G. E. Hilbert, Paper presented before 104th meeting, American Chemical Society, September, 1942. In press.

<sup>13</sup> K. Hess, R. Pfleger and C. Trogus, *Ber.*, **66**, 1505 (1933).

<sup>14</sup> W. Syniewski, *Ber.*, **30**, 2415 (1897); **31**, 1793 (1898).

<sup>15</sup> K. Zulkowski, *Ber.*, **23**, 3295 (1891).



hydrogen chloride,<sup>16,17</sup> 85% phosphoric acid,<sup>18</sup> formic acid,<sup>19</sup> and other acids, concentrated solutions of acid salts, and oxidizing agents or high temperatures.

### III. PREPARATION OF THE STARCH ACETATES

Starch acetates are the most easily prepared of the starch esters. They have served frequently for the characterization of starch fractions, for investigations of starch structure and as intermediates<sup>4, 17, 20-23</sup> in the preparation of methylated starch. Although most acetylation work has been done on white potato starch, considerable attention has been given to the acetylation of other starches such as those from corn,<sup>5, 10, 24, 25</sup> waxy corn,<sup>26</sup> wheat,<sup>3, 11, 27, 28</sup> canna,<sup>29</sup> rice,<sup>30-33</sup> horse chestnut<sup>11</sup> and banana.<sup>34</sup>

Methods for the preparation of starch acetates may be classified as acetylation (1) in the presence of pyridine, (2) in the presence of specifically added catalysts other than pyridine, and (3) in the absence of a specifically added catalyst. Methods classified in (1) produce little or no degradation of the starch molecules. Those in (2) may or may not produce degradation, depending upon the reagents selected, while methods in (3) almost invariably cause a depolymerization of the starch.

#### 1. Acetylation in the Presence of Pyridine

Pyridine is by far the most commonly used catalyst or accessory in the present day acetylations of starch. It is particularly suitable for the laboratory acetylation of starch in those cases where damage to the basic molecular structure is to be minimized.

<sup>16</sup> F. Pregl, *Monatsh.*, **22**, 1049 (1901).

<sup>17</sup> D. K. Baird, W. N. Haworth and E. L. Hirst, *J. Chem. Soc.*, 1201 (1935).

<sup>18</sup> R. Sutra, *Compt. rend.*, **196**, 1608 (1933).

<sup>19</sup> J. R. Whinfield and G. C. Ritchie, British Pat. 535,949 (1941).

<sup>20</sup> W. N. Haworth, E. L. Hirst and M. M. T. Plant, *J. Chem. Soc.*, 1214 (1935).

<sup>21</sup> W. N. Haworth, E. L. Hirst and A. C. Waine, *J. Chem. Soc.*, 1299 (1935).

<sup>22</sup> W. N. Haworth, E. L. Hirst, H. Kitschen and S. Peat, *J. Chem. Soc.*, 791 (1937).

<sup>23</sup> E. L. Hirst, M. M. T. Plant and M. D. Wilkinson, *J. Chem. Soc.*, 2375 (1932).

<sup>24</sup> R. W. Kerr and O. R. Trubell, *Cereal Chem.*, **18**, 530 (1941).

<sup>25</sup> R. W. Kerr, O. R. Trubell and G. M. Severson, *Cereal Chem.*, **19**, 64 (1942).

<sup>26</sup> W. N. Haworth, E. L. Hirst and M. D. Woolgar, *J. Chem. Soc.*, 177 (1935).

<sup>27</sup> J. Boeseken, J. C. Berg and A. N. Kerstjens, *Rec. trav. chim.*, **35**, 320 (1916).

<sup>28</sup> H. Staudinger and E. Husemann, *Ann.*, **527**, 195 (1937); *Ber.*, **71**, 1057 (1938).

<sup>29</sup> W. Z. Hassid and W. H. Dore, *J. Am. Chem. Soc.*, **59**, 1503 (1937).

<sup>30</sup> M. Bergmann and F. Beck, *Ber.*, **54**, 1574 (1921).

<sup>31</sup> M. Bergmann and H. Ludewig, *Ber.*, **57**, 961 (1924).

<sup>32</sup> E. L. Hirst and G. T. Young, *J. Chem. Soc.*, 1471 (1939).

<sup>33</sup> P. Brigl and R. Schinle, *Ber.*, **62B**, 99 (1929).

<sup>34</sup> E. G. E. Hawkins, J. K. N. Jones and G. T. Young, *J. Chem. Soc.*, 390 (1940).

Mixtures of acetic anhydride and pyridine, both because of their mild character and the difficulty with which they penetrate starch granules, do not effect more than a minor acetylation of untreated starches even during long contact at 100°. Consequently, the reagents may be applied successfully only to those pretreated starches, starch fractions, or modified starches which are in a non-horny, finely divided state.

After swelling starch granules in aqueous pyridine, Friese and Smith,<sup>6</sup> as well as other workers,<sup>7, 33, 35</sup> have added acetic anhydride to bring about a smooth acetylation of the wet starch. Since water consumes excessive amounts of acetic anhydride and may produce hydrolysis of the starch, it is not a desirable constituent in the reaction mixture. Pacsu and Mullen<sup>8, 36</sup> have improved the Friese and Smith procedure by distilling the water from the gelatinized starch as a pyridine-water azeotrope and adding acetic anhydride to conduct the acetylation under anhydrous conditions. At 100–115°, the acetylation is complete in one hour.

No uniform acetylation conditions have been customary for the acetylation of starch by acetic anhydride and pyridine. Suggested reaction temperatures have varied from 15° to over 100° and reaction periods from several hours to a week. Recently,<sup>12</sup> work has been undertaken to clarify these views and to establish information on which a more uniform acetylation procedure can be based.

This work<sup>12</sup> showed, at once, the necessity of using a disorganized starch such as is obtained by the specific pretreatments outlined in Section II. The acetylation of a dry fluffy starch proceeds slowly at 60–80° while slightly colored products are developed at temperatures in excess of 100°. However, at 100°, no color develops and the reaction proceeds swiftly, all of the starch being dissolved in fifteen minutes. After 1.5–3 hours, the acetyl value of the product reaches 44.8%, that of a triacetate. At moisture contents of 0.2–11%, the rate of acetylation remains constant, although completely anhydrous starch may be slightly resistant to the acetylation. This would be in keeping with the belief that, at excessively low moisture values, strong intermolecular forces come into play which cause the starch molecules to be highly associated. To conserve acetic anhydride and reduce the risk of hydrolysis, starch dried to a moisture content of about 3% should be used. A reagent ratio of 3.7 parts of pyridine and 3.2 parts of acetic anhydride to 1 part of starch gives very good results. Smaller amounts of acetic anhydride produce slower rates of acetylation, while little benefit is derived from the use of larger quantities. The mildness of the acetylation reaction is attested by the fact that approximately identical viscosities are found for starch acetates prepared in either a three- or a six-hour reaction period.

<sup>6</sup> W. S. Reich and A. F. Damansky, *Bull. soc. chim. biol.*, **19**, 158 (1937); **19**, 357 (1937); *Compt. rend. soc. biol.*, **113**, 23 (1933); *Compt. rend.*, **196**, 1610 (1933).

<sup>8</sup> J. W. Mullen and E. Pacsu, *Ind. Eng. Chem.*, **34**, 1209 (1942).

Acetyl chloride in the form of an addition compound with pyridine has been employed for the acetylation of potato starch by Reich and Damansky,<sup>35</sup> who obtained rather unusual results not verified by other investigators. Reich and Damansky treated dry starch with anhydrous acetyl chloride and pyridine at 70–80°. Acetylation proceeded slowly, but after 120 to 152 hours seemed to reach an end point with the introduction into the starch of about 37% acetyl. A similar end value of about 39% acetyl was obtained by treating dry potato starch in dry pyridine with acetic anhydride at 80° for 324 hours. The theoretical acetyl content of a starch triacetate is 44.78%. The products were not randomly acetylated, as would be expected, but consisted of a mixture of about 82% diesters and 16% of a triester which could be separated by chloroform fractionation. Corresponding types of esterification were obtained by esterifying dry starch in pyridine with either benzoyl or cinnamoyl chloride. Reich and Damansky therefore concluded that natural starch consists principally of a component having two free hydroxyl groups per glucose unit. Partial hydrolysis of this labile component, either in water or in acidic reagents, is postulated to set free a third hydroxyl group which can give rise to a triester. They believe that the ease with which starch is converted to the trihydroxy component accounts for the isolation of a triester by most investigators. It is known now that drying causes strong association of starch molecules and this may, in part, account for the results obtained. In any event, these unique results have not been fully explained and further investigation of the method is warranted.

## 2. *Acetylation in the Presence of a Specifically Added Catalyst, Other than Pyridine*

Sulfuric acid is a powerful esterification catalyst. It has been widely applied with mixtures of acetic acid and acetic anhydride to promote acetylations of numerous substances. Use of this catalyzed reaction for starch acetylation, however, has not risen to pre-eminence among starch acetylation methods as it has done among cellulose acetylations, although both reactions were discovered at the same time.<sup>37</sup> The underdevelopment of this reaction in the starch field may be due to the following causes: (1) sulfuric acid, a powerful acetylation catalyst, strongly catalyzes the hydrolysis of starch molecules and cannot be used for starch acetylations in the concentrations found most effective for cellulose reactions; (2) most investigations of this reaction have been made on whole granules

<sup>37</sup> A. Franchimont, *Compt. rend.*, **89**, 711 (1879).

or horny starch, both of which resist penetration by the acetylating agents and, hence, do not readily react in the reaction medium.

While whole starch is very slowly or incompletely dissolved by mixtures of acetic acid, acetic anhydride, and sulfuric acid, the acetyl content of the dissolved portion rises rapidly with increased amounts of sulfuric acid or the application of higher temperatures.<sup>10,38</sup> In contrast to whole starch a finely divided, fluffy starch, prepared as described in Section II, might be expected to be acetylated rapidly and completely by mixtures of acetic acid, acetic anhydride, and sulfuric acid.

Acetic anhydride and sulfuric acid together also form a powerful acetylating mixture capable of esterifying starch at low temperatures. Pregl<sup>18,39</sup> treated a Zulkowsky heat-modified potato starch with a mixture of cold acetic anhydride and sulfuric acid. After 40 hours, most of the starch dissolved to produce a product containing 46.7–47.4% acetyl.

Peiser<sup>3,40</sup> has pretreated wheat starch by gelatinization in water, precipitation by alcohol and drying. Acetylation was effected in the cold with 6 parts of acetic anhydride and 0.05 part of sulfuric acid. After eight hours, only 14% of the starch dissolved to produce an acetate containing 46.7% acetyl. At 55°, the acetyl content of the dissolved starch is reported as 47.3%. On the other hand, Haworth, Hirst and Webb<sup>4</sup> on following Peiser's procedure have not obtained a similar product.

It should be borne in mind in these cases that while mixed acetic anhydride and sulfuric acid produce acetylation, they also bring about acetolysis which may result in severe depolymerization of the starch molecules. The occurrence of degradation is evident from the fact that the resulting acetates have acetyl values in excess of the theoretical value of 44.78%, and from the finding of glucose pentaacetate<sup>41</sup> among the reaction products whenever low temperatures or low sulfuric acid concentrations are not employed.

Acid catalysts other than sulfuric acid have been tested with acetic anhydride for use in starch acetylation. None of these, however, seem to exert as powerful a catalytic action<sup>27,38</sup> as sulfuric acid, and some, particularly the halogen acids, cause even more extensive depolymerization of the starch.<sup>42</sup> For example, acetic anhydride saturated with hydrogen chloride rapidly dissolves starch and converts it to low molec-

<sup>38</sup> C. A. Burkard and E. F. Degering, *Rayon Textile Monthly*, **23**, 340 (1942).

<sup>39</sup> See also H. Pringsheim and F. Eissler, *Ber.*, **46**, 2959 (1913).

<sup>40</sup> See also: H. Pringsheim and P. Meyersohn, *Z. physiol. Chem.*, **173**, 211 (1928); and, reference 35.

<sup>41</sup> Z. Skraup, *Monatsh.*, **19**, 458 (1898); *Ber.*, **32**, 2413 (1899).

<sup>42</sup> Z. Skraup, *Monatsh.*, **26**, 1415 (1905).

ular weight, chlorine-containing, acetylated products<sup>41</sup> among which is acetochloromaltose. Acetic anhydride saturated with hydrogen bromide rapidly dissolves rice starch at 0° to produce<sup>40</sup> an 85% yield of aceto-bromoglucose.

Starch has been acetylated by Barnett's mixture, which is composed of acetic acid, acetic anhydride, and a catalyst consisting of equal parts of sulfur dioxide and chlorine. This mixture, originally developed for cellulose esterification,<sup>48</sup> readily acetylates starch at 55°, the acetyl content reaching the theoretical value of 44.8% in about four hours.<sup>4</sup> A critical evaluation of the reaction by Hassid and Dore,<sup>29</sup> and particularly by Higginbotham and Richardson,<sup>7</sup> has shown that the acetates prepared have the viscosity, reducing power, and solubility characteristics indicative of a partially degraded starch.

Zinc chloride, although commonly used as a catalyst in the acetylation of simple sugars, has not been extensively investigated as a catalytic agent for starch acetylation. Law<sup>44</sup> has reported that he could not acetylate ordinary starch with a mixture of zinc chloride, acetic acid, and acetic anhydride. Starch heated in glycerol at 100–170°, and therefore probably degraded, has been acetylated,<sup>45,46</sup> however, in a mixture of zinc chloride and acetic anhydride at 50–80°.

Acetyl chloride, either alone<sup>47</sup> or when heated in the presence of barium carbonate,<sup>14</sup> acetylates and, at the same time, degrades starch. Acetyl bromide likewise acetylates and simultaneously degrades starch.

Sodium acetate, a mild acetylation catalyst, has been extensively used in the acetylation of carbohydrate material. When used in conjunction with acetic anhydride<sup>27</sup> or with acetic anhydride and acetic acid<sup>38</sup> at reflux temperatures, it is capable of producing only a slow acetylation of untreated starch granules. After four days of refluxing with acetic anhydride and sodium acetate, corn starch has been acetylated to 43.5% acetyl content,<sup>25</sup> but the acetylation is non-uniform since the product can be fractionated into parts having different acetyl contents. The slow acetylation of ordinary starch in these cases is probably due to the compact structure of the starch granules, and a much more rapid and complete acetylation would be expected to occur with a starch pretreated as described in Section II.

<sup>41</sup> W. L. Barnett, *J. Soc. Chem. Ind.*, **40**, 8T (1921).

<sup>44</sup> D. Law, *Chem.-Zeit.*, **32**, 365 (1908).

<sup>45</sup> Y. Tsuzuki, *Bull. Chem. Soc. Japan*, **3**, 276 (1928); **4**, 153 (1929); *C. A.*, **23**, 1393 (1929); **24**, 260 (1930).

<sup>46</sup> I. Sakurada and R. Inoue, *J. Soc. Chem. Ind. Japan*, **39**, Suppl. binding 48 (1936); *C. A.*, **30**, 4714 (1936).

<sup>47</sup> A. Michael, *Am. Chem. J.*, **5**, 359 (1883).

Sodium and potassium thiocyanate are said to behave in a fashion similar to sodium acetate in starch acetylations.<sup>48</sup>

Sulfuryl chloride and magnesium perchlorate have been suggested as acetylation catalysts<sup>48a</sup> for starch. Sulfur dioxide in acetic acid,<sup>48b</sup> sulfur trioxide in acetic anhydride,<sup>48c</sup> and sulfonated fatty acid or sulfonated salicylic acid in a mixture of acetic anhydride and acetic acid<sup>48d</sup> have also been reported to acetylate starch.

### 3. Acetylation in the Absence of a Specifically Added Catalyst

The preparation of the first starch acetate, as well as the first cellulose acetate, was announced by Schützenberger<sup>49</sup> in 1865. These acetates were prepared by heating the carbohydrates in acetic anhydride to about 140–160°. Further examination of this reaction has been made by Traquair<sup>50</sup> who found that on heating starch to 90° with acetic anhydride a derivative of low acetyl content (1–4%) is obtained which is capable of forming clear, somewhat elastic films. This starch acetate, termed "Feculose," was produced commercially for a time, being sold for use as a thickening agent and as a size for textiles and paper.

Elevated temperatures are apparently required to cause acetylation of untreated starches by acetic anhydride. Wheat starch, for example, is not acetylated<sup>27</sup> by this reagent at 35°. At temperatures sufficiently high to produce acetylation, however, acetic anhydride causes extensive degradation of the starch molecules, resulting at 95° in the production of considerable quantities of maltose octaacetate.<sup>51</sup>

Acetic acid, by itself, esterifies untreated starch slowly and with difficulty even at reflux temperature. After heating starch with acetic acid at 90° for 72 hours, Cross, Bevan and Traquair<sup>52</sup> succeeded in obtaining an acetate containing only 33.4% acetyl. Since this acetate was water-soluble, it undoubtedly represented a degradation product. Clarke and Gillespie,<sup>53</sup> in a similar experiment, refluxed potato starch in glacial acetic acid for as long as 296 hours without increasing the acetyl value of the product beyond 44.0%. Tokuzo,<sup>54</sup> however, has recently claimed the acetylation of starch by acetic acid at 80°.

<sup>48</sup> Y. Tsuzuki, *Bull. Chem. Soc. Japan*, **4**, 21 (1929); *C. A.*, **23**, 2425 (1929).

<sup>48a</sup> E. Lorand, U. S. Pat. 1,959,590 (1934).

<sup>48b</sup> I. G. Farbenindustrie, U. S. Pat. 1,928,269 (1930).

<sup>48c</sup> E. Knoevenagel, *Ann.*, **402**, 111 (1914).

<sup>48d</sup> R. Escales and H. Levy, *Kunststoffe*, **13**, 25, 52, 64 (1923); *C. A.*, **18**, 2248 (1924).

<sup>49</sup> P. Schützenberger, *Compt. rend.*, **61**, 485 (1865); see also: P. Schützenberger, *ibid.*, **68**, 814 (1869); *Ann. chim. phys.*, **21**, 235 (1870); A. Michael, *Am. Chem. J.*, **5**, 359 (1883).

<sup>50</sup> J. Traquair, *J. Soc. Chem. Ind.*, **28**, 288 (1909).

<sup>51</sup> R. Sutra, *Compt. rend.*, **195**, 1079 (1932).

<sup>52</sup> C. F. Cross, E. J. Bevan and J. Traquair, *Chem.-Zeit.*, **29**, 527 (1905).

<sup>53</sup> H. T. Clarke and H. B. Gillespie, *J. Am. Chem. Soc.*, **54**, 2083 (1932).

<sup>54</sup> N. Tokuzo, Japanese Pat. 130,827 (1939); *C. A.*, **35**, 2026 (1940).

The addition of acetic anhydride, either directly to the initial reaction mixture of starch and acetic acid or after a pretreatment of starch with warm acetic acid,<sup>56</sup> produces a much higher acetylation rate than is attained by acetic acid alone. On refluxing a mixture of starch, acetic acid, and acetic anhydride, Burkhard and Degering<sup>56</sup> have observed that in about four hours a product containing 36% acetyl can be isolated, although thereafter the acetylation rate decreases greatly, 45 hours being required to produce a derivative having the analysis of a triacetate.

Ketene, alone or in the presence of an acid catalyst, has been observed<sup>56, 57</sup> to produce a low degree of acetylation in whole starch.

#### IV. PROPERTIES AND CHARACTERISTICS OF STARCH ACETATE

The properties displayed by a starch triacetate, or by other starch esters are dependent upon the type and molecular weight of the starch or starch fraction used for the esterification. The properties may also be influenced by trace constituents or impurities such as compounds of nitrogen and phosphorus which are often observed in starch esters. While the nature of the nitrogenous constituent is not known, it has been demonstrated that much of the phosphorus of potato starch exists as a natural phosphoric ester of the amylopectin fraction. It is not surprising, therefore, that the phosphorus of potato starch is carried through an esterification and may influence the properties of the starch ester. The exact modifying effects of these components on the properties of starch esters, however, are still to be explained.

Starch acetates may be characterized, in part, by (1) acetyl content, (2) solubility, (3) behavior in solution, (4) optical rotation, (5) fusion temperature, and (6) mechanical properties.

##### 1. *Acetyl Value and Its Determination*

Determination of acetyl content has been the commonest means for the characterization of a starch acetate. Quantitative determinations of the acetyl content of starch acetates may be made by several procedures, each of which involves an initial saponification of the acetyl groups.

One suitable analytical procedure is a modification<sup>52</sup> of the Eberstadt method developed primarily for use with cellulose acetates. By this procedure, the sample is swollen with warm 75% alcohol and then

<sup>56</sup> British Celanese Ltd., British Pat. 487,020 (1938).

<sup>56</sup> C. H. Burkhard and E. F. Degering, *Proc. Indiana Acad. Sci.*, 51, 173 (1942).

<sup>57</sup> E. B. Middleton, U. S. Pat. 1,685,220 (1928).

<sup>52</sup> L. B. Genung and R. C. Mallatt, *Ind. Eng. Chem., Anal. Ed.*, 13, 369 (1941).

saponified for 24–48 hours at temperatures below 35° by the use of aqueous alkali with an initial concentration of 0.25 normal. The excess alkali is then slowly back-titrated with standard acid.

A second procedure<sup>63</sup> involves the transesterification of a dry starch acetate in anhydrous methanol using sodium methoxide as a catalyst.

A sample of dry starch acetate weighing 0.2 to 0.3 g. is placed in a distilling flask fitted with a dropping funnel, and 20 ml. of anhydrous methanol and 5 to 10 ml. of 0.2 *N* sodium methoxide in anhydrous methanol are added. Distillation is begun and the acetyl groups are removed as methyl acetate. When the solution has been concentrated to about 5 ml., a fresh 10–20 ml. portion of methanol is added. In this manner, three separate portions of methanol are added and distilled. The distillate is collected in a cooled receiver in which the methyl acetate is later saponified by refluxing with 25 ml. of 0.2 *N* sodium hydroxide and the excess alkali titrated with standard acid. The amount of alkali consumed in the saponification is equivalent to the acetyl content of the starch acetate. This procedure has the advantage of rapidity and of being unaffected by traces of non-volatile acidic impurities. Acetyl values obtained are accurate to  $\pm 0.1\%$ .

Another similar procedure<sup>64</sup> has been developed in which *p*-toluene-sulfonic acid is added to the reaction flask prior to the distillation of the methyl acetate.

Since all of these methods involve heterogeneous saponifications, the physical condition of the sample is an important variable. Best results are therefore obtained if a finely divided or fluffy sample is used.

Acetyl values of fully acetylated starch may serve to indicate a depolymerized starch if the depolymerization has been extensive. The non-reducing end or ends of each starch acetate molecule contains a glucose unit with four acetyl groups instead of the usual three. Normally, the number of these extra acetyl groups is too few to raise the acetyl value of the starch acetate beyond the triacetyl value of 44.78%. As the size of the starch acetate molecule diminishes, however, the number of end groups or glucose tetraacetate units increases. If the accuracy of the acetyl determination is  $\pm 0.1\%$ , it should be possible to distinguish from the starch triacetate those derivatives with acetyl values equal to, or greater than about 44.9%. This corresponds to the detection of starch acetates with a degree of polymerization of 40 to 60 glucose units or less.

## 2. Solubility

The solubility of a starch acetate is dependent upon: (a) the acetyl content; (b) the average degree of polymerization of the starch; and

<sup>63</sup> R. L. Whistler and Allene Jeanes, *Ind. Eng. Chem., Anal. Ed.*, **15**, 317 (1943).

<sup>64</sup> F. B. Cramer, T. S. Gardner and C. B. Purves, *Ind. Eng. Chem., Anal. Ed.*, **15**, 319 (1943); cf. K. Freudenberg and M. Harder, *Ann.*, **433**, 230 (1923).



(c) the particular type of acetylated starch or starch fraction. Undegraded starch acetates prepared by mild esterification methods are insoluble or difficultly soluble in most reagents and dissolve easily in relatively few solvents, which include only those of a polar nature. Many reagents, however, cause a sufficient weakening of the attractive forces between the starch molecules to allow the formation of voluminous gels. Friese and Smith<sup>6</sup> have found potato starch triacetate to be insoluble in ethyl acetate, acetone, benzene, and chloroform, although swelling occurs in these reagents. The difficulty or incompleteness with which potato starch triacetate dissolves in various solvents has been noted by others.<sup>7</sup> This insolubility of the triacetate may possibly result from its high molecular weight or from its phosphoric ester content.

In general, starch triacetates are soluble in acetic acid and, except perhaps for potato starch triacetate, are soluble in chloroform, 1,1,2-trichloroethane, tetrachloroethane, and other halogenated hydrocarbons. High grade starch triacetates do not appear to be soluble in ethyl acetate or alcohol, while some controversy exists as to the extent of their solubility in pyridine and acetone. Waxy corn starch triacetate, perhaps due to its smaller molecular weight, is readily soluble in a wide variety of organic solvents.

It should be observed that slight depolymerization or incomplete acetylation of the starch acetate molecule leads to products possessing a much wider degree of solubility. For example, at low acetyl values (0-25%), starch acetates are said to be water-soluble.<sup>52,53</sup> However, if the starch molecules are undegraded, it is probable that the water-soluble range does not extend to products containing more than 8-15% acetyl groups.

Solubility differences of the triacetates of the purified starch fractions have not yet been investigated in detail. It might be expected, however, that amylose triacetates, which are composed of linear molecules capable of close packing, would be more insoluble than the somewhat loosely packed molecules of amylopectin triacetate. Furthermore, various amylose triacetates, because of their uniform composition, might be expected to show similar solubilities, whereas different amylopectin triacetates, due to the variation of their phosphoric acid contents, might show dissimilar solubilities.

### 3. *Properties of Starch Acetate Solutions*

Starch acetate solutions have, at times, been investigated as to viscosity, osmotic pressure, rate of diffusion, cryoscopic point, *et cetera*. Despite the limited number of these investigations, certain deductions may be made regarding the size, shape, and associative forces of starch acetate molecules.

Considerable advantage is gained by making physical measurements on solutions of starch derivatives rather than on aqueous solutions of starch. For one reason, solutions of starch derivatives are more homogeneous and are more free of structural effects than aqueous starch dispersions wherein complete granule disorganization is difficult to accomplish and powerful structural forces often persist. A second reason lies in the ability of solutions of starch derivatives to remain constant with time and, hence, not to undergo the complicated series of changes which occur in aqueous starch dispersions and which are collectively referred to as aging or retrogradation.

Starch acetate molecules in solution are probably almost electrically neutral. The acetyl group, however, possesses strong associative forces, and, as a consequence, the starch acetate molecules may be assumed to be highly solvated; the degree of solvation is dependent on the polar nature of the solvent and therefore reaches exceptionally high values for solvents such as formic acid.<sup>65</sup> This tendency to bind polar molecules also accounts for the high swelling action which many polar organic liquids have on starch acetates.

Starch acetate solutions exhibit viscosity effects characteristic of dissolved high polymers. Since the viscosity of a starch solution varies in relation to the size of the starch molecules, viscosity measurements have afforded a rapid means for following molecular breakdown, and, in addition, have provided information on the molecular weight and shape of the dissolved molecules.

Staudinger<sup>66, 67, 68</sup> has developed an empirical equation relating the viscosity of a polymer in dilute solution to its molecular weight:

$$\eta_{sp}/C = K_m M$$

Here  $\eta_{sp}$ , the specific viscosity, is equal to the relative viscosity minus one. Staudinger designates  $C$  as the concentration of the solution in basal moles or the number of moles of the polymeric repeating unit per liter; thus, for a starch acetate, it is the number of grams per liter divided by 288.  $K_m$  is a constant particular to a definite series of homologues measured in a definite solvent, and  $M$  is the molecular weight. Ordinarily, this equation is employed for viscosity values extrapolated to zero concentration. Although the relationship is by no means exact<sup>69-72</sup>

<sup>65</sup> H. Staudinger and H. Eilers, *Ber.*, **69B**, 819 (1936).

<sup>66</sup> H. Staudinger, *Ber.*, **59**, 3031 (1926).

<sup>67</sup> H. Staudinger and W. Heuer, *Ber.*, **63**, 222 (1930).

<sup>68</sup> H. Staudinger and G. V. Schulz, *Ber.*, **68**, 2320 (1935).

<sup>69</sup> H. Staudinger and H. Fischer, *J. prakt. Chem.*, **157**, 19 (1940).

<sup>70</sup> K. H. Meyer, *Kolloid-Z.*, **95**, 70 (1941).

<sup>71</sup> G. V. Schulz and P. Imglingerd, *J. prakt. Chem.*, **158**, 136 (1941).

<sup>72</sup> K. H. Meyer and E. Wolff, *Kolloid-Z.*, **89**, 194 (1939).

and the molecular weight value obtained must be interpreted with caution, the equation has been useful.

Using molecular weight values from osmotic pressure data, Staudinger<sup>28</sup> evaluated the  $K_m$  constant for partially degraded potato starch triacetate as  $1.02 \times 10^{-4}$  in chloroform,  $0.69 \times 10^{-4}$  in acetone, and  $0.69 \times 10^{-4}$  in *m*-cresol. Wheat starch triacetate in chloroform gave a value agreeing with that of potato starch triacetate. Since these  $K_m$  values are 5 to 10 times smaller than the  $K_m$  value for cellulose triacetate, Staudinger has concluded that the starch molecules are shorter, and, in addition, are probably branched. By plotting the value of Kraemer's<sup>72a</sup> intrinsic viscosity,  $[\eta]$ , against  $c$ , Mullen and Pacsu<sup>36</sup> obtained for potato

$$[\eta] = \frac{\ln \eta_{rel}}{c} \quad (c = \text{g. per 100 cc. soln.})$$

starch triacetate a straight line with a positive slope while cellulose acetate gave a straight line with a negative slope. From this, these workers concluded that starch acetate molecules in solution have a spherical or ellipsoidal form.

In some cases the solutions have exhibited structural effects, the nature or extent of which have not been fully established. Staudinger and Eilers<sup>65</sup> found that the viscosity of their starch triacetate solutions displayed little dependence on temperature and considered the acetate to be mono-dispersed. Higginbotham and Richardson,<sup>7</sup> on the other hand, found a noticeable temperature dependence for viscosities of carefully prepared potato starch triacetate in tetrachloroethane solutions. For example, a 0.25% solution was thixotropic at 25°, but not at 60°. The existence of structural effects in starch acetate solutions was likewise noted by Mullen and Pacsu<sup>36</sup> for potato starch triacetate dissolved in tetrachloroethane.

As a rule, the viscosity of potato starch triacetate solution appears to be higher than the viscosity of other starch acetates while the viscosity of waxy corn starch triacetate is lower than the viscosity of other starch acetates in keeping with the relative molecular weights of these starches.

Meyer and coworkers<sup>5</sup> have investigated the viscosities of "amylose" and "amylopectin" fractions obtained by hot water extraction. Such fractions probably are not pure (see page 261). They have shown that the reduced viscosity,  $\eta_{sp}/C$ , of their corn "amylose" triacetate in chloroform or in tetrachloroethane varies as a linear function of the concentration,  $C$ , whereas the reduced viscosity of corn "amylopectin" triacetate does not. Amylose triacetate exhibits a considerably higher viscosity than amylopectin triacetate of equal molecular weight. This is probably

<sup>72a</sup> E. O. Kraemer, *Ind. Eng. Chem.*, **30**, 1200 (1938).

due to the linear structure of the amylose molecules as contrasted to the coiled, branched, or more compact nature of the amylopectin molecules. Amylose triacetate solutions are, however, less viscous than cellulose triacetate solutions of equivalent molecular weight. This suggests that the amylose molecules are less extended than the cellulose molecules, and may possibly be arranged in a spiral shape.<sup>73</sup>

Starch acetate solutions, because of their stability, are suited for osmotic pressure measurements and have been employed with considerable success for direct molecular weight determinations.

Staudinger and Husemann<sup>28</sup> determined the osmotic pressure of solutions of a potato starch acetate which had been fractionated into four parts by precipitation of its chloroform solution with ether. The molecular weights of the fractions ranged from 45,000 to 275,000. All of the fractions were soluble in chloroform, but fractions of low molecular weight were also soluble in acetone. For various concentrations of solute in either chloroform or acetone, the osmotic pressure did not increase in direct proportion to the solute concentration, but the deviation from van't Hoff's law was the smallest in the case of the acetone solutions. Osmotic pressure measurements on "amylose" and "amylopectin" triacetates dissolved in tetrachloroethane have been made by Meyer and co-workers,<sup>5</sup> who have deduced molecular weights for these substances of approximately 78,000 and 300,000, respectively (see above discussion of the purity of these fractions).

Diffusion measurements<sup>74-77</sup> have been made on starch acetates dissolved in such solvents as acetic acid and acetic anhydride, and molecular weight values up to 224,700 have been indicated. Unfortunately, diffusion constants of starch fractions have been investigated only to a very limited extent. Diffusion measurements probably would provide evidence of value in the determination of the physical shape of the molecules of the two starch fractions; the rate of diffusion of the amylopectin acetate should conform most nearly to the normal hydrodynamic predictions for spherical macromolecules.

Starch acetate solutions have so far proved unsatisfactory for molecular weight measurements by either the cryoscopic or ebullioscopic<sup>45</sup> methods. Cryoscopic measurements in phenol or glacial acetic acid have generally given abnormally large freezing point depressions indicative of impossibly low molecular weight values for the starch acetate.

<sup>73</sup> K. Freudenberg, *Naturwissenschaften*, **27**, 841 (1939).

<sup>74</sup> M. Samec, *Kolloid-Beihfte*, **37**, 91 (1932).

<sup>75</sup> M. Samec and L. Knop, *Kolloid-Beihfte*, **39**, 438 (1934).

<sup>76</sup> M. Samec, *Kolloid-Z.*, **59**, 266 (1932).

<sup>77</sup> M. Samec, *Kolloid-Z.*, **64**, 321 (1933).

In other instances, the values did not correlate with those provided from other sources<sup>68</sup> and in at least one instance no freezing point depression was noted.<sup>45</sup> These effects have not been well explained, although similar anomalies have been observed with other high polymers.<sup>78, 79</sup> For example, in the case of cellulose derivatives, Freudenberg<sup>80</sup> has shown that the freezing point method is very susceptible to error, due both to a tendency of the solute to crystallize and to the probable presence of small amounts of impurities of low molecular weight.

#### 4. Optical Rotation

Optical rotations of starch acetates have, as a rule, been measured by means of the sodium-D-lines with chloroform or, less frequently, pyridine as the solvent. Although individual specific rotations have ranged from +128° to +276°, the values reported for triacetates prepared by mild treatments seem to lie relatively close together, as indicated in Table I.

TABLE I  
*Optical Rotation of Starch Triacetates*

<i>Investigators</i>	<i>Starch type</i>	$[\alpha]_D$ <i>In chloro- form</i>	<i>Tem- pera- ture</i> °C.
Hawkins, Jones, Young <sup>64</sup>	Banana	+167°	20
Hassid, Dore <sup>39</sup>	Canna	164	—
Hirst, Young <sup>32</sup>	Rice	171	20
Brigle, Schinle <sup>33</sup>	Rice	162.4	19
Haworth, Hirst, Woolgar <sup>35</sup>	Waxy corn	166	18
Baird, Haworth, Hirst <sup>17</sup>	Potato	177-179	18
Brigle, Schinle <sup>33</sup>	Potato	168.4	20
Reich, Damansky <sup>35</sup>	Potato	176.3	23
Hirst, Plant, Wilkinson <sup>33</sup>	Potato "amylose" <sup>a</sup>	170	19
Hirst, Plant, Wilkinson <sup>33</sup>	Potato "amylopectin" <sup>a</sup>	170	19
Freudenberg, Rapp <sup>81</sup>	Potato "amylose" <sup>b</sup>	172	20
		<i>In pyridine</i>	
Mullen, Pacsu <sup>36</sup>	Potato	+158°	22
" "	Tapioca	155	22
" "	Wheat	151	22
" "	Corn	156.5	22
" "	Rice	157.9	22

<sup>a</sup> Not pure; separated by aqueous extraction of the frozen paste. <sup>b</sup> Not pure; separated by electrodialysis.

<sup>78</sup> H. Staudinger and E. Dreher, *Ann.*, **517**, 73 (1935).

<sup>79</sup> H. Staudinger, W. Kern and J. J. Herrera, *Ber.*, **68**, 2346 (1935).

<sup>80</sup> K. Freudenberg, *Naturwissenschaften*, **17**, 959 (1929).

<sup>81</sup> K. Freudenberg and W. Rapp, *Ber.*, **69**, 2041 (1936).

Strict comparisons cannot be made among the optical rotations obtained by different investigators, however, because of the non-uniformity of the temperature and concentration of the measured solutions and the variation in the treatments which the starches received both before and during the acetylations. The similarity in rotations of the starch fractions suggests either that very little branching occurs in the amylopectin fraction or that the glucosidic linkages involved at the point of branching are similar in rotational value to the predominant  $\alpha$ -1,4-glucosidic linkage. From optical measurements on whole starch, Meyer, Hopff and Mark<sup>82</sup> have concluded that  $\beta$ -linkages cannot occur in considerable numbers. This observation has also been supported by other lines of work.<sup>83, 84</sup>

### 5. Fusion Temperature

The fusion temperatures of starch triacetates are not sharp, but cover a range of 20–50°. High grade starch triacetates, in capillary tubes, generally fuse between 280–300°. This high fusion temperature, which is equivalent to that for cellulose triacetate, is again an indication of the high degree of association which exists between the starch acetate molecules.

### 6. Mechanical Properties

Physical and mechanical properties of starch esters are of interest not only because they aid in the characterization of an ester, but also because they provide information from which extensive deductions may be drawn regarding the architecture of starch molecules. Thus, the general property of whole-starch esters to form brittle plastics and films must arise from fundamental structural causes which *a priori* might be attributed to: (1) a relatively low molecular weight; (2) a tangled or branched configuration; or (3) the presence of several components of which one capable of forming films is prevented from so doing by a second component having poor film-forming properties. An insight into the causative factor for brittleness was given by Meyer and co-workers,<sup>5</sup> who reported that their "amylose" triacetate yielded strong films, whereas their "amylopectin" triacetates did not; this indicates that the third possibility listed above is the most likely one.

A quantitative investigation of the film-forming properties of acetylated starch fractions<sup>85</sup> obtained by the butanol precipitation method of Schoch has substantiated this belief and has revealed that, while the

<sup>82</sup> K. H. Meyer, H. Hopff and H. Mark, *Ber.*, **62**, 1103 (1929).

<sup>83</sup> W. Kuhn, *Ber.*, **63**, 1503 (1930).

<sup>84</sup> K. Freudenberg, W. Kuhn, W. Dürr, F. Bolz and G. Steinbaum, *Ber.*, **63**, 1510 (1930).

<sup>85</sup> R. L. Whistler and G. E. Hilbert, *Ind. Eng. Chem.*, **36**, 796 (1944).

triacetates of both starch fractions are capable of producing clear, transparent, lustrous films, only amylose triacetate (called fraction A by Schoch) is capable of forming films having high tensile strengths and good extensibilities.

Typical stress-strain curves for this unplasticized amylose triacetate film and for film containing 20% dibutyl phthalate plasticizer are shown

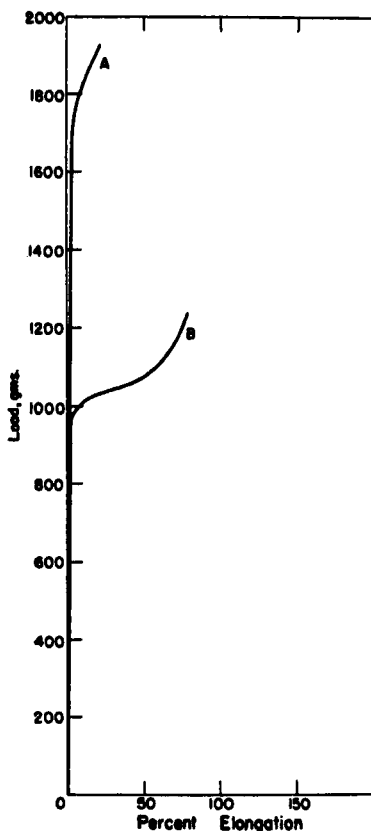

FIG. 1. Stress-strain relationship of amylose triacetate film containing  
(A) no plasticizer, and  
(B) dibutyl phthalate plasticizer.

in Fig. 1. Application of an increasing stress to the unplasticized film (Curve A) produces a considerable elastic deformation which obeys Hooke's law. When the yield value is reached and plastic flow sets in, the curve continually bends away from the stress coordinate, indicating an increase in the rate of flow as stress is applied. Plastic flow con-

tinues to an elongation of about 22%, at which point the film ruptures. The relatively long period of plastic flow is evidence that the film possesses considerable inherent plasticity.

Plasticizers greatly modify the stress-strain properties of the film. In their presence the elastic deformation is decreased, the yield value is lower, the pliability is increased and the character of the plastic flow is changed. This latter effect is most pronounced in films containing about 20% plasticizer (Curve B). In such films, after the yield value is attained, plastic flow commences and proceeds at an increasing rate as stress is applied until the film has elongated 20–30%, whereupon the stress-strain curve rises sharply and becomes concave to the stress axis. This is evidence of an increasing resistance to the applied stress and the development of greater strength within the film. By analogy to the behavior of other high polymers, it may be inferred that the amylose acetate molecules are of a linear nature and are therefore susceptible of organization during stretching of the film. Further evidence of molecular organization in the film is the development, during the elongation, of optical anisotropy.

Amylose acetate films (prepared by acetylation of the A-fraction) in hot water may be elongated 600–1,000% and will set to the new length when cooled. These films have greatly increased tensile strengths. When ruptured under stress, they split in lines parallel to the direction of orientation, which is a further indication of a parallel organization in the film. Confirmatory evidence that stretching produces orientation in these acetate films has been obtained by X-ray analysis.<sup>86</sup> X-ray diffraction patterns taken during the stretching of films clearly indicate a progressive change from an amorphous to a highly crystalline condition wherein the molecules tend to become arranged with their long axes parallel to the direction of elongation. The ease and high degree to which amylose acetate molecules can be oriented by stretching are the best evidence yet obtained for the linear nature of amylose molecules.

In general, the properties of these amylose triacetate films are very similar to those of cellulose triacetate films. A comparison of some of their properties is given in Table II.

Amylose triacetate prepared from butanol-precipitated starch may be plasticized with almost any of the common plasticizers which are applicable to the plasticization of cellulose triacetate. For example, some suitable plasticizers are: dimethyl or diethyl tartrate, tributyl citrate, tributyl phosphate, tricresyl phosphate, polyethylene glycol, and pentaerythritol tetraacetate. Addition of only 10–20% plasticizer is sufficient to give amylose triacetate films a useful and lasting degree of

<sup>86</sup> R. L. Whistler and N. C. Schieltz, *J. Am. Chem. Soc.*, **65**, 1436 (1943).



TABLE II

*Comparison of Properties of Unplasticized Films of Amylose Triacetate and Cellulose Triacetate*

<i>Property</i>	<i>Amylose triacetate film</i>	<i>Cellulose triacetate film</i>
Tensile strength (kg./mm. <sup>2</sup> )	7.9-8.6	8.0-10.0*
Elongation at break (%)	22	4
Refractive index	1.47	1.48
Density	1.34	1.4
Hardness, Rockwell	M60-65	—
Modulus of elasticity (kg./m. <sup>2</sup> × 10 <sup>8</sup> )	2.3	—

\* For high grade laboratory preparations.

plasticity. Because of their high quality and low plasticizer requirements, these films appear to be well suited for industrial use.

Paralleling their film-forming properties, these amylose triacetates can be molded into strong, tough plastics, but the amylopectin triacetates yield only very brittle products. Similarly, Mullen and Pacsu<sup>87</sup> have shown that whole starch acetate produces clear, transparent, molded pieces which, however, are brittle.

Since amylopectin acetate produces only brittle films and plastics, its molecules probably have a non-linear structure which may be branched or coiled. A further striking difference between amylose triacetate and amylopectin triacetate is that the former can be obtained in the form of a highly fibrous mass, whereas the latter occurs only as a fine powder.

As amylopectin predominates in all known starches, the poor film-forming properties of whole starch acetates become understandable. Artificial mixtures of amylose and amylopectin triacetates (acetylated fractions A and B) show increasingly poor film-forming properties as the proportion of amylopectin acetate in the mixture is increased.

Starch acetates normally contain 2 to 3% moisture. They have a strong binding power for water as is indicated by the observation that an unplasticized amylose (fraction A) triacetate film soaked in water will lose about one-third of its tensile strength.

## V. PREPARATION AND PROPERTIES OF OTHER ORGANIC ESTERS OF STARCH

### 1. *Starch Formate*

Formic acid gelatinizes starch<sup>80, 88, 89</sup> at room temperature, and at the end of twenty-four hours produces a starch monoformate which is stained

<sup>87</sup> J. W. Mullen and E. Pacsu, *Ind. Eng. Chem.*, **35**, 381 (1943).

<sup>88</sup> D. Gottlieb, C. G. Caldwell and R. M. Hixon, *J. Am. Chem. Soc.*, **62**, 3342 (1940).

<sup>89</sup> A. G. Kldiaschwili, *J. Russ. Phys. Chem. Soc.*, **36**, 905 (1904); *J. Chem. Soc.*, **86**, Part 1, 798 (1904).

red-brown by iodine. Longer reaction periods produce no additional ester formation. The monoformate is also produced by heating starch in formic acid for thirty minutes. An attempt to obtain a higher degree of esterification by increasing the reaction period has resulted in considerable depolymerization of the starch, although a product analyzing as a triformate is ultimately obtained.

### 2. Starch Propionate and Butyrate

Starch propionates, with various degrees of propionation up to the tripropionate, have been prepared by refluxing corn starch with propionic acid and propionic anhydride.<sup>90</sup> The lower propionates are water-soluble, but the tripropionate is soluble only in organic solvents. Starch tripropionate and starch tributyrates are easily prepared by treating swollen starch with pyridine and the acid anhydride.<sup>96</sup> These triesters are more soluble in organic solvents than the starch triacetates.

Both starch tripropionate and tributyrates form clear plastics<sup>97</sup> which, although brittle, are somewhat softer than those of typical whole-starch triacetates. This fact is in keeping with similar results noted for cellulose esters and sustains the view that the mutual attraction of the starch chains is continually rendered less effective as the aliphatic chain increases in length.

### 3. Starch Chloroacetates

Starch esters of either mono-, di-, or trichloroacetic acid can be prepared<sup>90, 91</sup> by heating starch with the appropriate acid or by treatment with the acid anhydride and sulfuric acid.<sup>92</sup> Starch triacetates can be chlorinated by phosphorus pentachloride at 135–140° to produce a starch trichloroacetic ester.<sup>92</sup>

### 4. Starch Esters of Higher Fatty Acids

Higher aliphatic esters of starch are generally prepared by treating starch with the acid chloride in the presence of alkali or a tertiary organic base<sup>93–95</sup> such as pyridine,<sup>95–97</sup> quinoline,<sup>98</sup> picoline,<sup>99</sup> or dimethylani-

<sup>90</sup> D. E. Mack and R. N. Shreve, *Ind. Eng. Chem.*, **34**, 304 (1942).

<sup>91</sup> A. G. Kldiaschwili, *J. Russ. Phys. Chem. Soc.*, **37**, 421 (1905); *J. Chem. Soc.*, **88**, Part I, 634 (1905).

<sup>92</sup> H. Rudy, *Cellulosechemie*, **13**, 49 (1932).

<sup>93</sup> M. Hagedorn, U. S. Pat. 1,994,608 (1935).

<sup>94</sup> I. G. Farbenindustrie, French Pat. 668,686 (1929).

<sup>95</sup> P. Berthon, German Pat. 484,242 (1923).

<sup>96</sup> H. Gault and P. Ehrmann, *Chimie & industrie*, Special No. 574 (1924).

<sup>97</sup> P. Berthon, U. S. Pat. 1,651,366 (1927).

<sup>98</sup> P. Karrer and Z. Zega, *Helv. Chim. Acta*, **6**, 822 (1923).

<sup>99</sup> E. Lorand, *Cellulosechemie*, **13**, 185 (1932).

line.<sup>100</sup> In some cases, the acid anhydride has been used in place of the acid chloride. Thus, Genin<sup>101</sup> prepared an incompletely esterified starch stearate by use of stearic anhydride on gelatinized starch.<sup>99</sup> In similar ways, other starch esters, such as the laurates, myristates, palmitates and stearates have been prepared. The following three procedures are typical of the preparative methods used.

Starch dilaurate<sup>102</sup> is prepared by treating 1 part of dry starch in 2.5 parts of pyridine and 3 parts of toluene with 5 parts of lauroyl chloride for two hours at 100°. The product is soluble in benzene, chloroform, and halogen derivatives of acetylene, but is insoluble in water, alcohol, and acetone. On evaporation of a benzene-chloroform solution it forms a brittle film.

Starch palmitate is prepared by treating 1 part of starch in a mixture of 4 parts of benzene and 1.8 parts of pyridine with 6 parts of palmitoyl chloride and 4 parts of benzene for thirty minutes at 60° and precipitating the product with ethanol. Quinoline<sup>98</sup> may be substituted for the benzene and pyridine. Because of the high boiling point of quinoline, an elevated esterification temperature can be used and triesters produced<sup>99</sup> in about three hours.

Starch laurate benzoate is prepared by mixing equal parts of starch and of a 40% sodium hydroxide solution, heating in benzene to the reflux temperature and then adding slowly a mixture of benzoyl chloride and lauroyl chloride. After a few minutes, the mixed ester is formed.

### 5. Starch Tosylate

Starch, swollen in pyridine for several days, reacts<sup>103</sup> evenly with tosyl chloride (*p*-toluenesulfonyl chloride) in pyridine at 20° to produce, after nine days, a tritosyl starch which is insoluble in ordinary solvents and decomposes at 235°. On treatment with sodium iodide in acetone at 100° for three days, the ester is converted to a 2,3-ditosyl-6-iodostarch. Treatment of the tritosyl or the ditosyliodostarch with a mixture of hydrobromic acid and glacial acetic acid leads to the formation of 1- $\alpha$ -bromo-2,3,6-tritosyl-4-acetylglucose or 1- $\alpha$ -bromo-2,3-ditosyl-4-acetyl-6-iodoglucose, respectively.<sup>104-106</sup>

<sup>100</sup> L. Rosenthal and W. Lenhard, U. S. Pat. 1,739,863 (1929).

<sup>101</sup> G. Genin, *Rev. gen. Mat. Plast.*, **12**, 5 (1936).

<sup>102</sup> H. Gault, *Compt. rend.*, **177**, 592 (1923).

<sup>103</sup> K. Hess and R. Pflieger, *Ann.*, **507**, 48 (1933).

<sup>104</sup> K. Hess, O. Littmann and R. Pflieger, *Ann.*, **507**, 55 (1933).

<sup>105</sup> K. Hess and O. Littmann, *Ber.*, **67**, 465 (1934).

<sup>106</sup> K. Hess and W. Eveking, *Ber.*, **67B**, 1908 (1934).

### 6. *Starch Benzoate and Cinnamate*

Starch benzoate may be prepared by treating dry starch in pyridine with benzoyl chloride at 75° for 72 hours. A mixture of di- and tri-benzoates is said to result.<sup>85,107</sup> The separated tribenzoate is soluble in pyridine, acetone, and chloroform, but is insoluble in alcohol and ether. In chloroform its optical rotation is  $[\alpha]_D^{22} + 80^\circ$ . After starch is swollen in pyridine, the addition of benzoyl chloride causes a slow benzylation at room temperature.<sup>108</sup> The tribenzoate is produced in about twelve days.

Reich and Damansky<sup>85</sup> claim that cinnamoyl chloride in pyridine reacts slowly with dry starch when heated to 75°, and produces a mixture of di- and tricinnamate.

Other derivatives, such as the 3,4-dichlorobenzenesulfonyl ester of starch,<sup>108</sup> have also been prepared by treating starch with the acid chloride in the presence of sodium hydroxide.

## VI. PREPARATION AND PROPERTIES OF INORGANIC ESTERS OF STARCH

### 1. *Starch Nitrate*

Nitric acid esters of starch are the oldest known starch derivatives and are the only starch esters commercially produced on a large scale. Like cellulose nitrates, the starch nitrates are excellent explosives. They are used extensively in blasting compositions, for quarrying and for certain types of mining. Tapioca starch was used mainly for commercial nitrations in the United States until the advent of World War II and the disruption of supplies made it necessary to nitrate corn starch. This transition has been accomplished with little difficulty, although the exact process used is a trade secret.

Braconnot,<sup>109</sup> in 1833, prepared the first starch nitrate by dissolving potato starch in cool, concentrated nitric acid and precipitating the product by the addition of water. He designated his product xylöidine. Since then, a large number of investigations of starch nitration have been reported in the scientific and patent literature. A concise review of the older work is given by Kessler and Röhm.<sup>110</sup>

Whole starches may be nitrated at temperatures of 8–25° by nitric acid alone or by mixtures of nitric acid with either sulfuric acid or

<sup>107</sup> A. F. Damansky, *Comp. rend. soc. biol.*, **114**, 1051 (1933).

<sup>108</sup> A. A. Houghton, British Pat. 493,513 (1938).

<sup>109</sup> H. Braconnot, *Ann. chim. phys.*, [2], **52**, 290 (1833).

<sup>110</sup> H. Kessler and R. Röhm, *Z. angew. Chem.*, **35**, 125 (1922).

phosphoric acid. Depending upon the temperature and the length of treatment, the products generally possess 6–14% nitrogen. Considerable difficulty seems to be involved in producing a uniform trinitrate containing the theoretical 14.14% nitrogen. In general, the starch nitrate preparations are soluble in acetone, acetic acid, chloroform, and in mixtures of alcohol and ether, but are insoluble in alcohol or ether alone.

Will and Lenze<sup>111</sup> treated rice starch with nitric acid (*d.* 1.5) at 8° for 24 hours, added sulfuric acid and washed the precipitate with water and alcohol. The product contained 14.04% nitrogen, was insoluble in alcohol, but was soluble in acetone and acetic acid. It was relatively stable, showing a flash point at 194°. Under the same conditions, but nitrating with a mixture of 10 parts of nitric acid and 20 parts of sulfuric acid, they obtained a product containing 13.9% nitrogen. Holmes<sup>112, 113</sup> has advised the use of 25 parts of starch in 100 parts of mixed acid composed of 32.5% nitric acid and 64.5% sulfuric acid. As might be expected from the known ease with which the starch is hydrolyzed, a considerable depolymerization of the starch occurs during the nitration reaction. Berl and Bütler<sup>114</sup> have used a mixture containing equal parts of nitric acid and fuming sulfuric acid for thirty minutes at 10° to nitrate potato, wheat, rice, and soluble starches. They obtained products containing about 12.9–13.8% nitrogen, but noted that a 5% solution of cellulose nitrate in acetone has a viscosity nine thousand times greater than the corresponding starch nitrate. This suggests that the starch nitrate is of low molecular weight.

In order to minimize the starch hydrolysis, Berl and Kunze<sup>115</sup> substituted phosphoric acid for sulfuric acid in the nitration mixture.

One part of dry starch was suspended in 25 parts of concentrated phosphoric acid at 0° and, to the slowly stirred solution, there was added an equal volume of cold, concentrated nitric acid. Nitration proceeded rapidly, reaching a maximum value of 13.0% nitrogen. The viscosity of the product rose to a flat maximum after twelve hours of nitration; the end viscosity value was about tenfold higher than in the similar case where sulfuric acid was employed. Best results were obtained when the reaction mixture contained about 6% moisture. The product was stable up to 180°.

Staudinger and Husemann,<sup>28</sup> using this method, prepared a starch

<sup>111</sup> W. Will and F. Lenze, *Ber.*, 31, 68 (1898).

<sup>112</sup> F. B. Holmes, U. S. Pat. 779,421 (1905).

<sup>113</sup> F. B. Holmes, U. S. Pat. 779,422 (1905).

<sup>114</sup> E. Berl and R. Bütler, *Z. ges. Schiess- u. Sprengstoffw.*, 5, 82 (1910); *J. Soc. Chem. Ind.*, 29, 373 (1910).

<sup>115</sup> E. Berl and W. C. Kunze, *Ann.*, 520, 270 (1935).

nitrate which contained 12.6–12.8% nitrogen corresponding to 2.5 nitrate groups per anhydroglucose unit. From osmotic pressure measurements, they considered that the starch molecule is 36–46% degraded during nitration by this method, whereas a 40–70% degradation occurs if sulfuric acid is used in the nitration. When either sulfuric or phosphoric acid is employed as a nitration catalyst, small amounts of these acids become esterified with the starch.

By solvent fractionation, a number of investigators<sup>115–118</sup> have been able to separate starch nitrate preparations into several fractions, some of which differ from each other in their nitrogen contents.

Although early preparations of starch nitrates were unstable and hazardous to handle, stabilizing treatments have been developed which have made the compounds relatively safe. Production of stable products requires the use of purified starches and the thorough washing of the starch nitrate to remove all traces of acid. The nitrate may be washed in hot water or with water containing neutralizing agents such as carbonates<sup>119, 120</sup> or other alkaline solutions.<sup>121</sup> The nitrate may also be stabilized by the addition of aniline<sup>121</sup> or methanol.<sup>115</sup>

Denitration with regeneration of a soluble starch occurs on treatment of the nitrate with ammonium hydrogen sulfide,<sup>122</sup> or alcoholic potassium hydroxide solution.<sup>123</sup>

## 2. Starch Phosphate

Amylopectin of potato starch and probably amylopectin of other tuber starches occurs as a natural ester of phosphoric acid. Potato "amylopectin" contains approximately 0.07–0.09% phosphorus,<sup>124–128</sup> or one phosphate group for every 212 to 273 anhydroglucose units. The phosphate appears to be attached mainly to the primary alcohol group since, on hydrolysis, potato "amylopectin" (separated by electro dialysis)

<sup>115</sup> H. Pringsheim, J. Leibowitz and S. H. Silmann, *Ber.*, **58**, 89 (1925).

<sup>117</sup> T. Urbanski and J. Hackel, *Chem. Zentr.*, **I**, 1938–9 (1940).

<sup>118</sup> W. O. Snelling and G. E. Rees, U. S. Pat. 2,271,877 (1942).

<sup>119</sup> S. S. Sadler, U. S. Pat. 1,211,761 (1917).

<sup>120</sup> J. Helle and A. Kunz, U. S. Pat. 2,127,360 (1938).

<sup>121</sup> A. Nobel, German Pat. 57,711 (1891).

<sup>122</sup> H. F. Brown and J. H. Millar, *J. Chem. Soc.*, **75**, 308 (1899).

<sup>123</sup> E. Berl and W. Smith, *J. Soc. Chem. Ind.*, **27**, 534 (1908).

<sup>124</sup> M. Samec, *Kolloidchem. Beihefte*, **6**, 23 (1914).

<sup>125</sup> M. Samec and H. Haeratl, *Kolloidchem. Beihefte*, **12**, 281 (1920).

<sup>126</sup> M. Samec and A. Mayer, *Compt. rend.*, **172**, 1079 (1921); **173**, 321 (1921).

<sup>127</sup> M. Samec and A. Mayer, *Kolloidchem. Beihefte*, **16**, 89 and 91 (1922); **13**, 272 (1921).

<sup>128</sup> H. C. Sherman and J. C. Baker, *J. Am. Chem. Soc.*, **38**, 1885 (1916).

produces appreciable amounts of glucose-6-phosphate.<sup>129</sup> Probably due to its esterified phosphoric acid, this potato "amylopectin" shows a strong anodic migration<sup>130-132</sup> which has permitted Samec to separate it from the "amylose" by electro dialysis.

Mild acid hydrolysis does not easily remove the esterified phosphorus,<sup>133-136</sup> although prolonged treatment with hot water causes slow hydrolysis of the phosphate.<sup>137</sup> Alkali,<sup>138</sup> as well as various amylophosphorylases quickly dephosphorylate starch fractions.

Starch has been phosphorylated by treating it in aqueous solution with phosphorus oxychloride and calcium carbonate.<sup>127, 139</sup> This treatment, which introduces 1-2% phosphorus, also increases the conductivity and viscosity of the starch pastes.

### 3. Starch Sulfate

Starch, when stirred with concentrated sulfuric acid, is degraded and at the same time esterified<sup>140-144</sup> to form sulfuric esters capable of yielding insoluble lead, calcium, and barium salts. Degradation of the starch is decreased if it is added slowly and with stirring to a warm mixture of dry pyridine, chlorosulfuric acid, and anhydrous chloroform. After two hours, a product may be recovered by precipitation and washing in dry methanol. In this way, Tamba<sup>145</sup> has isolated a sulfuric acid diester of starch. The sulfuric acid esters are unstable in aqueous solutions and hydrolyze readily with the liberation of sulfuric acid.

<sup>129</sup> T. Posternak, *Helv. Chim. Acta*, **18**, 1351 (1935).

<sup>130</sup> A. Coehn, *Z. Electrochem.*, **4**, 63 (1897).

<sup>131</sup> F. Bottazzi and C. Victorow, *Atti accad. Lincei*, **19**, II, 7 (1910); *C. A.*, **5**, 1406 (1911).

<sup>132</sup> Z. Gruzewska, *J. physiol. path. gen.*, **14**, 7 (1912); *C. A.*, **7**, 89 (1913).

<sup>133</sup> A. Fernbach, *Compt. rend.*, **138**, 428 (1904).

<sup>134</sup> H. Tryller, *Chem.-Zeit.*, **44**, 833 (1920).

<sup>135</sup> E. Fouard, *Compt. rend.*, **144**, 501 (1907).

<sup>136</sup> J. H. Northrop and J. M. Nelson, *J. Am. Chem. Soc.*, **38**, 472 (1916).

<sup>137</sup> M. Samec and A. Mayer, *Kolloidchem. Beihefte*, **12**, 1228 (1920).

<sup>138</sup> M. Samec and F. Hoeffft, *Kolloidchem. Beihefte*, **5**, 141 (1913).

<sup>139</sup> J. Kerb, *Biochem. Z.*, **100**, 2 (1919).

<sup>140</sup> B. Carolles, *Rev. sci. industrial Paris*, **15**, 69 (1843).

<sup>141</sup> H. Fehling, *Ann.*, **55**, 13 (1845).

<sup>142</sup> J. Kalinowsky, *J. prakt. Chem.*, **35**, 193 (1845).

<sup>143</sup> M. Koenig and S. Schubert, *Monatsh.*, **6**, 708 (1885).

<sup>144</sup> M. Koenig and S. Schubert, *Monatsh.*, **7**, 455 (1886).

<sup>145</sup> R. Tamba, *Biochem. Z.*, **141**, 274 (1923).

4. *Starch Xanthate*

Starch, like cellulose, reacts with alkali and carbon disulfide to form xanthates. Cross, Bevan and Briggs<sup>146</sup> treated 22 g. of starch with 11 g. of carbon disulfide dissolved in 10 g. of toluene and then added, with stirring, 55 g. of sodium hydroxide in the form of a 20% solution in water. A yellow solution soon formed with an appearance similar to that of viscose. In this manner, between one and two xanthate groups per glucose unit are ordinarily introduced,<sup>147</sup> but a higher degree of xanthation is more difficult to attain. The starch xanthates, in general, undergo the same types of reactions as are found for the more widely studied cellulose xanthates. On aging, a slow decrease occurs in the amount of bound carbon disulfide. The xanthate is decomposed with the regeneration of starch and carbon disulfide by the addition of mineral acids, strong acetic acid, or by heat alone. A purified starch xanthate may be obtained by decomposing the inorganic thiocarbonates by the addition of dilute acetic acid to the crude solution, and then precipitating the starch xanthate with alcohol. A solution of purified starch xanthate on contact with iodine produces a dixanthate in apparently quantitative yield.

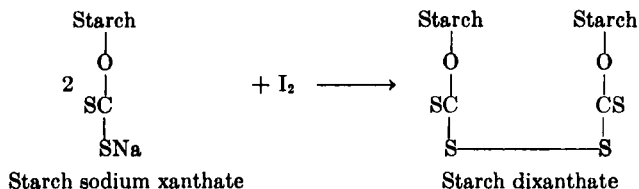

Treatment of the xanthate with such compounds as benzene diazonium chloride is said to replace the sodium with phenyl to produce an entirely organic dithiocarbonate.<sup>148</sup>

Starch xanthates have been suggested for use as adhesives for wood veneers,<sup>149</sup> and as textile sizes.<sup>150</sup>

<sup>146</sup> C. F. Cross, E. J. Bevan and J. F. Briggs, *J. Chem. Soc.*, 91, 612 (1907).

<sup>147</sup> H. Ost, F. Westhoff and L. Gessner, *Ann.*, 382, 340 (1911).

<sup>148</sup> J. H. Holberger, German Pat. 662,180 (1932).

<sup>149</sup> K. Stern, U. S. Pat. 1,412,020 (1922).

<sup>150</sup> R. Elssner, U. S. Pat. 2,000,887 (1933).



This Page Intentionally Left Blank

# CELLULOSE ESTERS OF ORGANIC ACIDS

BY CHARLES R. FORDYCE

*Eastman Kodak Co., Rochester, N. Y.*

## CONTENTS

A. Commercial Development . . . . .	309
B. Preparation . . . . .	310
I. Raw Materials . . . . .	310
II. Cellulose Acetate . . . . .	311
1. Acetylation Processes . . . . .	311
2. Modified Processes . . . . .	313
3. Partial Esterification . . . . .	314
4. Viscosity . . . . .	315
5. Salt Effect . . . . .	317
III. Mixed Esters . . . . .	317
IV. Other Organic Esters . . . . .	318
1. Esterification Methods . . . . .	318
2. Esters of Higher Aliphatic Acids . . . . .	319
3. Esters of Unsaturated Acids . . . . .	319
4. Esters of Substituted Aliphatic Acids . . . . .	319
5. Esters of Aromatic Acids . . . . .	320
6. Esters of Dibasic Acids . . . . .	320
7. Esters of Sulfonic Acids . . . . .	321
8. Carbamates . . . . .	321
C. Industrial Applications . . . . .	322
I. Production Trends . . . . .	322
II. Textiles . . . . .	322
III. Protective Coatings . . . . .	323
IV. Films . . . . .	325
V. Molding Compositions . . . . .	326

### A. Commercial Development

Large scale industrial development of cellulose esters of organic acids has taken place during the past twenty years. At the beginning of the World War in 1914 cellulose acetate was in the early stages of commercial manufacture. Its use for aircraft fabrics at that time brought about

production capacity in excess of its normal development; and at the end of the war there was need of suitable peacetime uses for the material. Cellulose acetate rayon proved to be the most favorable outlet, and with the rapid growth of this industry, together with a steady and rapid drop in the cost of raw materials, cellulose acetate production has increased rapidly. Uses other than rayon have developed, including plastics, photographic films and other forms of sheeting, and a variety of miscellaneous applications.

It is natural that with the growing interest in cellulose acetate, chemists have investigated other organic cellulose esters. Cellulose formate, the ester of the lowest member of the fatty acid series, has been studied sufficiently to show that it is unlikely to be of commercial importance.<sup>1,2</sup> It is difficult to produce a high degree of esterification of cellulose with this acid, and the ester which is obtained is very limited in solubility, and is highly unstable toward moisture and elevated temperatures.

Esters of acids which have higher molecular weights than acetic acid change rapidly in physical properties as the molecular weight of the acid becomes greater. They exhibit wide ranges of solubility in organic solvents and become increasingly compatible with resinous materials. Resistance to moisture is greatly increased. These esters, however, have lower melting points and less tensile strength than cellulose acetate.

For a wider range of properties, cellulose mixed esters have proved to be superior to the single esters, combining satisfactory strength with increased solubility and resistance to moisture as compared to the acetate. Cellulose acetate propionates and acetate butyrates have become commercially prominent, particularly in the fields of photographic films, plastics and lacquers.

Other cellulose esters of organic acids, including those of substituted and polybasic acids, have been studied in detail and will be described in sections to follow. Their cost of manufacture is in general greater than that of the more simple esters, and their uses are confined to cases in which special properties are required.

## B. Preparation

### I. RAW MATERIALS

The most dependable source of cellulose for the manufacture of cellulose esters has been cotton linters, which is a by-product of the

<sup>1</sup> G. Tocco, *Giorn. chim. ind. applicata*, **13**, 325, 414 (1931).

<sup>2</sup> Y. Ueda and T. Shimada, *Cellulose Ind.* (Tokyo), **15**, 426 (1939).

cottonseed oil industry. Linters are obtained as short fibers on cotton seeds after the long fiber has been removed. When cottonseed oil became an important commercial item, linter fibers were removed to improve recovery of the oil, without serious consideration of their value. The material was found to be readily purified to yield high quality cellulose and, following the practice in the manufacture of cellulose nitrate, was adopted for acetylation.

Purification of cotton linters involves the steps of first removing impurities by mechanical means, and then digesting in alkaline "cooks," followed by bleaching and drying. The process produces cellulose of about 99%  $\alpha$ -cellulose, less than 0.1% ash, 0.002% iron, and less than 0.2% lignin. It can be obtained with high cuprammonium viscosity, which is controlled to the desired range during purification.

It has been demonstrated that wood cellulose can also be employed for the commercial manufacture of cellulose esters. Several descriptions of suitable purification processes have appeared in the technical literature.<sup>3,4,5</sup> The material has now attained large industrial use and when properly purified approaches the quality of cotton cellulose. Important considerations in the preparation of wood pulp for acetylation are the proper removal of impurities to yield a product of high alpha cellulose content without severe loss of viscosity, and with retention of uniform reactivity of the cellulose toward acetylation. Color and haze in the acetylated product are difficult to eliminate to the degree possible with cotton linters.

## II. CELLULOSE ACETATE

### 1. Acetylation Processes

Uniformity of reaction is a very important factor in the commercial manufacture of cellulose esters. Direct acetylation of native celluloses with acetic anhydride and catalyst yields hazy, non-uniform products. For this reason, early investigators recommended as the starting material regenerated cellulose or cellulose which had received strong treatment with mineral acid or salts such as zinc chloride. Later, in commercial processes, suitable esterification methods for use with native cellulose were developed, usually involving a pretreatment prior to the esterification. Soaking with acetic acid was early shown to give great improvement in quality.<sup>6</sup> This is a practical treatment, since acetic acid is commonly used as an esterification solvent and is always a component of

<sup>3</sup> D. Krüger, *Zellstoff-Faser*, 32, No. 3, 33 (1935).

<sup>4</sup> G. A. Richter, U. S. Pat. 1,709,322 (April 16, 1929); 2,041,958 (May 26, 1936).

<sup>5</sup> F. Olsen, *Ind. Eng. Chem.*, 30, 524 (1938).

<sup>6</sup> A. Wohl, Brit. Pat. 20,527 (July 17, 1913); French Pat. 448,072 (Jan. 22, 1913).

the reaction bath, because of its formation from the anhydride during acetylation. Acetic acid pretreatment with or without the acetylation catalyst is therefore widely used in commercial processes.

A theoretical explanation of the pretreatment action is that the acetic acid soaking greatly reduces the hydrogen bonding of cellulose chains to each other; thus, it permits much better diffusion of anhydride into the inner structure of the cellulose, and the rate of diffusion is more uniform than would otherwise be possible.

The most commonly employed catalyst for acetylation with acetic anhydride is sulfuric acid. This catalyst was one of the first used with cellulose in the studies of Franchimont in 1879.<sup>7</sup> Practical difficulties in the use of sulfuric acid, particularly because of the formation of sulfate esters which were unstable, led to a search for other catalytic agents. A variety of mineral and organic acids and salts have been suggested. Zinc chloride, which was also used in the early studies of Franchimont, proved to be among the most effective agents, if used in large quantities. With the addition of a small amount of hydrochloric acid to this material, activity approaching that of sulfuric acid is obtained. Some commercial use of this catalyst mixture was made, but later this was given up because of the large amount of salt required, and because the corrosive nature of the salt interfered with the recovery of acetic acid from aqueous solution. Perchloric acid was found to be an exceptionally strong catalyst,<sup>8,9</sup> but has also been kept from commercial use because of corrosion of equipment.

Theoretical studies have explained the behavior of these acids as catalytic agents. The effective strength of acidity is the controlling factor in the esterification reaction. This esterification is in a non-aqueous system, usually in the presence of acetic acid as a solvent. The explanation must therefore be approached on the basis of a non-aqueous system. When acetic acid is the solvent medium, this material is considered to combine with hydrogen ions in a manner corresponding to water in aqueous systems, giving the following parallel equations:

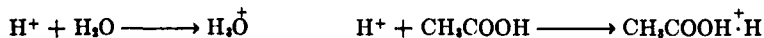

Acetic acid in this system may be considered as slightly basic since it combines with hydrogen ions. Salts such as sodium acetate become strong bases. Acids may vary from their corresponding strengths in aqueous solutions in a manner dependent upon the relative tendencies of water and acetic acid to take up hydrogen ions. Measurements have

<sup>7</sup> A. Franchimont, *Compt. rend.*, **89**, 711 (1879).

<sup>8</sup> C. J. Malm, U. S. Pat. 1,645,915 (Oct. 18, 1927).

<sup>9</sup> D. Krüger and F. Höhn, German Pat. 519,877 (Nov. 5, 1931).

shown the following order of strengths of acids in acetic acid:

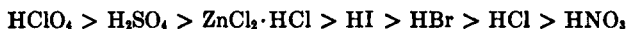

Conant and Hall<sup>10</sup> termed perchloric and sulfuric acids "super-acids" in acetic acid because of their exceptional strength as compared with other acids. Hydrochloric and nitric acids are only slightly stronger than acetic acid itself.

Commercial experience with sulfuric acid as a catalyst has largely overcome the difficulty of combined sulfate by controlling the processes to maintain insignificant amounts in the product. Most cellulose esters are subjected, after esterification, to partial hydrolysis, during which treatment sulfate groups are largely removed. Fully esterified products, on the other hand, require suitable stabilization treatments. These include boiling water treatments, which are more effective if the water is slightly acid,<sup>11</sup> or by treatments above the normal boiling point of water,<sup>12,13</sup> such as are attained by use of superheated steam or autoclaves. The small amount of sulfate remaining after these treatments may be neutralized by salts, such as those naturally present in the processing water.

## 2. Modified Processes

Various details of procedure are known for the esterification of cellulose with acetic anhydride in acetic acid solvent. The factors of pre-treatment, catalyst concentration, acetylation temperature and time of reaction are kept in balance in order that products of satisfactory appearance and the desired range of viscosity will be obtained. Modifications of this general formula usually involve the use of different solvents to replace part or all of the acetic acid.

Solvents employed for such modified procedures must not affect the esterification reaction or the catalyst. Halogenated hydrocarbons are among the most interesting materials which have been used.<sup>14, 15, 15a</sup> A process employing methylene chloride has achieved commercial use. This material is an excellent solvent for cellulose triacetate, and can be employed with low catalyst concentrations. A more unusual process is one using liquid sulfur dioxide as the esterification solvent.<sup>16</sup>

<sup>10</sup> J. B. Conant and N. F. Hall, *J. Am. Chem. Soc.*, **49**, 3047 (1927).

<sup>11</sup> I. G. Farbenindustrie Akt.-Ges., Brit. Pat. 299,326 (March 24, 1930).

<sup>12</sup> C. Dreyfus and H. Martin, U. S. Pat. 2,071,333 (Feb. 23, 1937).

<sup>13</sup> Wolff and Co., German Pat. 440,844 (Feb. 12, 1927); 511,020 (July 10, 1930).

<sup>14</sup> R. Hofmann, U. S. Pat. 2,126,190 (Aug. 9, 1938).

<sup>15</sup> H. LeB. Gray, U. S. Pat. 1,823,359 (Sept. 15, 1931).

<sup>15a</sup> L. E. Clement, U. S. Pat. 2,104,023 (Jan. 4, 1938).

<sup>16</sup> L. M. Burghart, U. S. Pat. 1,822,563 (Sept. 8, 1931); 1,816,564 (July 28, 1931).

If the added solvent does not produce a mixture which will dissolve the triacetate, the esterified product retains its natural fibrous condition. Carbon tetrachloride was one of the first solvents used to produce such a reaction. Various other solvents were later suggested,<sup>17,18</sup> including other halogenated solvents, hydrocarbons, ethers, and mixtures of these materials. The vital factor in such a process is to provide the most efficient diffusion of reagents into the cellulose fiber without permitting the product to dissolve. Advantages are therefore often gained by the use of properly balanced mixtures instead of a single material. A thorough study of esterification without loss of fiber structure has been made during the past years, but such processes have not reached popular commercial use. A serious limitation of this type of esterification is that only fully esterified products can be so produced, since no method of uniform hydrolysis in suspension has yet proved itself satisfactory.

### 3. *Partial Esterification*

All esterification processes with acetic anhydride yield the fully esterified ester as the first soluble product. If the reaction medium is a solvent for the triester a solution is obtained, and if a reaction which retains the fiber structure is employed, samples taken at intervals are all insoluble in solvents until complete esterification is attained. The process in this way differs from nitration, in which soluble, partially esterified products are obtained by adjustment of the concentration of the nitration acids. In the etherification of cellulose, the ethers (*e.g.*, methylated cellulose) prepared by partial substitution are also soluble products, exhibiting continuous, gradual changes in solubility characteristics with increasing substitution.

Nitration is an equilibrium reaction, the nitrogen content of the product being determined by the acid concentration at the end of the reaction. If this concentration is then changed, the nitrogen content of the cellulose ester adjusts itself accordingly. It may be assumed that a uniform distribution of substituted groups, made possible by the reversible esterification reaction, is responsible for solubility in this case, although direct measurement of the distribution has not been reported. This explanation cannot be applied to etherification reactions. Soluble, partially esterified, higher esters, such as cellulose crotonate, benzoate, stearate, and others, may also be prepared by reactions which are not reversible.

Explanations of the mechanisms of substitution reactions and their relation to solubility must involve consideration of two factors: (1) the

<sup>17</sup> O. Sindl and G. Frank, U. S. Pat. 2,143,332 (Jan. 10, 1939).

<sup>18</sup> R. Muller, M. Schenk and W. Wirbatz, U. S. Pat. 2,045,161 (June 23, 1936).

distribution of substituted groups among different glucose units in the cellulose molecule; and (2) the distribution between the primary and two secondary hydroxyl groups in the 2, 3 and 6 positions of the glucose units.

Degradation of cellulose ethers to glucose units and the determination of the relative ratios of mono, di, tri, and unsubstituted glucose residues, have given results which are in agreement with random reaction and the equal availability of all three hydroxyl groups.<sup>19</sup> Distribution of methyl and ethyl groups between primary and secondary positions at low degrees of substitution has been shown to depend upon the degree of homogeneity of the etherification reaction.<sup>20</sup> This work affords an interesting comparison between water-soluble cellulose ethers and cellulose acetate of low acetyl content. Hydrolysis of cellulose acetate in acid solution, continued beyond the acetone-soluble range, may be carried to water-soluble products of 14% to 18% acetyl content. Partial acetylation of cellulose, on the other hand, either by restricted amounts of acetic anhydride or by heating regenerated cellulose with acetic acid, yields acetyl values within the same range, but no water-soluble products. Measurements of the relative distribution of the acetyl groups in these materials would be of interest.

Free hydroxyl groups in acetone-soluble cellulose acetate were found by Cramer and Purves<sup>21</sup> to be in a ratio of about one primary to two secondary groups. This confirms earlier measurements made by Sakurada and Kitabatake.<sup>22</sup> Oxidation by lead tetraacetate indicates that very few glucose units have free hydroxyl groups in both the 2 and 3 positions.<sup>23</sup> These results disagree with the calculated distribution based on random reaction, and may indicate that a substituted group in one secondary hydroxyl influences the reactivity of the adjacent hydroxyl group. A similar distribution of substituted groups was observed in cellulose ethers.<sup>24</sup>

#### 4. Viscosity

Of primary importance in the commercial use of cellulose derivatives are strength and toughness of the products. It was early recognized that these qualities were directly related to viscosity, and many com-

<sup>19</sup> H. M. Spurlin, *J. Am. Chem. Soc.*, **61**, 2222 (1939).

<sup>20</sup> J. F. Mahoney and C. B. Purves, *J. Am. Chem. Soc.*, **64**, 15 (1942).

<sup>21</sup> F. B. Cramer and C. B. Purves, *J. Am. Chem. Soc.*, **61**, 3458 (1939).

<sup>22</sup> I. Sakurada and T. Kitabatake, *J. Soc. Chem. Ind., Japan*, **37**, supp. binding, 604 (1934).

<sup>23</sup> F. B. Cramer, R. C. Hockett and C. B. Purves, *J. Am. Chem. Soc.*, **61**, 3463 (1939).

<sup>24</sup> J. F. Mahoney and C. B. Purves, *J. Am. Chem. Soc.*, **64**, 9 (1942).



mercial developments have been directed toward esterification processes capable of giving increased viscosity.

A very early step in this direction was the use of native cellulose as the starting material, replacing regenerated celluloses or those which had been treated with strong acids. Also, acetylation processes at an early date were modified to maintain as high a viscosity as was possible during the esterification reaction. Processes described in 1915–1918<sup>25</sup> emphasized that the use of mild acetylation temperatures give cellulose triacetates insoluble in chloroform but soluble in mixtures of chloroform and alcohol. These products were referred to as "higher in viscosity than any previously prepared," and therefore more suited for film formation and plastic compositions. Since that time still further progress in increased viscosity has been realized, such as by acetylation under mild reaction conditions using large amounts of solvent.<sup>26</sup> In all of these developments, conditions avoiding degradation or depolymerization of the cellulose are emphasized.

The establishment of the modern concept of cellulose as a long chain molecule made up of anhydroglucose units has done much to clarify the relation of viscosity to strength. Extensive theoretical investigations over the past fifteen years on the molecular size of natural and synthetic polymers have made it possible to speak in terms of molecular weights and degrees of polymerization (DP) in addition to the more empirical property of viscosity. High molecular materials acquire properties of strength as films or filaments by virtue of forces of attraction between long chain molecules. Thus, a certain minimum chain length is necessary to permit these forces of attraction to be effective.<sup>27</sup> Cellulose acetates must have an average DP of at least 50 to form films and filaments. Above that figure products increase in strength proportional to their chain lengths up to a DP of about 200. With still further increase in chain length, the increase in strength is very slight.

All celluloses and derivatives made from them are mixtures of cellulose molecules of varying chain lengths. Many fractionation studies of cellulose acetate have been directed toward separating the material into its lower and higher chain length components and determining the degree to which the different fractions contribute to the strength of the prod-

<sup>25</sup> H. Dreyfus, U. S. Pat. 1,181,857 (May 2, 1916); 1,217,722 (Feb. 27, 1917); 1,278,885 (Sept. 17, 1918).

<sup>26</sup> H. Dreyfus, U. S. Pat. 1,829,822 (Nov. 3, 1931).

<sup>27</sup> H. Mark, in "Cellulose and Cellulose Derivatives," E. Ott, Editor, p. 1007. Interscience Publishers, Inc., New York (1943).

uct.<sup>28,29,30,31</sup> Earlier work indicated that an improvement of physical properties could be obtained by properly mixing low and high viscosity fractions. A great many measurements, however, point toward the fact that the resultant properties depend mainly upon the average chain length of the mixture with little or no advantage in the choice of components.

### 5. Salt Effect

An abnormal viscosity increase is observed for cellulose esters in the presence of certain inorganic salts. The viscosity of cellulose nitrate solutions may be greatly increased by the addition of calcium salts.<sup>32</sup> A similar behavior results from washing the product in hard water. The degree of viscosity increase diminishes with dilution of the solution. The same type of behavior takes place with cellulose acetates, especially in anhydrous acetone solution. Lohmann<sup>33</sup> has found that cellulose acetate of DP 180, when washed with water containing calcium salts, exhibits acetone viscosities in concentrated solution similar to those of an acetate of DP 250 washed in distilled water. When measured in very dilute solutions, the salt effect was absent. Calcium was found to give the greatest effect, strontium slight, and magnesium, aluminum, and alkali salts practically none. Measurements of filament strengths showed the values to be proportional to their true chain lengths, rather than to the abnormal viscosities.

The abnormal viscosities appear to be caused by combination of the metal ions with acid groups. These may be sulfate groups from the catalyst employed in esterification, or carboxyl groups present in the cellulose or introduced during purification.

## III. MIXED ESTERS

The mixed organic esters of cellulose most prominent commercially are the acetate propionate and acetate butyrate. The cellulose in these products is esterified partly by acetyl and partly by propionyl or butyryl groups. The products are uniform compounds, giving clear, homogeneous solutions and plastic compositions.

<sup>28</sup> H. J. Rocha, *Kolloid-Beihfte*, **30**, 230 (1930).

<sup>29</sup> F. Ohl, *Kunstseide*, **12**, 468 (1930).

<sup>30</sup> H. M. Spurlin, *Ind. Eng. Chem.*, **30**, 538 (1938).

<sup>31</sup> A. M. Sookne and M. Harris, Research Paper RP 1513, *J. Research Natl. Bur. Standards*, **30**, 1 (1943).

<sup>32</sup> S. A. Glickman, S. S. Mindlin, V. I. Guseva and P. I. Zeldovich, *Plasticheskie Massy*, 1933, No. 4, 11; *C.A.*, **28**, 5978.

<sup>33</sup> H. Lohmann, *J. prakt. Chem.*, **155**, 299 (1940).

Manufacture of these mixed esters is best carried out by simultaneous esterification with a reaction bath containing both acyl groups.<sup>34</sup> This may be by direct use of both anhydrides or by a mixture of the acid of one and the anhydride of the other; the proportion in which an acyl group is introduced in the product is controlled by its concentration in the reaction bath.

The solubility restrictions that apply to the manufacture of the mixed esters are the same as those for the cellulose acetate, in that no soluble products are obtained by partial esterification. Hydrolysis of the esters in acid solution, however, yields uniform products showing gradually changing physical properties with increasing free hydroxyl content. The exact ratio of hydrolysis of acetyl to hydrolysis of propionyl or butyryl groups depends upon the composition of the hydrolysis solution. Thus, a cellulose acetate propionate hydrolyzed in acetic acid solution will retain a higher proportion of acetyl groups than would the same cellulose ester hydrolyzed in propionic acid.

Physical properties of the cellulose mixed esters differ from those of cellulose acetate.<sup>35</sup> Cellulose acetate propionates and acetate butyrates both exhibit wider solubilities in organic solvents than cellulose acetate, the range of solubility being greater the higher the propionyl or butyryl content. Halogenated solvents most readily dissolve fully esterified or slightly hydrolyzed cellulose esters, while ketones or mixtures of benzene or toluene with alcohol exhibit maximum solubility behavior toward moderately hydrolyzed products. Sorption of moisture increases in proportion to the degree of hydrolysis, and fully esterified products of high propionyl or butyryl content show very low moisture sorption values. Melting points of the mixed esters are irregular, but in general are lower, the greater the content of higher acyl groups.

#### IV. OTHER ORGANIC ESTERS

##### 1. *Esterification Methods*

A great variety of cellulose organic esters other than those of present commercial importance have been prepared for laboratory study. Methods of preparation different from those in commercial use must be employed since anhydrides of acids above butyric do not readily esterify cellulose. The reaction of acid chlorides in the presence of pyridine has been widely used, and is usually considered to be a reliable preparative method. In most cases elevated temperatures are required, however, and the danger of side reactions which result in combined nitrogen and

<sup>34</sup> H. T. Clarke and C. J. Malm, U. S. Pat. 2,048,685 (July 28, 1936).

<sup>35</sup> C. J. Malm, C. R. Fordyce and H. A. Tanner, *Ind. Eng. Chem.*, **34**, 430 (1942).

chlorine in the cellulose ester is not generally appreciated. Another useful esterification process is the reaction of cellulose with a slight excess of the acid to be employed in the presence of chloroacetic anhydride and a mild acid catalyst.<sup>36,37</sup> The chloroacetic anhydride does not itself esterify cellulose under these conditions, but acts as an impelling agent to bring about the esterification of other acids in the reaction mixture.

### 2. Esters of Higher Aliphatic Acids

Very little recent work has been published concerning the higher aliphatic cellulose esters. Earlier investigations<sup>38,39</sup> have shown that the physical properties of such esters depart rapidly from the strength and toughness of cellulose acetate, esters above the butyrate exhibiting extreme softness, low melting points, and low tensile strengths. They have, on the other hand, high resistance to moisture, a wide range of solubilities in organic solvents, and increased compatibilities with oils, waxes, and resins. Mixed cellulose esters containing appreciable quantities of acetyl with the remaining hydroxyl groups esterified with the higher acid groups, exhibit film-forming properties and unique qualities of compatibility which make them desirable for special uses.

### 3. Esters of Unsaturated Acids

Esters of unsaturated acids are of experimental interest because of their ability to be converted into insoluble products. Cellulose crotonate, upon heating in the presence of air, or upon exposure to ultraviolet light, becomes completely insoluble.<sup>40</sup> This action may be accelerated by the addition of small quantities of benzoyl peroxide. Esters of more active unsaturated acids, such as cellulose acetate linoleate, become insoluble upon exposure to air at ordinary temperatures.<sup>41</sup>

### 4. Esters of Substituted Aliphatic Acids

Cellulose esters of halogenated acids are exceptionally difficult to prepare. This is particularly true if the halogen is in the alpha position to the carboxyl group. Chloroacetic anhydride in the presence of acid catalysts esterifies cellulose only after severe degradation. The use of pyridine is prohibited because of side reactions with the reagent. Mixed

<sup>36</sup> H. T. Clarke and C. J. Malm, U. S. Pat. 1,880,808 (Oct. 4, 1932); Brit. Pat. 313,408 (Aug. 27, 1929).

<sup>37</sup> I. G. Farbenindustrie Akt.-Ges., German Pat. 516,250 (Jan. 20, 1931).

<sup>38</sup> M. Hagedorn and P. Moller, *Cellulosechem.*, 12, 29 (1931).

<sup>39</sup> S. E. Sheppard and P. T. Newsome, *J. Phys. Chem.*, 39, 143 (1935).

<sup>40</sup> C. J. Malm and C. R. Fordyce, U. S. Pat. 1,973,493 (Sept. 11, 1934).

<sup>41</sup> C. R. Fordyce and G. D. Hiatt, U. S. Pat. 2,170,016 (Aug. 22, 1939).

esters containing moderate amounts of chloroacetyl groups may be made by heating cellulose acetate with chloroacetic anhydride in the presence of a neutral solvent. Esters of halogenated higher fatty acids have been prepared by the addition of chlorine or bromine to the unsaturated groups of cellulose crotonate and cellulose oleate.<sup>42</sup>

Alkoxy fatty acid anhydrides show a behavior similar to that of the halogenated anhydrides and do not esterify cellulose in the presence of acid catalysts. In the presence of pyridine, however, methoxyacetic and ethoxyacetic anhydrides or their acid chlorides give soluble cellulose derivatives.<sup>43</sup>

### 5. Esters of Aromatic Acids

Investigations of the cellulose esters of benzoic acid have so far not led to products of commercial interest. Benzoyl chloride reacts in the presence of pyridine at elevated temperatures, most suitably by the use of a higher boiling neutral solvent as diluent.<sup>44</sup> Benzoyl derivatives have also been prepared by the reaction of the acid chloride on alkali cellulose. A combination of pyridine and alkali has been reported to be advantageous.<sup>45</sup>

### 6. Esters of Dibasic Acids

Reaction of cellulose with acid chlorides of dibasic acids in the presence of pyridine yields insoluble products, probably due to cross-linking of the ester groups. Mixed esters of dibasic acids in which the second carboxyl group is esterified with a monohydric alcohol may be prepared by the reaction with cellulose of the acid chloride of the half ester in the presence of pyridine<sup>46</sup> or by use of the half ester with chloroacetic anhydride as an impelling agent. Soluble products are obtained which have comparatively low melting points.<sup>47</sup> Half esters of phthalic and succinic acids in which the second carboxyl group remains a free acid may be prepared by reaction of the anhydride in the presence of pyridine.<sup>48</sup> Cellulose acid succinate and acid phthalate are insoluble in most organic solvents, but their pyridine or alkali metal salts are soluble in water.

More interesting derivatives are the mixed esters in which the free hydroxyl groups of cellulose acetate are esterified with the dibasic acid

<sup>42</sup> H. T. Clarke and C. J. Malm, U. S. Pat. 1,687,060 (Oct. 9, 1928).

<sup>43</sup> C. J. Malm and J. D. Coleman, U. S. Pat. 2,028,792 (Jan. 28, 1936).

<sup>44</sup> A. Wohl, *Z. angew. Chem.*, **25**, 285 (1903).

<sup>45</sup> H. Ost and F. Klein, *Z. angew. Chem.*, **26**, 437 (1913).

<sup>46</sup> G. V. Frank and W. Caro, *Ber.*, **63 B**, 1532 (1930).

<sup>47</sup> C. J. Malm and C. R. Fordyce, *Ind. Eng. Chem.*, **32**, 405 (1940).

<sup>48</sup> F. Schulze, U. S. Pat. 2,069,974 (Feb. 9, 1937); C. J. Malm and C. E. Waring, U. S. Pat. 2,093,462 (Sept. 21, 1937); 2,093,464 (Sept. 21, 1937).

anhydride, giving acid esters which are soluble in organic solvents and which may be converted into water-soluble salts. Cellulose acetate acid phthalates showing these characteristics may be prepared by reacting a cellulose acetate having less than 35% acetyl content with phthalic anhydride in the presence of pyridine at 100° C. The products, isolated as the acid esters by precipitation in dilute aqueous acid and by washing with distilled water to prevent contamination from salts, are soluble in organic solvents and are insoluble in water, but are readily dissolved by dilute alkali.

### 7. Esters of Sulfonic Acids

Partial esterification of cellulose with *p*-toluenesulfonyl chloride may be accomplished in the presence of pyridine, or by reaction with alkali cellulose.<sup>49</sup> The tosyl (*p*-toluenesulfonyl) group has been shown to react quite readily with the primary hydroxyl group of cellulose but much more slowly with the secondary groups.<sup>21</sup> The reaction in the presence of pyridine must be carried out at low temperatures to prevent the introduction of nitrogen and halogen from side reactions.<sup>50</sup>

Use of the tosyl derivative of cellulose for theoretical study is important. Cramer and Purves<sup>21</sup> have prepared tosyl derivatives of acetone-soluble cellulose acetate. By treatment with sodium iodide, which replaces tosyl groups in the primary position by iodine, they have been able to measure the proportions of primary and secondary hydroxyl groups present in the original product.

By treatment with aliphatic primary or secondary amines, tosyl groups on cellulose (a low-substituted cellulose, such as methylcellulose, was employed) may be replaced by substituted amino groups.<sup>51</sup> The products obtained are insoluble in water but dissolve readily in dilute acid.

### 8. Carbamates

Organic isocyanates react with cellulose in the presence of dry pyridine to produce the corresponding N-substituted carbamates.<sup>52</sup> Aliphatic isocyanates bring about only partial esterification, while aromatic reagents under proper conditions react readily and completely. Cellulose N-phenylcarbamate is soluble in several organic solvents and is extremely stable toward either acid or alkaline decomposition. Incomplete esteri-

<sup>49</sup> I. Sakurada and T. Nakashima, *Sci. Papers Inst. Phys. Chem. Research (Tokyo)*, **6**, 214 (1927).

<sup>50</sup> K. Hess and N. Ljubitsch, *Ann.*, **507**, 62 (1933).

<sup>51</sup> J. F. Haskins, U. S. Pat. 2,136,299 (Nov. 8, 1938).

<sup>52</sup> W. M. Hearon, G. D. Hiatt and C. R. Fordyce, *J. Am. Chem. Soc.*, **65**, 829 and 833 (1943).

fication of cellulose with phenyl isocyanate does not give soluble products, although soluble cellulose carbamates containing free hydroxyl groups may be prepared by the esterification of cellulose acetate of low acetyl content with phenyl isocyanate and subsequent removal of the acetyl groups.

### C. Industrial Applications

#### I. PRODUCTION TRENDS

The recent rapid expansion in the production of cellulose acetate is evidence of its broadening use. Large scale manufacture in the United States for rayon use began in 1926 with an annual production of slightly over two and one-half million pounds. In 1931 increased quantities began to be used for films and sheets. By 1938, cellulose acetate and cellulose acetate butyrate molding compositions had become prominent products. Total production of cellulose organic esters in 1943 is estimated at approximately two hundred and forty million pounds, of which one hundred and ninety-five million pounds was cellulose acetate used for rayon. Of the remaining forty-five million pounds used for other purposes, more than half was cellulose mixed esters.

This production expansion was made possible in no small degree by a sharp reduction in the cost of manufacture. From an original market price of \$1.45 a pound in 1926, cellulose acetate dropped steadily to \$.50 a pound in 1936, and further to \$.30 in 1940. In addition to a lower cost as a result of the increasing quantity of production, these reductions in price were aided greatly by reductions in the cost of raw materials. Acetic acid became much cheaper during this period, and the cost of conversion of the acid to its anhydride was aided by improved process development. Recovery of acetic acid from aqueous solution also became cheaper with the adoption of extraction and azeotropic distillation processes, replacing the original recovery by evaporation of neutralized solutions. In addition, technical developments in the acetylation process increased the economy of plant unit operations.

Practically all cellulose acetate manufactured at the present time is the acetone-soluble product, ranging from 37% to 41% acetyl content. Cellulose mixed esters now produced in quantity include cellulose acetate propionate of 33% propionyl content, cellulose acetate butyrate of 16% butyryl content, both of which are used largely for protective coatings and films, and cellulose acetate butyrate of 36% butyryl content used for plastics.

#### II. TEXTILES

Textile filaments of cellulose acetate are classified as rayon, that term having been adopted for all manufactured textile fiber or yarn produced

chemically from cellulose or with cellulose as a base. In the United States, cellulose acetate rayon now constitutes approximately 30% of the total rayon production. Cellulose acetate of about 39% acetyl content is most widely used for rayon, and is spun by the dry spinning process, which involves extrusion of a heavy acetone solution of the acetate through a spinneret into an air section where the solvent is evaporated. For lustrous finishes, clear solutions are used, while dull finishes are produced by the incorporation of a pigment. Careful production control is maintained over factors which affect the size and nature of the filament and its tensile strength and stretch characteristics.

A product of growing importance in all rayons is staple fiber, for which filaments are cut into short lengths to make them suitable for spinning, alone or with cotton, wool, or other fibers on standard textiling equipment. Cellulose acetate staple fiber is widely used in dress goods, shirtings and mens' fabrics, and its property of good resilience has made the material of interest for such applications as rugs and blankets.

Plastic properties of cellulose acetate make it possible to bring about high degrees of orientation of filaments by stretching under suitable conditions, resulting in increased tensile strength. Taking advantage of these possibilities, a new variety of cellulosic rayon has been developed which has a high tensile strength. During the manufacture of this product, acetyl groups are removed, resulting in a regenerated cellulose.

### III. PROTECTIVE COATINGS

Interest in cellulose esters of organic acids for protective coatings has been largely with the hope of finding a material which would offer the same advantages of solubility and compatibility as cellulose nitrate and in addition overcome some of the difficulties encountered with that material. Lacquer coatings containing cellulose nitrate discolor upon long exposure to light, and exhibit "chalking" in the presence of some pigments. Coated fabrics for aircraft purposes are highly flammable. Artificial leather compositions are susceptible to brittleness at low temperatures.

Cellulose acetate has offered little in fulfilling the requirements of a protective coating material. Although stable to light, it is restricted in use by its limited solubility in solvents, and its poor compatibility with resins. It has been used only for special purposes as a lacquer material, and to a limited extent for surface coatings on paper and cloth. Cellulose mixed esters appear more promising for these uses.<sup>53, 54</sup> Cellulose acetate

<sup>53</sup> C. R. Fordyce, M. Salo and G. R. Clarke, *Ind. Eng. Chem.*, **28**, 1310 (1936).

<sup>54</sup> W. E. Gloor, *Ind. Eng. Chem.*, **29**, 690 (1937).



propionates and acetate butyrates with moderate or large amounts of the higher acyl group are soluble in the ester, alcohol, and hydrocarbon solvent mixtures used with cellulose nitrate, and cellulose acetate butyrates of high butyryl content are compatible with large proportions of many resins.

Dipping lacquers suitable for applying heavy surface coatings without wrinkling or running may be made using certain cellulose esters.<sup>54a</sup> Cellulose acetate butyrates of high butyryl content are useful, with solvent mixtures composed of toluene or xylene and minor amounts of isopropyl alcohol. These lacquers owe their unique properties to the fact that, while they are clear, mobile solutions at elevated temperatures, they set to firm gels upon cooling to room temperature. Heavy coating applications "set" as dipped articles are withdrawn from warm lacquer solutions, and immediately become non-tacky. Successive coatings may be applied at ten or fifteen minute intervals. Pigmented and colored compositions may be used, resulting in finished products of appearance comparable to molded articles.

Cellulose acetate butyrates have proved useful for aircraft fabric coatings. The most important factors here are durability and moisture resistance, making possible surface coatings of good wearing quality which are not susceptible to excessive shrinkage with changing humidity. The development of aircraft fabrics has extended over a period of twenty-five years. Cellulose acetate was used during the first World War but was later replaced by cellulose nitrate. The nitrate, in spite of its high flammability, was preferred because it showed less tendency to become slack in damp weather and excessively tight when warm and dry. A recent thorough investigation of materials for this use has shown that advantages can be realized through the use of cellulose esters which are nearly fully esterified.<sup>55</sup> Cellulose acetate butyrates appeared to be exceptionally useful. Substantially fully esterified products were soluble in practical solvent mixtures, and coatings were sufficiently moisture-resistant to maintain desirable tautness through a wide range of humidity. With selected solvent combinations, cellulose esters of about 0.2 free hydroxyl groups for each glucose unit were found to be most desirable.

Artificial leather coatings may be made from cellulose acetate butyrate compositions of high butyryl content. Large amounts of plasticizers of low volatility are employed. These coatings offer improved flexibility at low temperatures over those made from cellulose nitrate compositions.

<sup>54a</sup> C. R. Fordyce and G. J. Clarke, U. S. Pat. 2,350,742 (June 6, 1944); 2,350,743 (June 6, 1944).

<sup>55</sup> F. Reinhart and G. Kline, *Ind. Eng. Chem.*, **32**, 185 (1940).

Coatings using high viscosity cellulose acetate butyrate may be made from solvent solutions in the same manner in which nitrate coatings are applied. Low viscosity acetate butyrate compositions may be applied by melt coating applications, in which no solvent is employed. In addition to plasticizers, the coatings may carry pigments and coloring materials and may be readily embossed by processes commonly employed for artificial leather manufacture.

#### IV. FILMS

Cellulose esters are widely employed in the manufacture of films and sheets, ranging in thickness from foils of less than one-thousandth of an inch to sheets as thick as one-fourth inch. The greatest use of thin foils is for packaging purposes, for which they are used directly or by lamination to paper or metal foil. Intermediate thicknesses of five to nine-thousandths of an inch are extensively used for photographic films. Deep drawing processes for shaping films by heat, use thicknesses as high as ten to twenty-thousandths of an inch. Heavier sheets are necessary for rigid articles such as windows for airplane cockpits. In addition to clear transparent sheeting, colored and pigmented sheets of light and intermediate thickness are employed to a considerable extent for miscellaneous uses such as lamp shades and packaging containers.

Thin foils are manufactured by casting films from solutions in volatile solvents. Cellulose acetate containing a moderate amount of plasticizer is widely used. It gives a product of good aging characteristics with respect to exposure to light or weather, but it is comparatively low in toughness. Films of considerably increased toughness may be made from cellulose acetate butyrate, and are finding continuously wider application.

Transparent film base for photographic use is required for camera roll films, for X-ray and portrait films, and for eight, sixteen and thirty-five millimeter wide Cine Films. In the past, cellulose nitrate has been used for these products, except for the eight and sixteen millimeter films, and was found highly satisfactory except for its inflammability. This inflammability has made it necessary to turn to the use of the cellulose esters of organic acids for film products exposed to exceptional hazards during use or storage. The burning qualities of the latter type of films, called Safety Films, are usually further retarded by the incorporation of phosphate plasticizers.

Films for X-ray and portrait purposes require good rigidity for handling and high resistance to moisture in order to prevent unevenness at varying humidities. Cellulose acetate with comparatively large amounts of plasticizer has been widely used for this purpose. Cellulose

mixed esters offer advantages of greater moisture resistance and have replaced the acetate to a large degree. In addition to their more desirable inherent qualities, the physical properties of films of cellulose mixed esters may be improved by variation of the mechanical conditions employed in the casting operation. Cellulose mixed esters which, coated from acetone, yield very brittle films, give flexible products from chlorinated solvents.<sup>56</sup>

Cine Films must withstand severe mechanical wear and must be of good dimensional stability for projection. Cellulose nitrate has qualities which are very desirable for this purpose, and remains the standard product for the professional moving picture industry. Amateur and educational Cine Films must be made of less inflammable material. Cellulose acetate has been used for this purpose but is limited in its moisture resistance, its strength and its tendency toward brittleness at low humidities. Improvements have been obtained by the employment of cellulose mixed esters possessing a moderate higher acyl content. Such products are widely used for narrow width Cine Films.

Films of greater thickness than those used for photographic purposes may be manufactured by coating from solution in volatile solvents, by extrusion with plasticizer with little or no solvent, or by blocking and skiving. Rigid sheets must be coated from solvents and heavy thicknesses attained by lamination. Skiving operations are limited in sizes which can be made in a single sheet. Extrusion at elevated temperatures offers an economical method for the manufacture of well plasticized films, although it is difficult to attain the optical quality possible by the solvent coating process. Cellulose acetate butyrates of high butyryl content offer attractive possibilities of extrusion and require only comparatively small amounts of plasticizer.

## V. MOLDING COMPOSITIONS

Molding compositions of cellulose derivatives belong to the thermoplastic group of plastics as contrasted with the thermosetting group which undergo chemical change to insoluble products during the molding operation. Cellulose nitrate plasticized with camphor (celluloid) has long been established as a thermoplastic molding composition. Cellulose acetate and cellulose acetate butyrate molding compositions are now available in addition to the nitrate. As a group, the cellulosic plastic materials are outstanding for their toughness.

Cellulose acetate became of interest as a molding material because of its lower flammability as compared with celluloid. For the past ten

<sup>56</sup> C. J. Malm, U. S. Pat. 1,960,185 (May 22, 1934).

years its popularity has steadily increased with the use of injection molding, which rapidly replaced the slower compression molding process for most purposes. Materials of hard or soft flows are obtained by a variation of the type and quantity of plasticizer used. In addition to plasticizers, pigments and coloring materials may be added to the molding composition, making possible all color variations for decorative effects. These compositions are prepared commercially by homogenizing the mixtures with application of heat, or by using volatile solvents to give pastes which, after thorough mixing, are pressed into heavy sheets, cured to remove solvent, and then cut into granules.

Cellulose acetate butyrate molding compositions have been available since 1938. A cellulose ester of high butyryl content is used and offers several advantages over cellulose acetate. It is high in moisture resistance, and is compatible with highly moisture resistant plasticizers.<sup>57</sup> In addition, this cellulose ester is inherently more plastic than cellulose acetate, requiring considerably less plasticizer to produce the necessary flow characteristics. These factors combine to yield a product of good weathering characteristics which is resistant to warping or buckling.

Physical properties of greatest importance in molding compositions are tensile, impact and flexural strengths, hardness, dimensional stability, and low moisture sorption and resistance under conditions of water immersion. Testing methods up to the present time have not been sufficiently dependable to allow the behavior of a plastic for a specific use to be predicted, and actual use tests have been employed for practical evaluation. This is partly due to a lack of knowledge as to the tests which are important for various wearing qualities, and partly to a lack of standardization of tests. Impact tests are known to vary as a result of slight differences in the preparation of samples or in test procedure. Water immersion tests often result in a loss of the plasticizer from the test sample; hence, inaccurate measurements of water absorption are given. Several physical properties also depend upon the use of suitable molding conditions which must be maintained in the preparation of samples.

<sup>57</sup> C. R. Fordyce and L. W. Meyer, *Ind. Eng. Chem.*, **32**, 1053 (1940).

This Page Intentionally Left Blank

# A DISCUSSION OF METHODS OF VALUE IN RESEARCH ON PLANT POLYURONIDES

BY ERNEST ANDERSON AND LILA SANDS

*Department of Chemistry, the University of Arizona, Tucson*

## CONTENTS

I. Introduction . . . . .	329
II. Methods Used in Studying the Composition of Polyuronides . . . . .	331
1. Testing for Polyuronides . . . . .	331
2. Isolation of Polyuronides . . . . .	331
3. Purification of Polyuronides . . . . .	333
4. Analysis of Polyuronides . . . . .	334
5. Hydrolysis of Polyuronides . . . . .	335
6. Separating the Products of Hydrolysis . . . . .	337
III. Identifying the Units in the Polyuronide . . . . .	337
1. Methoxyl . . . . .	337
2. The Sugars . . . . .	338
3. The Uronic Acids . . . . .	338
IV. Methods for Determining the Structure of Polyuronide Molecules . . . . .	340
V. Some Results of Structural Investigation of the Polyuronides . . . . .	341

## I. INTRODUCTION

Polyuronides may be defined as polysaccharides that contain one or more uronic acid units in their molecular structures. They have a frequent and wide occurrence in nature. Much of the carbohydrate material in plants belongs to the group. It includes all pectic materials and plant gums and many plant mucilages, hemicelluloses and gel-forming substances and some microbial polysaccharides. These substances are to be looked for in water-soluble plant exudates and mucilages, as well as in water and alkaline extracts of most plant materials. This review will be limited to the polyuronides occurring in plants.

Previous to the last decade most of the research on the group dealt with the composition of the substances. There still remains an enormous amount of this work to be done. Now, however, emphasis is shifting to a study of the structure and molecular size of these bodies. The methods that were developed in the study of the simple sugars, the glycosides, starch and cellulose are being applied in the study of the polyuronides.

The polyuronides are a heterogeneous group of compounds whose physical properties and chemical composition are not well defined. They are all non-crystalline and insoluble in strong alcohol. Many are soluble in water and those that are insoluble in this solvent are often soluble in solutions of sodium, potassium or ammonium hydroxides or carbonates. Many of them become sticky, slimy or gelatinous when moistened with water. They are all stained by ruthenium red and all give the naphthoresorcinol test for a uronic acid. In their natural condition they do not reduce Fehling's solution. They are all hydrolyzed by hot dilute solutions of strong acids to reducing sugars and aldobionic or free uronic acids. In the polyuronide molecule the sugar and uronic acid units are joined by glycosidic linkages to form complex acids. Plant gums, many plant mucilages and some of the gel-forming substances of marine algae are present as salts. All pectic materials contain polygalacturonic acids, partly as salts but for the most part as methyl esters of these acids. Many polyuronides contain an ether-linked methyl group that is attached to the uronic acid. Early publications on the group are summarized in a number of reference works.<sup>1-8</sup> Later publications are given in the monograph by Norman<sup>9</sup> and in various reviews.<sup>10-12</sup>

In order to determine the structure, the polyuronide must be isolated, purified and tested to see that it belongs to the group. It must be hydrolyzed; the sugars, uronic acid and other groups present must be identified, and their relative positions in the molecule established. The positions and types of the glycosidic linkages as well as the types of lactol rings must be determined. The length of the glycosidic chain, or of the branches, and the approximate size of the molecule must be estab-

<sup>1</sup> J. von Wiesner, "Die Rohstoffe des Pflanzenreiches," W. Engelmann, Leipzig, 4th ed., 1928.

<sup>2</sup> E. Abderhalden, "Biochemisches Handlexikon," J. Springer, Berlin, 1931.

<sup>3</sup> G. Klein, "Handbuch der Pflanzenanalyse," J. Springer, Vienna, 1932.

<sup>4</sup> B. Tollens (revised by H. Elsner), "Kurzes Handbuch der Kohlenhydrate," J. A. Barth, Leipzig, 4th ed., 1935.

<sup>5</sup> O. Tunmann and L. Rosenthaler, "Pflanzenmicrochemie," Gebrüder Borntraeger, Berlin, 1931.

<sup>6</sup> M. W. Onslow, "The Principles of Plant Biochemistry," The University Press, Cambridge, 1931.

<sup>7</sup> M. H. Branfoot, "The Pectic Substances of Plants," His Majesty's Stationery Office, London, 1929.

<sup>8</sup> A. W. Schorger, "The Chemistry of Cellulose and Wood," McGraw-Hill, New York, 1926.

<sup>9</sup> A. G. Norman, "The Biochemistry of Cellulose, the Polyuronides, Lignin, etc.," The Clarendon Press, Oxford, 1937.

<sup>10</sup> S. Peat, *Ann. Repts. Progress Chem. (Chem. Soc. London)*, **38**, 150 (1941).

<sup>11</sup> J. Bonner, *Botan. Rev.*, **2**, 475 (1936).

<sup>12</sup> E. L. Hirst, *J. Chem. Soc.*, 70 (1942).

lished. When possible, x-ray pictures of the material are made. In addition there are questions as to the origin and use of these materials in the plant.

## II. METHODS USED IN STUDYING THE COMPOSITION OF POLYURONIDES

### 1. Testing for Polyuronides

If the plant compound gives the naphthoresorcinol test for a uronic acid and on hydrolysis with a hot dilute solution of a strong acid gives simple sugars and aldobionic or free uronic acids, it is a polyuronide.<sup>13-16</sup>

### 2. Isolation of Polyuronides

Plant gums are isolated by hand picking. In isolating other polyuronides, the powdered plant material is usually first extracted with hot benzene and alcohol or a mixture of these solvents. Mucilages,<sup>17-25</sup> water-soluble pectic materials,<sup>26</sup> and some gel-forming substances from marine algae<sup>27,28</sup> are dissolved in water. In some cases marine algae are extracted with a dilute solution of sodium carbonate.<sup>29,30</sup> In industrial practice, some plant mucilages are isolated in the dry condition from seeds by milling processes.

After removal of the water-soluble material, water-insoluble pectic substances are frequently extracted by a hot 0.5% solution of ammonium oxalate.<sup>31,32</sup> While this solution will dissolve pectic materials that are not protected by lignin, the ammonium oxalate may contaminate both

<sup>13</sup> B. Tollens, *Ber.*, **41**, 1788 (1908).

<sup>14</sup> A. W. van der Haar, "Anleitung zum Nachweis, zur Trennung, und Bestimmung der Monosaccharide und Aldehydesäuren," Gebrüder Borntraeger, Berlin, 1920.

<sup>15</sup> C. A. Browne and F. W. Zerban, "Methods of Sugar Analysis," John Wiley and Sons, New York, 3rd ed., 1941.

<sup>16</sup> E. M. Kapp, *J. Biol. Chem.*, **134**, 144 (1940).

<sup>17</sup> E. Anderson and J. A. Crowder, *J. Am. Chem. Soc.*, **52**, 3711 (1930).

<sup>18</sup> K. Bailey and F. W. Norris, *Biochem. J.*, **26**, 1609 (1932).

<sup>19</sup> Alice G. Renfrew and L. H. Cretcher, *J. Biol. Chem.*, **97**, 503 (1932).

<sup>20</sup> E. Anderson, *J. Biol. Chem.*, **104**, 163 (1934).

<sup>21</sup> R. E. Gill, E. L. Hirst and J. K. N. Jones, *J. Chem. Soc.*, 1469 (1939).

<sup>22</sup> R. S. Tipson, C. C. Christman and P. A. Levene, *J. Biol. Chem.*, **128**, 609 (1939).

<sup>23</sup> E. Anderson, L. G. Gillette and M. Seeley, *J. Biol. Chem.*, **140**, 569 (1941).

<sup>24</sup> J. Mullan and E. G. V. Percival, *J. Chem. Soc.*, 1501 (1940).

<sup>25</sup> W. A. G. Nelson and E. G. V. Percival, *J. Chem. Soc.*, 58 (1942).

<sup>26</sup> Ref. 7, p. 48.

<sup>27</sup> M. R. Butler, *Biochem. J.*, **28**, 759 (1934).

<sup>28</sup> J. Buchanan, E. E. Percival and E. G. V. Percival, *J. Chem. Soc.*, 51 (1943).

<sup>29</sup> C. L. Butler and L. H. Cretcher, *J. Am. Chem. Soc.*, **51**, 1914 (1929).

<sup>30</sup> M. R. Butler, *Biochem. J.*, **25**, 403 (1931).

<sup>31</sup> M. Lüdtke and H. Felser, *Ann.*, **549**, 1 (1941).

<sup>32</sup> S. T. Henderson, *J. Chem. Soc.*, **131**, 2117 (1928).



the isolated product and the residual plant material. These substances may also be extracted as described later in connection with the extraction of hemicelluloses from wood. Branfoot<sup>7</sup> has made a detailed summary of work on the isolation and purification of pectic substances.

In the isolation of hemicelluloses from plant materials containing a relatively large amount of pectic substances, such as the cambium layer of a wood<sup>33</sup> or the leaves and stems of plants,<sup>34</sup> the water-soluble materials and insoluble pectic substances are first removed. The hemicelluloses are then extracted by an alkaline solution. Sodium hydroxide solutions at concentrations varying from 2 to 17% have been used for this purpose. Norman<sup>35</sup> recommends a 2% solution of sodium carbonate when high purity is more desirable than completeness of extraction. Most investigators have used a cold sodium hydroxide solution of approximately 4% concentration.<sup>35-42</sup>

In the isolation of hemicelluloses from plant materials containing relatively large amounts of hemicelluloses and small amounts of insoluble pectic materials, as in hardwoods,<sup>43</sup> the powdered material is first extracted with organic solvents and hot water. The hemicelluloses are then removed by two extractions with a cold 4% solution of sodium hydroxide. The material is made neutral with dilute hydrochloric acid and washed with water. It is then extracted successively with a hot .05 *N* solution of hydrochloric acid and a cold 5% solution of ammonium hydroxide. This procedure removes only a part of the hemicelluloses and pectic materials from a wood since lignin protects the underlying hemicelluloses from the alkaline solution or is combined with them.<sup>44, 45</sup> To overcome this difficulty the wood is suspended in water and treated with chlorine gas.<sup>43, 45, 46</sup> The subsequent addition of a large volume of

<sup>33</sup> E. Anderson, *J. Biol. Chem.*, **112**, 531 (1936).

<sup>34</sup> (a) H. D. Weihe and M. Phillips, *J. Agr. Research*, **60**, 781 (1940); (b) **64**, 401 (1942); (c) M. Phillips and B. L. Davis, *ibid.*, **60**, 775 (1940); (d) B. L. Davis and M. Phillips, *ibid.*, **63**, 241 (1941).

<sup>35</sup> A. G. Norman, *Biochem. J.*, **31**, 1579 (1937).

<sup>36</sup> F. W. Norris and I. A. Preece, *Biochem. J.*, **24**, 59 (1930).

<sup>37</sup> I. A. Preece, *Biochem. J.*, **24**, 972 (1930); **25**, 1304 (1931).

<sup>38</sup> S. Angell and F. W. Norris, *Biochem. J.*, **30**, 2159 (1936).

<sup>39</sup> H. W. Buston, *Biochem. J.*, **28**, 1028 (1934).

<sup>40</sup> M. H. O'Dwyer, *Biochem. J.*, **19**, 656 (1926); **22**, 381 (1928); **25**, 2017 (1931); **28**, 2116 (1934); **33**, 713 (1939).

<sup>41</sup> K. P. Link, *J. Am. Chem. Soc.*, **51**, 2506 (1929).

<sup>42</sup> I. A. Preece, *Biochem. J.*, **34**, 251 (1940).

<sup>43</sup> E. Anderson, L. W. Seigle, P. W. Krznarich, L. Richards and W. W. Marteny, *J. Biol. Chem.*, **121**, 165 (1937).

<sup>44</sup> Ref. 9, p. 61.

<sup>45</sup> A. G. Norman and J. G. Shirkhande, *Biochem. J.*, **29**, 2259 (1935).

<sup>46</sup> Lila Sands and P. Nutter, *J. Biol. Chem.*, **110**, 17 (1935).

alcohol and extraction with this hot solvent removes the chlorinated lignin. This procedure frees the pectic acid, which is removed by a cold 5% solution of ammonium hydroxide. Additional amounts of hemicellulose are then extracted with a 4% solution of sodium hydroxide. This procedure has been used in the study of several hardwoods, and in every case hemicelluloses and pectic materials have been obtained both before and after chlorination.<sup>33, 43, 46, 47</sup>

To isolate the pectic materials and hemicelluloses from the alkaline solutions, they may be precipitated as ammonium or sodium salts by addition of alcohol, or the solutions may be made slightly acid with dilute hydrochloric acid and the materials precipitated by alcohol.

A new approach to the isolation of hemicelluloses is through the production of holocellulose<sup>48</sup> by chlorination of the wood followed by extraction of the holocellulose with a 3% solution of ethanolamine in alcohol. The holocellulose contains the carbohydrate portion of the wood freed of lignin. Hemicelluloses are then extracted from this product in the regular way.<sup>49-51</sup>

### 3. Purification of Polyuronides

Most polyuronides are complex mixtures of closely related compounds. They cannot be purified by crystallization. The most that can be done is to free them as far as possible from inorganic materials and non-polyuronide organic materials and to separate them by various methods of fractionation into mixtures that approximate the composition of definite compounds. During this process acids should be used only in low concentrations and at low temperatures.

Dialysis and electrodialysis have been used in the purification of some polyuronides.<sup>52-57</sup> Inorganic impurities may be reduced in amount

<sup>47</sup> (a) E. Anderson, M. Seeley, W. T. Stewart, J. C. Redd and D. Westerbeke, *J. Biol. Chem.*, **135**, 189 (1940); (b) E. Anderson, R. B. Kaster and M. Seeley, *ibid.*, **144**, 767 (1942).

<sup>48</sup> G. J. Ritter and E. F. Kurth, *Ind. Eng. Chem.*, **25**, 1250 (1933); W. G. Van Beckum and G. J. Ritter, *Paper Trade J.*, **104**, 49 (1937); **108**, 27 (1939).

<sup>49</sup> R. L. Mitchell and G. J. Ritter, *J. Am. Chem. Soc.*, **62**, 1958 (1940).

<sup>50</sup> M. A. Millett, Ph.D. Dissertation, Univ. Wisconsin (1943).

<sup>51</sup> Unpublished work of B. B. Thomas of The Institute of Paper Chemistry, Appleton, Wis.

<sup>52</sup> L. Rosenthaler (tr. by S. Ghosh). "The Chemical Investigation of Plants," G. Bell and Son, London, 1930.

<sup>53</sup> R. A. Gortner, "Outlines of Biochemistry," John Wiley and Sons, New York, 2nd ed., 1938.

<sup>54</sup> M. H. O'Dwyer, *Biochem. J.*, **20**, 656 (1926).

<sup>55</sup> W. F. Hoffman and R. A. Gortner, *J. Biol. Chem.*, **65**, 371 (1925).

<sup>56</sup> A. W. Thomas and H. A. Murray, *J. Phys. Chem.*, **32**, 676 (1928).

<sup>57</sup> F. E. Brauns, *Ind. Eng. Chem., Anal. Ed.*, **13**, 259 (1941).

by repeatedly precipitating the material from slightly acid solution by the addition of alcohol. This process removes some of the lignin, and other impurities. However, lignin is best removed by dissolving the polyuronide in water or dilute alkali, making the solution faintly acid with hydrochloric acid and adding liquid bromine.<sup>47a</sup> The purified material is precipitated by the addition of alcohol. Norman suggests the use of chlorine dioxide or sodium hypochlorite for the removal of lignin.<sup>58</sup> After extraction of the hemicelluloses, they may be purified by chlorination and subsequent extraction of the chlorinated lignin with a 3% solution of ethanolamine in alcohol.<sup>54</sup>

Mixtures of polyuronides may be partly separated by fractional solution in water and alcohol<sup>28</sup> or by fractional precipitation from water or dilute acid or alkaline solution by the addition of alcohol.<sup>35, 37</sup> Copper hydroxide in the form of Fehling's solution has been used, especially in the separation of mixtures of celluloses and polyuronides.<sup>18, 34c, 42, 59, 60</sup> The acylation of a mixture of polyuronides and the separation into soluble and insoluble portions by use of chloroform and acetone has also been used.<sup>24</sup> Methylation followed by fractional distillation under reduced pressure has also found application for this purpose.

Pectin and pectic materials that contain relatively small amounts of other materials can be readily converted to insoluble calcium pectate.<sup>61</sup> When these materials have been isolated from a hardwood or similar material, they consist of pectic acid mixed with hemicelluloses, lignin and coloring matter. To remove these impurities, the material is treated with liquid bromine. The pectic acid and hemicelluloses are precipitated by alcohol and washed with this solvent until free of brominated lignin. The pectic acid is then separated from the hemicellulose by conversion to insoluble calcium pectate.

#### 4. Analysis of Polyuronides

The analytical determinations most often made on a polyuronide before it is hydrolyzed are those for uronic acid, pentosan, methylpentosan, methoxyl and ash. The percentage of hexosan is usually estimated by difference. When the polyuronide has been obtained as a free acid it can in many cases be titrated with a base. Such metals as sodium, potassium, magnesium, calcium and iron often occur and especially so in plant gums and mucilages.

<sup>48</sup> Ref. 9, p. 57.

<sup>49</sup> E. G. V. Percival, *J. Chem. Soc.*, 54 (1934).

<sup>50</sup> F. W. Norris and I. A. Preece, *Biochem. J.*, 24, 59 (1930).

<sup>51</sup> Ref. 7, p. 73.

The content of uronic acid is determined by some modification of the original method of Lefèvre and Tollens.<sup>62-65</sup> Norman<sup>66</sup> has described some errors inherent in this method.

Pentosan and methylpentosan determinations are described in standard works.<sup>67</sup> When these determinations are made on polyuronides, they are inaccurate and of restricted use in calculating the relative number of pentosan and methyl pentosan units per uronic acid unit. This is especially true when pentoses, methylpentoses and hexoses occur together in a polyuronide.

The content of methoxyl can be accurately determined as described by Clark.<sup>68</sup>

### 5. Hydrolysis of Polyuronides

Three types of carbon-oxygen linkages may occur in a polyuronide: ester, ether and glycoside. The ester-linked methyl group of pectins is split by cold dilute alkali. It may also be removed by certain enzymes. Methyl groups which often occur ether-linked to the uronic acid especially in plant gums and hemicelluloses,<sup>19, 20, 46, 69-72</sup> resist hydrolysis by mineral acid solutions of 2 to 4% concentrations, even in the autoclave. Such groups survive hydrolytic conditions that are usually chosen.

The furanoside bond of glycosides is easily split. Even the acidity of the free gum or mucilage acid in water solution is sufficient to sever furanoside bonds on long boiling,<sup>73</sup> while heating with a 1% solution of a mineral acid at 80° will break them in a few hours.<sup>69, 74-76</sup> The pyranoside bond on the other hand rather successfully survives this mild treatment.<sup>69, 73, 76</sup> However, when the pyranose form of a uronic acid is linked through its aldehyde group to a sugar, its complete degradation

<sup>62</sup> K. U. Lefèvre and B. Tollens, *Ber.*, **40**, 4513 (1907).

<sup>63</sup> A. D. Dickson, H. Otterson and K. P. Link, *J. Am. Chem. Soc.*, **52**, 775 (1930).

<sup>64</sup> R. L. Whistler, A. R. Martin and M. Harris, *J. Research Natl. Bur. Standards*, **24**, 13 (1940).

<sup>65</sup> F. W. Norris and C. E. Resch, *Biochem. J.*, **29**, 1591 (1935).

<sup>66</sup> Ref. 9, p. 213.

<sup>67</sup> "Methods of Analysis," Assoc. Official Agr. Chemists, 5th ed., Washington, 1940.

<sup>68</sup> E. P. Clark, *J. Assoc. Official Agr. Chem.*, **15**, 136 (1932); **22**, 622 (1939).

<sup>69</sup> E. Anderson and Louise Otis, *J. Am. Chem. Soc.*, **52**, 4461 (1930).

<sup>70</sup> K. Bailey, *Biochem. J.*, **26**, 1609 (1932).

<sup>71</sup> M. H. O'Dwyer, *Biochem. J.*, **33**, 713 (1939).

<sup>72</sup> Lila Sands and W. Y. Gary, *J. Biol. Chem.*, **101**, 573 (1933).

<sup>73</sup> (a) E. L. Hirst and J. K. N. Jones, *J. Chem. Soc.*, 1174 (1933); (b) J. K. N. Jones, *ibid.*, 558 (1939).

<sup>74</sup> E. Anderson, F. H. Russell and L. W. Seigle, *J. Biol. Chem.*, **113**, 683 (1936).

<sup>75</sup> C. L. Butler and L. H. Cretcher, *J. Am. Chem. Soc.*, **53**, 4160 (1931).

<sup>76</sup> Lila Sands and R. Klaas, *J. Am. Chem. Soc.*, **51**, 3441 (1929).

may require an acid concentration of 4% at 120° for ten to twenty-four hours.<sup>25, 74, 77</sup> Such drastic treatment destroys a large amount of the uronic acid; yet Mullan and Percival<sup>24</sup> hydrolyzed the mucilage from the seed of *Plantago lanceolata* at 100° for twenty-four hours with a 15% solution of sulfuric acid and obtained the barium salt of a uronic acid in amount sufficient for analysis. Butler and Cretcher<sup>29</sup> hydrolyzed alginic acid with a cold 80% solution of sulfuric acid. Later Schoeffel and Link hydrolyzed this acid with a 2.5% solution of sulfuric acid at 100°. <sup>78</sup>

In general, methylation tends to reduce the ease of hydrolysis of polyuronides. Methylated compounds are successfully degraded by heating in a boiling methyl alcohol solution containing 3 to 4% hydrochloric acid.<sup>10, 24</sup> In order to split methylated polyuronic acids by this method, they may be heated under pressure.<sup>79, 80</sup> To prove that the carboxyl group increases the difficulty in splitting the uronosidic linkage, pectic acid was methylated and the carboxyl groups reduced. The resulting material was more easily hydrolyzed than that before reduction.<sup>81</sup>

In polyuronides the glycosidic bond may be attached to any of the carbons 2 to 6. The ease of hydrolysis of these compounds may be influenced by variation in the point of attachment. Alpha glycosidic linkages seem to be more easily ruptured than beta linkages.

Polygalacturonic acid has been hydrolyzed by the enzyme pectinase in the preparation of D-galacturonic acid.<sup>82</sup> When enzymatic hydrolysis of a polyuronide is possible, it is very useful since there is little decomposition of the products by this method. In addition it gives valuable information as to the type of glycosidic linkage present.

Fractional hydrolysis is often used to advantage. In this method the sugars are split off in successive stages by subjecting the material to successively more severe conditions of hydrolysis and separating the

<sup>77</sup> S. Morell, L. Baur and K. P. Link, *J. Biol. Chem.*, **105**, 15 (1934).

<sup>78</sup> (a) E. Schoeffel and K. P. Link, *J. Biol. Chem.*, **95**, 213 (1932); (b) K. P. Link and R. Nedden, *ibid.*, **94**, 307 (1931).

<sup>79</sup> G. H. Beaven and J. K. N. Jones, *Chemistry and Industry*, **17**, 363 (1939).

<sup>80</sup> S. Luckett and F. Smith, *J. Chem. Soc.*, 1106, 1114, 1506 (1940).

<sup>81</sup> P. A. Levene, G. M. Meyer and M. Kuna, *Science*, **89**, 370 (1939).

<sup>82</sup> E. Abderhalden (F. Ehrlich), "Handbuch der biologischen Arbeitsmethoden," Abt. I, Teil II, Urban und Schwarzenberg, Berlin, 1936, p. 1617; H. H. Mottern and H. L. Cole, *J. Am. Chem. Soc.*, **61**, 2701 (1939); I. Manville, F. Reithel and P. Yamada, *ibid.*, **61**, 2973 (1939); W. W. Pigman, *J. Research Natl. Bur. Standards*, **25**, 301 (1940); E. Riets and W. D. Maclay, *J. Am. Chem. Soc.*, **65**, 1242 (1943); P. P. Regna and B. P. Caldwell, *ibid.*, **66**, 244 (1944); H. S. Isbell and Harriet L. Frush, *J. Research Natl. Bur. Standards*, **32**, 77 (1944).

fission products at each step. This yields a less complex mixture of sugars and facilitates their isolation and identification. It also yields toward the end an aldotronic or aldobionic acid from which can be obtained detailed information concerning these small units.

The acids most often used in hydrolyzing polyuronides are sulfuric, hydrochloric and oxalic. When the catalyzing acid must be removed at the close of the hydrolysis, sulfuric or oxalic is used. The mineral acids are more effective in bringing about hydrolysis, but oxalic acid accomplishes this with less decomposition.

### 6. *Separating the Products of Hydrolysis*

After the polyuronide has been partially hydrolyzed by the mineral acid, the unhydrolyzed portion of the molecule, which contains the uronic acid, and the free sugars are separated from each other. The method used in this process varies with the polyuronide, the degree of hydrolysis and the catalyzing acid. When hydrolysis has been prolonged and the uronic acid is present largely as an aldobionic acid, the solution is neutralized (usually with barium or calcium carbonate); the solution containing a salt of the aldobionic acid and the free sugars is filtered from the precipitated salt of the catalyzing acid. The solution is concentrated under reduced pressure, and the salt of the aldobionic acid is precipitated as a gum by the addition of alcohol to the solution,<sup>22, 75, 83</sup> or as a flocculent solid by pouring the concentrated solution slowly, with stirring, into excess 95% alcohol.<sup>34a, 46, 73, 78a, 84</sup> The salt is separated from the alcoholic solution of the sugars. When the polyuronide has been degraded to only a slight extent, as in the first step of a fractional hydrolysis, the unchanged part of the molecule is precipitated from the acid solution by the addition of alcohol.<sup>73</sup> The alcoholic solution of the hydrolyzing acid and free sugar is concentrated, and the mineral acid is separated from the sugar.

## III. IDENTIFYING THE UNITS IN THE POLYURONIDE

### 1. *Methoxyl*

The presence of a methyl group may be detected by the method of Denigès.<sup>85</sup> This method depends on the oxidation of the methyl group to formaldehyde and detection of this aldehyde by rosaniline-sodium sulfite solution. Methyl ester and ether linkages may be distinguished

<sup>22</sup> (a) M. Heidelberger and W. F. Goebel, *J. Biol. Chem.*, **74**, 613 (1927); (b) W. F. Goebel, *ibid.*, **110**, 391 (1935).

<sup>34</sup> K. Bailey, *Biochem. J.*, **29**, 2477 (1935).

<sup>85</sup> M. G. Denigès, *Compt. rend.*, **150**, 529 (1910).

by the method of von Fellenberg.<sup>86, 87</sup> This method depends on the fact that an ester-linked methyl group is liberated by heating the compound at 80° with a 2% solution of sodium hydroxide while an ether-linked methyl group is only liberated by heating the compound for ten minutes in a boiling 72% solution of sulfuric acid. These tests can be made on the original polyuronide.

## 2. The Sugars

The sugars that occur most often in polyuronides are: D-galactose, D-glucose, D-mannose, D-xylose, L-arabinose, and L-rhamnose. Other rare sugars occur in nature and may be found in polyuronides. This fact should be kept in mind in examining sugar mixtures obtained by the hydrolysis of polyuronides.

Some polyuronides contain but a single sugar. Often two and three different sugars are present. Polyuronides containing more than four different sugars are rare. In identifying the sugars, color tests alone should not be relied upon since during hydrolysis of the polyuronide with mineral acids decomposition products result that often render some of the color tests unreliable.

After hydrolysis of the polyuronide and separation of the products, the sugars, except those remaining attached to the uronic acid components, will be in the alcohol-soluble portion. Detailed directions for separating, identifying and determining sugars in mixtures such as these are given in various reference works<sup>14, 15</sup> and research articles.<sup>34b, 73</sup> The solvents most often used in crystallizing the sugars are glacial acetic acid, ethanol, methanol, and water and mixtures of these solvents.

## 3. The Uronic Acids

Three uronic acids occur in nature, D-galacturonic, D-glucuronic and D-mannuronic acids. No polyuronide is known that contains two different uronic acids. D-Glucuronic acid containing an ether-linked methyl group occurs in mesquite gum.<sup>69</sup> It probably is the monomethyluronic acid that occurs in many hemicelluloses.<sup>47a, 72, 88</sup>

The identification of the uronic acid in a polyuronide is somewhat difficult<sup>89</sup> because during hydrolysis a large part of it is destroyed, and the free acid finally obtained is contaminated with decomposition and reversion products as well as with low polymers resulting from incomplete

<sup>86</sup> T. von Fellenberg, *Biochem. Z.*, **85**, 44 (1918).

<sup>87</sup> Louise Otis, Ph.D. dissertation, Northwestern University, 1930.

<sup>88</sup> M. H. O'Dwyer, *Biochem. J.*, **28**, 2116 (1934).

<sup>89</sup> C. Niemann, E. Schoeffel and K. P. Link, *J. Biol. Chem.*, **101**, 337 (1933).

hydrolysis. Furthermore the acids form few, well-defined, insoluble derivatives with distinguishing characteristics. This difficulty accounts for the fact that the uronic acid has remained unidentified in many investigations although its presence has been established by color tests or carbon dioxide production. It is difficult to split off the ether-linked methyl group from the naturally occurring monomethyluronic acids without destroying the acid. In only a few cases have these acids been identified.<sup>19, 69</sup>

Norman<sup>90</sup> has tabulated the constants for various derivatives of the uronic acids and has summarized previous work on their identification. The free acids or their lactones have been used for the purpose of identification.<sup>78a, 84, 91, 92, 93</sup> The quinine, brucine, and cinchonine salts<sup>91, 34b, 94</sup> have also been used for this purpose, although their isolation in pure form is hindered by the presence of the corresponding alkaloidal salts of the low polymers of the acid. Some of the complex hydrazines have been used to identify the acids.<sup>73, 89, 95</sup> *p*-Bromophenylhydrazine has been frequently used for this purpose. One difficulty in the use of hydrazines is that they may form numerous types of derivatives such as salts, hydrazides, hydrazones and osazones.

The method of Heidelberger and Goebel<sup>83a</sup> has been used to identify *D*-glucuronic and *D*-mannuronic acids without isolating the free acid. *D*-Glucuronic acid by this method yields *D*-saccharic acid, which is identified as the potassium acid saccharate, while *D*-mannuronic acid yields *D*-mannosaccharic acid which can be identified as the di-amide. Since both *D*- and *L*-galacturonic acids give mucic acid, this method cannot be used for the complete identification of galacturonic acid. However, since *L*-galacturonic acid has not been observed in nature, the formation of mucic acid by this method is very strong evidence of the presence of *D*-galacturonic acid.

Studies of the methylation products have also supplied evidence for the identification of these acids.<sup>73, 96</sup> After complete methylation and hydrolysis of the aldobionic or polyuronic acid, it is often possible to isolate the methylated uronide as the lactone, or methyl ester. The acid may also be oxidized to the methylated dibasic acid and identified as such. Furthermore, after methylation and hydrolysis of pectic and

<sup>90</sup> Ref. 9, p. 211.

<sup>91</sup> C. Niemann and K. P. Link, *J. Biol. Chem.*, **104**, 205 (1934).

<sup>92</sup> W. L. Nelson and L. H. Cretcher, *J. Am. Chem. Soc.*, **52**, 2130 (1930).

<sup>93</sup> E. Schoeffel and K. P. Link, *J. Biol. Chem.*, **100**, 397 (1933).

<sup>94</sup> W. L. Nelson and L. H. Cretcher, *J. Am. Chem. Soc.*, **54**, 3409 (1932).

<sup>95</sup> H. Granischstadt and E. G. V. Percival, *J. Chem. Soc.*, 54 (1943).

<sup>96</sup> F. Smith, *J. Chem. Soc.*, 1035 (1940).



alginic acids, followed by bromine oxidation of the products, the 2,3-dimethyldibasic acid is obtained. If the dimethyldibasic acid is oxidized by per-iodic acid and bromine, pectic acid yields (*dextro*)-dimethoxysuccinic acid while alginic acid yields meso dimethoxysuccinic acid; thus galacturonic and mannuronic acids may be differentiated.

#### IV. METHODS FOR DETERMINING THE STRUCTURE OF POLYURONIDE MOLECULES

Analysis of the original polyuronide and of the products formed during its fractional hydrolysis indicate the relative positions of some of the sugar units in the molecule. The relative ease and extent of hydrolysis of the material under different conditions and the progressive changes in the specific rotation of the products throw some light on the nature of the glycosidic linkages in the molecule. Analysis and hydrolysis of the aldobionic and aldotrionic acids obtained during the hydrolysis of a polyuronide establish the first and second units in the chain of sugars that is attached to the uronic acid. Hypiodite oxidation<sup>17</sup> of the reducing group of the aldobionic acids has shown that the bound aldehyde is always that of the uronic acid.<sup>97</sup>

The unit to which an ether-linked methyl group is attached can be determined by hydrolyzing the polyuronide, separating the various products and testing each for the methyl group. The carbon to which the ether-linked methyl is attached has not yet been determined. The carboxyl group in plant gums, many mucilages and some pectic materials is present as a salt. On the other hand, the insolubility in water of hemicelluloses in the native condition and their slight solubility in water after they have been dissolved by sodium hydroxide, suggests that the carboxyl group in these compounds is in ester union with some plant material, probably lignin.<sup>98</sup> In other materials, it may be esterified with methyl alcohol.

The most valuable means for determining the structure of a polyuronide is by a study of the products obtained by hydrolysis of the completely methylated material as developed by W. N. Haworth and associates.<sup>10,12</sup> Any methylated hexose found in the hydrolyzate with two carbons (including the glycosidic carbon) not methylated could only have occupied the non-reducing end of a polysaccharide chain. On the other hand, any methylated sugar with three non-methylated carbons must have developed the third free hydroxyl during hydrolysis of the chain. Such a sugar could have occupied any position in a straight

<sup>97</sup> W. F. Goebel, *J. Biol. Chem.*, **72**, 809 (1927).

<sup>98</sup> Ref. 9, p. 59.

polysaccharide chain except the non-reducing end. Any methylated sugar with four non-methylated carbons must have developed two free hydroxyls during hydrolysis of the chain. Such a condition indicates the sugar residue at which a branch is attached to the polysaccharide chain. It is possible to make an approximately quantitative separation of the variously methylated monosaccharides. Their relative amounts in the hydrolyzate will indicate the extent of branching of the chain both on the basis of the number of end groups and of branching groups. Often the results permit several interpretations between which there is as yet no satisfactory way of choosing. The methylated sugars occurring in the hydrolyzate can usually be identified as furanose or pyranose forms.

Per-iodic acid is known to split carbon chains between carbons containing adjacent hydroxyl groups. This method has been used in studying the structure of some polyuronides and confirms the results obtained by methylation of these materials.<sup>79, 99, 100</sup>

Average equivalent weights may be calculated for various polyuronides from the percentage of uronic acid and often by titration of the free polyuronic acid. When other characteristic groups are present such as an ether-linked methyl or a reducing sugar group, they may also be used as a basis for calculating equivalent weights. While these equivalent weights have little significance in estimating the molecular size of the polyuronides, they may in some cases be very helpful in determining the size of a repeating unit in the molecule.

The important physical and chemical methods for estimating the size of starch and celuloise molecules are based on measurements of viscosity, osmotic pressure, speed of sedimentation in the ultracentrifuge and end group studies. These methods are now being used in the study of polyuronides.

#### V. SOME RESULTS OF STRUCTURAL INVESTIGATIONS OF THE POLYURONIDES

In 1934, Morell, Baur and Link<sup>77</sup> showed by end group studies of a polygalacturonic acid obtained by partial hydrolysis of citrus pectic acid that it consisted of an open chain of 8 or 10 D-galacturonic acid units. In 1940 Lockett and Smith<sup>101</sup> showed that a similar degraded polygalacturonic acid consisted of 13 units of galacturonic acid. Other methylation studies on polygalacturonic acids have shown that they consist of a chain of D-galacturonic acid units joined by 1,4-pyranoside

<sup>99</sup> P. A. Levene and L. C. Kreider, *J. Biol. Chem.*, **120**, 591 (1937).

<sup>100</sup> B. W. Lew and R. A. Gortner, *Arch. Biochem.*, **1**, 325 (1943).

<sup>101</sup> S. Lockett and F. Smith, *J. Chem. Soc.*, 1106 (1940).

linkings.<sup>79</sup> X-ray studies of the nitric acid esters of pectin support this chain structure of polygalacturonic acid.<sup>102</sup>

End group studies have not been used to determine the chain length of the pectin molecule since only the partially degraded pectin undergoes complete methylation.<sup>12, 77</sup> Ultracentrifuge measurements on pectins from various sources indicate that they have molecular weights varying from approximately 25,000 to 50,000.<sup>103</sup> If pectin were a simple polymerized galacturonic acid anhydride, this maximum molecular weight would correspond to a chain length of approximately 280 D-galacturonic acid units. However, the carboxyls in pectin are largely methylated. In addition, varying amounts of admixed araban and galactan are present. Hence, the chain length of pectin must be less than 280 uronic acid units. Ultracentrifuge measurements also show a lack of uniformity of particle size within any one pectin preparation and a variation in the average size of pectins from different sources. Viscosity measurements on nitric acid esters of pectins from apples, lemons, and oranges give values for molecular weights varying from 150,000 to 200,000.<sup>104, 105</sup> If these materials were pure polymerized di-nitric acid esters of galacturonic acid anhydride, the maximum molecular weight would correspond to a chain length of approximately 740 units. Since, however, admixed arabans and galactans are present, the chain length must be less than 740 units.

Pectin preparations usually show the presence of an araban and a galactan along with the pectic acid. By using methods that would not hydrolyze furanoside linkings it has been possible to isolate an araban from the pectin of peanuts, apples, citrus fruits and from the seed of *Lupinus albus*.<sup>12, 73a, 106</sup> A galactan was also isolated from *Lupinus albus*. In connection with this work, Hirst wrote: "It has long been known that pectin consists essentially of a mixture of polysaccharides including an araban, a galactan and a polygalacturonic acid."<sup>12</sup>

The alginic acids of marine algae correspond closely to the pectic acids of higher plants. They consist of chains of D-manno-pyranuronic acid units joined by 1:4  $\beta$ -linkages.<sup>10</sup>

Plant gums always contain either D-galacturonic or D-glucuronic acid and at least two of the following sugars: D-galactose, L-arabinose, L-rham-

<sup>102</sup> F. A. Henglein and G. G. Schneider, *Ber.*, **69**, 321 (1936).

<sup>103</sup> F. W. Norris, *Ann. Repts. Progress Chem. (Chem. Soc. London)*, **35**, 364 (1938).

<sup>104</sup> S. Peat, *Ann. Repts. Progress Chem. (Chem. Soc. London)*, **34**, 301 (1937).

<sup>105</sup> G. G. Schneider and H. Bock, *Ber.*, **70B**, 1617 (1937).

<sup>106</sup> E. L. Hirst and J. K. N. Jones, *J. Chem. Soc.*, 452, 454 (1939); G. H. Beaven, E. L. Hirst and J. K. N. Jones, *ibid.*, 1865 (1939).

nose, D-mannose and D-xylose. In some cases an ether-linked methyl group is attached to the glucuronic acid.

Mesquite gum is one of the simplest of this group of polyuronides. It consists of monomethyl-D-glucuronic acid attached to a chain of three units of D-galactose and four units of L-arabinose. The ease with which the arabinose is removed suggests a furanoside linkage for this sugar.<sup>69</sup>

Methylation studies on gum arabic prove that the repeating unit is very complex. This unit consists of a poly-D-galactopyranose chain to which are attached D-galacturonic acid units. To these uronic acids and to some of the galactose units, there are attached by L-arabinofuranoside linkages, saccharide chains consisting of L-arabinofuranose, L-rhamnopyranose and D-galactopyranose units. There are 1:3, 1:4 and 1:6 glycosidic linkages in the molecule. The aldobionic acid present in gum arabic is 6- $\beta$ -glucuronosidogalactose.<sup>80</sup>

Damson gum<sup>73a, 107</sup> resembles gum arabic in its intricately branching chain as well as in the carbohydrate content and general arrangement. D-Mannose and a small amount of D-xylose were found in place of L-rhamnose. The aldobionic acid present in this gum is 2- $\beta$ -D-glucopyrano-uronosido-D-mannose. While the work on the structure of cherry gum<sup>73b</sup> is less advanced, it appears to be of the same type as damson gum and gum arabic. The aldobionic acid is the same as that in damson gum.

The structure of polyuronic mucilages<sup>10</sup> has been less thoroughly studied than that of plant gums. They contain D-galacturonic acid and the same general group of sugars as the gums. The mucilages from flaxseed and from slippery elm bark yield the same aldobionic acid, 2-D-galacturonosido-L-rhamnose.

Many hemicelluloses are known to consist of D-glucuronic acid, combined with D-xylose, L-arabinose, or both and to contain no hexose. A few hemicelluloses have been reported to contain D-galacturonic acid, D-glucose, D-mannose or D-galactose.<sup>38, 39, 54, 108</sup> Since pectic materials and celluloses often dissolve in the alkaline solution used in extracting the hemicelluloses, it is quite possible that the galacturonic acid and hexoses may be derived from these materials and not from hemicelluloses.

Little has been done in studying the size and structure of hemicellulose molecules. Some that have been isolated from hardwoods and separated from lignin and pectic materials consist of a monomethyluronic acid combined with a series of molecules of D-xylose. The difficulty with

<sup>107</sup> E. L. Hirst and J. K. N. Jones, *J. Chem. Soc.*, 1482 (1939).

<sup>108</sup> A. G. Norman, *Biochem. J.*, **23**, 1353 (1929); H. W. Buston, *ibid.*, **38**, 44 (1938); E. F. Kurth and G. J. Ritter, *J. Am. Chem. Soc.*, **56**, 2720 (1934); E. Anderson, J. Kesselman and E. C. Bennett, *J. Biol. Chem.*, **140**, 536 (1941).

which they are hydrolyzed suggests the presence of D-xylopyranose. Frequently they reduce Fehling's solution. This is certainly due to incipient hydrolysis during isolation and purification. The equivalent weights calculated for these bodies<sup>47a</sup> often indicate the presence of 16 to 18 units of D-xylose for each uronic acid unit. Since some of the sugar units must have been lost in the hydrolysis, this value is a minimum chain length. Possibly this simple chain is a repeating unit, many of which make up the hemicellulose molecule.

## AUTHOR INDEX \*

### A

Abderhalden, E.: 330, 336  
 Adams, Mildred: 26  
 Adams, M. H.: 254  
 Alberda van Ekenstein, W.: 10, 64, 199  
 Allard, G.: 13  
 Allen, F. W.: 228, 231, 244 (124)  
 Alsberg, C. L.: 253, 258  
 Altmann, R.: 194  
 Anderson, C. G.: 49, 50  
 Anderson, E.: 19, 331, 332, 333 (33, etc.),  
 334 (23, 47a), 335, 336 (74), 338 (47a,  
 69), 339 (69), 340 (17), 343\* (69),  
 344 (47a)  
 Angell, S.: 332, 343 (38)  
 Ariyama, T.: 182  
 Armstrong, A. R.: 233  
 Astbury, W. T.: 245, 271  
 Austin, W. C.: 10, 38, 42, 43, 64 (13),  
 72 (13), 73 (13)

### B

Babo, L., v.: 129  
 Badenhuisen, N. P.: 248  
 Baer, E.: 65  
 Bailey, K.: 331, 334 (18), 335, 337, 339 (84)  
 Baird, D. K.: 284, 296  
 Baker, J. C.: 305  
 Baldwin, M. E.: 251  
 Baldwin, R. R.: 266  
 Bang, I.: 214  
 Barger, G.: 266  
 Barker, G. R.: 199, 217  
 Barnett, W. L.: 288  
 Bass, L. W.: 196, 208  
 Bates, F. J.: 10, 38, 76  
 Bates, F. L.: 257, 260, 261 (32)  
 Baumgarten, Rosa: 132  
 Baur, L.: 336, 341, 342 (77)  
 Bawden, F. C.: 236  
 Beans, H. T.: 257  
 Bear, R. S.: 265  
 Beaven, G. H.: 336, 341 (79), 342\* (79)

Beck, F. F.: 177, 178, 179, 284  
 Beckmann, C. O.: 249, 267, 271  
 Behrens, M.: 196  
 Bell, D. J.: 155  
 Bell, F. O.: 245, 271  
 Bellows, J.: 189  
 Belozerskiĭ, A. N.: 196  
 Bennett, E. C.: 343  
 Bennet-Clark, T. A.: 47  
 Benoy, Marjorie P.: 254  
 Berg, J. C.: 284, 287 (27), 288 (27)  
 Berger, E.: 213, 218\* (80), 223, 232 (110),  
 244\* (110)  
 Bergmann, M.: 40, 58, 75 (59), 78, 79,  
 80, 113, 133, 134, 153, 284  
 Berl, E.: 304, 305  
 Bernfeld, P.: 251, 262, 268, 269, 282, 284  
 (5), 294 (5), 295 (5), 297 (5)  
 Berthon, P.: 301, 302 (95)  
 Bertrand, G.: 13, 14, 16, 33, 71, 158, 188  
 Beuchelt, H.: 197, 226 (25), 232, 233 (25)  
 Beuther, Anne M.: 136, 145  
 Bevan, E. J.: 289, 292 (52), 307  
 Bielchowsky, F.: 197, 226 (25), 233 (25),  
 238  
 Bigelow, N. M.: 168, 172  
 Blanksma, J. J.: 10, 199  
 Blatherwick, N. R.: 189  
 Bock, H.: 342  
 Bodycote, E. W.: 60, 61, 72 (64), 73 (64),  
 75 (64)  
 Boeseken, J.: 213, 284, 287 (27), 288 (27)  
 Boettger, I.: 227, 234 (123c), 245  
 Bohle, K.: 168, 172  
 Bohm, E.: 87  
 Bolomey, R. A.: 228, 231  
 Bolz, F.: 269, 296  
 Bonner, J.: 330  
 Bosshard, E.: 198  
 Bosshard, W.: 67, 68, 69  
 Bott, H. G.: 79, 84, 105, 108, 111 (6),  
 114 (6)  
 Bottazzi, F.: 306

\* The numbers in parentheses are reference numbers. An asterisk preceding the parentheses indicates that, besides the reference numbers, the author's name also is mentioned elsewhere on the page.

- Bouchardat, G.: 191  
 Bougault, J.: 13  
 Bourquelot, E.: 13, 47  
 Boutron-Charlard: 129, 130  
 Braconnot, H.: 303  
 Bradshaw, P. J.: 189  
 Brady, T. G.: 238  
 Branfoot, M. H.: 330, 331 (7), 332, 334 (7)  
 Braun, E.: 59, 60, 73 (61), 79, 107, 111 (5),  
 114 (5)  
 Brauns, D. H.: 90, 114, 115, 124  
 Brauns, F. E.: 333  
 Bredereck, H.: 197, 205, 209, 213, 218\*  
 (80), 223, 224, 225, 226 (25), 231,  
 232, 233 (25), 235, 242, 244\* (110), 245  
 Brentano, W.: 251, 262  
 Briggs, J. F.: 307  
 Brigl, P.: 60, 112, 137, 139, 143, 284, 285  
 (33), 296  
 Brimhall, B.: 274  
 British Celanese Ltd.: 290  
 Brown, H. F.: 305  
 Brown, R. L.: 14, 27  
 Browne, C. A.: 331, 338 (15)  
 Bruyn, C. A. Lobry de. *See* Lobry de  
 Bruyn, C. A.  
 Buchanan, J.: 331  
 Buckles, R. E.: 115  
 Bungenberg de Jong, H. G.: 258  
 Burghart, L. M.: 313  
 Burkard, C. A.: 287, 288 (38), 290\* (38)  
 Burkhart, O.: 59, 60, 73 (61)  
 Bussy, A.: 129, 130  
 Buston, H. W.: 332, 343\* (39)  
 Butenandt, A.: 235  
 Butler, C. L.: 331, 335, 336  
 Butler, M. R.: 331  
 Bütler, R.: 304
- C
- Caesar, G. V.: 274  
 Caldwell, B. P.: 10, 70, 71, 73 (87), 336  
 Caldwell, C. G.: 300  
 Calvery, H. O.: 195  
 Cannan, R. K.: 186  
 Caro, W.: 320  
 Carolles, B.: 306  
 Carpenter, F. H.: 227, 228, 232  
 Carr, C. J.: 135, 177, 178\* (4), 182, 183,  
 184, 185, 186, 187 (38), 189, 191\* (34),  
 192
- Caspersson, T.: 194, 196, 244  
 Catron, L. F.: 177  
 Chandler, L. B.: 43, 72 (17)  
 Cheburkina, N. V.: 196  
 Chernoff, L. H.: 19  
 Chigirev, S. D.: 196  
 Christman, C. C.: 331, 337 (22)  
 Chugaev, L.: 143  
 Clapp, S. H.: 208  
 Clark, E. P.: 19, 335  
 Clarke, G. J.: 324  
 Clarke, G. R.: 323  
 Clarke, H. T.: 289, 292 (53), 318, 319, 320  
 Clement, L. E.: 313  
 Clibbens, D.: 132  
 Cloetta, M.: 159, 160, 163  
 Coehn, A.: 306  
 Cohen, H. R.: 255  
 Cohen, J.: 189  
 Cohen, S. S.: 235, 236, 245  
 Cole, H. L.: 70, 336  
 Coleman, J. D.: 320  
 Compton, J.: 30, 50, 155  
 Conant, J. B.: 313  
 Cooke, R. Kathleen: 199  
 Cori, C. F.: 271  
 Cori, Gerty T.: 271  
 Cornthwaite, W. R.: 87  
 Cramer, F. B.: 82, 90, 91, 112 (12), 122  
 (12), 291, 315  
 Cremer, M.: 177  
 Cretcher, L. H.: 331, 335, 336, 339 (19)  
 Cross, F.: 289, 292 (52), 307  
 Crowder, J. A.: 331, 340 (17)  
 Cushing, M. I.: 274
- D
- Dakin, H. D.: 176, 177  
 Dale, J. K.: 24, 79, 83, 84, 123 (2)  
 Damansky, A. F.: 285, 286, 287 (35), 296,  
 303  
 Danilow, S.: 65  
 Davis, B. L.: 332, 334 (34c, 35), 338 (34b)  
 Degering, E. F.: 287, 288 (38), 290\* (38)  
 Delachanal: 15  
 Delaporte, B.: 196  
 Delbrück, K.: 110, 132, 137  
 Delory, G. E.: 233  
 Denigès, M. G.: 337  
 Derksen, J. C.: 265

- Deuel, H. J.: 189  
 Deutsch, W.: 226  
 Dibben, H. E.: 234  
 Dickson, A. D.: 335  
 Diehls, O.: 25  
 Dillon, R. T.: 166, 226  
 Distelmaier, A.: 62, 156  
 Dmochowski, A.: 197  
 Donhoffer, M.: 187  
 Donhoffer, S.: 187  
 Dore, W. H.: 284, 296  
 Dorfmueller, G.: 217  
 Doser, A.: 60  
 Dox, A. W.: 229  
 Dozois, K. P.: 178, 192  
 Dreher, E.: 296  
 Drew, H. D. K.: 7  
 Dreyfus, C.: 313, 316  
 Drummond, J. C.: 186  
 Dubos, R. J.: 227  
 Dubrovskaya, I. I.: 196  
 Dumpert, G.: 265, 266 (49), 270 (49)  
 Dunlap, R. I.: 271  
 Dunlop, H. G.: 51 (see Robertson), 53  
     (see Robertson), 56, 73 (58), 75 (58)  
 Dunn, E. R.: 177, 182  
 Dürr, W.: 81, 269, 297
- E**
- Edwards, F. C.: 265  
 Ehrenberg, J.: 213, 218 (80)  
 Ehrlich, F.: 70  
 Ehrmann, P.: 301  
 Eiler, J. J.: 228, 244 (124)  
 Eilers, H.: 293, 294, 296 (65)  
 Eisfeld, K.: 133, 134  
 Eissler, F.: 287  
 Eitel, E. H.: 182  
 Ekenstein, W. Alberda, van. *See* Alberda  
     van Ekenstein, W.  
 Elderfield, R. C.: 62, 64, 72 (72), 74 (72),  
     108, 148, 149, 153, 154, 155, 156, 159  
     (3), 164, 168\* (39)  
 Ellinghaus, J.: 221  
 Ellis, F.: 183, 185, 188, 189, 190  
 Elsner, H.: 20, 32, 330  
 Elssner, R.: 307  
 Embden, G.: 212, 213  
 Engels, H.: 81  
 Escalles, R.: 289
- Ettel, V.: 8 (38), 11, 12, 15, 32, 48, 49, 50  
 Euler, E.: 109, 111 (57)  
 Evans, E. F.: 14, 66  
 Evans, W. E.: 185, 186  
 Evans, W. L.: 87, 88, 97, 98, 121 (21, 46),  
     254  
 Eveking, W.: 302  
 Ewing, M. E.: 189
- F**
- Falconer, R.: 141, 223, 224 (107), 225 (107)  
 Farley, F. F.: 253, 254, 274  
 Farrow, F. D.: 253  
 Fauré: 130  
 Fay, I. W.: 4  
 Fehling, H.: 306  
 Fellenberg, T., von: 338  
 Felser, H.: 331  
 Felton, G. E.: 261, 274 (40)  
 Fernbach, A.: 252, 306  
 Feulgen, R.: 196, 221, 244, 245\* (166)  
 Field, C. W.: 181  
 Finkelstein, N.: 183, 188 (22)  
 Fischer, E.: 2, 3, 4, 5, 6, 7, 8, 9, 10, 11,  
     12, 13, 14, 15, 18, 19, 20, 21, 22, 24,  
     25, 26, 28, 29, 30, 31, 32, 33, 34, 38,  
     39, 41 (5), 58, 71, 75 (59), 78, 79, 80,  
     102, 110, 111\* (62), 113, 132, 133,  
     136, 137, 153, 162, 199  
 Fischer, F. G.: 228, 234, 245  
 Fischer, H.: 293  
 Fischer, H. O. L.: 65  
 Fletcher, H. H.: 254  
 Fletcher, W. E.: 230, 234, 235 (132a)  
 Fleury, F.: 171  
 Ford, C. E.: 261, 274 (40)  
 Fordyce, C. R.: 318, 319, 320, 321, 323,  
     324, 327  
 Forman, S. E.: 185, 186, 189  
 Foster, J. F.: 267  
 Fouard, E.: 306  
 Fox, T. G., Jr.: 267  
 Franchimont, A.: 286, 312  
 Frank, G.: 314  
 Frank, G. V.: 320  
 French, D.: 257, 260, 261 (32), 265, 270  
 Freudenberg, K.: 19, 59, 60, 62, 72 (73),  
     73 (61), 79, 81, 82, 89, 96, 111 (5), 112,  
     114 (5), 119, 121, 142, 155, 161, 265,  
     266, 269, 270, 291, 295, 296



Friedrich-Frekxa, H.: 235  
 Friese, H.: 282, 285, 292  
 Frush, Harriet L.: 24, 45, 70, 76 (25), 94,  
 95, 115, 121 (41), 124, 336

## G

Gadamer, J.: 130, 131  
 Gardner, T. S.: 291  
 Garot: 129  
 Gary, W. Y.: 335, 338 (72)  
 Gatin-Gruzewska, Z.: 251, 306  
 Gault, H.: 301, 302  
 Gautier, A.: 2  
 Gehman, H.: 87  
 Genin, G.: 302  
 Genung, L. B.: 290  
 Gerecs, S.: 52  
 Gessner, L.: 307  
 Gilbert, R.: 88  
 Gill, R.: 331  
 Gille, R.: 134  
 Gillespie, H. B.: 289, 292 (53)  
 Gillette, L. G.: 331, 334 (23)  
 Glickman, S. A.: 317  
 Gloor, W. E.: 323  
 Goebel, W. F.: 337, 339 (83a), 340  
 Goodyear, E. H.: 7  
 Goos, F.: 202  
 Gortner, R. A.: 333, 341  
 Gottlieb, D.: 300  
 Gottschalk, A.: 188  
 Graefe, G.: 94  
 Graf, L.: 89  
 Graff, S.: 198  
 Granischstädten, H.: 339  
 Green, J. W.: 138, 140  
 Greenstein, J. P.: 194, 245  
 Griffith, C. F.: 51 (see Robertson), 53  
 (see Robertson), 54, 56, 57, 58 (56),  
 62, 73 (56), 74 (56), 75 (56), 154  
 Gronemeier, G.: 139  
 Grüner, H.: 112  
 Gruzewska, Z.: see Gatin-Gruzewska  
 Guerin-Varry: 247  
 Gulland, J. M.: 141, 197, 199\* (26), 201,  
 202\* (40), 213, (40), 214 (26), 216,  
 217, 218 (91), 223, 224, 225, 226 (26),  
 229, 230, 232, 233, 234, 235, 239,  
 244 (128)  
 Günther, S.: 132

Guseva, V. I.: 317  
 Guttman, R.: 70

## H

Haar, A. W., van der: 331, 338 (14)  
 Hachtel, F.: 178  
 Hackel, J.: 305  
 Haerdtl, H.: 251, 270 (13), 305  
 Hagedorn, M.: 301, 319  
 Haldane: 179  
 Hall, N. F.: 313  
 Halliburton, W. D.: 186  
 Hammarsten, E.: 195, 244, 245  
 Hammarsten, O.: 198, 214  
 Hammett, L. P.: 115  
 Hanes, C. S.: 265, 271  
 Hann, R. M.: 6 (55), 8, 11, 13, 14, 17, 18,  
 21, 23, 24, 25, 26, 27, 29 (21), 34\* (40),  
 49, 50 (38), 52  
 Hanze, A. R.: 96, 140  
 Harder, A.: 81  
 Harder, M.: 291  
 Harder, W.: 132  
 Haring, K. M.: 133  
 Harris, I. F.: 196  
 Harris, M.: 317, 335  
 Harris, S. A.: 197, 211, 215, 216, 217  
 Hartley, Olive P.: 23, 27  
 Hartmann, M.: 168  
 Hartwig, S.: 235  
 Haskins, J. F.: 321  
 Haskins, W. T.: 52, 73  
 Hassid, W. Z.: 268, 269, 284, 296  
 Hawkins, E. G. E.: 284, 296  
 Haworth, W. N.: 7, 50, 60, 61, 62, 71,  
 72 (64), 73 (64), 75 (64, 65), 79, 80,  
 84, 88, 98, 100, 101, 102, 105, 107,  
 108, 109, 110, 111 (6), 112, 114\* (6),  
 154, 268, 282, 284\* (4), 287, 296, 340  
 Hearon, W. M.: 321  
 Heidelberger, M.: 172, 337, 339 (83a)  
 Helferich, B.: 44, 45, 87, 109, 110, 111,  
 133, 204  
 Helle, J.: 305  
 Henderson, S. T.: 331  
 Henglein, F. A.: 342  
 Henry: 129  
 Hermanns, L.: 164  
 Herrera, J. J.: 296  
 Hess, K.: 268, 283, 302, 303 (103), 321

- Hesse, G.: 172  
 Hettche, O.: 136  
 Heuer, W.: 255, 293  
 Heyl, F. W.: 208  
 Hiatt, E. P.: 186  
 Hiatt, G. D.: 319, 321  
 Hibbert, H.: 49, 50  
 Higginbotham, R. S.: 253, 282, 285 (7),  
 292 (7), 294  
 Hilbert, G. E.: 264, 282, 283, 285 (12), 297  
 Hirschbrunn, M.: 129, 154  
 Hirst, E. L.: 60, 61, 62, 72 (64), 73 (64),  
 75 (64), 79, 80 (3, 4), 84, 88, 98, 100  
 (see Haworth), 101, 102, 105, 107,  
 108, 109, 110 (see Haworth), 111 (6),  
 112, 114\* (6), 282, 283, 284\* (4, 11),  
 287, 296, 330, 331, 335 337 (73),  
 338 (73), 339 (73), 340 (12), 342\* (12,  
 73a), 343\* (73a)  
 Hixon, R. M.: 253, 254, 261, 267, 271, 273,  
 300  
 Hobday, G. I.: 216, 218 (91), 223, 224  
 (107), 225 (107)  
 Hochstetter, H., v.: 81  
 Hockett, R. C.: 21, 23, 43, 72 (17), 204, 315  
 Hoefft, F.: 306  
 Hoepfner, E.: 235  
 Hoffman, W. F.: 333  
 Hoffmann, A.: 157, 164, 167 (16), 173  
 Hoffmann-La Roche, F., and Co. Akt.-  
 Ges.: 70  
 Hofmann, A. W.: 131  
 Hofmann, R.: 313  
 Hohenemser, H.: 282, 284 (5), 294 (5),  
 295 (5), 297 (5)  
 Höhn, F.: 312  
 Holberger, J. H.: 307  
 Holiday, E. R.: 199, 201, 202 (40), 213 (40)  
 Holmes, F. B.: 304  
 Hopf, H.: 297  
 Hoppe-Seyler, F.: 194  
 Houghton, A. A.: 303  
 Hudson, C. S.: 6 (55), 8, 10, 11, 12, 13, 14,  
 17, 18, 19, 20 (56c), 21, 23, 24, 25, 26,  
 27, 28, 29 (21), 32 (77c), 34\* (40),  
 37, 40, 42, 43, 44, 45, 46\* (20), 47,  
 48, 49, 50\* (38), 51, 52, 53\* (48), 54,  
 56\* (47, 51), 67, 71, 72 (11, 16, 17,  
 18, 45, 46, 51), 73\* (20, 51), 74 (51),  
 75 (51), 76 (10, 11, 16, 19, 20), 92,  
 95, 100 (37), 102, 112, 118 (37), 120  
 (37), 135, 139, 155, 160, 163, 186,  
 204, 254, 257, 261, 270\* (33)  
 Hughes, G.: 283, 284 (10), 287 (10)  
 Hüllweck, G.: 132  
 Humoller, F. L.: 10, 38, 42, 43, 64 (13),  
 72 (13), 73\* (13)  
 Husemann, E.: 284, 295, 304
- I
- Iddles, H. A.: 251, 255  
 I. G. Farbenindustrie: 289, 301, 313, 319  
 Imglingerd, P.: 293  
 Isbell, H. S.: 7, 11, 24, 26, 27, 45, 54, 70,  
 71, 73, 76\* (25), 83, 85, 92, 93, 94\*  
 (13), 95, 100, (18), 108, 111, 112, 115,  
 118 (17), 121 (13, 18, 41), 122 (13),  
 123 (13), 124, 153, 336  
 Ishikawa, H.: 197  
 Itallie, Th. B., van: 265  
 Ivers, O.: 81, 82, 96, 112, 119, 121  
 Iwanoff, L.: 226
- J
- Jachimowicz, T.: 213  
 Jackson, E. L.: 23, 51, 54  
 Jackson, E. M.: 223, 224 (107), 225 (107),  
 232, 233  
 Jacobs, W. A.: 10, 37, 38, 39, 41 (1), 67,  
 72 (1), 157, 163, 164, 167 (16), 168,  
 172, 173, 197, 198, 199\* (28), 207  
 (28), 210\* (32, 34), 214\* (24, 27, 32,  
 34), 221, 223, 226, 237 (100), 241  
 Jaffe, M.: 181  
 Jeanes, Allene: 283, 285 (12), 291  
 Jenrette, W. V.: 245  
 Jensen, C. C.: 254, 274 (29)  
 Jochmann, I.: 245  
 Johnson, J. W.: 182  
 Johnson, T. B.: 133, 208  
 Johnston, C.: 189  
 Jones, D. I.: 50  
 Jones, J. K. N.: 284, 296, 331, 335, 336,  
 337 (73), 338 (73), 339 (73), 341 (79),  
 342\* (73a, 79), 343\* (73a, b)  
 Jones, W.: 195, 214, 221, 226  
 Jordan, D. O.: 230, 234, 235 (132a)  
 Jorpes, E.: 195, 214, 218 (87), 234  
 Josephson, K.: 111, 112  
 Jung, H.: 239

## K

- Kalinowsky, J.: 306  
 Kapp, E. M.: 331  
 Karrer, P.: 132, 301  
 Karrer, W.: 167  
 Kaster, R. B.: 333  
 Katz, J. R.: 265, 273  
 Kauffmann, E.: 187  
 Kennedy, R. P.: 214  
 Kerb, J.: 306  
 Kern, W.: 296  
 Kerr, R. W.: 248, 262, 263, 268, 269 (43, 55), 270, 272, 282, 284, 288 (25)  
 Kerstjens, A. N.: 284, 287 (27), 288 (27)  
 Kessler, H.: 303  
 Kesselman, J.: 343  
 Kiliani, H.: 3, 4, 150, 155, 156, 158, 159, 160, 161  
 King, E. J.: 233  
 Kitabatake, T.: 315  
 Kitschen, H.: 284  
 Klaas, R.: 335  
 Kldiaschwili, A. G.: 300, 301\* (89)  
 Klein, F.: 320  
 Klein, G.: 330  
 Klein, W.: 109, 111, 229, 233, 238, 241\* (135)  
 Klemperer, F.: 197, 226 (25), 233 (25)  
 Klimek, R.: 213  
 Kline, G.: 324  
 Klingensmith, C. W.: 87, 88, 121 (21)  
 Knauf, A. E.: 6 (55), 8 (55), 18, 52  
 Knoevenagel, E.: 289  
 Knop, L.: 295  
 Knopf, M.: 214  
 Knorr, E.: 79, 94, 95  
 Kobayashi, Y.: 214, 218 (87), 232  
 Koenig, M.: 306  
 Koethnig, M.: 223, 232 (110), 242, 244 (110)  
 Kohn, H.: 19, 162  
 Komita, Y.: 197  
 Königs, W.: 79, 94, 95  
 Körner, W.: 130  
 Kossel, A.: 195, 237  
 Kraemer, E. O.: 294  
 Krafft, F.: 163  
 Krajne, B.: 268  
 Krantz, J. C., Jr.: 177, 178, 182, 183, 184 (18), 186, 187 (38), 188, 189, 190, 191\* (34), 192  
 Krauz, C.: 31  
 Kreider, L. C.: 87, 88, 341  
 Krüger, D.: 311, 312  
 Krznarich, P. W.: 332  
 Kuhn, W.: 269, 297  
 Külz: 179  
 Kuna, M.: 336  
 Kunitz, M.: 227, 234  
 Kunz, A.: 40, 42, 43, 72 (11), 76 (10, 11), 95, 305  
 Kunze, W. C.: 304  
 Kurth, E. F.: 333, 343

## L

- Labbé, M.: 188  
 LaForge, F. B.: 11, 12, 13 (35, 37), 25, 47, 48, 49, 50, 72, 73 (37), 207, 208\* (60), 226, 240 (60)  
 Lake, W. H. G.: 61, 62, 75 (65, 70a, b)  
 Lamb, I. D.: 150, 155 (5), 156 (5), 159 (5), 164 (5)  
 Lang, Lina: 132  
 Lanzenberg, A.: 16  
 Larson, H. W.: 189  
 Laser, R.: 226  
 Laubenheimer, A.: 129  
 Laurent, A.: 191  
 Law, D.: 288  
 Lawrence, R. D.: 188  
 LeB. Gray, H.: 313  
 Lefèvre, K. U.: 335  
 Lehmann, G.: 223, 232 (110), 244 (110)  
 Lehmann-Echternacht, H.: 228, 234 (123c), 245  
 Lehrman, L.: 256  
 Leibowitz, J.: 305  
 Lenhard, W.: 302  
 Lenze, F.: 304  
 Leonhardt, H.: 135, 136 (28)  
 Lespieau, R.: 36  
 Leuchs, H.: 30  
 Levene, P. A.: 10, 21, 25, 30, 37, 38, 39, 40, 41\* (1), 50, 58, 61, 67, 72\* (1, 60), 73\* (8a, b, 60), 75 (60), 84, 85, 86, 118 (16), 121 (16), 141, 155, 163, 166, 195, 196, 197, 198, 199\* (28), 208\* (60), 209, 210\* (32, 34), 211, 212\* (51), 213, 214\* (24, 27, 32, 34), 215, 216\* (21), 217, 218\* (87), 221, 222\* (98), 223, 224, 226, 227, 229, 230, 236,

- 237\* (100), 238, 239, 240\* (60), 241\* (105, 118, 130), 242, 243, 244, 245, 331, 336, 337 (22), 341
- Levy, H.: 289
- Lew, B. W.: 341
- Lewis, H. B.: 177, 182
- Lichtenstein, R.: 109, 111 (57)
- Liebig, J.: 210
- Ling, A. R.: 252
- Link, K. P.: 282, 332, 335, 336, 337 (78a), 338, 339\* (78a, 89), 341, 342 (77)
- Lintner, C. J.: 249
- Littmann, O.: 302
- Ljubitsch, N.: 321
- Lobry de Bruyn, C. A.: 64
- Lohmann, H.: 317
- Lohmann, W.: 131
- London, E. S.: 238, 242 (151)
- Lorand, E.: 289, 301, 302 (99)
- Loring, H. S.: 227, 228, 232, 234, 236
- Lubavin, N.: 194
- Luckett, S.: 336, 341
- Ludewig, H.: 284
- Lüdtke, M.: 331
- M**
- Macbeth, A.: 283, 284 (10), 287 (10)
- Mack, D. E.: 301
- Maclay, W. D.: 6 (55), 8, 13, 18, 26, 29 (21), 34\* (40), 336
- MacPhillamy, H. B.: 108, 153, 155, 156
- Macrae, T. F.: 197, 199 (26), 201, 214 (26), 226 (26)
- Maculla, A.: 198
- Mahdi hassan, S.: 196
- Mahoney, J. E.: 315
- Makino, K.: 229, 244 (127)
- Mallatt, R. C.: 290
- Malm, C. J.: 312, 318, 319, 320, 326
- Maltby, J. G.: 26
- Mandel, J. A.: 237
- Mannich, C.: 159
- Manville, I.: 336
- Mark, H.: 297, 316
- Markownikoff, W.: 3
- Marteny, W. W.: 332
- Martin, A. R.: 335
- Martin, H.: 313
- Maquenne, L.: 251, 268
- Mathers, D. C.: 51 (see Robertson), 53 (see Robertson), 54, 73 (53), 74 (53), 75 (53)
- Mauss, W.: 159
- Mayer, A.: 251, 270 (13), 305, 306\* (127)
- Mayer, W.: 62, 156
- McCance, R. A.: 188
- McCready, R. M.: 268, 269
- McManus, W. F.: 38, 73
- Medigreceanu, F.: 226
- Meisenheimer, J.: 239
- Merrill, Alice T.: 8, 11, 21, 26, 27, 29 (21)
- Meunier, J.: 15
- Meyer, A.: 248
- Meyer, G. M.: 30, 40, 41, 58, 61, 72 (60), 73 (8a, b, 60), 75 (60), 336
- Meyer, K. H.: 187, 251, 261, 262, 264, 268, 269, 282, 284 (5), 293, 294, 295, 297
- Meyer, L. W.: 327
- Meyer, R.: 25
- Meyersohn, P.: 287
- Michael, A.: 289
- Micheel, F.: 52, 63, 161, 163, 166
- Middleton, E. B.: 290
- Miescher, F.: 193, 242, 244
- Mikeska, L. A.: 239
- Millar, J. H.: 305
- Miller, E. J.: 79, 80 (3), 105, 107, 114, 154
- Millett, M. A.: 333
- Mindlin, S. S.: 317
- Mitchell, R. L.: 333
- Moelwyn-Hughes, E. A.: 99
- Mohs, P.: 159
- Moller, P.: 319
- Montgomery, Edna M.: 12, 25, 26, 27, 32 (77c)
- Morell, S.: 336, 341, 342 (77)
- Mori, T.: 141, 211, 238
- Morrell, R. S.: 7
- Mottern, H. H.: 70, 336
- Mueller, G.: 244
- Mueller, T.: 27
- Mullan, J.: 331, 334 (24), 336 (24)
- Mullen, J. W.: 282, 283, 285, 294, 300, 301 (36)
- Müller, A.: 109, 110, 133, 144
- Muller, R.: 314
- Murray, H. A.: 333
- Musser, R.: 182, 184 (18)
- Myers, J.: 183, 188

- Myers, W. H.: 61, 62, 74 (66, 67, 71), 75  
(66, 67, 71)
- Myrbäck, K.: 234
- N**
- Naegeli: 247
- Nakashima T.: 321
- Nanji, D. R.: 252
- Neave, G. W.: 169
- Nedden, R.: 336
- Nef, J. U.: 7
- Nelson, J. M.: 249, 272 (8), 306
- Nelson, W. A. G.: 331, 336 (25)
- Nelson, W. L.: 339
- Neumann, A.: 236, 237, 244
- Neumann, W.: 168, 171, 172
- Newsome, P. T.: 319
- Niemann, C. G.: 282, 338, 339\* (89)
- Nobel, A.: 305
- Noorden, K. H., von: 188
- Nordal, C.: 47
- Norman, A. G.: 330, 332\* (9), 334 (9),  
335 (9), 339 (9), 340 (9), 343
- Norris, F. W.: 331, 332, 334\* (18), 335,  
342, 343 (38)
- Northrop, J. H.: 306
- Noth, H.: 110, 111\* (62)
- Nutter, P.: 332, 337 (46)
- O**
- Odake, S.: 141
- O'Dwyer, M. H.: 332, 333, 335, 338, 343  
(54)
- Ohl, F.: 317
- Ohle, H.: 109, 110, 111\* (57), 112
- Oldham, J. W. H.: 109, 155, 205
- Ollendorf, G.: 199
- Olsen, F.: 311
- Onslow, M. W.: 330
- Osborne, T. B.: 196
- Ost, H.: 307, 320
- Ostmann, P.: 133
- Otis, Louise: 335, 338\* (69), 339 (69), 343  
(69)
- Ottenstein, B.: 237, 241 (150)
- Otterson, H.: 335
- P**
- Pacsu, E.: 45, 82, 86, 89, 90, 91, 93, 99,  
100, 102, 112 (12), 114, 121 (29, 30,  
34, 39), 122 (12), 124 (29), 138, 139,
- 140, 252, 282, 283, 285, 294, 300, 301  
(36)
- Page, J. H.: 176, 177
- Panizzon, L.: 62
- Parnas, J. K.: 213
- Passmore, F.: 4, 5, 7, 8 (13), 18
- Pasternack, R.: 70
- Payne, W. W.: 188
- Peat, S.: 54, 61, 62, 73 (69b), 74 (69b),  
75 (65, 69b, 70a, b), 284, 330, 340  
(10), 342\* (10), 343 (10)
- Pedersen, K. O.: 244
- Peirce, G.: 6, 8\* (23), 9, 11, 12, 15, 18,  
29, 48
- Peiser, E.: 282, 284 (3), 287
- Percival, E. E.: 331
- Percival, E. G. V.: 331, 334\* (24), 336\*  
(25), 339
- Perkins, M. E.: 195, 221
- Pfannenstiel, A.: 49
- Pfützing: 24
- Pfieger, R.: 283, 302, 303 (103)
- Pfuger: 178
- Phelps F. P.: 10, 38
- Phillippe, L.-H.: 8, 17, 36
- Phillips, M.: 332, 336 (34a), 338 (34b)
- Piccard, J.: 237
- Pickels, E. G.: 244
- Pigman, W. W.: 26, 27, 44, 45, 70, 76, 85,  
92, 93, 100 (18), 111, 112, 121 (18),  
138, 153, 336
- Piloty, O.: 7, 10, 28, 29, 199
- Pirie, N. W.: 236
- Plant, M. M. T.: 284, 296
- Ploetz, T.: 265, 266 (49), 270 (49)
- Plosz, P.: 194
- Posternak, T.: 38, 306
- Preece, I. A.: 332, 334\* (37, 42)
- Pregl, F.: 284, 287
- Pringsheim, H.: 248, 287, 305
- Proner, M.: 47
- Proust: 181
- Pryde, J.: 7
- Puntenney, I.: 189
- Purdie, T.: 169
- Purves, C. B.: 23, 264, 291, 315
- R**
- Rabe, A.: 78, 79, 80, 113, 153
- Radais, R.: 188

- Radley, J. A.: 248, 274  
 Raistrick, H.: 71  
 Rapp, W.: 296  
 Rappaport, F.: 169  
 Raschig, K.: 19, 62, 72 (73), 155, 161  
 Rath, M. M.: 185  
 Raybaud, A.: 187  
 Raymond, A. L.: 30, 141, 166, 205  
 Read, B. E.: 221  
 Redd, J. C.: 333, 334 (47a), 338 (47a),  
 344 (47a)  
 Rees, G. E.: 305  
 Regna, P. P.: 10, 70, 71, 73 (87), 336  
 Reich, W. S.: 285, 286, 287 (35), 296, 303  
 Reichert, E. T.: 248  
 Reichstein, T.: 27, 36, 38, 64, 65, 66, 67,  
 68, 69, 71, 72 (7, 96), 168, 169, 170,  
 171 (43)  
 Reifer, J.: 169  
 Reinbrecht, O.: 5, 24 (12)  
 Reiner, M.: 188  
 Reinhart, F.: 324  
 Reinwein, H.: 187  
 Reis, J.: 232  
 Reithel, F.: 336  
 Remick, A. E.: 103, 104  
 Renfrew, Alice G.: 331, 339 (19)  
 Resch, C. E.: 335  
 Reynolds, D. D.: 87, 97, 98, 121 (46)  
 Rich, F. V.: 82  
 Richards, L.: 332  
 Richardson, W. A.: 253, 274, 285 (7),  
 292 (7), 294  
 Richter, F.: 223, 232 (110), 244 (110)  
 Richter, G.: 197, 223, 226 (25), 232, 233  
 (25)  
 Richter, G. A.: 311  
 Richtmyer, N. K.: 10, 13, 14, 17, 21, 26,  
 27, 43, 44, 46\* (20), 49, 50 (38), 51,  
 52\* (48), 56\* (47, 51), 67, 72 (16,  
 17, 18, 45, 46, 51), 73 (20, 51), 74  
 (51), 75 (51), 76 (16, 20), 92, 95,  
 100 (37), 112, 118 (37), 120 (37),  
 135, 186, 191 (34)  
 Rietz, E.: 336  
 Ritchie, G. C.: 284  
 Ritter, G. J.: 333, 343  
 Roberts, R. H.: 282  
 Robertson, G. J.: 51, 53, 54, 56, 57, 61,  
 62, 72 (57), 73 (53, 56, 58), 74 (53, 56,  
 57, 66, 67, 71), 75 (53, 56, 57, 58, 66,  
 67, 71), 154, 155  
 Robiquet, P. J.: 129, 130  
 Rocha, H. J.: 317  
 Roche, A.: 187  
 Roe, J. H.: 17, 186  
 Röhm, R.: 303  
 Roll, P. M.: 227  
 Rosenthal, L.: 302  
 Rosenthaler, L.: 330, 333  
 Rossenbeck, H.: 196  
 Rossi, A.: 229  
 Roukheldman, N.: 196  
 Roux, E.: 269  
 Rudy, H.: 301  
 Ruell, D. A.: 7  
 Ruff, O.: 19, 162, 199  
 Rundle, R. E.: 257, 260, 261, 265, 266, 270  
 Ruppertsberger, M.: 186  
 Russell, F. H.: 335, 336 (74)  
 Rutherford, J. K.: 205
- S
- Sadler, S. S.: 305  
 Sakurada, I.: 315, 321  
 Salo, M.: 323  
 Samec, M.: 251, 270, 295, 305, 306\* (127)  
 Samuels, H.: 79, 80 (4), 98, 100 (see  
 Haworth), 101, 102, 105, 110 (see  
 Haworth)  
 Sands, Lila: 332, 335, 337 (46), 338 (72)  
 Sattler, L.: 66  
 Sawyer, H. L.: 24  
 Sawyer, S. D.: 189  
 Scattergood, A.: 114  
 Schaaf, E.: 265, 266 (49), 270 (49)  
 Schantarowitsch, P.: 65  
 Schardinger: 269  
 Scheibe, G.: 235  
 Schenck, M.: 314  
 Schieltz, N. C.: 266, 299  
 Schink, N. F.: 257, 258 (34), 260 (34),  
 261 (34), 262 (34), 275 (34)  
 Schinle, R.: 112, 137, 143, 155, 284, 285  
 (33), 296  
 Schlitter, E.: 168  
 Schlubach, H. H.: 88, 90, 91, 94, 202  
 Schmidt, G.: 213, 227, 233, 244  
 Schmidt, J. S.: 182, 184 (18)  
 Schmidt, O. T.: 62, 151, 155, 156

- Schmiedeberg, O.: 171  
 Schneider, G. G.: 342  
 Schneider, W.: 130, 131, 132, 133, 134,  
 135, 136\* (28), 137, 138, 140, 144, 145  
 Schoch, T. J.: 254, 256, 257, 258\* (34), 260  
 (34), 261, (34), 262 (34), 267 (37),  
 270 (33, 37), 272 (30, 34a), 274 (29),  
 275 (34), 280, 282, 297  
 Schoeffel, E.: 336, 337 (78a), 338, 339\*  
 (78a, 89)  
 Scholtz, H.: 79, 82, 89, 114 (5)  
 Schopmeyer, H. H.: 261, 274 (40)  
 Schoppee, C. W.: 168, 169, 170, 171 (43)  
 Schorger, A. W.: 330  
 Schotte, H.: 58, 75 (59)  
 Schröter, G. A.: 90, 91, 202  
 Schryver, S. B.: 252  
 Schubert M. P.: 134  
 Schubert, S.: 306  
 Schultz, J.: 194, 196  
 Schulz, A.: 139  
 Schulz, G. V.: 293  
 Schulze, E.: 198  
 Schule, F.: 320  
 Schütz, L. A.: 131  
 Schützenberger, P.: 289  
 Schwarte, G.: 160, 161  
 Schwarzenberg: 336  
 Seeley, M.: 331, 333, 334 (23, 47a), 338  
 (47a), 344 (47a)  
 Seigle, L. W.: 332, 335, 336  
 Sepp, Johanna: 136, 137  
 Severson, G. M.: 263, 269 (43), 284, 288  
 (25)  
 Shapiro, J.: 177  
 Sheppard, S. E.: 319  
 Sherman, H. C.: 305  
 Shimada, T.: 310  
 Shirkhande, J. G.: 332  
 Shreve, R. N.: 301  
 Signer, R.: 244  
 Silbermann, A. K.: 182  
 Sillmann, S. H.: 305  
 Silver, S.: 188  
 Simms, H. S.: 211, 221, 222 (98), 230, 242  
 Simon, A.: 155  
 Simpson, M.: 2  
 Sindl, O.: 314  
 Skraup, Z.: 287  
 Slyke, D. D., van: 223  
 Smith, F.: 336, 339, 341  
 Smith, F. A.: 282, 285, 292  
 Smith, H. W.: 183, 188 (22)  
 Smith, S.: 150, 155 (5), 156 (5), 159\* (5),  
 164 (5)  
 Smith, W.: 305  
 Smith, W. S.: 8  
 Smith, W. W.: 183, 188  
 Snelling, W. O.: 305  
 Sobotka, H.: 84, 141  
 Sollmann, T. R.: 181  
 Sookne, A. M.: 317  
 Speedie, T. H.: 155  
 Spengler, O.: 49  
 Sprague, G. F.: 261, 271  
 Spurlin, H. M.: 315, 317  
 Stacey, M.: 71, 88  
 Stadler, P.: 88  
 Staedeler: 3  
 Stahel, R.: 4  
 Stanley, W. M.: 235  
 Staudinger, H.: 255, 284, 293, 294, 295,  
 296\* (65), 304  
 Stearn, A. E.: 221, 222 (99)  
 Steibelt, W.: 132  
 Steiger, Marguerite: 36, 38, 64, 65, 66, 67,  
 71, 72 (7, 96)  
 Stein, G.: 159  
 Steinbaum, G.: 297  
 Steinbrunn, G.: 269  
 Stern, K.: 307  
 Steudel, H.: 214, 237  
 Stewart, W. T.: 333, 334 (47a), 338 (47a),  
 344 (47a)  
 Stiehler, Ottilie: 137  
 Stiller, E. T.: 204, 211  
 Stoll, A.: 148  
 Story, L. F.: 202, 239  
 Strain, W. H.: 148  
 Sutra, R.: 284, 289  
 Suzuki, U.: 141  
 Svedberg, T.: 244  
 Syniewski, W.: 283, 288 (14)
- T
- Takahashi, H.: 228, 232  
 Takahashi, K.: 182  
 Talley, E. A.: 97, 98, 121 (46)  
 Tamba, R.: 306  
 Tanner, H. A.: 318

Tanret, C.: 155, 252  
 Taube, C.: 65  
 Taylor, T. C.: 249, 251, 253, 254, 255, 272  
 Teece, E. G.: 109, 112  
 Tennent, H. G.: 244  
 Tetlow, W. E.: 61, 74 (67), 75 (67)  
 Thannhauser, S. J.: 187, 214, 217, 233,  
 237, 241\* (150)  
 Thomas, A.: 229  
 Thomas, A. W.: 333  
 Thomas, B. B.: 333  
 Thomas, E. M.: 252  
 Thompson, A.: 137, 140, 143  
 Thompson, J. W.: 177  
 Thompson, R. H. S.: 227  
 Tilden, Evelyn B.: 13, 17, 270  
 Tipson, R. S.: 86, 163, 199, 203, 205, 206,  
 207, 208, 209, 210, 212, 213, 218, 222,  
 229, 240, 243, 331, 337 (22)  
 Tocco, G.: 310  
 Todd, W. R.: 183, 188  
 Tokuzo, N.: 289  
 Tollens, B.: 20, 32, 155, 330, 331, 335  
 Traquair, J.: 289, 292 (52), 300 (50)  
 Trogus, C.: 283  
 Trubell, O. R.: 284, 288 (25)  
 Tryller, H.: 306  
 Tschesche, R.: 148, 168, 171, 172  
 Tunmann, O.: 330  
 Tszuzuki, Y.: 289, 295 (45), 296 (45)

## U

Ueda, Y.: 310  
 Urban: 336  
 Urbanski, T.: 305

## V

Valatin, T.: 52  
 Valentin, F.: 156  
 Van Beckum, W. G.: 333  
 Vargha, L., v.: 112  
 Venus-Danilowa, E.: 65  
 Victorow, C.: 306  
 Vignon, L.: 184  
 Vilbrandt, C. F.: 244  
 Vincent, C.: 15  
 Voegtlin, G.: 177, 182  
 Votoček, E.: 31, 155, 161, 162

## W

Wagner, P.: 131  
 Waine, A. C.: 284  
 Waisbrot, S. W.: 140  
 Walton, R. P.: 248  
 Waring, C. E.: 320  
 Waters, E. T.: 188  
 Webb, J. I.: 282, 284 (4), 287  
 Weber, I.: 226  
 Weihe, H. D.: 332, 334 (34c), 337 (34a)  
 Weinmann, H.: 169  
 Weisblat, D. I.: 96, 121, 140  
 Wendt, G.: 141  
 Wernicke: 24  
 West, E. S.: 183, 188  
 Westerbeke, D.: 333, 334 (47a), 338 (47a),  
 344 (47a)  
 Westgarth, G. C.: 7  
 Westhoff, F.: 307  
 Westphal, K.: 159, 171  
 Whinfield, J. R.: 284  
 Whistler, R. L.: 264, 266, 282, 283, 285  
 (12), 291, 297, 299, 335  
 Whitehead, W.: 51 (see Robertson), 53  
 (see Robertson), 56, 72 (57), 74 (57),  
 75 (57), 154  
 Wiegand, E. J.: 189  
 Wiegel, E.: 258, 263  
 Wiemann, J.: 36  
 Wiesner, J., von: 330  
 Wiggins, L. F.: 62, 73 (69b), 74 (69b),  
 75 (69b)  
 Wilhelms, Adrienne: 133, 144  
 Wilkinson, M. D.: 284, 296  
 Will H.: 129, 130,  
 Will, W.: 304  
 Williams, C. B.: 257, 258 (34), 260 (34),  
 261 (34), 262 (34), 272 (34a), 275 (34)  
 Williamson, S.: 155  
 Wilson, E. J., Jr.: 89, 121 (30), 139, 254,  
 257, 270 (33)  
 Winekler, F. W.: 2  
 Windhaus, A.: 159, 160, 161, 164, 171  
 Winkler, S.: 87  
 Winstein, S.: 115  
 Winzor F.: 283, 284 (10), 287 (10)  
 Wirbatz W.: 314  
 Wohl, A.: 198, 311, 320  
 Wolf, A.: 142



- Wolf, I.: 88  
Wolf, J.: 47  
Wolff, E.: 293  
Wolff, J.: 252  
Wolff and Co.: 313  
Wolfrom, M. L.: 12, 13, 14, 27, 66, 84, 85,  
96, 118 (16), 121, 123 (16), 137, 140,  
143  
Wollenweber, H.: 186  
Woolgar, M. D.: 284, 296  
Wrede, F.: 130, 131, 133, 134, 136, 141,  
144, 145  
Wright, F. E., 72
- Y**
- Yamada, P.: 336  
Yamagawa, M.: 226  
Yanovsky, E.: 102, 155  
Young, F. C., Jr.: 62, 72 (72), 74 (72),  
153, 154, 155, 156  
Young, G. T.: 283, 284\* (11), 296
- Z**
- Zach, K.: 19  
Zeiser, H.: 151, 156  
Zega, Z.: 301  
Zeldovich, P. I.: 317  
Zemplén, G.: 52, 89  
Zerban, F. W.: 66, 332, 338 (15)  
Zervas, L.: 93, 186  
Zimmermann, M.: 212  
Zimmermann, W.: 136, 145  
Zulkowski, K.: 249, 283, 287

## SUBJECT INDEX

### A

- Acetic acid, cellulose ester. *See* Cellulose acetate.  
 as solvent for sugars, 24  
 starch ester. *See* Starch acetate.
- Acetic acid, chloro-, anhydride, effect on esterification of cellulose, 319  
 starch ester, 301
- , dichloro-, starch ester, 301
- , trichloro-, starch ester, 301
- Acetobacter suboxydans, 17
- Acetolysis, of starch, 287
- Acetone, reaction with inosine, 206  
 reaction with uridine, 210
- Acetylation, of cellulose, 311  
 of starch, 284-290
- Acetyl bromide, in acetylation of starch, 288
- Acetyl chloride, in acetylation of starch, 288
- Acetyl value, determination of, for starch acetates, 290
- Acids, hydroxy, synthesis of, 2
- Acylation, of polyuronides, 334
- Acyl migration, 109, 113
- Adenine, from desoxyribonucleic acid, 237  
 from nucleic acids, 195  
 phosphodesoxyribosynucleotide, 241  
 from ribonucleic acid, 198, 200
- Adenine, desoxyribosyl-, 240
- , 9'-(3-phospho-D-ribofuranosyl)-. *See* Adenylic acid (from ribonucleic acid).
- , 9'-(5-phospho-D-ribofuranosyl)-. *See* Adenylic acid, muscle.
- , 9'-(5-tritylribofuranosyl)-6'-N-trityl-, 205
- Adenine glycoside, 141
- Adenosine, from ribonucleic acid, 198, 200  
 spectrum and structure of, 202, 204
- Adenosine, 2,3-diacetyl-, 205, 206
- , diacetylditryl-, 205, 206
- , N,5-diphospho-2,3-isopropylidene-, 213
- , ditosyldiacetyl-, 206
- , ditryl-, 205, 206
- , isopropylidene-, 207
- , 3-phospho-, 217
- , 5-phospho-. *See* Adenylic acid, muscle.
- , trimethyl-N-methyl-, 203, 204
- , tritosyl-, 205, 206
- , 5-trityl-, 205, 206
- Adenylic acid, 196  
 boric acid complex of muscle, 213  
 muscle, 212, 213  
 from ribonucleic acid, 214, 217
- Adhesives, dextrin, 274  
 starch xanthates as, 307
- Adonitol, 10, 180
- Adsorption, of iodine by starch, 256  
 molecular configuration and, 277  
 by starch, 252, 255
- Adynerin, 148, 171
- Aircraft fabrics, cellulose ester coatings for, 324
- Alcohols, configuration of sugar, 1-36  
 effect on aqueous leaching of starch, 263  
 identification of higher-C sugar, 34  
 metabolism of sugar, 175-192  
 starch precipitation by, 258, 263  
 from sugars by reduction with Raney Ni, 24
- Aldehyde content, of starch, 276
- Aldehyde group, in starch molecule, 253
- Aldonic lactones, from aldonic phenylhydrazides, 22
- Aldose alkyl orthoesters, 113, 121
- Aldose orthoacyl halide, 118
- Aldoses, degradation of, 254
- Alginate acid, hydrolysis of, 336  
 structure of, 342
- Alkali lability, of starch, 253, 267
- Alkali number, of starch, 254
- Allitol, 36, 64, 65, 181
- L-Alloascorbic acid, 64, 65
- D-Alloheptulose, 48

- D-Allomethylose, 2-desoxy-. *See* Digitoxose.
- Allomucic acid, 37, 39
- D-Allonic acid, 38, 39
- D-Allono- $\gamma$ -lactone, 38
- Allonucleic acid, 196
- D-Allose, 10, 37, 39, 65  
phenylosazone, 72
- D-Allose, 2,6-didesoxy-. *See* Digitoxose.
- , 3-methyl-2,6-didesoxy-. *See* Cymarose.
- D,L-Allose, phenylosazone, 72
- L-Allose, 42  
phenylosazone, 72
- $\alpha$ -D-Alloside, methyl 2,3-anhydro-4,6-benzylidene-, 55, 57
- L-Allosone, 64
- D-Allulofuranose, 1,2,3,4-diisopropylidene-, 65
- L-Allulofuranose, 1,2,3,4-diisopropylidene-, 64, 65
- D-Allulose, 65, 66
- L-Allulose, 64, 65
- keto*-D-Allulose, pentaacetyl-, 66
- , tetraacetyl-1-desoxy-, 66
- , tetraacetyl-1-diazo-1-desoxy-, 66
- D-Altrofuranose, 1,2,5,6(?)-diisopropylidene-, 72
- D-Altro-D-*gluco*-heptitol. *See*  $\beta$ -Sedoheptitol.
- D-Altro-D-*manno*-heptitol. *See* Volemitol.
- D-Altro-D-*fructo*-heptose. *See* Sedoheptulose.
- D-Altroheptulose. *See* Sedoheptulose.
- D-Altromethylose, specific rotation of, 155
- , 2-desoxy-. *See* Digitoxose.
- , 2-methyl-, 62, 63, 64, 153, 154  
specific rotation of, 155
- L-Altromethylose, 62  
and phenylosazone, 161, 162
- D-Altronic acid, 38, 39, 73  
brucine salt, 73  
and calcium salt, 67, 68, 70, 73  
sodium salt, 73
- D-Altronic acid, 5-keto-, 69
- L-Altronic acid, 73  
brucine salt, 73  
calcium salt, 73
- D-Altronic 1,5-lactone, 3,4,6-trimethyl-, 73
- D-Altronic phenylhydrazide, 73
- L-Altronic phenylhydrazide, 73
- D-Altronolactone, 73
- L-Altronolactone, 73
- D-Altrosan, 44, 45, 50, 52, 56  
—, 2,3,4-triacetyl-, 53
- D-Altrose, 2, 10, 38, 39, 45, 56  
benzylphenylhydrazone, 72  
dibenzyl mercaptal, 72  
and dibenzyl mercaptal, 43  
from methyl  $\alpha$ -D-glucoside, 54  
oxime, 72
- D-Altrose, 3-amino-, 60  
phenylosazone, 73
- , 1,6-anhydro-, 72
- , 1,6(?)-anhydro-3-amino-, hydrochloride, 72
- , 1,6-anhydro-2,3,4-triacetyl-, 72
- , 6-desoxy-2-methyl-, 62, 63, 64, 72
- , 2,6-didesoxy-. *See* Digitoxose.
- , 3-methyl-, phenylosazone, 73
- , 2-methyl-3,6-anhydro-, 72
- , 2,3,4,6-tetramethyl-, 73
- , 2,4,6-trimethyl-, 73
- , 3,4,6-trimethyl-, 73
- $\alpha$ -D-Altrose, 1-chloro-2,3,4,6-tetraacetyl-, 53, 72
- , 4,6-dimethyl-, and phenylosazone, 73
- , pentaacetyl-, 53
- , 1,2,3,4,6-pentaacetyl-, 72
- $\beta$ -D-Altrose, 72
- , pentaacetyl-, 53
- , tetraacetyl-, 53
- , 2,3,4,6-tetraacetyl-, 73
- L-Altrose, 42  
benzylphenylhydrazone, 72  
dibenzyl mercaptal, 43, 72
- L-Altrose, 6-desoxy-, 62, 72  
*p*-bromophenylhydrazone, 72, 75  
phenylhydrazone, 72  
phenylosazone, 72
- $\beta$ -L-Altrose, 72
- Altrose group of substances, 37-76
- D-Altroside, methyl isopropylideneanhydro-, 71
- $\alpha$ -D-Altroside, methyl, 54, 56, 74
- , methyl 2-acetamino-3-acetyl-, 74
- , methyl 2-acetamino-3-acetyl-4,6-benzylidene-, 74
- , methyl acetamino- 3,4,6-triacetyl-, 74

- , methyl 2-acetyl-3-acetamino-, 74
- , methyl 2-acetyl-3-acetamino-4,6-benzylidene-, 74
- , methyl 2-amino-, and hydrochloride, 74
- , methyl 2-amino-4,6-benzylidene-, hydrochloride, 74
- , methyl 3-amino-4,6-benzylidene-, 61 hydrochloride, 75
- , methyl 4,6-benzylidene-, 56, 75
- , methyl 2,3-dimethyl-, 74
- , methyl 4,6-dimethyl-, 54, 75
- , methyl 2,4-dimethyl-3,6-anhydro-, 75
- , methyl 2,3-dimethyl-4,6-benzylidene-, 74
- , methyl 2,3-ditosyl-4,6-benzylidene-, 74
- , methyl 2,3-ditosyl-4,6-dimethyl-, 74
- , methyl 2-hydrazino-4,6-benzylidene-, 74
- , methyl 3-hydrazino-4,6-benzylidene-, 75
- , methyl 2-methyl-, 62, 74, 154
- , methyl 3-methyl-, 75
- , methyl 2-methyl-3,6-anhydro-, 74
- , methyl 2-methyl-3-benzoyl-4,6-benzylidene-, 74
- , methyl 2-methyl-4,6-benzylidene-, 74
- , methyl 3-methyl-4,6-benzylidene-, 75
- , methyl 2-methyl-6-desoxy-, 63, 74
- , methyl 2-methyl-3,4-diacetyl-, 74
- , methyl 2-methyl-3,4-diacetyl-6-iodo-, 63, 74, 154
- , methyl 2-methyl-3,4-diacetyl-6-trityl-, 62, 63, 74, 154
- , methyl 2-methyl-6-iodo-, 154
- , methyl 2-methyl-3-tosyl-, 74
- , methyl 2-methyl-6-tosyl-, 154
- , methyl 2-methyl-3-tosyl-4-acetyl-6-trityl-, 74
- , methyl 2-methyl-3-tosyl-4,6-benzylidene-, 74
- , methyl 2-methyl-3-tosyl-4,6-dibenzoyl-, 74
- , methyl tetraacetyl-, 53
- , methyl 2,3,4,6-tetraacetyl-, 74
- , methyl 2,3,4,6-tetramethyl-, 75
- , methyl 2,4,6-triacetyl-3-acetamino-, 75
- , methyl 2,4,6-trimethyl-, 75
- $\beta$ -D-Altroside, methyl, 75
- , methyl 3-acetamino-, 75
- , methyl 3-acetamino-4,6-dimethyl-, 75
- , methyl 3-amino-, 58, 59, 60 acetate, 75 hydrobromide, 75 hydrochloride, 75 identity with methyl epiglucosamine, 61
- , methyl 4,6-benzylidene-, 75
- , methyl 4,6-dimethyl-, 76
- , methyl 2,6-dimethyl-3,4-anhydro-, 75
- , methyl 2-methyl-4,6-benzylidene-, 75
- , methyl tetraacetyl-, 53
- , methyl 2,3,4,6-tetraacetyl-, 75
- , methyl 2,3,4,6-tetramethyl-, 75
- , methyl 2,4,6-triacetyl-3-acetamino-, 75
- , methyl 2,4,6-trimethyl-, 75
- , methyl 3,4,6-trimethyl-, 75
- , methyl 2,4,6-trimethyl-3-acetamino-, 61, 75
- D-Altruronic acid, 67, 68
- Aluminum chloride, in orthoacyl chloride formation, 119 reaction with maltose octaacetate, 82 in rearrangement of sugar acetates, 44, 46
- Amide rule of rotation, 21, 163
- Amyl alcohol, as starch precipitant, 259
- tert*-Amyl alcohol, as starch precipitant, 259
- Amylase, action on starch, 276 starch conversion by, 269, 270 starch fractionation by, 252
- Amyloamylose, 250
- Amylocellulose, 252
- Amylopectin. *See also* "B fraction" under Starch.
- Amylopectin, 250 methylation of, 268 the term, 280
- Amylopectin phosphate, 305
- Amylopectin triacetate, films and plastics of, 300 viscosity and osmotic pressure of, 294, 295
- Amylose. *See also* "A fraction" under Starch.
- Amylose, 250 methylation of, 268 the term, 280
- $\alpha$ -Amylose, 250
- $\beta$ -Amylose, 250
- Amylose triacetate, films of, 297, 298, 299

- plastics of, 300  
viscosity and osmotic pressure of, 294, 295
- Anhydro-D-altrose. *See* D-Altrose, anhydro-.
- Anhydroepiglucoamine, hydrochloride, 59, 61
- 1,5-Anhydro-D-mannitol. *See* Styrcitol.
- 1,5-Anhydro-D-sorbitol. *See* Polygalitol.
- $\beta$ -Antiarrin, 148
- Antiaronic acid, 159
- Antiarose, 159  
in cardiac glycosides, 148
- Araban, in pectin, 342
- D-Arabinose, 2  
specific rotation of, 155
- D-Arabinose, 2-methyl-, specific rotation of, 155
- L-Arabinose, 3  
in polyuronides, 338
- L-Arabinose, 2-desoxy-, 239
- Arabinosecarboxylic acid, 3, 4
- D-Arabitol, 180
- L-Arabitol, 180
- D-Arabomethylose, and *p*-bromophenylhydrazine and phenylosazone, 162
- L-Arabomethylose, and *p*-bromophenyl-osazone and phenylosazone, 162
- Ascorbic acid, 71
- Asymmetric carbon atom, van't Hoff-Le Bel theory, 2, 4, 18
- Avocado, heptose from, 12

## B

- Bacillus macerans, action on starch, 269
- Bacteriological culture media, dulcitol, mannitol, and sorbitol in, 192
- Banana starch. *See* Starch.
- Barium salts, in preparation of aldonic acids with NaCN, 23
- Benzenesulfonic acid, 3,4-dichloro-, starch ester, 303
- Benzimidazole, 2-[D-*altro*-pentahydroxy-amyl]-, 73
- Benzimidazole rule of rotation, 21
- Benzoic acid, cellulose esters, 320  
starch esters, 302, 303
- Benzyl alcohol, as starch precipitant, 259
- S-Benzylthiuronium salts, 168, 171

- Bis(diacetoneglucose) disulfide, 143
- Boric acid, complex with muscle adenylic acid, 213
- dl*-Borneol, as starch precipitant, 259
- Bread staling, 273
- p*-Bromophenylhydrazine, in identification of uronic acids, 339
- Brucine, D-altronate, 73  
L-altronate, 73  
salts with uronic acids, 339
- 1-Butanol, 2-ethyl-, as starch precipitant, 259  
—, 2-methyl-, as starch precipitant, 259
- Butyl alcohol, leaching of starch with, 263  
starch precipitation by, 258, 259, 263
- sec*-Butyl alcohol, as starch precipitant, 259
- Butyric acid, cellulose esters, 310, 317, 322, 324, 326  
starch ester, 301

## C

- Calcium altronate. *See* calcium salt under Altronic acid.
- Calcium L-galactonate, 70
- Calcium pectate, 334
- Calcium salts, in preparation of aldonic acids with NaCN, 23
- Canna starch. *See* Starch.
- Carbamic acid, *N*-phenyl-. *See* Carbanilic acid.
- Carbanilic acid, cellulose esters, 321
- Carbanilic acid, thio-, phenyl ester glucoside, 133
- Carbonium ion, in orthoester formation, 115
- Carbon tetrachloride, as solvent for acetylation of cellulose, 314
- Cardiac glycosides, 147-173
- Catalysts, for acetylation of starch, 284, 286  
for esterification of cellulose, 312
- Cellobiose,  $\alpha$ -octaacetate, AlCl<sub>3</sub> rearrangement of, 46
- Cellobiose, thio-, 136
- Cellulosans, sepn. from polyuronides, 334
- Cellulose, sources of, for ester prepn., 310
- $\alpha$ -Cellulose, 311
- Cellulose acetate, 309  
film, 300

- industrial applications, 322
- manufacture of, 311-314
- preparation of, 289
- salt effect on, 317
- viscosity of solutions of, 294
- viscosity and strength of, 316
- Cellulose acetate butyrate, 310, 317, 322, 324, 326
- Cellulose acetate linoleate, 319
- Cellulose acetate phthalate, 321
- Cellulose acetate propionate, 310, 317, 322
- Cellulose acid phthalate, 320
- Cellulose acid succinate, 320
- Cellulose benzoate, 320
- Cellulose carbamates, *N*-derivatives, 321
- Cellulose carbanilate, 321
- Cellulose crotonate, 319
- Cellulose esters, of aromatic acids, 320
  - of dibasic acids, 320
  - of higher aliphatic acids, 319
  - industrial applications, 322
  - mixed, 317
  - of organic acids, 309-327
  - salt effect on, 317
  - of substituted aliphatic acids, 319
  - of sulfonic acids, 321
  - of unsaturated acids, 319
- Cellulose formate, 310
- Cellulose nitrate, 325, 326
  - salt effect on, 317
- Cellulose sulfonates, 321
- Cellulose *p*-toluenesulfonate, 321
- Celtrobionic acid, 44
- Celtrobiose, 44
  - orthoesters of, 91
- Celtrobiose, hexaacetyl-, 1,2- or 1,6- ortho-acetic acid, 92, 112
- $\alpha$ -Celtrobiose, acetochloro-, 44, 76
- , heptaacetyl-, and Et<sub>2</sub>O compound, 76
- , octaacetyl-, 76
- $\beta$ -Celtrobiose, monohydrate, 76
- $\beta$ -Celtrobiose, heptaacetyl-, and Et<sub>2</sub>O compound, 76
- , hexaacetyl-, 1,2-orthoacetate(?), 76
- , octaacetyl-, 76
- , monohydrate, 76
- Cheirolin, 132
- Chemical properties, configuration and, of similar sugars, 26
- Cherry gum, structure of, 343
- Chitosamine, 60, 61
- Chromatin, 193
- Cinchonine, salts with uronic acids, 339
- Cinnamic acid, starch ester, 303
- Coacervation, 277
- Coatings, cellulose ester, 323
- Configuration, of alcohols (sugar) and higher-C sugars, 1-36
  - amide, benzimidazole, and phenylhydrazide rules of rotation and, 21
  - lactone rule of rotation and, 18, 19
  - and orthoester formation, 124
  - physical and chemical properties and, of similar sugars, 26
  - proof of, in glucose and galactose series, 33
- Convallatoxin, 148
- Corn starch. *See* Starch.
- Cotton linters, as cellulose source, 310
- Cozymase, 213
- Crotonic acid, cellulose ester, 319
- Crystallization, of sugars, solvents for, 24
- Cyanohydrins, Fischer cyanohydrin synthesis, 1-36, 37, 38
- Cyclohexanol, effect on leaching of starch, 263
  - effect on starch paste, 272
  - as starch precipitant, 259
- Cyclopentanophenanthrene, perhydro-3-hydroxy-, glycosides, 147
- Cymarin, 148, 166
- Cymaronic acid, phenylhydrazide and *S*-benzylthiuronium salt, 168
- Cymaronic lactone, 165
- Cymaronic lactone (1,4), 5-methyl-, 165
- Cymaronic lactone (1,5), 4-methyl-, 165
- Cymarose, 63, 64, 148, 149, 164-166, 168, 169
- Cysteine, thiosugar derivative, 134
- Cytidine, 207-210
- Cytidylic acid, 196, 217
- Cytosine, from desoxyribosenucleic acid, 237
  - desoxyribose nucleoside, 238, 240
  - from nucleic acids, 195
  - phosphodesoxyribosynucleotide, 241
  - from ribosenucleic acid, 198
- Cytosine, 3'-desoxyribosyl-, 240
- , diphosphodesoxyribosyl-, 242

## D

Damson gum, structure of, 343  
 Degradation, of aldose sugars, 254  
   of starch, 254  
 Depolymerization, of polytetranucleotides, 227  
 6-Desoxyaltroses, 62  
 Desoxy-D-altrose. *See* D-Altrose, desoxy-.  
 2-Desoxy-L-arabinose, 239  
 6-Desoxy-D-gulose, 30  
 Desoxyribonucleo-depolymerase, 245  
 Desoxyribose. *See* Ribose, desoxy-.  
 Desoxyribosenucleic acid, 195, 236-245  
 Desoxyribose nucleosides, 238  
 Desoxyribosyladenine, 240  
 3'-Desoxyribosylcytosine, 240  
 Desoxyribosylguanine, 240  
 Desoxyribosylpurines, 238  
 Desoxyribosylpyrimidines, 240  
 3'-Desoxyribosylthymine, 240  
 2-Desoxy sugars, 148  
 2-Desoxy-D-xylose, 239  
 5-Desoxy-D-xylose, 30  
 Dextrins, 269, 273  
 Dextrosecarboxylic acid, 3  
 Diabetes, effect of glycerol on insulin shock, 177  
   mannitol as sweetening agent in, 181  
   sorbitol as sweetening agent in, 187, 189  
 Dialysis, in purification of polyuronides, 333  
 Dichroism of flow, of starch-iodine complex of A fraction, 266  
 Diffusion constants, of starch acetates, 295  
 Diginigenin, 168  
 Diginin, 148, 168, 170  
 Diginonic acid, *S*-benzylthiuronium salt, 171  
   and phenylhydrazide and *S*-benzylthiuronium salt, 168, 169  
 Diginose, 148, 167-170  
 Digitaligenin, 158  
 Digitalis glycosides, 148  
 Digitalonic lactone, 150, 158  
 Digitalose, 62, 148, 150-158  
 Digitoxal, 160, 161, 162, 163  
 Digitoxide, methyl, 165  
 —, methyl dimethyl-, 165  
 Digitoxin, 163

Digitoxonic acid, 160  
 Digitoxonic lactone, 163  
 Digitoxonic lactone (1,4), dimethyl-, 165  
 Digitoxose, 63, 64, 148, 149, 159-163  
 Digitoxosecarboxylic lactone, 163  
 Di(glucosyl-3) disulfide, 143  
 Di(glucosyl-6) sulfide, 141  
 Dioxane, as solvent in sugar research, 24  
 Diphosphodesoxyribosylcytosine, 242  
 Diphosphodesoxyribosylpyrimidines, 241  
 Diphosphothymidine, 242  
 Disulfides, of sugars, 136, 144  
 Dulcitan, metabolism of, 191  
 Dulcitol, 181  
   metabolism of, 191

## E

Electrodialysis, in purification of polyuronides, 333  
 Electrophoresis, of starch, 251  
 Emicymarin, 148, 156  
 Enzymes, in fractionation of starch, 252  
   nucleoclastic, 226  
   starch conversion by, 269, 270  
 Epiglucoamine, 57, 60  
 —, anhydro-, hydrochloride, 59, 61  
 —, methyl-, and hydrochloride, 58, 59, 60, 61  
 Epimers, 4  
 Erythritan, metabolism of, 179  
 Erythritol, metabolism of, 178  
   tetranitrate, 179, 185  
 Erythroamylose, 250  
 Esterification, catalysts for, of cellulose, 312  
   of cellulose, 318  
   partial, of cellulose, 314  
   solvents for, of cellulose, 313  
   of starch, 281  
 Esters. *See also* Orthoesters.  
   of cellulose with organic acids, 309-327  
   of starch, 279-307  
 Ethanol, 2-methoxy-, as solvent in sugar research, 24  
 Ethyl alcohol, leaching of starch with, 263  
   as starch precipitant, 259  
 Ethylene glycol, metabolism of, 176  
 Ethylene glycol monomethyl ether, as solvent in sugar research, 24

- Ethylene oxide-mannitan monolaurate, 187
- Ethylene oxide rings, formation and cleavage of, 57
- Ethyl lactate, as solvent in sugar research, 24
- Explosives, starch nitrates as, 303
- F**
- Fatty acids, adsorption by starch, 255  
effect on starch paste, 272  
removal from starch, 256
- Feculose, 289
- Fermentation, alcoholic, by yeast, 213
- Film, cellulose acetate, 300  
cellulose ester, 325  
starch acetate, 297
- Fischer cyanohydrin synthesis, 1-36, 37, 38
- Folinerin, identity with oleandrin, 171
- Formic acid, cellulose ester, 310  
starch ester, 300
- Fractionation of starch, 247-277  
by adsorption (selective), 252, 255  
by aqueous leaching, 251, 261, 276  
by electrophoresis, 251  
by enzymes, 252  
by precipitation (selective), 252, 255, 258, 263, 276  
by retrogradation (selective), 251
- $\alpha$ -D-Fructopyranoside, methyl-, tetraacetate, 90
- D-Fructose, 2, 3, 16  
methyl 1,2-orthoacetate, 91  
orthoesters of, 90
- D-Fructose, 3,4,5-triacetyl-, methyl 1,2-orthoacetate, 90, 91
- Fructoside, 3-monoacetyl- $\beta$ -methyl-, and triacetate, 91
- $\beta$ -D-Fructoside, ethyl thio-, 138
- Fucohexonic acids, 30
- D-Fucopyranoside, methyl 3,4-isopropylidene-, 154  
—, methyl 2-methyl-3,4-isopropylidene-, 154
- Fucose, 28  
configuration of, 19
- D-Fucose, 62  
specific rotation of, 155
- D-Fucose, 2-methyl-, specific rotation of, 155  
synthesis of, 152, 153, 154
- , 3-methyl-. *See* Digitalose.
- L-Fucose, 30  
 $\alpha$ -L-Fucose, 2,3,4-trimethyl-, monohydrate, 156
- G**
- Galactan, in pectin, 342
- D-Galactonic acid, 67, 68
- L-Galactonic acid, 69  
and calcium salt, 70
- L-Galactonic acid, 5-keto-, 69, 70
- $\alpha$ -D-Galactopyranoside, methyl 3,4-isopropylidene-6-tosyl-, 154  
—, methyl 6-tosyl-, 154
- 4- $\beta$ -D-Galactopyranosido-D-altrose. *See* Neolactose.
- D-Galactose, 3  
calcium D-altronate from, 67, 68  
configuration of, 7, 33  
diethyl monothioacetal pentaacetate, 96  
higher-C sugars from, 8  
orthoesters of, 96  
in polyuronides, 338  
specific rotation of, 155
- D-Galactose, 6-desoxy-. *See* D-Fucose.
- , 1,2,3,4-diisopropylidene-6-iodo-, 62
- , 2-methyl-, specific rotation of, 155
- , thio-, 136
- , trithiodi-, 136
- aldehydo-D-Galactose, 1-chloro-1-thioethoxy-, pentaacetate, 96
- , 1-thioethoxy-, ethyl 1,2-orthoacetate 3,4,5,6-tetraacetate, 96, 121
- Galactosecarboxylic acid, 3
- D-Galacturonic acid, in polyuronides, 338  
and sodium calcium salt, 70
- L-Gala-D-*gluco*-7-desoxyheptonic acid, 30
- L-Gala-D-*manno*-7-desoxyheptonic acid, 30
- D-Gala-L-*manno*-7-desoxyheptose, 31
- $\alpha$ -Galaheptitol, 8
- D-Gala-L-*gluco*-heptitol, 9, 11  
and heptaacetate, 35
- D-Gala-L-*manno*-heptitol. *See* L-Perseitol.
- D- $\beta$ -Galaheptitol, 8
- L-Gala-D-*gluco*-heptitol, 14  
and heptaacetate, 35
- D-Gala-L-*manno*-heptonic acid, 3
- $\alpha$ -Galaheptose, 8
- $\beta$ -Galaheptose, 8
- D-Gala-L-*gluco*-heptose, 9, 20, 21
- D-Gala-L-*manno*-heptose, 9



- L*-Gala-*D*-fructo-heptose. *See* *L*-Perseulose.  
*L*-Galaheptulose. *See* *L*-Perseulose.  
*D*-Gala-*D*-manno-nonitol, 31  
*L*-Gala-*D*-gala-octaric acid, 29  
*D*-Gala-*L*-gala-octitol, and octaacetate, 35  
*D*-Gala-*L*-gulo-octitol, 22  
     and octaacetate, 35  
*D*-Gala-*L*-ido-octitol, 22  
*D*-Gala-*L*-gala-octonic acid, 29  
 Galactose, 8  
*D*-Gala-*L*-gulo-octose, 22  
*D*-Gala-*L*-ido-octose, 22  
 Gelatinization, of starch, 275  
 Gelation, configuration and, 277  
     of starch, 264, 272  
 Gel-forming substances, 331  
 Gitoxin, 163  
 Glaucoma, sorbitol in treatment of, 189  
 Glucocheirolin, 131, 132  
*D*- $\alpha,\alpha,\alpha$ -Glucoseconic lactone, 18, 20  
*D*- $\alpha,\alpha,\beta$ -Glucoseconic lactone, 18, 20  
*D*-Gluco-*D*-gala-decose, 29  
*D*- $\alpha,\alpha,\alpha$ -Glucosecose, 17, 29  
*D*-Glucufuranose, 1,2-isopropylidene-, 3-  
     monoacetate, 111  
     monobenzoate, 110  
 $\alpha$ -*D*-Glucufuranoside, ethyl thio-, 139, 140  
 Gluco-*gulo*-heptitol, and heptaacetate, 34,  
     35  
*D*-Gluco-*D*-ido-heptitol, 9, 17  
     and heptaacetate, 34, 35, 36  
 (*meso*)-Gluco-*gulo*-heptitol, 9  
*D*-Gluco-*D*-gulo-heptonic acid, 3, 24  
*D*-Gluco-*D*-gulo-heptonic lactone, 23  
 $\alpha$ -Glucoheptose, 7  
 $\beta$ -Glucoheptose, 7  
*D*-Gluco-*D*-gulo-heptose, 9, 18  
*D*-Gluco-*D*-ido-heptose, 9  
*D*-( $\alpha$ )-Glucoheptose, orthoesters of, 88  
 —, tetraacetyl-, methyl 1,2-orthoacetate,  
     88  
 $\beta$ -*D*-( $\alpha$ )-Glucoheptosyl chloride, pentaacetyl-, 88  
 Gluconasturtiin, 131  
*D*-Gluco-*D*-manno-nonitol, 31  
*D*-Gluco-*D*-manno-nonose, 29  
 Gluconic acid, crystalline, 24  
*L*-Gluconic acid, 4  
 Glucononose, 7  
*D*- $\alpha,\alpha,\alpha$ -Glucononose, 29  
*D*- $\alpha,\alpha$ -Glucooctitol, and octaacetate, 21  
*D*-Gluco-*L*-gala-octitol, 20, 22  
     and octaacetate, 35  
*D*-Gluco-*L*-talo-octitol, 22  
     and octaacetate, 35  
 Glucooctose, 7  
*D*-Gluco-*L*-gala-octose, 20, 22  
*D*-Gluco-*L*-talo-octose, 22  
 $\beta$ -*D*-Glucopyranose, 1,2,3,4- and 1,2,3,6-  
     tetraacetates, structures of, 109  
 $\alpha$ -*D*-Glucopyranoside, ethyl thio-, 139  
 $\beta$ -*D*-Glucopyranoside, ethyl thio-, 139  
 —, methyl, 2,3,4,6-tetraacetate, 109  
 4- $\beta$ -*D*-Glucopyranosyl-*D*-altrose. *See* Cel-  
     trobiose.  
 3- $\alpha$ -*D*-Glucopyranosyl-*D*-fructose. *See*  
     Turanose.  
 4- $\beta$ -*D*-Glucopyranosyl-*D*-mannose, 85  
 Glucosamine, 30, 60, 61  
*D*-Glucose, 2, 3, 17  
     in cardiac glycosides, 148  
     configuration of, 18, 33  
     higher-C sugars from, 7  
     pentaacetate, AlCl<sub>3</sub> rearrangement of, 46  
     6-phosphate, 306  
     in polyuronides, 338  
     specific rotation of, 155  
*D*-Glucose, aceto-, isothiocyanate and  
     thiocyanate, 133  
 —, 2-amino-, 61  
 —, 3-amino-, 59, 60  
 —, 1- $\alpha$ -bromo-2,3-ditosyl-4-acetyl-6-iodo-,  
     302  
 —, 1- $\alpha$ -bromo-2,3,6-tritosyl-4-acetyl-, 302  
 —, dimethyl-, from methylated starch, 269  
 —, 2-methyl-, specific rotation of, 155  
 —, monoisopropylidene-, spectrum of, 107  
 —, 1-thio-, 130, 134, 135  
 —, 3-thio-, 142  
 —, 2-thioethyl-, 143  
 —, 3-thiomethyl-, 142  
 —, 6-thiomethyl-, 144  
 $\beta$ -*D*-Glucose, 2,3,4-triacetyl-, 1,6-orthoacetic  
     acid, 110  
*d*- and *l*- $\beta$ -*D*-Glucose 1,2,3,4-tetraacetate-  
     *D*-mannose 3',4',6'-triacetate 6,1',2'-  
     orthoacetate, 97  
*D*-Glucoside, benzyl thio-, 138  
 —, ethyl thio-, 138  
 —, methyl, 2-chlorohydrin, 58

- , methyl thio-, 138  
 —, phenyl thio-, 132  
 $\alpha$ -D-Glucoside, methyl, D-altrose from, 54, 55  
 —, methyl 2-amino-4,6-benzylidene-, 61  
 —, methyl 2,3-ditosyl-4,6-benzylidene-, 54, 55  
 —, propyl thio-, 138  
 $\beta$ -D-Glucoside, ethyl thio-, 137  
 —, methyl 2-chloro-, 58  
 —, methyl 2-tosyl-, 60  
 —, methyl 3,4,6-triacetyl-, 60  
 4-Glucosidomannose, heptaacetyl-, 1,2-orthoacetate, 153  
 —, hexaacetyl-, 153  
 4- $\beta$ -D-Glucosyl-D-mannose, hexaacetate, 85  
 —, hexaacetyl-, methyl 1,2-orthoacetate, 86  
 4- $\beta$ -D-Glucosyl-D-mannoside, methyl, heptaacetate, 85  
 4- $\beta$ -D-Glucosyl-D-mannosyl chloride, heptaacetyl-, 86  
 Glucotropaeolin, 131  
 D-Glucuronic acid, in polyuronides, 338  
 Glutaric acid, *ribo*-trihydroxy-, 199  
 —, *L-arabo*-trimethoxy-, 151  
 —, *ribo*-trimethoxy-, 203  
*ribo*-Glutaric di(methylamide), trimethoxy-, 48, 50  
 Glycerol, effect on insulin shock, 177  
 metabolism of, 177  
 trinitrate, 185  
 Glycidol, metabolism of, 178  
 $\alpha$ -Glycofuranosides, 138  
 Glycosides,  $\alpha$ -, formation in Königs-Knorr reaction, 84  
 cardiac, 147-173  
 digitalis, 148  
 nitrogen, 202  
 thio-. *See* Thioglycosides.  
 Glycothioses, 135  
 Guanine, 195, 198, 200, 237  
 desoxyribose nucleoside, 238  
 phosphodesoxyribosynucleotide, 241  
 Guanine, desoxyribosyl-, 240  
 —, 9'-(3-phospho-D-ribofuranosyl)-. *See* Guanylic acid.  
 Guanine-uridylic acid, 223-226  
 Guanosine, 198, 200, 201  
 spectrum and structure of, 202  
 Guanosine, isopropylidene-, 207  
 —, trimethyl-N-methyl-, 203  
 Guanylic acid, 196, 214, 216  
 D-Gulo-L-gala-heptitol, 11  
 D-Gulo-L-talo-heptitol, 11, 17  
 L-Gulo-D-gala-heptitol, 16  
 L-Gulo-D-talo-heptitol. *See*  $\beta$ -Sedoheptitol.  
 L- $\beta$ -Guloheptitol. *See*  $\beta$ -Sedoheptitol.  
 D-( $\alpha$ )-Guloheptose, orthoesters of, 94  
 D-Gulo-L-gala-heptose, 11  
 D-Gulo-L-talo-heptose, 11  
 L-Gulo-D-tagato-heptose, 17  
 D-( $\alpha$ )-Guloheptose, tetraacetyl-, methyl 1,2-orthoacetate, 94  
 $\alpha$ -D-( $\alpha$ )-Guloheptosyl chloride, pentaacetyl-, 95  
 D-Gulomethylolose, 155  
 —, 2-methyl-, 155  
 D-Gulose, 4  
 —, 6-desoxy-, 30  
 L-Gulose, 17  
 Gum arabic, structure of, 343  
 Gums, plant, 331  
 structure of, from plants, 342
- ## H
- Halohydrocarbons, as solvents for acetylation of cellulose, 313  
 Hemicelluloses, 252, 332, 343  
 1-Hexanol, 2-ethyl-, as starch precipitant, 259  
 Hexitols, 180  
 Hexyl alcohol, as starch precipitant, 259  
 Holocellulose, 333  
 Hydration, of starch, 275  
 Hydrazine, derivatives, in identification of uronic acids, 339  
 Hydrocarbons, halogenated, as solvents for acetylation of cellulose, 313  
 Hydrochloric acid, rearrangement of orthoesters by, 121, 122  
 Hydrogenation, of 5-keto-L-galactonic acid, 70  
 of ribosylpyrimidines, 208  
 Hydrolysis, of orthoesters, 98-104, 104-107  
 of polyuronides, 335, 337, 340  
 of starch fractions, 268

- Hypoxanthine, from desoxyribosenucleic acid, 237, 238  
 desoxyribose nucleoside, 238  
 from inosinic acid (muscle), 210  
 Hypoxanthine, 9'-(3-phospho-D-ribofuranosyl)-. *See* Inosinic acid (from ribosenucleic acid).  
 —, 9'-(5-phospho-D-ribofuranosyl)-. *See* Inosinic acid, muscle.  
 —, ribosyl-. *See* Inosine.

## I

- D-Iditol, 181  
 L-Iditol, 16, 181  
 D-Idose, 4  
 L-Idose, 17  
 Inosine, 199  
   spectrum and structure of, 202  
 Inosine, 5-iodoisopropylidene-, 206, 207  
 —, isopropylidene-, 206, 207  
 —, tosylisopropylidene-, 206, 207  
 Inosinic acid, muscle, 197, 207, 210, 212  
   from ribosenucleic acid, 217  
 Iodine, adsorption by starch, 256  
 Iodine-starch complex, dichroism of flow of, 266  
 Isoamyl alcohol, as starch precipitant, 259  
 Isobutyl alcohol, as starch precipitant, 259  
 Isobutyric acid,  $\alpha$ -hydroxy-, 3  
 Isomannide, dinitrate, 185  
   metabolism of, 184  
 Isothiocyanates, of aceto-D-glucose, 133  
   of sugars, 144  
 Isothiourea, glucoside tetraacetate, 133  
 Isothiourea, phenyl-, glucoside tetraacetate, 133  
 Isotrehalose, seleno- 144

## K

- Ketene, acetylation of starch with, 290  
 Ketose alkyl orthoesters, 120  
 Königs-Knorr reaction, 79, 114  
    $\alpha$ -glycoside formation in, 84

## L

- Lacquers, cellulose ester, 324  
 Lactic acid, 2  
   ethyl ester, as solvent in sugar research, 24  
 Lactone rule of rotation, 18, 19, 160, 163

- Lactones, aldonic, 22  
   of sugar acids, 3  
 Lactose,  $\beta$ -octaacetate,  $\text{AlCl}_3$  rearrangement of, 46  
 $\alpha$ -Lactose, acetochloro-, 40, 41  
 —, octaacetyl-, 41  
 Lauric acid, starch ester, 302  
 Lauryl alcohol, effect on leaching of starch, 263  
   effect on starch paste, 272  
   as starch precipitant, 259  
 Leaching, aqueous, of starch, 251, 261, 276  
 Leather, cellulose ester coatings for, 324  
 Levoglucosan, 51, 52  
 Levulosecarboxylic acid, 3  
 Lignin, removed from polyuronides, 334  
 Lily bulb starch. *See* Starch.  
 Linoleic acid, cellulose ester, 319  
 D-Lyxomethylose, and *p*-bromophenylosazone and phenylosazone, 161, 162  
 D-Lyxose, orthoesters of, 84  
 D-Lyxose, diacetyl-, methyl 1,2-orthoacetate, 84  
 L-Lyxose, 2  
 $\alpha$ -D-Lyxoside, methyl-, triacetate, 84

## M

- Magnesium perchlorate, as catalyst in acetylation of starch, 289  
 Maltose, heptaacetate, 81  
   methyl 1,2-orthoacetate, hydrolysis of, 100  
   orthoesters of, 80  
 Maltose, acetyl-, 1,2-orthoacetyl chloride, 119  
 —, hexaacetyl-, methyl 1,2-orthoacetate, 82  
 Maltoside, ethyl, heptaacetate, 81  
 —, methyl, heptaacetate, 81, 82  
 $\alpha$ -Maltosyl bromide, heptaacetyl-, 82  
 Maltosyl chloride, acetyl-, 112  
 —, heptaacetyl-, 81, 119  
 $\alpha$ -Maltosyl chloride, heptaacetyl-, 82  
 Manna sugar. *See* Mannitol.  
 $\beta$ -Mannide, metabolism of, 184  
 Mannitan, monolaurate-ethylene oxide, 187  
   metabolism of, 184  
 D-Mannitol, 163

- hexanitrate, 185  
metabolism of, 181, 188
- D-Mannitol, 1,5-anhydro-. *See* Styrcitol.
- L-Mannitol, 181
- D-Mannitol group, of carbohydrates, 16
- L-Manno-L-gala-7-desoxyheptitol, 20
- L-Manno-L-talo-7-desoxyheptitol, 20
- L-Manno-L-gala-7-desoxyheptose, 20
- L-Manno-L-talo-7-desoxyheptose, 20
- L-Manno-D-gala-9-desoxynononic acid, 29
- L-Manno-D-manno-8-desoxyoctose, 28
- D-Manno-D-gala-heptitol. *See* D-Perseitol.
- D-Manno-D-talo-heptitol. *See* D-Volemitol.
- $\alpha$ -Mannoheptonic acid, 23
- D- $\beta$ -Mannoheptonic acid, 8
- D-Manno-D-gala-heptose, 5, 9
- D-Manno-D-tagato-heptose, 12, 17
- D-Manno-D-talo-heptose, 9
- D- $\beta$ -Mannoheptose, 8
- Mannoheptulose, 12
- D-Mannoheptulose, metabolism of, 17, 186
- L-Mannonic acid, 3, 4
- Mannonic lactone, 23
- D-Manno-L-gala-nonitol, 31
- D-Manno-L-gulo-nonitol, 31
- Mannonononic lactone, 20
- Mannononose, 5
- Manno-manno-octitol, 18
- D-Manno-L-manno-octitol, and octaacetate, 35
- D-Manno-L-manno-octonic lactone, 6
- D-Manno-L-manno-octose, 5, 8, 18
- $\alpha$ -D-Mannopyranose, 3,4,6-trimethyl-, 108
- D-Mannopyranoside, methyl tetramethyl-, 105
- 6-D-Mannopyranosyl-D-glucose, orthoester, 97
- D-Mannose, 2, 17, 24
- ethyl 1,2-orthoacetate, 84
- higher-C sugars from, 5
- methyl 1,2-orthoacetate, 84, 108
- orthoesters of, 83
- in polyuronides, 338
- D-Mannose, triacetyl-, methyl 1,2-orthoacetate, hydrolysis of, 105
- , 3,4,6-trimethyl-, methyl 1,2-orthoacetate, 108
- D-Mannoside, methyl, tetraacetate, 83
- $\alpha$ -D-Mannoside, methyl 2,3-anhydro-4,6-benzylidene-, 57, 61
- D-Mannuronic acid, in polyuronides, 338
- Menthol, as starch precipitant, 259
- Mercaptals, thioglycosides from, 136
- Merosinigrin, 130
- Mesquite gum, 338, 343
- Metabolism, of dulcitan, 191
- of dulcitol, 191
- of erythritan, 179
- of erythritol, 178
- of ethylene glycol, 176
- of ethylene oxide-mannitan monolaurate composition, 187
- of glycerol, 177
- of glycidol, 178
- of isomannide, 185
- of  $\beta$ -mannide, 185
- of mannitan, 184
- of D-mannitol, 181, 188
- of D-mannoheptulose, 17, 186
- of methyl alcohol, 176
- of oleic esters of mannitol and mannide, 186
- of polygalitol, 191
- of D-sorbitol, 183, 187
- of styrcitol, 186
- of sugar alcohols and their derivatives, 175-192
- of D-volemitol, 186
- Methane, dichloro-, as solvent for acetylation of cellulose, 313
- Methanol, metabolism of, 176
- as solvent in sugar research, 24
- Methanolysis, of orthoesters, 123
- Methoxyl, detection in polyuronides, 337
- determination in polyuronides, 335
- Methyl alcohol. *See* Methanol.
- Methylation, effect on optical activity of sugars, 155
- of gum arabic, 343
- of polyuronides, 334, 336, 339
- of starch, 268, 275, 276
- Methyl cellosolve, as solvent in sugar research, 24
- Methylene chloride, as solvent for acetylation of cellulose, 313
- Molding compositions, 322, 326
- Molecular weight, of cellulose esters, 316
- of desoxyribosenucleic acid, 244
- of pectins, 342
- of polyuronides, 342

- of ribonucleic acid, 234
  - of starch fractions, 276
  - Molecular weight determination, starch acetate solutions for, 295
  - Mucic acid, 7
  - Mucilages, 331, 343
  - Muscle, ribosylpurine nucleotides of, 210
  - Mutarotation, of *D*-altrose, 43
  - Myristic acid, starch ester, 302
  - Myronic acid, 129
  - Myrosin, 129, 133
- N
- Neolactobionic acid, 42
  - Neolactose, 40-43
    - phenylosazone, 76
  - Neolactose, hexaacetyl-, methyl 1,2-orthoacetate, 45, 46, 76, 95
  - $\alpha$ -Neolactose, acetochloro-, 40, 41, 43, 76
  - , heptaacetyl-, 76
  - , octaacetyl-, 40, 76
  - $\beta$ -Neolactose, 76
  - , heptaacetyl-, 76
  - , octaacetyl-, 40, 76
  - $\beta$ -Neolactoside, methyl, heptaacetate, 45, 76, 95
  - Neriantin, 148
  - Nitration, of starch, 303
  - Nitrogen glycosides, 202
  - Nomenclature, "aric," for sugar dibasic acids, 29
    - D* and *L*, of perseitol and sorbitol, 14
    - of starch components, 250
    - of sugars, 28
    - of thiosugars, 135
  - Nonitols, configurations of, 31
  - Nononic lactone, 6
  - $\Delta^9$ -Norcholonic acid, 21-hydroxy-, lactone glycosides, 147
  - Nuclease, 226
  - Nucleic acids. *See also* Desoxyribose-nucleic acid; Ribonucleic acid.
  - Nucleic acids, 193-245
    - the term, 194
  - Nuclein, 194
  - Nucleinase, 226
  - Nucleoproteins, 194
  - Nucleosidase, 226
  - Nucleosides, desoxyribose, 238
    - of ribonucleic acid, 197, 198
  - Nucleotidase, 226, 245
  - 5-Nucleotidase, 233
  - Nucleotides, phosphodesoxyribose, 241
    - of ribonucleic acid, 196, 197
    - ribosylpurine, of muscle, 210-213
    - ribosylpurine, of ribonucleic acid, 214-217
    - ribosylpyrimidine, 217-219
- O
- Oleandrin, 148, 171
  - Oleandronic acid, 172
    - phenylhydrazide and *S*-benzylthiuronium salt, 168
  - Oleandrose, 148, 168
    - and 2,4-dinitrophenylhydrazone, 171, 172
  - Oleic acid, effect on starch paste, 272
    - esters of mannitol and mannide, metabolism of, 186
    - as starch precipitant, 273
  - Optical rotation, amide, benzimidazole, and phenylhydrazide rules of, 21
    - lactone rule, 18
    - of starch acetates, 296
    - of sugars and their 2-methyl derivatives, 155
  - Orthoesters, 77-127, 138, 153
    - in altrose series, 45
    - definition and general structure, 78
    - hydrolysis (acid) of, 98-104
    - hydrolysis (alkaline) of, 104-107
    - mechanism of conversion of, 121
    - mechanisms of formation of, 113-127
    - orthoacyl halides and anhydrides, 112
    - preparation and properties, 79
    - structure of, proof of, 107-112
  - Osazones, improvements in characterization of, 24
  - Osmotic pressure, in polyuronide structure study, 341
    - of starch acetate solutions, 295
  - Osootriazoles, sugar, 25
  - Ouabain, 148
  - Oxidation, asymmetric, of sugars, 46
    - of starch, 274
- P
- Palmitic acid, effect on starch paste, 272
    - starch ester, 302

- Pectic acid, purification of, 334  
Pectic substances, 331  
Pectin, calcium D-altronate from, 70  
  structure of, 342  
2-Pentanol, 4-methyl-, as starch precipi-  
  tant, 259  
3-Pentanol, as starch precipitant, 259  
Pentasol, 276  
  as starch precipitant, 259  
Pentitols, 180  
Pentosans, determination of, 335  
Perchloric acid, as catalyst for acetylation  
  of cellulose, 312  
Periplocyamarin, 148  
Persea gratissima, heptose from, 12  
D-Perseitol, 5, 8, 9, 12, 14, 15, 16  
  and heptaacetate, 35  
L-Perseitol, 9  
  and heptaacetate, 35  
D-Perseitol group, of natural carbohy-  
  drates, 15  
D-Perseulose, 14  
L-Perseulose, 12, 13, 14, 17  
Pharmacology, of erythritol and erythri-  
  tan, 179  
  of ethylene glycol, 176  
  of glycerol trinitrate, 179  
  of isomannide and  $\beta$ -mannide, 185  
  of mannitan, 184  
  of mannitol, 183, 184  
  of methyl alcohol, 176  
  of nitrates of sugar alcohols, 185  
  of selenosugars, 145  
  of sorbitol, 189  
Phenylhydrazide rule of rotation, 21, 160  
Phosphatase, 232, 233  
Phosphates, starch, 305  
  transfer in muscle, 213  
Phosphoadenosine, 217  
5-Phosphoadenosine. *See* Adenylic acid,  
  muscle.  
Phosphodesoxyribose nucleotides, 241  
Phosphoribitol, 211  
5-Phospho-D-ribofuranose, 211  
3-Phosphoribonic acid, 215, 216  
5-Phosphoribonic acid, 215, 216  
  and  $\gamma$ -lactone, 211  
3-Phospho-D-ribose, 214, 215, 216  
Phosphorus, in starch, 270  
5-Phosphouridine, 218  
Phthalic acid, cellulose ester, 320  
Physical properties, configuration and, of  
  similar sugars, 26  
Plastics, amylose triacetate, 300  
  cellulose ester, 326  
  starch acetate, 297  
Polar compounds, adsorption by starch,  
  252, 255  
  effect on starch paste, 272  
  precipitation of starch by, 252  
Polygalacturonic acids, hydrolysis of, 336  
  structure of, 341  
Polygalitol, 135  
  metabolism of, 191  
Polymerization, degree of, of cellulose  
  esters, 316  
Polyuronides, 329-344  
  analysis of, 334  
  definition of, 329  
  detection of, 331  
  hydrolysis of, 335, 340  
  hydrolytic products from, 337  
  identification of units in, 337  
  isolation of, 331  
  purification of, 333  
  structure of, 340  
  sugars of, 338  
  uronic acids of, 338  
Potassium thiocyanate, as catalyst in  
  acetylation of starch, 289  
Potato starch. *See* Starch.  
Precipitation, selective, in starch frac-  
  tionation, 252, 255, 258, 263, 276  
2-Propanol, as solvent in sugar research, 24  
Propionic acid, cellulose esters, 310, 317,  
  322  
  starch ester, 301  
Propyl alcohol, as starch precipitant, 259  
Pseudofructose. *See* Allulose.  
Psicose. *See* Allulose.  
Purine, 200  
Purinenucleosidase, 226  
Purines, desoxyribosyl-, 238  
  ribosyl-, 198-207  
Pyridine, as catalyst for acetylation of  
  starch, 284  
Pyrimidinenucleosidase, 226  
Pyrimidines, desoxyribosyl, 240  
  diphosphodesoxyribosyl-, 241  
  ribosyl-, 207-210

## Q

Quinine, salts with uronic acids, 339

## R

Raney nickel, in reduction of sugars, 24

Rayon, 322

Rearrangement, acyl migration, acidic orthoester formation during, 109

acyl migration, in glycosides, 113

of orthoesters, 82, 100, 121

of sugar acetates by  $AlCl_3$ , 44, 46

Reduction, of sugars to alcohols, 24

Resonance, in orthoester formation, 117

Retrogradation, of starch, 247, 250, 251, 264, 273, 276

Rhamnoheptose, 7

L-Rhamnoheptose, 28

Rhamnohexitols, 20

$\alpha$ -Rhamnohexonic acid, 7

$\beta$ -Rhamnohexonic acid, 7

$\beta$ -Rhamnohexonic lactone, 7

Rhamnohexoses, 7, 18, 19

L-Rhamnononic acid, 28

Rhamnooctonic acid, 7, 28

L-Rhamnooctose, 28

L-Rhamnopyranose, 3,4-diacetyl-, methyl 1,2-orthoacetate, 153

L-Rhamnopyranoside, methyl 2-methyl-, 3,4-diacetate, 108, 154

$\beta$ -L-Rhamnopyranoside, methyl, triacetate, 108, 154

—, methyl trimethyl-, 105

—, methyl 2,3,4-trimethyl-, 107

L-Rhamnose, 28

in cardiac glycosides, 148

configuration of, 19

higher-C sugars from, 7

methyl 1,2-orthoacetate, 98, 105, 107

orthoesters of, 79

in polyuronides, 338

specific rotation of, 155

L-Rhamnose, diacetyl-, methyl 1,2-orthoacetate, spectrum of, 107

—, 3,4-diacetyl-, 154

methyl 1,2-orthoacetate, structure of, 108

—, dimethyl-, methyl 1,2-orthoacetate, 105

—, 3,4-dimethyl-, methyl 1,2-orthoacetate, 99, 107

—, 2-methyl-, specific rotation of, 155  
synthesis of, 151, 153

—, trimethyl-, methyl 1,2-orthoacetate, 105

Rhamnoside,  $\gamma$ -methyl-, monoacetate, 80

L-Rhamnoside,  $\gamma$ -methyl-, triacetate, 79

$\beta$ -L-Rhamnoside, methyl, triacetate, 79

Ribitol, phospho-, 211

D-Ribofuranose, 5-phospho-, 211

—, trimethyl-, 203, 204

Ribofuranoside, methyl 2,3-isopropylidene-, 212

—, methyl 5-phospho-2,3-isopropylidene-, 212

D-Ribomethylose, 161, 162, 163

D-Ribonic acid, 199, 207

—, 3-phospho-, 215, 216

—, 5-phospho-, 211, 215, 216

$\gamma$ -D-Ribonolactone, 5-phospho-, 211

—, trimethyl-, 209

$\delta$ -D-Ribonolactone, trimethyl-, 203, 204

Ribonuclease, 227, 231

Ribosenucleic acid, 195, 196-236

D-Ribopyranose, trimethyl-, 203

Ribose, 3'-hydroxyacetyl 1,2-orthoacetate, 87

1,2-orthoacetic acid, 87

D-Ribose, 2, 39

cyanohydrin synthesis with, 37, 38

from cytidine and uridine, 207

from nucleic acid, 195

orthoesters of, 86

from ribosenucleic acid, 198

synthesis of, 199

D-Ribose, 2-desoxy-, from nucleic acid, 195

from thymus nucleic acid, 239

—, diacetyl-, methyl 1,2-orthoacetate, 87

—, 3,4-diacetyl-, 3'-acetoxyacetyl 1,2-orthoacetate, 87

—, 3-phospho-, 214, 215, 216

L-Ribose, 42

orthoesters, 86

synthesis of, 10, 199

L-Ribose, 2-desoxy-, 239

—, 3,4-diacetyl-, 3'-acetoxyacetyl 1,2-orthoacetate, 87

Ribosenucleic acid, from tobacco mosaic virus, 235

Ribosenucleic acid, desoxy-, 195, 236-245

- Ribosylpurine nucleotides, of muscle, 210-213  
of ribosenucleic acid, 214-217
- Ribosylpurines, 198-207
- Ribosylpyrimidine nucleotides, 217-219
- Ribosylpyrimidines, 207-210
- Ribosyltheophylline, 200, 201
- Rice starch. *See* Starch.
- S**
- Salt effect, on viscosity of cellulose esters, 317
- Sarmentocymarin, 148, 172
- Sarmentonic acid, phenylhydrazide and *S*-benzylthiuronium salt, 168
- Sarmentose, 148, 168, 172
- Scillaren A, 148
- Sedimentation, in polyuronide structure study, 341
- $\alpha$ -Sedoheptitol, identity with volemitol, 47
- $\beta$ -Sedoheptitol, 12, 13, 16, 47, 48, 49
- Sedoheptulosan, 48, 49, 50, 52
- , tetramethyl-, 48, 49, 50
- Sedoheptulose, 11, 12, 13, 17, 47, 48, 49
- Sedum spectabile, sugar from, 12
- Selenoisotrehalose, 144
- Selenosugars, 144
- Selenoxide, of methyl  $\beta$ -D-glucoside triacetate, 145
- Sinalbin, 129, 131
- Sinapin, 129, 131
- Sinapinic acid, 131
- Sinigrin, 129
- Sionin, 187
- Sizes, textile, starch xanthates as, 307
- Sodium acetate, as catalyst for acetylation of starch, 288
- Sodium cyanide, in preparation of aldonic acids with Ca or Ba salts, 23
- Sodium thiocyanate, as catalyst for acetylation of starch, 289
- Solvents, for acetylation of cellulose, 313  
in sugar researches, 24
- D-Sorbitol, 14, 16, 181  
metabolism of, 183, 187
- D-Sorbitol, 1,5-anhydro-. *See* Polygalitol.
- L-Sorbitol, 181
- L-Sorbose, 16  
orthoesters of, 93
- L-Sorbose, triacetyl-, ethyl and methyl orthoacetates, 93
- Sorghum starch. *See* Starch.
- Spectra, of 1-, 3-, 7- and 9-methylxanthines and xanthosine, 201  
structure and, of orthoesters, 107
- Staling of bread, 273
- Starch. *See also* Amylopectin; Amylose.  
A and B fractions, 247, 250, 259, 260, 262, 263-271  
acetolysis of, 287  
adsorption by, 252, 255  
aldehyde content of, 276  
alkali lability of, 253, 267  
alkali number of, 254  
amylase action on, 276  
 $\beta$ -amylase conversion of, 269  
banana, 296  
botanical aspects, 275  
canna, 271, 296  
corn, 255, 267, 268, 270, 271, 272, 275, 282, 296  
corn, electrophoresis of, 251  
corn, waxy, 261, 265, 270, 271, 272, 292, 296  
defatting of, 256  
degradation of, 254  
dichroism of flow of iodine complex, 266  
electrophoresis of, 251  
enzymic conversion of, 269, 270  
enzymic fractionation and hydrolysis of, 252  
fractionation of, 247-277  
gelatinization of, 275  
gelation of, 264, 272  
granule structure of, 253  
hydration of, 275  
hydrolysis of, 268  
iodine adsorption by, 256  
leaching (aqueous) of, 251, 261, 276  
from lily bulbs, 261  
methylation of, 268, 275, 276  
nomenclature of components of, 250  
oxidation of, 274  
paste, 255, 271  
paste, viscosity of, 249, 253  
potato, 261, 263, 267, 268, 270, 271, 272, 292, 294, 296  
potato, acetylation of, 286, 289  
potato, electrophoresis of, 251



- potato, phosphate, 305  
precipitation (selective) of, 258, 263, 276  
precipitation with polar organic substances, 252  
pretreatment for esterification, 282  
problems, 275  
retrogradation of, 247, 250, 251, 264, 273, 276  
rice, 256, 271, 296  
rice, nitration of, 304  
sol, 265  
sorghum (waxy), 261  
structure of, 253, 275  
synthesis of, 270  
tapioca, 261, 263, 267, 268, 271, 272, 296  
ultracentrifuge studies, 267  
viscosity of solns., 266  
wheat, 255, 272, 294, 296  
wheat, acetylation of, 289  
wheat, pretreatment of, 287  
X-ray diffraction, 265
- Starch, 2,3-ditosyl-6-iodo-, 302
- Starch acetate, 281  
banana, optical rotation of, 296  
canna, optical rotation of, 296  
corn, optical rotation of, 296  
determination of acetyl value of, 290  
diffusion constants for, 295  
film-forming properties of, 297  
fusion temperatures of, 297  
molecular-weight determinations, 295  
optical rotation of, 296  
osmotic pressure of solutions of, 295  
potato, optical rotation of, 296  
potato, solubility of, 292  
potato, viscosity of, 294  
preparation of, 284, 289  
properties and characteristics of, 290  
properties of solutions of, 292  
rice, optical rotation of, 296  
solubility of, 291  
tapioca, optical rotation of, 296  
viscosity of solutions of, 293  
waxy corn (maize), optical rotation of, 296  
waxy corn, solubility of, 292  
wheat, optical rotation of, 296  
wheat, viscosity of, 294
- Starch benzoate, 303  
Starch butyrate, 301  
Starch chloroacetate, 301  
Starch cinnamate, 303  
Starch dichloroacetate, 301  
Starch 3,4-dichlorobenzenesulfonate, 303  
Starch esters, prepn. and properties of, 279-307  
Starch formate, 300  
Starch laurate, 302  
Starch laurate benzoate, 302  
Starch myristate, 302  
Starch nitrate, 281, 303  
Starch palmitate, 302  
Starch phosphate, 305  
Starch propionate, 301  
Starch stearate, 302  
Starch sulfate, 306  
Starch *p*-toluenesulfonate, 302  
Starch tosylate, 302  
Starch trichloroacetate, 301  
Starch xanthate, 307  
Stearic acid, starch ester, 302  
Stereoisomerism, cis-trans, in orthoester formation, 118  
theory of orthoester formation, 114
- Strophanthin, 148  
k-Strophanthin- $\beta$ , 173  
Strophanthobiose, 173  
Structure, of desoxyribosenucleic acid, 242  
of orthoesters, proof of, 107-112  
of polyuronides, 340  
of ribosenucleic acid, 219  
of starch, 253  
of starch A and B fractions, 263, 264  
of starch granule, 275
- Styracitol, metabolism of, 186  
Succinic acid, cellulose ester, 320  
Succinic acid, *meso*-dimethoxy-, 203, 204, 209
- Sugars, of cardiac glycosides, 147-173  
configuration and physical and chemical properties of similar, 26  
2-desoxy, 148  
Fischer cyanohydrin synthesis and configuration of, 1-36  
nomenclature of, 28  
in polyuronides, identification of, 338  
reduction of, to alcohols, 24  
seleno-. See Selenosugars.  
solvents for, 24  
thio-. See Thiosugars.

- Sugar acetates, rearrangements by  $\text{AlCl}_3$ , 44, 46
- Sugar alcohols. *See* Alcohols.
- Sulfates, starch, 306
- Sulfides, sugar, 136, 144
- Sulfones, sugar, 136
- Sulfonic acids, cellulose esters, 321
- Sulfosinapisin, 129
- Sulfur dioxide, as catalyst in acetylation of starch, 289
- liquid, as solvent for acetylation of cellulose, 313
- Sulfuric acid, as catalyst for acetylation of cellulose, 312
- as catalyst for acetylation of starch, 286
- Sulfur trioxide, as catalyst in acetylation of starch, 289
- Sulfuryl chloride, as catalyst in acetylation of starch, 289
- Synthesis, Fischer cyanohydrin, 1-36, 37, 38
- of starch, 270
- T**
- D-Tagatose, 68, 69
- , diisopropylidene-, 68, 69
- D-Tagaturonic acid, 69, 70
- , diisopropylidene-, 68, 69
- D-Talitol, 181
- L-Talitol, 181
- L-Taloheptulose, 48
- D-Talomucic acid, 10, 38, 39, 67, 68
- D-Talomucic 1,4-lactone, 67, 68
- D-Talomucic 3,6-lactone, 67, 68
- D-Talonic acid, 39, 67, 68
- D-Talose, 1,2-orthobenzoic acid, 93, 111
- orthoesters of, 92
- D-Talose, triacetyl-, methyl 1,2-orthoacetate, 92
- Tapioca starch. *See* Starch.
- $\alpha$ -Terpineol, as starch precipitant, 259
- Tetritols, metabolism of, 178
- Textile weaving, starch use in, 273
- Theophylline, ribosyl-, 200, 201
- Thevetin, 148
- Thioacetals, 140
- thioglycosides from, 136
- Thioaldoses, 134, 141
- Thiocellobiose. *See* Cellobiose, thio-.
- Thiocyanate, of aceto-D-glucose, 133
- Thio-D-fructoside, ethyl-. *See* D-Fructoside, ethyl thio-.
- Thiogalactose. *See* Galactose, thio-.
- 1-Thio-D-glucose. *See* D-Glucose, 1-thio-.
- Thio-D-glucoside. *See* D-Glucoside, thio-.
- Thioglycoses, 135
- Thioglycosides, from mercaptals, 136
- natural, 129
- synthetic, 132
- Thiosugars, 129-144
- D-Threitol, 180
- L-Threitol, 180
- Thymidine, 240, 243
- , diphospho-, 242
- , 3-tosyl-5-trityl-, 241
- , 5-trityl-, 240
- Thymine, from desoxyribonucleic acid, 237
- desoxyribose nucleoside, 238, 240
- from nucleic acids, 195
- phosphodesoxyribosynucleotide, 241
- Thymine, 3'-desoxyribosyl-, 240
- Thymus nucleic acid. *See* Desoxyribose-nucleic acid.
- Titanium tetrachloride, reaction with orthoesters, 86
- reaction with triacetylfructose methyl orthoacetate, 91
- in rearrangement of methyl tetraacetyl- $\beta$ -D-altrioside, 53
- rearrangement of orthoesters by, 122
- Tobacco mosaic virus, ribonucleic acid from, 235
- p-Toluenesulfonic acid, cellulose esters, 321
- starch ester, 302
- Trithiodigalactose, 136
- Triticonucleic acid, 196
- Trityl chloride, reactions of, 204
- Turanose, heptaacetate, 89
- methyl 1,2-orthoacetate, 89, 100
- orthoesters of, 89
- Turanose, hexaacetyl-, methyl 1,2-orthoacetate, hydrolysis of, 99
- Turanoside, methyl, heptaacetate, 89
- U**
- Ultracentrifuge, in polyuronide structure study, 341, 342
- in starch research, 267

Uracil, from nucleic acids, 195  
 from ribonucleic acid, 198  
 Uracil, 5-methyl-. *See* Thymine.  
 —, 3'-*D*-ribofuranosyl-. *See* Uridine.  
 Uridine, 207-210  
 —, 5'-bromo-, 208  
 —, dihydro-, 208  
 —, 2,3-dimethyl-, 209  
 —, 4',5'-diphenylhydrazino-, 208  
 —, 2,3-ditosyl-, 209  
 —, 2,3-ditosyl-5-trityl-, 209  
 —, ditrityl-, 209  
 —, iodoisopropylidene-, 210  
 —, 2,3-isopropylidene-, 210, 218  
 —, *N*(1')-methyl-, 208  
 —, 5'-nitro-, 208  
 —, 5-phospho-, 218  
 —, 5-phosphoisopropylidene-, 218  
 —, 5-tosyl-2,3-dimethyl-, 210  
 —, tosylisopropylidene-, 210  
 —, 5-trityl-, 209  
 Uridylic acid, 196, 217  
   guanine-, 223-226  
   nucleotidase action on, 226  
 Uronic acids, determination of, 335  
   of polyuronides, 338  
 Uzarin, 148

## V

van't Hoff-Le Bel theory, 2, 4, 18  
 Varianose, 71  
 Vernine, 198  
 Vitamin C, 71  
*D*-Volemitol, 8, 9, 11, 12, 13, 15, 16  
   and heptaacetate, 34, 35  
   identity with  $\alpha$ -sedoheptitol, 47  
   metabolism of, 186  
   synthetic, 32  
 Volemose, 32, 71  
 Volemulose, 13, 32, 71

Viscosity, of cellulose esters, 315  
   in polyuronide structure study, 341, 342  
   of starch acetate solutions, 293  
   of starch paste, 249, 253  
   of starch solns., 266

## W

Walden inversion, 54, 57, 115, 124  
 Wheat starch. *See* Starch.  
 Wood pulp, as cellulose source, 311

## X

Xanthates, starch, 307  
 Xanthine, 1-, 3-, 7- and 9-methyl-, spectra  
   of, 201  
 —, 9'-(3-phospho-*D*-ribofuranosyl)-. *See*  
   Xanthylic acid.  
 —, ribosyl-. *See* Xanthosine.  
 Xanthosine, 199, 201  
 Xanthylic acid, 214, 216  
 X-ray diffraction, of starch, 265  
 Xylitol, 180  
 Xylöidine, 303  
*D*-Xylomethylose, 161  
 Xylose, 5-thioethyl-, 143-144  
 —, 5-thiomethyl-, 141, 143  
*D*-Xylose, in polyuronides, 338  
   specific rotation of, 155  
*D*-Xylose, 2-desoxy-, 239  
 —, 5-desoxy-, 30  
 —, 2-methyl-, specific rotation of, 155

## Y

Yeast nucleic acid. *See* Ribonucleic  
 acid.

## Z

Zinc chloride, as catalyst for acetylation of  
 cellulose, 312  
   as catalyst for acetylation of starch, 288