



Engraving by Walker Del. ph. a.

Edmond Halley

*from a portrait by M. Dahl in the possession
of the Royal Society*

CORRESPONDENCE
AND PAPERS OF
EDMOND HALLEY

PRECEDED BY
AN UNPUBLISHED MEMOIR OF HIS
LIFE BY ONE OF HIS CONTEMPORARIES
AND THE
'ÉLOGE' BY D'ORTOUS DE MAIRAN

Arranged and Edited by
EUGENE FAIRFIELD MacPIKE

MEMBER OF THE HISTORY OF SCIENCE SOCIETY,
OXFORD HISTORICAL SOCIETY, ETC.

OXFORD
AT THE CLARENDON PRESS

1932

OXFORD UNIVERSITY PRESS

AMEN HOUSE, E.C. 4

LONDON EDINBURGH GLASGOW

LEIPZIG NEW YORK TORONTO

MELBOURNE CAPE TOWN BOMBAY

CALCUTTA MADRAS SHANGHAI

HUMPHREY MILFORD

PUBLISHER TO THE

UNIVERSITY

PRINTED IN GREAT BRITAIN

PREFACE

'No biographer has yet appeared to write the life of this great man, nor does any public monument yet adequately represent the national estimation which is so richly deserved by the second most illustrious of Anglo-Saxon philosophers.'¹

According to Prof. S. P. Rigaud² (*obit* 1839), the original MS. Memoir of Halley, now first published herein,

'was found in the Bodleian Library at Oxford; it is a small quarto and consists of twenty leaves. The author is not known, but it appears that he was of Cambridge University, was acquainted with Halley and Dr. Sykes, the orientalist, and wrote before Halley's manuscript observations were out of the hands of his executors'.³

The authorship of this MS. Memoir was, at one time, ascribed to Israel Lyons, jun. (1739-75), of Cambridge, although evidently of an earlier date.⁴ A transcript⁵ made by Rigaud is in the Bodleian Library, where, also, is a manuscript note⁶ by him, as follows:

'In the "Biographia Britannica" reference is made to some manuscript* memoirs communicated by Halley's son-in-law Mr. Price. Vol. iv, p. 2494, 1757.'⁷

* These are not the account of a [*sic*] which a copy is contained in this book, p. 2-19.⁸ For among other things, mention is made at the end of note [o], p. 2502, of Halley losing a favourite boy at sea to which no allusion is made in this narrative.⁹

Rigaud, after satisfying himself that the MS. Memoir of Halley found in the Bodleian Library was not identical with the memoirs by Henry Price, appears not to have made any further effort to discover the true authorship. The manuscript was transferred from the Bodleian Library to that of the Radcliffe Observatory, Oxford, where it is preserved now (1932). The text, as presented in the pages following, is after a photostat made directly from that original.

The wording of several portions of this memoir is closely similar to that of corresponding parts of Mairan's 'Éloge de M. Halley'.¹⁰

¹ *Nature*, vol. xxi, p. 303, London, 1880.

² 'Some Particulars of the Life of Dr. Halley; communicated by Professor Rigaud, through Mr. Baily' (*Monthly Notices of the Royal Astronomical Society*, Dec. 12, 1834, vol. iii, p. 67).

³ Cf. Baily, Francis: *Account of Flamsteed* (1835); *Supplement* (1837), p. 731, where reference is made to the purchase of Halley's manuscript observations by the British Government.

⁴ See Rigaud, S. P.: *Memoirs of the Royal Astronomical Society* (1836), vol. ix, p. 206, note.

⁵ MS. Rigaud 7, ff. 2-19, Bodleian Library, Oxford.

⁶ MS. Rigaud 7, f. 50.

⁷ *Biographia Britannica*, vol. iv, p. 2494, side-note (b), London, 1757.

⁸ MS. Rigaud, 7, f. 2-19.

⁹ See p. 8, notes (5 and 6).

¹⁰ Mairan, J. J. d'Ortois de: 'Éloge de M. Halley', in *Mémoires de l'Académie Royale des*

This seems to warrant the belief that the author was Martin Folkes (1690-1754), to whom Mairan acknowledged indebtedness. That the reader may judge for himself, the original French text of Mairan's 'Éloge' has been inserted immediately after the memoir, with notes referring to the related portions of the latter. The handwriting of the manuscript of the memoir is, apparently, not that of Folkes. It may well be a copy made, under his direction, by a clerk. The original may have been transmitted to Mairan, in Paris.

It is, of course, possible that the memoir communicated by Folkes to Mairan in Paris may have been somewhat longer than the one which we are reproducing. Folkes, in his letter of transmittal to Mairan, or perhaps on the occasion of a visit to Paris soon after Halley's death, may have made some further comments. In fact, Mairan, in his 'Éloge' of Halley, has some remarks, which he seems to ascribe to Folkes, concerning Halley's sympathetic and happy temperament¹ that do not appear to be based directly or entirely upon the corresponding section of Folkes's MS. memoir as we have it now.

Martin Folkes, President of the Royal Society, 1741-52, was born in 1690, on the 29th October, which by an odd coincidence happens to be Halley's birthday. He was educated at Saumur and Cambridge. He died in 1754, having survived Halley by twelve years. Folkes's memoir (if it be indeed his), although brief, is interesting and valuable, coming (as it appears to me to come) directly from the pen of an able contemporary of Halley and a President of the Royal Society.

There were no notes accompanying the manuscript. The annotation has been inserted by the present editor.

The chronological lists of Halley's Correspondence are about as nearly complete as it is possible to make them at this time, and will assist in tracing the relationship between the letters now first published and those already printed. Of the latter, somewhat fuller citations appear, in proper chronological order, in the 'Remarks' column; thus facilitating reference to a considerable portion of Halley's correspondence.

The Letters, as printed herein, are from several different sources and, in most cases, are reproduced from photostats of the original manuscripts, as explained in the respective notes. A few of the letters, however, are reprinted from old or rare works not easily accessible,

Sciences (for 1742), Paris, 1744/5; (see *Histoire*, pp. 172-88); translated into English in *The Gentleman's Magazine*, vol. xvii, pp. 455-8; 503-7, London, 1747.

¹ See p. 22.

but endeavours have been made to avoid unnecessary duplication. The Papers of Halley have never been printed before. They are all from photostats of the original manuscripts in the Royal Society's Library, as noted in each case.

Halley's other unpublished Letters and Papers, exclusive of his MS. observations at Greenwich,¹ would, no doubt, when recovered suffice to make a second and, perhaps, even a third volume. The present writer's purpose is to make somewhat more accessible than hitherto all the material to which he has himself gained access, and to provide a key to sources.

As to the Appendix (Halleiana I-XXI), a number of the sections, in whole or in part, have already appeared elsewhere, but it has seemed desirable and almost necessary to include all in this collection, in view of the fact that no properly complete 'Life' of Halley exists. Furthermore, the material assembled now, from many sources, will throw welcome sidelights upon various points mentioned only briefly in the memoir which is here ascribed to Folkes.

The List of Halley's Published Writings, in Appendix XIX, in its original form was the work of the late Alexander J. Rudolph, then Assistant Librarian of the Newberry Library, Chicago. As here presented, it contains the changes made by him and the present editor, as well as some additions by the latter; the whole, however, being entirely re-arranged by Mr. H. W. Robinson.

The Section giving the Grouped References (Appendix XX) has been arranged chronologically, according to the most important phases of Halley's life and activities.

The references to other possible sources of original material, in Appendix XXI, may be helpful to those desiring to make further researches into the subject of Halley's life and work.

For the permission to make photographs, photostats, or transcripts of MS. letters, papers, portraits, &c., the editor wishes to express his deep sense of gratitude to the President and Council of the Royal Society, the Trustees of the British Museum, the Superintendent of the Public Record Office, and the Librarian of the Guildhall Library, London; the Librarians of the Bodleian Library and of Radcliffe Observatory, Oxford; the Librarians of the University Library and Trinity College Library, Cambridge; the officers of the Bibliothèque Nationale, Paris, and of the former Royal and Provincial Library of Hanover; and the Director of the Stadtbibliothek in Danzig.

¹ Cf. Baily, Francis, in *Memoirs of the Royal Astronomical Society*, vol. viii, p. 169, 1835.

The Royal Society Club generously authorized the reproduction of the interesting pages (Appendix XV) extracted from the well-known work by the late Sir Archibald Geikie. The editor is grateful for the permission to include those remarks.

From the officers and staff of the Library of Congress, Washington, D.C.; the John Crerar Library, and the Newberry Library, Chicago, as well as the Chicago Public Library,¹ the New York Public Library, the Library of the Boston Athenaeum, Boston, Massachusetts, and of other institutions in Great Britain, Europe, and America, the editor has received invaluable help in procuring photostat copies of the desired material there preserved.

To Sir Frank W. Dyson, K.B.E., F.R.S., Astronomer Royal, and Mr. D. J. R. Edney, Secretary and Librarian of the Royal Observatory, Greenwich; Miss K. Williams, Assistant Secretary and Librarian of the Royal Astronomical Society, London; Mr. Ralph J. Beever, M.A., St. Albans; Mr. W. T. Ottewill, Superintendent of Records, India Office, London; Miss E. G. Parker, Oxford, and many others who have supplied valuable data or have made useful suggestions, the editor tenders, anew, his sincere thanks.

The generous co-operation of Dr. J. F. Fulton, at Oxford, extending over many months, was exceedingly helpful and greatly facilitated the completion of the task undertaken.

The editor is especially indebted to Mr. A. H. White, honorary Consulting Librarian of the Royal Society, and to his colleague, Mr. H. W. Robinson, for their constant kindness, courtesy, and patience in answering innumerable inquiries. The extensive and invaluable material which they have supplied has been of the utmost assistance. Mr. Robinson's most notable contributions consist of his 'Extracts' from Hooke's MS. Diaries, and from the Journal Book and Council Minutes of the Royal Society. Mr. White and Mr. Robinson have each kindly examined my manuscript, in which they have made important emendations and additions. Furthermore, Mr. White has read all proofs and seen them through the press, a service of inestimable value to a Transatlantic editor.

The Editor, of course, assumes responsibility for all the material presented and for its arrangement. The insertion of *complete* cross-references in all the notes and the different Appendixes would have been impracticable. The index, compiled by Mr. Robinson,

¹ In respect of the treasures possessed by the Chicago Public Library, it would be ungrateful, on the part of a resident of that city, not to record again an enduring appreciation of the large collection of books, many of them rare, which was assembled, under the patronage of Queen Victoria, and generously presented to the city of Chicago, after the disastrous fire of 1871.

aims to supply this desideratum and to overcome the difficulties produced.

The present volume will not in any way lessen, but on the contrary will increase the need for a comprehensive biography of Halley. If it shall serve to promote the accomplishment of that desideratum, by (as one would hope) an English astronomer, the editor will feel amply repaid for his labours, which in any case have not been without their own reward.

In the final steps leading to publication, valuable encouragement and assistance were kindly given by Sir Frank W. Dyson, K.B.E., F.R.S., Astronomer Royal, Dr. Forest Ray Moulton, F.R.A.S., Dr. William Duncan MacMillan, F.R.A.S., Dr. George Sarton, Mr. A. H. White, and Mr. H. W. Robinson, to all of whom the editor is greatly indebted.

The appearance of this book in type was made possible by a generous subvention granted by The History of Science Society, to the President and Council and the Publications Committee of which Society, as well as to Mr. Frederick E. Brasch, Corresponding Secretary, the editor wishes to express his gratitude. He would also wish to acknowledge the care and skill which the Clarendon Press have devoted to the typography and production of the work.

E. F. M.

CHICAGO,
ILLINOIS, U.S.A.



CONTENTS

	<i>Page</i>
LIST OF ILLUSTRATIONS	xii
THE PORTRAITS OF HALLEY	xiii
I. MEMOIR OF HALLEY, BY (?) MARTIN FOLKES	I
II. ÉLOGE DE M. HALLEY, BY D'ORTOUS DE MAIRAN	15
III. CHRONOLOGICAL LISTS OF HALLEY'S CORRESPONDENCE, PRINTED AND UNPRINTED, SO FAR AS TRACED	29
IV. LETTERS OF HALLEY, MOSTLY UNPRINTED, IN ORDER OF DATE	37
V. UNPRINTED PAPERS BY HALLEY, IN ORDER OF DATE	135
VI. <i>APPENDIX: HALLEIANA</i>	171
I. Halley's Ancestry, by Ralph J. Beevor, M.A.	173
II. Extracts from India Office Records, 1676-8	179
III. Extracts from Robert Hooke's MS. Diaries	182
IV. Selected Letters from the Correspondence of Hevelius, Newton, and others	187
V. Halley's Latin Hexameters	203
VI. English Versification of the Hexameters	207
VII. Presentation of the <i>Principia</i> to King James II	209
VIII. Extracts from the Royal Society's Journal Books, 1688-96	210
IX. Extracts from the Royal Society's Council Minutes, 1688-99	239
X. Halley at the Mint at Chester	241
XI. The Admiralty's Instructions to Halley in 1698	243
XII. Halley's Two Voyages, 1698-1700	244
XIII. Halley's Two Missions to Vienna, 1702/3	248
XIV. An Account of Halley's Inaugural Address, as Savilian Professor of Geometry, at Oxford, in 1704	251
XV. Origin of the Royal Society Club	252
XVI. Halley's Will, with Comments	255
XVII. Inscriptions on Halley's Tomb, in the Churchyard at Lee	258
XVIII. Halley's Character and Personality	261
XIX. List of Halley's Published Writings	272
XX. Grouped References for Halley's Life and Work	279
XXI. Key to Sources of Original Material	288
INDEX	290

LIST OF ILLUSTRATIONS

- EDMOND HALLEY AT THE AGE OF 80. *From the original portrait by Michael Dahl in the possession of the Royal Society of London* Frontispiece
- EDMOND HALLEY. *From an original portrait in the possession of the Royal Society of London* Facing page 14
- EDMOND HALLEY. *From an engraving by G. White of the original portrait by Sir Godfrey Kneller* Facing page 28
- LETTER FROM HALLEY TO WALLIS, 11 Dec. 1686. *Original in the Library of Trinity College, Cambridge* Facing page 74
- HALLEY'S HOUSE AND OBSERVATORY in New College Lane, Oxford
Facing page 124
- EDMOND HALLEY. *From the portrait, painted in 1712, by Thomas Murray, in the possession of the Bodleian Library, Oxford* Facing page 134
- HALLEY'S ARMS. *From the original in the possession of the Bodleian Library, Oxford* Page 178
- LETTER FROM NEWTON TO HALLEY, 1 March 1724/5. *Original in Portsmouth Collection, University Library, Cambridge* Facing page 200
- HALLEY'S TOMB IN LEE CHURCHYARD Facing page 260
- HALLEY'S HOROSCOPE. *From the original in the possession of the Bodleian Library, Oxford* Page 271
- EDMOND HALLEY. *From an engraving by G. Vertue of the original portrait by R. Philips* Facing page 284

THE PORTRAITS OF HALLEY

THE Portraits of Halley reproduced in this work are perhaps worthy of some fuller description than it is possible to give on the plates themselves. There are five authentic portraits which it has been possible to identify definitely, although the particulars so far obtained are not so full as could be desired.

In chronological order, the first to receive mention would seem to be the one reproduced facing p. 14. This represents Halley as a youngish man, possibly approaching forty years of age. It was probably painted by Thomas Murray (1666-1724) in the last decade of the seventeenth century. The original is in the possession of the Royal Society. The inscription on the portrait was obviously added at a later date, when most of the portraits then in the Society's Collection received similar treatment. So far as can be ascertained this portrait has not been engraved.

The best known portrait is undoubtedly the one which is found facing p. 28. This was painted by Godfrey Kneller, afterwards Sir Godfrey Kneller (1646-1723), *c.* 1700. It represents Halley in the uniform of a Naval Captain. The original cannot be traced, but the portrait was beautifully and handsomely engraved by G. White, who died in 1732. Many photographic reproductions of this engraving exist, but they are poor representations of the work of the engraver.

The next in order of date is the portrait facing p. 134, which is here reproduced from a photograph of the original in the Bodleian Library. A copy of this is in The Queen's College, Oxford, which building is shown as a background to the portrait. This portrait was also painted by Thomas Murray, in the year 1712, and is striking in several respects. Thomas Hearne says of this portrait that it was 'done exactly like him'. A fine engraving was made by J. Faber, jun., in 1722.

The portrait facing p. 284 was apparently painted about 1720, or shortly after Halley had been appointed Astronomer Royal. It was the work of Richard Phillips (1681-1741). Unfortunately no trace can now be found of the original. The reproduction given in this book is from the line engraving by G. Vertue, a contemporary of Halley.

The portrait reproduced as the frontispiece is by Michael Dahl (1656-1743) and was painted in the year 1736, when Halley was 80 years old. The original is in the possession of the Royal Society, to whom it was bequeathed by Halley's daughter, Mrs. Price, in her will, dated 8 July 1764 and proved 14 November 1765.¹ This portrait was engraved by W. T. Fry in the early part of the nineteenth century for the Society for the Diffusion of Useful Knowledge.

In addition to the above, attention may be called to a Group Portrait of Halley, Newton, Flamsteed, and Sanderson. It is one of a set of six plates entitled 'Worthies of Britain', containing four oval portraits framed in palm

¹ Cf. *The Genealogist*, vol. xxv, p. 12, London, 1908.

branches, each having the name on a scroll at the bottom, and dates of birth and death at the sides. These plates were engraved by F. Kyte (? about 1740).

Many engravings and photographic reproductions have been made of most of the above portraits, and evidence is forthcoming that still other portraits exist, but these would seem to be either copies or posthumous portraits based on one or other of the foregoing, rather than originals.

I

MEMOIR OF DR. EDMOND HALLEY¹

Edmund² the Son of Mr. Edmund³ Halley, Citizen of London, was born on the 29th of October 1656,⁴ at Haggerston in the Parish of St. Leonard Shoreditch,⁵ in the Suburbs of the Town: and being sent early to St. Paul's School,⁶ he was there educated in Grammar Learning, under the Eminent Doctor Thomas Gale,⁷ then Master thereof; and became Captain of the School by the Time he was 15 years Old. At Midsummer 1673 he was admitted Student of Queens College in the University of Oxford;⁸ having already acquired not only good skill in the Latin, Greek, and Hebrew Tongues, but being also well acquainted with the Principles of Geometry and Astronomy, in which he soon made so great a progress, and so early distinguisht himself, that we Find a Piece of His, called, *Methodus directa et Geometrica, cujus ope investigantur Aphelia, Excentricitates, Proportioneseque Orbium Planetareorum, absque supposita æqualitate Anguli motus, ad alterum Ellipseos Focum, ab Astronomis hactenus usurpata*; written when he was not 19 years of Age; and publish't in the Philosophical Transactions for the Months of August and September 1676. He had also, at the University, apply'd himself to actual Astronomical observations and having, as he tells us, provided himself with *Instrumentorum supellectile aequali*, let no opportunity slip of making what use of them he was able; and soon found such a defect in the then best Tables, with regard, particularly, to the Motions of Jupiter and Saturn, that he was very desirous to Correct The Same; which however he was sensible could not be

¹ See Preface.

² The correct spelling of Dr. Halley's Christian name is 'Edmond', not 'Edmund'. Cf. *Notes and Queries*, vol. clv, 1928, pp. 24-5.

³ i.e. 'Edmond'. The Halleys were from Derbyshire. See Aubrey, John: *Brief Lives*, ed. Clark, vol. i, p. 282, Oxford, 1898; and *Notes and Queries*, vol. clii, 1927, p. 389.

⁴ i.e. 8 Nov. 1656, n.s. See Aubrey, *Brief Lives*, vol. i, p. 282; and *Biographia Britannica*, vol. iv, p. 2494 (London, 1757).

⁵ Shoreditch 'was a manor at the time of the Norman conquest, being then called Hergotestane'.—Lysons, Daniel: *Environs of London*, vol. ii, pp. 299-300, London, 1810-11. Cf. *Notes and Queries*, vol. xi, 1909, p. 64. Shoreditch subsequently became a part of the manor of Stepney, the old books of which are still in existence. An examination of them, in 1929, failed to reveal any entry of the surname 'Halley'.

⁶ Aubrey, *Brief Lives*, vol. i, p. 282; and *Biog. Brit.*, vol. iv, p. 2494.

⁷ Thomas Gale (1635?-1702).

⁸ Halley entered Queen's College as commoner 25 June and matriculated 24 July 1673. Magrath, John: *The Flemings in Oxford*, vol. i, p. 267, Oxford, 1904. Cf. Foster, Joseph: *Alumni Oxonienses (1500-1714)*, vol. ii, Early Series, p. 635, London, 1891.

done to the purpose, without a more correct Catalogue than was yet extant of the Fixt Stars. This work He would also willingly have set about, but that he understood Mr. Hevelius at Dantzic, and Mr. Flamsteed at home, had already applyed themselves to the same task. He therefore judged nothing could be of more service to the Science, than seconding those Gentlemens undertaking, by supplying that part of the Catalogue, their situation render'd them incapable of performing themselves; and which had never yet been done with Care by any other Astronomer: With this design, he left the University before he was of standing to take his First Degree; and finding his Father willing to gratify his Curiosity, and furnish the Expences¹ necessary for his Instruments and Voyage, he, after thinking of several places, at last pitch'd upon the Island of St. Helena,² a Settlement of the East India Company, in South Latitude of about 16 Degrees, as a proper Situation for his intended Observations of the Southern Stars. He then mention'd his design to Sr. Jos: Williamson,³ Secretary of State, and Sr. Jonas Moore,⁴ then Surveyor of the Ordnance, both which were his Friends, honour'd him with their particular Esteem, and the latter of which, was himself a skillful Mathematician and Astronomer, and a great Promoter of those Sciences. They greatly approved of his design, encouraged him in it, and having mention'd it to His Majesty King Charles 2d, he was also well pleas'd therewith, and gave him his Royal letter of Recommendation to the East India Company;⁵ who promised him, on their side, what assistance depended on them for his Voyage. Mr. Halley then provided himself with an Excellent brass Sextant, of $5\frac{1}{2}$ feet Radius, well fitted up, with Telescope Sights, indented Semicircles of the same metal, and Screws for the ready bringing it into any plane; A Quadrant of about 2 foot Radius, which he chiefly intended for observations, to adjust his Clock; a good pendulum Clock; and a Telescope of 24 feet; some lesser ones; and two Micrometers. Thus prepared, he set out in November 1676, and in about 3 months landed at St. Helena's, where he immediately applyed himself to the business he came for; and omitted no oppor-

¹ Halley's father, Edmond Halley, senior, salter, made to him an allowance of £300 per year. See *Biog. Brit.*, vol. iv, p. 2495, side-note l.

² Rigaud, S. P. and S. J., eds.: *Correspondence of Scientific Men*, vol. i, pp. 228, 241-3, Oxford, 1841.

³ *Calendar of State Papers, Domestic, 1677*, ed. Daniell, p. 314, London, 1909. Sir Joseph Williamson (1633-1704) was appointed Secretary of State, in 1674; cf. *Dict. Nat. Biog.*, vol. lxii, pp. 2-4.

⁴ Sir Jonas Moore (1617-79). See Birch, Thomas: *History of the Royal Soc.*, vol. iv, pp. 106-8; and *Dict. Nat. Biog.*, vol. xxxviii, p. 373.

⁵ See Appendix II. (Cf. *The Observatory*, vol. li, p. 286, 1928.)

tunity of rend'ring his catalogue compleat,¹ and which was afterwards printed at London, in 1679, with an Account of some other of his observations, he made during his stay at St. Helena's, particularly that of the Transit of Mercury over the Disc of the Sun; 28 Oct. 1677: with his thoughts on the use of that sort of Observations, for the discovery of the Suns Parallax.² Having finisht his work, he return'd to England, where he arriv'd³ in the Autumn of 1678; and soon after had his Master of Arts Degree at Oxford, conferr'd upon him, by the University,⁴ his first Degree and absence being dispenc'd with, upon his Majestys Royal Letters of Recommendation of the 18th of Novr. that year:⁵ wherein he was pleased to take notice, that he had received an Excellent Account of his Learning, particularly in Mathematicks and Astronomy; Whereof he had given good testimony by his Observations in the Island of St. Helena.

The 30th of the same November 1678, he was chosen Fellow of the Royal Society;⁶ and having a desire to see and confer with Mr. Hevelius, on the Subject of his Catalogue of the Fixt Stars, & knowing besides, that that noble Person was very desirous to see at his house, some able Astronomer of the Royal Society,⁷ well acquainted with making observations, who might be a Witness of the Exactness with which he observed: Mr. Halley determin'd upon making him a Visit in the Spring. He accordingly set out, carrying with him his 2 Foot Quadrant, which he had at St. Helena's; only to show Mr. Hevelius, ye Nature and uses of the Telescope Sights, and other Conveniencys with which that Instrument was Furnisht; and which it was thought, from the late Controversy between Doctor Hooke and him, Mr. Hevelius was not sufficiently apprized of. He arriv'd at Dantzic 16th may 1679,⁸ where Hevelius received

¹ At a meeting of the Royal Society, 7 Nov. 1678, 'Mr. Hooke shewed the planisphere and description of the stars of the southern hemisphere made by Mr. Halley' (Birch, *Hist. Roy. Soc.*, vol. iii, p. 434).

² Hooke, Robert: *Lectures and Collections*, 1678, pp. 75-7.

³ At a meeting of the Council of the Royal Society, 30 May 1678, 'Sir Jonas Moore gave an account that Mr. Edmund Halley, who went to the island of Saint-Helena, . . . was newly returned to England' (Birch, *Hist. Roy. Soc.*, vol. iii, p. 409). Robert Hooke, in his MS. diary (a folio preserved in the Guildhall Library), records, under date of 'Thursday, May 30, 1678', that he met 'Hally from St. Helena with Sr. J. More & Colwall at Toothes', the latter being a coffee-house or tavern.

⁴ The degree of M.A. was conferred upon Halley, at Oxford, 3 Dec. 1678 (Wood, Anthony: *Fasti Oxon.*, ed. Bliss, pt. ii, p. 368, London, 1820).

⁵ *Calendar of State Papers, Domestic*, 1678, ed. Daniell, pp. 517, 528, London, 1913.

⁶ Halley was proposed as a Fellow by Sir Jonas Moore (Birch, *Hist. Roy. Soc.*, vol. iii, pp. 441-2, London, 1757).

⁷ See 'Correspondence'; also Appendix IV.

⁸ 16 May 1679, o.s., i.e. 26 May 1679, n.s. *Biog. Brit.*, vol. iv, pp. 2497-8; and *Phil. Trans.* (1685), vol. xv, p. 1167.

him with great Joy and respect; and they Fell to observing the same Evening. Mr. Halley stay'd at Dantzic 'till near the End of July;¹ was present at a very great many of Hevelius's observations; and has done great Justice to that worthy Person's care and Exactness, as well as to the goodness of his Instruments, which he found to perform, far beyond what he thought possible to be done with plain sights only. He show'd Mr. Hevelius the Uses and Conveniencys of the Telescopic sights; but the old Gentleman was too much rivitted to his Opinion, of those he had so long and so successfully used; and had besides been too much sour'd by the manner in which Dr. Hooke had too freely treated his Labours, to think of altering his method or opinion; as appears from what he has said in his *Annus Climactericus*,² which Contains the account of this years observations: He was nevertheless highly pleased with this visit, and satisfy'd with the Justice Mr. Halley had done him, whom he stiles in the just mention'd work, *Hospitem gratissimum, Virum integerrimum et veritatis amantissimum*. It was a few weeks after Mr. Halleys departure, the 16 of the following September, that that dreadfull Fire³ happen'd, in which Mr. Hevelius's Observatory, with his whole Library, and all his instruments, in which he had expended so vast a sum, together with his dwelling house, several others, and almost all that belong'd to him, were in the most calamitous manner totally destroyed.⁴

The next year, Mr. Halley having a mind to make the Tour of France and Italy, and to converse with the Eminent Astronomers and other Learned Men of those parts, set out for Paris,⁵ on the 1st of December 1680, in Company with Mr. Nelson, well known by his religious writings: and I remember to have heard him say, he was on the road between Calais and Paris,⁶ when he first saw the

¹ Halley's letter to Hevelius, after the conclusion of their joint observations, was dated 'Gedani, Julij 8/18, 1679'. (See p. 44). A letter from Halley dated Oxford, Nov. 16, 1679, to John Aubrey (see p. 47), shows that he had returned into England before that date. In fact, Robert Hooke, in the folio journal before mentioned, records, under date Thursday, August 14, 1679, 'Hally retourn'd this day from Dantzick'. (See 'Extracts from Hooke's MS. Diaries' in Appendix III.)

² Hevelius, Johannes: *Annus Climactericus*, Gedani, 1685; reviewed by Dr. John Wallis, in *Phil. Trans.* (1685), vol. xv, pp. 1162-83.

³ 16 Sept. 1679, o.s. The fire broke out in the night of 26 and 27 Sept. 1679, n.s., while Hevelius was at his country-seat. *Allgemeine Deutsche Biographie*, vol. xii, p. 342, Leipzig, 1880. There was, until recently, in the library of the Royal Society, a copy of Capellus, *De Incendio Heveliano*, 1679, a very rare tract. Cf. Birch, *Hist. Roy. Soc.*, vol. iii, p. 519.

⁴ Some particulars of the loss of instruments, books, and records appear in *Phil. Trans.* (1685), vol. xv, pp. 1163-4. Hevelius rebuilt his observatory and, by August 1681, had acquired new instruments, although inferior to the old (*ibid.*, p. 1182).

⁵ Aubrey, *Brief Lives*, ed. Clark, vol. i, p. 283; and *Biog. Brit.*, vol. iv, p. 2499.

⁶ Halley arrived in Paris, 24 Dec. 1680 (Weld, Charles Richard: *Hist. Roy. Soc.*, vol. i, pp. 267-8, London, 1848).

Famous Comet of that year in its return from the Sun; he had already seen it in its going down to the Sun in the month of November before his setting out.

He has often talked of the particular Civilities he received from the Learned and Eminent Persons of Paris, during his stay in this Capital: from whence he and his Fellow Traveller proceeded to Italy,¹ where they spent great part of the year 1681, in the principal Citys, and seeing the most remarkable places of that Country; 'till Mr. Halley's affairs calling him home² and Mr. Nelson being dispos'd to stay longer abroad,³ the former⁴ left the latter at Rome, and embarking at Leghorn for Genoa, came from thence thro' France by Land, making some stay at Paris a second time in his return home.⁵

Mr. Halley the following year 1682 changed his Condition, marrying Mrs. Mary Tooke,⁶ an agreeable young Gentlewoman; and a Person of real merit; she was his only wife, and with whom he lived very happily,⁷ and in great agreement, upwards of 55 years;⁸ he had by her, that liv'd to grow up, one Son,⁹ and two Daughters;¹⁰ the Son died before him, but the Daughters are both living in great Esteem, the one is single, and the other has been twice handsomely married.

Mr. Halley intending now to settle for some time at home, resolv'd to pursue his Astronomical observations, and having, in order to it, fixt the Sextant he had at St. Helena, in a small Ob-

¹ *Biog. Brit.*, vol. iv, p. 2500.

² *Ibid.*

³ Nichols's *Literary Anecdotes*, vol. iv, pp. 188-222; and *Dict. Nat. Biog.*, vol. xl, p. 211 *passim*.

⁴ Halley was still in Rome 15 Nov. 1681 (*Notes and Queries*, vol. clv, 1928, p. 87).

⁵ *Biog. Brit.*, vol. iv, p. 2500. Halley returned into England, 24 Jan. 1681/2. Aubrey, *Brief Lives*, vol. i, p. 233. 'He hath contracted an acquaintance and friendship with the eminentst mathematicians of France and Italie, and holds a correspondence with them.' (*Ibid.*)

⁶ 'Edmond Hailey and Mary Tuke' (i.e. Tooke) were married 20 April 1682, at St. James, Duke's Place, Without Aldgate, London (*Notes and Queries*, vol. iv, 1911, pp. 85, 198).

⁷ 'But neither domestic cares, nor the tendernesses of an happy marriage could abate his ardour in the study of philosophy, or confine him to his native country; we see him again traversing the seas and again returning laden with new treasures to enrich the learned world.' Mairan: 'Éloge de M. Halley', as translated into English, in *The Gentleman's Magazine*, vol. xvii, p. 457, London, 1747.

⁸ Mrs. Mary Halley (*née* Tooke) died 30 Jan. 1735/6 (*Boyer's Political State of Great Britain*, vol. li, p. 215). She was buried at Lec, Kent, 14 Feb. 1735/6 (*Notes and Queries*, vol. cliii, 1927, pp. 212-13).

⁹ Edmond Halley, junior, Surgeon in the Royal Navy, born c. 1698; died near Portsmouth, 7 Feb. 1740, o.s. (*Notes and Queries*, vol. cliii, 1927, pp. 410-11).

¹⁰ The two surviving daughters, both born c. 1688, were Margaret Halley, who died single, 13 Oct. 1743, and Mrs. Catherine Price, formerly Butler, who died 10 Nov. 1765 (*Notes and Queries*, vol. cliv, 1928, pp. 208, 250).

servatory he fitted up at Islington,¹ where he then lived, he began a regular Course of Observations, of the Moon especially; on the 7th of Novr. 1682, and carryed on the same to the 16th June 1684. The account of these observations he publisht at the End of Street's *Astronomia Carolina*; and there he tells us, *that having observed the same Errors of the Tables of the Moon, to return after certain periods, he found there was no way so proper to correct the Tables as by a sedulous and continued series of observations, to be collated with the Calculus, and the Errors noted in an Abacus; from whence at all times, under the like situation of the Sun and Moon, he might take out the Correction to be allowed.* It was therefore his design, he tells us, *to carry on these observations diligently for that purpose, through the whole Course of 223 Lunations; after which the Eclipses of the Sun and Moon return nearly under the same circumstances; but he was interrupted at the time last mention'd, by unforeseen domestic occasions, which obliged him then to post-pone all other considerations, to that of the defence of his Patrimony.*²

It was about this time, that Friendship and Intimacy began, between him and Mr. Newton, afterwards Sr. Isaac;³ which continued as long as they both lived. Mr. Newton first communicated to him his Demonstrations of the Figure of the Celestial Orbits, which Mr. Halley strongly prest him to impart to the Royal Society, and after to draw up for the press: and when the same was done, and the whole book of the *Principia* was put into the form it now appears; Mr. Halley, as he had by his persuasions induced Mr. Newton to compose it, undertook himself the care of publishing it for the Author; as we learn from Mr. Newtons preface to that work, dated at Cambridge 8 May 1686. And after the book was printed Mr. Halley drew up a little abstract of what related in it to the explication of the Tides, and the general constitution of the System, for the use

¹ *Biog. Brit.*, vol. iv, p. 2500. Halley afterwards removed to a house in Golden Lion Court, on the east side of Aldersgate Street (London), a few yards north of what is now known as Falcon Street (*Biog. Brit.*, vol. iv, p. 2508, side-note; and *The Genealogist*, vol. xxv, p. 9, London, 1908).

² Halley's father died, intestate, c. March–April, 1684. Litigation ensued between Halley and his step-mother, who remarried. See Chancery Proceedings, 'Young v. Halley, 1693'; and 'Edmund Halley v. Robert Chester or Cleator and Joane, his wife' (Hamilton Division, 181–90).

³ Halley first visited Newton, at Cambridge, in August, 1684. The *Principia* resulted. 'But for him [Halley], in all human probability, that work would not have been thought of, nor when thought of written, nor when written printed' (De Morgan, Augustus: 'Halley' in *Cabinet Portrait Gallery of British Worthies*, vol. xii, p. 12, London, 1847, quoted in *Notes and Queries*, vol. clv, p. 24). Halley edited the *Principia*, saw it through the press, and paid the cost of the printing out of his own pocket. (Birch, *Hist. Roy. Soc.*, vol. iv, p. 486.)

of King James the 2d who was pleased to desire such an account for his own information.¹

Mr. Halley had been now some time very eminent among the members of the Royal Society, by the several curious and valuable papers he had publisht in the *Philosophical Transactions*, and elsewhere, among which a Theory of the variation of the magnetic Needle, in 1683, is not one of the least considerable, and in the latter end of the year 1685, he was induced to accept the place of Assistant Secretary to the Society;² in which post he took upon himself the care of publishing the *Philosophical Transactions*,³ which he did regularly for the following 7 years, from the beginning of 1686 to the End of 1692; which part of that Collection has ever been esteemed one of the most valuable of the whole, from the judicious choice he made of the papers there preserved; and the great number of excellent pieces of his own, in particular, which are there inserted.

Tho' Mr. Halley only publisht these *Transactions* 'till the end of 1692, he did not however desist from still enriching them with his own works, and a considerable Number of most curious and interesting papers of his are found dispers'd thro' the *Transactions* of the succeeding years.⁴

When the great recoinage of clipt money was made by K. William, & 5 Mints were for that purpose erected out of London, Mr. Halley was judg'd a proper person to be intrusted with the care of one of them; and he was accordingly 12 March 1696 appointed, by his Majesty, Comptroller of the Mint at Chester,⁵ in which Office he continued about 2 years, 'till the breaking up of those mints, on the finishing their business: It was about this Time also that the Czar Peter the Great of Russia was in England; who being appriz'd of Mr. Halley's Character and Reputation, conferr'd several times with him, on occasion of the designs he had form'd of establishing a Navy, and introducing the Sciences into his Country. This Great Prince was highly pleas'd with him, treated him with great distinction, admitting him to the Familiarity of his Table, to have the more

¹ See 'Correspondence', pp. 31, 85, and Appendix VII.

² 27 Jan. 1685/6. Birch, *Hist. Roy. Soc.*, vol. iv, p. 450, note.

³ Halley discontinued the editorship of the *Philosophical Transactions* at the end of 1692. There is no precise statement in the Royal Society's Council Minutes, but 7 Dec. 1692, Halley made an offer to furnish himself one-quarter of the matter published. On 15 Feb. 1692/3, 'It was resolv'd, that Dr. Plott shall print the *Transactions* & that for his encouragement therein, he have . . . etc. etc.'. Halley's salary as Clerk to the Society was continued until October 1696.

⁴ See Appendix XIX.

⁵ Brewster, Sir David: *Life of Newton*, 1855, vol. ii, pp. 194-6.

opportunities of being inform'd by his enter[taining] and instructing Conversation.¹

In 1698 the King, who had been inform'd of Mr. Halley's ingenious Theory of the Magnetic Needle, was desirous the variation shou'd, for the Benefit of Navigation, be carefully observed, in diverse parts of the great Atlantic Ocean; for which purpose His Majesty, the 19th Aug. 1698, appointed Mr. Halley Commander of his Ship the Paramoor Pink,² with orders³ to seek by observation the discovery of the Rule of the variation of the Compass, and at the same time to call at his Majestys Settlements in America, and make some observations there, in order to the better laying down the Longitudes and Latitudes of those places, and to attempt a discovery of what Lands lay to the South of the Western Ocean; for which purpose Mr. Halley set out on the 24th of the following October: But when he had already pass'd the Line, some Accidents that happen'd on board, and a mutiny caused by his Lieutenant, obliged him to return much sooner than was intended, and he arrived again in England the latter end of June 1699; from whence after the Trial of his Lieutenant,⁴ who was broken and dismiss'd the Kings Service, he again set out the 16 of September following, with the same Ship and another lesser, both under his command; and having observed in many places of the Atlantick Ocean, and advanced as far to the Southward as the Ice would permit, he toucht at The Canaries, Madera, and Cape Verd Islands, at St. Helena, the Coast of Brazile, Barbadoes, and several other places, according to his Instructions, and return'd to England the 7 Sept. 1700.

In which whole Voyage, he has told me, he was attended with a particular piece of good Fortune, which was, that, tho' he in that time 4 times crosst the Line, and went directly from thence into the cold Climates of the South, he lost not one Man,⁵ but brought home every Soul with him he Carried out, in good health;⁶ a par-

¹ Halley, it has been stated, 'spoke German fluently' in his conversations with Peter the Great, in 1698; yet the latter is said to have understood only Russian and Dutch!

² The recorded 'Commission for Mr. Edmund Halley to be Master and Commander of his Maty. Pink the Paramour, dated the 19 day Aug. '98' is preserved in the Admiralty Archives, in the Public Record Office, London.

³ See Appendix XI.

⁴ See 'Correspondence', p. 107. (Cf. Bellamy, F. A.: *Knowledge*, vol. xxxiii, p. 168, London, 1910.)

⁵ 'However, this happiness was dashed with the misfortune of losing a favourite boy, who by some unlucky accident was thrown overboard and drowned, and the captain was so deeply affected with the loss that during his whole life afterwards he never mentioned it without tears' (*Biog. Brit.*, vol. iv, p. 2502, note [O]).

⁶ If Halley 'brought home every Soul with him he Carried out', one must infer that the 'favourite boy' was taken aboard ship by Halley, at some place on his voyages. We have no evidence of this. (See Appendix XII.)

ticular, probably, more than to Fortune, owing to his own great Care, and that humanity to his Men, which was a very distinguishing part of his Character. As the result of these observations, Capt. Halley, after his return, publisht 1701 his Curious Chart of the variations,¹ observ'd in his voyage; which have since been remarkably verified in those Seas, as well as his conjectures concerning ye change of those variations in following times, wch. have answer'd beyond what could be expected from a Theory, offer'd in the very infancy of the observations on which it was to be built.

In 1701, Capt. Halley was appointed again 26th April, Commander of his Majestys same Ship, and having receiv'd his Instructions from the board of Admiralty, the 12 June following *to observe the course of the Tides, in the Channel of England, in every Circumstance thereof; and to take the bearings of the principal head Lands, in order to lay down the Coast truly:*² he immediately set out on the business, and having compleated the same; gave after his return, an account thereof in a large Map he publisht of the British Channel.

In 1702, Mr. Halley was sent by Queen Anne on an important Commission,³ which was, among other things, to view the Emperors Sea ports on the Dalmatian Coast of the Adriatic, upon which he set out from London 27 Novr. went over to Holland, and through Germany to Vienna; whence, after conferring with her Majestys Minister Mr. Stepney, he immediately proceeded into Istria, from whence returning to Vienna, he was introduced to the then Emperor Leopold, who was exceedingly pleas'd with him, presented him with a Fine Diamond Ring, and sent a letter by him to the Queen, greatly in his Commendation, under his own hand; after which, and receiving very particular Civilitys from the King of the Romans, Prince Eugene, and the whole Court, he return'd into England, was graciously receiv'd by his Sovereign, and having received fresh instructions, again set out, post by Holland, Osnaburg and Hannover, where he had the honour of supping with his present Majesty,⁴ then Electoral Prince, and his Sister the Queen of Prussia; and arriving again at Vienna, was the same night presented by Mr. Stepney to his Imperial Majesty, who directly sent his Chief Engineer forward with him into Istria, where they fortyfyed Trieste and the Port of Buccari, which Mr. Halley had before viewed, and found every way good, and convenient, and fit to receive and

¹ For references to Halley's Charts, see Appendix XIX.

² See 'Correspondence', pp. 118-20. The Admiralty's instructions to Halley, for the survey of the English Channel, were dated 12 June, 1701. (Cf. *Knowledge*, vol. xxxiii, 1910, p. 168.)

³ See Appendix XIII.

⁴ King George II.

secure Shipping of all sorts. Having seen these works finisht, Mr. Halley returnd to England, where he again Landed in the Month of October 1703, a little before the memorable Storm in November of that year.¹

The Learned Dr. Wallis² dying just after, Mr. Halley was by the Trustees of the Savillian Professorship at Oxford, chosen on the 8th of Jany. following 1703/4 to succeed him in the Geometry Chair of that University; which he held with the greatest reputation to his Death; not only reading constantly the several Lectures appointed by the founder, but publishing also several Books for the service and advancement of the Science, and the honour of the University, to which he now again belong'd.

In 1706 he publisht Apollonius's book, *De sectione Rationis*,³ by him translated, or rather decypher'd, from an Arabic Manuscript, in the Bodleian Library; for he did not, at that time, understand the Arabic Tongue, but only translated the whole by the assistance of a very few pages of it already translated by Dr. Barnard, which he made use of, as a Key to the rest; and this he did with such success, through his being so great a Master of the Subject, that I remember the Learned Dr. Sykes, (our Hebrew Professor at Cambridge, and the greatest Orientalist of his time, when I was at that University,) told me, that Mr. Halley talking with him upon the subject, shew'd him two or 3 passages which wanted Emmendation, telling him what the Author said, and what he shou'd have said, and which Dr. Sykes found he might with great ease be made to say, by small corrections, he was by this means enabled to make in the Text. Thus, I remember, Dr. Sykes expresst himself, Mr. Halley made Emendations to the Text of an Author, he could not so much as read the language of. To the translation of this valuable piece, now first publisht, he added his own restitution of the two Books of the same Author, *De Sectione Spatii*, which are lost, from the account given of these books by Pappus; and following close the method of Apollonius himself, in his other works. In 1710 he publisht his fine Edition in Folio of Apollonius's Conicks, and Serenus's Sections of the Cone and Cylinder; the latter in Greek and Latin, and also the Former as far as the End of the 4th Book, to which he added the 5th 6th and 7th which he translated from Arabic, and the 8th which he restored entirely, as he had done the books *de Sectione Spatii*, by the help of Pappus's Lemmata, still extant in Greek, and by him intended for the Demonstration of the 8th as well as the 7th book

¹ *Biog. Brit.*, vol. iv, p. 2512.

² John Wallis (1616-1703). (See Appendix XIV.)

³ *Biog. Brit.*, vol. iv, p. 2513, note [KK].

of the Conics. He also prepar'd about the same time an Edition of Menelaus' Sphericks, which being printed off, still lies ready, but has not yet been given to the Publick.¹

The 30th Novr. 1713, he was chosen Secretary of the Royal Society² in the Room of Dr. Sloane now Sr. Hans Sloane Bart. who resign'd that post; and Dr. Halley, as he now was, (having some years before in regard to his service, been created Dr. of Civil Laws³ in the University of Oxford,) accepting this place, he once more took the Charge of publishing the Philosophical transactions, which he did from the beginning of 1714 to the end of 1719; from wch. time, they were continued by Dr. Jurin, his Successor in the office of Secretary to the Society, and who was chosen upon Dr. Halley's resignation, 30th Novr. 1721.

During this time, the Dr. was also employ'd in preparing what he had long meditated, a more compleat and perfect Body of Astronomical Tables than had yet appear'd, and which being now finisht were printed off, and the publication daily expected with impatience, as no more than the precepts of Calculation, and a preface to give some account of the work, seem'd wanting. The Dr. however delay'd the publication from time to time, as always intending upon his returning to observations again, as will be seen, to enable himself to give yet some consummatory precepts, to render even those Tables still more perfect;⁴ and by these means, it is come about, that they have not yet seen the Light,⁵ and the Publick must expect them from ye hands into wch. ye Drs. Executors shall please to put them.⁶

Mr. Flamsteed dying the last day of the year 1719, Dr. Halley was recommended by the late Earl of Macclesfield, then Lord Chancellor, and perfectly acquainted with the Drs. Great Merits, as

¹ Subsequently published as: *Menelai Sphaericorum libri tii., quos olim, collatis MSS. Hebraeis et Arabicis, typis exprimendos curavit . . . E. Halleius.* Oxonii, 1758. 8vo.

² The date, 13 Nov. 1713, given in *Biog. Brit.* vol. iv, p. 2514, must be incorrect, for it appears as 30 Nov. 1713 in the R. S. Council Minutes.

³ 'July 19 (Wed.) 1710. Yesterday, Mr. Halley, Savilian Prof. of Geometry had the degree of Dr. of Law given him by Convocation' (Hearne, Thomas: *Remarks*, vol. iii, p. 25). Halley was created D.C.L. at Oxford, 16 Oct. 1710 (*Dict. Nat. Biog.*, vol. xxiv, p. 106).

⁴ Lisle, Joseph Nicolas de: *Lettres . . . sur les Tables Astronomiques de M. Halley . . .*, Paris, Quillau, 1749. (See p. 33 of first letter, about Halley's withholding his tables of the moon, to perfect them.)

⁵ These were published as *Tabulae Astronomicae, accedunt de usu Tabularum praecepta*, Lond. 1749. 4to. [Ed. J. Bevis.] The same, in English, London, 1752. 4to.

⁶ This wording shows that the Memoir was written soon after Halley's death, 14 Jan. 1741/2 (i.e. 25 Jan. 1742, n.s.), for his will was proved 9 Feb. 1741/2, by his two daughters. A reference to the purchase, by the British Government, of Halley's papers, or of some of them, is made by Francis Baily, in his *Supplement* (1837) to his *Account of Flamsteed* (1835), p. 721.

also by the then Earl of Sunderland, Secretary of State, and others, to his Late Majesty K. George the First, as the fittest Person to do Honour to the Post of Astronomer Royal and observator at Greenwich; which his Majesty was accordingly pleas'd to give him, by Commission dated the 9th day of February 1719/20.¹ And the Dr. to whom this post was highly agreeable, immediately set himself to provide proper instruments for the observatory, particularly a new transit instrument, and a large mural arch, of about 8 Foot Radius, curiously, and with the greatest accuracy divided and fitted to a substantial stone wall, built on purpose; the whole with the advice, and under the Direction of Mr. Graham of the Society, well known by his Exquisit Care and Judgement in all works of this sort; the Dr. being hereunto enabled, by a Sum of money obtain'd from his Majestys Treasury for that purpose, chiefly through the Favour and assistance of the Noble Lord, first mention'd, and who was pleas'd to add to his other great Qualifications, that of being the greatest Promotor of Science, and Patron of Men of Learning of his time.

The Observatory thus furnisht, Dr. Halley again set himself to observe, with a dilligence hardly to be credited; pursuing, in a Constant Series, the Scheme he had laid so many years before, of collecting a Body of Lunar places, to be daily compar'd with his Calculus, to find what improvements that was still capable of; and pursuing this method, he has left us a compleat set of Lunar observations, without neglecting, at the same time, those of the Sun and other Planets, at all convenient opportunities, from the 1st of January 1722 to the 30th Decemr. 1739 during all which time, he has scarcely ever lost a Meridian View of the Moon, either by Day or Night, when the Heavens would permit her to be seen. These observations it is hoped will, as well as his Tables, already printed, and to which he had added his Astronomy of Comets, be publisht for the use and Benefit of the Science, as well as in Justice to the Memory of this Truly great Man.²

Dr. Halley was of a strong constitution, and had known very Little Sickness during the whole Course of his Life, till he was Seized with a sort of paralitick disorder, some years before his

¹ See a paper by S. P. Rigaud in *Memoirs of the Royal Astronomical Society*, vol. ix, pp. 205-6; cf. also Baily, *ibid.*, vol. viii, p. 169.

² De Morgan has this remark on Halley's work at the Observatory: 'The period during which he held the post of Astronomer Royal, compared with those of his predecessor Flamsteed, and his successor Bradley, is hardly entitled, if we look at its effect upon the progress of science, to be called more than strong twilight night between two bright summer days' (*Cabinet Portrait Gallery of British Worthies*, vol. xii, p. 10, London, 1847).

Death; which however was not to such a Degree as to hinder his regular carrying on his observations to the 'Time above mention'd. He also went about 'till a little more than a twelve month, came mostly once a week to London to dine with a Number of his Friends, that usually met him of thur[s]day before the meeting of the Royal Society:¹ and even 'till within a few months he did not quite neglect his observations, but was at proper opportunitys employing his large mural Arch; preserving his memory and Judgement to the very last, with a good share of that chearfulness and Spirit he was so remarkable for;² His disorder increasing, he went off almost without Distemper, by a gradual Decay of his strength, departing this Life the 14 January 1741/2.*³ He was buried by his own direction, in the little Parish Church of Lea near Greenwich, where he had before interr'd his Consort. He is succeeded in his Post of Astronomer Royal by the Learned and Reverd. James Bradley D.D. F.R.S. and Savilian Professor of Astronomy at Oxford, well known in the Learned world, and whom he had himself on all occasions recommended and wisht for his Successor. In the Savilian Chair of Geometry he is succeeded by the Revd. Mr. Nathaniel Bliss, a Learned and worthy Member of that University, and also Fellow of the Royal Society. The greatest number of Dr. Halley's pieces, besides those already mention'd in this paper, are dispers'd through the Philosophical Transactions, where their Titles may be seen.⁴ He was every way an excellent Scholar,⁵ and even in Poetry he has shewn himself to have had a Genius, in the fine Latin verses, prefix'd by him to Sr. Isaac Newtons Principia.⁶ During his Sea Voyages, he could not help improving the Instruments he was there oblig'd to be conversant with, such as Davis's Quadrant, to which he added the Glass Vane; the Azimuth Compass; and the diving Bell;⁷ of wch. he has given an account in the Transactions.

Finis.

* Aged 85.

¹ Cf. Geikie, Sir Archibald: *Annals of the Royal Society Club*, p. 6, London, 1917.

² *Biog. Brit.*, vol. iv, p. 2517.

³ i.e. 25 Jan. 1742, n.s. Halley was buried at Lee, near Greenwich, 31 Jan. 1742, n.s. See Appendix XVII.

⁴ See Appendix XIX.

⁵ See Appendix XVIII.

⁶ See Appendix V.

⁷ 'Haley me parla beaucoup de son invention pour aller sous l'eau et d'y faire tout le travail qu'on fait sur la terre.' Letter dated Whitehall, 26 Jan. 1692, from Constantyn Huygens, addressed to Christiaan Huygens. See *Œuvres Complètes de Christiaan Huygens*, tome x, p. 237, La Haye, 1905. Cf. Chancery Affidavits, Trinity Term, 1691, Nos. 1132, 1133, 1134 (Public Record Office, London), made by persons who went down under water in Halley's diving-bell.

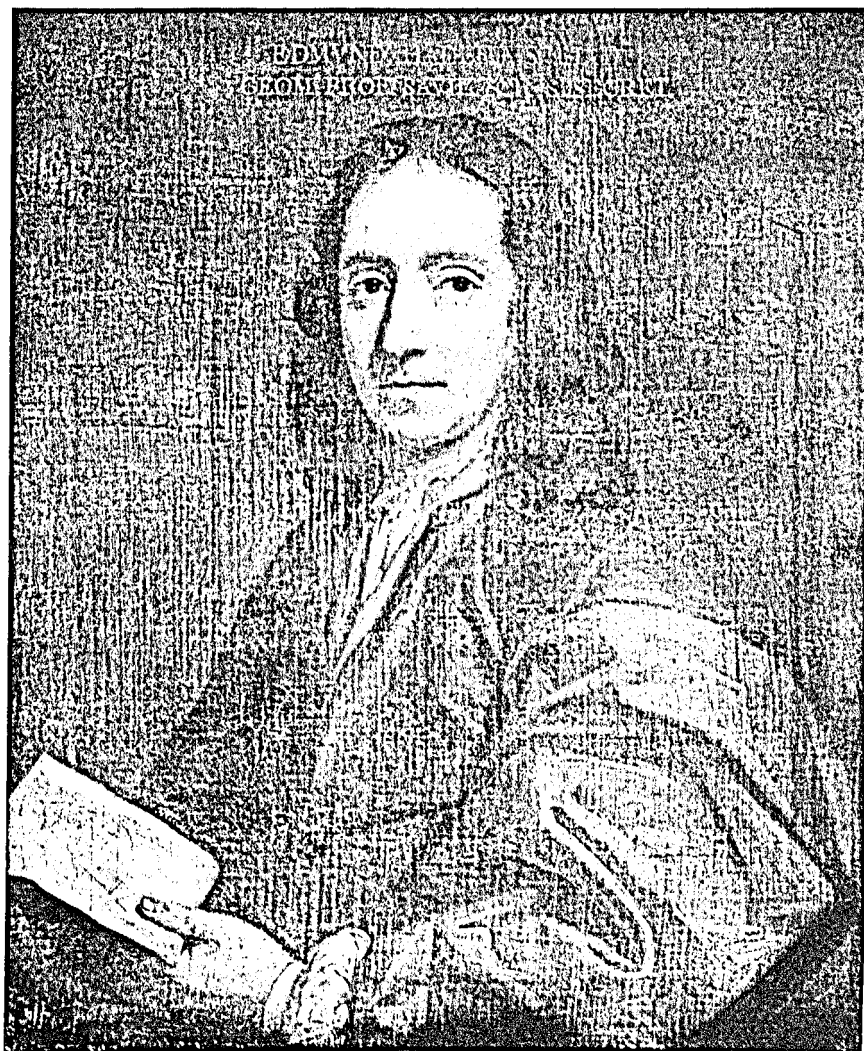

EDMOND HALLEY

*From a portrait in the possession of the
Royal Society of London*

II

ÉLOGE DE M. HALLEY¹

By JEAN JACQUES D'ORTOUS DE MAIRAN

Edmond Halley, fils d'Edmond Halley citoyen de Londres, d'une famille honnête, mais peu favorisée de la fortune, naquit dans un fauxbourg de cette Capitale le 8 Novembre 1656. Il fit ses Humanités dans l'École de St. Paul sous le fameux Thomas Gale, & il y devint habile, non seulement dans les Langues Latine, Grecque & Hébraïque, mais encore en Géométrie & en Astronomie. A l'âge de 17 ans il fut reçu parmi les Étudiants du Collège de la Reine dans l'Université d'Oxford. Beaucoup de curiosité & une grande facilité à apprendre, le portèrent d'abord presque également à toutes les Sciences, mais il se détermina bien-tôt en faveur de l'Astronomie. A peine avoit-il 19 ans lorsqu'il donna sa Méthode directe & géométrique pour trouver les Aphélie & les excentricités des Planètes, ouvrage que les Astronomes les plus consommez de ce temps-là pouvoient envier, & qui terminoit une dispute célèbre qu'il y avoit entr'eux sur ce sujet. Descartes commença sa Géométrie par un Problème où les Anciens s'étoient arrêtez; la première route que s'ouvre M. Halley, le conduit à tout ce qu'il y a de plus caché & de plus subtil en Astronomie.

Mais pour mieux sentir le prix de tout ce qu'il fit dans la suite en faveur de cette science & de celles qui en dépendent, jetons les yeux sur l'état florissant où se trouvoit alors l'Astronomie en Europe, & rappelons ici du moins les noms illustres des Émules de M. Halley dans la même carrière; car s'il est glorieux de tirer une science du berceau, il est peut-être encore plus difficile de se distinguer parmi ceux qui semblent l'avoir portée à son plus haut période.

Flamsteed premier Astronome du Roi d'Angleterre, & Chef de l'Observatoire de Greenwich, embrassoit le plus vaste champ des observations célestes, & travailloit sans relâche à réformer & à augmenter le catalogue des Étoiles fixes. Hévélius, comme un autre Tycho-Brahé, n'épargnoit ni soins ni dépenses pour faire refleurir l'Astronomie dans le Nord, & il en avoit établi le siège à Dantzick ville anséatique, dont il étoit le premier Magistrat. L'Italie retentissoit encore du bruit des découvertes du célèbre Dominique Cassini que la France venoit de lui enlever. La Hollande se glorifioit

¹ *Mémoires de l'Académie Royale des Sciences (Histoire)*, Année 1742. Paris 1744-5, pp. 172-88.

d'avoir produit M. Huguens, qu'elle possédoit tour à tour avec cette Académie naissante, & qui après avoir mis les Lunettes d'approche dans l'état de perfection & de grandeur où nous les voyons aujourd'hui, avoit démêlé autour de Saturne le premier Satellite que l'on y ait aperçu, & cet Anneau surprenant dont les phases n'avoient présenté jusque-là aux yeux des Astronomes que deux anses attachées au globe de cette Planète, ou deux autres Planètes qui paroisoient & dispa-roissoient bizarrement à ses côtés. La France enfin, opulente de ses richesses & de celles de ses voisins, rassembloit ses Bouillauds & ses Cassinis, Picard, Auzout, Roemer, de la Hire, Richer, qui s'étoient tous signalez par leurs découvertes, ou par l'invention de quelqu' instrument propre à en occasionner de nouvelles, ou par quelque méthode fine & ingénieuse. Plusieurs de ces hommes célèbres, non contens d'observer de cet édifice que la magnificence de Louis le Grand & les soins de l'illustre Colbert venoient d'élever à l'Astronomie, s'étoient transportez, les uns vers le Midi & tout proche de l'Équateur, pour y rectifier les élémens de cette science, les autres du côté du Pole & sur les ruines du fameux château de Tycho-Brahé, pour reprendre le fil des observations de cet Astronome: expéditions sçavantes qui se renouvellent de nos jours sous un règne qui n'est pas moins favorable aux Sciences & aux beaux Arts que le règne de Louis le Grand.

Voilà dans quelles circonstances M. Halley se fit connoître.

Les Étoiles fixes, indépendamment de leurs autres usages, sont autant de points de comparaison dont les Astronomes ne peuvent se passer pour déterminer la route des Planètes sous la voûte apparente à laquelle nous rapportons leurs mouvemens; aussi s'est-on donné des soins infinis dans tous les siècles pour connoître le nombre & la position exacte des Étoiles fixes. Cependant comme les Anciens voyageoient rarement au delà de l'Équateur, & que ceux d'entre les Modernes que leur navigation y avoit conduits, avoient pour la plûpart un tout autre objet que la perfection de l'Astronomie, ou manquoient du loisir & des moyens nécessaires pour la perfectionner à cet égard, les Étoiles de l'Hémisphère austral, & sur-tout celles qu'on y voit près de son Pole, demeu-roient ou tout-à-fait inconnues, ou mal placées sur le Globe céleste. C'est pour remplir ce vuide, cette partie imparfaite du Catalogue des Fixes de Ptolomée & de Tycho, & pour seconder les soins de Mrs Flamsteed & Hévélius, que M. Halley se proposa d'aller à l'Isle Sainte-Hélène, pays le plus méridional que les Anglois eussent alors sous leur domination, & situé sous le 16me degré de latitude australe. Mrs Williamson Secrétaire d'État, & Jonas Moore Grand-Maître de l'Artillerie &

sçavant Mathématicien, furent ses Mécènes auprès du Roi Charles II. Ce Prince à qui l'Isle Sainte-Hélène appartenoit par droit de conquête, & qui l'avoit cédée depuis peu à la Compagnie des Indes d'Angleterre, accorda libéralement tout ce qu'on jugea nécessaire pour les succès de cette entreprise, & M. Halley partit dans le mois de Novembre de l'année 1676. Il arriva à l'Isle Sainte-Hélène en trois mois, il y exécuta pleinement son projet, & revint à Londres vers l'automne de 1678.

D'abord, il y prit ses Degrés de Maître-ès-Arts, ayant obtenu des dispenses honorables à l'occasion de son voyage, & il fut reçu Membre de la Société Royale.

L'année suivante il fit imprimer son Catalogue des Étoiles australes, où entre plusieurs autres nouveautés on vit paroître la Constellation du fameux Chêne qui avoit servi de retraite à Charles II poursuivi par Cromwel après la déroute de Worcester, avec cette espèce de dédicace en style lapidaire: *Robur Carolinum, in perpetuam, sub illius latebris servati Caroli secundi Magnæ Britannicæ Regis, memoriam, in Cælum meritò translatum.* C'est ainsi que M. Halley voulut consacrer les marques de sa reconnoissance dans ce même Ciel que la protection & les bienfaits de ce Prince lui avoient donné moyen de connoître.

Il avoit rapporté plusieurs autres observations de l'Isle Ste-Hélène, & principalement celle du passage de Mercure par le disque du Soleil, qu'il sçavoit devoir arriver le 3 Novembre 1677. C'étoit le quatrième de ces phénomènes que l'on eût vû depuis l'invention des Lunettes, car auparavant il n'en étoit pas question; imperceptibles à la vûe simple, aussi-bien que les taches du Soleil, les Anciens n'auroient pû tout au plus que les soupçonner. D'ailleurs ils sont si rares, & en même temps si précieux à l'Astronomie, qu'un autre Astronome Anglois nommé Shakerley, étoit allé exprès à Surate en 1661 pour y voir le second, qui ne devoit arriver que de nuit en Europe. On sent assez combien une telle curiosité & de semblables démarches pour la satisfaire, font honneur à une nation chez qui elles sont communes.

L'observation de M. Halley étoit accompagnée de réflexions sçavantes sur l'utilité de ces sortes d'éclipses ou d'immersions des Planètes inférieures, pour découvrir la parallaxe du Soleil & sa distance à la Terre. Il donna dans la suite une méthode & des tables pour les prédire, & enfin il démontra en 1716, après bien des calculs & par une application ingénieuse de sa théorie aux parallaxes de Vénus & du Soleil, que le passage de cette Planète par le disque du Soleil, passage qui doit arriver le 5me Juin 1761, pourra nous

faire connoître la vraie distance du Soleil à la Terre, à un 500me près. Il exhorte en même temps & en termes pathétiques tous les Astronomes qui vivront alors, à se préparer pour cette importante observation, à mettre en œuvre tout ce qu'ils auront de sagacité & de sçavoir pour bien déterminer les circonstances d'un phénomène si rare & si décisif; car il ne se flattoit nullement d'en être témoin: mais il n'en prend pas moins part au spectacle, & il ne néglige rien pour s'en assurer le succès. Toute philosophie qui voudroit affoiblir en nous ce desir d'être utiles, lors même que nous ne serons plus, & nous enlever la satisfaction actuelle que nous procure un semblable avenir, sappe les fondemens du vrai héroïsme, & doit être proscrite.

M. Halley desiroit extrêmement de conférer avec M. Hévélius, & lui faire part de tout ce qu'il avoit observé de curieux à l'Isle Sainte-Hélène & dans sa navigation. C'étoit l'usage le plus flatteur qu'il en pouvoit faire pour lui-même, & aussi le plus capable de lui procurer de nouvelles lumières, M. Hévélius étant regardé alors par son âge, par ses immenses & sçavans Écrits, & par la place qu'il occupoit dans sa République, comme le Chef des Astronomes de l'Europe. M. Halley partit donc pour Dantzick, il y arriva le 26 de Mai 1679, & sans autre préliminaire, les deux Astronomes observèrent ensemble le même soir, comme gens qui se connoissoient depuis long temps, & qui s'étoient vûs dans cette commune patrie vers laquelle ils dirigeoient leurs regards. La différence de leurs opinions sur quelques points d'Astronomie pratique, n'empêcha pas qu'il ne se formât entr'eux une liaison intime, dont M. Hévélius nous a laissé des temoignages dans son *Annus climactericus*.

Conduit par de semblables motifs M. Halley voulut voir aussi les Sçavans de France & d'Italie. Il étoit à moitié chemin de Calais à Paris, lorsqu'il aperçut pour la première fois la fameuse Comète de 1680, si remarquable par sa grandeur, & si terrible aux yeux d'un vulgaire qui étoit encore très-nombreux; mais elle n'annonçoit à notre Astronome qu'un nouveau sujet de recherches, & de nouveaux succès, car un des plus excellens ouvrages que M. Halley nous ait donné depuis, a été son *Abrégé de l'Astronomie cométique*. Il y réduit, conformément à l'idée de M. Newton, les Trajectoires ou orbites de cette espèce de Planètes à de simples paraboles qui ont le Soleil pour foyer comme les ellipses des Planètes ordinaires, & qui en facilitent beaucoup le calcul; il nous met sous les yeux dans une Table d'une seule page, les nœuds, les périhélies, les distances & les mouvements de vingt-quatre Comètes des plus considérables & des mieux observées, c'est le fruit d'un travail immense; & cette même Comète

en 1680, qu'il croyoit être celle qui parut du temps de Jules-César, y joue un des principaux rôles.

De retour en Angleterre il se maria en 1682 avec Marie Tooke, demoiselle aussi aimable par les agrémens de sa personne que par les qualités de son esprit; mais ni les soins domestiques, ni les douceurs d'un heureux mariage, ne purent diminuer son ardeur pour l'étude du Ciel & du reste de la Nature, & le fixer dans son pays. Nous le verrons encore courir les mers, & en rapporter de nouvelles richesses philosophiques.

Parmi les Mémoires qu'il donna les années suivantes à la Société Royale, il y en a un de 1683 qui est de la dernière importance pour la Navigation; c'est sa *Théorie sur les variations de la Boussole*. On sçait que l'Aiguille aimantée ne tourne pas toujours exactement vers le Pole, qu'elle en décline quelque fois de 10, 15 ou 20 degrés, tantôt vers l'orient, tantôt vers l'occident, soit en différens lieux, soit en différens temps, & cela sans règle connue, du moins n'y avoit-on rien observé jusque-là qui en eût la moindre apparence. Mais M. Halley se défiant de ces prétendues irrégularités de la Nature, qui n'ont presque jamais de réalité que dans notre ignorance, rassemble un nombre infini d'observations sur ce sujet, la plupart tirées des plus fameux Routiers; il les compare, il en sasse & ressasse, pour ainsi dire, toutes les circonstances, & il trouve enfin qu'il y a sur le Globe terrestre, dans cette grande Mer qui sépare l'Europe & l'Afrique d'avec l'Amérique, plusieurs points dont les suites décrivent sur ce Globe autant de lignes courbes où la Boussole ne décline ni à droite ni à gauche. Il s'aperçoit que ces courbes ont un mouvement latéral réglé & périodique autour d'un axe & sur des Poles qui ne sont pas ceux de la Terre; que ce mouvement, cet axe & ces Poles étant connus, tout Navigateur placé sur un point donné de la surface du Globe terrestre, pourra connoître la distance du lieu où il est à ces lignes, & la déclinaison de l'Aiguille aimantée, ou, réciproquement, à quel point il est, par la quantité de déclinaison orientale où occidentale qu'il y observera. D'où l'on voit si cette connoissance pouvoit être poussée jusqu'à un certain degré de précision, elle n'iroit pas à moins qu'à la détermination des longitudes. C'est là le fait tel qu'il résulte des observations immédiates, & le fait est tout ce qu'il y a ici d'essentiel par rapport à la Géographie & à la Navigation.

Quant à la cause physique qu'en donne M. Halley, c'est un second Globe contenu dans celui de la Terre supposée creuse vers son centre, un gros Aimant qui attire à lui tout ce qui est doué de quelque vertu magnétique, & qui par sa rotation sur l'axe qui lui

est propre, entretient la déclinaison de la Boussole dans une variation continuelle.

Le Public est redevable à M. Halley du fameux livre des *Principes mathématiques de la Philosophie naturelle*, du moins en a-t-on joui par son moyen beaucoup plutôt qu'on n'auroit fait. Il s'étoit lié d'amitié avec M. Newton en 1684, & l'on sçait que ce grand homme avoit conçu dès-lors tout ce qu'il enfanta depuis de plus sublime en Géométrie & sur la Physique céleste; mais uniquement occupé à découvrir, & avare du temps qu'il y employoit, il ne se hâtoit nullement de rédiger ses découvertes, encore moins de les publier. M. Halley qui en avoit parfaitement senti l'étendue & l'utilité, l'engagea d'abord à communiquer à la Société Royale celles qui regardoient les orbites des Planètes, & ensuite à les mettre dans l'ordre où nous les avons dans le livre des Principes. Enfin il s'offrit de veiller à l'édition de cet ouvrage, & en ayant obtenu l'aveu de l'Auteur, il le fit paroître en 1686. Ce zèle pour l'avancement des Sciences & pour la gloire du Philosophe qui en reculoit si fort les limites, jeta les premiers fondemens de l'attachement inviolable que ces deux illustres amis conservèrent l'un pour l'autre jusqu'à la fin de leurs jours.

M. Halley avoit fait précéder l'édition des Principes de M. Newton, d'un Mémoire qu'il lut à la Société Royale sur le mouvement des Corps projetez, où il examine préliminairement la cause & les propriétés de la Pesanteur selon ces mêmes Principes.

La même année parut son *Histoire des Vents alisez & des Moussons qui règnent dans les Mers placées entre les Tropiques, avec un Essai sur la cause physique de ces Vents*, & une Carte qui en représente les directions sur 240 degrés en longitude, & plus de 30 en latitude de chaque côté de l'Équateur, ce qui comprend toute la région connue des Vents alisez; autre matière importante pour les Navigateurs, & qui peut marcher avec la théorie des variations de la Boussole: c'est de même le fruit d'un nombre prodigieux d'observations & de lectures. Du reste M. Halley attribue la cause de ces Vents, & avec beaucoup de vrai-semblance, au mouvement diurne de la Terre, ou, pour parler le langage ordinaire, au cours réglé du Soleil d'orient en occident, & à l'action de ses rayons, qui raréfiant & gonflant sans cesse l'atmosphère & les eaux de la Zone Torride, y produisent successivement une montagne mobile d'air, dont les isles adjacentes & les continens d'alentour modifient diversement & changent plus ou moins la direction générale.

Suivirent bien-tôt l'*Estimation de la quantité de vapeurs aqueuses que le Soleil élève de la mer, la Circulation de ces vapeurs, l'Origine des*

Fontaines, Questions sur la nature de la Lumière & des Corps transparents, Détermination des degrés de mortalité du genre humain pour évaluer le prix des rentes viagères, & plusieurs autres ouvrages de toute espèce, Astronomie, Géométrie & Algèbre, Optique & Dioptrique, Physique spéculative & expérimentale, Ballistique & Artillerie, Histoire Naturelle, Antiquités, Philologie & Critique; au nombre de vingt-cinq à trente Dissertations ou Mémoires que donna M. Halley dans l'espace de neuf à dix ans qu'il demeura à Londres, & presque tous remplis d'idées neuves singulières & utiles.

Cependant la théorie des variations de la Boussole faisoit grand bruit, non seulement parmi les Philosophes, mais chez tout ce qu'il y avoit de Navigateurs intelligens; l'examen en avoit été fait par plusieurs d'entr'eux, & toujours à l'avantage de la nouvelle idée. M. Delisle le Géographe la vérifia par des recherches immenses sur les Mémoires des Voyageurs. Mais le Roi d'Angleterre que la situation & les forces maritimes de ses États engageoient plus particulièrement à cette vérification, ne se contenta pas de l'examen paisible du Cabinet; il donna à M. Halley le commandement d'un de ses Vaisseaux, avec ordre de faire voile vers l'Océan Atlantique, & sur-tout dans les Mers où Sa Majesté avoit des établissemens, pour y constater la loi des variations magnétiques, & pour tenter de nouvelles découvertes. M. Halley partit le 3 Novembre 1698.

Il avoit déjà passé la Ligne lorsque des accidens qui arrivèrent sur son Vaisseau, & la révolte de son Lieutenant, l'obligèrent de retourner sur ses pas.¹ Il aborda en Angleterre au commencement de Juillet de l'année suivante, le Lieutenant rebelle fut cassé, & M. Halley qui ne se rebutoit pas aisément, se rembarqua deux mois après sur le même Vaisseau, avec un autre de moindre grandeur dont il eut aussi le commandement.² Enfin après avoir parcouru les Mers de l'un à l'autre hémisphère, jusqu'aux glaces qu'il découvrit sous le 52me degré de latitude australe, c'est-à-dire, jusqu'où Améric Vespuce avoit porté sa navigation, il revint en Angleterre le 18 Septembre de l'année 1700.³ Sa route est tracée sur les dernières Mappemondes de M. Delisle, parmi les routes des plus fameux Navigateurs, au nombre desquels on peut hardiment mettre M. Halley, même dans ce qui regarde purement l'art & la manœuvre de la Navigation. Il visita les Canaries, les Isles du Cap-verd, l'Isle Sainte-Hélène déjà illustrée par les observations astronomiques qu'il y avoit faites, les côtes du Brésil, les Barbades & plusieurs autres parages,

¹ Cf. the preceding *English memoir*, p. 8.

² Cf. above, p. 8.

³ Cf. above, p. 8.

conformément aux ordres qu'il avoit reçus,¹ ou à ses vûes particulières qui s'étendoient bien au delà des instructions de la Cour. Partout les variations de la Boussole se trouvèrent conformes à la loi qu'il leur avoit prescrite, & il en publia une Carte générale qui comprend, à un 8me près ou environ, toute la surface du Globe terrestre.

Ici M. Folkes que ses talens & son sçavoir ont placé à la tête de la Société Royale, ami de M. Halley, son successeur dans l'Académie des Sciences, & à qui nous devons la plus grande partie des Mémoires dont nous avons besoin pour cet Éloge, nous apprend une particularité que nous ne devons pas omettre. M. Halley avoit passé quatre fois la Ligne pendant le cours de ce voyage, c'est-à-dire, en moins de deux ans; il avoit été quatre fois des pays froids aux pays chauds, & des pays chauds aux pays froids, sans perdre un seul homme de son Équipage; singularité remarquable, & qui fut bien moins l'effet du bonheur de M. Halley que de son attention compatissante, & de cet esprit d'humanité qui fit toujours un des principaux traits de son caractère.²

Le Capitaine Halley, car on ne le nommoit plus autrement après cette grande navigation, commanda encore quelques Bâtimens pour aller lever la Carte de la Manche; les instructions de l'Amirauté qui lui furent expédiées à ce sujet en 1701, portoient: *Qu'il observeroit le cours des Marées dans toute la Manche Britannique, & qu'il prendroit le gisement exact des Côtes & des principaux Caps.*³ Les ordres de l'Amirauté furent diligemment exécutez, & avec une exactitude qui accompagne rarement la diligence.

En 1702 la Reine Anne chargea M. Halley d'une commission importante dont nous ignorons l'étendue, le détail & les motifs; on nous apprend seulement qu'il devoit aller visiter les Ports de l'Empereur sur le Golfe de Venise. Il est à présumer qu'il s'acquitta de cette commission au gré des deux Puissances, car ayant passé par Vienne pour se rendre en Istrie, l'Empereur Léopold alors régnant le reçut & le renvoya ensuite à la Reine avec toute sorte de marques de distinction, & M. Halley ne fut pas plutôt arrivé à Londres, qu'il eut ordre de retourner à Vienne. Il reprit le chemin d'Allemagne, passa par Osnabrug & à Hannovre, où il eut l'honneur de souper avec le Prince Électoral aujourd'hui Roi d'Angleterre, & avec sa sœur la Reine de Prusse; & étant arrivé à Vienne, M. Stepney Ministre d'Angleterre à cette Cour, le présenta à l'Empereur le jour même de son arrivée. Il n'étoit encore question, du moins en apparence, que des Ports de Trieste & de Boccari situez sur le Golfe.

¹ See above, p. 8.

² See above, p. 9.

³ See above, p. 9.

M. Halley accompagné de l'Ingénieur en chef de l'Empereur, fit réparer le premier, & y ajoûta quelques fortifications; à l'égard du second, il le trouva en état de recevoir avec sûreté des flottes de toute espèce.¹

Nous avions cru n'avoir à faire que l'éloge d'un Astronome, d'un Physicien, d'un Sçavant ou d'un Philosophe, & nous voilà insensiblement engagez dans l'histoire d'un excellent homme de Mer, d'un Voyageur illustre, d'un Ingénieur habile, & presque d'un homme d'État. Il est vrai que nous n'avons plus désormais à suivre M. Halley sous le Pole Antarctique ni dans une Cour étrangère; rendu à sa patrie, les Sciences & les Arts qui firent ses plus chères délices vont l'y retenir, & recevoir un nouveau lustre de ses travaux. Cependant il nous reste à parler de près de quarante ans d'une vie tranquille à la vérité, mais studieuse, & en ce sens d'autant plus remplie qu'elle a été accompagnée de plus de loisir. Abrégeons donc encore & l'histoire de M. Halley & celle de ses ouvrages.

Le docte Wallis étant mort vers la fin de 1703, M. Halley lui succéda à la Chaire de Professeur en Géométrie à Oxford.

En 1713 il fut choisi pour être Secrétaire de la Société Royale, place dont les fonctions consistent principalement à rassembler & à publier avec choix les ouvrages qui ont été présentez à la Compagnie par ses Membres. Il la garda jusqu'en 1720, où celle d'Astronome Royal à l'Observatoire de Greenwich vint à vaquer par la mort de M. Flamsteed. Celle-ci beaucoup plus conforme à ses desirs, fut demandée pour lui au feu Roi George par les Comtes de Macclesfield Chancelier d'Angleterre, & de Sunderland Secrétaire d'État, qui l'obtinrent sur le champ.

L'Astronomie reprit dès-lors tous ses droits sur M. Halley, il se procura de nouveaux instruments plus parfaits ou plus commodes par rapport à ses vûes, & il observa le ciel à Greenwich jusqu'au commencement de 1740, avec cette ardeur assidue qui faisoit une partie essentielle de son caractère. Il avoit formé depuis long temps le projet de rassembler une suite complète d'observations sur les lieux de la Lune, pour les comparer avec ses calculs, & pour réduire enfin à quelque loi constante la course bizarre de cet Astre, qu'il appelle aussi quelque part *Sidus contumax*. Il détermina ces lieux, non seulement par rapport aux Étoiles visibles & connues du Zodiaque, mais encore par rapport à une infinité d'autres qu'on ne découvre que par le secours des lunettes, & dont il avoit fixé la position dans une Carte céleste fort détaillée qu'il publia sur ce sujet. Et comme les éclipses des Étoiles du Zodiaque par la Lune sont de grand usage

¹ See above, pp. 9, 10.

pour les longitudes géographiques, il donna en 1731 une méthode pour trouver par ce moyen les longitudes en mer à un degré ou vingt lieues marines près, & pour les perfectionner sur terre.

Il avoit dressé d'après cette longue suite d'observations, des Tables lunaires qui n'ont point encore été publiées, quoiqu'imprimées en partie depuis plus de vingt ans. C'est moins à sa négligence ou à la lenteur de l'âge qu'il faut attribuer ce délai, qu'à la difficulté de se contenter qui s'accroît avec l'âge, ou plutôt avec le sçavoir; mais on espère que M. Bradley son ami & son successeur à Greenwich, déjà célèbre par ses observations sur l'Aberration des Fixes, voudra bien y mettre la dernière main, & nous faire part de ce nouveau trésor astronomique.

M. Halley fut reçu dans l'Académie des Sciences en qualité d'Associé étranger au mois d'Août 1729, à la place de M. Bianchini.

Une forte constitution & une santé ferme secondoient parfaitement la marche vigoureuse de son esprit, & se soutinrent jusque vers la fin de sa vie.¹ Agé de quatre-vingt-deux ou trois ans il fut attaqué d'une espèce de paralysie, qui ne fit cependant que diminuer un peu son travail & rendre ses observations moins fréquentes;² sa mémoire qui étoit des plus heureuses, ne paroissoit pas en avoir reçu la moindre atteinte. Il vint toujours à Londres une fois la semaine, selon sa coûtume, pour y dîner avec ses amis, jusqu'à environ une année avant sa mort; mais sa maladie augmentant par degrés insensibles, il cessa de vivre comme par la seule extinction de ses forces & presque sans accident, le 25 de Janvier dernier, au commencement de sa quatre-vingt-sixième année.

Il avoit toujours fait grand cas de la Géométrie des Anciens, de leur manière rigoureuse de démontrer, & de l'élégance de leurs constructions; en cela, comme dans tout le reste, digne défenseur des sentimens de Newton. C'est dans cet esprit qu'il donna en 1717 une traduction latine des huit livres des *Coniques* d'Apollonius & des deux livres de Sérénus, *De la section du Cylindre & du Cone*, d'après un Manuscrit Arabe. Il n'estimoit pas moins l'Astronomie ancienne; il a fait revivre le *Saros* des Chaldéens, qui est une période de 223 mois lunaires synodiques, c'est-à-dire, d'environ 29 jours & demi chacun, par le moyen de laquelle on peut très-facilement prédire les retours & les Éclipses de Lune & de Soleil, entre les limites d'une demi-heure d'erreur.

Il appliquoit le calcul avec beaucoup d'adresse aux Problèmes physico-mathématiques. La Planète de Vénus paroît quelquefois en plein jour & en présence du Soleil, & ce qui est à remarquer, c'est

¹ See p. 12, above.

² See p. 13, above.

que cela n'arrive que lorsqu'elle est presque entre le Soleil & nous, & que l'hémisphère qu'elle nous présente, n'est éclairé que dans une assez petite partie: M. Halley démontra en 1716 que, toutes compensations faites de sa distance à la Terre & de la grandeur de cette partie visible, Vénus ne doit jamais nous paroître si brillante que lorsque son croissant lumineux n'occupe que le quart de son disque.

Il nous a aussi donné d'excellens morceaux sur le Baromètre & sur ses usages, sur les Marées, sur quelques Météores extraordinaires, sur l'art de vivre sous l'eau, ou sur la manière de faire descendre l'air que nous respirons jusqu'au fond de la mer, & il a mis lui-même son art en pratique. Le détail de tout ce qu'il vit & qu'il sentit dans cette épreuve, les différentes couleurs & les reflets de la lumière filtrée à travers cette immense quantité d'eau, offrent un spectacle curieux, & dont M. Newton a bien sçu faire usage dans son Optique.

Son génie le portoit à des systèmes hardis. Ce globe d'Aimant, cette petite Terre que nous avons dit qu'il imaginoit au centre du globe creux de la grande, pour donner raison des variations magnétiques, il l'emploie encore à l'explication de l'Aurore Boréale; car il suppose que l'intervalle compris entre la surface concave de l'un & la surface convexe de l'autre, est rempli d'une vapeur légère & lumineuse, qui venant à s'échapper en certains temps par les Poles du globe terrestre, produit toutes les apparences de ce phénomène. L'explication physique du Déluge universel par la rencontre d'une Comète dont la queue ou l'atmosphère aqueuse inonda notre Globe, & qui a été si bien mise en œuvre par M. Wiston¹ dans sa *Nouvelle Théorie de la Terre*, appartient primitivement à M. Halley, comme il paroît par les pièces qu'il remit sur ce sujet à la Société Royale dès l'année 1694, & qui ont été imprimées depuis par ordre de cette Compagnie en 1724. Il admettoit l'espace réel & sans bornes, l'attraction mutuelle des corps, & en conséquence il croyoit les Étoiles en nombre infini, parce que si elles n'étoient balancées de toutes parts & à l'infini par des tendances réciproques, elles se réuniroient toutes incessamment autour d'un centre commun. Dans un autre de ses Mémoires il propose une manière de remonter jusqu'à la première époque du Monde, par des observations réitérées pendant plusieurs siècles sur la salure de la mer, qui va, selon lui, en augmentant, à cause des nouveaux sels que les fleuves détachent des terres & qu'ils y portent sans cesse. En un mot, M. Halley ne craignoit pas de heurter les opinions communes, & ne se faisoit pas un scrupule d'imaginer, de proposer des hypothèses, & de conjecturer

¹ Whiston, Wm.: *A New Theory of the Earth*, London, 1696.

d'après ses observations & ses idées particulières. C'est à cette hardiesse, souvent heureuse, parce qu'elle étoit toujours éclairée, que nous devons l'admirable théorie des variations de la Boussole, & la plupart des autres découvertes dont il a enrichi le Monde sçavant & la Société.

Avec un esprit vif & pénétrant il avoit encore une imagination féconde & fleurie, il étoit Poëte. Pendant qu'il travailloit à l'édition des Principes de Newton, il ne put être le promoteur de tant de sublimes merveilles & les voir passer sous ses yeux, sans entrer dans une espèce d'enthousiasme qui éclata par une cinquantaine de vers latins où il les décrit. Tycho-Brahé se sentit animé d'une semblable verve poétique, à la vûe de l'instrument avec lequel Copernic avoit fait ses observations, & changé la face du ciel. Les vers de Tycho-Brahé furent gravez sur l'instrument qui les lui avoit inspirez, ceux de M. Halley ont été mis à la tête du livre immortel qui en étoit l'objet, & ils méritent par eux-mêmes d'en partager l'immortalité.

Il possédoit tous les talens nécessaires pour plaire aux Princes qui veulent s'instruire, une grande étendue de connoissances & beaucoup de présence d'esprit; ses réponses étoient promptes, & cependant mesurées & judicieuses, toujours sincères. Lorsque le Czar Pierre le Grand vint en Angleterre, il y vit M. Halley, & il le trouva digne de la réputation qui le lui avoit annoncé.¹ Il l'interrogea sur la flotte qu'il avoit dessein de former, sur les Sciences & les Arts qu'il vouloit introduire dans ses États, & sur mille autres sujets que sa vaste curiosité embrassoit. Il fut si content de ses réponses & de son entretien, qu'il l'admit familièrement à sa table, qu'il en fit son ami; car on peut hasarder ce terme avec un Prince de ce caractère, assez grand homme pour ne distinguer les hommes que par leur mérite.

Mais M. Halley rassembloit encore plus de qualités essentielles pour se faire aimer de ses égaux. La première de toutes, il les aimoit; naturellement plein de feu, son esprit & son cœur se montroient animez en leur présence d'une chaleur que le seul plaisir de les voir sembloit faire naître. Il étoit franc & décidé dans ses procédés, équitable dans ses jugemens, égal & réglé dans ses mœurs, doux & affable, toujours prêt à se communiquer, désintéressé. Il a ouvert le chemin des richesses par tout ce qu'il a fait en faveur de la Navigation, & il a ajoûté à cette gloire celle de n'avoir jamais rien fait pour s'enrichir. Il a vécu & il est mort dans cette médiocrité si vantée par les Philosophes, & dont le choix libre suppose en effet tant de ressource dans l'ame & de lumière dans l'esprit. Quand le Roi

¹ Cf. p. 7, above.

Guillaume ordonna le grand renouvellement des Espèces d'Angleterre en 1696, & qu'il fit construire exprès cinq Monnoies hors de Londres, M. Halley fut nommé Contrôleur de celle de Chester, soit à titre de grace, soit parce qu'on le jugeoit capable d'en bien remplir les fonctions. C'est le seul emploi de cette nature qu'il ait jamais eu ou voulu avoir, & qu'il ne conserva que pendant les deux années que dura la refonte.

Il étoit généreux, & sa générosité s'exerçoit même aux dépens d'une vanité dont les Sçavans ne sont pas plus exempts que les autres hommes, & qu'ils montrent peut-être plus aisément. Une grande lettre que j'ai vûe de lui par hasard il y a quinze à seize ans, & qu'il écrivoit à un Auteur qui ne lui étoit connu que de réputation, nous en fourniroit la preuve. Il y démêle avec autant de sagacité que de politesse, une erreur de calcul délicate où cet Auteur étoit tombé en traitant le point décisif d'une question d'Astronomie & de Physique. Je ne sçache pas cependant que M. Halley ait jamais rien donné au public de cette lettre, quoiqu'elle pût lui faire honneur; mais nous n'avons garde de dévoiler plus particulièrement un secret qui lui en fait encore davantage. La gloire d'autrui ne l'incommodoit pas, une émulation inquiète & jalouse n'avoit jamais eu d'accès dans son cœur; il ignoroit également ces préventions outrées en faveur d'une nation, injurieuses au reste du genre humain. Ami, compatriote & sectateur de Newton, il a parlé de Descartes avec respect; successeur de Wallis, il a sçu rendre justice à nos anciens Géomètres, & dans le préambule d'un excellent Mémoire d'Algèbre¹ qu'il lut à la Société Royale, il n'a fait nulle difficulté de reconnoître que Harriot, Oughtred & plusieurs autres, tant Anglois qu'étrangers, ce sont ses termes, ont puisé dans Viète tout ce qu'ils nous ont donné de meilleur en ce genre.

Enfin, des qualités si rares & si estimables étoient assaisonnées chez M. Halley d'un fond de gaieté que ses recherches abstraites, ni la vieillesse, ni la paralysie dont il fut attaqué quelques années avant sa mort, ne purent jamais altérer; & cette heureuse disposition qu'il tenoit de la Nature, fut d'autant plus entière, qu'elle marcha toujours à la suite du contentement intérieur qui naît de la vertu.

Il avoit eu de son mariage un fils & deux filles; le fils est mort long-temps avant lui, les filles vivent encore, l'une dans le célibat, l'autre mariée pour la seconde fois, & toutes deux fort estimées.

¹ This refers to the paper in *Phil. Trans.*, vol. xviii (1694), 'Methodus nova accurata et facilis inveniendi Radices Æquationum'.



EDMOND HALLEY

*From an engraving by G. White of the original portrait
by Sir Godfrey Kneller*

III

CHRONOLOGICAL LISTS OF HALLEY'S CORRESPONDENCE

PRINTED AND UNPRINTED, SO FAR AS TRACED

The Lists of Correspondence here given are as complete as possible, but it is fully realized that other letters must exist. Every effort has been made to trace letters written by Halley, and whilst evidence of the existence of all those cited below has been obtained, it has not always been possible to find the originals.

Where original letters have been traced the location is given. In the case of letters already printed, the place where printed will be found quoted in the 'Remarks' column, where also are certain notes which may help in the tracing of the missing letters. It will be observed that there are no letters from Halley later than 1729.

The following abbreviations are used:

- B.M. The British Museum.
- C.(T.) Cambridge, Trinity College Library.
- C.(U.) Cambridge, University Library.
- M. The Earl of Macclesfield's Collection.
- O.(B.) Oxford, Bodleian Library.
- O.(R.) Oxford, Radcliffe Observatory.
- P.R.O. Public Record Office, London.
- R.O.(G.) Royal Observatory, Greenwich.
- R.S. The Royal Society.

An asterisk denotes that the letter is printed in full in the present work.

(a) LETTERS FROM HALLEY

	Date.	To.	Location.	Remarks.
*1674/5.	March 10.	Flamsteed, J.	C.(T.)	This and other letters are referred to in <i>The Observatory</i> , vol. xlv, p. 293, 1922.
1676.	July 1. [July 8 (?)]	Boucher, Ch. Oldenburg, H.	.. M. & R.S.	Cf. reply to Halley. Printed in Rigaud, S. P. & S. J. [Editors]: <i>Correspondence of Scientific Men</i> , vol. i, pp. 226-36, Oxford, 1841. (Signed 'Edmond Halley.') No date, but Oldenburg's endorsement is 'Rec. July 10, 76.'
	July 11.	Oldenburg.	M.	<i>Ibid.</i> , vol. i, pp. 236-7. (Signed: 'Edmond Halley.')

CHRONOLOGICAL LIST OF

	<i>Date.</i>	<i>To.</i>	<i>Location.</i>	<i>Remarks.</i>
	1676. Aug. 8.	Oldenburg.	R.S.	<i>Ibid.</i> , vol. i, pp. 241-3. (Signed: 'Edm. Halley.') Upon this Oldenburg has written, 'Rec. Aug. 9, 76: ans. Aug. 10, 76.' Halley embarked for St. Helena in the following November (<i>ibid.</i> , p. 243).
	1677. [c. Oct. 20.]	Flamsteed.	..	Mentioned in Bailly, Francis: <i>Account of Flamsteed</i> , pp. 667-8.
*	Nov. 22.	Moore, Sir J.	..	Printed in Hooke, R.: <i>Lectures and Collections</i> , 1678, pp. 75-7.
*1678.	Nov. 11.	Hevelius, J.	B.M.	Printed in Olhoff, J. E.: <i>Excerpta ex Literis . . . ad J. Hevelium</i> , pp. 182-4, Gedani, 1683.
	1679. [May-June (?)]	Moore.	..	Mentioned in Birch, T.: <i>Hist. Roy. Soc.</i> , vol. iii, pp. 488, 499 (2 letters).
*	June 7.	Flamsteed.	..	'Fair copy' in Flamsteed MSS., Greenwich.
*	July 8/18.	Hevelius.	..	Printed in Hevelius: <i>Annus Climactericus</i> , 1685, pp. 101-2.
*	[Oct. (?)]	Olhoff, J. E.		A copy of this letter is in the Bodleian Library (Rigaud MSS.). The original is in the collection of the Historical Society of Pennsylvania.
*	Nov. 16.	Aubrey, J.	O.(B.)	
*1680/1.	Jan. 15.	Hooke, R.	..	Printed in part in Weld, C. R.: <i>Hist. Roy. Soc.</i> , vol. i, pp. 267-8, London, 1848. 'Fair copy' in Royal Society Letter Book.
*1681.	May 19/29.	Hooke.	R.S.	
*	Nov. 5/15.	Hevelius.		A transcript of this letter is in the Bibliothèque Nationale.
*1682.	April 7/17.	Hevelius.	..	(As above.)
*1685.	[Sept.]	Sturm, J. C.	..	A 'fair copy' of this letter is in the Royal Society Letter Book.
*1685/6.	March 2.	Leeuwenhoek, A. v.	..	(As above.)
*1686.	March 27.	Molyneux, W.	R.S.	
*	March 27.	Ashe, St. G.	..	A 'fair copy' of this letter is in the Royal Society Letter Book.
*	[May (?)]	Sturm.	..	(As above.)
*	[May 15.]	Leeuwenhoek.	..	A 'fair copy' of this letter is in the Royal Society Letter Book.
	May 22.	Newton.	R.S.	Printed in Birch: <i>Hist. Roy. Soc.</i> , vol. iv, p. 484; <i>Biog. Brit.</i> , vol. v, p. 3225; Rigaud, S. P.: <i>Historical Essay on the First Publication of Newton's 'Principia'</i> , App. iv, pp. 25-6, Oxford, 1838; Brewster: <i>Life of Newton</i> (ed. 1855), vol. i, App. viii, pp. 438-9; <i>ibid.</i> , App. xii, p. 478; Ball, W. W. Rouse: <i>An Essay on Newton's 'Principia'</i> , London, 1893, pp. 154-5.

	Date.	To.	Location.	Remarks.
*1686.	May 27.	Molyneux.	R.S.	Printed in Brewster, App. xii, pp. 472-3; Ball, p. 156.
	June 7.	Newton.	C.(U.)	
	[ante June 29.]	Caswell, J.	..	See Gunther, R. T.: <i>The Philosophical Society</i> , p. 186, Oxford, 1925.
	June 29.	Newton.	C.(U.)	Printed in Rigaud, App. vi, pp. 35-9; Brewster, App. viii, pp. 446-9; Ball, pp. 162-4.
*	July 9.	Wallis, J.	C.(T.)	
*	July 9.	Caswell.	C.(T.)	
*	July 19.	Reiselius, S.	R.S.	
	Oct. 14.	Newton.	C.(U.)	Printed in Brewster, App. xii, pp. 473-4; Ball, pp. 167-8.
*	Nov. 13.	Wallis.	C.(T.)	
*	[Nov.]	Hevelius.	..	A 'fair copy' of this letter is in the Royal Society Letter Book.
*	Dec. 11.	Wallis.	C.(T.)	
*	Dec. 21.	(?)	..	A 'fair copy' of this letter is in the Royal Society Letter Book.
*1686/7.	Jan. 1.	Wallis.	C.(T.)	
*	[c. Jan. (?)]	Valvasor, J. W.	..	A 'fair copy' of this letter is in the Royal Society Letter Book.
*	Feb. 15.	Wallis.	O.(B.)	
	Feb. 24.	Newton.	C.(U.)	Printed in Brewster, App. xii, pp. 474-5; Ball, pp. 170-1.
	March 7.	Newton.	C.(U.)	Printed in Brewster, App. xii, pp. 475-6; Ball, pp. 171-2.
	March 14.	Newton.	C.(U.)	Printed in Brewster, App. xii, pp. 476-7; Ball, p. 172.
1687.	April 5.	Newton.	C.(U.)	Printed in Brewster, App. xii, pp. 477-8; Ball, p. 173.
*	April 9.	Wallis.	O.(B.)	
	[ante May 20.]	Wallis.	..	See Gunther, <i>The Philosophical Society</i> , p. 204.
*	June 25.	Wallis.	C.(T.)	
*	[June or July.]	King James II.	C.(U.)	Printed in 1687 (folio); and part printed in <i>Phil. Trans.</i> , vol. xix, pp. 445-57. (Cf. Rigaud, <i>Historical Essay on the First Publication of Sir Isaac Newton's 'Principia'</i> , 1838, pp. 87-8.)
	July 5.	Newton.	C.(U.)	Printed in Brewster, vol. ii, p. 111; Ball, pp. 173-4.
1690/1.	Feb. 5.	Ashe, St. G.	..	Known by Ashe's reference only.
*1691.	June 22.	Hill, A.	..	Printed in <i>Familiar Letters which passed between Abraham Hill, Esq. . . . and several eminent and ingenious persons of the last century . . .</i> (T. Astle), London, 1767, pp. 136-7.
1692/3.	Jan. 20.	Houghton, J.	O.(B.)	Printed in <i>A Collection for Improvement of Husbandry and Trade</i> , No. 25 (ed. by J. Houghton), 1692.

CHRONOLOGICAL LIST OF

	<i>Date.</i>	<i>To.</i>	<i>Location.</i>	<i>Remarks.</i>
*1692/3.	[March (?)]	Neumann, C.	..	A 'fair copy' of this letter is in the Royal Society Letter Book.
*1694.	June 12.	Sloane, H.	B.M.	
*1694/5.	March 9.	Sharp, A.	..	Printed in Cudworth: <i>Life . . . of Abraham Sharp</i> , 1889, p. 25.
*1695.	Sept. 7.	Newton.	C.(U.)	
*	Sept. 28.	Newton.	C.(U.)	
*	Oct. . . .	Newton.	C.(U.)	
*	Oct. 15.	Newton.	C.(U.)	
*	Oct. 21.	Newton.	C.(U.)	
*1696.	[n.d.]	Newton.	C.(U.)	
*	Oct. 12.	Sloane.	R.S.	
*	Oct. 26.	Sloane.	R.S.	Printed in <i>Phil. Trans.</i> , vol. xix, p. 316.
*	Nov. 2.	Sloane.	R.S.	
*	Nov. 25.	Sloane.	R.S.	
	Nov. 28.	Newton.	..	<i>Catalogue of Portsmouth Collection</i> , p. 36. (Citation only.)
1696/7.	Feb. 13.	Newton.	..	(As above.)
*1697.	April 5.	Sloane.	..	A 'fair copy' of this letter is in the Royal Society Letter Book.
	May.	[Sloane (?)]	..	Printed in <i>Phil. Trans.</i> , vol. xix, pp. 570-2.
	June 7.	[Sloane (?)]	..	Printed in <i>Phil. Trans.</i> , vol. xix, pp. 582-4.
	July 21.	Molyneux.	..	<i>Catalogue of Portsmouth Collection</i> , p. 36. (Citation only.)
	July 31.	Molyneux.	..	(As above.)
	Aug. 2.	Newton.	..	(As above; also Brewster, vol. ii, p. 195.)
	Aug. 25.	Molyneux.	..	(As above.)
*	Oct. 25.	Sloane.	R.S.	Printed in part in <i>Phil. Trans.</i> , vol. xix, p. 784.
	Dec. 30.	Newton.	..	<i>Catalogue of Portsmouth Collection</i> —quoted from by Brewster, vol. ii, pp. 195-6.
*1698.	Nov. 1.	Burchett, J.	P.R.O.	
*	Nov. 4.	”	”	
*	Nov. 28.	”	”	
*	Dec. 19.	”	”	
*1699.	April 4.	”	”	
*	June 23.	”	”	
*	June 29.	”	”	
*	July 4.	”	”	
*	July 8.	”	”	
*	Aug. 23.	”	”	
*	Sept. 4.	”	”	
*	Sept. 12.	”	”	
*	[n.d.]	”	”	
*	Sept. 21.	”	”	
*	Sept. 26.	”	”	
*	Sept. 27.	”	”	
*	Oct. 28.	”	”	
*1700.	March 30.	”	”	
*	July 8.	”	”	

	Date.	To.	Location.	Remarks.
*1700.	Aug. 27.	Burchett, J.	P.R.O.	
*	Sept. 2.	"	"	
*	Sept. 7.	"	"	
*	Oct. 26.	Sloane.	B.M.	
*1701.	April 23.	Burchett.	P.R.O.	
*	April 26.	"	"	
*	[n.d.]	"	"	
*	[n.d.]	Gregory, D.	..	<i>Ante</i> May 21. See Rigaud: <i>Historical Essay</i> , App. xxiii, p. 79, citing 'Memoranda of Dr. David Gregory, Oxon. 21 May 1701', which merely mentions a letter from Halley. The letter itself is lost.
*	May 31.	Burchett.	P.R.O.	
*	June 4.	"	"	
*	June 11.	"	"	
*	June 18.	"	"	
*	July 29.	"	"	
*	Aug. 23.	"	"	
*	Sept. 13.	"	"	
*	Oct. 2.	"	"	
*1701/2.	Jan. 27.	Southwell, Sir R.	R.S.	
*	Feb. 18.	Burchett.	P.R.O.	
	1704/5.	Sherwin.	M.	
*1705.	April 23.	Sharp, A.	..	Printed in Cudworth: <i>Life . . . of Abraham Sharp</i> , 1889, p. 23.
*	June 23.	Charlett, A.	O.(B.)	
*1705/6.	March 16.	Hudson, T.	O.(B.)	
*1708/9.	Feb. 7.	Gale, R.	O.(B.)	
*1710.	May 14.	Sloane.	B.M.	
*1711.	June 23.	Flamsteed.	R.O.(G.)	Printed in Baily, Francis: <i>Account of Flamsteed</i> , 1835, p. 293.
*1712.	[n.d.]	Sloane.	B.M.	
	1714.	Nelson, R.	..	Printed in Brokesby, F.: <i>Life of Dodwell</i> , 1715, pp. 611-38.
*1715.	Oct. 3.	Keill, J.	C.(T.)	Printed in Edleston, J.: <i>Correspondence of Sir Isaac Newton and Professor Cotes</i> , 1850, pp. 184-5.
*1716.	June 7.	Flamsteed.	R.O.(G.)	
*	Sept. 6.	Pound, J.	O.(R.)	Printed in <i>Miscellaneous Works and Correspondence of the Rev. James Bradley, D.D., F.R.S.</i> , Rigaud, 1832, p. iii.
*1721.	May 16.	Anstis, J.	B.M.	
*1722.	July 9.	Sloane.	B.M.	
*	Nov. 7.	Sloane.	B.M.	
*1724/5.	Feb. 16.	Newton.	C.(U.)	
*	(?)	[n.d.]	C.(U.)	
*1727.	July 1.	Sloane.	B.M.	
*1729.	Sept. 1.	Sloane.	B.M.	

CHRONOLOGICAL, LIST OF

(b) LETTERS TO HALLEY

	Date.	From.	Location.	Remarks.
1676/7.	March 10.	Boucher, Ch.	..	A 'fair copy' of this letter is in the Flamsteed MSS., Greenwich.
1680/1.	March 1.	Hooke, R.	R.S.	
*1681.	(Spring ?)	Hevelius, J.	R.S.	
*1681/2.	Jan. 9.	Hevelius.	R.S.	
*1682.	[n.d.]	Hevelius.	..	Transcript in Bibl. Nat., Paris.
	Nov. 21.	Flamsteed.	R.O.(G.)	
1685.	June 12.	Smith, T.	O.(B.)	
1685/6.	Feb. 13.	Newton.	R.S.	
	March 10.	Justel, H.	R.S.	
	March.	Justel (3 letters).	R.S.	
1686.	March 27.	Sturm, J. C.	..	Copy in Letter Book, R.S.
	April 1.	Justel.	R.S.	
	April 8.	Molyneux, W.	R.S.	Printed in Birch: <i>Hist. Roy. Soc.</i> , vol. iv, pp. 475-9.
	April 26.	Justel.	R.S.	
	April 27.	Justel.	R.S.	
	April.	Justel.	R.S.	
	May 15.	Molyneux.	R.S.	
	May 27.	Newton.	..	Printed in Ball, W. W. Rouse: <i>An Essay on Newton's 'Principia'</i> , pp. 155-6.
	May.	Justel (2 letters).	R.S.	
	June 19.	Molyneux.	R.S.	
	June 20.	Newton.	R.S.	Printed in Rigaud, S. P.: <i>Historical Essay on Newton's 'Principia'</i> , App. v, pp. 26-35, Oxford, 1838; Brewster: <i>Life of Newton</i> (ed. 1855), vol. i, App. viii, pp. 439-45; Ball: <i>An Essay on Newton's 'Principia'</i> , pp. 156-62.
	June 29	Caswell, J.	R.S.	See Gunther, R. T.: <i>The Philosophical Society</i> , p. 180, note, Oxford, 1925.
	June.	Justel.	R.S.	
	July 2.	Wallis, J.	R.S.	<i>Ibid.</i> , p. 186, note.
	July 14.	Newton.	R.S.	Printed in Rigaud, App. vii, pp. 39-41; Brewster, vol. i, App. viii, pp. 449-50; Ball, pp. 164-5.
	July 20.	Molyneux.	R.S.	
	July 27.	Newton.	R.S.	Printed in Rigaud, App. viii, pp. 41-4; Brewster, vol. i, App. viii, pp. 450-2; Ball, pp. 165-7.
	Aug. 20.	Newton.	..	Cf. Edleston, J.: <i>Correspondence of Sir Isaac Newton and Professor Cotes</i> (London, 1850), pp. xxx, lvii. (This letter is lost.)
	Oct. 8.	Reisel, S.	R.S.	
	Oct. 18.	Newton.	R.S.	Printed in Rigaud, App. ix, pp. 45-7; Brewster, vol. i, App. viii, pp. 453-4; Ball, pp. 168-9.
	Nov. 8.	Wallis, J.	R.S.	Cf. Gunther, R. T.: <i>The Philosophical Society</i> , p. 187, note.

	<i>Date.</i>	<i>From.</i>	<i>Location.</i>	<i>Remarks.</i>
1686.	Nov. 25.	Wallis.	R.S.	Printed, <i>ibid.</i> , pp. 188-91.
	Nov.	Justel.	R.S.	
	Dec. 14.	Wallis.	R.S.	Printed, <i>ibid.</i> , pp. 193-4.
	Dec. [& n.d.]	Justel (2 letters).	R.S.	
1686/7.	Jan. 14.	Wallis.	..	Printed, <i>ibid.</i> , pp. 197-8.
	Jan.	Justel (4 letters).	R.S.	
	Jan. 17.	Wallis.	O.(B.)	
	Feb. 13.	Newton.	R.S.	Printed in Rigaud, App. x, pp. 47-8; Brewster, vol. i, App. viii, p. 455; Ball, pp. 169-70.
	Feb.	Justel (2 letters).	R.S.	
	March 1.	Newton.	R.S.	Printed in Rigaud, App. xi, pp. 48-9; Brewster, vol. i, App. viii, p. 456; Ball, p. 171.
	March 4.	Wallis.	O.(B.)	
	[n.d.]	Justel (3 letters).	R.S.	
1687.	April 14.	Eimmart, G. C.	R.S.	
	April 26.	Wallis.	O.(B.)	
	April.	Justel.	R.S.	
	June 8.	Hayley, W.	..	Copy in Letter Book, R.S.
	June.	Justel (4 letters).	R.S.	
1687/8.	Jan.	Justel (3 letters).	R.S.	
	Feb. 2.	Rooke, W.	..	Copy in Letter Book, R.S.
	Feb. 24.	Hayley.	..	" " "
	March 1.	Sturm.	..	" " "
1688	April.	Justel (2 letters).	R.S.	
	May.	Justel (2 letters).	R.S.	
	June.	Justel (3 letters).	R.S.	
	June 12.	Musgrave, W.	..	Copy in Letter Book, R.S.
	July.	Justel.	R.S.	
	Aug.	Justel.	R.S.	
	Oct.	Justel.	R.S.	
	Nov.	Justel.	R.S.	
1689.	May.	Justel.	R.S.	
1690.	May.	Justel (2 letters).	R.S.	
[n.d.	n.d.]	Justel (12 letters).	R.S.	
1690.	Oct. 8.	Molyneux.	R.S.	
1691.	May 1.	Reisel, S.	..	Copy in Letter Book, R.S.
	June 18/28 & n.d.	Ashe, St. G.	..	" " "
1692.	April 4.	Craige, J.	..	" " "
1692/3.	Jan. 11.	Gregory.	R.S.	
1693/4.	Jan. 7.	Rooke, W.	R.S.	
	Feb. 8.	Rooke.	R.S.	
1694/5.	March 1.	Neumann, C.	R.S.	
1695.	Aug. 31.	Aubrey.	R.S.	
	Oct. 1.	Newton.	..	See Halley's reply, Oct. 1695.
*	Oct. 17.	Newton.	C.(U.)	
	Nov. 11.	Wallis.	R.S.	
	Nov. 26.	Wallis.	R.S.	
	Dec. 3.	Wallis.	R.S.	
1695/6.	March 14.	Newton.	M.	
	March 16.	Pulleyn, O.	R.S.	
1696.	July 3.	Allen, B.	R.S.	

LIST OF HALLEY'S CORRESPONDENCE

	<i>Date.</i>	<i>From.</i>	<i>Location.</i>	<i>Remarks.</i>
1696/7.	Feb. 9.	Hyde, T.	R.S.	
	Feb. 11.	Newton.	M.	
1701.	July 9.	Cassini, J. D.	R.S.	
1702.	May 23.	Wallis.	R.S.	
*1703.	July 14.	Leibniz.	..	
1705.	Sept. 17.	Smith, T.	O.(B.)	
*	Dec. 8.	Leibniz.	..	
1711 (?)	..	Cotes, R.	..	'Exact date uncertain.' See Edleston, <i>Correspondence of Sir Isaac Newton and Professor Cotes</i> , pp. 204-5, London, 1850.
*1712.	Nov. 23.	Bernoulli.	B.M.	
1714.	July 9.	Pound, J.	R.S.	
	Aug. 17.	Derham, W.	R.S.	
1714/15.	Feb. 2.	Machin, J.	M.	
1716.	July 16.	Machin.	M.	
1717/18.	March 16.	Conduitt, J.	R.S.	
1718.	Oct. 21.	Taylor, B.	B.M.	
1720.	Oct. 14.	Whiston, W.	R.S.	
	Oct. 16.	Hill, T.	R.S.	
	Dec. 9.	Maclaurin, C.	R.S.	
1722.	Aug. 16.	Candler, Barth.	R.S.	
* (?)	[n.d.]	Newton.	..	A copy or draft of this letter is preserved in the Library of the University of Cambridge.
(?)	(?)	Pyke, Isaac.	R.S.	
1724.	Dec. 3.	Newton.	M.	
*1724/5.	March 1.	Newton.	C.(U.)	
1725.	June 7.	Du Val, V. J.	R.S.	
	Sept. 12.	Saunderson, W.	R.S.	
1728/9.	Jan.	Bradley, J.	R.S.	
1732.	May 25.	Logan, J.	R.S.	
1736.	Oct. 28.	Wright, T.	R.S.	
1738.	May.	La Condamine	M.	
1739.	Oct. 12.	Bevis, J.	R.O.(G.)	
	Oct. 26.	Nicholas, Wm.	R.O.(G.)	
	Nov. 21.	Burchett, J.	R.O.(G.)	
	Dec. 21.	Miller, Philip.	R.O.(G.)	

IV
LETTERS OF HALLEY

These letters are printed in the order of their dates. The original spelling has been followed as far as possible. The footnotes amplify the remarks in the Preface and the particulars given in the foregoing Chronological List.

I. To FLAMSTEED.¹ 1674/5.

Oxford Mart. 10. 1674/5.

Sr.

The veneration I have for all who think Astronomy deserves their cares and are not dismay'd at the laborious and chargeable trouble of making celestial observations, was the chief motive which induced me to give you the trouble of these lines, which I thought I might with the more confidence do considering how free and communicative a genius you expressed in your satisfactory answer to the request of my very good friend Mr. Charles Bouchar. Yet I dare not promise to myself the like favour from you on any other grounds than that I am a true honourer of your worth and a real well willer to Astronomy and all its followers. You may perhaps have expected that Mr. Bouchar should have returned you thanks for the great trouble he put you to by his letter; he doubtless would have done it had not his occasion called him soon after the receipt of yours to take a voyage to Jamaica where he will not neglect to make what observation he can but especially those of Mercury for which that horizon will be most convenient; since his departure I have been wholly destitute of a coadjutor in my studies yet whensoever the heavens favour us with serenity I omit not to make what observations I may of the planets, being reasonably well provided in instruments in which I can confide to one minute without error by means of the telescopicall sights and a skrew [?] for the subdivision by my Quadrant so furnished I have observed $\bar{\eta}$ and ζ to differ considerably from Heckers Ephemeris. which makes $\bar{\eta}$ at least 20' in consequence to his visible or true place but ζ about 8' in antecedens; nor doth Streets Caroline Tables represent $\bar{\eta}$ much better, for in the observations of Hevelius Aug 16/26 1670. Philos. Transac. Num. 65 pag. 2089. $\bar{\eta}$ was seen in $10^{\circ} 5^{\circ} 15' 25''$ as $\ast\gamma$ with south Latitude. $1^{\circ} 54' 11''$ but by the Caroline Calculation $\bar{\eta}$ was in $10^{\circ} 5^{\circ} 32' 32''$ diff. $17' 7''$ in the same latitude precisely. And

¹ Reproduced from photostat of the original in the Library of Trinity College, Cambridge, which is mutilated in parts.

according to Heckers Ephemeris he was in $4^{\circ} 11'$ of æ Lat. Aus. 1. 53. $19'$ † obser: whence so great differences should arise is hard to conjecture, however future observation will declare whether it be the fault of his eccentricity or Middle motion. If you have observed anything of the like nature in h I beg you would communicate it. Your Observations of z published Philos. Trans. Num. 82. make z 13 in consequence to Heckers Eph. and those Num. 87. diff. $8'$ the same way agreeing with mine precisely, æ I find little fault with yet about his opposition to the sun he was near upon $5'$ in conseq. to Heckers place; Sr. if you are pleased to send me any of those most accurate observations you do daily make wherby I may confirme mine I shall ever own it as a signal obligation, and shall endeavour to return my gratitude by making any observation you shall desire me. I request that you would send me Cassini's supposition of the Hight of the Atmosphere and the horizontal refraction, and what other Hypothesis he hath of the doctrine of Refractions . . .¹ experiment hath been made to confirm those quantities, to . . . seem to vary from any certain rule and to be subject to the accidents of the heat and cold which may considerably alter the density and altitude of the sphear of air and consequently alter the refractions made in it which seems to be confirmed by comparing the refractions of the sun with those of the fixt starrs observed by Tycho where the slower decrease of the sunns refrac. argues a greater hight of the Atmosphere as if the presence of the sunn did elevate the Air. which if so the after noon refractions would be greater than the mornings. and these uncertainties will make the place of z dubious to $2'$ or $3'$ in most observations that can be made in our climate. The late Eclipse of D Jan. 1. I observed at London with Mr. Street as follows. The precise beginning we saw not by reason we had not fitted our instruments soon enough, trusting to much to the calculation, but $\frac{2}{3}$ of a dig. were eclipsed when the upper limb of the moon was $11^{\circ} 39'$ high. i.e. $5^{\text{h}} 30\frac{1}{2}'$. the Immersion was when Pollux was high $27^{\circ} 15'$, $6^{\text{h}} 25\frac{1}{4}'$. Emersion alt. Pollux. $41^{\circ} 35'$, 7. 58. The just end when the moons Lower limb was $42^{\circ} 30'$ high the time $9^{\text{h}} 0\frac{1}{4}'$. whence the middle may be $7^{\text{h}} 12'$: viz. $8'$ to soon for the calculation of Mr. Stephenson. During the time of totall darkness the moon covered a starr of the 6 mag viz. 29 of II the immersion was 15° or 16° from the nadir toward the west when pollux was $33^{\circ} 5'$ high $7^{\text{h}} 3\frac{1}{8}'$ but the Emersion was 75° from the nadir to the west. Alt Pollux $37. 45. 7^{\text{h}} 42' 20''$: what you or your freends have observed of this Eclipse I entreat you to send me; one thing more I thought

¹ A small portion of the page here is worn away.

fit to signifie to you that is that the 13th and 20th of \mathfrak{H} are erroneously placed in Tichoes Cataloge the 13th is there in $14^{\circ} 19' \vee 0^{\circ} 57\frac{1}{2}$ Lat Bor but its distance from Ma. Pegasi is $16^{\circ} 36' 20''$ and from Cing. Andromedæ $28^{\circ} 4' 15''$. Hence I computed his place in $\vee 14. 19\frac{1}{2}$ with South Lat. $0^{\circ} 11' 50''$ and the 20 is in $22^{\circ} 12' \vee$ with $1. 38\frac{1}{2}$ Bor Lat. but by his distance from Lucida. $\vee^{is} 15^{\circ} 15' 5''$ and from os Ceti $19^{\circ} 44' 45''$ I computed its place in $22^{\circ} 11' 17''$ cum Lat. Aus. $1^{\circ} 40' 40''$. Moreover I am fully satisfied that Cor \mathfrak{M} is at least $5'$ in antecedence to his Tichonic place which is confirmed by Tichos own observations Who₄ Februarii mane obs. 1584 the distance of Cor \mathfrak{M} from Spica \mathfrak{M} $45. 51\frac{1}{2}$ and my observation was $45^{\circ} 50' 55''$ the same to sence wheras Ticho'es data require the distance to be $45^{\circ} 57'$. The appulse of the moon to $\delta 22^{\circ}$ March instant I intend diligently to observe, and hope you will doe the like. I beleive that about 9^h p.m. her northern horn will get near to cover him, which if it doe I will note the time of the immersion and emersion otherwise the time of the right line with the horns. I desire you would send me those observations made with you, whereto I shall subjoyn my own if the heavens favour us; these Sr. as a specimen of my Astronomical endeavours I send you, being ambitious of the honour of being known to you, of which if you shall deem me worthy I shall account my self exceedingly happy in the enjoyment of the acquaintance of so illustrious and deserving a person as your self.

I am Sr. Your and Urania's most humble Servant thð unknown.

Edm. Halley.

Queens coll. Oxon.

2. To SIR J. MOORE (?). 1677.¹

St. Helena, Novemb. 22. 1677.

Honored Sir,

You may with reason wonder that I should so long be negligent to write to your Worship, to give you an account of my proceedings since my departure from you, seeing that in the business I am now

¹ This letter is, exceptionally and on account of its importance, reprinted from Robert Hooke's *Lectures and Collections*, 1678 (pp. 75-7). Moore and Williamson were patrons of Halley and sponsored his expedition to St. Helena (cf. *Journal of Science*, vol. xvii, pp. 92-3, London, 1880). Furthermore, Birch seems clearly to write of this same letter, as having been addressed to Moore (cf. Birch, *Hist. Royal Soc.*, vol. iii, pp. 385, 387). Hooke's MS. Diary contains this entry: 'Sunday, Feb. 17, 1677/8. . . . missed Sr. J. More at Tower found him here. with Journalls Hallys letter. transcribed Hally.' The original letter has not, as yet, been found. It was probably signed: Edmond Halley, which was the latter's spelling at that time and later when signing in full. The present editor has never seen his complete signature in English in any other form than Edmond (cf. *Notes and Queries*, vol. cliii, 1927, pp. 124, 212, 410; vol. clv, p. 24).

engaged upon, the Honorable Sir *Joseph Williamson*, his Majesties Principal Secretary of State, and your self are my only Patrons: but I have not been unmindful of my Duty in this particular, only I delayed, that what I sent you might not be altogether inconsiderable. I hoped still that we might have some clear weather when the Sun came near our Zenith, that so I might give you an account that I had near hand finished the Catalogue of the Southern Stars, which is my principal concern; but such hath been my ill fortune, that the Horizon of this Island is almost always covered with a Cloud, which sometimes for some weeks together hath hid the Stars from us, and when it is clear, is of so small continuance, that we cannot take any any number of Observations at once; so that now, when I expected to be returning, I have not finished above half my intended work; and almost despair to accomplish what you ought to expect from me. I will yet try two or three months more, and if it continue in the same constitution, I shall then, I hope be excusable if in that time I cannot make an end. However it will be a great grief to be so far frustrated in my first undertaking: I have notwithstanding had the opportunity of observing the ingress and egress of ♀ on the ☉, which compared with the like Observations made in *England*, will give a demonstration of the Suns Parallax, which hitherto was never proved, but by probable arguments. Likewise I have seen those two Eclipses, one of the Sun, the other of the Moon in *May* last, both which I send you, but the *mighty winds, and extraordinary swift motion of the Clouds* hindred the exactness of the Observations. That of the Moon may help for the difference of our Meridians, which is about 7 degrees to the Westwards of *London*: but it may more curiously be found by *Mercury sub Sole*. There are three Stars of the first Magnitude that never appear in *England*, but none near the South Pole of any brightness, except one of the third Magnitude, which is about ten degrees distant from it. The two Nubeculæ called by the Saylor's the *Magellanick* Clouds, are both of them exactly like the whiteness of the milky way lying within the Antartick Circle; they are small, and in the Moon shine, scarce perceptible; yet in the dark the bigger is very notable. I need not relate unto you the temperature of the Weather for heat and cold here in the Torrid Zone, you your self having long since had experience of a Latitude little different: only this I shall certifie you, that ever since I came to this Island, we have had no weather that is hotter than the Summer of *England* is ordinarily. Mr. *Clark* is a person wonderfully assistant to me, in whose company all the good fortune I have had this Voyage consisteth, to me all other things having been cross:

nevertheless I despair not of his Honors and your Worships favour, which alone is sufficient to encourage me to bear with patience these disappointments, and expect some fitter opportunity.

I am your Worships most obliged Servant, and true Honorer,
Edmund Halley.

3. To HEVELIUS.¹ 1678.

Præclariss: Amplissimoque viro Johanni Hevelio Consuli Gedaniensi, Astronomorum facile principi. S.P.

Nudius tertius est, Vir Cl. ex quo literas tuas 13/23 Augusti datas mecum communicavit amicus meus singularis Dm. Flamsteedius, ex quibus non ingratis tibi futuras observationes meas stellarum prope polum Antarcticum lucentium intellexi; Catalogum meum paucos ante dies editum ad te mitto, quem, si concessa fuerit commoda aliqua transmittendi opportunitas, citius in manus dedissem vestras; lætatus admodum hac occasione tanti viri amicitias mihi conciliari posse:

Honores a te mihi designatos, labores meos quales quales tuorum monumentis adjungendo, gratissime habeo; vereor tamen ne hæc cœpta mea juvenilia, non accurata satis apud Judicem adeo oculatum videantur, nec digna, quæ exquisito illo Catalogo, quem de te expectat orbis literatus, annectantur: Observationibus vero inest sincera fides, pro ratione instrumenti, ut etiam calculo iis superstructo, in quo supposui plerumque Latitudines duarum Tychonicarum, cum distantia observata (namque meridianas altitudines cælum plerumque nubilum nequaquam permisit observatas). In Catalogo meo suppono obliquitatem Tychonicam $23^{\circ} 31' 30''$ et præcessionem æquinociorum sive Longitudinem 1^{ae} stellæ γ $28^{\circ} 41'$, quanta fuit ineunte anno 1678; utrasque vero a te paulo aliter statutas, non dubito; quocirca calculi laborem repetere non gravarer, si modo correctiora haberem fixarum, quibus usus sum

¹ Printed from a photostat of the original in the British Museum, London (Egerton MS. 2334, f. 32; cf. *Notes and Queries*, vol. cliii, 1927, pp. 212, 410). It seems quite possible that this original was one of the four from Halley to Hevelius 'enlevées' (? by Libri) from the collection in the library of the Observatory at Paris (see Béziau, L. C.: 'La Vie et les Travaux de Jean Hévélius', in *Bullettino di Bibliografia, &c.*, ed. Boncompagni, vol. viii, p. 650, note 10, Roma, 1875). A transcript of this letter (? made by Hevelius's secretary, Olhoff) is in the Bibliothèque Nationale, Paris, under MSS. Fonds Latin No. 10349, tome xiii, pp. 84-6 (*not examined*). This letter was printed by Olhoff in his *Excerpta ex Literis . . . ad J. Hevelium*, pp. 182-4, Gedani, 1683, of which book copies are in the Royal Society Library and the British Museum, London. It was also reprinted (from Olhoff) in the *Biog. Brit.*, vol. iv, p. 2497, London, 1757.

loca, de Catalogo tuo desumpta, ut potius Heveliani quam Tyconici Catalogi Supplementum opus meum inscriberem. Qualia sint nostra observata comparatione cum vestris facta, in quibusdam stellis ab utroque nostrum observatis, facile constabit nec magnas inveniri differentias ausim spondere. Ipse vero de se loquetur Catalogus; quo tui juris facto utere pro libito; ac si dignum recenseas, quem lucubrationibus vestris adjungas, me plurimis officii vinculis obstrictum tenebis, animumque tui et Astronomiæ amore fervidum, majori ardore accendes; hoc etenim pacto, inter volumina tua nunquam moritura, nomen meum oblivionis fato ereptum, apud posteros quantumvis seros legetur: nec majus hominibus (me saltem iudice) contingit bonum, quam grata per cuncta secula memoria, de bene gestis in usus publicos vel literarum parta; Dm. Flamsteedius qui jam ad te scribit observationes Eclipsis Lunaris Octob. 19/29 a nobis felicissime habitas, transmittere promisit, itaque me ea de re excusatum habeas velim.

Brevi, Deo volente, civitatem vestram visurus iter suscipio, ut virum apud eruditos universos celeberrimum, quemque non sine quadam æmulationis specie veneror, oculis meis agnoscam utque instrumenta tua modumque observandi expertus intelligam, atque de ulteriori Astronomiæ profectu te consulam. Juventuti vero nostræ, quæ vix hodie vicesimum secundum annum attingit, venia impetranda est, dum Reverentiam vestram majoribus curis occupatam, ineptiis meis lacesso: Vale, Vir Clar. meque omnibus observantiæ ac obsequii vinculis tibi devinctum ne dedigneris redamare.
Edm. Halley.

Dabam Oxoniæ Novemb. 11^o st. vet. 1678.

4. To FLAMSTEED.¹

Dantzick June 7th. St. Vet: 1679.

Dear Sr.

I had sooner given you some account of my Negotiation, had I not been wholly taken up with the Curiosities of this Place, which has caused me to send no more than 2 Letters till this day; I know your principall desire is to understand my Sentiments, about my Lord Hevelkyes Instruments and Observations, of which I shall as briefly as I can give you an account of what I have seen and experienced.

The Instruments that he principally useth, are his Quadrans Azimuthalis, about 5 foot Radius, to take the Meridian Altitudes

¹ From a 'fair copy' in the possession of the Royal Observatory, Greenwich.

of the Sun, which He doth by lettinge the Species of the Sun through a small hole, and collecting the Rays in a Circle at the Center of the Quadrant, as is at large described in the first part of his Machina Cœlestis. Then his Sextans—Magnus Orichalcicus, about 6 foot Radius, which is Reallye a very curious Instrument; with this he at present Measures all his distances, his Quadrans, Magnus Volubilis, and Octans Orichalcicus haveing not been used a long time; and for correctinge his times he observes his Altitudes of the Sun and Starrs with a Quadrant not above 10 Inches Radius, with such a Perpendicular, as we used at the time of the Lunar Eclipse we observed at Sr. Jonas's: his Clocks are not extraordinarye, he hath but 2, and those with very short pendulums, and such as are made to stand on Tables: As to the exactness of the Observations of the Meridian Altitudes, I can say little, there are enough of them in his Book wherby you may make a judgement: But as to the distances measured by the Sextans, I assure you I was surpriz'd to see so near an agreement in them, and had I not seen, I could scarce have credited the Relation of any; Verily I have seen the same distance repeated severall times without any fallacy agree to 10", and on Wednesday last I myself tryed what I could doe, and first I at the moveable sight, and the Printer at the fixt, did observe the distance of Yed Ophiuchi from Lucida Aquilae $55^{\circ}-19'-00''$; then we removed the Index, and my Lord at the moveable sight, and I at the fixt, did observe the same $55^{\circ}-19'-05''$, and you will find the same distance 6 times observed in Page 272 of ye fourth book of his Machina Cœlestis, so that I dare no more doubt of his Veracitye: I want time to add more, than that we have here observed the occultation of γ by the Moon in the day time May 26d: m: the Immersion of the Center was at $4^h-18\frac{1}{2}'$, the Emersion at $5^h-16\frac{2}{3}'$ about 4' more Northerly than the Center of ye Moon, the Calculus errs very considerably, if the place of γ be corrected: I hope you alsoe have observed this Eclipse, it will very well give us the difference of Meridians.

I hope about 3 weeks hence to goe for Denmark, there to observe somethinge for the difference of Meridians of Uraniburge from London: wherfore I entreat you to be more than ordinarye intent upon the occultations and appulses dureinge my absence.

I am in hast Sr. Your ever Affectionate Friend & Servant,
Edmond Halley.

Ps. Pray present my humble Service to Sr. Jonas Moor.

Recepi hanc Literam Junij 26:1679. T.S.

5. To HEVELIUS.¹ 1679.

Amplissimo, Spectatissimoque Viro, Johanni Hevelio, Consuli Gedanensi, Astronomo Summo, S.P.

Nuperrimè intellexi ex Dn. Olaffio, Dominat. Vestram à me expectare, ut animi mei sensum de Observationibus ac Instrumentis Vestris scripto exponerem, quòd quidem lubentissimè faciam, cùm jam satis abundè mihi constet de eorum usu & certitudine. Fateor equidem me semper dubitasse, ex quo primùm cœpi scientiam Astronomicam excolere, ne fortè collimatio per nuda vestra pinacidia facta, incerta sit aliquot minutis, atque non semel miratus sum, quæ ratio dissvaderet ab usu Telescopiorum ad istud negotium; Interea tamen non ausus eram quidquam fidei Vestræ in dubium vocare, atque mecum semper conservavi venerationem Astronomiæ vestræ integram, ut cuivis patet ex Præfatiunculâ Catalogi mei. Dum verò his dubiis perturbatus sim, venit ad nos fama, jam editum fuisse librum, Observationes omnes vestras uno Volumine complectentem, atque quidem tales, quæ novum Fixarum Catalogum multò auctiorem & correctiorem concederent. Ego lætatus admodùm adedè magnificè auctam Uraniæ supellectilem, partim gratulabundus, partim etiam suspicionibus meis subventurus hûc me recepi. Quòd verò tanto affectu, tantâ benevolentia à Dominatione Vestrà receptus sim, tanto candore & sinceritate totus Apparatus Astronomicus mihi commonstratus sit, atque quòd toties mihi concessum sit, Vestris adesse observationibus, non inter minimas felicitates pono, sed etiam abundè mihi gratulor de suscepto meo itinere. Taceo inventa ingeniosissima ista, quibus ingentia Vestra Organa nullo ferè negotio, quasi minimo digito dirigi possunt; Quæ omnia in perpetuum Astronomorum commodum accuratissimè, prout res fert, in priori parte Machinæ vestræ Cœlestis describuntur. Me verò ultrò testem offero certitudinis vix credendæ Instrumentorum, contra omnes, qui inposterùm Observationes Vestras in dubium vocare possint, quippe qui hisce oculis vidi, non unam vel alteram, sed etiam plures observationes Stellarum Fixarum Sextante magno Orichalcico, à diversis etiam Observatoribus, quandoque etiam à me ipso, licet parùm exercitato, peractas, ac amotâ regulâ repetitas, accuratissimè, atque ferè incredibiliter inter se convenire, ac nun-

¹ Reprinted from Hevelii, Johannis: *Annus Climactericus*, pp. 101-2, Gedani, 1685. This letter appears, also, in *Biog. Brit.*, vol. iv, p. 2498, note [K]. The original of this was, no doubt, one of those lost from the collection in the library of the Observatory at Paris. It is probably a transcript of this letter which is in the Bibliothèque Nationale, Paris, under MS. Fonds Latin No. 10349, tome xiv, pp. 25-8 (not examined).

quam nisi temnendâ minuti parte inter se discrepare; quòd an majori gaudio, an admiratione exceperim nescio. Namque ex intimo isto affectu, quo Scientiam Sideralem colo, nil gratius mihi obtingere potuit, quàm quòd certò constaret, tanto ac tam accurato penu locupletatam esse Astronomiam, nec quidquam magis mirum, quàm quòd aded accuratus sit. Hinc possunt examinari Tabulæ jam constructæ, atque etiam Novæ procudi, quas forsitan non aded facilè eludet Cælum, dummodò sibi constans sit (de quo dubitare cogit Motus Saturni nondum numerorum legibus adstrictus) neque ipse gravabor, volente DEO, operam dare isti negotio. Interea verò, Vir honorande, favore vestro cohonestare atque animos addere ne desinas, nec pereat affectus vester benevolus erga me immeritò conceptus; dum ego precibus fuis DEum Opt. Max. suppliciter rogo, ne unquam deficiant animi, corporisve vires, utque possis diu Orbi litterato prodesse, nec nisi serus ad cælum redeas;

Sic vovet Nominis Vestri Cultor assiduus
Edmundus Hallejus.

Dabam Gedani,
Julii 8, 18, 1679.

6. To J. E. OLHOFF.¹ [Oct. 1679?]

Clariss. Viro Dm. Johanni Erico Olaff veteris civitatis Gedanensis Secretario amico suo honorando S.P.

Vir Clar.

Deficiunt mihi verba ad exprimendum doloris sensum a me conceptum, cum ad nos pervenerit, Dm. Hevelium morte adeo repentina tam brevi post abitum meum a nobis abreptum fuisse;

¹ Printed from [Rigaud's] 'fair copy' in the Bodleian Library (MS. Rigaud 8, ff. 56-60), where Rigaud has these notes: "This letter was advertised in 1838 by Mr. Rodd of Great Newport Street, in one of his Catalogues—as follows—"Halley (Edmund Astronomer) letter in Latin to Eric Olaff, on the death of Hevelius—sends a silk dress to Madam Hevelius and desires to have various works of Hevelius in return, 15s." The letter was purchased by Mr. Linacre a bookseller of Liverpool, who favoured me with a copy of it; but as he was not accustomed to read Halley's writing and did not understand latin there was some difficulty in deciphering his transcript. Sr. Jonas Moore died in 1681 which marks the time when it was written—Hevelius did not die till Jan. 1687, the report therefore which occasioned this letter was premature." It has now been ascertained that the original letter is in the possession of the Historical Society of Pennsylvania and by their courtesy it is possible to give a corrected version of the letter here.

Hooke's MS. Diary in the Guildhall Library, under date Sept. 4, 1679, contains a report of the death of Hevelius, and as Moore died in August of the same year (Rigaud's statement of 1681 being wrong), the probable date of Halley's letter to Olhoff is October 1679. (Cf. Appendix IV. Hevelius's reply of 1681.) [Ed.]

noxam, quam orbis literatus eo fato functo sustulit, vix unquam satis deflere possumus; nec in posterum sperandum est, adeo generosa indole scientiam astronomicam promotum iri, cum jam corruerit præcipua ejus columna. Auget hoc malum clades etiam apud nos recepta, cum summus ille amicus & patronus omnigenæ matheseos, Ds. Jonas Morus, pari fato obierit nuperrime, quasi vellet in cœlestibus ædibus, tanto viro se comitem adjungere. Nimis certi sumus damni hujus domestici; est vero in votis exoptatissimis Dm. Hevelium adhuc superesse, famam hac in parte mendacem se exhibuisse, etiamsi rarius in rebus tristibus fallat. Mæstissimam conjugem ejus pullis vestibis incedere debere sat sentio; pluribus tamen de causis, tunicam pro ipsa comparatam mittere volui, primum quia haud certus sum jam obiisse maritum, atque hoc in casu nil mora ingratus fore reputo; deinde non possum sine aliquot Imperialium damno, alieno institori vendere, nec dubito quin possit apud vos, si ita placuerit, cum aliquo lucro vendi; constat enim ex serico, et forma [est] novissimi modi, atque confido Dominæ Hevelio summe placituram, si modo se ea induere concederetur; denique poterit conservari usque dum tempus luctibus assignatum peractum sit, non enim gummi induratur nec injuriam patietur si diu reponatur. Quoad impensas erogatas, constat tunica ex decem ulnis nostris serici præstantioris, quarum unaquæque constabit decem solidis Anglis. Serici vero subdititii sunt octo ulnæ viginti solidis Anglis constantes, duæ vero ulnæ nostræ excedunt parum tres Gedanenses; pretium Sartori solutum et impensæ cœteræ minutæ efficiunt summam totam £6 8s. 4d. nostræ monetæ, hoc est 27 Imperialium cum dimidio. Jam octodecim Imperiales mihi nuperrime solutæ sunt pro libris duobus quos vendendos in Angliam miserat Dm. Hevelius, restant itaque mihi debitæ novem cum dimidio, pro quibus, si placuerit Dominæ Heveliæ ad me transmittere exemplar unum Selenographiæ et alterum Cometographiæ, ego lubentissime, quo velit modo, si quid illi debitum sit, solvam, atque in honorem ducam, si possim ullo modo inservire Dominæ tantarum virtutum participi atque tanti viri relictæ. Jam iterum, iterumque expeto et efflagito Dom. Vestram velle rescribere quamprimum fieri possit, ut certus sim an revera mortuus sit Dm. Hevelius necnon, et quo casu; debeo enim ad illum mittere libros aliquos, et conspicilia et vitra telescopica, quæ omnia comparaveram; postea vero quam audiveram eum defunctum [esse], reddidi. Interim quam humanissime salutes et meo nomine consoles mœrentem viduam, quinetiam deferas officia mea conjugi vestræ charissimæ, socero etiam et socru vestris, quibus omnibus me addictissimum

dicas; nec credas me immemorem humanitatis vestræ, erga me exhibitæ, dum apud vos diversatus sum, deficiunt mihi solummodo occasiones gratitudinem debitam testificandi.

Vale vir clariss: Meque amando constanter perge
Edm. Halley.

Missa est tunica in navi Anglica dicta, The Charity of Hull, Wilhelmo Loggan Navarcha, abiegna arcula inclusa cum hac inscriptione Anglica.

To the Honourable Lady Madam Hévelki of the Old Stadt Dantzick

These present.

Istum Navarcham alloqui poteris quotidie in diversorio nautarum nostratium, in vico vulgo dicto Boessmangæ, Davidi vestro bene cognito, quo etiam mittentur, obsecro, libri pro me designati cum hac inscriptione. To Mr. John Colson at his house in Marsh Yard near the Hermitage, London.

These present.

Literæ vero ad me missæ per tabellionem, possunt inscribi, To Mr. Edmond Halley, at his Father's house in Winchester Street—

These
London.

7. To JOHN AUBREY.¹ 1679.

Oxford November 16: 79.

Sr.

Mr. Pigott delivered yours to me, which besides the severall favours I have formerly received from you obliges me exceedingly, by being the instrument of a very desirable acquaintance with that Gentleman whom I formerly knew no otherwise then by fame: I hope it may fall in my way to be serviceable to him, that I may have oportunity to lett him know how much I value yourself and him. I hope shortly to hear of some great improvement of the vniversall character, of the use whereof I am very well persuaded by some late discou[r]se I had with Mr. Pigot.

As to the advice you give me, to study Astrology, I profess it seems a very ill time for it, when the Arch-conjurer Gadbury is in some prospect of being hanged for it, however I went to the library and lookt out the booke you recommended to me which I find to be

¹ This letter is here reproduced from a transcript, made by Miss E. G. Parker, from MS. Aubrey 42, f. 148, Bodleian Library, Oxford.

published in anno 1557, so that I doubt not but the more moderne Astrologers having more experience of things may have added to him considerably, however upon your recommendations I will read it over. Pray present my service to Mr. Hook, Mr. Wild, Mr. Fison and the rest of our friends that used to meet at Jonathans, and if any thing worth notice occur pray be pleased to oblige me now and then with a line or two

I am Yours to serve you
Edmond: Halley

[*Added in Aubrey's hand:*] It is Leovitius de Coniunctionibus magnis: he begins with J. Cæsar, and so comes downe to Maximilian ye Emp: to whom he dedicates his Booke.

8. To HOOKE.¹

Jan. 5/15, 1680/81.

Sr.

I got hither the 24th of the last month after the most unpleasant journey that you can imagine, having been 40 hours between Dover & Calais with wind enough.

The letters you were pleased to entrust me with did me the kindness to introduce me into the acquaintance of Mr. Justel and Toynard, with whom is the rendezvous of all curious and philosophical matters. At present I can send you but little but what you have seen yourself. The generall talk of the virtuosi here is about the Comet, which now appears, but the cloudy weather has permitted him to be but very seldom observed, whatever shall be made publick about him here, I shall take care to send you, and I hope when you shall please to write to me you will do me the favour to let me know what has been observed in England. Whilst I am here I shall be able to serve you in procuring you what books you shall desire, that are to be purchased for money, but those that have been published by the Academie of Sciences, amongst which is the Book of Plants Sr. John Hoskins desires, will be much more difficult to come by. However I have hope to get them for the Society's library, at least to get a sight of them, so as to give you some Account of what they contain. There is just now finished the Book of Astronomical Voyages, but I have not gotten a sight thereof. But Mr. Cassini who seems my friend will I hope grant it me; If I can but get it in my own possession,

¹ Printed from the 'fair copy' in the Letter Book of the Royal Society.

I will make hard shift to copy the most material things. There is one Mr. Varen that is about going to the Isle of Ferro to make observation of the Satellites to determine the Longitude of Paris from the said Isle which by an edict of Lewis 13 is under the first Meridian. &c. Paris.

9. To HOOKE.¹ 1681.

Saumeur May 19/29 1681.

Sr.

Your letter findeing me here hindered me of the Opportunity of serveing you in the Several particulars you desire, which required my being at Paris. I assure you I have written to an acquaintance of mine a Bookseller there, about sending you Monton and De la Hire, and the price of De Shales; but as yet I have recd. noe answer. Monsieur Cassini, who has been my very particular good friend, has let me have the peruseing of all the books published by their Royall Academy, and tells me that they are designed to be printed in a smaller volume, and that then he will obtain a Sett of them for the Society, but I thought not fit to neglect another Opportunity which offered itselfe to doe you service, wch. is his Maties. Envoy Mr. Henry Savile dureing my stay at Paris was pleased more out of his owne goodness than any desert of mine (as they say) to admitt me to a great freedome with him; wch. I laid hold of to gett a promise of him to procure the first and large Edition of those bookes for you, he made noe Scruple to promise me, and seemed glad of the Opportunity of serveing you; and accordingly I gave him a Catalogue of the bookes, but some unexpected buisieness calling him home for a little time, I was deprived of the Satisfacõn I promised myselfe in transmitting them to you; however you need not doubt but you may have them by his means when he returnes, but it would not be amiss that some of the Society of his acquaintance waite on him and put him in minde of it, as I will doe after his returne. The bookes are 1. Memoires pour Servir a l'histoire Naturelle des Animaux dressez par M. Parrault. this you have seen, and I believe it is not encreased since its first publication, though they have gotten together a great deal of new matter of that kinde amongst the reste they have dessected an Elephant the last winter and found Severall very remarkable particularities in him.

2. Recueil de plusieurs Traitez de Mathematiq, de l'Academie Royale des Sciences. These treatises are as Followeth: Resolution

¹ After photostat from Royal Society Guard-book, H. 3. 40. This original is not Halley's autograph and the many and often obvious errors it contains have all been left uncorrected.

de 4 principaux problemes d'Architecture par Mr. Blondel ce sont (1) Décrire geometriquement en plusieurs manieres et tout d'un trait le contour de l'enflure et diminution des Colonnes. (2) L'Apollonius Francois des Tactions ou trouver une section Conique qui touche trois lignes droites données en un mesme plan, et Deux de ces lignes en un point donné de chacune ou bien, décrere Geometriquement les cares rampans sur toutes Sortes de pieds droites et de hauteur. (3) Trouver Geometriquement les pointes de teste de toutes Sortes des arcs rampants. (4) Trouver la ligne sur laquelle les poutres doivent être coupez en leur hauteur et largeur, pour les rendre partout egalement fortes.

Mesure de la terre par M. Picart.

Traité de la percussion ou Choq des corps.

Nouvelle decouverte touchant la Veué.

Traité du Nivellement avec la description de quelques Niveaux nouvellement inventez, ces trois par Mr. Mariotte

Traité des Triangles rectangles en Nombres par Mr. Frenicle.
Of these I suppose you have seen none, but the measure of the earth.

3. Memoires pour servir a l'Histoire des plantes par Mr. Dodart.

This is a very small one and there are but 38 plantes whereof you have the pictures and descriptions preceeded by a pretty long discourse about vegetation in gennerall, whereby you will finde how much Sr. John Hoskins and you overvalued our Monsieurs Herball yet to give it its due I never saw anything of that kinde anything neer soe curious.

4. Relation de plusieurs voïages Astronomiques. this is a smaller folio than the rest, and is divided into 3 parts. The first containes the voïage of Mr. Picart to Uranburg in the yeare 1672, when he found the latitude of the place where Tycho's Castle stood $55^{\circ} : 54' \frac{1}{4}$ and the difference of meridions from Paris $42' : 10''$.

The second part gives the Observations Mr. Picart has made of the Longitudes and Latitudes of Severall of the Cittyes of France his Last voïage, wherein he has Observed the longitude of Bayon and of la tour de Cordoüan at the mouth of the River of Bourdeaux, does make appeare that the french had usurped more upon the Ocean in the west than they have been able to Conquer in the east. Bayon is but 15 minutes to the west of Paris, which the best of their Maps made $21'$.

The third part of that Booke Containes the relatōn of the voïage of Cayenne, the best thing done there was the takeing the tropicall Meridian heights of the ☉ whereby the latitude is found $4^{\circ} : 56'$ North and the distance of the tropicks $46^{\circ} . 57' . 20''$ the person who

Observed Seemeth not to have been very understanding in Astronomicall matters but his Meridionall heights may be well enough taken, he has some Observations proper for determining the Longitude of that place but I have not yett Computed them.

These are all I can heare are yet published. Monsieur de la Hier is about a Third treatise of the Conicks, but I know not whether that may not be printed and sold by a bookseller as his others are and I hope the rendring this peice of Service to the Society may pas for some part of Acknowledgment of the Obligacions I lye under to that illustrious body, who were pleased to give me the honour and advantage of being admitted amongst them.

Monsieur Cassini did me the favour to give me his booke of ye Comett Just as I was goeing out of towne; he, besides the Observations thereof, wch. he made till the 18 of March new stile, has given a theory of its Motion wch. is, that this Comet was the same with that that appeared to Tycho Anno 1577, that it performes its revolution in a great Circle including the earth wch. he will have to be fixt in about 2 yeares and halfe or that its diurnall motion of the perigeon is $24' \cdot 5'' \cdot 2''' \cdot 40''''$ and that the diurnall motion is of the perigeon direct is $6'' : 31'''$, the Radix of the Motion of Longitude & of the perigeon is $\rightarrow \cdot 14^{\circ} : 00'$ to 1577 November 7^d St. vet. 6^h p.m. in Uraniburgi that the proportion of the perigeon distance to ye Apogeon is at $1-2 \cdot 1\frac{1}{2}$ the Northern Node 21° of \rightarrow fixt and the inclinacion $29^{\circ} : 15'$, this is the Summe of his Hypothesis and he says it will answer exactly enough to the Motions of the two Comets as likewise to that of Aprill 1665; I know you will with difficulty Embrace this Notion of his, but at the same tyme tis very remarkable that 3 Cometts should soe exactly trace the same path in the Heavens and with the same degrees of velocity. I tryed but without Success to represent the Observations by an equable Motion in a right line. I made a theory to hit the first and last and two intermediate Observations, but then the Latitudes differed a little too much and the rest of the Longitudes would not hit right, especially at first where they differed $51'$. it Semeth to me that the real motion was swifter at first then afterward when the body was not only to sight but really deminished. your thoughts hereupon may serve to guide me in my Speculation. I am yet resolved to try one bout with it, and it will be with a great deale of regret that I shall be forced to give over. I beleave the Observations of Mr. Flamsteed are the best that are made of it. the instruments of the Observatuire here not being Compareable to his Sextans.

The great map of the Moon I have gotten for Mr. Flamsteed and

my selfe I was faine to be very Impudent to gett them & had I knowne your desire sonner, I would in your name demanded another, I assure you I asked him for 4 and he would give me but two telling me they were not as then finished; I beleive they are very exact being of about 20 inches English Diamiter, but I finde the shaddowes not neer soe well done as those of Mr. Hevelius.

If you would Compare London an Paris together as to Bulke and people I thinke I can give you and indifferent account of Paris I tooke the pains to pace it verey carefully and found it from the Observatory to ye end of the Fawbury St. Martin north and South it is 3 Englished measured miles and from port St. Honoré to port St. Antonie East and west the greatest length is $2\frac{1}{2}$ miles, soe that I suppose you will Conclude with me it is not soe great a Continuum of houses as London, but by reason of theire liveing many in a house it seemeth more populous, and theire bills of burialls and Christning Confirmes it, for the last yeare 1680 were buried 24411 whereas at London 20000 is reckoned a high bill, and the Christnings farr exceed ours, haveing been almost 19000, when we have ordinarily but 12 or 13000, here they Likewise take an account of the weddings which were 4470 the last yeare or a quarter part of the Christings very neare now in these weddings halfe as many were married as were borne; and not more; it will from hence follow, supposing it alwaies the same, that one halfe of mankinde dies unmarried, and that it is nescessary for each married Couple to have 4 Children one with another to keep mankinde at a stand. this Notion Occurred whilist I was writeing, of which when you are pleased to favour me with any of your Comãnds, be soe kinde as to lett me know your sentiments. about the begining of July or latter end of June, we shall part from hence and goe by Rochelle, Bourdeaux, Toulouse and Narbonne, with intention to see the new Cavall which is almost finished, and soe by Montpellier and Avignon into Provence, if you have any querys or other Service to give me Direct thus,

A Monsieur Monsieur Mareshall a la ville de venise
rue de Bussy au Fauxburg St. Germaine pour faire tenir
a Monsieur Halley A Paris

Be pleased to give my humble Service to the Honorable president and the Gentlemen of the Society, and remember me kindly to Mr. Hunt.

I am Honored Sir

Your Freind and Servant to the utmost of my powre
E. Halley.

IO. To HEVELIUS.¹ 1681.

Romæ Novemb. 5/15 1681

Ornatissime Domine

Heri non sine summo gaudio intellexi ex litteris amici cujusdam in Anglia, me longo errore laborasse, et vanæ anxietatis penas sustinuisse, dum in animum induxeram, me favoribus vestris olim adeo profuse exhibitis, latente causa privari, eximiamque istam benevolentiam quam apud vos toties expertus sum, ob inopinatum aliquod demeritum quasi indigno negari. Quippe jam satis conspicuum est, non provenisse longum istud silentium vestrum, ex aliqua de causis, quas mihi finxeram, sed solum, quod adeo intentus fueris restaurandis damnis, ab incendio vestro nunquam sine novis lachrymis memorando, sublatis, ut non scribere vacavit; vel forsàn quod literæ meæ, quas tres miseram, nunquam in manus vestras venissent. Unam Oxonii dedi qua gratulabar famam mendacem tantumque Virum incolumem, simulque verbis multum tamen dolori concepto imparibus flebam flammam Orbi Litterato adeo inimicas, atque his comites dedi duo exemplaria catalogi mei, et omnia tradenda commisi Mercatori cuidam Scoto, qui per civitatem vestram debuit præterire in Poloniam, Alteram Londini Mense Junio (ni fallor) anni præteriti 1680 qua præter expolitam solitæ vestræ benignitatis continuationem, aliquot occultationes oculi Tauri indicavi, quibus observandis Dominationem Vram invigilaturam speravi, eas etenim ipsas applicationes, ab amicis in diversas Indiæ Orientalis partes proficiscentibus, in gratiam Longitudinum observatas fore curaveram. Deinde hyeme sequente in Galliam me recepi, cum subito exortus est Cometa iste ingens, quem cum Domino Cassino quotiescunque Cælum permisit, assidue observavi. Itaque Mense Februario, in unum collectis omnibus observationibus tam nostris quam alienis ex Anglia, Germania et Italia receptis omne quod eousque obtinueram transmittere volui, nactus ut mihi videbatur potestatem aliquam inserviendi desideriis vestris, simulque monstrandi me non immemorem hospitii Gedanensis, unaque cum descriptione aliquali Observatorii Parisiensis et instrumentorum quibus instruitur, quam magnopere à Te expetitam cognovi, adjunxi preces forsàn nimis importunas, quibus responsum vestrum efflagitavi, quem tamen commoratus Parisiis usque ad medium Majum frustra exspectavi. Ex eo tempore quasi semper in itinere totius fere Franciæ ambitum circumivi, deinde Italiam ingressus huc usque

¹ After a photostat from the transcript (? made by Olhoff), in the Bibliothèque Nationale, Paris, under MS. No. 10349, tome xv, pp. 95-7. The original of this letter was, probably, among those 'enlevées' from the collection in the library of the Observatory at Paris.

penetravi, adductus desiderio videndæ tantæ Urbis, quæ olim fere toti orbi cognito leges suas præscripsit, et hodie non minore imperio, diverso tamen jure dominatur. Urbi sane populo ædificiis et artibus longè famæ impar, neque conspiciuntur nisi pauculæ ruinæ miserandæ reliquæ antiqui splendoris Romani. Urania nostra deserta et quasi sine cultu hic languet, et inter Musas vix locum obtinet, nec nisi pictor et sculptor in pretio habentur. Breve redditum paro in Patriam meam, quam assequi spero circa medium Januarium, cumque non sine insigni meo infortunio, litteræ vestræ quas Londino ad me transmissas die 15/25 Augusti nuperrime audiivi, nondum in manus meas venerint, vereor ne amissæ sint, nisi forsitan inveniri possint Parisiis, itaque si contineant quidquam quo inservire possim Dominationi V'ra iterum iterumque obsecro quod placuerit transmittere statim à receptis hisce copiam literarum istarum inscriptam Anglice sicut invenies in altera pagina, quam cum accepero quanto-cyus fieri possit voluntatem vestram exequar, avidissime inhians occasionibus quibus demonstrare possim quantum in honorem duco titulum

Servuli Vestri Obsequentissimi
Edm. Halley.

Monsieur

Saluez de ma part (je vous en prie), Madame votre femme, la famille de Mr. Oloff et les deux Butners pere et fils.

Inscribantur litteræ Vestræ For Mr. Edmond Halley, at his fathers house, in Winchester Street, London.

II. To HEVELIUS.¹ 1682.

Clarissime ac Spectatissime Domine, Amice plurimum Colende.

Receptis hisce certior factus eris, portum Gedanensem attigisse Navem dictam the Swan of London (der Schwan von London) e qua ope inclusæ cartulæ recipies, arculam abiernam hunc in modum notatam, atque insuper inscriptam Anglice To the Honble. Monsr. Hevelius Consul of the Altstadt Dantzick. Continet omnia quæcunque de nobis petieras, si modo excipias delineationes instrumentorum et Observatorii Flamstedii, quæ, cum sint in potestate Illustris Domini Jonæ Moor, qui Regem sequutus per aliquot

¹ After a photostat of the transcript (? made by Olhoff) in the Bibliothèque Nationale, Paris, under MS. No. 10349, tome xv, p. 169. The original was, no doubt, at one time in the collection in the library of the Observatory at Paris, from which many MS. letters were stolen.

Septimanas foris agit, nondum obtinere potui; Ultimæ V'ræ. 14 Febr. datæ, heri mihi latæ sunt, et eo ipso momento artificem adii, qui par istud vitrorum, quod effractum dicis, fecerat; et hodie mihi retulit vitra quæ inclusa vides, ea spero tam Latitudine quam bonitate prioribus paria; Litteræ meæ per Tabellionem quas ante hasce recipere debes fusius contenta arculæ exponunt desideriis vestris satisfaciunt, et ad communia nostra studia spectantia plurima continent, quæ grata Tibi fore sentio, itaque hic repetitionis haud opus est. Vale Vir Clariss. et me constanter amando perge

E Servulis vestris studiosissimus
Edmond Halley

Dabam Londini April. 7/17
1682

12. 'To CASSINI.¹ 1685.

Clarissime

Non ita pridem mihi commonstrata est Epistola² tua Dmo. Haak data, quâ Theoriam meam variationis Magneticæ candide pertractas, atque eo usque approbas, ut causas ejus Physicas acri tuo ingenio investigandas susceperis, ipsiusque Dmi. Haak Philosophantium communis amici, ac eo nomine mihi semper colendi jussu et instinctu tandem audax factus, amicitiam tuam ac familiaritatem, quum per literas habere licet provoco. nec dubito quin candidus ille animus, qui ubique in scriptis tuis elucet, homini ante omnia veritatis amatori tuique nominis cultori assiduo hoc facile concessurus sit. Interim abunde mihi gratulor, quod dissertatiuncula illa mea de re Magneticâ tantum virum fautorem invenerit, atque gratias ago maximas quod libro tuo nuper edito, cui titulus³

commendatoriam ejus mentionem feceris, quodque causas rei naturales altiori indagine scrutatus fueris; vereor tamen ne nimis arcte vestigiis Cartesianis instans proprias tuas cogitationes vero magis affines celaveris. plurima sane sunt Cartesii dogmata, quæ labefactare deprehenduntur, plura vero captu difficilia, ne dicam impossibilia, quorum e numero sunt particulæ illæ striatæ, quibus Magnetis Phænomena explicare conatur. mihi sane virtus Magnetica a principiis . . . gravitatis haud multum

¹ From a photostat of 'fair copy' in Royal Society Letter Book, vol. xi. Errors left uncorrected. This inscription to Cassini is certainly wrong. Like Letter No. 16, it was to Johann Christoph Sturm, of Altdorf, Bavaria.

² The relevant portion of this letter of Sturm's is found, fair copied, in Royal Society Letter Book, vol. ix.

³ Blank in original. Book referred to is probably Sturm's *Collegii Experimentalis, &c.*, Norimbergæ 1685.

diversa pendere videtur, quâ assignandâ egregie fallitur Cartesius, dum terræ rotationem circa axem suum causatur, experientiâ enim constat corpora non minus esse gravia circa polos ac circa Æquatorem, nec penduli vibrationes tardiores hic quam apud Indos etiamsi motu multo citatori circumaguntur, nec dubito quin eadem sit gravitatis vis, etiam sub polo ipso. hinc utrumque Phenomenon inter arcana naturæ hucusque latentia repono, neque erubesco ignorantiam meam ulli fateri in rebus hisce forsan humanum captum excedentibus; tuque etiam vir Clarissime non invitus fateberis nunquam tibi plene a quovis autore hac in parte satisfactum fuisse; Interim eximias tuas facultates geniumque Philosophicum exprome, et pro viribus veri scientiæ promovendæ strenuus incumbe, meque amicorum tuorum catalogo ascribe.

Edmundum Halley.

13. To LEEUWENHOEK.¹ 1685/6.

March 2.

Worthy Sr.

Yrs. of the 12 of Octob. to Mr. Aston, was by him safely delivered to the Royal Society, who have so great a value for so constant, and so communicative a Correspondent to let your letters goe unanswered so long; but so it is, that the Society being unexpectedly deprived of the Service of Mr. Aston by whom the whole charge of the Correspondence was undertaken, their affairs were very much retarded thereby, and it is but lately that they have reassumed their meetings upon a new model which they concieve may be less subject to the like inconveniences. so that for this time they beg your excuse, and promise you for the future a more ready returne of their thanks, for your ingenious and curious communications.

Your letter contains in it a great many particulars, in all which you fail not to add some new discovery or to confirm the old, and especially where you tell them that the Cotton seed contains in it a perfect plant capable to shift for itself without any Oleaging pabulum, as is ordinary in the seed of most other plants, to maintain its deriving its infancy, if I may so say, however they think it worth the considering whether those plants you examined might not be somewhat too old, that so the substance designed for nutriment might be dried up and extenuated so, as to pass for leaves or els whether there might not be contained within the stem which in your figures you design large, a substance analogous to the yolk of

¹ From a 'fair copy' in the Royal Society's Letter Book, vol. xi. Errors left uncorrected.

an Egg as it is in the bellies of Chickens and undoubtedly in those insects you mention to have found without a pabulum in their shells, but this only by way of inquiry, and to know your opinion thereon: you likewise advance an opinion that the hitherto supposed pores of the skin are rather the most compact parts thereof, and that the cuticula is in those little cavities more firmly than ordinary affixt by some ligatures to the cutis, which tho it be strange is not without great shew of probability, especially if upon view the sweat be found to flow less freely through those pores than elsewhere.

Another of your discoveries, it is to be feard, will pass for paradoxicall in the judgment of most men, to wit, that whereby you find the slime of Eels, and other fish not an Excrement but a real necessary part of their bodies, and likewise have scales of its one, this is what the Society wonders at, and would be glad they had glasses capable to shew them those miracles, which tho upon your credit they dare not disbelieve, yet their satisfaction would be more entire, could they but see them themselves. Lastly your speculations upon mixtures of several Chymicall liquours with the blood, are in the opinion of the Society highly worth the prosecuteing, there being hopes that by this means some light may be drawn towards the discovery of the abstruse and mysterious . . . of some medicines in the body, those effects, tho never so surprizing are not otherwise known then by their symptoms this therefore they recommend to your further examination with hearty wishes of success, there being scarce anything more beneficial to man-kind than would be the advancement of the most Emperial art of Medicine into a scientificall knowledg.

They have yet one further request to you, that since at this time the Eggs of silk-worms, and the things that happen to them could not by reason of the foregoing hard winters be observed by you, they desire you this spring to view the spawn of ffrogs, and to note ye method yt nature takes in ye production of those animals, for it is reasonable to suppose yt ye generation of most if not all oviparous fishes is after ye same manner.

14. To MOLYNEUX.¹ 1686.

March 27, 1686.

Sir,

I know not which way to apologize for having so long deferr'd to write to you, and give you an account of the state of the Controversy,

¹ From Halley's original (rough draft) in the Archives of the Royal Society. A fair copy is in the Royal Society's Letter Book.

between Mr. Hevelius and Mr. Hook¹ about Telescope sights, wherin I am so much concerned; as likewise of what has past in the Royall Society, since Mr. Aston and Dr. Robinson without any apparent cause, resigned their office of Secretaries,² and the Society have made me their Servant. I assure you Sr. it is in no measure to be attributed to a want of respect, for your person, whom all that knows, must needs aknowledg singularly endowed with a talent of reasoning aright, and judging truly in all things brought before you; but so it is, that a certain sluggish indisposition of mind, has been the frequent occasion of my committing several indecencys of the like kind, and in your particular, with shame I must own it, this is not the first time; there is nothing but your good nature, can set me right in your esteem which I promise myself will be done, when by a future diligence, I shall make it appear that I have cured myself of that torpid maladie, wherby I have so well deserved to loose many of my friends. The correspondence of the Society is now fallen to my share, and therefore first in their name I invite you to a communication of what passes in your society, which alwais has been most acceptable here; and I promise you a faithfull account of what is materiall, that is brought in before ye Royall Society, as it has been heretofore done by Mr. Aston, entreating you withall not to let any long time slip before you gratifie us in this particular. The History of our affaires is briefly this. On St. Andrews day last, being our Anniversary day of Election, Mr. Pepys was continued president, Mr. Aston Secretary, and Dr. Tancred Robinson chosen in the Room of Mr. Musgrave; every body seemed satisfied and no discontent appeared anywhere, when on a suddain Mr. Aston, as I suppose, willing to gain better terms of reward from the Society, than formerly, on Decemb. 9 in Councill declared that he would not serve them as Secretary, and therefore desired them to provide some other to supply that office, and that after such a passionate manner, that I fear he has lost severall of his friends by it; the Councill resolved not to be so served for the future, thought it expedient to have only Honorary Secretarys, and a Clerk or Amanuensis upon whom the whole burden of the business should lie; and to give him a fixt salary, so as to make it worth his while, and he to be accountable to the secretarys, for the performance of his office; according to which resolutions Sr. John Hoskins and Dr. Gale, were chosen Secretarys, and on Jan. 27 last they chose me for their under officer,

¹ For Hooke's own account of his dispute with Hevelius, see Waller, R.: *The Posthumous Works of Robert Hooke*, London, 1705 (*The Life of Dr. Robert Hooke*, pp. xv-xix). Cf. *Biog. Brit.*, vol. iv, pp. 2497-9, London, 1757.

² Cf. Birch, vol. iv, p. 450.

with a promise of a Salary of fifty pounds per ann. at least: by reason of the Holydaies, and the unsettled posture the Society was in, there was little done till February 3, when Mr. Hook brought in an invention of his, for nicely discovering the Alterations of the Air, by the Barometer, which I conceive will be much better, than anything else of that kind, the contrivance thus AB is as is usuall in the common wheel Barometer only from the ball B goes up a glass cane as long as you please according to the proportion of the diameters of the ball or rather cylinder to the Cane, at the head of which there is a third ball or cylinder C equal to the former, then supposing the quicksilver, at the mean hight to stand at a and b he pours on as much spirit of wine tinged with Cocchineall as shall fill the rest of the ball and half the cane up to c and again upon that as much oyle of Turpentine tinged likewise, but with another colour as shall fill the remainder of the Cane, and half of the upper Cylinder C to d, and note that these liquors are chosen upon two accounts, first they are exceeding near of a weight, and the spiritt of wine being highly rectified is lighter than oyle of turpentine, but by a very small addition of phlegm or water the spirit of wine will preponderate, and be undermost, so that you may make them as near a weight as you please; secondly they are liquors that will not mix so that the oyle of turpentine swimming on the topp will be divided by a line only from the spirit of wine, which the oyle will keep from evaporating; now the effect will be this, that when the Air is heavy and the Quicksilver bee raised into the Cylinder A, and retired out of B, the spirit of wine will descend into the Cylinder B, and the oyle of turpentine will fill the Cane, so as to make the partition of the 2 liquors near to the Cylinder B, and when the Air is light on the Contrary, the mercury will sink in A and rise in B, so as to drive all the spirit of wine into the Cane, and the oyle of turpentine into the Cylinder C, so that the section of the 2 liquors, will be near C, and the variation of the hight of the Mercury will be enlarged into almost the whole length of the Cane, without that the counter pressure from the liquor, will be in the least altered, the hight of the incumbent liquors being always the same, wherof every 15 inches, will raise the mercury an inch above what the Air doth in the ordinary barometer, and by this means is a remedy found out for the defects of Mr. Habins way (formerly brought before the Society by Mr. Hook), which is only with a narrow cane rising from the Cylinder B, with one liquor, which rises, when the mercury sinks, and sinks when the mercury rises, but then each 15 inches of the liquor so raised, does counterpoise an inch of mercury, and the variations that might be observed

in the hights of the liquor, are thereby rendered less perceptible, and by no artifice more than 30 inches assunder in their extreames, supposing the greatest inequality of the hight of the barometer be 30 inches; and this I suppose is a sufficient if not a redundant description of this Barometer; whose glass will be some piece of skill to make: but when effected may be of admirable use to discover new propertyes of the Atmosphere. Mr. Hook has likewise shown before the Society a Levell of his invention, pretended by him to be capable of the utmost exactness, and yet of a very small bulk; I will by the next opportunity send you an account thereof. Mr. Papin has shown some very pretty experiments before the Society, as of the compression of the Air into a 60th part of the space it naturally takes up: reliving a Bird shutt up in a small space till almost dead by admission of Air that had been under so great a compression; and of shooting by the rushing in of the air into a Cylinder that had been evacuated by the Air pump, which succeeded beyond expectation. Mr. Justell has given us an account of a new engine which consumes smoak to admiration, and the most stinking things burnt in the furnace thereof, give not the least ill sent, the contrivance he has promised the Society to endeavour to obtain for them, which when I have got I will send you.

The Controversy between Mr. Hevelius and Mr. Hook, as you very well observe does, as Hevelius manages the matter, affect all those observers that use Telescope sights, and myself in particular, and it is our common concern to vindicate the truth from the aspersions of an old peevish gentleman, who would not have it believed that it is possible to do better than he has done, and for my own part I find myself obliged to vindicate my observations made at St. Helena and to rectifie some mistakes, whether willfull or no I cannot say; first he sais I was sent by R. S. to St. Helena at his request to observe the Southern Starrs (pag. 14), whereas it is very well known to all our Astronomers that at my own motion and charge I undertook that voiage above two years, before I had the honour of being a member of the R. S. all which I have declared in the preface to my Catalogue. Again he sais pag. 18 of the preface that I was sent with a sextans fitted with Telescopic sights for no other purpose but rigidly to examine his instruments: Wherin he does me a treble injurie, first in transferring the oblig. due to me

[Ends abruptly.]

15. To ASHE.¹ 1686.

Lond: March 27: 1686.

Worthy Sir,

The Royal Society are so far sensible of the Advantages of the Offer you make them of a Correspondence to be kept between the Gentlemen of your Philosophical Society at Dublin and themselves, that they have immediately ordered them and your Self their Thanks for so kind an Invitation: and they assure you that for the future your Letters shall be duly answered, and such Matters as shall be thought worth communicating, readily transmitted to you.

Your new method of demonstrating the knottiest Propositions of Euclid, your new-invented Dial, your Experiments of Injections of Liquors into Animals, and the account of your mathematical Girl, are things that will be very acceptable to us; as likewise whatsoever, whether Natural, Artificial or Mathematical Curiosity comes before you: in requital whereof at present we have not much to return you; only two Inventions of Mr. Hooke's seem to merit your Consideration. The first we understand has been already sent to your worthy Member Mr. Wm. Molyneux; being an Improvement of the Barometer, to make the alterations of its Height as large as you please. The other is of a New Level, whereby he pretends by a very small Instrument, and which may be made almost to be carried in your Pocket, to discover ye Horizontal Line for all Uses to the utmost Rigour of Exactness. The Contrivance thus:

AB, CD are two Rulers at right Angles, the one to the other. EF is a third, erected at right Angles on the Intersection of the other two, but cut away at the bottom, that so the Wire FG may be fasten'd to the Center of the Instrument in F, to give the Axis EF a small Inclination towards C.

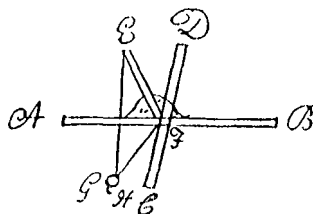

G is a Ball of Lead fasten'd upon the strong Wire FG, which is to turn upon the Center, and whose End is to be sharpen'd into a Point as at H, to meet with another Point at C the End of ye Ruler DC.

EG is a Thread from the top of the Ruler EF to the Lead G; so that the Triangle EFG is a kind of circular Pendulum vibrating upon ye Axis EF. And when the Line AB is horizontal, the Point H must come and settle, after vibrating equally on both Sides, at

¹ After a photostat of the 'fair copy' in Royal Society Letter Book. A rough draft of this letter is in the Royal Society Guard-book H. 3. 42.

the Point C: and when the other Ruler DC is likewise nearly horizontal, then will the least variation in the horizontal Position of the Line AB remove the Point H very far from the Point C, so as to make what perhaps is not above a minute or two, become discernable by some Inches in the distance of the Points H, C: the Pendulum GEF always pointing out which way is the Inclination of the Axis EF, in respect of the Horizon; which is never towards C, but when the Line AB is horizontal.

This Description I hope may suffice to make you comprehend the whole Contrivance of the Machine, of which Mr. Hooke makes great account, asserting it as exact as a Perpendicular of what length you please. The opinion of your Gentlemen hereupon will be very acceptable to the Society; to whom the only difficulty appears in the construction of the Instrument. A large Account of this will be printed, I suppose, in a Transaction.

Dr. Papin has lately shewed before the Society an Experiment of shooting a Bullet by the Irruption of the Air into a Cylinder evacuated by the Pneumatick Engine. The Shot was cast with an unexpected Force, and near the matter as strongly as if it had been by the Wind-gun, or the Compression of the Air.

We are informed from France of an Invention of a sort of Furnace, which consumes the Smoak, so that the most foetid things burnt therein give not the least ill Scent. Mr. Justel, who communicates this to the Society, has promised us to do his Endeavour to discover the Secret thereof: which when we have learnt shall be sent you, together with what in the mean time shall occur.

I am &c.

16. 'To A CERTAIN NOBLEMAN AT VIENNA'.¹ 1686.

Diu avideque expectatas tuas 27^o Martij datas debite ad manus perlatae sunt, sed jam exacto medio mense Maio, moerebam sane commercium illud literarium de quo tanta mihi proposueram, tam infeliciter denegatum ac jam pene desperatum esse, reputans mecum tibi semper ardua philosophica molito ad difficilia hujusmodi non vacasse, sed ex humanissimis tuis longe alia fertur causa, scilicet luxato humero, periere non solum mihi sed etiam universis literatis horæ illæ subsecivæ quas in emolumentum publicum scientiis promo-

¹ From a photostat of 'fair copy' in Royal Society Letter Book, vol. xi, from which the heading above is taken. The addressee was certainly Johann Christoph Sturm, of Altdorf, Bavaria. Punctuation, &c., preserved.

vendis tanta cum laude impendere consuēsti, participato itaque dolore tuo simul atque gaudio pro restituto humero, jam strictiori vinculo amicitiam inter nos contrahi posse confido, imposterum quantum in me est religiosissime observandam. Quæ dixi in ultimis meis de Cartesio, ejusque principiis boni consulas, obsecro, ego enim liberrime philosophari solitus, alienâ sententiâ minime offendor, ac nollem infensum alicujus animum in me incitare, dum errori vel detegendo vel refutando acrius insurgo; ingenuis sane omnibus vel studium privato quovis interesse prævalere oportet, mihi saltem semper charus sit, quicumque ab erroris devijs rectum veritatis tramitem reducere possit vel etiam cum hoc animo sensum meum de hypothesi tua, qua quatuor mundi polos magneticos a me propositos ex causis physicis stabilire voluisti non enim ex influxu particularum a mundi polis vim magneticam ortam ducere, sed ex peculiari structura ipsius lapidis sibi homogenia trahentis et heterogenia pellentis maxime probabile mihi videtur: Gravitās, etsi vis longe dissimilis atque undique æqualiter diffusa, a causis non multum diversis originem trahit sine dubio; jam vero acutissimus Mathematicus atque philosophus Ds. Neutonus Cantabrigiensis causas atque effectus gravitatis acerrimo quo pollet ingenio disquisivit ejusque libri ea de re jam sub prelo sunt; demonstrat ille vim gravitatis in superficie terræ maximam esse et sursum decrescere in duplicatâ ratione distantiæ a centro, deorsum vero in simplici: hoc est, gravitates corporum semidiametrum terræ sursum a superficie positorum, ad quartam partem ponderis sui decrescere, et infra, medio loco versus centrum corpora non nisi dimidio in centrum urgeri; et in ipso centro pondera evanescere lateque his positis vim talem, sed longe fortiorem soli inesse demonstrat ut et Jovi; et hinc facile deducit impulsu quocunque moventia corpora dum tali gravitatione agitentur necessario describere vel circulos, vel Ellipses vel parabolas vel hyperbolas secundum gradum velocitatis impressæ, neque unicum reperitur inter Phœnomena cœlestia, quod non exacte congruat cum hac hypothesi, seu potius demonstratione. talem autem vim componi ostendit ex conjunctis viribus particularum innumerarum minimarum corpora terræ solis &c. componentium, quibus se mutuo appetunt, atque undique ad concursum conspirant, uti videre est in fluidorum corporum particulis minimis, viz. hydrargyri et pluviae guttis, quæ dum admodum exiguæ sunt formam sphaericam sponte sua etiam absente et exhausto aere affectant, nec video quo pacto æther subtilissimus ac omnium corporum poros liberrime permeans ad hunc effectum educere possit; restat solummodo ut interna aliqua ac nobis haud comprehensibili affectione in se

invicem ad congressum impellantur materiæ particulæ minimæ; quod quidem non generalis materiæ affectio est, cum aëris particulæ, ut et vaporum vi quadam se invicem fugandi præditæ videantur; unde forsàn immensa illa æris condensatio et dilatatio vi Elasticâ hactenus imbuta non invenuste explicari potest. cum vero hæc ita sint, quid si lapis magnes ex particulis minimis ferri attractivis non undique in circuitu, sicut est vis gravitatis, sed solummodo secundum lineam quamvis datam componatur?

Omni procul dubio plurima magnetis Phænomena hinc soluta dabuntur, ac si magnes aliquis ingens interpositâ zonâ ex particulis non similiter attractivis constante, in duos dividatur, patet talem magnetem quatuor polos magneticos non longe a se dissitos habiturum. sed de his plus satis, cum in tantis tenebris vix quicquam lucis profiteri audeam. Tu vero vir Clarissime veri studium excolere ne desinas, cumque natus videaris in rei literariæ emolumentum egregias animi tui dotes in scientiæ cupidos impendere haud graveris; meque tui amantissimum pristino affectu redama.

Occasionem nactus ad te transmittendi ope Dni. Wegleiter volui munusculum tui sane indignum sed benevolentiæ tesseram his literis adjungere, simul te exoratum cupio, ne mihi vitio veritas quod tamdiu literæ tuæ mecum sine responsu hæserint, negotia mea longe gravissima, quibus pene obruor, obstitere, quominus officii mei erga plurimos amicos, præcipue erga te memor fuerim, imposterum vero operam dabo ut tibi non sit ea in re querelæ locus, Cum sim vir Spectatissimè Eruditionis tuæ

cultor assiduus

Edmund: Halley.

P. Scr. Si quem nôsti virum eruditum præcipuè mathematicum Viennæ Austriæ degentem, qui rebus Philosophicis operam dat, lubentissime cum illo commercium Literarium stabilire vellem; sic jubente Societate Regiâ cui inservio.

17. To MOLYNEUX.¹ 1686.

London Maij 27, 1686.

Sr.

I have yours of the 8th of Aprill, and yesterday received another dated the 15th of May, in the latter wherof you make good a promis in your former, by sending us the figure of the Horny Girle, which is certainly a most extraordinary curiosity, and which I belive very

¹ From the original (rough draft) in the Archives of the Royal Society. This letter was in answer to two from Molyneux. For Molyneux's letter of 8 April 1686, see Birch, vol. iv, pp. 475-9.

much puzzles the Physicians to account for; wee are made to belive we shall see her here at Bartholomew faire.

I doubt not but you have seen the account I sent Mr. Ashe about Mr. Hooks level, Mr. Ashe writes us, the consideration therof was refer'd to you and that you reported favourable of it, only it was found somewhat ticklish, and would hardly ever come to the same point twice, tho the Instrument were unmoved, this Mr. Hook belives to have proceeded from the want of a Contrivance, which I forgot to mention, in the Letter sent you, viz. that the Wire on which the weight is fixed, was to be fasten'd to the pin in the centre by a small thread, as in the mergent and not to touch the sd pin at no time, and he is positive, that when this is done you will find this objection cease: the other you make against it is that the least breath of air disturbs it, and sets it amoving, after it has stood; this proceeds from the niceness therof, for a pendulum so long as to vibrate in the same time, as the pendulum of this levell doth, suppose in 5 seconds of time, will be 81 foot long, and that charged with a small weight such as that of this levell will be found to be no less ticklish, than this, but to remedy both the bigger the weight the more certainly will this pendulum find out the perpendicular.

Yesterday Mr. Hook produced a further invention by applying the pendulum of this level to a Watch, so as to make it the regulator therof which tho by the rudeness of the Aparatus it performed not to all points, yet the society were fully satisfied that the thought was good, and that by this means Clocks may be made to goe a very long space with the same number of teeth as ordinary only by making the vibrations of the pendulum so many times slower, which could not be effected in the ordinary way by reason of the vast length of the pendulum requisite to vibrate so slowly.

As to the Contrivance of the Baroscope I wrote you in my last, you say truly, that the great difficulty is in the make of the glass, but since, the inventor Mr. Hook has obviated it, by grinding the pipes so as to fit, like stopples into the Cylinders, wherby the air is as well excluded as if it were solid glass at least when assisted with Cement.

As to Mr. Hevelius we heare as yet no farther from him, and I am very unwilling to let my indignation loose upon him, but will unless I see some publick notice taken elsewhere, let it sleep till after his death if I chance to outlive him, for I would not hasten his departure by exposing him and his observations as I could do and truly as I think he deserves I should.¹

¹ See *Biog. Brit.*, vol. iv, pp. 2498-9, note K, London, 1757.

18. To LEEUWENHOEK.¹ 1686.

Worthy Sir

Since my last of ye 2d of march. we have recieved your answer thereto, and lately another of ye fourteenth courant. the first has been read before the Society, and the latter shall be as soon as translated: the remarks that have been made thereon you shall shortly have by the Post; this being only intended to accompany a small present, which the Society as a mark of their respect & gratitude for the pains you take to obliging them, has thought fit to send you: tis a book they have printed lately at their own charges, being the Natural History of fishes by Mr. Willoughby which you will find a work of great curiosity, the Gentleman that has undertaken to deliver it you, is a very knowing & curious person, & ye Society would esteem it an obligation, if you should think fit to let him view in your most incomparable microscope some of those many curiosities, wherewith from time to time you entertain us, so much to our satisfaction, I have yet one further request to you, wch is, that several Gentlemen of the Society, who are your admirers, have heard that yr Picture is of late curiously graved have ordered me to desire of you some few prints to adorn their studies, and one for the Societies meeting room, where you will be sure to be in good company, what you shall think fit to send, you may please to deliver to this Gentleman Mr. Colson for ye Society, & they will be sure to come to hand.

Yrs. &c.

Ed: Halley.

19. To WALLIS.²

London Julij 9^o 1686

Reverend Sr.

I communicated your letter, according to your desire, to the R. Society at their last meeting: and received their Command to return you their hearty thanks for the respect and kindness you profess for them, and to assure you that nothing will be more acceptable than the restitution of that Correspondance which heretofore they so much valued. To set you right in your Opinion of the cause of the intermission that has been, be pleased to know that no one letter from Mr. Musgrave has come to Gresham Coll. since the business of the Society has gone through my hands, which is

¹ From a photostat of 'fair copy' in Royal Society Letter Book, vol. xi.

² From a photostat of the original in the Library of Trinity College, Cambridge.

ever since the beginning of last February and if Mr. Musgrave have sent 6 Letters, as he informs you, I presume it was rather to Mr. Aston, than to the Society, who never communicated them: However it be, I will soon take care to give you an extract of the Societys Journall for the time you want, and will for the future send you, at least once a fortnight, what shall occur, hoping the like freedom from you. In the mean time I shall be glad to find all dissatisfactions and uneasiness at an end, they being hardly consistent with a Philosophicall Genius.

I am Sr. Your most humble Servant.
Edm. Halley.

20. To CASWELL.¹

London Julij 9^o 1686

Sr.

I give you many thanks for the communications of your last, and could wish you had sent me the other Circumstances of your Noble Experiment upon Snowden which only wanted an Observation of the Barometer upon the Sea side, to have made it the most perfect of the kind. I have further cause to thank you for so managing my letter, as to let it be the occasion of restoring the Correspondance between the Royall Society and yours at Oxford, which hath been interrupted by the misunderstandings of some, and ill will of others. Since yours I have recd. one from Dr. Wallis, proffering to renew the former intercourse between us, wherewith the Society is well pleased, and have ordered me to signifie the same to Dr. Wallis, to whom I will in a few days send an Abstract of the Societys Journall for the time you want it. I have now lately prevailed upon the Society to allow me £50 to measure a degree of the Earth, tis too little to do it by a scale of Triangles, and will only defray the Charge of an actuall mensuration; pray let me know your opinion as to the best way of measuring, and if you think one may be sure that way to 1 in 1000, if so tis as near as I can hope to take the Latitudes, wherin lies the main difficulty, which I will endeavour to obviate by using a Radius of above 20 foot with Telescope sights. I have this day seen a great curiosity viz a Calicoe shirt brought from India, which is wove without a seam all of one peice which I should have thought impossible had I not seen it, it explains the Scripture relation of our Saviours coat which was without seam.

I am Sr. Your very Loving friend & humble Servt.
Edm. Halley.

¹ From a photostat of the original in the Library of Trinity College, Cambridge.

21. To REISELIUS.¹ 1686.

Julii 19, 1686.

Spectatissime Domine

Ultimæ tuæ 12^o Februarii datæ non appulerunt ante exactum Martium, ubi hæserint incertum. Cumque jussu Societatis Regiæ Papinius noster paulo antea responsum postulatis tuis de Instrumento ejus hydraulico aquam circulante fusius dederit, artificiumque ejus internum reseraverit, non par erat importunis literis lucubrationes tuas nunquam non fructiferas interpellari. Quoniam vero jam plurimi fluxerunt menses, ex quo altum est utrinque silentium, ejusdem Societatis mandato te aggredi jussus sum, ne eam tui immemorem putes, neve illa diutius inventis tuis et experimentis curiosis privetur, quæ adeo benevole communicare consuesti.

Papinii literas jam dudum tuas attigisse manus nullus dubito, utpote quæ secundum monitum tuum Dno Isaac Velthuisen inscribebantur: Transactiones reliquas omnes huc usque editas jam mitto, futuras ordine edendas, si placuerit, missurus; simul etiam eodem fasciculo Celeberr: Boylii partem primam continuationis novorum Exper: physico Mechan. quam olim desiderasti tenebis; ac siquid præterea ejusmodi fuerit quod in posterum petieris, statim mandato tuo quantocyus exequi operam dabo.

Quæris insuper, Vir Clarissime, quid novi inveniatur apud nos, præter ea, quæ in Transactionibus continentur; Ut hac in re tibi aliquo modo satisfaciam, Catalogum librorum nuper Londini editorum una habes; quæ vero Philosophiam propius spectant, hæc sunt. Paucis abhinc septimanis in lucem prodiit Historia Naturalis Piscium: Authore Willoughbeio Naturæ sagacissimo indagatore, editionem curante Societate Regia, opus sane dignissimum, Latine conscriptum, ac ferme ducentis Iconismis æri incisis, Piscium omnium huc usque cognitorum figuras vivas exhibentibus, perornatum: Ac jam primum publici juris fit, Tomus primus Historiæ plantarum, Authore Raio Botanicorum nostratium facile principe, qua plantarum omnium, quotquot in notitiam Authoris venere, descriptiones nova methodo et ordine accuratissimas exhibentur. Jamque sub prælo est, Liber vere egregius, cui titulus Philosophiæ Naturalis principia Mathematica, Autore Isaaco Newton, Matheseos professore Cantabrigiæ, Geometrarum quotquot unquam extiterunt, forsan

¹ From the original (rough draft) in the Archives of the Royal Society. Endorsed on last page 'Lr to Dr. Reiselius of Wirtemberg, July 19^o 1686; Journall-Book R.S. No. 8, pag: 44-49; ansr to Reiselius's Letter of Feb. 12.'

summo. Hoc specimine probabitur, quousque in indaganda veritate Mens humana recte instituta valere potest. Demonstrationibus enim firmis et indubitatis, Motum orbicularem Planetarum ostendit, ex impresso et vi gravitante versus centrum Solis componi, viresque illas decrescere in ratione duplicata reciproce distantiarum a Sole; quo pacto Orbes omnium gyantium, quorum velocitates datum terminum non excedunt, Ellipses fiunt; Datam vero istam Velocitatem attingentia lineam parabolicam designant, superantia vero Hyperbolicam, Sole ceu centro in foco omnium constituto, ea lege motus ut Areæ temporibus proportionales inter curvam et Radios, cum multis aliis inventis longe dignissimis.

Experimenta quod attinet nova, Cl. Dns. Hookius nuper coram Soc. Reg. Barometrum inventionis propriæ protulit, cujus ope mutatio gravitatis Aeris incumbentis, quæ in his regionibus duorum quasi pollicum Hydrargyri est, in quamvis altitudinem, si velis viginti pedum, extendi possit. Ac simul aliud inventum longe ingeniosissimum, quo linea horizontalis pro libellandis aquis aliisve usibus, investigari possit, ea certitudine, ac si observaretur perpendicularo immensæ Longitudinis; nuperrime etiam vidimus Indusium ex India advectum, nullis suturis, solummodo textoris arte concinnatum, cujus generis fortassis erat Vestimentum istud Servatoris nostri Jesu Christi, cujus mentio fit in sacris Literis; artificium ejus jam detexisse videmur: Hæc sunt Vir Clar: quæ pro hac vice tibi significanda putavi, ac si qua alia te digna contigerint, prima occasione te participem faciam. Interim quicquid Curiosi vel Ars vel Natura vel denique argutum Philosophantium acumen ediderit, apud vos, semper Societati Regiæ gratum et acceptum fore ne dubites. Cumque libri quam plurimi de rebus ad Philosophiam spectantibus in Germania vestra passim eduntur, quorum notitia vix unquam ad nos pertingit, possis facili negotio, transmissis titulis eorum, quæ tibi digna videbuntur, ingenti vinculo Societatis animi in tui Amorem jam satis proclivem constringere

Vale Vir Clarissime

Meque virtutum tuarum Studiosissimum

Gemmæ Chalcedoniæ tincturam istam, quam misisti, inter mira Naturæ merito reponimus, ac texturæ istius Lapidis peculiari, ac solito laxiori tribuimus, haud tamen ulli corporum cælestium influxui, quæ an ullo modo agant in inferiora, est quod valde dubitem.

Novemb. 13. 1686.

Reverend Sr.

I have yours of the 8th and give you my most hearty thanks for the communications therein contained, for the which likewise the R. Society own their obligations to you; The sweet earth found at Hogsdon near London has been twice under the Societys consideration, the first time above 20 years since, and now lately it has come before them as a new thing, till the former account was found upon their books. 'Tis there sd that there lived upon that spot one that used to distill great quantities of Oyle of Turpentine, who digging accidentally, and finding a stiff clay, imagined that it might be capable to hold his Oyle of Turpentine, and accordingly he put into a hole in the ground a very great quantity of that Oyle which it seems being more penetrating than Water, in one Night soakt all into the ground; which having lain a long time digesting the particles of earth have acquired the smell and tast you now find, but upon distillation tis observed to yeild a liquor very near to that arising from Colophonie or the Caput Mortuum of the sd Oyle. The child you mention to have seen with 6 fingers on a hand & as many toes on each foot, is a great curiosity, especially if they be so contrived that the hand be not therby made less fit to do its office. Nor is the quantity of Water found in the Dropsicall maid less prodigious, it being hardly conceavable how the Muscles of the Abdomen should be distended to so great a Capacity.

That you are pleased to approve of my two little discourses inserted in the Transactions, is to me instead of an universall applause, for if in these matters, you like, I need not fear the censure of any one, you being that Judge in these cases to whom all others do and ought to subscribe. I am sorry for the errata you advertise me of, there are more of them, tho none so considerable; the body of the Impression has scaped one of them viz. $bb \mp \frac{tt \ bb}{rr} = GLq$.

The rest must be inserted in the Errata at the end of the year, for now tis too late to put them in the next. I attemptd about the end of last August to make a survey of a degree of the Earth, by a scale of Triangles; but found severall obstacles which for that time obliged me to desist. The chief wherof were that I found a great and insuperable difficulty to come to the objects I had seen at a great distance, for the country people I observed could tell me nothing of places above 7 or 8 miles off; And that at about 20 miles North

¹ From a photostat of the original in the Library of Trinity College, Cambridge.

from London, the country is very thick of high Woods, and the hills so near of a hight, that there were no conspicuous objects to be found: so that I saw an absolute necessity of making a preparative perambulation, to find out the eminent Objects that so I might not be at a Loss upon my second attempt. Near London and to the Southwards the Country is open and fit for the purpose, but for 15 miles viz from Ware to Royston there will be great difficulty to continue a scale of Triangles. I should be very glad to know your sentiments about the method of finding out the highest Objects, such as may be certain to see one another; If I cannot do this I must be forced to trust to actual mensuration, wherein it will be hard to come within a thousandth part of the true distance.

The R. Society has lately received an odd Inscription found lately on the basis of a pillar at Rome, if you value those things in my next I will send you a Copy therof. There has been likewise presented to them the relation of a very strange tomb, lately found in France, supposed before Christianity in that Country. both these are ordered for the Transactions. Likewise a relation of a little Man less than a pygmie, said to have been lately presented to the French King, being 37 years old, and with a great beard, and yet but 16 inches high.

There has been lately invented in France a transparent substance sd to be made out of Hoggs bladders, proper to serve instead of Coach glasses because it will not break.

Mr. Papin showd, the other day, the Experiment of the Engine yt consumes smoak before the Society with success.

By a letter from Sr. Cassini I have lately received the accurate Epochæ, Middle Motions and distances of the 5 satellites of Saturn not long since discovered by him, which for the sake of the curious I intend suddenly to publish.

These Sr. are the principal things that have occurrd since the reassembling of the Society; and I shall take particular care once a fortnight to transmit to you the Minutes of what passes, and will so soon as I can find a trusty friend to send by, let you have the Originall minutes of what has been done, since the business of the Society has gone through my hands; which as a member of the Society I doubt not but you will please to use to its advantage

I am Sr.

Your most humble servant to command

Edm. Halley.

pray Sr. give my service to Mr. Caswell, and be not unmindfull of the Eclipse next Friday night.

23. To HEVELIUS.¹ 1686.

Spectatissime Domine.

Binæ tuæ Epistolæ, altera 9^o Iulii, altera verò Septembris 17^o anni currentis datæ, ejusdem propemodum tenoris, exiguo tantum interjecto temporis spatio, in manus meas rectè venerunt. Ob recessum solennem Societatis Regiæ, non nisi nuperrimè contenta earum communicare licuit, ideoque responsum eo usque differendum censui, dum coràm perlectis tuis, gratias tibi meritò a Societate decretas significare potuerim. Nec dubites quin semper summo favore ac benevolentia quæcunque miseris dignabitur, cùm te sui ornamentum ac decus egregium nunquam non æstimaverit. Quòd Observationem tuam occultati Jovis potius Actis nostris philosophicis quam Lipsiensibus inseri velles, novum animi tui in nos propensi indicium est: itaque Transactione jam prælum subeunte, jussu Societatis propediem publici juris fiet. Sed ne tanto munere donati, vacui ad te accedere videamur, cape paucula Astronomica forsàn notitiã tuã non indigna.

Communicavit non ita pridem Observationem suam ejusdem Occultationis dignissimus Socius Cassinus, qui Parisiis in Observatorio, præsentibus pluribus Astronomis, tubis 20 & 70 pedum Observationi invigilavit et compertum est Aprilis 10 St. N. Vesp.

9^h 40' 21". Jovem attigisse limbum Lunæ orientalem tunc temporis asperum et scintillantem ob vapores horizontales.

9. 41. 20. Omnino disparuit: Jupiter asperitatibus Limbi confusus. Punctum Immersionis è regione Stagni Miris. Satellitum Immersiones ob crassum prope Horizontem Aera deprehendere non licuit.

10. 30. 2. Extimus Satelles Jovem tunc præcedens emersit è regione Mediæ Paludis Mæotidis.

10. 40. 24. Limbus Jovis primus emersit ex obscuro Lunæ Limbo e regione boreæ partis Mæotidis.

10. 40. 56. Centrum emersit. Momentum quo Jovis limbus integer factus est difficillimum erat notatu at 10^h 41'. 36". Eclipsis certissimè jam finita erat.

10. 42. 49. Penintimus Satelles emersit.

10. 45. 1. Intimus Satelles emersit.

10. 50. 40. Penextimus etiam Satelles in maxima sua a Jove digressionem emergere visus est.

¹ Printed from a photostat of the 'fair copy' in the Royal Society Letter-Book, Supplement. A rough draft is in the Royal Society guard-book (H, 3, 46).

11^h. 45'. Lunæ diameter deprehensa est 32'. 27" et Calculo Cas-
sini Parallaxis ejus 61 minutorum. Atque hæc Obser-
vatio maximè accurata nobis videtur.

Idem egregius Astronomus Summam Observationum suarum
quinque Satellitum $\bar{\nu}$ nuperrimè communicavit, quorum Epochæ
medii motus et distantiae a centro ex literis ejus 10^o Octobris
ultimò elapsi datis, hi sunt.

Intimus distat à centro Saturni $\frac{39}{40}$ diametri Annuli; motu suo
diurno confecit 6^{sig.}. 10^{gr.}. 41'. 31". et ultimo Decembris 1685 meri-
die Stylo novo in Meridiano Parisiensi inveniebatur in orbita sua in
 \mathcal{W} 24. 50. Hic Satelles motu valde sensibilibiter eccentrico circumfertur.

Penultimus distat a centro Saturni $\frac{5}{4}$ diametri Annuli: motum
habet diurnum. 4^{sig.}. 11^{gr.}. 31'. 30". Epocha verò ejus ad idem
tempus eundemque locum in \mathcal{M} 9°. 10'.

Medius seu tertius distat a centro $\bar{\nu}$ $\frac{7}{4}$ diametri Annuli. Motus
ejus diurnus est 2^{sig.}. 18°. 41'. 50". Epocha verò ejus ad idem tempus
et locum \mathcal{M} 9°. 39'.

Penextimus seu Hugenianus Satelles distat à centro Saturni quatuor
diametris Annuli. Motus ejus diurnus 22°. 34'. 38". Epocha verò
ejus ineunte Anno Gregoriano 1686 Parisiis erat \mathcal{E} 18. 1.

Extimus sive quintus Satelles removetur a Centro Saturni 12
diametris Annuli. Motus ejus diurnus est 4°. 32'. 17". Epocha
verò ejus ad idem tempus ac locum invenitur \mathcal{E} 16°. 19'.

Ope horum numerorum facili negotio loca horum Satellitum
ad datum tempus erues; ut possis tubis tuis præstantissimis hæc
minutissima ac longè obscurissima Sidera oculis propriis depre-
hendere, quæ quidem nulli Astronomorum nostratium hactenùs
conspecta sunt, sed tanti viri autoritas inventa ejus in dubium
vocari non patitur.

Instante $\frac{19}{29}$ Novembris Luna Eclipsim patietur, cui observandæ
jam accingimur; nec dubito quin more tuo, summo studio eidem
operam dabis: quicquid obtinebimus prima data occasione tenebis,
unà cum Transactionibus illis quæ tibi desunt.

Avidè jam desiderantur apud Nos libri tui quos propediem
edendos ultimis tuis expectare jubes; ac tibi omnia fausta precatur
R. Societas, quem nec juventutis illecebræ, nec Senii incommoda
ab indefatigabili veri disquisitione, ac bonarum literarum emolu-
mento, unquam deflectere vel absterrere valuerunt.

Vale, Vir dignissime, ac eodem, quo sideralem Scientiam affectu,
meque Societatemque nostram tui amantissimam prosequi digneris.

Devinctissimus tuus

E. H.

24. To WALLIS.¹

London Decemb 11 1686

Reverend Sr.

I humbly begg your pardon that your letter has layn so long unanswered; private business of the greatest consequence to my self and the hast of Getting an accurate Ephemeris for the next year ready in time, is my just excuse both to the Society and their correspondants, whom for this last fortnight I have neglected; and now for want of time and an Amanuensis, to ease me of the trouble of copping, I am forced to send you the originall Minutes of what has passed in the Society at two of their Meetings since my last. but I hope for the future once a week to answer your Expectation, and therefore pray that this fault of mine may not be used as a precedent on your side.

You were pleased to mention some thoughts you had of communicating your conclusions concerning the opposition of the Medium to projects moving through it; the Society hopes you continue still inclined so to do, not doubting but that your extraordinary talent in matters of this nature, will be able to clear up this subject which hitherto seems to have been only mençoned among Mathematicians, never yet fully discussed. Mr. Isaac Newton about 2 years since gave me the inclosed propositions, touching the opposition of the Medium to a direct impressed Motion, and to falling bodies, upon supposition that the opposition is as the Velocity; which tis possible is not true: however I thought any thing of his might not be unacceptable to you, and I begg your opinion therupon, if it might not be (especially the 7th problem) somewhat better illustrated. I have lately printed a Transaction wherin I give an Historicall Account of the Trade Winds and Monsoons all over the Earth, together with a Mapp shewing the whole at one view, it is what has cost me some paines to be well informed, and there are some particulars therein worth your consideration. I dessign next Week to send you half a Dozen to give to such of your Company as are curious that way; hoping they will think it worth their time to look into the Causes of so Generall and constant Phænomena, which are there most faithfully described.

I have no Copy of the Inclosed minutes, which are as they were read before the Society, therefore I pray you to conceal any thing

¹ From a photostat of the original in the Library of Trinity College, Cambridge. This and the following letter show many signs of very hasty writing.

you shall think not proper to be publickly read, and to send me them again in your next. In the mean time I am Sr.

Your most Obedient Humble servt.

Edmond Halley

At our Anniversary Election Novemb 30^o last the only alteration that was made was My Lord Carbery was chosen President in the room of Mr. Pepys.

25. To WALLIS.¹

London. Jan. 1^o 1686/7.

Reverend Sr.

I have yours of the 14th past, and am charged with the R. Societys thanks, for the Minutes of Your Society of the 30th Novemb. and 7^o Decemb. past and return you mine, for your sentiments you are pleased to give me, about the Cause of the Trade Winds; wherin you cannot assent to the reason, I have assigned, from the Rarefaction of the Sunn; conceiving that, if this were the Cause, it would rather produce a Westerly wind yn an Easterly, the Air being less rarified on the Western side of the Meridian than the Eastern; but to this objection I answer, that the place where the greatest rarefaction is, does shift with a prodigiously rapid motion, in respect of that of the Air, from East to West; and the tendency of the Air being towards this moveable place, I conceive the consequence will be, that the whole body of Air will rather follow this motion than oppose it: however I shall readily submitt this my opinion to any thing else that shall better square with the Phænomena, which I fear will not be made out, especially as to the Monsoons, if the Motion of the Earth be admitted as a Cause which I am very sure has little effect upon the Tides. But from the matter of Fact, which I have carefully collected and recited, I doubt not, but if you would please to consider all circumstances closely, you would much more certainly be able to conclude, whence the severall Variations of these Winds proceeds, than I have been able to do in my short attempt.

My Lord Carbery our President is much obliged to you for your respects and I have his commands to communicate what shall pass in the R. Society worth your Notice. What wee have been doing is as follows.

Decemb. 8. The Meeting was taken up in a great measure in swearing the new Vicepresidents and some of the Councill.

¹ From a photostat of the original in the Library of Trinity College, Cambridge.

Dr. Gale assured that he well knew two persons cured of the Dropsy or Anasarca by the use of Musterd seed in their drink.

Dr. Robinson sd that Cubick grains of Hæmatitis were found near Helmsley in Yorkshire; Mr. Hook sd that he had seen such that came out of New England which were transparent and true Amethysts. Upon Mention of the great Eruption of Water you were pleased to communicate, Dr. Robinson alleaged that it is a common thing in the Woulds and Craven of Yorkshire to have such eruptions of Water out of the sides of the hills; and that he himself had seen it spout two yards out of the Earth; Mr. Pagit sd that he knew the scituation of Kettlewell and that to the S.W. therof was a lake on the top of the hill and that out of it from below the Water spouts out with much Violence and becomes the head of the River Aar.

Mr. Cluver gave in an account of Mr. Molineux's book intituled *Horologium Telesopicum*, which was ordered to be inserted in the Transactions as likewise another account of Dr. Plots book of Staffordshire drawn up by Mr. Harwood fellow of the Society.

Mr. Mears son to Sr. Thomas Mears was Elected.

Mr. Thomas Molineux presented his brothers observation of the Eclipse of the Moon Novemb. 19^o 1686, wherby it appeared that the Quantity and duration agreed with my calculus but that it hapned about 10 m. sooner than I had predicted.

Mr. Hook read a discourse of his, concerning shells and the like substances found under ground, and on the tops of hills, as Nautili, Helmet stones & the like, and produced several elegant figures of the like substances drawn by himself.

A Letter from Mr. William Cole concerning some farther remarks on the purple of his discovery, was read, and severall peices of Cloath stained with that Juice which at the request of the R. Society he presents to Mr. Huetius, now Bishop of Soissons, were produced.

A proposall was made by way of Address to the R. Society, by Mr. Claud Bardon professour of Mathematicks, for their Encouragement to proceed in his dessign of causing Arithmet: Tables to be graved for the ready working Multiplication and the like.

Decemb. 15. 1686.

Dr. Clopton Havers was admitted fellow of the Society.

Sr. Sarotti sd that it was a common thing to have spouts of water out of the hills in the kingdom of Naples.

Mr. Hook alleaged the instance of the River Mole in Surrey which goes under ground from Darking to Leatherhead, after the

same manner as these springs in Yorkshire, where some extraordinary fall gives them the Impetus wherwith they break out.

Dr. Sloan read part of a letter to himself from Mompellier, concerning a very impetuous Hurricane, therabouts, upon the 22th of October last occasioned or rather preceded by the Collision of 2 clouds, one coming from the Sea the other from the land, from whence without any thunder proceeded a flash of Lighting and great haile, which was soon followd by a violent tempest of Wind.

Mr. Hook read a further discourse of his, being by way of Introduction to a Theory of his concerning petrified shells &c. found on the tops of hills & deep under ground.

Mr. Cluver presented to the Society with Isagoge Phytologica Jungii lately put out by Vagetius.

The same produced a book of one Mallement de Messange a french man, wherin he pretends to an absolute Quadrature of the Circle by right lines only: Mr. Cluver having examined sd it contained a paralogism which he promised to make out before the Society.

An Extract of a letter from Rome to Sigr. Sarotti, about an urn lately found there in a sepulcre, which upon opening was found to exhale a very strong bituminous scent, and to have in it an oylie substance contained in an Earthen pot like a Lamp, which substance grew hard upon admission of the outward Air: this was by some at Rome supposed one of the perpetuall Lamps of the Ancients.

Dr. Papin shewd the Experiment of a flint & steel in Vacuo and having contrived to thrust down the tricker of a pistol in an exhausted receiver, it was found that the fire that followed the fall of the Cock was scarce perceptible, yet in the Air the sparks gave a most Vivid light.

By my next, which shall follow this speedily, you shall have what has been done since, which neither the time nor paper permits at this time to be sent you.

I am Reverend Sr. Your most humble Servant
Edm. Halley.

26. To WALLIS.¹

London, Feb. 15, 1686/7.

Reverend Sr.

That you have not heard from me so long, has been chiefly because wee have had little materiall or worth your notice to communicate; at present I can inform you thoroughly of the Hypothesis of Mr. Hook, concerning the changes which seem to have hapned

¹ Printed from the original in the Bodleian Library (MS. Ashmole 1813, ff. 325-6).

in the Earth's surface, from the shells in bedds, found unpetrified in the Alps and other hills far from and above the sea, and again sea sand and shells found at great depths under ground. Upon this subject Mr. Hook has read severall lectures before the Societie; and it seems that he hath shown how the superficies of the earth may have been frequently covered with water, and again dry, so as to answer to all the appearances; if the change of the Earth's axis may be allowed. For it hath been demonstrated by him, that the figure of this ball is not to the Rigour of Geometry sphericall (supposing it covered with water) but that it must necessarily be of the sort of solides calld sphæroides prolatus, the shortest diameter being the Axis; which happens by the equality of the gravitation of bodies towards the center, and the *Vis Centrifuga* arising from the circular motion about the Axis (wherby the same bodies are cast off from the center), compounded together: herby the surface of the sea will be farthest of all from the center, under the equinoctiall and if upon any account the axis may be disturbed or altered in the Earth, twill from hence follow, that the sea would rise on those parts wherto the Equinoctiall approaches, and sink on those shores from which it departs; he farther asserts that when such a shift of the Axis begins, it will proceed on to make a revolution, in a greater or lesser circle, according to the manner of the impression of the force causing it, so that those parts of the Earth, which are now near the poles, may possibly hertofore have been under the Equinoctiall, or in the Torrid Zone, where the animals, whose shells we find (as the *Nautili* or *Cornu Ammonis* stones) tho at present no such are produced on our Coasts, may have formerly been generated; And tis his assertion, that there are not extant any authentick records of the latitudes of places sufficient to evince the fixation of the poles, but that the observations of the Ancients seem very rude and uncapable of giving any information in this matter; wherfore the last Wednesday he proposed a method of examining this Hypothesis, by showing how to find the Meridian line on the Earth with very great exactness, by means of the pole starr and a very long telescope, wherby he supposed if there were any difference, it might be discovered in the life time of one single observer. Sr. your thoughts herupon must needs be very acceptable to the R. Society, if you shall think it worth your consideration. I know not whether I gave you an account of the experiment of a flint and steel in *Vacuo*, which was, that there were no sparks visible from their collision, tho' they were most vivid in the same receiver when the air was admitted; since Mr. Papin has shewed the experiment,

of the quantity of air produced by the explosion of gunpowder in an exhausted receiver, the success wherof was, that 6 grains of powder produced as much air as supported the $\frac{1}{2}$ in a Gage to 5 inches high, in a vessel holding 3 pounds of water, that is there was a pressure equall to a 6th part of that of water, and consequently that there was about half a pint or 4 grains of air. Twas ordered to try whether this air, thus produced, would serve for a pabulum for fire, with design to examine the hypothesis of the fire's feeding upon the nitrous parts of the air; this medium being wholly made up of the substance of nitre dispersed in the form of air. The success herof you shall know. Wee have lately received an account from France of a very unaccountable effect of lightning, which I thought I ought to inform you of, which please to take in the words it was communicated in, least I might prejudice the sense in the translation—Le tonnere est tombé sur les chassis de verre du cabinet de Monsieur l'Evesque de Soissons, en forme de balles de pistolet, dont deux panneaux de chassis furent cribléz par des trous également ronds, sans eclater le verre. Il y a bien d'apparence que les grélons de feu fussent si brulans, que le verre s'est fondu à l'instant mesme, ce qui paroist par l'orbe qui s'est fait de verre fondu a l'entour du trou, qui est lisse comme le bord d'un verre a boire. Monsieur l'Evesque de Soissons n'en a gardé que deux carreaux ainsi percéz, parce qu' ayant donné les dits carreaux a nettoyer a un vitrier, ils se sont tous reduits en poudre quand on les a frottéz, comme des larmes de verre quand on les casse en rompant la pointe. Les volets qui etoient ferméz derriere les chassis & a deux doits du verre n'en ont recu aucune atteinte. From the same hand we are informed that the French in Canada have found out a whole mountain of lead-ore, which is bare, so that there is no need of mining: and that the same French have lately seized upon our settlement at Hudson's bay, and no news to be had of what is become of our people there. From Rome we are told that Sigr. Ciampini, who has a sort of monthly academy at his house, designs to publish Journalls of what occurs to them, after the nature of the Journal de litterati, formerly set forth by l'Abbate Nazari.¹

Sr., The Society gives you many thanks for your many communications, of which they hope the continuance, and particularly for the pains you have taken in enquiring into the opposition of the medium

¹ Halley may himself have met the Abbé Nazari, while in Rome in 1681, as there is a record of a copy of the 'Principia' being presented by Halley to him. (See *Proceedings of the Manchester Literary and Philosophical Society*, vol. xviii, p. 63, 1879; and *Nature*, vol. xix, p. 422, 1879.)

to bodies moving in it; they propose to your farther consideration, if this opposition may not take off, constantly, such a part of the velocity in each part of the motion, as the intrinsick or specifick gravity of the medium is of the gravity of the body projected; which if true will give us a better account than can be obtained from experiments. But I fear to have tired your patience, and shall only add the thanks of our Honble President, the Society, and my self, for your kind token of your books of Logick, which I distributed according to your direction.

I am Reverend Sr. Your most obedient Servant
Edm. Halley.

Your questioning my hypothesis for solving the Trade Winds makes me less confident of the truth therof, and I should be glad to see some other notion wherby more of the appearances would be naturally solved.

27. *To WALLIS.*¹

London, April 9, 1687.

Reverend Sr.

That your last has layn so long unanswered is chiefly for want of matter worthy your notice; the present posture of affaires having an influence on the gentlemen of the Society, as well as the rest of the Town, whose heads are taken up with thoughts and expectations of a differing nature: to which add that I have lately been very intent upon the publication of Mr. Newtons book, which has made me forget my duty in regard of the Societies correspondants; but that book when published will I presume make you a sufficient amends for this neglect. I have now lately received the last Book of that Treatise wch is entituled de Systemate Mundi; wherin is shown the principle by which all the Celestiall Motions are regulated, together with the reasons of the several inequalities of the Moons Motion and the cause and quantity of the progression of the Apogeon and retrocession of the Nodes. How he falls in with Mr. Hook, and makes the Earth of the shape of a compressed sphæroid, whose shortest diameter is the Axis, and determines the excess of the radius of the Equator above the semiaxe 17 miles, and from this quantity shows that the retrocession of the Equinoc-tiall points does necessarily follow, and computes it to be 49" 58" yearly. Then he gives the reason of the tides to be from the decrease of Gravity, from the contrary attraction of the Sun and Moon;

¹ Printed from a transcript of the original in the Bodleian Library (MS. Lister 3, ff. 119-20).

wherby the Water being less pressed rises where they are verticall, and subsides where they are in the Horizon: he computes the effect of the Moon to be about 6 times as great as the Sunns, and seems to account very well for the severall phænomena of the Tides. He concludes his book with the Theory of Comets, showing that their Orbs are sufficiently near parabolicall; and upon that supposition shows how from observation to find the parabola wherin they move, and gives an example of the Motions of the great Comet of 1680/1, and having stated the Orb from the observations of the Evening Comet, he finds that the Comet that appeared in November in the Morning was the same with that long tailed one; and that his calculus will agree as well with its motion, as the ordinary tables do with the planets. I hope to get the whole finished by Trinity term, but the correction of the press costs me a great deal of time and paines.

Mr. Hook seems concerned that you think his Hypothesis of the mutability of the Earth's poles so slightly grounded, and thinks he can fully answer the objections of your letter. For my part I conceive it reasonable, not to say demonstrative, that the Earth is of the form of the Sphæroides prolatus, but doubt very much whether there be any ground to suppose a rotation of the Earth's poles; the latitudes of places having been ever since wee have accounts of observations much the same, Alexandria being laid down by Ptolemy in the same lat: that Mr. Greaves found it, within a very few minutes, to be excused by the coarsness of Ptolemy's instruments.

Sr. I give you many thanks for your thoughts upon ye opposition of the medium to projectiles; it will serve to adorn and recommend the Transactions: Mr. Newton in his second book has handled this subject copiously and considered the opposition in a direct and duplicate proportion of the Velocity, and shown what are the curves that will result therfrom; and as truth is alwaies the same, I find your conclusions (as farr as you goe) æquivalent to his.

Mr. Hook has lately proposed a method of finding the Meridian line with great exactness, by directing a Telescope to the pole point which he sais he can truely discover by means of the small fixt stars about it, which lie in a remarkable form, very near together in a little constellation he gives the name of Rosa Anglica, being a kind of pentagon, with one in the midst, this with all the Eys I have, I could not find, and if there are any such I am sure they are very small.

We have had lately from France a very odd relation of an Hermaphrodite at Tholose, who being in all appearance female has yet a penis of a very considerable size, but that which is the most

remarkable is, that it is perforated, and is the common passage of urine, semen and the Menstrua which she has regularly. She has been hitherto habited and named as a female, but this discovery has obliged her to change the name of Marguerite for Arnold and to put on breeches. There is some difficulty to believe this story, tho it seems well attested, being from a noted physitian of the place; but the bantring ridiculing humour of that light nation makes me suspect all that comes from thence.

The problem of the Apparent magnitude of the Sun near the Horizon so much greater than when he is considerably high having been revived to the Society by Mr. Molineux of Dublin and the reason therof seeming obscure, the Societie would be glad to know your opinion therof.

Sr. I fear to be troublesome and therefore conclude Your most obedient humble Servt.

Edm. Halley.

28. To HAYLEY.¹ 1686.

Eclipsis solis to bee observed at Smyrna May 1 1687.

Sr.

London Decemb. 21^o 1686. Mr. Halley. In this Letter are directions for ye due Observing of it. Your kind proffer to observe the Eclipse of the Sunn, that will be in May next at Smyrna, has obliged me to consider what will be the appearance thereof in that Port, as likewise how you may effectually obtain the time of the End sufficient to determine the difference of Longitude between it, and London; As to the appearance, I conceive (by the accounts I have already gotten) that Smyrna is about 28. degrees or 1 h. 52 min. of time to the East of London; and upon that supposition I find that the beginning will be about 3 of the Clock; the Middle about 10 min. past 4; the end about a quarter past 5. in the afternoon, and that about the middle there will be just half the Sunn obscured; That you may the better compare the Calculation with your Observation, the SHEME annexed will shew you how it ought to appear, if our Numbers may be trusted, and wee are not considerably out in the Longitude of Smyrna.

Here in the following Page you see it begins in the underpart of the Sunn, a little to the left hand; When greatest, that it taketh away the left side of the Sunn as farr as the Center; and that it ends about the Middle of the upper Quadrant to the left hand.

¹ From a photostat of 'fair copy' in Royal Society Letter-book, vol. xi.

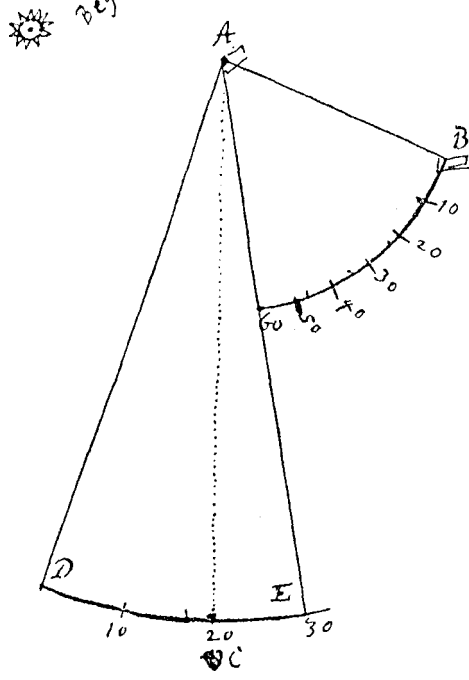
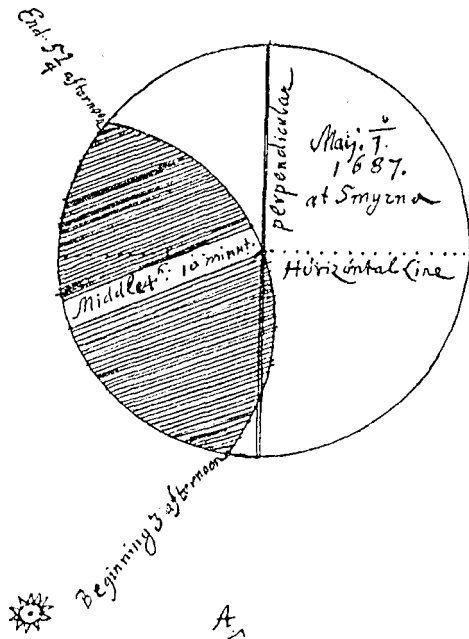

It remains now to shew, how you may with certainty obtain the times of the day by Observation; About the end, the Sunn will be about 20 degrees high in the West; and considering the Port of

Smyrna is Landlockt, you cannot use the Edg of the Sea for an Horizon, so you must be forced to use a Perpendicular, which you must apply to the center of your Sea Quadrant after the manner in the Scheme where you make the Horizon vane at A the shade vane, and take the Shadow thereof on the Edg of shade vane B., set to the beginning of the Divisions, and then the Degrees cut by the Perpendicular on the 30 Arch will shew the Sunns Altitude, but if the Sunn shall exceed 30 Degrees high you must remove your shade vane Lower, as need shall require, and the Sum of the degrees on the two Arches shall be the hight sought, but I suppose I need not be thus particular, in this Matter. I shall only add that the Instrument must be sett curiously perpendicular, so that the thread may neither bear against the Arch, nor fall off from it and that at the time of Observation it must be directly turned against the Sunn, so that the shade of the rule AD fall exactly on the other Rule AE. It will contribute much to the exactness of your Work, if you have or can procure there a Pendulum Minute watch or Clock, which you must try, how it goes, before, and after the End of ye Eclipse; and so be at leasure to mind nothing else but the Minutes by the Watch, when the Eclipse ends; which whether it goe true or false is not Materiall, if so you sett down, what Altitudes you find at any time by the Watch, near the time of your Observation; for the watch may be supposed to go equally for the space of half an hour, how much soever it differs from the true time of the day, as if you observe the End of the Eclipse at 16. minutes past 5. by the watch and at 25. Minutes past, the Sunns Altitude be found 18. degrees, that Altitude gives the true time, and shewes, how much the Watch goes too fast or too slow; which difference must be added or subtracted from 5. h. 16. min: to have the true time of the End of the Eclipse. Twill be the greater Confirmation, if you please to employ more hands than one, with severall Instruments, and practise yourself some time before in this manner of Observation by taking the Meridian Altitude of the Sun which will give the Latitude of Smyrna.

Sir I am the more bold in this Particular with you, because of the Character you bear of a very curious Commander, and because this Observation will be of Considerable use in the rectifying of Geography.

Sr. your most humble Servt.
Edm. Halley.

29. To WALLIS.¹ 1687.

London June 25^o 1687.

Reverend Sr.

You are herewith desired to accept of half a dozen Transactions but just now come out; together with my thanks for your leave to publish your discourse concerning the Opposition of Media to Projects, which is the Argument that will most recommend my Collection to the Curious, since so difficult and nice a subject is so clearly and throughly handled therein. The Gentleman who will deliver you these, is one that has a great veneration for you, and desired me to give him this opportunity of waiting upon you, being unwilling to leave Oxford without paying his respects where they are so much due. I was willing to make you a more valuable present: I mean Mr. Newton's book of Mathematicall Philosophie, which is now near finished; but I must entreat your patience yet ten days more, by which time it will be compleat. To hasten the edition of this book, I have been obliged to attend 2 presses, which has so farr taken me up, that for that reason, and for want of such communications as might be worthy of you, I have so long forborn to write to you, but the book, which needs must please you, will I hope obtain my pardon.

Sr. I am Your most assured humble Servt.
Edm. Halley.

30. To KING JAMES II.² 1687.

May it please Yor. most Excellt. Maty.

I could not have presumed to approach Yor Maties. Royall presence with a Book of this Nature, had I not been assured, that when the weighty affaires of Your Governmt. permit it; Yor. Maty. has frequently shown Yor. self enclined to favour Mechanicall and Philosophicall discoveries: And I may be bold to say, that if ever Book was worthy the favourable acceptance of a Prince, this, wherein so many and so great discoveries concerning the constitution of the Visible World are made out, and put past dispute, must needs be gratefull to Yor. Matie; Being especially the labours of a worthy subject of your own, and a member of that Royall Society founded by Yor. late Royall Brother for the advancement of Naturall knowledge, and which now florishes under your Majesties most Gracious Protection.

But being sencible of the little leisure wch. care of the Publick

¹ Reproduced from a photostat of the original in the Library of Trinity College, Cambridge.

² Printed from a photostat of the original in the Library of the University of Cambridge.

leaves to Princes, I believed it necessary to present with the Book a short Extract of the matters contained, together with a Specimen thereof, in the genuine Solution of the Cause of the Tides in the Ocean. A thing frequently attempted But till now without success. Whereby Yor Matie. may Judge of the rest of the Performances of the Author.

[The body of this letter is printed in *Phil. Trans.*, vol. 19, 1695-7, pp. 445-457. The beginning and ending are therefore alone given here.]

If by reason of the difficulty of the matter there be anything herein not sufficiently Explained, or if there be any materiall thing observable in the Tides that I have omitted wherein Yor. Matie. shall desire to be satisfied, I doubt not but if Yor. Majesty shall please to suffer me to be admitted to the honour of Your Presence, I may be able to give such an account thereof as may be to Your Majesties full content:

I am Great Sr. Yor. Maties. most Dutifull & obedient Subject
Edmond Halley.

31. To VALVASOR.¹ 1687/8.

Literas tuas, Vir excellentissime, 17^o Novembris ad me datas, quamprimum in manus venerunt, cum Regia nostra Societate communicavi; nec facilè crederes quanto gaudio & attentione tenerentur Socii, dum legeretur syncera et accurata illa descriptio Lacûs Zircknitzensis, cujus miracula, quotquot huc usque de eo scripserunt, non nisi carptim strinxere, ac prætermissis circumstantiis ad causam conjectandam requisitis, pro re omninò portentosa vendidere. Iam verò industria tua et sagacitate factum est, quòd non amplius lateat, unde hi Naturæ lusus insoliti proveniant, atque quod effectus singularis, cujusque in toto terrarum orbe vix aliud extat exemplum, genuinas causas quasi præsentis contemplemur.

Alpes vestras Carnicas plurimis foraminibus ac cavitatibus pervias esse, ex absorptis iterumque emergentibus tot fluminibus quæ in Charta tua Carniolæ videre est, abundè constat. Ac si flumina illa ad subterraneum aliquem lacum concurrunt, (qualem reverà ad pagum vicinum Kumpale reperiri scribis) facilè concipitur repentina pluvia, qualis plerumque fit tonante cœlo, admodum augeri posse Lacûs istius aquas; præsertim cum per præruptas valles, quales sunt

¹ After a photostat of the 'fair copy' in Royal Society Letter-book.

A rough draft is in the Royal Society guard-book, H. 3. 47. The latter gives reference to 'Journal Book R.S. No. 8, pag. 171', and is further endorsed: 'Ansr. to Valvasor's Letter of Novr. 17 concerning . . . Lake Zircknitz.' Valvasor was elected into the Royal Society Dec. 14, 1687.

Alpinæ, præcipiti cursu ferantur collectæ aquæ. Auctas verò in Lacu aquas per alia foramina paulò altiùs sita emitti posse perspicuum est: ac cum talium foraminum ora ità disponi possint, ut aliqua supra aquæ superficiem dehiscant, aliqua verò, aquis licet satis profundè immersa, canales habeant in initio obliquè ascendentes, fieri potest, ut quamvis uno eodemque momento incipiat aqua per utraque illa foramina effluere, tamen hæc non nisi superficiem aquæ eique insidentes Anates deferant; illæ verò partes aquæ inferiores una cum piscibus hauriant. An verò ope Syphonum hæc omnia, uti supponis, rite explicari possint, meritò ambigitur. Syphon enim non nisi repleto utroque ejus crure aquam elevare potest; at postquam defecerit aqua, statim ingresso aëre cessat ejus effectus: ac licet aqua ad priorem altitudinem redierit, tamen priusquam aër de Syphone eductus sit, ne guttulam quidem aquæ elicere potest: quod paucis monuisse sufficiat.

Fluviorum illorum, qui in montes vestros se condunt, vellemus libentissimè historiam naturalem à te addiscere, nisi jam nupero beneficio satis superque obstricti, dum hæc petimus nimis importuni videamur. Saltem verò locorum, quorum in tuis meministi (viz: Grottæ Podpetskio, foveæ Storsegg, pagi Kumpale, S. Cantiani &c.), situs quam fieri potest accuratos, respectu Lacùs Zircknitzensis, in Charta tua geographica Carniolæ notari ac transmitti cupimus: periit enim nescio quo fato Charta illa quam misisti.

Ne Viri adèò in Societatem nostram devoti, tantosque labores ad Scientiam naturalem promovendam perpassi, parum æqui æstimatores videamur, visum est Concilio & Sociis te merito tuo in eorum numerum adsciscere: quod quidem factum est 14^o mensis elapsi, unanimi præsentium suffragio; teque Societatis Regiæ Sodalium saluto gratulorque, atque etiam quod domùs tuæ clades nuperas faustis nuptiis restaurare satagis. Carmina in librum tuum Encomiastica inclusa habes, ac siquo alio modo tibi gratum efficere possimus, semper tibi paratissimum ad omnia officia experieris

Tuum &c.

E. H.

P.S. Quod autem ad hæc carmina spectat, velim tuo utaris arbitrio; corrige, omitte, quod tibi videbitur. Siquid dictum sit, quod nomini & honori tuo minus conveniat, quæso, candidè interpreteris. Vale.¹

¹ Rigaud says: 'This seems to indicate that he [Halley] had addressed some verses to Valvasor, but none have been discovered. This is to be regretted; for it may be seen from what he printed with the *Principia* that his powers were not confined to those branches of study, in which he was most eminently distinguished.' (Rigaud, S. P., *Historical Essay on the First Publication of Sir Isaac Newton's 'Principia'*, p. 85, Oxford, 1838.)

32. To ABRAHAM HILL.¹ 1691.

Pagham, June 22, 1691.

Hon. Sir,

I got down hither this morning by times, and went on board, in order to have gone down and set our people to work; but it was captain Chanterell's advice, that our five-inch hawser, which had scarce been five times used to the capstan, was so far worn, being exceedingly burnt with overtanning, that he thought it unsafe, and therefore desired he might have a new one somewhat larger, of about thirty fathoms; the casks likewise prove not so well as expected. It is the opinion of all who have seen our ropes, that they are the most tarred of any they ever saw, and I am willing to believe it is done for the advantage of the maker, rather than out of any design to baffle and defeat our business. We shall with all diligence prosecute the affair, and I hope now, in a short time, to give you a good account of your ship. This business requiring my assistance, when an affair of a great consequence to myself calls me to London, viz. looking after the Astronomy-Professor's place in Oxford, I humbly beg of you to intercede for me with the archbishop Dr. Tillotson, to defer the election for some short time, 'till I have done here, if it be but for a fortnight: but it must be done with expedition, lest it be too late to speak. This time will give me an opportunity to clear myself in another matter, there being a caveat entered against me, till I can shew that I am not guilty of asserting the eternity of the world. I hope you will excuse this trouble, as it will be of so great service to

Your most obliged, &c.
Edmund Halley.²

33. To NEUMANN.³ 1693.

Reverendissimo Domino D^{no} Casparo Neumann apud Uratislaviam
Pastori Primario ac Judicij Eccles. Assessori Edmundus
Halley S P.

Cum Vir eximie doctus ac de re Literaria optime meritus Dn^s
Henricus Justellus, communi Eruditorum Clade nuper diem obierit,
Optimæ Conjugi ejus literas tuas mecum communicare visum est,

¹ Reprinted from [Astle, Thomas, ed.:] *Familiar Letters which passed between Abraham Hill, Esq., and several eminent and ingenious Persons of the last Century*, p. 136, London, 1767.

² The original letter, which has not been found, was, probably, signed: Edmond Halley.

³ From a photostat of the 'fair copy' in Royal Society Letter-book, vol. xi. Justel died in the Autumn of 1693.

ut ad ea quæ ad me spectant Responsum darem; jubente insuper Societate Regiâ amicitiam tuam excolere, ac si non grave ducas, ad Epistolare commercium de Rebus istiusmodi Virum tantopere ad Arithmeticam ut vocamus Politicam promovendam natum provocare.

Ceterum abundè mihi gratulor hæc prima mea incæpta¹ tibi non displicuisse, atque etiamsi labores tuos præoccupasse videar, deducendo conclusiones nonnullas e Tabulis Emortualibus Uratislaviæ, quas summâ ut apparet curâ concinnasti, nollem tamen præmaturo iudicio ulteriora tua conamina præpedire, sed ex animo hortor, ut concinnatis hisce nascentium ac morientium Rationibus per plures annos, collatis omnibus tutius concludere liceat, non tam de eis quæ nuperâ dissertatione tetigi, sed etiam de multis alijs Genus humanum proximè spectantibus. Porro quoad numerum Incolarum Urbis Vestræ, experimento determinatum iri ope tuâ sperare jubes, quod basis firmissimæ loco erit, ad superstruenda cætera. Numerum vero istum 34000 non multum excessurum post habitum experimentum nullus dubito, cum scilicet ex toto populo nostro tricesimus quisque quotannis moriatur, (uti abundè probavit nobilissimus nostras Dn^s Petty) atque etiam apud vos tot Infantes morbo absumantur, in primo sexennio, ut vix quadragesimus quintus e reliquis post annum absolutum desideretur, nempe concesso numero vestro. Optassem quidem Tabulam numerum vigentium cujusque ætatis complectentem, (qualis pag. 600 habetur) accurato scrutinio a singulis domibus obtineri posse, cujus ope certius ac validius rem totam comprobare daretur, cumque Gradus ille insignis quem in Ecclesia dignissimè possedis, huic negotio exequendo maxime idoneus videatur, non est quod datâ occasione ac otio de benevolentîâ aut industriâ tuâ dubitare debeamus. Vale Domine Reverendissime meque celeberrimi nominis tui cultorem addic-tissimum credas.

34. To SLOANE.² 1694.

Chichester June 12^o 1694.

Sr.

I hope you will please to pardon my neglect in not waiting on you to request of you the favour I now begg, viz: that you would please to take the Minutes of the Society during my absence this summer. I shall make it my endeavour to be serviceable to you in

¹ See Halley's paper in *Phil. Trans.* for Jan. 1692-93.

² After a photostat from the original in Sloane MS. 4036, fo. 175, British Museum.

prosecuting such naturall Enquirys as shall come in my way, and in all things strive to approve my self

Sr. Your most obedient Humble Servt.

Edmond Halley.

35. To SHARP.¹ 1694/5.

London, March 9th, 1694/5.

Mr. Sharp,

I have seen your curious improvement of the method I published in the *Transactions* of May last, where you have apply'd Mr. Newton's invention of the unciaë affixt to the members of very high powers, to so good purpose that I cannot believe it can be carried further, and I congratulate you on your happy discovery. But since in your letter you mention the making the logarithms by this means, give me leave to observe to you, what perhaps you had overlookt, that if instead of 140737488355328 for the index of your power, you use 10000, &c., taken as infinite, and extract by this method the root-bearing unity, the remainder will be Napier's, or the hyperbolick logarithm for that number whose root you extracted. And if you extract the root of the power whose index is assumed 23025851, &c., which is Napier's logarithm of 10, that root unity shall be Briggs his logarithm of the number whose root you extract, wherein you will observe that the only difference between this and the method you lay down will be, that instead of $c, d, f, g,$ &c., you may use $c, \frac{1}{2}c, \frac{1}{3}c, \frac{1}{4}c,$ &c.; and if c be unity with ciphers, then $1 + e + \frac{1}{2}ee + \frac{1}{6}eee + \frac{1}{24}eeee + \frac{1}{120}eeeee + \frac{1}{720}e^6,$ being put equal to any number, e shall be Napier's logarithm thereof, which I find results to the same with what Mercator has with the help of Gregory's improvements done in the Quadrature of the Hyperbola and the construction of the logarithms, as you will easily perceive.

I thought it fit to pay my respects to a person so worthily deserving of the mathematical studies, and if you have any thoughts of Christ's Hospital, it is ere long to be disposed of, and you may in my opinion stand as fair for it as you are deserving it, if it deserve you. In such case you may be sure of all the assistance I can give you, though you will not need it, if Mr. F. [Flamsteed] be willing to befriend you. I shall be glad to hear from you when you can find

¹ Reprinted from Cudworth, William: *Life and Correspondence of Abraham Sharp*, p. 25, London, 1889.

One has reason to doubt the correctness of the printed signature 'Edmund Halley', for it was Halley's custom, when signing his name in full, in English, to spell his Christian name, Edmond. Cf. *Notes and Queries*, 1928, vol. clv, pp. 24-5.

leisure, and you may direct to me, to be left with Mr. Hunt, in Gresham Colledge.

I am, your very loving friend and servant,
Edmund Halley.

Addressed—'For Mr. Abraham Sharp, at Mr. Stansfield's, Bradford.'

36. To NEWTON.¹ 1695.

London Sept. 7^o 1695

Ever Honoured Sr.

Since I left you I have been desirous to make some triall how I could obtain the position of the Orb of the Comet of 1683, and after having gotten some little direction from a course Construction, I took the pains to examine and verifie it by an accurate Calculus, wherin I have exceeded my expectation, finding that a parabolick orb limited according to your Theory will most exactly answer all the Observations Mr. Flamsteed and my self formerly made of that Comett, even within the compass of one minute. If that of 1664 be but well observed, I doubt not of the like success therin, but I fear, for want of Telescope sights, Hevelius could not sufficiently distinguish the Nucleus therof. It is no great trouble and if you think it requisite I will by the same method compute exactly some or all of Mr. Flamsteeds observations of that of 168^o_p, which you say, you did per operationes partim Graphics, being desirous as far as you will permitt it, to ease you of as much of the drudging part of your work as I can, that you may be the better at leisure to prosecute your noble endeavours. I begg your pardon that I have not yett returned you your Quadratures of Curves, having not yet transcribed them, but no one has seen them, nor shall, but by your directions; and in a few days I will send you them. I should be glad of the favour of a line or two from you, to receive your commands in any thing wherin I may be capable to shew my self Sr.

Your most faithfull Servant

Edm. Halley.

37. To NEWTON.¹ 1695.

London Sept. 28^o 1695

Honoured Sr.

I have been hard at work to serve you, and having done the Comet of 1683, which I can represent most exactly; and that of 1664, (wherin I find Hevelius has not been able to observe with the

¹ From a photostat of the original, in the Portsmouth Collection, University Library, Cambridge.

exactness requisite,) as near as I conceivd it possible; I fell to consider that of 168^o₁ which you have described in your book, and looking over your Catalogue of the observed places, I find in that of the 25th of January 1681, that there is a mistake of 20 minutes, in the Longitude that day, or 56 minutes for 36, and so I have it in a Ire Mr. Flamsteed sent me when I was at Paris. I thought fitt to advertise this, because you wrote me you designed to undertake to correct what you had formerly determined about the Orb therof; and that day is one of those you have taken to define the orb by. I find certain indication of an Elliptick Orb in that Comet and am satisfied that it will be very difficult to hitt it exactly by a Parabolick. When I have computed all the Observations, I shall send you what I have done. If you have not gotten Vlacq's great Table of Sines and Tangents to 10 Seconds, I belive I can procure it for you, and shall be glad to serve you therin, well knowing how much it will ease you in the Computations you are at present engaged in; If you still want the book pray lett me know. I must entreat you to procure for me of Mr. Flamsteed what he has observed of the Comett of 1682 particularly in the month of September, for I am more and more confirmed that we have seen that Comett now three times, since ye Yeare 1531, he will not deny it you, though I know he will me.

I am Sr. Your most obedient Servant
Edm. Halley.

38. To NEWTON.¹ 1695.

Honoured Sr.

In answer to yours of the 1st October, I give you many thanks for yr Communication of the Observations of the Comet of 1682 which next after that of 1664 I will examine, and leave it to your consideration, if it were not the same with that of 1607, and when your more important business is over, I must entreat you to consider how far a Comets motion may be disturbed by the Centers of Saturn and Jupiter, particularly in its ascent from the Sun, and what difference they may cause in the time of the Revolution of a Comett in its so very Elliptick Orb.

I have gotten for you Ulacq's Canon magnus Triangularum and will send it you the beginning of next week, it costs me eight shill. and I am very glad I can accommodate you therewith.

As to the Comet of 168^o₁ I was only desirous to trie the method I

¹ From a photostat of the original, in the Portsmouth Collection, University Library, Cambridge. The right-hand margin is worn away in places.

used in that of 1683, in this also, taking your limitation for an Hypothesis I found I could not stirr the Nodes or Inclination; that the Angle between the Aphelion and descending Node was $9^{\circ} 20'$ and the Latus rectum of the parabola .0243 of such parts as the mean distance of the Sun is 1,0000, hence the Aphelion or Axis of the parabola is directed into II $27^{\circ} 22\frac{1}{2}'$ with $8^{\circ} 11'$ North Latitude; and in this is the principall fault of your first determinations: The time of the perihelion I see no cause to alter but that it was Decemb. 8° oh. $4'$ p.m.

From these data by an exact Calculus I derived the following Table to the moments of Mr. Flamsteed's Observations.

		Dist.	Long.	Lat.	Long.	Lat.	Error		
		Comet \odot .	Comp.	Comp.	Obs.	Obs.	Long. Lat. "		
1680.	Decemb.	12	28028	Ψ 6.29.25	8.26. 0	Ψ 6.33.	8.26.	-3.35 + -	
		21	61976	Ξ 5. 6.30	21.43.20	Ξ 5. 7.38	21.45. $\frac{1}{2}$	-1.8 -2.10	
		24	70008	Ξ 18.48.20	25.22.40	18.49.10	25.23. $\frac{3}{8}$	-0.50 -0.44	
		26	75576	28.22.45	27. 1.36	28.24. 6	27. 0.57	-1.21 +0.39	
		29	84021	Υ 13.12.50	28.10.10	Υ 13.11.45	28.10. 5	+0.55 +0.5	
	30	86661	17.40. 5	28.11.20	17.37. 5	28.11.12	+3. 0 +0.8		
1681.	Januar.	5	101440	Υ 8.49.49	26.15.15	Υ 8.49.10	26.15.26	+0.39 +0.1	
		9	110959	18.44.36	24.12.54	18.43.18	24.12.42	+1.18 +0.12	
		10	113162	20.41. 0	23.44.10	20.40.57	23.44. 0	+0. 3 +0.15	
		13	120000	26. 0.21	22.17.30	25.59.34	22.17.36	+0.47 -0.	
		25	145370	Θ 9.33.40	17.57.55	Θ 9.35.48	17.56.54	-2. 8 +1.0	
		30	155303	13.17.41	16.42.47	13.19.36	16.40.57	-1.55 +1.	
		Feb.	2	160951	15.11.11	16. 4.15	15.13.48	16. 2. 2	-2.37 +2.
		5	166686	16.58.25	15.29.13	16.59.52	15.27.23	-1.27 +1.5	
		25	202570	26.15.46	12.48. 0	26.19.22	12.46. $\frac{3}{8}$	-3.36 +1.	
		Mart.	5	216205	Θ 29.18.35	12. 5.40	29.20.51	12. 2.40	-2.16 +3.

Thus you see how near your Theory agrees with the observed Motions and where the errors are greatest the Observation may justly be suspected; for in the first the Comet was just setting within the uncertainties of Refraction, and its places collected from the Suns by Mr. Flamsteed's tables which he now has altered as much as amounts to two Minutes about the Winter Tropic, and I believe that that causes so much of the error in Longitude on Decemb. 12° , and on Decemb. 30th I am apt to suspect that either the observed place was $2'$ more or 17.39 of Υ , or else that the time was $10'$ later. And in Mr. Flamsteeds Ire to me Jan. 1680/1, he writes that at 8h. $30'$ he observed the distance of the Comet from Andromeda's head $19^{\circ} 55' 40''$, and from Markab Pegasi $8^{\circ} 52'$, whence he deduces the Longitude $17^{\circ} 51\frac{1}{2}'$ Υ with Lat. $28^{\circ} 14'$, tho afterwards a copy he sent me agrees with yours. However it be, it is impossible for my numbers to err 2 minutes in one diurnall motion, when I agree so well both before and after.

As to the signs of the Orb's being Elliptick, I think that the

bending thereof towards the Node, towards the End, is an argument of a greater Curvity compared with the other errors, for the Latitude was greater than computed at first and lesser afterwards, which seems to require that the perihelion was somewhat earlier, but that cannot be by reason of the errors in Longitude on Decemb. 29. 30 and Jan. 5 which would be increased thereby. So that I conclude the Angle at the Sun to have been greater than by our Calculation in an orb of the same Latus Rectum, and consequently Elliptick. Perhaps your sagacity may discover how to adjust the matter so as to remove the greatest part of these errors which upon severall attempts I found to hard for me.

I compared this Comets motion in the other part of its orb, whilst it descended and could wish that Mr. Flamsteed had seen it at least once for all the rest are very course observers. the computed places are these.

	eq. Time. d h ' "	Cometa a ☉.	Long	Comput. Lat.	Comput.
Novemb.	16.17.00	83920	28. 0.25	0.43.20	east
	18.21.34	78020	18.41.50	1.17.30	
	20.17.0	72992	28. 1.45	1.44.30	
	26.17.0	54799	26.46.30	2.42.30	

If you think fitting to alter any of these Elements I shall not be wanting to adapt the calculus to your Emendations.

The Comet of 1683 does I think agree rather better with a parabolick orb, at least for so much thereof as we could observe. its Elements are these.

	d h ' "
Perihelion	July. 3.2.50 in Π 25°.29.' $\frac{1}{2}$
Latus Rectum	224080.
Descending Node	\sphericalangle 23°.23'
Inclination.	83.11

But I want time to add the Table of Computed places compared with the Observed, which you shall have by some other opportunity: I find a necessity to derive the places of Hevelius's Comett from the Observations, and not to trust to his computations which costs me some trouble.

I am Sr. Your most faithfull Servt.

Edm. Halley

I had sent this on Saturday night but could not, now it accompanies your Vlacq, which the Carrier brings you.

39. To NEWTON.¹ 1695.
Honoured Sr.

London Octob. 15^o 1695

I hope you recd. the Ulacq's Tables which I sent you on Munday sennight and with it the Theory of the Comett of 1683, and the computed places of that of 1680/1. Since then I have with some difficulty mastered that of 1664/5, but I was obliged to have recourse to the observations themselves, and to adjust and compare them together, and recalculate the whole, before I could make them agree with any tollerable exactness, and I suspect that Mr. Hevelius, to help his Calculations to agree with the heavens, had added 8 or 9 minutes to the places observed, on the 4th, 5th, and 8th of December, for I find the true places to be as on the other side of this sheet. And what confirms the whole is that without any forcing, the Last appearence of this Comett on Mart. 1. does sufficiently agree with all the rest: so that I think there can be nothing plainer than that Comets do move in orbs about the Sun, exceeding near to parabolick; and since in this comett of 1664, Cassinis Numbers,² which supposes the Earth to stand still, differs near two degrees from the observed places, it may be concluded that that Hypothesis is incapable to represent its motion nearer, wheras this of yours traces out its course as exact as the best Astronomical Tables can any of the planets, notwithstanding that this Comett came so near the earth as to encrease its visible velocity near ten fold. I had mislaid my book wherin I made my Lunar computations, so could not send it you, but having rummaged for it, and found it, I will send it you this week hoping it may be of some service to you. Next to this, I will examine the Comet of 1682 and send you the result, hoping it will give me no great trouble, because the observations I presume are exact: Sr. pray please to command me in any thing you conceive I may be capable to serve you, and you shall be assured that with all readiness I will approve my self.

Your most faithfull Servant

Edm. Halley.

40. To NEWTON.¹ 1695.
Sr.

Octob. 21^o, 1695.

In your last you have amended the orb of the Comett of 1680/1 from what I could do, and I am glad you concurr with me in the conclusion that it must be Ellipticall, and from your limitations I have recomputed the Comets places, as follows.

¹ From a photostat of the original, in the Portsmouth Collection, University Library, Cambridge.

² The original has *Theory* crossed out and *Numbers* written above.

			Error. Long.	Lat.
Decemb. 21°	☿ 5. 7.30	21°.42'.49" Lat.	-0' 8"	-2'.41"
29	♄ 13.12.22	28.10. 5	+0.37	+ -
Jan. 5	♃ 8.49. 3	26.15.32	-0. 7	+0. 6
25	♁ 29.33.40	17.58.35	-2. 8	+1.41
Mart. 5	♂ 29.19.19	12. 6. 9	-1.32	+3.29

By which it appears that you have every where corrected the Longitudes. But for the Latitudes the error both at first and last is about $\frac{1}{2}$ a minute greater, which I hope you will be able to remove when you come to determine the species of the Ellipse.

I have almost finished the Comet of 1682 and ye next you shall know whether that of 1607 were not the same, which I see more and more reason to suspect. I am now become so ready at the finding a Comets orb by Calculation, that since you have not sent ye rulers, as you wrote me, I think I can make a shift without them. And I intend as far as I can to limitt the Orbs of all the Comets that have been hitherto observed, of all which I shall duly give you an account. I have sent you the book wherin I did most of my Lunar Computations, and would have made an Extract therof, but am at present busy about the Society's Books, and withall I belive the whole work will be more satisfactory.

There is in the Book of my Lunar Observations a Table of the Nonagesime degree and its altitude, which will be worth your Calculators while to transcribe. I mean that made for the Lat $51^{\circ} 30'$, which will be of use to find the parallaxes by.

Sr. I am With all imaginable respect
your most devoted friend and Servt.

Edm. Halley.

The node of the Comet being $\odot 2^{\circ}. 2'$ the angle in the plain of the Orb between the Node and Aphelion is $9^{\circ}. 22'. 48''$. The Latus rectum 0,0245 ye radius being 1.

41. To NEWTON.¹ 1696 (?)

Sr.

I had waited on you on Saturday, but I was obliged to go on board my frigatt, and besides I could not get time to finish the

¹ From a photostat of the original, in the Portsmouth Collection, University Library, Cambridge. The concluding words, about Halley's serving Newton, as his Deputy, indicate that this letter may have been written early in the Spring of 1696, before Halley was appointed, by Newton, as Deputy-Comptroller of the Mint at Chester. But Halley's reference to his going on board his 'frigatt' seems to imply a date after 19 August 1698, when Halley was appointed 'Master and Commander of his Maty. Pink the Paramour'. If, so early as the Spring of 1696, Halley was in charge of a 'frigatt', there appears to be no record of it now. Yet, as Newton was lodged at the Mint in the Tower of London, in 1696, we must believe that this letter was written in that year.

account of the two Comets I promised you. I find the Inclination Evidently less than that of the Comet of 1682, in the other of 1607, but some of the observations will allow it the same; they being by no means sufficiently accurate. Your self will best judge whether they may be safely concluded to be the same, as is my present opinion. I will waite on you at your lodgings to-morrow morning to discourse the other matter of serving you as your Deputy.

42. To SLOANE.¹ 1696.

Chester Castle. Octob. 12^o 1696

Honoured Sr.

I hoped to have sent you by this time the Journall book of the Society compleat, but a great glut of business, at the first opening of our Mint, requiring a constant attendance, has hindred me for some time, so that I must begg your excuse at present, but will speedily return you the Books, filled up to the last recess of the Society, by some safe hand. In the mean time the Society meeting on Wensday next, I have sent you the Minutes of the last Day when the Society adjourned, which you may please to separate from this. † There are severall Antiquities in and about this place in custody of private persons, of which I will take care to give you a description; and the scituation of the City is very remarkable; being at the place where the river Dee ceases to flow, upon any other than spring Tides. And the walls and all publique buildings are of a stone which is afforded by Quarries which are upon the spott, and in many places appear in the Ditch of the Town, which convenience I suppose occasioned the Romans to found the City here, which is square like the Roman Castra, and each side is about 600 or 700 Yards. and here was for a long time the head Quarters of the Legio XX. called Victrix. I carried my Magneticall needle with me, but have not yet drawn a Meridian line with all the exactness requisite, so can only tell you that the Variation of the Needle here is considerably less than at London, and as I guess, not fully 4 degrees. but in a little time I will ascertain it. Please to give my humble Duty to the Society, and entreat them to excuse me this absenting my self from my post in their service. I conceive the time therof will not be long, and I hope I may be in some measure serviceable to them here. Pray present the Inclosed to Sr. John Hoskyns with my humble service

I am Dear Sr. Your most obedient servant
Edmond Halley.

Conceall my letter to this mark †.

¹ After a photostat from Royal Society guard-book, H. 3, 48.

43. To SLOANE.¹ 1696.Chester Mint Octob 26^o 1696.

Kind Sr.

I received yours and shall not be wanting, as this place will furnish me, to supply the Society with such information as I conceive may be acceptable to them. and particularly where I shall receive their commands to enquire into any matter. The account the Society had from Dr. Wallis about a year since of a Greyhound-dogg that voided an animall resembling a whelp P anum, as strange and incredible as it may seem, is yet here stedfastly believed, and the creature was kept for some time in spiritt of wine, having lived for some short time after it came into the world: and it was seen alive by Mr. Roberts of the Society, then in Chester. They say it exactly resembled a Grayhound whelp, and had on its side a large spott, in the same place as the Dogg it proceeded from, had such another; and that with it was voided a considerable quantity of a whitish mucous matter, so that the people here will not permitt me to question the truth therof. Mr. Roberts who saw it at first, can best judge what credit this uncouth story merits. But this is certain that it cost the Dog his life, to gratifie the curiosity of some Gentlemen here who dissected him, but were disappointed of their expectations. for my own part, as I am determin'd *nihil temere credere*, so on the other hand as I dare not pretend to limit the powers of Nature, I suspend my opinion, laying only before you what credible wittnesses do assert.

I this morning got a sight of an altar peice dugg up here, about 3 years since, and took the inscription therof which is pretty entire but roughly cut in the stone of the place, which is soft and moldring nor capable of long continuance when it is exposed to the Air, it has the following inscription

PRO . SAL . DOMIN
 . . . IM NN INVI
 CTISSIMORVM
 AVGG . GENIO LOCI
 FLAVIVS LONG . . .
 TRIB . MIL . LEG XX
 LONGINVS FLA
 VIVS . DOMO
 SAMOSATA
 V. S.

I suppose VS there not
 being roome for NVS

¹ After a photostat from Royal Society guard-book, H. 3, 49. The greater part of this letter was printed in the *Phil. Trans.* (1696), vol. xix, p. 316.

By the Title of Domini nostri given to the Emperors it appears that this inscription was of the Bas empire not before Dioclesian nor yet so late as Theodosius it being pagan. The stone it self is about 32 inches high. 16 in breath and 9 thick: On the one end is engraven not very curiously the resemblance of a Genius holding a cornu Copia. on the other is a flower pot somewhat better performed, but a little endamaged by the softness of the Stone. The Back side opposite to the inscription is adornd with a pretty sort of feuillage designed to fill up the vacant space. On the topp in a preey deep cavity is a full face of a man almost such as they paint the Sun or full moon withall with a capp upon his head. of which as yet I can not comprehend the design. I submitt it to the disquisition of the Society & if it may be thought requisite I will more particularly inspect and describe this Stone, which is in the Custody of one Mr. Prescott here a great lover of antiquity and who has severall curiositys by him which I am promised to peruse.

The Stone of this place, which is soft reddish gritt and very friable with shining particles intermixt, is very apt to decay with the weather, so that all old buildings are very much defaced therby, and the walls which are built therof, are so frequently out of repaire, that they have officers on purpose whom they call Murengers, who do gradually refit them, where they are most worn out; in some places the stone is in a manner mouldred away like sammel bricks in a wall, leaving the mortar standing. In these Stones and the Quarries from whence they came, I have diligently sought for shells or other animall substances, such as are often found in other places, but hitherto have found no such things: but the Stone is generally intersperst with pebbles and small flints, which as ye stone decays do discover themselves within it, as if they had been lodged in the Sand wherof the Stone consists before its induration.

I hope to find something to entertain you weekly withall especially if you please to direct my enquiry. Wee proceed lightly in our business of Coining and should soon have done, were we not limited to small mony, only shillings and sixpences. Pray give my humble duty to the Society and pray desire Dr. Hook to take Care of the Eclipse next Friday morning.

I am Sr. Your most faithfull Servt.

Edm. Halley.

44. To SLOANE.¹ 1696.Chester Mint. Novemb. 2^o 1696.

Sr.

Since my last we have been exceedingly prest with the receipt of Clipt moneys, so that I have had little leasure to look after any sort of philosophicall matters, only the Eclipse of the Moon on Friday morning I sat up for, but by reason of flying clouds, which let the Moon appear only by short intervalls, it was impossible for me to take the principall Phases; Only the Beginning (as near as I could estimate it) was much about 2h. 45' after Midnight, and in about an hour succeeded the totall Darkness. I say only, *about*, for we could not have any steedy observation by reason of the Clouds, and as to the Emerging appearance, during the whole time therof the Moon was scarce one minute together visible. I hope you have had better fortune at London. And I must wait an other opportunity to ascertain the Longitude of this place, which before I return I will accurately performe. We have here two curious mills, the one a Water mill that forces up the water of the River Dee, for the use of the Town, into a cistern, half a mile from the mill, upon the highest part of the Town: whence by pipes it is conveyed for the use of the Inhabitants. The other a windmill, built severall years since, and now out of use, being a stout pile of brick buildings, wherin a Mill with Horizontall sayles is contrived, so as to admitt the wind on one side, and exclude it on the other, by the opening and shutting of severall windows adapted for the purpose. I shall against next week be able to procure an exact description of both of these Mills and shall transmitt them to you, for part of your next Wednesdays entertainment. Wee coine apace and have already paid of 3000 li: but the mony, especially since the late vote of Parliament, flows in upon us, that wee would gladly be permitted to Coine, at least half Crowns, for otherwise all our endeavours will not satisfie the importunity of the Country. Pray give my humble duty to the Society, and please to let me know now and then the principall occurances that come before you.

I am Sr. your most obedient Servt.

Edm. Halley.

45. To SLOANE.² 1696.

Kind Sr.

I most humbly entreat you to pardon my silence for so long time tho I have to allege in my defence a quotidian Ague wch held me

¹ After a photostat from Royal Society guard-book, H. 3, 50. Endorsed: 'Read Nov. 4, 96.'

² Dated in endorsement Chester, 25 Nov. 1696. After a photostat from Royal Society guard-book, H. 3, 51.

for some time indisposed, and the bad weather and short days have hindred my designed visit to the Windmill I menconed which is out of town; but my justest excuse is that I have been in a manner wholly employed in our Mint business which we press on with all possible diligence, being in hopes shortly to have my whole time at the Societys service and to be able to return by spring: for the Country has done bringing in of Clipt moneys untill they see what the act of Parliament now before the Lords will ordain: We are now in a condition to give great dispatch and have for some weeks coined about 3000 li in shill and sixpences and shall be able to double the summ when we coin half crowns as we shall begin to do next week, so that wee hope to have all the Bullion in our hands recoined soon after Christmass.

I have an account of the Windmill that it is performed with all the artifice possible to make it go easy, but that admitting the Wind only by a Window and but upon one saile at a time, it did not move without a strong gale of wind, and therefore was so seldome serviceable, as at length to be laid aside as useless and has not gone for some years, however I will see it and if there be any thing curious or particular shall send an account of it.

The Waterwork here I have seen, and it is extreemly simple—being no other than a plain and simple undershot water wheel turned by the fall of the River with a triple crank on its Axis without any coggs or other apparatus, wherby the water is forced into 3 barrills into a pipe which conveys it to a Cistern about half a mile from it, and about 60 foot above it, in the market place on the highest ground of the Town whence it runs in small branches into all the parts of this City, and makes a very good revenue for the proprietor, and the river water being usually turbid, has the opportunity of fining in the great Cistern before it be distributed among the Inhabitants.

The river Dee at this time runs very plentifully with a great fall of fresh water over a damm or causeway made purposely to give the water a force to drive the Mills that are here at both ends therof, and it roars over it, much like the fall of London bridge; the spring Tides only reaching the head of this Damm, therby stopping the mills for about an hour and half each Tide: But on the neap Tides or Quarter Moons; the Tides are scarce sensible and the mills work without ceasing: In summer time I am assured that this great river does scarce suffice to drive the mills, all the water passing by the Mill Tayles, and rarely unless upon land floods running over the Causway: which considering its present abundance

I could scarcely credit, if I did not know that it runs through the lake of Bala in Wales, which I conceive may be large enough in hot weather to exhale the greatest part of the water it receives from the springs arising in the Welch mountains, which in the colder seasons do evacuate themselves into the Sea. The spring tides here rise about 6 foot the neaps scarce two. and S. by East Moon makes high water as it does all over this part of the Irish Sea. I have just got leasure to read over Mr. Sellers's account of Palmyra, which has been sent me; I find he has been very carefull not to own any thing he had out of my account in ye Transaction No. 218, and never mençons me but where he is willing to contradict me; which has obliged me to remark some things wherin I am sure he has lapsed, which I hoped to have drawn up fitt for a Transaction and have sent you by this post, but not being able to get it ready to my mind, I must begg your patience till this day Sennight, when for the entertainment of the Society you may please to present them with an account I am preparing for them

I am Sr. Your most obedient Servt.

Edm. Halley.

I wish you a happy Election and should be glad to hear the success therof. Pray give the Gentlemen of the Society my most humble Service.

46. To SLOANE.¹

Sir

Chester April 5, 1697

The enclosed will serve for an entertainment to the Society, and the characters may very well deserve a place in the transactions, wherein I gave the brief history of Palmyra. I think it would not be amiss to engrave them in their full dimensions, as they are in the paper, which was taken from the stone itself. I am just now booted to goe for Hollywell, and shall next give you an account of what I observe there, and I have made a party to go to Snowdon at Whitsuntide and shall need the Societys assistance and direction as to what they would have me enquire into there.

I am your &c.

Edm. Halley.

47. To SLOANE.² 1697.

Sr,

Chester. Octob: 25, 1697.

I hoped to have waited on the Society by their first meeting after their recess, but as yet the business of our Mint is not in such a

¹ Printed from the 'fair copy' in the Letter Book of the Royal Society.

² After a photostat from the original in the Royal Society's archives. The middle part of this letter was printed in *Phil. Trans.* (1697), vol. 19, p. 784.

condition, that I can be spared for good and all; though in a month I guess we shall have finished our whole coinage, which will be of very near 300000 li: and besides I am subpœna'd on a Triall, which will not be till this day 3 weeks. In the mean time my heart is with you, and I long to be delivered from the uneasiness I suffer here by ill company in my business, which at best is but drudgery, but as we are in perpetuall feuds is intollerable.

I observed the late Eclipse of the Moon Octob. 19 with all the satisfaction I could desire, the air was all the while very still and clear so that I think the observation may be very much depended on, and will with sufficient exactness give the Longitude of this place.

	h. ' "	Emersions.	h. ' "
The Beginning.	6. 8½	<i>Porphyrites</i> and the Middle of M.	
<i>Porphyrites</i> imerged	6.16	<i>Ætna</i>	8. 7.00
North Part of <i>Mærotis</i>	6.21½	<i>Horminius</i>	8.17.30
<i>Lacus Niger Major</i> and South End		<i>Mons Herculis</i>	8.18.30
of <i>Mærotis</i>	6.26	<i>Besbicus</i>	8.21.00
<i>Besbicus</i>	6.46¾	<i>Apollonia</i>	8.26.15
<i>Apollonia</i>	6.49½	<i>Byzantium</i>	8.29. 0
<i>Byzantium</i>	6.53	<i>Lacus Niger Major</i>	8.32. ½
<i>Horminius</i>	6.59	S. Part of <i>Mæotis</i>	8.35.
N. Part of <i>Mæotis</i>	7. 2½	N. Part of <i>Mæotis</i>	8.43.
<i>Mons Corax</i>	7. 3½	The End.	8.49. ½
<i>Mons Herculis</i>	7.10		
S. Part of <i>Mæotis</i>	7.12½		

About the middle there remained 9'.26". of the Luminous Part and consequently the Digit. Eclipsed, 8¾.

I should be glad to see what was done in this Eclipse at Gresham Coll. or Greenwich, and if any other exact observations therof be come to the Society. I have a particular and very extraordinary account of an Iris I saw here, the like wherof I never read of or heard described which shall entertain you at the next meeting.

I am your most obedient Servant
Edm. Halley.

48. To J. BURCHETT.¹ 1698.

Portland Road Novemb 1°. 1698.

Honoured Sr.

Last Saturday afternoon I past through the Downs to the Westwards, without anchoring, being unwilling to loose the opportunity

¹ This and other letters reproduced herein, which were written by Halley during his two voyages in 1698-1700, were addressed to Josiah Burchett, Secretary to the Admiralty, London. The copies here presented are from photostats of the original letters, preserved under the heading of 'Captains' Letters, 1698-1700', in the Admiralty Archives, Public Record Office, London.

of a fair wind; the next day it blew so hard as to put us by our Topsails, and yesterday being gott the length of Portland the Wind came up at West and W.S.W. which obliged us to putt in here. The Pink proves an excellent Sea-boat in bad Weather, and sails reasonably well Large, but goes to windward but indifferently, which perhaps may be amended by finding her trimm. During the bad weather on Sunday, her streining opened some leaks which are considerable for a new shipp, and have discovered an evill wee did not foresee; for having only hand pumps, and our ballast being Sand, the bilge water with the motion of the shipp brings the Sand to the pumps and choaks them, and we have pumpt up abundance of Sand with the Water, which galls and wears the pumps. Wherefore my Officers have remonstrated the necessity of shifting the ballast for shingle as also of caulking her upper works, which wee find very leaky. I therefore humbly entreat that their Lopps¹ please to send their Order to the Docks at Portsmouth and Plymouth, that if the Paramour pink come in there, they with all possible dispatch cause her ballast to be shifted for Shingle, and the vessell brought on the Wey's, and searcht and caulked where need shall require. I hope two or three days may suffice for all we have to do.

I am your most obedient servt.
Edm. Halley.

49. To BURCHETT. 1698.

Honoured Sr.

When I wrote to you from Weymouth road, it was so dead calm that it was impossible for me to guess whether the next wind would be fair for Portsmouth or Plymouth, but soon after a strong Westerly wind sprung up, which brought us hither yesterday. I waited on the Commissioner and gave him the account I wrote you, of the ill condition of our ballast in relation to our pumps, and it was his opinion that my demand to have the ballast shifted and the leaks search'd, was so necessary that he needed not to stay for an order from above, however their Lopps letter will have the effect to get me the sooner dispatcht, which therefore I humbly hope will not be denied to

Your Honours most obedient Servt.
Edm. Halley.

Spitt head
Novemb 4^o
1698.

¹ Halley's abbreviation for 'Lordships'.

50. To BURCHETT. 1698.

Portsmouth Novemb. 28^o 1698

Honoured Sr.

In persuance of their Lopps orders, the Commissioner here has caused me to be dispatcht with all the Expedition I could desire, and on the 22th instant I joyned Admirall Benbow at St. Hellens, who lies there only expecting a fair wind. Our people were somewhat doubtfull of going alone, for fear of meeting with a Sallyman, but if we can keep the Admirall Company those apprehensions are over. He has promised to take care of us; but if their Lopps shall think fitt to recommend us to him, in their next letters, it will assure me of his protection; which the weakness of my own compliment in all respects, makes me very desirous of. This is the last favour I have to begg, and I humbly hope it will not be refused to

Honoured Sr. Your most obedient servant
Edm: Halley.

P.S. Novemb. 29 *mane*. The wind is now come up at N.E. and I belive wee shall saile this day, but the Admirall calls in at Plymouth for the Dreadnought.

51. To BURCHETT. 1698.

Madera Decemb 19^o 1698

Honoured Sr.

On the sixteenth Instant I arrived at this Island together with the Gloucester, the Falmouth, the Dunkirk and Lynn frigots, under the Command of Rear Admirall Bembow. By reason of the Holydays it was not possible for the Shipps to have their Wines on board before this day, wch occasioned the Admirall to leave the Island the same night he arrived, being unwilling to waite so long. I have gotten my self dispatcht, and shall persue my Voiage with the first wind it being now Calm. I thought I ought to give their Lopps an account of our arrivall here, not finding that there were any letters left for you by the Admirall here; who left the Island in all diligence.

I am Your Honours most obedt. Servant
Edm. Halley.

52. To BURCHETT. 1699.

Honoured Sr.

I have had no opportunity to give their Lopps any account of my proceedings since my last of Decemb. 20^o from Madera. That

same day I sayled for the Cape de Virde Islands and arriving at St. Jago on Jan. 2^o, I found there two English Marchāt shipp, one of which calld the New Exchange, wherof one John Way is Master belonging to London, was pleased, instead of saluting us, to fire at us severall both great and small shott. We were surprized at it, and believing them to be pirates, I went in to windward of them and bracing our head sailes to the Mast, sent my boat to learn the reason of their firing. They answered that they apprehended we were a pirate, and that they had on board them two Masters of vessells, that had been lately taken by pirates, one of which swore that ours was the very shipp that took him; wherupon they thought themselves obliged to do what they did in their own defence. Then they sent on board me the two persons they said were the Masters of the taken Vessells, and soon after the two Masters came themselves, they said they were sorry that they had fired at the Kings Colours, but that Colours were not to be trusted. I told them I must acquaint their Lopps with what had past, and if their Lopps would put it up, as it hapned they had done me no damage. The next morning they both sailed; and upon our arrivall here we found the said Master John Way and his shipp in this road. From St. Jago we proceeded to the southward and being gotten within 100 leagues of the line, we fell into such calmes and small southerly gales, that our shipp being very indifferent to windward, we were full seven weeks before we gott 100 leagues to the Southward of the line, in which time our water being near spent, obliged us to recruite it on the coast of Brasile. By this time twas March and we found the Northerly Currents made against us, and we upon the Lee-shore; so that it would have been scarce possible for a more winderly shipp than we, to turn to the Southward. And the winter advancing apace in those Climates I principally entended to discover, I thought it not adviseable to proceed that way at this time of the year; hoping it may give their Lopps some satisfaction if I do curiously adjust the Longitude of most of the Plantations and see what may be discovered in relation to the Variation of the Needle in the Northern Hemisphere. Twas the last of November before we left the coast of England, wch considering the uncertainty of the Winds was I find above two months too late: but I hope to be in England time enough to proceed again this year if their Lopps shall think fitting to allow it. We wated in the river of Paraiba in Brasile where the Governour Dom Manuel Soarez Albergaria was very obliging and civill, but the Portuguez, as farr as I could guess, were very willing to find pretences to seize us, and tempted us severall times to meddle with

a sort of wood they call Poo de Brasile which is an excellent dye, but prohibited to all foreigners under pain of confiscation of Shipp and goods. I being aware of their design absolutely refused all commerce with them, and having gotten our water we arrived here in three weeks, the second of this month: Our whole shipp company is here in perfect health and our provision proves very good.

I am Honoured Sr Your most obedient Servt.
Edm. Halley.

Paramour pink
in Barbadoes road
Aprill 4^o 1699.

53. To BURCHETT. 1699.

Honoured Sr.

I this day arrived here with his Maties: Pink. the Paramore in 6 weeks from the West Indies, having buried no man during the whole Voiage,¹ and the Shipp being in a very good condition. I doubt not but their Lopps will be surprized at my so speedy return, but I hope my reasons for it will be to their satisfaction. For as, this time, it was too late in the year for me to go far to the Southwards, I feared that if I went down to Jamaica, and so to Virginia &c. the same inconvenience of being late might attend me in case their Lopps, as I humbly hope, do please that I proceed again for I find it will be absolutely necessary for me to be clear of the Channell by the end of August or at farthest by the middle of September. But a further motive to hasten my return was the unreasonable carriage of my Mate and Lieutenant, who, because perhaps I have not the whole Sea Dictionary so perfect as he, has for a long time made it his business to represent me, to the whole Shipp company, as a person wholly unqualified for the command their Lopps have given me, and declaring that he was sent on board here, because their Lopps knew my insufficiency. Your Honour knows that my dislike of my Warrant Officers made me Petition their Lopps that my Mate might have the Commission of Lieutenant, thereby the better to keep them in obedience, but with a quite contrary effect it has only served to animate him to attempt upon my Authority, and in order therto to side with the said officers against me. On the fifth of this month he was pleased so grosly to affront me, as to tell me before my Officers and Seamen on Deck, and afterwards owned it under

¹ Cf. p. 8, notes 5-6.

his hand, that I was not only uncapable to take charge of the Pink, but even of a Longboat; upon which I desired him to keep his Cabbin for that night, and for the future I would take the charge of the Shipp my self, to shew him his mistake: and accordingly I have watcht in his steed ever since, and brought the Shipp well home from near the banks of Newfound Land, without the least assistance from him. The many abuses of this nature I have received from him, has very sensibly toucht me, and made my voiage very displeasing and uneasy to me, nor can I imagine the cause of it, having endeavoured all I could to oblige him, but in vain. I take it that he envys me my command and conveniencies on bord, disdaining to be under one that has not served in the fleet as long as himself, but however it be I am sure their Lopps will think this intollerable usage, from one who ought to be as my right hand, and by his example my Warrant Officers have not used me much Better; so that if I may hope to proceed again I must entreat their Lopps to give me others in their room.

Notwithstanding that I have been defeated in my main design of discovery, yet I have found out such circonstances in relation to the Variation of the Compass, and the method of observing the Longitude at Sea, (which I have severall times practised on board with good success) that I hope to present their Lopps with something on those articles worthy of their patronage. I humbly entreat yr Honour to expedite my orders into the Downs, and if it be their Lopps pleasure, that the Shipp continue there for some time, they please to give me leave to come up to waite upon them, to give them a fuller account.

I am Their Lordships and Your Honours most obedient servt.
Edm. Halley.

Plimouth

June 23^o 1699.

54. To BURCHETT. 1699.

Honoured Sr.

I arrived yesterday morning in the Downs from Plymouth, whence I sayled on Sunday. I was obliged to waite on Sr. Cloudsley Showell that day, to see if we had any orders; but finding none, I obtained of the Flagg leave to come up to London, so that to morrow I will be sure to wait upon your Honour, and hope to find an opportunity to present my self to their Lopps. Your Honour will please to excuse my not writing by the last post, the Admiralls house

being about seven miles from hence, occasioned my loosing the advantage therof

I am Your Honours most obedient servt.
Edm. Halley

Deale
June 29^o 1699.

55. To BURCHETT. 1699.

Honoured Sr.

Yesterday at the Court Martiall¹ I fully proved all that I had complained of against my Lieutenant and Officers, but the Court insisting upon my proof of actuall disobedience to command, which I had not charged them with, but only with abusive language and disrespect, they were pleased only to reprimand them, and in their report have very tenderly styled the abuses I sufferd from them, to have been only some grumblings such as usually happen on board small Shippes. My Lieutenant has now declared that I had signally disoblighd him, in the character I gave their Lopps of his Book, about 4 years since, which therefore, I know to be the cause of all his spight and malice to me, and it was my very hard fortune to have him joyned with me, with this prejudice against me. Howsoever their Lopps may resent it, I am sure that never any man was so used by a Lieutenant as I have been, during the whole term of the Voiage, nor could I any wais help my self when abroad: It remains for me to shew their Lopps that as to the Principall business I went upon, my Voiage has not been ineffectuall, and I humbly hope they will suspend their censure till I can prepare for them the Theory of the Variation of the Compass and of the changes therof, for which I have now obtained a competent stock of Materialls. I have my sailing Orders, but it blows so fresh at North that the pilote thinks not fit to weigh.

I am your Honours most obedt. Servt.
Edm. Halley

Paramore pink riding in the Downes
July 4^o 1699.

56. To BURCHETT. 1699.

Honoured Sr.

Long Reach July 8^o 1699

These may serve to acquaint you, that in persuance of the Orders I received from Sr. Cloudsley Shovell, I arrived this day with his

¹ The Admiralty's order for the Court Martial of Lieut. Harrison was dated '29 June, '99' (cf. *Knowledge*, vol. xxxiii, p. 168, London, 1910). See also Luttrell's *Brief Relation of State Affairs*, vol. iv, pp. 532-3, 538, Oxford, 1857.

Maties: Pink the Paramour in this place, where having delivered her Gunn's and stores I am to proceed to Deptford: Which shall be performed with all possible Expedition.

I am your Honrs: most obedt. Servt.
Edm. Halley

57. To BURCHETT. 1699.

London August 23^o 1699

Honoured Sr:

The Paramore Pink being refitted and almost ready to come out of the Dock, I humbly entreat their Lopps would please to renew my Commission, in order to the Shipping my Complement of Men, which though small may require some time: For the expediting therof I humbly hope your Honours favour Being

Sr Your most obedient servt.
Edmond Halley

58. To BURCHETT. 1699.

Honoured Sr.

The Paramour Pink is at present in such a forwardness, that I hope to be ready to saile in a Weeks time. Their Lordships were pleased to allow me 100 li impress money for ye former Voiage, which still remains almost entire in my hands; I humbly hope they will now please to give their directions to the Navy board, that the residue therof may be allowed me for the same purposes in this present Voiage. And wheras their Lopps have been pleased to appoint me a Boatswaine with one Arm, who by consequence can be of little service in case of extremity, I am obliged to begg the succour of 3 or 4 men more; which as I content my self with a Mate only, will be born on the Shipp with the same charge as in the former Voiage, when I had a Lieutenant allowed me.

I am Your Honours most obedt. Servt.
Edm. Halley.

Sept 4^o
1699.

59. To BURCHETT. 1699.

Honoured Sr.

I entreat that in the orders their Lopps please to give me, it may be specified that I endeavour to make discovery of the South unknown lands, between Magellan Streights and the Cape of Good

Hope, between the Latitudes of 50° and 55° South, if I meet not with the Land sooner.

I am Your Honours most obedt. Servt.
Edm. Halley.

Sept. 12^o
1699

60. To BURCHETT. 1699.

Honoured Sr.

You were pleasd to tell me yesterday that their Lopps were consenting to allow me the imprest money now in my hands, for the use of my present Voiage. I now humbly entreat your Honour would please to signifie their pleasure therin, to the Navy board, and I shall then be ready to waite on you for my last orders.

I am your most obedt. Servant
Edm. Halley

I am bound to attend the Navy board this morning and therefore must begg your Honours excuse that I waite not on you my self.

61. To BURCHETT. 1699.

Downs Sept. 21^o 1699.

Honoured Sr.

I gott into the Downs this day, just time enough to make use of the Post, to give you an account therof; as also that we find the Paramore, now we have her by the stern, to saile much better than formerly; and to goe much better to windward, so that my hopes are, I shall have no further cause to complain of her. With my humble duty to their Lopps I remain

Your Honrs. most obedt: Servant
Edm. Halley.

62. To BURCHETT. 1699.

Downes Sept. 26^o 1699

Honoured Sr.

Yesterday the wind coming up at NW most of the small craft weighd out of the Downs, and were followed afternoon by his Maties: Shipp the Winchester, but before Sunn sett the wind shifted to W and WSW, so that they were all taken short off of Folkston; A Guiney man of 30 Gunns having promisd to keep me company 800 Leagues, did not think fit to weigh with so scant a wind, [so] I remaine here. This morning the wind is at SW b S, so if it blow fresh, we expect the return of those that sailed yesterday.

I am ready to saile with the first wind, but belive that their Lopps are not willing to hazard the Shipp to the Rovers of Barbary, by my going alone, before their ports, with so small a force.

I am Honourd Sr. Your most obedt. Servt.

Edm. Halley.

63. To BURCHETT. 1699.

Honourd Sr.

This morning the wind coming up at ESE a fine gale, I am now under saile to the Westwards in Company of the Falcon bird a Shipp of good force belonging to the Royall African Company, and I hope this wind may carry us clear of the Channell, in which case I am morally assured of my passage to the Southward. I humbly entreat your Honour will please to afford me your good opinion during my absence, and at my return I am fully perswaded I may be able to answer the expectations of those who perhaps censure the performances of my last voiage without examining all the Circonstances.

I am Honourd Sr. Your most obedt. Servt.

Edm. Halley.

Downs
Sept. 27^o
1699.

64. To BURCHETT. 1699.

St. Jago Octob 28^o 1699

Honoured Sr.

These are to acquaint you, that I left the Downs on the 27th past, and on the 12th Instant was got into the Latitude of Madera, where the wind shifting from NW to NNE, put me to Leeward of the Island, and I thought it not adviseable to beat to windward so much in the way of the Salleteens. So I made the best of my way to these Islands and arrived here the 25th about Noon. I have already filled all my water, and this morning saile to the Southwards; my Ships company is all well and my Officers as forward this time to serve me, as they were backward the last, so that I now proceed with great satisfaction, and hope to see the limits of my Voiage before the New year.

I am Your Honours most obedt. Servt.

Edm. Halley.

65. To BURCHETT. 1700.¹

Honord: Sr.

I must Intreat you to lay before the Lords of the Admty. this account of what I have done in execution of the Orders I Received from them. Since my last from St. Iago, which I hope came long since to Your hands, haveing not been able to fetch Madera by reason of the winds shifting upon me, I was Oblaged to putt into Ryo Jennero in Brasile to gett some Rumm for my Ships company, from whence I wrote you a letter which I suppose will not be in Engld: soe soon as this. I left Ryo Jennero on the 29^o of December last and stood to the Southward till the 1st of February, when being gotten into my Station Vizt. in Lattd: 52 $\frac{1}{2}$ ^o and 35^o west Longitude from London, we fell in with great Islands of Ice, of soe Incredible a hight and Magnitude, that I scarce dare write my thoughts of it, at first we took it for land with chaulky cliffs, and the topp all covered with snow, but we soon found our mistake by standing in with it, and that it was nothing but Ice, though it could not be less then 200 foot high, and one Island at least 5 mile in front, we could not get ground in 140 fadtham. Yet I conceive it was aground, Ice being very little lighter then water and not above an Eight part above the Surface when it swims; It was then the hight of Summer, but we had noe other signe of it but long Days; it froze both night and day, whence it may be understood how these bodies of Ice are generated being allways increased and never thawing. The next day February the 2d. we were in Imminent Danger to looss our ship and lives, being Invironed wth Ice on all Sides in a fogg soe thick, that we could not see it till was ready to strike against it, and had it blowne hard it had scarce been possible to escape it. Soe I stood to the Northward to get clear of it, which in the Lattd. of 50^o I did, and their saw the last Ice. In my way hither I Discoverd the Isles of Tristan da Cunha, and in Eleaven Weeks from Ryo Jennero I arrived at this Island, to fill my Water and refrezen my men, and in this whole course I have found noe reason to doubt of an exact conformity in the variations of the compass to a generall Theory, which I am in great hopes to settle effectually

I am Honord Sr. Your most Obedt. Servt.
Edmond Halley.

St. Helena

March 30th: 1700

¹ This letter, and the next, are not in Halley's autograph. The spelling has been altered as little as possible.

66. To BURCHETT. 1700.

Bermudas July 8^o 1700

Honourd Sr.

My last from St. Hellena, gave your Honour an Account of my Southern cruise, wherin I endeavoured to see the bounds of this Ocean on that side, but in the Lattd. of $52\frac{1}{2}^{\circ}$ was intercepted with Ice cold and foggs Scarce credible at that time of the Year. Haveing spent above a Month to the Southwards of 40 degrees, and Winter comeing on, I stood to the Norwards again and fell [in] with the three Islands of Tristan da Cunha which yeilding us noe hopes of refreshment, I went to St. Helena, where the continued rains made the water soe thick with a brackish mudd, that when settled it was scarce fitt to be drunke; all other necesarys that Island furnishes abundantly. At Trinidad we found excellent good water, but nothing else. Soe here I changed as much of my St. Hellena water as I could, and proceeded to Fernambouc in Brassile, being desirous to hear if all were at peace in Europe, haveing had noe sort of Advice for near eight months, here one Mr. Hardwyck that calls himselfe English consull, shewed himselfe very desirous to make prize of me, as a pyrate and kept me under a guard in his house, whilst he went aboard to examine, notwithstanding I shewd him both my commissions and the smallness of my force for such a purpose. From hence in sixteen days I arrived at Barbados on the 21st of May, where I found the Island afflicted with a Severe pestilentiall disease, which scarce spares any one and had it been as mortall as common would in a great measure have Depeopled the Island. I staid there but three days, yet my selfe and many of my men were seized with it, and tho it used me gently and I was soon up again yet it cost me my skin, my ships company by the extraordinary care of my Doctor all did well of it, and at present we are a very healthy ship: to morrow I goe from hence to coast alongst the North America and hope to waite on their Lordshps: my selfe within a month after the arrivall of this, being in great hopes, that the account I bring them of the variations and other matters may appear soe much for the publick benefit as to give their Lordshps. intire satisfaction:

I am Your Honrs: most Obedt: Servant:
Edmond Halley.

67. To BURCHETT. 1700.

Honoured Sr.

I this day arrived from Newfound land at this port and waiting on the Commisr. I found no orders from their Lopps, so shall this

night persue my voiage to the Downs where I shall waite for what further orders their Lopps shall please to give me

I am Your Honours most obedt. Servt.

Plymouth:
August 27^o 1700

Edm. Halley.

68. To BURCHETT. 1700.

Downs Sept. 2^o 1700

Honourd Sr.

I am just arrived time enough to save the post, and to give yr Honour an account that having received yr Lopps orders, I shall as soon as the Tide serves endeavour to putt them in execution: We were forced to tide it from the Isle of Wight, otherwise I had waited on you by this time.

I am Your Honours most obedt. Servt.

Edm. Halley.

69. To BURCHETT.

Long reach Sept 7^o 1700

Honoured Sr.

The winds having been extreamply contrary, it has cost me five days to gett from the Downs hither, and in the passage I have had the dissatisfaction to see the Paramour fall to Leeward of all the Marchant men that turned it with us. I now humbly hope from yr Honours favour, to find at Deptford (where I shall be in a day or two) their Lopps leave to come up to waite on them.¹

I am Sr. Your Honours most obedt. Servt.

Edm. Halley

70. To SLOANE.² 1700.

Sr.

Having had the misfortune to omitt giving you notice of the favour I design my self on Munday night in enjoying your good company over a bottle of Wine, I now entreat you to forgive that neglect and that you will please to bestow your self on me at the usuall hour at the Kings Arms on Ludgate hill, as being a place in some respects more convenient for the Company and my self than at home:

I am Sr. Your most obedt. Servant

Saturday morn

. Edm: Halley.

Octob. 26^o 1700.

¹ Luttrell, under date of 'Saturday, 14 Sept., 1700', says: 'Captain Hawley, the famous mathematician, is come to town from his expedition in the South Seas, and has given the lords of the admiralty an account of the observations and discoveries he made there.' (Luttrell's *Brief Relation of State Affairs*, vol. iv, p. 687, Oxford, 1857.)

² After a photostat from the original in Sloane MS. 4038, fo. 82, British Museum.

71. To BURCHETT.¹ 1701.

To the Right Honble: the Lords Commissrs: for Executing the Office of Lord High-Admirall of England.

It is humbly proposed

That if their Lopps shall think fitting to have an exact account of the Course of the Tides on and about the Coast of England, so taken as at one View to represent the whole; (which will be a work of generall use to all Shipping, especially such as have occasion to turn to Windward, and wch is wanting towards the compleating the Art of Navigation) there be provided a small Vessell such as their Lopps shall think proper, with all convenient speed, on board of which such an account of the Tides may be taken, as their Lopps shall direct; for which service their Lopps most obedient servant humbly offers himself.

Edm. Halley.

Aprill 23^o

1701.

72. To BURCHETT. 1701.

Honrd. Sr.

The Season of the Year advancing and Men being scarce, I humbly entreat my Commission to be dispatcht, in order to gett the Paramore Pink mann'd with such Compliment as their Lopps shall think fitting, which cannot be well less than it was the last time viz: 25 Men. She has been lately dockt & wants only rigging, which is but a little work. Two Boats and two spare Cables, for the small Bower and one spare Anchor, is all at present I can think may be needfull of Extraordinarys, being near at hand to be supplied on occasion.

I am yr Honours obdt. Servt.

Edm. Halley.

Aprill 26^o

1701

73. To BURCHETT. 1701.

Honrd. Sr.

The Paramore Pink being so far fitted as to be ready to saile, if my Compliment of men were ready, I beseech you to lay before

¹ This and the eleven other following communications from Halley, during his survey of the English Channel, in 1701, were addressed to Josiah Burchett, Secretary to the Admiralty. These letters, as reproduced herein, are from photostats of the originals in the Admiralty Archives, Public Record Office, London, where they are preserved under the heading of 'Captains' Letters, 1698-1700-1701'.

their Lopps the great difficulty I find to gett them, no men now offering themselves as usuall at other times. Eight or ten able hands before the Mast, is all I want necessarily, and I humbly hope that so small a demand will meet with no difficulty: The advanced Season of the Year makes me the more sollicitous in this matter.

I am Your Honrs. most obedt. Servt.

Edm. Halley.

[29 April 1701]

74. To BURCHETT. 1701.

Honrd. Sr.

I have attended my Ld Lucas according to their Lopps order, and find that his order of Councell for pressing Seamen has been discharged some time since. If their Lopps shall think fitting to spare me but two able Seamen out of four or five of the Ships of Warr, I will take care to return them where I had them in case the breaking out of a war oblige me to desist from my undertaking.

I am Your Honrs. most obedt. Servt.

Edm. Halley.

Maii 31^o

1701

75. To BURCHETT. 1701.

Honrd. Sr.

I find my self disappointed in my Mate, who for great wages has been tempted to break his promise with me: and for 40 sh. p month I fear I cannot have a man capable to take charge of my Shipp, Marchants giving now so much to any able Seaman. I humbly hope their Lopps will think it reasonable to allow me a warranted Master, well acquainted with the Channell in lieu of a Mate; and that they please likewise to give me leave to have out of the Shipp of Warr, under such restriction as their Lopps please, such men as shall be willing to serve on board me.

I am Yr. Honrs. most obedt: Servant

Edm. Halley.

June 4^o

1701

76. To BURCHETT. 1701.

Honrd Sr.

Being now in a condition to saile I addresse my self to your Honr: for the Instructions their Lopps please to give me; amongst which with all submission I entreat that these or to the same purpose may be inserted.

You are to use all possible diligence in observing the Course of the Tides in the Channell of England as well in the mid sea as on both Shores, and to inform your self of the precise times of High and Low Water; of the sett and strength of the Flood and Ebb and how many feet it flows in as many places as may suffice to describe the whole. And where there are irregular and half Tides to be more than ordinarily curious in observing them. You are likewise to take the true barings of the principall head lands on the English Coast one from another, and to continue the Meridian as often as conveniently may be from side to side of the Channell, in order to lay down both coasts truly against one another.

What else their Lopps please to enjoyne me, I shall as is my duty perform to the best of my power, being

Your Honrs: most obedt. servt.
Edm. Halley.

June 11^o
1701

77. To BURCHETT. 1701.

Downs June 18^o 1701

Honred: Sr.

I arrived in the Downs on Monday last, and have to day gotten an order from the Admirall for the four men their Lopps have appointed me here; They will be delivered me this night, and with them I shall be enabled to proceed according to their Lopps Instructions designing to sayle to morrow morning. I shall not fayle to give your Honr: an account of my proceedings as occasion shall offer, being

Your Honrs: most obedt: servt.
Edm. Halley.

78. To BURCHETT. 1701.

Spitt head July 29^o 1701

Honoured Sr.

In obedience to their Lopps orders, I have since I left the Downs on the 19th of June, endeavoured to gett as exact an account of the Tides in the Channell as possible, and have ankered all over it, from the Forland to Portland, and from Blackness to the Casketts on the French side: and I have been particularly curious in this part between the Isle of Wight and Portland and the French Coast against it, where I find the Course of the Tides very extraordinary, but which I think I can describe effectually. I have been of late putt from my business by hard gales of Wind which drove me in

hither, but still hope by the end of the Summer to give their Lopps a full account of the whole Channell, if not interrputed by the breaking out of Warr, which I find is suddainly expected here. If their Lopps have any further orders for me, I shall call in at Plymouth for them, designing to saile hence as this day, and to tide it down, if the weather permitt it.

I am Your Honours most obedt Servt.
Edm. Halley.

79. To BURCHETT. 1701.

Paramore pink at Dartmouth. Aug 23^o 1701.

Honoured Sr.

By my last of July 29^o from Spitthead I gave you an account that I had carefully observed the Course of the Tides in the Eastern part of the Channell of England; since then I have lost no opportunity, in order to do the like for the Western part, and I have ankered all along the English Coast in the Offing as far as the Lizard, and from thence in the midd Channell, and over to Ushant, where I was the last week. The frequent weighing my ankers in so deep water has been very hard service to my small company, but the greatest difficulty I find, is from the frequent gales of Wind, which, (especially without the Start) raise the sea to that degree that there is no riding, and which, in this month of August, have forced me four severall times into Harbour. I waite here for an opportunity of smooth weather, to anker in severall places between the Start and the Sept Isles; wherby I shall be able to compleat the sett of observations necessary to the description of the Tides in the Offing; of which I cannot find any of our books to give a tollerable account. When I return from the French coast, I entend to putt in to Spitthead, to receive any farther orders their Lopps may think proper for me. With my humble duty to their Lopps I remain

Your Honrs. most obedt: Servant
Edm. Halley.

80. To BURCHETT. 1701.

Paramore pink at Spitthead Sept 13^o 1701

Honoured Sr.

These may serve to acquaint you that having observed the Course of the Tides in the Western part of the Channell, and my provision being almost spent, I came in here on the 11th Instant to recruite, and yesterday I received a months provision, with which I am going this morning to saile, to observe some particulars, which the

circumstances of the Winds would not suffer me to do as I past down. I am in hopes I shall be so fortunate as to please their Lopps in this Summers expedition, wherin I have discovered, beyond my expectation, the generall rule of the Tides in the Channell; and in many things corrected the Charts therof. Before this Months provision expires the winter season will oblige me to return, hoping from yr Honour a favourable acceptance of the endeavours of

Honrd: Sr. Your most obedt. Servt.
Edm. Halley.

81. To BURCHETT. 1701.

Paramore Pink in Long reach Octob 2^o. 1701

Honoured Sr.

Finding the season of the year too far lapsed to ride at anchor in the Channell; in persuance of their Lopps orders, I came into the River of Thames last night, and am at present moored in this place, where I waite their Lopps farther pleasure, hoping they please to allow me the Liberty to waite on them to render them an account of my Summers Expedition.

I am Your Honours most obedt: Servt:
Edm: Halley.

82. To SOUTHWELL.¹ 1701/2.

Honourd Sr.

In obedience to your Commands I have endeavoured to draw up such plain directions for making the Survey of a Coast, as may be serviceable to any that have the will and opportunity to describe curiously any Shoals they are acquainted with:

In order to this Survey of a Sea coast and to lay down truly the shoals and dangers near it, if the land be accessible the best way will be to take with all possible care the true positions of as many remarkable objects such as Steeples, Mills, Rocks, Cliffs, Promontorys, or such like as you find most conspicuous along the Coast, that is their true barings from one another in respect of the true North and South; which is best done by measuring the angle with any proper instrumt. from the rising or setting sun, allowing his amplitude and according to the exactness of these angles will your survey be more or less true. I preferr this method of taking

¹ From the original in Royal Society Collection of 'Newtoniana'. This interesting letter was addressed to Sir Robert Southwell. It was purchased at a sale of manuscripts at Sotheby's, in May 1839, and came from the collection of James Stewart, Esq., F.S.S.

these angles by the Sunn rather than by the Compass or magneticall needle, because of the smalness of the radius of the Magneticall chart and the uncertainty of the variation on the Land, the needle being affected with the neighbourhood of Iron Oars and Mineralls.

This done you may readily plott down all those objects on the Land, by any view of them from a vessell riding at Anchor off at Sea; for if you take their true position from your shipp, by help of the rising or setting Sunn as before, the intersections of those lines with those of the positions of the objects to one another, will give you the places and proportionall distances of the sd Objects one from another, to which afterwards a scale may be adapted, as shall be taught by and by.

Being thus assured of the plott of severall objects on the shore, it will be very easy to lay down the points of any sand or shole, or any sunk rock on that Coast, either by the position of two or more of those objects, from a vessell riding at those points; or more compendiously and easily by taking the angles between those objects, at the said places entended to be laid down in your platt. That this may be the better understood, take the following Scheme. On the Coast to be described Let A be a steeple, B a Mill, C a Rock, D a remarkable Tree, E a steep Cliff &c. and lett each of them be seen from some other of the objects, and their positions truly taken. for example Let B bear from A West 12° . Northerly; C from B, W 30° . Southerly, D from C W. 20° . N. and E from A W 2° . Southerly. This done at a convenient distance off at Sea as at \rightarrow , let the position of A be North 20° Easterly, B. N 2° East, C. N $22^{\circ}\frac{1}{2}$ W or NNW, D. N 40° W and E. N 53 West. I say the true platt of the aforesd places A, B, C, D, E &c. will be as in the Scheme, although as yet we know not the reall distances of them, and wee may use them with certainty to lay down any other places in their true position. As for example, let there be a shole at one end wherof E bares NNW and C, NE; this being protracted, tis plain tis at F that that point of the shole ought to be laid down. At the other end of the same shole which wee will call G, for want of the Sunn, wee can only take the angle DGB 60 degrees & the angle CGA 80 degrees, I say the point G will be nicely determined therby. For if the angle BDH be made 30 degrees or the Complement of DGB, and DH = BH, the arch of the Circle DBG described with the radius DH and center H, shall be such that wherever you take the point G therein the angle BGD shall be 60 degrees. In like manner making the Angle ACK 10 degrees the arck of the Circle AGC whose center is K passing through A and C, shall in all its points G make the angle

LETTERS

123

By presents to severall Portuguese Governers and Officers at St. Jago, Paraiba, Rio Jennero and Pernambouc at the prime cost	}	13.	16.	0
Pd. severall Portuguese Pilots at Paraiba, Rio Jennero and Pernambouc		5.	17.	0
Pd. severall Coopers at severall times for trimming our Cask	}	1.	14.	8.
				2
Pd. severall Caulkers for caulking our Decks and Upper-works at Bermudas in July 1700	}	4.	6.	4
Pd. then refreshing the paint of our Carvd work		0.	10.	0.
Pd. Samll: Day Esqre: Governour of Bermudas for a small Anchor wt 315 lb wt: as per Voucher	}	7.	17.	0
Pd. Zachary Briggs Pilot, of Bermudas		2.	2.	8.
Pd. for Timber for a small Anchor stock		0.	5.	0
Pd. Peter St. Croix pilot of Jersey for 58 days service on board the Pink last summer in the Channell as £ Voucher	}	11.	10.	0
Totall		<hr/> 47. 18. 10. <hr/>		

And wheras the late Lords Commissrs: of the Admiralty were pleasd to pay me 100 li Imprest money, it appears that there still remains 52 li therof in my hands. But I humbly hope his Excellency my Ld High Admirall will please to consider the smallness of my wages in my late Channel cruise ammounting not to 50 li in the whole.

Edm. Halley.

Feb. 18^o
1701/2

84. To SHARP.¹ 1705.

London April 23^o 1705.

Sr.

I congratulate the success of your paines in the exact Quadrature of the Circle, which more than doubles the famous number of Van Ceulen. I desired Mr. Sherwin to thank you in my name for it, and to let you know that I should have been glad to have communicated a Method I have thought on for that purpose, than which I belive it is not in nature to do it more easily, and which might have saved you some Elbow-greace, had I known your design.

¹ Reproduced from a facsimile of the original letter in Cudworth, William: *Life and Correspondence of Abraham Sharp*, p. 33, London, 1889.

It is by taking the thirds of the $\sqrt[3]{}$ of 12 infinitely and then dividing by the odd numbers in Arithmetical Progression adding and subtracting the Quotes alternately. This I find, by a letter of yours I have seen, that Mr. Sherwin has sent it you exemplified so that I need describe it no more. In the same you ask the demonstration therof, which is very easy, and is founded on the same principle with Mr. Leibnitz's famous series $\frac{1}{1} - \frac{1}{3} + \frac{1}{5} - \frac{1}{7} + \frac{1}{9} \&c.$ = to the Area of the Quadrant, viz. that the fluxion of the Tangent of an arch is to the fluxion of the arch as the square of the secant to the square of the radius which is thus evident. Let CAR be any arch and RT

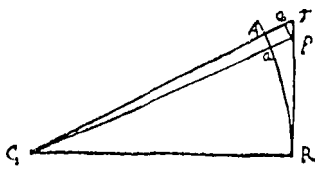

its Tangent. Drawing the line Cap infinitely near to CAT. Tp will be the fluxion of the Tangent = t and Aa the correspondent fluxion of the arch = a . Now ob similia triangula Tp is to Qp as CT to CR, and again Qp is to Aa as CT to CR = CA wherfore Tp is to Aa as CTquad ad CRquad, that is as $rr + tt : rr :: t : a$. Wherfore dividing rrt by $rr + tt$ the Quote will

be $t - \frac{ttt}{rr} + \frac{t^4t}{r^4} - \frac{t^6t}{r^6} + \frac{t^8t}{r^8} \&c$ equal to the fluxion of the arch and its Integrall or flowing quantity will be the arch it self, viz.

$t - \frac{t^3}{3rr} + \frac{t^5}{5r^4} - \frac{t^7}{7r^6} + \frac{t^9}{9r^8} \&c.$ Now the Tangent of 3ogr: being

$\sqrt[3]{\frac{1}{3}}$ it is evident that $\frac{1}{3}\sqrt[3]{\frac{1}{3}}$ is equal to the Cube therof, and $\frac{1}{3} \times \frac{1}{3}\sqrt[3]{\frac{1}{3}}$ the fift power therof &c in infinitum. Whence tis plain that the arch of 3ogr: is $\sqrt[3]{\frac{1}{3}} - \frac{1}{9}\sqrt[3]{\frac{1}{3}} + \frac{1}{45}\sqrt[3]{\frac{1}{3}} - \frac{1}{189}\sqrt[3]{\frac{1}{3}} \&c$ or $\sqrt[3]{\frac{1}{3}} \times 1 - \frac{1}{9} + \frac{1}{45} - \frac{1}{189} \&c$ and six times this arch is the semi-circumference of the circle whose radius is 1. that is $\sqrt{12} \times 1 - \frac{1}{9} + \frac{1}{45} - \frac{1}{189} \&c$ which is our very Theoreme. Mr. Sherwin just now shews me your letter of the 20th Instant. you have taken the paines to verifie your former work by this method also for which I again thank you and wish it may at any time lie in my power to testifie the respect I shall always have for a gentleman endued with your admirable qualities.

I am Sr. Your most assured Friend & Servt.

Edm. Halley.



HALLEY'S HOUSE AND OBSERVATORY
in New College Lane, Oxford

85. To CHARLETT.¹ 1705.

London, June 23, 1705.

Reverend Sr.

I return you many thanks for your repeated favours as well in what relates to my house, wherein I must esteem you my greatest benefactor, as for your kind endeavours to give reputation and value to my small performance about Comets, which no wais deserves a place in your Catalogue, or to bear the badg of the Theater. I purpose to be in Oxford about the time you mention, but hope to see you in London befor then. As for Dr. Gregory with whom I this day dined at Sr. Is: Newtons, I cannot find that he has any thoughts of seeing Oxford this summer. I see you have put my Apollonius among the books preparing for the press, I wish when done it may answer expectation. If it pleases the Dean and some few Mathematicall Judges I have all I hope from it. I could be glad of a few more of my papers for most of the ten you were pleasd to send me, were soiled so as not to be fit to be presented to Quality: Burgers did not take care to wipe his fingers as he ought. We are told for certain that the Germans must quitt Triers as the French Liege, but we must leave behind us a prodigious quantity of forage and provisions or elce be obliged to burn it; but tis to no purpose to write you news, who have so good intelligence from all sides. I therefore subscribe myself

Reverend Sr. Your most obdt. servant
Edm: Halley

86. To HUDSON.² 1705/6.

Dear Dr.

I heartily congratulate your recovery, your friends here having been in pain for you, and none more solicitous than my self; but an intermitting feavour, I should have hoped, might not have given you such a shoc, as I understand you have underwent; after a good dose of the Jesuite, which is an infallible antidote.

¹ From a transcript of the original, in MS. Ballard 24, fo. 27, Bodleian Library, Oxford. All except the concluding portion of this letter was printed in Aubrey, John: *Letters Written by Eminent Persons*, vol. 1, pp. 139-40, London, 1813. The 'house' to which Halley refers, in the beginning of the letter, is a residence in New College Lane, Oxford, left to the Savilian Professor by Dr. Wallis. (See *Notes and Queries*, 10th series, vol. ix, p. 166.) A picture of the house appears, as a frontispiece, in Bauer, L. A.: *The Earth's Magnetism*, reprinted Publication No. 2281 from the Smithsonian Report for 1913, pp. 195-212, Washington, 1914. A photograph, taken in 1931, is here reproduced.

² From a transcript of the letter in MS. Rawlinson, D. 316, fo. 141; Bodleian Library, Oxford. Dr. T. Hudson was the librarian of the Bodleian.

I thank you for your continued kindness in your being willing to trouble yourself to see my sheets correct. I shall make bold to desire you to inspect the translation of the preface of Pappus, which I have almost finished; and my own preface also, with which your trouble will be at an end. In the mean time I shall always gratefully remember your kindness to Sr.

Your much obliged servt.
Edm Halley

London March 16 1705/6.

My service to Dr. Crosthwaite

87. To (?) GALE.¹ 1708/9.

Oxon. Feb. 7. 1708/9.

Sr.

I am in hopes you will pardon me that I have not sooner sent you the Inscription you desire. It being of a very soft and rough sort of stone, occasioned me an uncommon difficulty in reading it, especially being filled up with moss whose roots eat into the body of the stone, and dissolve the substance therof, and with it the remains of the letters. However after severall essays, and having the help of Prideaux his reading, I at length made it out, though not a little nor immaterially differing from Prideaux. tis thus

VIVIO^{D.} MARC^M
ANO ML LEG II
AVG JANVARIA
MARINA @NIVNX
PIENTISSIMA POSV
IT ME MORAM



(a) Here has been a small hole originally in the stone by reason of which LEG and II are at too great a distance: and the word ML is more effaced than all the rest, and is left out by Prideaux; who likewise makes an H of the two II's and interprets it not very skilfully.

The stone is 7 foot long and 2 foot 8 inches broad and a foot from the bottom is a nich 2 foot broad and 4 foot high, wherein in high relief stands the image of a Roman soldier not unlike what you will find in Prideaux, only the person is not so burly as he makes him, nor is what he holds in his right hand a sword, but the remains of some other instrument, whose form is lost by the injury of time or ill keeping. The image is at present very rough and unsightly,

¹ Printed from a transcript of the original manuscript letter in the Bodleian Library inserted in their copy of Horsley's *Britannia Romana* at p. 331, where the stone is described. See Gale's *Antonini Iter Britanniarum* (1709), where Halley's corrected version is given (p. 68).

all the parts of the head being gone; and it only serves for a further argument of the Second Legions being here. If any more particulars be desired you may command them. Sr. I wish you well out of the press and remain

Your most faithfull Servt.
Edm: Halley.

88. To SLOANE.¹ 1710.

Oxford Maij 14^o 1710

Sr.

I could heartily wish I could be present on Wednesday, but did think the Society was gott over the matter you mention the last Councill day: for it was carried by a great plurality of Voices, that the Dr. had offended, and that the grimaces he sais he apprehended you to make, being subject to a dubious interpretation, and unobserved by my self (who saw you all the while) and severall others present, should first be disowned by you, as to the intencion of any looks or actions; and that then ye Dr. for his words, which could not be denyed, should begg your pardon before the Society, with a promise not to do the like for the future. I belive the Councill will continue of the same sentiments: but if you think any thing I can say may be serviceable to you; I shall again be in town the latter end of this week, and will if need be give my evidence vivâ voce, at another Councill you may easily gett for the week following. I am sorry you have all this trouble, being Sr.

Your most obedt. Servt.
Edm: Halley

89. To FLAMSTEED.² 1711.

London, June 23, 1711.

Reverend Sir,

Though I am credibly informed that these sheets have been, from time to time, sent you from the press, yet, lest it should be otherwise, I have now sent you the catalogue of the fixed stars intended to be prefixed to your book; having spared no pains to make it as complete and correct as I could, by help of the Observations you have given us, made before the year 1706. I desire you to find all the real faults you can, not as believing there are none, but being willing to have a work of this kind as perfect as possible:

¹ After a photostat of the original in Sloane MS. 4042, fo. 131, British Museum.

² Reprinted from Baily, Francis: *An Account of the Revd. John Flamsteed*, 1835, p. 293.

and if you signify what's amiss, the errors shall be noted, or the sheet reprinted, if the case require it. Pray govern your passion, and when you have seen and considered what I have done for you, you may perhaps think I deserve at your hands a much better treatment than you for a long time have been pleased to bestow on

Your quondam friend, and not yet profligate enemy (as you call me),

Edm. Halley.

90. To SLOANE.¹ ? ca. 1712.

Sr.

I have waited to have seen you at Betty's Coffee house, to have told you that Sr. Christopher Wrenn and Sr. Isaac design to waite on you this afternoon after dinner to see the experiment of the Airs refraction. I hope it will give you no trouble to afford us the same conveniency wee had the other day

I am Sr. your most obedt. Servant

Edm: Halley

91. To KEILL.² 1715.

London Octr. 3 1715

Dear Sr.

We have printed a French translation of ye account of the Commercium given in the transactions in order to send it abroad; Sr. Isaac is desirous it should be publisht in the Journal Litteraire and Mr. Gravesant has promised to get it done but cares not to do it as of his own hand and therefore proposes that you would signifie to Mr. Johnson at the Hague by a letter enclosed either to Sr. Isaac or me that you are desirous that the said French paper be inserted in his Journal as containing the whole state of the controversy between you and Mr. Leibnitz. Sr. Isaac is unwilling to appear in it himself for reasons I need not tell you and therefore has ordered me to write to you about it who have been his avowed Champion in this quarrell and he hopes you will gratifie him in this matter by the first opportunity.

I have recd. Cloaks Ladyday's rent but hear not one word of Spetty. Pray let me know what I shall say to him about the Lease

¹ After a photostat of the original in Sloane MS. 4059, fo. 96, British Museum.

This letter, which is undated, was, of course, written after 16 April, 1705, when Newton was knighted, and before 1716, when Sloane was created a baronet. The note is inscribed to Dr. Hans Sloane.

² From a transcript made by Ralph J. Beevor, Esq., M.A., after the manuscript in the library of Trinity College, Cambridge. This letter was printed in Edleston, J.: *Correspondence of Sir Isaac Newton and Professor Cotes*, 1850, pp. 184-5; and, again, in *Notes and Queries*, vol. cliv, 1928, p. 368.

and I will endeavour to make him pay the year's rent due at Lady day or at least the best part of it before I come down to you which will not be long

I am dear Sr. Your most faithful servant
Edm: Halley

92. To FLAMSTEED.¹ 1716.

Crane Court, Fleet Street.

Mr. Flamsteed.
Sr.

I am commanded by the president, Councill and Fellows of the R. Society, to put you in mind that you are in arrears to them a Copy of your Astronomically Observations for the year 1714; and that those of 1715 ending with December last, are now become due to them: both of which they require you to send them on or before Midsummer day next, as you are obliged to do by her late Maties orders, which constituted them perpetuall Visitors of the Royall Observatory, and entitle them to the Copies they now demand.

Your humble Servt,
Edm: Halley.
R. S. Sec.

By order of the Society June 7, 1716.

93. To POUND.² 1716.

London, Sept. 6, 1716.

Dear Sir,

Entreating you to pardon the frequent trouble I give you, these are to let you know that by the distances you took the other night I find the place of the nebula in Hercules to be m , $25^{\circ} 6'$, with the latitude $58^{\circ} 1'$, whereby it appears that it precedes π of Hercules $33\frac{1}{4}$ minutes of time with very little difference of declination. That in the foot of Antinous I find to have long. ϱ $8^{\circ} 55\frac{1}{2}'$, with north latitude $16^{\circ} 37\frac{1}{2}'$, preceding the bright foot of Antinous (λ Bayero). Bayer has two stars preceding λ , to which he has put no letters, but they are i and k in Mr. Flamsteed's Catalogue; the preceding of which k follows the nebula 6 minutes of time, and is $22\frac{1}{2}$ minutes more northerly than it. By these Mr. Bradley may at his leisure

¹ From the original letter in Flamsteed's MSS. (vol. 35, fo. 145) in the Royal Observatory, Greenwich. This letter is one of many which were sent to Flamsteed at intervals to remind him of his obligations. This particular one was signed by Halley, but all the others were signed jointly by members of the Council. Flamsteed never liked the Society's having the control of the Observatory and he, apparently, showed his dislike by withholding the observations until the very last moment.

² Reprinted from *Miscellaneous Works and Correspondence of the Rev. James Bradley* [Rigaud], Oxford, 1832, p. iii.

examine the above situations of the nebulae, which are fitted to Mr. Flamsteed's epocha, or anno ineunte 1690.

On Saturday next, Sept. 8vo, about 5 in the morning, (if you please once more to verify the places of the stars in the beginning of Virgo, to which the comet was applied in November 1680,) you will find Mars close to the two contiguous *d* and *e*, in Transactions No. 342, which are but 7 minutes asunder. According to my calculus I expect him nearer to each of them than they are to one another, and about 4 minutes more northerly than they, which have precisely the same declination. I fear it will be too light for me to see so small stars, when Mars gets over the houses, or you should not have had this trouble from, kind Sir,

Your much obliged, faithful servant,
Edm. Halley.

94. To ANSTIS.¹ 1721.

Greenwich, May 16, 1721.

Sir,

I am sorry your letter found me out of town and that my people did not send it after me, but I hope a delay of a few days will be of no consequence in your enquiry. I returned from Oxford this day and immediately fell to compute and can assure you that in the year 1446 the eleventh day of July was Monday, the Dominical letter of that year being B.

In the year 1518, the Dominical letter was C and by consequence the 16th day of May was Sunday but not the next to the Inventio Crucis.

In the year 1342/3 the Dominical letter was E and therefore the thirteenth of January was Monday and the Monday following was the twentieth day as you had very rightly concluded.

As to your Solar Eclipse, if you are secure of the year, I am as certain that in the month of August there could be no eclipse visible in France. Indeed on the 17h. day of that month the sunn was eclipsed in the southern parts of the globe but in no part of Europe so that there must be some mistake in the Historian that reports it. If it were any other year, the day of the eclipse would not be so near your time as in 1346.

In any other matter wherein I may be serviceable to you, please at all times to command

Sr. Your most faithfull servant,
Edm. Halley.

Inventio Crucis is on 3 May.

¹ Copy of letter in Stowe MS. 749, folio 158, preserved in the British Museum. (Transcript supplied by Ralph J. Beevor, Esq., M.A., St. Albans.)

95. To SLOANE.¹ 1722.

Honoured Sr.

These are humbly to put you in mind of your promised favour of presenting me to my Lord Cadogan to morrow morning at Man's Coffee house, about half an hour past Ten, as you appointed when I last had the honour to see you. You will pardon this trouble arising from my care lest the multiplicity of your affaires should occasion my request to slip out of your thoughts.

I am Sr. Your most faithfull & most obliged humble Servt.

Edm: Halley.

Greenwich Julij 9^{no} 1722

96. To SLOANE.² 1722.

Honoured Sr.

I must entreat you to putt into your Coach to morrow Michael Mæstlin's Observations of the Comet of 1580, which I want to compare with Tycho Brahe's Observations of the same, which were putt the other day into my hands by the Society. I know you have the book, for I formerly borrowed it of you, and made an extract therof, which having mislaid is at present lost to me. If you please to favour me in this matter, you will lay a new obligation on your most faithfull and Obedient servant

Edmond Halley.

Greenwich Novemb 7^o 1722

97. To NEWTON.³ 1724/5.

Honourd Sr.

A mistake I committed in considering the Scheme of your Comets Orb, which was no less than my taking the Suns motion the contrary way, made me conclude that no other than an Elliptick Orb could suffice to represent the first observations therof with the desired exactness, and you being indisposed out of town, I waited for your return to consult you. Being yesterday at London I guesd by some symptoms that you take it ill that I have not dispatcht the Calculus I undertook for you, but the aforesd mistake made me despair of pleasing you in it. Being got home last night I was astonisht to find my self capable of such an intollerable blunder, for which I hope it will be easier for you to pardon me,

¹ From a photostat of the original in Sloane MS. 4046, fo. 264, British Museum.

² From a photostat of the original in Sloane MS. 4046, fo. 307, British Museum.

³ From a photostat of the original, in the Portsmouth Collection, University Library, Cambridge.

than for me to pardon my self, who hereby run the risk of disoblighing the person in the Universe I most esteem. I entreat therefore that you would not think of any other hand for this computus, and that you please to allow me the rest of this week to do it in, being desirous to approve my self in all things

Honrd Sr. Your most faithfull Servt.

Greenwich.

Feb. 16^o

1724/5

Edm: Halley

98. To NEWTON.¹

For the Honble: Sr. Isaac Newton.

Anno 1680 Novemb. 23^o 17h 20' T. app. $\odot \rightarrow 13^{\circ}. 1'. 22''$
 Locus Cometæ visus. $\mathfrak{M}_c 13^{\circ}. 22'. 20''$ cum lat Aust. $2^{\circ}. 21'. 15''$.
 et distantia a centro Solis 64175 partium.

Ex hypothesibus secundis

Locus Cometæ $\mathfrak{M}_c 13^{\circ}. 13'. 24''$. Lat Aust. $2^{\circ}. 20'. 40''$.

Calculo Edm. Halley

99. To SLOANE.² 1727.

Grenwich July 1^o 1727

Sr.

I was surprized yesterday with a summons to attend you at a Councill on Tuesday next, of which I had no notice on Thursday last. If I can be particularly serviceable I will come to town on purpose; but I write this, being under an apprehension I mistook the day of your kind Invitation, which I thought you designed for Thursday between One and Two of the Clock. If you have changed the day, pray do me the favour to let me know it, by a line by the penny post, otherwise I shall waite on you on Thursday according to your first designation

I am With the utmost respect Sr. Your most obedt. Servant

Edm: Halley

100. To SLOANE.³ 1729.

Honoured Sr.

Her Majesty not having yet honoured the Observatory with her Royall presence, and finding by the News-papers, that shee with

¹ From a photostat of the original, in the Portsmouth Collection, University Library, Cambridge. Perhaps sent to Newton for use in his discussion of this comet in the 2nd or 3rd edition of the *Principia* (1713, 1726).

² From a photostat of the original in Sloane MS. 4048, fo. 317, British Museum.

³ From a photostat of the original in Sloane MS. 4050, fo. 181, British Museum.

the Prince very soon intend you the favour of a Viset; I humbly entreat you that when Shee comes, you would present me to her, if it may be done without offence; and that as soon as you know the certain time of her coming, you will please to send me word by a Messenger express, that I may give my attendance accordingly.

If this be practicable, I shall esteem it a singular kindness to

Sr. Your most obliged & humble Servant

Edm: Halley

Greenwich Park, Sept. 1^o 1729.

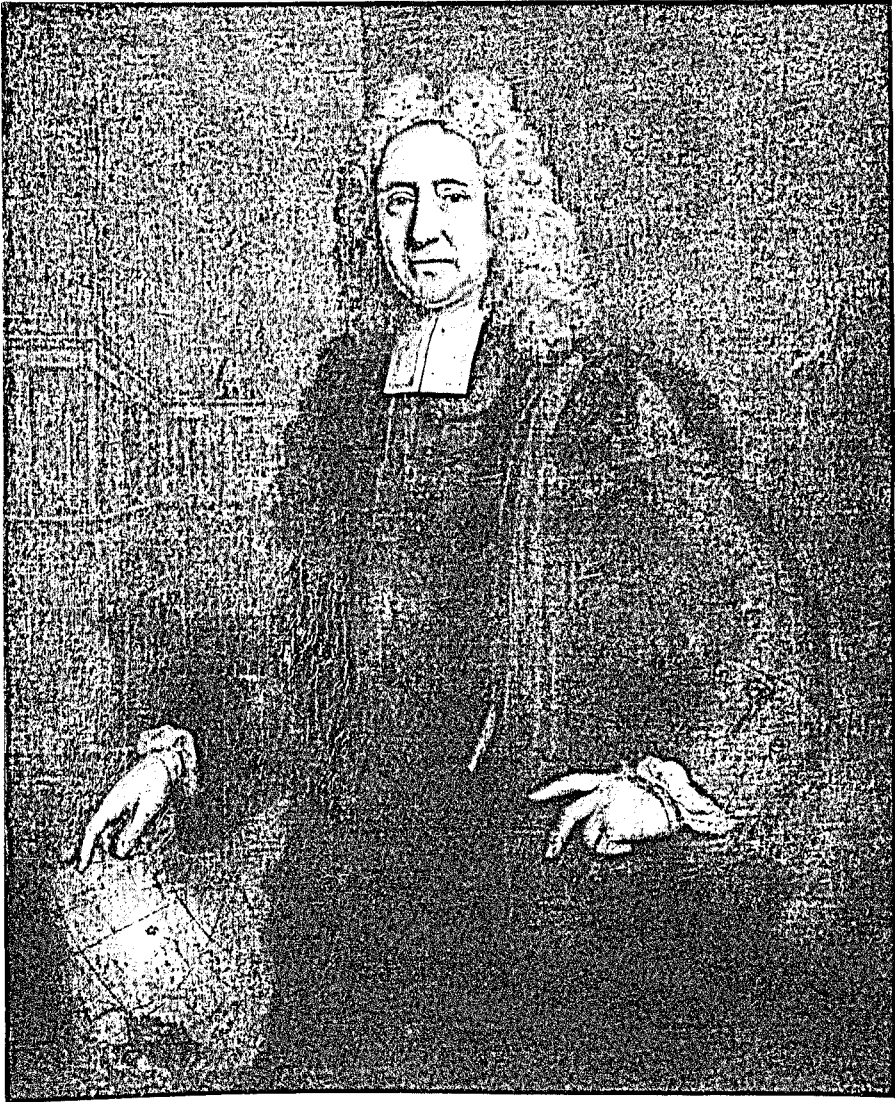

EDMOND HALLEY

From the portrait, painted in 1712, by Thomas Murray, in the possession of the Bodleian Library, Oxford

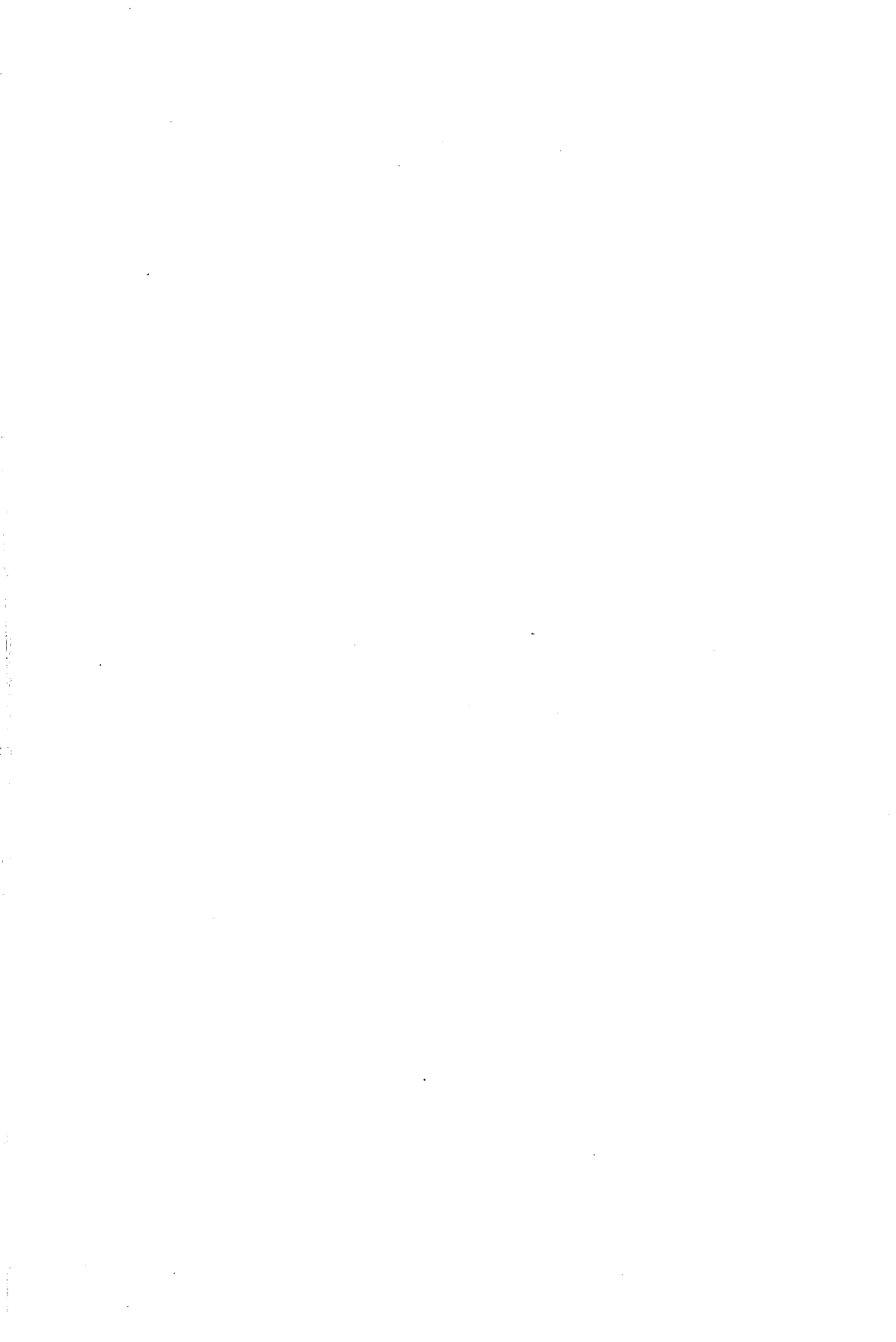

UNPRINTED PAPERS BY HALLEY

These 'papers', all read before the Royal Society, are selected from the Society's Halley Collection, as being unprinted. They are thirty in number and are here reproduced from the originals or 'fair copies' by the courtesy of the Royal Society. They are printed in order of date, and the date of reading of each paper, where ascertained, is given. Particulars will be found in the 'Extracts from the Journal Book of the Royal Society' (Appendix VIII) under the dates mentioned. Halley's originals are for the most part very rough drafts, evidently scribbled down for his own use at the meetings. In many cases they are so rough as to be incapable of certainty in reproduction.

[Read Feb. 23, 1686/7.]

1. *A Paper, concerning Trying the Force of ye Magnet at Several Distances.*¹

I find upon the Journal books of the Society, that the proportion of the decrease of the power of the magnet, as its sphere of activity is extended has been long since inquired into before this Honble Assembly, particularly April 4, 1666 it was experimented by counterpoising the attraction of a small oblong piece of Iron, by a Loadstone with weights in a scale, and it was found, that at 6 inch distance the force of the stone was not equivalent to a sensible part of a grain. that at 4 inch it was but $\frac{1}{8}$ of a grain, at 1 inch it was above 18 grains, but at $\frac{1}{8}$ of an inch it was 197 $\frac{1}{2}$ grains. This experiment shewes that a Scale is not an instrument nice enough to discover the true proportion desired; for that the force of the stone became thereby insensible at 6 inch distance, whereas there is hardly any Loadstone whose sphere of activity is not much larger. Since on January 19, 1680 Dr. Hook shewed an apparatus for finding the said proportion in order to reduce the magnetical power to a certain Theory. By I know not what mischance the entry in the Journal in this place is defective, and I do not find that it is anywhere else mentioned. So that it still remains to be enquired into after what manner the said magnetical force does diminish, and since there is hardly any one experiment can give more light into the mystery of magnetism yn this, I presume it well deserves to be prosecuted.

There is in ye Repository a magnet, whose sphere of activity, as to turning the needle, has been found to reach about 7 foot, and I conceive this would be proper to try the experiment withall, especially

¹ Printed from the 'fair copy' in the Register Book of the Royal Society.

since the comparison between the forces of two loadstones may be easily found, by the direction of the untouched needle between the poles of the stones, and consequently the distance of one of the stones being allways the same from ye needle, and so its force allways the same, ye different inclination of the needle upon ye approach, or removal of the other will certainly discover the differing forces of the same. The manner of deriving the comparative forces from experiment depends upon this proportion. That if a chord be drawn by two other chords in different lines of direction, the direction of the same will be neither towards one, or the other, but between ym. So as, if the forces drawing are equal to bisect the angle, but if unequal, So as the sines of ye angles made by the 2 chords, with the single one, are reciprocally, as the forces drawing each.

[Read March 2, 1686/7.]

2. *An Experiment, of the Force of the Magnetic Needle, and its Variation.*¹

We tryed the Experiment of the different power of the magnet at greater and lesser distances from its pole, by considering the different deflexion of the needle from the magnetical meridian at several tryals, approaching the stone from 9 foot to 1 foot, by 6 inches at a time. We for greater caution of the vicinity of iron took the Society's great magnet into the middle of the area of the Quadrangle of Gresham College, and having found the true meridian, we laid at right angles thereto a long piece of wood 9 foot long, west from ye pole of the stone; we divided it into spaces 6 inches asunder, and having applyed the center of the magnetic needle to those places, successively, we found that ye variation (as near as could be discerned), was about 5 degrees west: Then ye Magnet being applyed at nine foot distance, it varied but $2\frac{1}{2}$ west, or was attracted $2\frac{1}{2}$ from its own natural position. At $8\frac{1}{2}$ it varied $1\frac{1}{2}$ or was attracted $3\frac{1}{2}$. At 8 foot it was not sensibly more yn the former. At $7\frac{1}{2}$ it varied 1.10' or was attracted 3.50'; at 7 foot it varied $0\frac{1}{4}$ west, or was attracted 4.45'. At $6\frac{1}{2}$ 1.10' east. 6.10' at 6 . . . 2.40' east or 7.10' attr. $5\frac{1}{2}$ 4.40' east or 9.40' attr. At 5. 7.10' east or 12.10' attr. At $4\frac{1}{2}$ 11.15' east or 16.15' attr. At 4 foot 17 var. or 44.40' attr. At $2\frac{1}{2}$. $58\frac{1}{2}$ var. $63\frac{1}{2}$ attract. At 2 foot $76\frac{1}{2}$ or $81\frac{1}{2}$ attract. $1\frac{1}{2}$ foot $82\frac{1}{2}$ Variat. but $87\frac{1}{2}$ attraction. The difficulty of the operation of the needle, and the radius thereof being great, and altering the difference very considerably from ye Pole of the stone, rendered the observation

¹ Printed from the 'fair copy' in the Register Book of the Royal Society.

somewhat doubtful, so yt we concluded that for distance under 3 foot it were better to examine the forces of the stone, by comparison of those of another stone, which being kept always at the same distance, might have constantly the same force, for that in these trials, the force of the great magnet did too much overpower the direction.

[Read March 2 1686/7.]

3. *An Experiment of the Influence of the Air in Kindling of Phosphorus.*¹

The experiment made in the last meeting, not having been quite satisfactory, to know whether or not the air has any influence upon ye kindling of the Phosphorus by heat: I have prepared the same experiment, in such manner yt the thing may surely be determined I have provided two thin plates, like one another, and upon each of them I will put a piece of Phosphorus. With some gunpowder, having afterwards overwhelmed a Receiver upon one of ym, I will extract the air out of, and leave the other piece in the ordinary air; then putting a candle under each plate, at the same time, it may be seen, which piece of Phosphorus will take fire sooner, and whether the gunpowder *in vacuo* will be kindled at all: and if so, it may be observed how much more time will be requisite for the kindling of it *in vacuo* than in the open air.

[Read Jan. 11, 1687/8.]

4. *A Thermometer in which the Degree of Heat may be Measured by the Amount of Vapour given off by a Liquid.*

The thermometers that have hitherto been in use in the World have depended either upon the principle of the Air Rarefaction by heat, or else of the dilatation of fluids; there is yet a third way which has not yet been considered that I know of, which is by the quantity of vapour raised by a certain degree of warmth, which tis possible may be the most regular and nearest a true scale of heat, for there are severall good reasons to doubt, whether a double heat will make a double expansion either of Air or Liquors, there being certain bounds especially in the latter, which the utmost degrees of heat and cold can but attain to, and when the liquor comes near the limits of its expansion a great addition either of one or th' other can produce but little alteration in the bulk therof, whereas the swifter or slower evaporation seems proportionally to follow the intention or remission of heat. But the great difficulty that occurs in this manner of

¹ Printed from the 'fair copy' in the Register Book of the Royal Society.

Thermometer is how to contrive divisions that shall shew how fast the Water evaporates; after some thoughts upon it I came to this determination, that the divisions of the ordinary Thermometers which shew the degree of heat by the dilatation of Spirit of Wine, being unæqually divided, by marks found by experiment to answer to the severall degrees of evaporation; would be a much truer scale of heat than either of common sorts of weatherglasses. In order to examine the proportions of the Dilatation of water to its Evaporation, I have prepared an Experiment to shew how much the same quantity of water alters in its bulk upon the severall degrees of warmth, which being compared with the quantity of Vapour rising from the same degree, after the manner of the Experiment I lately produced will shew after what manner these new sort of divisions ought to be graduated. And by this means it will be made intelligible what the degrees of the Thermoscope mean, which hitherto have not been intelligibly discoursed of that I can find.

[Read March 14, 1687/8.]

5. *Experiment of the Expansions of Liquors by Heat.*

In the experiment with Mercury 125 ounces encreased the Quantity of 810 grains or 1 oz. 330 gr. whence the dilatation of Mercury is $\frac{1}{4}$ part of its bulk Cold. In this I observed that the Mercury rose very fast at first with a gentle heat, much more than the Water did, and near as much as the Spirit of wine, though it would dilate but little afterwards, so that Mercury may possibly serve as well for a Thermometer as most other liquors. These experiments compared with the specifick gravities of Liquors their refractions, augment by glaciation, and the other phenomena of Fluid bodies may possibly afford some light to discover the hidden secret of the figures and motions of the Constituent parts of the most simple substances, by which we must begin if wee shall ever hope to attain a true and adequate notion of materiall substances.

[Read March 28, 1688.]

6. *A New Thermometer and the Rarification of Liquors.*

It appears by the Experiments alleged in one of the last meetings, that the Expansions of Fluids by heat is very small, having been found but a twenty sixth of the Bulk of water, and but a $\frac{1}{74}$ of Mercury, when forced by the utmost degree of heat of Boyling water, and that the heat of the Air warmed by the Sun, did produce scarce any sensible dilatation in them. In Spirit of wine indeed this

augmentation was more visible, but yet is an exceeding little part of the bulk of the whole, and would not suffice to give a scale of a Thermometer, if it were not for the exceeding smallness of the neck in proportion to the Ball of Liquor annexed. There remains the Air only, which is capable of an exceeding great degree of contraction from cold and dilatation from heat, but withall there is in it this inconvenience, that a Thermometer thus made becomes subject to the differing degrees of the Airs pressure in different weathers, according as the Mercury in the Barometer is higher or Lower. To obviate this objection and to shew how the divisions in a Thermometer made upon this principle is the entent of this Discourse.

I suppose it is not unknown to any of this Honourable Company how this sort of Thermometer is made. viz by inverting a Bolt head in part full of water mixt with Aquafortis or some other liquor that will not freeze and then immersing the end of its cane in the same liquor; this done the liquor in the cane shall stand above the Levell of the Water, just such a part of 33 foot or the hight of a barometer supposed made with water as the liquor in the Bolt head was of the whole capacity of the said Head and the Cane; that is if it were half full of Air and half full of water, the Water retiring the Air will be rarified to half the density of the outward Air and shall have but half the pressure, to supply which a collum of water will be thrust up equall to the other half of the weight of the Incumbent Atmosphere that is of $16\frac{1}{2}$ foot high; but if there were less Water and more Air in the Bolt head the Water will rise less than $16\frac{1}{2}$ in the Cane; if there were more water it shall rise more and shall rise alwais a part proportionall to the Rising of the Mercury in the Barometer and fall when it falls, viz for every inch of rise or fall of the Mercury the Water will rise or fall such a part of the hight of $13\frac{1}{2}$ Inches as is the whole hight of the Water to 33 feet or thereabouts so that the Thermometer being adjusted to any given weight of Atmosphere or hight of the Mercury, it will be easy to reduce these irregularities to a certainty, by taking at the same time the hight of the Barometer, and then by help of a Table deducting or adding a part that shall correspond to that greater or lesser gravity of the Atmosphere. This done it is most evident that the Quantity of Air included will continue the same, but that it will be rarefied and condensed or contracted and expanded by Cold and Heat; and that very considerably, the Modus of this alteration of Bulk is I conceive yet unknown, and whether it be said to arise from diminution of the Elastick force in the Air upon cold, and its augmentation upon heat, or that like all other fluids the parts lies closer and more compact with cold, or swell and take up more

room with heat, or some other way, I shall not undertake to determine, but how great this power is, and with what degrees of Heat and Cold its bulk becomes augmented or diminished by any part, is easy to determine by experiment: and that being once known the same constitution of the ambient Air will make the same degree of expansion: From hence without any trouble in any place where a glass bolt head can be gotten, may a Thermometer be made and divided that shall agree with the Divisions of any other made after the same method, without need of any Standard to adjust it by, provided there can be any thing pitched upon to express any certain degree of heat which may be done either by the Quantity of Vapour emitted from common Water being the same, or from the point of Freezing either of water or any sort of Oyle, or else from that degree of heat which makes Spirit of Wine begin to emit bubbles, which I severall times experimented to begin exactly at one and the same point of expansion in Spirit of Wine and may possibly be the most exact. Such a Thermometer, if it shall please yr Lordship to order it I will prepare against the next meeting, and if I am commanded I shall expound all particularities of it more at large in the Transactions.

[Read April 25, 1688.]

7. *A Discourse tending to Explicate the Modus of the rising of Vapours out of Water.*¹

The rising of the Vapours of Water in ye Air, to the height they do, is possibly one of the hardest phænomena in nature to be explicated, considering that the manner of the one is at least 800 times more dense and ponderous yn yt of the other, and consequently according to the received and demonstrative laws of Hydrostaticks, they ought rather to rest on the surface of the water, till such time as they are again reincorporated; but by some change of particles, or what other way it is not easy to define, these vapours do as it were assimilate into ye form of Air, becoming elastick like it, and so continue till the agitation which caused their emission or exhalation ceasing they again resume the form of water. This being the most simple appearance of the kind, the solution hereof may possibly give some light towards the understanding of the more difficult Quæries of the texture of bodies, and their various transformations. I cannot pretend to have fully satisfied myself, and I can much less hope to give satisfaction to this Honble. Assembly, but I hope yt something not unlike the truth will be offered in that I am about to read.

¹ Printed from 'fair copy' in Register Book and Halley's original rough draft.

It is evident by the great ascent of these vapours, yt they are become nearly of the same specifick gravity with the Air, for otherwise no sort of force would suffice to cast so small bodies, through yt medium to so great a distance, but their whole motion would be lost by the opposition thereof. Mr. Newton has demonstrated ye necessity of a Vacuum interspersum, shewing yt the quantity of matter in all bodies is as are their intrinsick gravities, the remaining parts being empty or replete with a substance of such a rarity, as to have its weight not to be considered. We will therefore suppose yt in an infinitely little particle of Air there is 16000 parts of vacuity to one of substance; in water there will be about 20 to one. Gold being supposed to have 19 parts of substance, to one of vacuity. And these particles being assumed to be bubbles, it will follow yt ye thickness of the skin of matter in ye aqueous particle, will be about a 600th part of the semidiameter of such a particle. But of air the skin will not exceed ye 40000th part of the same semidiam. in thickness, which will be a bubble exceedingly thinner in proportion, yn those we see blown with a pipe out of a solution of soap. And as ye arch of one of these particles, is many times stronger yn that of the other, so it is not impossible that one may in the same proportion resist pressure more yn the other, and from ye elasticity or springiness of these coats of the aerial bubbles may the Spring of the Air in some measure be accounted for, it being evident yt very thin bubbles of glass are pliable, and yet restore themselves upon ye removal of what prest them, whereas those made of more thick and stubborn glass maintain their figure, and will not yield without breaking.

To this I shall subjoin an Experiments yt was not long since tryed before this company by the direction of Mr. Henshaw, yt the Vacuum on ye head of the Barometer is susceptible of dilatation and contraction by heat and cold, for yt upon the application of a Candle, the Mercury is found to subside, and upon its removal to return to its former height, which could not be if that exceeding subtile medium which is there did not shrink and swell with heat and cold. Let us say therefore that the vacuity within ye aqueous particles, coming to expand itself by the action of the Sun or other ways, does so far dilate the coat of the aqueous bubbles, that they becoming above 9 times as much in diameter as before, their bulk is encreased 800 times, and their surface about 90 times, by which means the less skin of such a particle will become but a 90th part of the thickness it was before and be nearly æquiponderate with such a bulk of Air, by which means these aqueous vapours will easily mix with or

amongst the particles of the Air, and remain suspended with them, and being become equally thin with ym, will be endowed with ye same elastick quality as ye Air, so long as its bubbles remain extended to the same degree. But the cause of their distortion ceasing, they again return to their wanted magnitude and form insensible drops of water. I here suppose an atom of vapour to be 9 times as great as a particle of Air, which some may think hard; but if we consider yt ye matter in question is concerning bodies infinitely little, tho ye one be 9 times greater yn ye other, yet is this greater less than any assignable magnitude. If these speculations shall seem of weight, and worth the prosecuting I shall proceed to give a further essay upon this subject, hoping to put others more able to conclude upon these enquiries, and that so we may try how we may be capable to comprehend *matter*, which tho the object of our senses seems little better understood yn immaterial substances themselves.

[Read April 11, 1688.]

8. *Concerning the Construction of the Thermometer, shewing the Degrees of Heat and Cold by the Dilatation and Contraction of the Air.*

After what manner this sort of Thermometer is affected by the different pressures of the Atmosphere, and what the differences in the hights of the Liquor therupon will be, I shewed in a Discourse I read the other day before this Honble Company. It remains now to shew how such a Thermometer may be made and the said differences be accounted for, so as the degrees of heat in the Air may be measured by some constant and visible effect therof, such as may be expressible in numbers. I shewed how small the dilatation of Water and Mercury are and that Spirit of Wine boyles, with no great degree of heat, whence I concluded that the Air was the most proper fluid for these purposes, and accordingly I suppose to have obtained the exact rule for adjusting a Thermometer made upon this principle. It has been found by experiment, that the Air in very deep wells and Grottoes under ground, having small apertures to the outward Air, and the Sun excluded, continues both in the Heat of Summer and the depth of Winter or highest Cold, in a mean condition of Temperature and thence is thought to be Cold in Summer and Hot in Winter whereas the difference really is in our pores or sensories which judg of Hot and Cold, by the relation any thing else bears to the temper of the Ambient Air. This is demonstrated from the Thermometer kept for a long time together in the grotto under the Observatory of Paris by Mr. Mariotte, who affirms that in the space of some years he did not find that there was any

sensible alteration of heat or cold so much as to amount to the tenth of an Inch either in Winter or Summer. This being granted I suppose that this state of the Air may be best put for the beginning of the divisions of a Thermometer, rather than the freezing point, it being very hard to find just that state of the Air, which neversolittle colder will freeze and never so little warmer will not: besides deep sellers and subterraneous grottoes may be every where found to adjust by: By some experiments I have made I found that the heat of Summer does not expand the ordinary air full a thirtieth part and Mr. Boyle in his History of Cold, Tit. 18, Parrag. 8, Pag. 475, alleages experiments proving that the force of the strongest cold we have, does not contract the air above a twentieth part, the sum of a twentieth and thirtieth is a twelvth part, but we will suppose it a tenth, and that 20 parts of Air in the mean state will be contracted to 19 by extremity of Cold and dilate to 21 by heat. wherfore to avoid the rising of the liquor into the head of the Glasse, it will be necessary that the Capacity of the Cane be 2 parts such as the head holds 19, and if it be more it will do no harm. 4 foot may be a good length for such a Cane and if the head be sufficient to hold a wine pint or 29 cube inches, the cane must containe at least 3 such inches, and its diameter will be better than a quarter of an inch. if it be smaller the cane may be longer, and the divisions will be wider. A Glass or Cane being proposed to make a Thermometer withall, first the whole capacity therof, must be obtained either in Water or Quicksilver (which by reason of its dryness and its not sticking to the sides of the glass is most proper) and will be easily had by weighing the whole glass full of liquor allowing the tare of the glass, then pouring off the one half of ye liquor of the Cane, or to the division designed for the mark of Temperature; see how much remains in the glass; of the weight wherof take such a part, as the hight above the surface of the Liquor, of the Mark designed to be is of the hight of the same liquor answering to the weight of the Atmosphere which in water is alwais between 32 and 35 feet. This part added to the Liquor that filled half the cane shall be the just quantity necessary to make the Liquor, when the Cane is inverted, stand at the hight desired; and having found by experiment how far a twentieth part of the capacity of the head and cane reach in the cane, both above and below that mark for temperature, those points being pricked down will give the points for extream heat and cold, and their distances above and below may be each divided into ten equally if the cane be of an equall bore, otherwise unequally so as to divide the solid capacity of the cane into ten equall parts. these divisions

shall shew the ten degrees of heat and as many of cold and this instrument may be easily made in any part of the world and will suffice to give the Comparative heats of Clymats and Regions, which without agreeing upon some such geometricall method of making [*Remainder missing.*]

[Read March 6, 1688/9.]

9. *A Method of Walking under Water.*

To walk on the bottom at a considerable depth of Water and to be there at Liberty to act, or manage one's self to the best advantage as if one trodd upon the drie ground, is without doubt a contrivance of great use in the saving things lost in Shipps or otherwise under water. What I can learn has been yet done herin, is first by plain diving or the power of suspending respiration for a considerable time, so that a man shall be able to continue under water severall minutes of an hour. This faculty is by long habit acquired, and there are many very excellent at it among the pearle divers in the West Indies, who have lately been made use of to very good purpose in the recovering of the plate lost in the Spanish wrack, but it is but a very short time that a man can endure the want of Air; and besides the pressure of the water when the depth is considerable, does very much incommode the diver, especially if he stay anything long, so that it is said the blood will gush out at their ears and noses. To remedy this the Diving-Bell has been invented wherin there is a considerable quantity of Air contained near the bottom of the water to save the trouble of coming up to the topp for breath, the diver when he can bear it no longer retreating to his reserve of air for succour, where having refreshed himself he is again fitt to go about his business: But in this case the diver is obliged to do all he does holding his breath, which must needs take away the Liberty of action, and grows still more and more uneasie till such time as he can endure it no longer. Therefore how to obviate this inconvenience and to contrive a means to be under water and to move there breathing all the while, as I have contrived it, may be a consideration not unworthy this Hoble. societie.

This in my opinion might be very well effected, if a vessel were made of Copper or wood of a Hemisphericall or Cylindrick form so as the diameter might be about twice the hight, suppose one 8 foot the other 4, this to be put inverted, or the close side upwards upon two Axeltrees on which should turn 4 wheels of Brass or Lead, so heavy as nearly to make the weight of the whole composition equall to the weight of a mass of water as great as the capacity of the vessell

and the bulk of vessell axis, wheels and all. Such a vessell will when put under water be very near equipondrate with it, and consequently be moveable there with a very small force that is to say when the whole vessel is full of Air: but the air being capable of compression, and occupying but half the space when it is under the pressure of 33 foot of water, it will follow that at that depth the cavity of the vessell will be half filled with water and the other half with Air condensed into half the bulk: and at 100 foot drop that $\frac{3}{4}$ of the vessell will be filled with water, and only one $\frac{1}{4}$ with Air compressed into a 4th part of its naturall bulk. And by this means ye weight of the Engine which at the first immersion was nearly equall to that of water will become immoveable to the strength of a Man unless we can drive out this water, which enters thus more and more as it deepens. Now this, as it seems, cannot be better performed than by sinking down vessells of compressed air from above, which being received below & opened under the cavity, and there filled with water, will increase the Air and drive out the water in the vessell; which may be repeated till such time as all the water is expelled and the whole vessell full of Air which will be compressed according to the depth; by this means the Engine will return to its first weight and be as easily moved at that depth as at first: and besides the Engineer will be no farther in water than the Radius of his Wheell is high, which needs be no more than up to his knees, so that he will have his whole strength to manage his engine as he pleases, and to work under it as occasion shall require; besides he may direct it as he pleases by a compass or magneticall needle within with him, and the weight of the whole being equipondrate with water he may easily raise it from the ground and turn it about as he sees cause. And if he be provided with such boots as the fishermen use he may be cloathed and stand dry on the bottom of the sea, tho it be 20 fathoms deep. The only objection I am not prepared to answer is that the Air when much Compressed may possibly be unfit for respiration at least hurtfull, but it may be said that no experiment I know of concludes compressed Air to have any such ill quality, and on the other side there being more therof taken in at every reciprocation of the Lungs, there is likewise more of the Nitro aeriall spiritt or pabulum Ignis taken with it, which consequently should render it more vitall; and fewer inspirations should serve our turns than in the Air we breath here.

[Read January 28, 1690/1.]

10. *Of Refractions.*

Having according to an order of the last day enquired what hath

been done concerning the refraction of liquors and is to be found in the books of the Society, I find there were severall experiments made and entered in the Journall-book No. 2. by which it appears that Oyle of turpentine has much the greatest refraction of the Liquors then tried, but the experiments then made do not in minutiis agree among themselves either by reason of some defect in the method of observing them, or rather considering they were made by the accurate hand of Mr. Hook, in the transcription and copy from the rough minutes of the Society; and the instrument wherby those observations were made, not being at hand, I thought I might offer something that might at least not give offence, in showing how the same proportion may be discovered with sufficient accuracy, by a very easy and practicable contrivance to be had at all times and wherby I doubt not but I shall put it past dispute whether common water does refract in the proportion of 1000 to $766\frac{1}{2}$ or 748, or Oyle of Turpentine as 1000 to 684 or 696, for the experiments hitherto made leave it uncertain within those limits.

The Law of the Refraction of the beams of light in transparent media was first discovered and published by Des Cartes in his Dioptricks, viz. that the sines of the Angles of Incidence and of the Refracted Angles are always in the same Ratio as is declared by Fig. 1 where the beams AD falling out of a rare medium as Air into a denser medium as water, glass, &c. are refracted or cast downwards towards the perpendicular in the lines DN under this condition that the lines AH and NL being the sines of the Angle of Incidence ADH and of the Refracted angle NDL are always in the same proportion, and this is a true proposition tho its author Descartes wholly mistook the cause when he assigned an easier passage to the beams of light through all transparent bodys than through the Air. But it has been since demonstrated that these bodys do retard the motion of the beams of light and that the phenomena of refraction are duly solved by supposing that light does penetrate these transparent substances with more or less velocity in the same proportion as are the sines AH and LN. This Mr Hugen's has most ingeniously made out in his late treatise de la Lumiere to which I refer, and experiment has taught us this proportion in severall bodies is in water from air as 3 to 4, in glass from air as 2 to 3 or more nicely as 193 to 300, and by the experiment I shewed the last day on a Diamant it is found to be as 2 to 5, or more justly as 51 to 125, which perhaps is the greatest refraction to be found in any transparent body that nature affords. This led to the consideration of that

texture of body which being so perfectly clear does yet so very much retard the motion of Light and having examined the specifick gravity of a Diamant by the curious essay ballance at Gouldsmiths hall where wee weighd in water two Diamonts of about 20 gr. each, it was found that a Diamant did not much in weight exceed glass being just $3\frac{1}{2}$ times the weight of its bulk of water wheras glass weighs about $2\frac{2}{3}$. But however I concluded that the weight being proportionate to the matter in each body, the Refractions of all bodies would be more or less as they were more or less weighty till upon experiment I found it otherwise, for having procured a sort of paste or artificiall stone wherin I suppose some metallick tincture to be lodged that gives it a green colour, its weight being above 5 times that of water and near double a diamants yet I find its refraction to be considerably less, though it still exceed that of glass, being in small numbers nearest as 6 to 11 or as 27 to 50. This I thought so considerable that I might merit the consideration of this Honourable assembly that it might be examined wherin consists the transparency of bodys, and from what proceeds their degree of refracting or rather of their obstructing the passage of Light, whether it be from their hardness or weight or both together; a Ruby I observed to refract in the proportion of 4 to 7 nearly and a piece of native chrystall given me by the Honourable president I found to have the refraction of 194 to 300 which is the same or very near that of glass though its substance be much harder and of a natural concretion made without fire. That of the green paste I have brought in order to shew the experiment therof before the Society, as likewise again to shew the manner of obtaining the refractions of transparent solid bodies having never so small a piece wheron two plaines may be polishd with a convenient angle.

[Read March 25, 1690/1.]

11. *On the Height and Velocity of Bullets and of Spiriting Waters in 'Fects d'Eau'.*

The last day I proposed in this Hoble. Assembly to Explain the Velocity of the Explosion of Gunpowder, and of projectiles cast by it by the consideration of the motion of fluids prest by an incumbent weight and to do this I calld in Mr Newtons 37 prop. of II. book wherby he demonstrates the Velocity of Water or other liquors running out at a Hole to be the same with that of a body falling from half the hight of the Liquor, at the end of its fall. Hence it is that the Velocitys are as the Square Roots of the hight of the liquors: That is a double Velocity is occasioned by a Quadruple hight a

treble by a Noncuple &c and to bring that to measure, if the Reservatory of Water be 32 foot high, the velocity of the water will be the same as of a body fallen 16 foot, as all bodies do in a second of time, now that velocity is at the rate of 32 foot to a second. and for any other hight as $\sqrt{32} : 32 ::$ so $\sqrt{\text{hight}}$ to the velocity of the Liquor pressing by its weight out at a Hole: And this rule Holds true be the liquors lighter or heavier: If then our nitrous flatous have a spring equall to the pressure of 4000 foot of Mercury and be 1600 times more dense than Air, it will be about twice heavier than water, and nearly 7 times lighter than Mercury. that is to say it will be equall to a pressure of 28000 foot of a Medium as dense as the nitrous flatus while confined in the chamber of the piece: and will in the beginning of its dilatation when at liberty aquire the same velocity as a falling body has after it has fallen 14000 foot that is by the former rule as $\sqrt{32}$ to 32 or $\sqrt{2}$ to 8, so $\sqrt{28000}$ or 168 foot to 946 foot in a second of time the Velocity of the first motion of Expansion of the powder, which is about a mile in 5 seconds, and which is above double the Velocity of the motion of sound, and which could carry a bullet 14000 foot perpendicularly high, or at 45 gr. range a shott 28000 or better than 5 miles which perhaps is the utmost scope of the projections to be made with powder. If this expansion be opposed by the weight of the shott that weight is to be reduced to a cylinder of the bore of the chamber of the piece and of the same specifick gravity with, the medium viz about 2ce the weight of water, and the lenth of this cylinder is to be deducted from the aforesaid 28000 foot, and then the Velocity of the remaining part of the Cylinder as it would vibrate in a syphon will give the motion of the bullet cast forward by the Expansion of the powder: It is to be noted that Mr Mariotte in his book du Movement des Eaux has committed a gross mistake in his assigning the hights of Jects d'eau to be equall or nearly so to that of the Reservatory of water, for by Mr Newtons demonstration it can mount but to half that hight and the quantity of water evacuated at a Hole which he Mr Mariot says pag. 265 was verified with all imaginable care it does appear that the velocity of the Water was that that would carry it exactly half the hight and no more. Notwithstanding pag. 309 & seq. he pretends to severall experiments of the rising of water nearly to the top of the Reservatory. and therefore it is necessary those pretended experiments are fained, which much calls in question all the rest of his book where he alleages tryall.

[Read April 22, 1691.]

12. *Of the hight of fountains . . .*

At the last meeting I had the honour to show this Society a very notable difference in Two eminent Authors about the Hight and velocity of spirting waters in Ject d'eaux: Mr Newton in one of his proposition asserting its swiftness to be that of a body falling half the hight of the incumbent fluid, and consequently that it can spirt at most but half the hight therof; But Mr Mariotte in his *Traité du Mouvement des eaux*, does assert and alleague severall experiments to prove that water will rise in a fontaine to the whole hight of the reservatory: and consequently that water wch passes out at a hole has the velocity of a body fallen the whole hight the incumbent water. This I had the last day the commands of this assembly to see experimentd which accordingly I have prepared. But as I mentioned then in pag. 265 of Mr Mariotts book, the expence of a fountain whose reservaty was 13 foot high at a round hole of $\frac{1}{4}$ of an Inch or 3 lines as the french divide it did in a minute of time evacuate 14 Paris pints which are there said to be 35 to the cube Paris foot that is $\frac{2}{3}$ of the Paris cube foot in a minute. the 60th part therof is the $\frac{1}{150}$ part of the cube foot for each second of time and that is $11\frac{1}{2}$ cube inches equall to the Cylinder of water that past out at $\frac{1}{4}$ of ane Inch bore in a second, now the area of that circle whose diam is $\frac{1}{4}$ of Inch is between $\frac{1}{20}$ and $\frac{1}{21}$ of a square inch. and dividing $11\frac{1}{2}$ inches the capacity of the Cylinder by its basis the Quote is its length viz 234 inches or $19\frac{1}{2}$ foot in a second of time and with this velocity it is necessary the water must have issued out at the hole whatever the subsequent velocitys were, in the Air. And if wee suppose with Monsieur Hugens that the fall of bodies be 15 foot 1 inch in a second and the velocity of such a falling bodie to be $30\frac{1}{6}$ foot in the same time, it will follow that the hights being as the squares of the Velocitys. as 910 to 380 so 5 foot 1 inch to $75\frac{1}{2}$ inch or 6. ft. $3\frac{1}{2}$ which is less than half the hight of the reservatory, wherfore it is evident that these two experiments of the quantity of water and the hight of the Ject. cannot stand together unless there be a considerable error in the supposed force of gravity of 15 french feet in a second. for if $19\frac{1}{2}$ foot in a second rises perpendicularly 13 foot it will follow. that the velocity of a falling body be about $14\frac{1}{2}$ in a second which is not half what is at present taken for granted from ye demonstration of Mr Hugens prop. 25 Horolog. Oscillatoij and yet more certainly from the proportion that gravity bears to the vis centripeta in the Moons orbit, which our Artists have discovered,

so that this principle seems unquestionable that the force of gravity is duly stated. It remains then to consider what may occasion this ascent of water to the Horizontall line, if it by experiment shall be found to be so, it having no greater velocity at its exit than appears by the quantity of water emitted, and yet ascending Higher by near half than that velocity can cause: if it be said that the friction or rubbing of the water against the sides of the hole does hinder it from going out with the quantity requisite. It is certain that the whole water does nearly ascend to the same hight, as well that that comes out of the sides of the hole as that that comes from the middle therof, as may be seen by arching Ject d'eaux in a parabolick figure. But if it were considerably hindered in passing the water from the sides would fall short of the due hight, so that the difficulty still remains, which abler artists are desired to discuss. From this experiment of this velocity of water pressing out at a hole are determined severall things of great use in Hydraulicks as ye proportioning of pipes to the barrills of pumps that the water may come easily so as to ballance the pressure of the Atmosphere, for 32 foot of water is equall to the pressure of the Atmosphere, which is the utmost hight that sucking pumps can raise water. If at 16 foot high above the water the pump make a vacuum, the velocity of ye water following the suction or stroke of the pump, will be that of the water pressing from a reservatory of 16 foot high: if at 8 foot of hight above, it will have the same velocity as if the reservatory were 24 foot, that is it will always be the velocity of water running out at a hole when pressed by the difference of 32 foot and the hight of the sucker of the pump: but if the pipe be so small as not to admitt the water to follow fast enough then must the hand bear the pressure of the Atmosphere in raising the sucker, which hinders the effect and very much encreases the Labour in pumping.

[Read Aug. 26, 1691.]

13. *A Relation of the Diving Bell.*

Having received the Societys commands to give them an account in writing of the success of my attempt on the Guiney frigate, and of the improvemts I have made of the Diving Bell. be pleasd to take the following relation.

The Diving tub was made 5 foot at Bottom where it was open 3 foot at top and 5 foot deep which contained about 64 foot in capacity and consequently required about 36 hundred weight to sink it which I applied as near as I could to make it tractable partly by bestowing about 10 hund. of Lead on the outside therof which

besides the weight had the use of making it perfectly tight, for the rest of the weights I hung them on two strong Iron rings which were one over the other as near the bottom as could be with convenience, and under the bell by three ropes I fastned a stage about $2\frac{1}{2}$ foot below to stand on, which 3 ropes held likewise each 2 ct. weight which contributed greatly to keeping the whole engine upright and secure from tripping: Within the bell I placed a bench about a foot from the bottom for the men below to sitt on when they should be cold and wheron a man might sett with all his clouths at any depth drie. I made likewise in the top of the bell a window to let in the light, which was very thick and strong but as clear glass as could be gotten and I placed a small Cock in the same crown of the bell to let out the hott and effete air unfitt for farther respiration:

When we lett down this engine into the sea we all of us found at first a forceable and painful pressure upon our Ears which grew worse and worse till something in the ear gave way to the Air to enter, which gave present ease, and at lenght we found that Oyle of Sweet Almonds in the Ears, facilitated much this admittance of the Air and took of the aforesd pain almost wholly.

Then it was observable that the water entered very deep into the bell, if we lowerd much at a time, and that at two fath. depth we had a foot water in it, or up to our bench, wherfore we were obliged to lower not above 2 fath. or 15 foot at first at a time and so drive out the water that entred before we lowerd any more, wherin consisted the principall invention I can boast of.

To do this I took a good Iron bound cask which held about 40 gall. and coated it over with lead so that it would sink empty and in this I made a bung hole in the parts designed to sink undermost, and a cock in that to be uppermost: this I contrived two guies for which when it sunk conveyed it always under the Diving Bell, when turning the Cock the air rushed out with great force into the bell whilest the water entred by the bunghole in the bottom of the Cask, then when the Air was all gone and the Cask ceasd to blow, by a signall given the cask was hald up again and being above water all the water run out at the bunghole and the Air entred by the Cock, which being turned the Cask was again sent down as before. Thee cask would usually drive out all the water that entred in lowering 2 fathoms $\frac{1}{2}$ when we were down as low as we intended then we began to let out our hot Air at the top of the bell just before wee received a Cask of fresh, wherby we renewed and recruited what was rendred effete and unfitt for respiration.

By this means I have kept 3 men $1\frac{3}{4}$ under the water and in ten

fathoms deep without any the least inconvenience and in as perfect freedom to act as if they had been above. It was observable that when we were ha'ld up, the Air coming to be rarified would immediatly fill with a white fogg as thick as any winter fog appears, which likewise would stink like our foggs here, but which would vanish upon the bells coming above water in an instant as it arose.

We observed that we had 2 sorts of light, the one that came by reflection from the water under the bell which cast a pale sea green colour on all objects it was cast on, and that by refraction from above by the glass which cast a pale Cherry colour or flesh colour especially when the sun shone strong: we found likewise that a man that hurt himself by bruising his finger had his blood tinged of a deep Verdigrise green, without any sign of red in it, and it was to be noted that he bled in so great quantity whilst he was under water as if a mans nose had bled violently, which was without doubt occasiond by the great pressure of the Air we were then under.

This method of keeping men under water has no limits, for if the bell be made greater and the Air Cask proportionable any number of men assigned may be supplyd with breath for as long time and at as great a depth as shall be desired and by what we have found at 10 fathom I see no reason to doubt but a man may be well enough in 20 or 30 fathoms without harm

[Read Sept. 23, 1691.]

14. *Of Conveying Air into the Diving Bell.*

I have at severall metings of this Honble Society proposed severall contrivances to convey Air under water for the use of Divers and particularly to Enable them to go out of the Diving Bell and continue there a time sufficient to do any manner of business, but this extended no farther than to work *on* or *above* the Level of the Water in the Diving Bell; and I hoped not to attain the art of going below the levell therof, by reason of the unaptness of so light a body as the Air to descend in Water; such is the darkness of Humane understanding, that we are apt to overlook the naturall and most facile ways of doing the thing wee desire; and believeing difficult what is in it self easy; look above the proper media wch ought to be applied, and fall upon more complicated and perplext. This was my case in this matter of Diving wch I thought to have exhausted; but without hoping it at lenght I fell by accident on the means of doing it, and which is the more considerable to make the thing do itself without Labour; for I now am sure, that I can maintain one or more men, to walk about and between the decks of a shipp in any reasonable

depth, and to maintain for them a light in a Lantern, without which they could not see to do any thing; and by this means that I can unlade a shipp at the botom of the sea without breaking her, which besides thinking my self bound to reveall this hoble. board, in consideration of my relation to this Society, I do therby desire to conserve to my self the right of priority of Invention on your Testimony and Register, being as I conceive like to be of great Use, to my self and those that shall have occasion to recover any thing from under water.

The Invention is this; A Man having a suite of Leather fitted to his body, with a cap of Maintenance such as I have formerly described, capable to hold 5 or 6 gallons, must be perfectly inclosed so as the water may as little as possible soack in upon him, must have a pipe coming from the Diving bell to his Capp, to bring him Air, which must be returned by another pipe, which must go *from* the cap of Maitenance, to a small receptacle of Air placed above the Diving bell into which it is to return the air, that has been breathed; whilst the other brings it to the man; and it is necessary that the Air must be pressed in to the capp of Maintenance, because the weight that lies on the Air in the bell, is greater than that on the small receptacle by a Cylinder of water equall to the difference of the hight of the surface of the water in both cavitys, which being 6 or seven foot will drive the Air with great swiftness, and the quantity of Air necessary to be transmitted may be regulated, (after the rate of about 2 Gall. $\text{\textcircled{P}}$ minute, with which by experiment a man breaths freely), either by contracting the Aperture of the pipe by the bore of a Cock or elce by diminishing the difference of the pressure on the two receptacles of Air. After the same manner may the flame of a Candle or lamp be conserved under water with much about the same expence of Air so that 4 gall. $\text{\textcircled{P}}$ minute or a tun $\text{\textcircled{P}}$ hour circulating after the manner I have described will be sufficient to maintain a man and his light in any reasonable depth under water to walk up and down about any business he could do in a shipp were shee above water. Nor do I belive any further thing can be hoped or desired in the art of going under Water.

[Read Sept. 30, 1691.]

15. *Of Sound under Water.*

It is the common oppinion and perhaps the true that Sound is no other than an undulating tremor of the Air, which has been proved by the ceasing of Sound when the Air has been pumpt out by the pneumatick engine, and by what I lately experienced in my Diving

bell, where the water cutting off all communication between the Air above and that included it was impossible to make them below hear any sound though never so great from above, and the contrary, though we fired a great gunn just over the bell when it was but a fathom under water. However there are severall known experiments that seem to contradict this Hypothesis, as that a striking watch included with the Air in a glass receiver, is well heard through the glass, though the outward Air have no communication with it, nor can the tremor thereof be supposed to be continued through any imaginary pores of the Glass, which shutts out the Air perfectly. Again the stroke of the Lead in sounding on hard ground, is very well to be heard, when the fall of the same Lead without a line is no way discernable to the Ear, whence it should seem that the Sound is conveyd by the continued parts of the line. The same may perhaps be said for the sound of the watch included in a receiver, and resting on the bottom that shutts it up, but it will be very hard to shew how the same tone from the bell of the watch to the bottom on which it lies loose, should be propagated to the Air without it. To examine this perfectly I have thought of the following exp. viz. to let the watch swim in another vessel on water, then to putt over it a receiver immersed so far in the water as to hinder the communication of the included Air with the externall Air and then to trie whether the Sound can be heard through the glass, for if it can, it is evident that it is not from any tremor impressd by contact, but that the motion once begun does really permeate the glass and cannot therefore be that of Air which is entirely excluded by glass, and then a Secd. Experiment will be to trie whether the same watch being wholly covered in water under the receiver will notwithstanding be heard, although it may happen to be heard when the receiver is in the Air. What conclusions may be drawn from the success of these experiments may possibly serve to entertain this Honble Assembly.

[Read Oct. 21, 1691.]

16. *Of Working under Water in the Diving Bell.*

Having obviated severall difficulties that I had found in the matter of continuing under water, as to the want of Air, Light and Heat, there yet remained one principal objection, which is from the agitation of the Surface of the Sea, which at lenght I think to be master of, that I can work in any seasonable weather. Having fortified myself against cold by a double or triple flannel or knit woolen westcoat and excluded the water by a well liquored leather suit

made fitt and close to the body, I make my self considerably heavier than water by adding a girdle of leaden shott quilted as is used for making of Horsmans weight, with this the diver can descend easily to the Diving tubb which is to be always left standing on the bottom, wherby with a buoy to find it, the bell will have no motion from the agitation of the waves but remain firm on its weights at the bottom, and to return again to the topp there is no more necessary but to leav off the girdle of shott, and then the Air in the small vessell on the head of the diver, which from its shape and use I call a capp of maintenance, will raise up the man and supply him with breath till he return to the waters surface. Thus there is no need for the bell to be drawn up to change the men, if any have a mind to come up: and this will ease the great trouble of the whole affaire, which requires so much strenght, and employs so many hands. I have likewise since thought of a means for weighing of shipp, which I think preferable to all others, viz. by sinking large vessells full of water and plac-ing them as best may be done affixt on the ports, ringbolts, chain plates and other fastning of the shipp, and then by conveeing air into these vessells, being open at bottom, by the help of the Air barrell; which is practicall to any depth and these vessells need be no stronger than to bear the weight of as much water as they will hold, and besides in haling down empty casks if they be tight and the Air entirely shut up they will stave with the pressure of the outward water, when the depth is great, and again to hall them down under water strains the thing to which the fastning is to be made with double the weight to be applied whilest perhaps it bear no more stress than the cask itself; but the principall use of this way is to fetch up a ship from the whole depth at once and not tide by tide to raise her more and more, as has been hitherto practised.

[Read Oct. 28, 1691.]

17. *An Account of Two Instruments (1) Shewing the Depth of the Water to Persons within the Diving Bell, (2) For Blowing Up the Decks of Ships under Water, or Houses in case of Fire.*

In severall of the late meetings of the Society I have shewn the means of subsisting under water, and how to be secure against the pressure of the water, the want of Air, of Light and Heat, as also how to Ascend and Descend at pleasure, and this by methods practicable as well by those that cannot swim as by those that can. By which I presume I have perfected the ars Urinatoria; and good part of these contrivances having already had the entended effect, I am

not doubtfull for those that I have as yet wanted the opportunity to trie. Since the last meeting I have thought of two Instruments serviceable to this purpose the one by means wherof the persons below may at all times tell how deep the water is over their heads. This is either a Barometer if the depth be small, wherin the water will raise the Mercury 5 inches $\frac{3}{16}$ for each fathom of depth, above the hight it rises to by the Airs pressure: but in great depths the lenght of the Mercuriall tube will be so great as to exceed the hight of the bell and become impracticable. For these cases a gage or bended syphon with two shanks. having the one end seald up with Air within it and the other end open and water in the inside [?] or bended part will be most proper, for the pressure of the water will drive the included Air in the seald part of the Gage into a lesser space according as the depth is greater, and this may be graduated either by experiment, or by the rules of the compression of the Air, which is proportionall to the depth, and the divisions are discovered by the Asymtotes of an Hyperbola. With this instrument which may be carried down in the Diving bell it will be seen by inspection, att what depth the bell is, without the trouble of sounding. But this perhaps may pass for a bare speculation or curiositie. The other instrument is proper for blowing up of ships under water or houses in case of fire, with a small quantile of powder and a secure effect. This is by a sort of Morterpiece to be fitted on the head of a post or beam and be lett into it so as that the reverse be born by the whole flat head of the post. This must have a fire lock affixt to it in a separate box and must be pitcht up, if it be for under water service, that no water may come in, only there must be a touch hole to communicate the fire to the powder which must fill the whole cavity of the mortarpiece. And the tricker must be likewise so secured that it may not go down till it be puld very hard by a string which must lay hold theron, after it is fixt in the place where it is to be discharged. The placing of this to best advantage will be between the deck and wedging it that it may have no recoyle and it will not easily be conceived how vast a force 8 or ten pounds of Gunpowder so included will produce, and how securely it will carry up the floors and roof of a house especially when there are stancions from floor to floor.

[Read Nov. 11, 1691.]

18. *An Attempt to Measure the Strength or Force of Running Water.*

Having obviated all other difficulties that might obstruct me in the Art of Diving and working under water, I came at lenght to the

grand impediment of a Stream the force of which when it is swift, as far as I can yet see, will make it uneasie if not unsafe to those that withstand it. However the speculations that occurd to me on this occasion may possibly be acceptable in this Honble Assembly. This inquisition naturally lead me to an attempt to measure the strength or force of running water, and it was at first plain that the direct pressure of a stream was equall to the weight of so much water as would generate a motion equall to that of the stream: and by Experiment made here not long since, it did appear that the Velocity of water pressed by the incumbent wt. of water in a vessell, was equall to the velocity of a body falling from the ht. of the incumbent surface, and from the known properties of gravity it is clear that the squares of the velocitys are as the hights, and 16 foot being the fall of bodies in a second of time, it follows that the velocity at the end of that fall is 32 foot $\text{\textcircled{P}}$ second, and by the rule as sq. of 32 foot viz. 1024 to 16 foot or 192 inches, so is the sq. of the Velocity of the running water, or its motion $\text{\textcircled{P}}$ second measured in feet to the hight of a Cylinder of water equall in weight to the pressure of the stream. So if a stream run 4 foot in a second which is about $2\frac{3}{4}$ miles in a hour, which equalls the strongest tide in the river of Thames, it will be as 1024. sq. of 32. to 192 inches, so 16 the sq. of the Velocity is given to 3 the hight of a cylinder of water equall in wt to the force of that stream: and if a piece of wood two foot square be exposed to this pressure it shall be counterpoised by the weight of 2 solid cube foot of water or $62\frac{1}{2}$ lb, but if a cylindrick body be exposed to such a stream, the force of the water pressing theron is diminished in all points as the sines of the angles of incidence on the curve surface, so that the pressure which in a flatt body was as the square of the velocity; on a round is diminesht in the proportion of a circle to the circumference squared. But if it be desired as in our case to provide that a man shall not be carried away by a stream, it must be considered that the force of the stream may be overcome by the bearing of the center of gravity of the man's body from its fulcrum against the pressure, and by the addition of wt, wherby he will be the more stedily affixt to the ground. But the force of the water acting on him will be as the profill or area of the out lines of a mans body, having perpendiculars erected on it, equall to the hight before found, answering to the strenght of the stream given, but divided diagonally; which figure by reason of its difficulty is hard to express in draught or words other than showing it. Now if the weight of this figure in water do not exceed the Inclination of the Center of gravity of the mans body from the perpendicular against the stream

the man will stand steady and withstand the Current, but if the Center of gravity pass of to the opposite side yeilding to the stream, it must necessarily Carry him away before it.

[Read Nov. 18, 1691.]

19. *The Manner of Computing the Weight or Force of the Winds. . .*

In the last meeting I shewed how to measure the force of a stream pressing upon a body suspended in it and that it was equall to the weight of so much water as would engender the velocity of the stream in the beginning of its fall, and upon supposition that heavy bodys descend 16 foot in the first second, wherin they aquire the velocity of about 32 foot in a second, I shewed that the proportion was as sq. of 32 to square of the Velocity expressed by the motion of the water in feet in a second of time, so 16 foot to the hight of a Cylinder of water equall in weight to the pressure of the stream. I likewise shewed that a round body makes less opposition to the stream than a flatt, and that the difference was as the Area of the Circle to the square of the diameter, and lastly I shewed how the force of a stream acted upon a body standing fixt at one end, as a man standing on the bottom of a river, viz that the force of the stream was as the aforesaid cylinder of water divided diagonally from the foot upwards: this occasioned some discourse concerning the force of winds which may and ought to be considered as streams or currents of the Air, and it was recommended to me to shew the manner of computing the weight or force of the winds upon the same principle. To do this it must be considered that Air is in weight to water about $\frac{1}{850}$ part and that from the laws of the motion of projects, it is plain that the velocity of Water pressed with the same weight as Air is to the Velocity of the Air, as 1 to $\sqrt{850}$ or 29, whence it follows that the swiftness of the Air being 29 times that of a stream of water the Effect will be equally strong, and that the swiftness of the wind being given, $\frac{1}{29}$ part therof will be the swiftness of a stream of water equall in force to that wind or rather that 29 foot of the Area of a sayle shall receive as great a strength from the wind as one foot therof from a stream of water equally swift with the wind. Hence may be computed the Velocity that any quantity of Saile in a given strenght of wind shall impress on a given vessell moving through the water. there being always an equality between the force of the wind acting on the Area of the expanded sayles and the force of a stream equall in swiftness to the way of the ship or vessell acting on body of vessell, whose various figure does [*Ends abruptly.*]

[Read Dec. 23, 1691.]

20. *A Way of Estimating the Necessary Swiftness of the Wings of Birds to Sustain their Weight in the Air.*

I have formerly shewn before this Honble Assembly the means of estimating the force of a stream of water and of the Wind, which is to be considered as a Stream of the Air. I likewise shewed that the force of a body moving through the Water or through the Air, was equall to the force of a stream of Water or Air, equall in velocity to the body moving, respect being had to the oblique incidence on the body according to its figure. I then shewed that a stream of 4 foot in a second was equall to the weight of 3 inches of water pressing perpendicularly on the same surface; and that such a stream pressing on a board of 2 foot square, was equall to $62\frac{1}{2}$ lb. Avoirdupois and in consequence therof I shewed, that the force of the Air of equall velocity was the 29th part of the force of a stream of water, and that Air moving 29 times as fast, the force therof was equipollent with a stream of water. This led me to consider the necessary swiftness of the wings of Birds to sustain their weight in the Air, for it is necessary, that the force and velocity of the wing bearing against the Air, must exceed that of a wind capable to sustain the weight of the Bird, if its wings were only expanded and kept immoveable, to receive the *impetus* of the wind blowing in this case perpendicularly upwards. To measure this necessary swiftness of the Wing I procured a pigion, a bird of Quick flight, and weighing it I found it to weigh 8 ounces $\frac{8}{10}$ Troy, and the wing expanded to contain in Area 35 square inches each. It remains then to find what stream of Air is requisite to sustain $8\frac{8}{10}$ oz. Troy on 70 inches expanded wing. And in this proportion each foot must sustain 18 ounces. But with the same velocity of water each foot of wing ought to sustain 29 times 18 ounces, that is $43\frac{1}{2}$ lb Troy, or about 8 inches deep in water, that is nearly $\frac{2}{3}$ of a solid foot of water. Now by the proportionall force of water pressing out of a hole, it follows that 8 inches deep will run out at a hole at the rate of 6 foot and half in a second; for as 192 inches or 16 foot to the square of the velocity it engenders, viz 1024 sq or 32 foot, 8 inches the hight of so much water to 42 sq. or $6\frac{1}{2}$ feet the swiftness of the stream of Air in a second requisite to sustain weight of the bird. But wings large enough to sustain the weight of one man with the same velocity of the stroak ought to be in Area 200 times as large as those of this bird, that is in their linear dimensions 14 times as great and consequently they ought to be about 12 foot long.

[Read Jan. 13, 1691/2.]

21. *An Instrument for Measuring the Way of a Ship.*

In one of the late Meetings of this Honble Society, I proposed that by the angle made by a line to the perpendicular charged with a given weight, and towed by a shipp, might be made a very good waywiser or logg, to measure the way of the shipp through the water, since which I have considered how to compute this angle and to contrive an instrument proper for this purpose. The first ingredient of this calculus is the force wherwith a stream presses the ball (which figure I chuse as being allwais alike) or wherwith the ball presses the water, which is found by the proposition I produced the other day, viz. As 64. to 1, so the square of the velocity of a stream expressed by the motion in a second, to the hight of a cylinder of water equall in wt to the force of the water pressing a body exposed to it. But by the 35 prop. of Mr Newtons second book of his *Principles* it is most elegantly demonstrated that the force of a stream against a ball is just half of the force of the same stream against the butt end of a cylinder of equall diameter. That is the force of a stream against a ball will be equall to a cylinder of water having in hight the $\frac{1}{128}$ part of the square of the Velocity, or of the motion of a stream in a second, having for basis the great circle of the sphere or ball lett down into the water. This being granted it will be easy to know how far such a stream shall draw any heavy body from the perpendicular. For if a ball hang on the Center C¹ and its weight or tendency downwards be expounded by the lenght of the line CD, and the force impelling it, being the weight of the water bearing horizontally against it, be likewise expounded by the line DE. it is plain that the body which in still water would have rested in D will by the force of the stream be carried to B. But this follows from the known principles of the composition and resolution of differing forces acting at the same time, but it is to be noted that the weight is not to be taken for the absolute weight of the body but for the weight therof in water, that is by subducting the wt of its bulk of water. This instrument may be also contrived with more balls than one, as for instance one for all motions under 3 miles an hour [*Ends abruptly.*]

[Read March 23, 1691/2.]

22. *Of the Rate of Flow of Water from Vessels.*

It has been generally received as a thing past doubt that water in a larg and open vessell would pass out at a hole swifter and with

¹ There is no accompanying sketch or diagram.

more freedome than in a narrower vessel, however the Curiosity of one Mr. Chamberlaine of Redding prompted him to some experiments of this nature, which from his own relation he seems [to] have tried with great curiosity. He took a barill of a gun being $\frac{5}{8}$ of inch or half inch half quarter in diameter and about the same length and fixt it into the side of a vessell $22\frac{1}{2}$ in. in diameter, then pouring water till it was $12\frac{1}{4}$ inches deep and keeping it as near as might be at the same hight he found that the water running out at this hole did evacuate the capacity of a certain vessell in $57''$ of time. Then putting the very same piece of pipe, into a smaller vessell whose diameter was only $13\frac{1}{2}$ inches, and keeping the water therein at the same hight above the hole of $12\frac{1}{4}$ as before, he found the water running out at it to fill the aforesaid vessell in 41 seconds of time that is in about $\frac{2}{3}$ of the time it had been filled before in by the efflux of the water from the former vessel. This he often repeated and still found the same thing, so that there is no room to doubt of the matter of fact, the author seeming a very curious and intelligent man. Afterwards having open'd a small barill some little matter, to fitt to a larger bore of a longer piece, he found that the same vessell was fill'd with water in 53 seconds from the great tubb, but the lesser tubb did it much sooner, viz in 36 seconds, which is a very considerable difference and the matter is of very great consequence to all those concernd in Hydraulick engines and wholly new and unexpected.

[Read March 23, 1691/2.¹]

23. *Of an Instrument for Observing at Sea.*

Being sensible of the great advantage of Telescope sights in observing of objects on shore, I have long thought if it might be possible to contrive an instrument for doing the same thing in those observations the seamen use to take there Latitude there being no thing more desirable than to attain a reasonable certainty in this affair. At length I presume I have attain'd what will with all possible exactness perform the thing required: that is to make a sea Quadrant wherin both the Horizon and object shall both be seen distinctly and enlarged, at one view in the common focus of a Telescope. The description wherof is as follows. Let AB be a square brass hollow tube so

¹ The Extract from the Journal Book of the Royal Society quoted in Appendix IX, under this date, is followed in the Journal Book by this interesting statement: 'Dr. Hook said that he had long since invented such an Instrument as this, that he made the same Object glass serve for both Objects, and that this was yet more compendious, the Modell of which he produced out of the Repository, and likewise shewed it in the History of the R. Society written by Dr. Spratt.' The reference to this instrument in Spratt's *History* will be found in § xxxvi (p. 246 of the first edition). Halley's rough figure is reproduced in facsimile. Cf. also Appendix III under dates of March 10, 1682 and Feb. 4, 1689-90.

strong as to bear its own length without bending. At A place the Eyeglass, and at B the objectglass of a Telescope of the length required. On this tube let the parallelogram CDEF of equal sides be affixed, which must be moveable on the four Centers C, D, E, F, each of the sides EC, CD, DF, being equal to the distance EF taken at convenience. On the side DF place an object glass of a Telescope as at G, and let it be as much a sphere as to have its focus at the distance of GF plus FH. And over all put a small brass ruler CF, having on the Center F a curious polisht mettall plate, or elce a fine thin plate of glass well foild, and cut so as to reach no lower than the center F, leaving the one half of the object glass at B open; then shall the Horizon be seen directly by the Telescope AB, and the Sun reflected from the plate F in the same point, and the altitude of the Sun be measurd by the Angle AFD., which may be opened or closed as occasion requires by a screw from the opposite angles DE: the which by its finess and by dividing the number of parts in each revolution of an Index, may make the divisions as sensible as can be required, and these divisions again are easily explicable by a small Table of Chords which at sight will give the degree and minute observed.¹

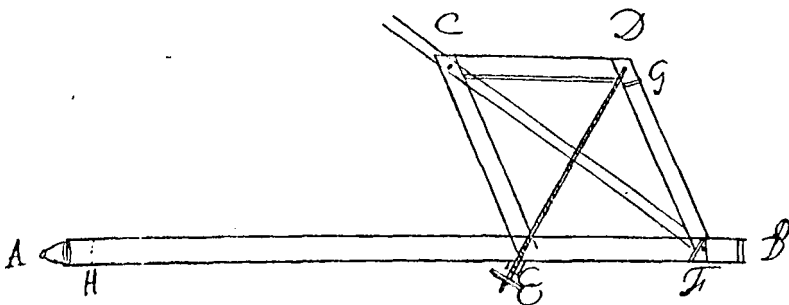

[Read November 16, 1692.]

24. *A Description of an Instrument to Observe the Celestial Motions &c., by reflexion, thro' a Telescope, without elevating the Telescope towards the Object.*²

The Instrument I proposed some time since, to observe with Telescope sights at Sea, and wherein I found Dr. Hook had gone before me, I take to be of so promising a contrivance yt I have ordered it to be made and adapted for that purpose, of wood, for tryal and practice, and design one of brass for use. As then I did

¹ This whole note, as written, is exceedingly rough and hastily scribbled.

² Printed from Halley's original note and 'fair copy' in Register Book of Royal Society.

not believe yt the visible species could be so strongly and truly reflected, as I the last night found it, on no other surface yn that of a polishd glass, for having taken of the polish of the back side to hinder the double reflection, I found that I could most distinctly discern all the small spotts in the Moon, almost as well as in the Telescope directly, and the glass being not otherwise polisht than as a piece of looking glass. It is not to be doubted but being most curiously plane wrought on the plane tools of the telescope makers, much more of the light might be conserved, and the species reflected more vigorously. I tryed likewise how the Stars would appear, which also did succeed. Hence I concluded that this instrument might serve as well to measure the place of the Moon in the heavens, at Sea in reasonable weather, and that when the Longitude shall be found out by the motion of the moon, this or such like must be the tool to observe with. This suggested that it was possible by this method of reflection to keep the moon for many hours togather in a telescope without moving it, only by the motion of the reflecting plate, which must be made to move either by the hand or clockwork, so as to answer the motion of the Heavens. To do this it is necessary that the reflecting plate be posited in some plane yt exactly respects some meridian or intersecting the Equator at Right Angles, and yt it turn on an axis parallel to that of the Earth. That its motion be just half so swift as yt of the object as it passes ye meridian with a relation to the encrease of right ascent. And it is further requisite yt the telescope be directed into some place of the parallel of declination opposite to that of the object entended to be viewed. In which case it is evident that the beams of any object will be thrown by the reflecting plate thro' the telescope. This I conceive would be of excellent use for any person skillful in designing to take the true figure of the Moon, and it were to be wisht yt Mr. Waller's curious hand could be engaged therin. This (as I since understand) has been long since proposed by Mr. Hook as a means of managing a long telescope, viz by reflecting the beams of light along ye tube, that need not be in an elevated position. How far he proceeded in yt matter will appear in the books of the Society: but we having now a glass of above 120 foot long, I think it can be no better way made use of yn by this contrivance, and it will need no pole at all, only an apparatus yt will be conveniently placed horizontall; and will consequently produce but little trouble to the observers, the tube remaining immoveable for ye same object. The reflecting plate being moveable only, and yt with half the motion of the object; only the position of the tube must be changed for every new object, and,

as was before said, must be directed to the parallel opposite to that of the object: viz to view the afternoon Sun in Cancer, it must be placed into the point of rising in Capricorn; to view the morning Sun in Capricorn, it must be directed to the point where the Sun would sett being in Cancer, and so more or less deviating from the East or West according as the object to be viewed is more or less distant from the Equator. This reflecting plate may be in a house sheltered from dews, which would be a great impediment, and it may be so moved by clockwork, that being duely placed an observer may need no assistance.

[Read December 14, 1692.]

25. *A Method of Enabling a Ship to Carry its Guns in Bad Weather.*

That the Inhabitants of an Island, or any State that would defend an Island, must be masters of the Sea, and superior in navall force to any neighbour that shall think fitt to attack it, is what I suppose needs no argument to enforce. But how this navall force may be managed, so as to be alwais in a condition to offend, or at least to defend against a vigilant enemy, is a matter that seems to require a more than ordinary concern, especially since we see that according to the present practise the great Shippes are thought unfitting to be ventured at sea for $\frac{2}{3}$ of the year notwithstanding the prodigious charge of fitting them. I have made it my business to inform myself of the reasons why these Shippes are usually thus laid up and do find that their value in case of disaster; and the weight of their guns hanging on the naile, and therby forcing and straining the sides of those Shippes, whose guns are so weighty, are the 2 principall reasons. As to the first the situation of our ports and shore give us great advantages to keep the Sea, for against Westerly winds, the Lizard, Torbay, Weymouth Road and the inside of the Isle of Wight, alwais afford protection; and the Easterly winds almost alwais blows off our shore, so that wee are ever fenced against it; and experience shews that the S.W. and N.E. quarters do generally afford those winds that blow hard and last long, and consequently in this case ought to be considered; nor is every possible gust of a Southerly wind to be pleaded, since the Channell is so narrow that a Southern Sea can never be very high, so as to make anchoring in case of extremity unpracticable. As to the other thing, that is the wt. of the Guns straining the sides of the Shippes, I think I have found out an Expedient, that will not only remove that objection, but even contribute to fortifie and bind together the timber of them by the single application of the tackle, wherwith the Gunn is kept

in its place and which they call the Breechings. For by this contrivance the wt. of the Guns is made to draw together, and close the sides, which as is now practised opens and strains them; that is by letting the takles of the Guns be brought over to the opposite side of the Shipp after the manner of this figure.¹ And wheras it will be objected that these tacles running cross the Shipp will be an impediment and hinder the freedom of passing upp and down I propose that all these tacles be laid close upon deck so as to lie loose when the Gun they belong to lies uppermost, and when it strains laying down, the breeching being carried under a roule or through a double block will still lie close upon deck, and in this case it [is] evident that the wt. of the Guns will contribute to bind the sides of the Shipp together, and in fair weather when the shipp rouls not it will be no great trouble to remove these takles and putt them on again when there shall be occasion.

[Read April 30, 1695.]

26. *Concerning the Evacuating Water by Pressure.*²

Having lately had some occasions to examine the quantity of water which is evacuated at any overture under the surface of the cistern pressing thereon, I find it to be reduceable to the geometrical problem of finding the solid capacity of a body, whose base is the aperture of the hole, and its sides erected thereon [at] right angles and terminated with the curve surface of a parabolick cylinder, whose *latus rectum* is equal to the space which water at its first issue would describe by the velocity it hath, running out of a hole so deep as to be so long ascending, as is the time required; As for instance the *latus rectum* of the parabolick solid which shall terminate the quantity expressing the efflux; if 1" of time, is 32 foot, being the velocity water hath, when it issues out with force sufficient to ascend 16 foot, which it doth according to the Laws of Gravity on ye surface of the Earth in 1" of time: And at any other depth the velocity is to the $\sqrt{\text{of the depth}}$, as 32 to 1; whence it is easy to demonstrate that the figure terminating the said effluxes is a Parabola: And it is very easy to deduce the Rule for exhibiting the quantity of water shall flow out at a square hole in ye side of a vessel; but if it be a round hole, it is a problem of more difficulty; and for what I yet see, not to be solved but by Mr. Newton's series, the figure to be squared being what I do not find any of our Geometers have yet considered. I have solved that way, and shall if desired communicate it. Note, not only the case when the hole touches the surface of the water, but

¹ No figure found.

² Printed, with corrections, from the fair copy in the Register Book of the Royal Society.

also at any depth and diameter whatsoever: tho' I fear it may be urged that the fall of the upper water does impede the efflux of the under water so as in some sort to diminish the quantity thereof computed by this rule.

[Read May 6, 1696.]

27. *The Geography of the Ancients and Moderns.*

It would without doubt pass for a Paradox if I should affirm that the Geography of the Ancients was in any respect more exact and curious than that of the Moderns. Notwithstanding which, as far [as] the bounds of the Roman Empire reached, we may be well assured that they had accurately surveyd all the provinces of their dominions and that the Itinerary calld by the name of Antoninus, is but a part of a much larger Catalogue of the distances of Cities on the Imperiall *Strata*, or Military Roads such as our Watling Street and Fosse in England, the remains of which at this day do sufficiently prove the care taken by the Romans in this remote province about the roads for the march of their Armys; and the Numbers in the Itinerary do sufficiently agree with the survey made by Ogilbys wheel, to make us conclude that these distances were not put down by estimate, as is usuall with us, but that they were an actuall survey, and perhaps there were on the way side Miliary Colums for the information of Travellers, as it is certain there were in Italy and some other provinces. This when the Itinerary was entire gave abundant light into the true dimensions of the severall provinces and was a firm *basis* to raise the superstructure of a good Geography if they had been a little more carefull in noting the Latitudes of their places and their positions in respect of the Meridian; wherein perhaps they found some difficulty for want of the direction of the Magneticall Needle. Besides the ancients did belive the Globe to be much less than our more accurate dimensions therof have since determined it, so that wheras Ptolomy reckoned 500 Stadia or $62\frac{1}{2}$ Italian miles to a degree wee are now assured that 76 such miles or 608 Stadia without any deflection, do subtend a degree: so many Italian miles being equall to $69\frac{1}{3}$ English, which Mr. Norwood's and Mr. Picart's surveys do agree in by a wonderfull concurrence. Whence it comes to pass that all the differences in Longit. or Latitude derived from the Itinerary distances are about $\frac{1}{6}$ part to great, and considering the deflection and inequality of the ways perhaps 80 or more miles may be allowed to a degree. By the way when I was at Rome I measured the Roman and Greek foot at the Campidolio and compared them with the London foot and found the Roman foot $\frac{4}{10}$ of an Inch less

than the London, and the Greek $\frac{1}{20}$ of an Inch more, whence it is observable that the Roman foot to the Greek is very near in the proportion of 24 to 25; whence it follows that 8 Greek Stadia of 600 foot each was the same measure as the Mille passus or 5000 foot of the Romans, who made their mile the Octastadion of the Greeks, as I suppose exactly so. This being presumed I think the measures left us by the Ancients will be very sufficient to shew the great errors committed by most of our Modern Geographers in making the length of the Mediterranean, for an instance, near a quarter part too long, and the Lesser Asia and Greece near double what it ought to be in breadth. But I shall only insist upon the length of the Straites, which I see some very late Authors have permitted to pass uncorrected.

Pliny with whom the Itinerary agrees reckons 360 miles from Rome to Brundizium that is $4\frac{1}{2}$ degrees of a great circle, which in that Latitude gives $5\frac{3}{4}$ of Longitude, and $1\frac{1}{4}$ is sufficient to answer for the distance of Appollonia or Valona on the Coast of Epirus: from Appollonia Pliny measures agreable to Strabo the distance to Byzantium or Constantinople *recta in Orientem* 711 miles, on which road Strabo sais expresly the miliary colums were all along erected, it being called Via Egnatia. These 711 miles are about $8\frac{3}{4}$ of a great circle and in the Latitude of 41 do make $11\frac{1}{2}$ of Longitude, whence Constantinople will not be above $18\frac{1}{2}$ or perhaps but 18 degrees from Rome, to the Eastwards. And by the Itinerary we are assured that it was from Constantinople to Antioch 726 miles or 685 miles to Alexandria, now Scanderoon, in the extream sinus of the Mediterranean, that is $8\frac{1}{2}$ degrees of a great circle, and the difference of Latitudes being about 5 degrees, it follows that the difference of Longitude cannot be greater than $8\frac{3}{4}$, whence Alexandria will be from Rome not more than 27 degrees; that is 40 from London, as we are informed by observations of Jupiters Satelites made at Rome and London. And that this measure is very near the truth I am assured from some celestiall observations made at Aleppo, but not with all the accuracy desired, as we hope we may have it in a very short time.

[Read March 19, 1700/1.]

28.¹ *Certificate concerning Sign' Alberghetti's Tables for shooting Bombs*

I have well considered ye tables of Sr. Alberghetti intended for shooting bombs out of a Long Gunn, & being but for ten degrees of Elevation and under cannot well be applicable to anyother but battery; He concludes that a cannon wch he calls Cannone di ducento carries

¹ These two items are both 'fair copies' of Halley's 'Certificates'.

its ball with such velocity yt while it flies 200 paces or 1000 foot, it falls below ye line of direction $1\frac{3}{4}$ paces or nearly 9 foot, wch shews yt the time is about $\frac{3}{4}$ of a second yt ye Ball is flying that space, which yet ye Author takes to be nearly a second of time. On ys principle vizt: yt ye fall of ye ball is $1\frac{3}{4}$: paces fallen below ye line of direction while it flies 200 paces, verrified, as he asserts, by sufficient experiment, are these tables founded, and calculated according to the Theory of Galileo with an exactness and curiosity beyond what ye gross practise of our present Canoniers seemes to require, who loose all the Geometricall accuracy of their art from ye unfitnes of ye boare to ye ball, & ye uncertain reverse of ye Gunn, which is indeed verry hard to overcome, but without it, it will not be so easy to batter at great distances as Sr. Alberghetti supposes. Yet may these tables be of good use for battery, where the works to be battered are considerably above ye levell and not verry farr beyond ye point blank of the piece. Besides the theory of Galileo allowing no opposition to ye ball from ye Air is insufficient in great distances.

Edmd: Halley

I have by order of ye Royall Society well considered the specimen of the tables of Sigr. Alberghetti designed for the shooting of Bombs out of Long Gunns. I find the Author in all things to follow the Doctrine of projections laid down by Galileo, Torricelli & others & yt he has performed his calculations with more than ordinary exactness: but ye chief design seems to be, to enable the Canoniers to strike any object above or below the Levell without any previous Geometricall working, wherein it would be very easy to commit Errors. It is not to be doubted but ye said Tables when finished may be of great use for the purposes entended, and may be very serviceable in battering with Cannon at a much greater distance then is thought possible by the generallity of Practicall Gunners without any more trouble then the bare Inspection of these Tables.

Edmond Halley

Gresham Coll: London

Martii 19/30: 1701.

[Read February 22, 1721/2.]

29. *Of protecting the drum of the ear under water. . . .*

Some years since I printed in the *Transactions* a paper concerning what I had discovered in the art of subsisting under water, and how to furnish Air at any depth and in any quantity required, and besides I related a constant effect of the pressure of the condensed Air upon the outward passage of the Ear, which was felt by all

persons that went down in the diving engine, not without pain; till such time as a valve (as I conceive) that is placed near the Drumm of the Ear being forced by the great pressure of the externall medium, gave way and slippd up; wherby the Air in the Cavity within the bony caverns of ye Ear immediately became of the same density & elasticity with the externall, whence present Ease ensued: But the pain and all other circonstances were renewed upon descending deeper according as the externall Air grew more dense and elastick than that that filld the aforesaid cavity: The constancy of this effect made me conclude that there was a valve obstructing the entrance of any thing into the cavity of ye Ear from without; and I was assured at the same time that there was no such passage as some have supposed, wherby the outward Air may communicate with that included in the Ears by the Mouth, which if I mistake not they call the Eustachian Tube, for had there been such a passage the pain must necessarily have been felt at both entrances or at neither. As I am no Anatomist I was very unwilling in my aforesd account to venter out of my depth, and therefore proposed nothing but bare and indisputable matter of fact. However as a Gentleman of this Society, to whom I must own I have some obligations, has been pleased, in his late description of the Ear, to lay the whole of this fact to the score of my veracity, as a thing he can no other wais account for, I thought it would not be improper for me to appeal to the severall very eminent Anatomists, which are so usefull and instructive a part of this Society, whether such a valve be not alwais to be found in the Humane Ear, and perhaps in the Ears of all other animalls. Particularly I recommend it to tryall whether the cavity of the Ear being turned with the Drum downwards, and filld with water, will not readily let the water pass out at a pore, which is closed against an externall pressure by the valve I have supposed. Indeed I cannot doubt but it will be found to be so, considering how easily the condensed air in this cavity is found to slipp out at the said pore, when the diving Bell is drawn up again, wherby the great Elasticity therof gradually abates, and restores itself to the naturall tension of the ambient medium without the least inconvenience to the Diver.

[Undated.]

30. *A Prism to transmitt only the Red Light. . . .*

The Excellent Mr Newton in his theory of Light publishd No. 80 of the *Transactions* has proved and putt past dispute that Colours in Nature [?] and bodies are no other than dispositions of those bodies

to reflect different sorts of Light, and that the beams of Light are really different in their refraction according to their colours; viz that a Red light has in the passage of ye same body a very considerably less refraction than a blew light; whence there occurred to me the following proposition, that a prism might be made of such an angle as to transmit only the Red light and exclude the blew. For if ABC be the prism¹ and the substance therof be so constituted as that the sines of Incidence and Refraction be as AB to BD, then shall the prism BAC cease to be transparent; but if the Refraction of the Body be less or the Angle less, then it shall appear with a Colour Image as in the ordinary glass prism: now if there be such a difference of the refractions of Rays as Mr Newton asserts, the Red light being less refrangible may pass that prism which is not transparent to the white or blew light, and if such a prism can be made wherein there shall appear no other colour but red, it may be a good confirmation of Mr Newtons theory, and perhaps serve to shew how the surfaces of some bodys may produce their colours from the position and refrangibility of the transparent attoms that compose their surface. If it please that this experiment be shewn before the Society I will procure a prism so cutt as to transmit the beams of the sun, with only a Red light.

¹ No Figure found.

VI
APPENDIX

HALLEIANA I—XXI

I. Halley's Ancestry, by Ralph J. Beavor, M.A.	173
II. Extracts from India Office Records, 1676-8	179
III. Extracts from Robert Hooke's MS. Diaries	182
IV. Selected Letters from the Correspondence of Hevelius, Newton, and others	187
V. Halley's Latin Hexameters	203
VI. English Versification of the Hexameters	207
VII. Presentation of the <i>Principia</i> to King James II	209
VIII. Extracts from the Royal Society's Journal Books, 1688-96	210
IX. Extracts from the Royal Society's Council Minutes, 1688-99	239
X. Halley at the Mint at Chester	241
XI. The Admiralty's Instructions to Halley, in 1698	243
XII. Halley's Two Voyages, 1698-1700	244
XIII. Halley's Two Missions to Vienna, 1702/3	248
XIV. An Account of Halley's Inaugural Address, as Savilian Professor of Geometry, at Oxford, in 1704	251
XV. Origin of the Royal Society Club	252
XVI. Halley's Will, with Comments	255
XVII. Inscriptions on Halley's Tomb, in the Churchyard at Lee	258
XVIII. Halley's Character and Personality	261
XIX. List of Halley's Published Writings	272
XX. Grouped References for Halley's Life and Work	279
XXI. Key to Sources of Original Material	288

Several sections of this Appendix of Halleiana have never appeared in print. Of these the most important consist of the extracts from Hooke's MS. Diaries, and from the Royal Society's Journal Books and Council Minutes.

A number of the appendixes, as explained in the Preface,¹ are reprinted from old or rare works, not easily accessible. It has seemed proper to incorporate them in the present collection, owing to the absence of any comprehensive biography of Halley.

¹ See p. vii.

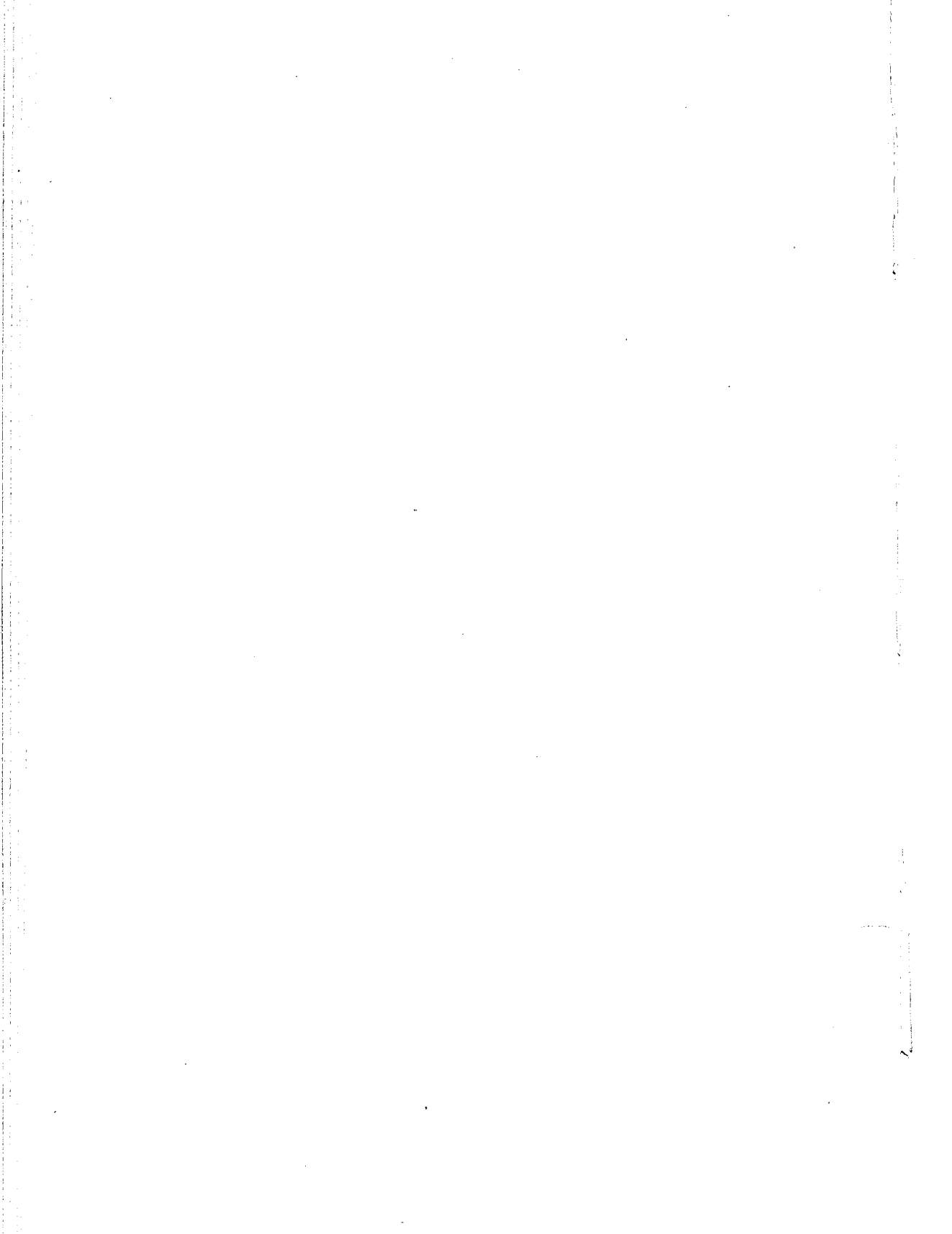

APPENDIX I

HALLEY'S ANCESTRY¹

By RALPH J. BEEVOR, M.A.

JOHN AUBREY states that Edmond Halley, the second Astronomer Royal, belonged to the 'Halleys of Derbyshire—a good family'.² The standards by which the goodness of a family is judged differ from those which are applied to an individual and have no reference to the Decalogue, the copy-book, or any other accepted code of morality. The right to bear arms³ or at least the possession of a gig or addiction to the practice of eating red currant jelly with his mutton is an essential condition precedent if a man is to claim that he is of 'good family'. We are without proof that the Derbyshire Halleys⁴ satisfied any of these conditions. The father of Edmond Halley was at one time a prosperous soap-boiler in the city of London.⁵ His grandfather, Humphrey Halley,⁶ was a haberdasher in Lombard Street and at a later date a vintner in or near Eastcheap. There, as far as our present knowledge goes, the Halley pedigree culminates. We lack proof of the connexion with the county of Derbyshire⁷ and the blue-blooded Halleys of that county are still to seek. There was living, however, at Youlgreave, near Bakewell, in the spacious days of Elizabeth, a yeoman bearing the name of Humphrey Halley⁸ who, as the parish records testify, was blessed with five sons. In the absence of other claimants, it may be conjectured that one of these sons was father of Humphrey Halley, vintner. None of the sons appears to have raised himself to the position of a possessor of acres. If a choice is to be made among these somewhat shadowy claimants to the honour of having been

¹ All the notes to this essay (with one exception) have been added by the present editor, the greater part of whose material on the genealogy of the Halley family is due to Mr. Beevor's generous collaboration extending over many years. See *The Genealogist*, new series, vol. xxv, p. 14, London, 1908.

² Aubrey, John: *Brief Lives*, ed. Clark, vol. i, p. 282; Oxford, 1898. Aubrey gives the coat, in colours: 'Sable, a fret and a canton argent' (*Ibid.*). Cf. *Notes and Queries*, vols clvi, p. 370, 1929.

³ Halley is described as 'armiger', in a passport from Queen Anne, dated 6 Nov. 1702.

⁴ 'There was a family called Halley of considerable note in the Forest' (i.e. King's Forest of the High Peak, Derbyshire), dating from the time of Edward I. See *The Reliquary*, vol. viii, p. 44; cf. *Notes and Queries*, 11th series, vol. vi, p. 497, 1912, and vol. vii, p. 203, 1913.

⁵ *The Genealogist*, new series, vol. xxv, p. 8, London, 1908.

⁶ *Ibid.*, vol. xxv, p. 6, 1908.

⁷ *Notes and Queries*, 11th series, vol. vi, p. 497, 1912; vol. vii, p. 203, 1913; and vol. clii, p. 389, 1927. Flamsteed began, in 1696, a correspondence with a Mr. Luke Leigh, of Derbyshire (? Bakewell), who was a kinsman of Halley; see Bailly, Francis: 'Account of John Flamsteed', p. 63; London, 1835.

⁸ From extracts supplied by Mr. Arthur Carrington, of the Downes, Bidford, N. Devon, quoted in *Notes and Queries*, 11th series, vol. iv, p. 466, 1911. Photostat copies are in the library of the Society of Genealogists, London. Mr. Beevor, also, made similar extracts at Youlgreave, in 1910.

great-grandfather of the astronomer, there are reasons for giving preference to the youngest of them, Francis. But it must be admitted that the only positive statement which can be made about this Francis Halley is that he was baptized in the parish church of Youlgreave on the 10th November, 1569.¹ Perhaps he is identical with Francis Halley who, in the year 1605, was fined 6*d.* for fishing without license in the waters of the Lord of the Manor of Bakewell.² Even members of a good family have been known to yield to the temptations of unlicensed angling.

John Flamsteed, the first Astronomer Royal, was a native of Derbyshire, having been born at Denby, near Derby, on the 19th August, 1646. There is no reason to doubt that his successor also came of a Derbyshire stock. But further patient investigation is needed before the fact is established beyond controversy. For the present, we must be content to commence the Halley family history with Humphrey Halley,³ the astronomer's grandfather, with whom we first make acquaintance on the 24th day of November, 1617, at the parish church of Barking, Essex, where he was allied to one Katherine Mewce.⁴ The lady, at any rate, was of good family, in the conventional sense, as we find her name and mention of her marriage in the pedigree of Mewce of Holdenby, recorded in the *Visitation of Northamptonshire*.⁵ It is not known where the first few years of their married life were spent. In the early part of 1627, they were living in Lombard Street, London, and five of their children were baptized at All Hallows Church⁶ hard by. In the record of baptism of the first two of these children, the father is described as a haberdasher. From the books of the Fishmongers' Company, it appears that, in January, 1631, he was living in a house in Lombard Street, called the 'Unicorn' and belonging to that Company. He was then described as a vintner. But he cannot, at that time, have entirely relinquished his interest in the haberdashery business. There are records, some ten years later, of a Chancery suit between Humphrey Halley and one Thomas Dent of York. Humphrey Halley seems to have been in partnership with Henry Dent, brother of Thomas, and an outstanding account relating to 'thirty felt hats and eleaven demy castors'⁷ was the subject of prolonged litigation.

In the State Papers, Domestic Series, is a receipt for 7*s.* 6*d.* paid by Humphrey Halley, on behalf of John Abbott, the Mayor of Huntingdon, a portion of the ship-money charged on the town of Huntingdon, by writ of the 12th August,

¹ See note 8 on previous page.

² Extracts from *Bakewell Charters*, supplied by Mr. William Boulsover, of Ferndale, Bakewell, Derbyshire.

³ *The Genealogist*, new series, vol. xxv, p. 6, 1908-9.

⁴ *Notes and Queries*, 11th series, vol. ii, p. 44, 1910; vol. clii, p. 389, 1927.

⁵ Metcalfe, W. C. ed.: *Visitations of Northampton, 1564, 1618-19*, p. 114, 1887.

⁶ *Magazine of History*, vol. xiii, p. 192, New York, 1911.

⁷ If an explanation of the term 'demy-castors' is needed, it will be found in a proclamation of King Charles I, issued from Whitehall, 26 May 1639, touching the Corporation of Bever Makers of London and to restrain the importing of 'forrain Hats and the wearing of Demy Casters within his Majestie's Dominions'. Pure Beaver is to be used in hat-making—mixed fur is to be seized. Demy Casters (where beaver is mixed with other material) are not to be made, sold, or after one year worn by any subjects on pain, etc. The Company may make them for export. [R. J. B.]

1636. As Huntingdon lies on the high-road from York to London, we may surmise that the good offices of the worthy haberdasher, on his homeward way, after a successful deal in 'demy castors', were employed to transmit a portion of the hated impost from the strongbox of the Mayor of Huntingdon to His Majesty's coffers. In the year 1639, we find Humphrey Halley in the parish of St. Clement's, Eastcheap. He was churchwarden of the parish from Easter, 1639, to Easter, 1642. His place of residence would appear to have been in the immediate vicinity of the church. For, at a Vestry held September, 1641, it was resolved that 'Mr. Halley, churchwarden, having severed and finished the way made by the Southside of the Church into St. Clement's Lane . . . and in regard he held the churchwarden's place at their request one year extraordinary . . . they were well pleased that he enjoy the way as aforesaid . . . paying xiid a year'. In 1641, he was one of those who took the protestation according to the ordinance of Parliament 5th May, 1641. On the 8th October, 1643, he signs the Solemn League and Covenant. He appears to have prospered. For in a list of the names of 'such of the parish of St. Clement's, Eastcheap, as have sent money to the Parliament, upon an order from the Lord Mayor, for the lone of thirty thousand pounds, being dated the 26th November, 1642', we find the substantial sum of £25 against his name. John Pearson, afterwards Bishop of Chester, author of the 'Exposition of the Creed', was lecturer at St. Clement's and Humphrey Halley was one of the 'right worshipful and well-beloved, the parishoners of St. Clement's, Eastcheap', to whom that work was dedicated. He was present at a Vestry meeting on 30th March, 1665. After that date the records of Eastcheap know him no more. We may conjecture that in this, the year of the Great Plague, he left the city and retired to Alconbury, in the county of Huntingdon. His daughter, Elizabeth, had married John Cawthorne of that place. At Alconbury, Humphrey and Katherine may be presumed to have celebrated their golden wedding. Katherine was buried there, on the 12th September, 1668,¹ whilst Humphrey was buried at St. Margaret's, the parish church of Barking, on the 16th October, 1672. The registers of the latter, under this date, give both as buried there. It is therefore conjectured that the remains of Katherine were removed from Alconbury to Barking, to be re-interred with those of her husband, in accordance with a wish possibly expressed by him; but there is nothing on record at Alconbury or at Barking to confirm this view. From Humphrey Halley's will, preserved at Somerset House, it appears that he had three surviving sons, Humphrey, William, and Edmond.² Humphrey died unmarried, at Alconbury, in 1676.³ He bequeathed £100 a piece to his nephews, Edmond and Humphrey. Nor were his other relations neglected, since he adds the quaint provision of '1/- a piece to the rest of my neer relations (not in this my will named), to be paid to him, her or them when he, she or they, each, every or any of them shall come and demand the same of my executors and not before'. The astronomer is sometimes said to have been an only child. But here we have evidence of the existence of a brother. This brother Humphrey died abroad, in 1684,

¹ *The Genealogist*, new series, vol. xxv, p. 6, 1908-9.

² *Ibid.*, p. 7.

³ *Ibid.*, p. 6.

when administration of his personal estate was granted to his brother Edmond.¹

If little is known of the life history of the elder Hūmphrey Halley, the information we possess about his son, Edmond, the astronomer's father, is still more meagre. He was, at one time, a prosperous soap-boiler in Winchester Street. But losses, caused partly by the Great Fire of London and in part by an imprudent second marriage, impaired his fortune.² Of his first wife, the astronomer's mother, we know nothing save that her name was Anne Robinson, that she was married 9th September, 1656,³ at St. Margaret's, Westminster, and that she was buried, at Barking, on the 24th October, 1672.⁴ Nearly twelve years later, on the 22nd April, 1684, Edmond Halley, the elder, was laid by her side.⁵ We have scanty records of his life but more abundant details about his tragic end. These are supplied by a broadside, probably unique, preserved in the Guildhall Library, which is given below *in extenso*:

A true
Discovery
of
Mr. Edmund Halley
of London
Merchant
Who was found Barbarously Murdered
at Temple-Farm, near Rochester in Kent
[17 April 1684.]⁶

Mr. Edmund Halley was a Gentleman of public Acquaintance and known Reputation through the whole City of London, and had there lived in Winchester Street for many years, and was no less esteemed for his own Merits, as a Person always forward to the Service of his King & Country, than he was respected as a Gentleman of a considerable Estate, and plentifully happy in all the Goods of Fortune. What was the Original Cause of his first withdrawing himself from his own Habitation whither any particular Business called him into the Country, or more private Discontent, Estranged him from his Relations, is not yet certainly known, but as it appears by the Gazet he went from home about the beginning of March; and could not since be heard of tho a Reward of a hundred pound was promised to any Person, who should discover him alive or dead.

Wednesday the 5th of March, at Evening, was the first time that Mr.

¹ *Notes and Queries*, 10th series, vol. vii, p. 264, 1907. There was, also, a sister, Katherine Halley, born 7 Feb. 1658; baptized 17 Feb. 1658, at St. Giles, Cripplegate, London (*Notes and Queries*, 11th series, vol. ii, p. 45), but she, no doubt, died in infancy. She was, probably, not identical with Halley's 'sister' mentioned in Geikie's *Annals of the Royal Society Club*, p. 6, London, 1917. The latter was, more likely, a sister-in-law, i.e. a sister of Mrs. Mary Halley; (cf. *Notes and Queries*, 10th series, vol. viii, pp. 221-2, p. 373; *ibid.*, vol. clvi, p. 287).

² *Biog. Brit.* (1757), vol. iv, p. 2503, note R.

³ *Notes and Queries*, 11th series, vol. xi, p. 423, 1915.

⁴ *Ibid.*, 11th series, vol. ii, p. 44, 1910.

⁵ *Ibid.*

⁶ This date is interpolated in handwriting.

Halley was missing, in the Morning he complained that his Feet were tender and his Shooes pinched him, upon which a Gentleman standing by who was his Nephew, told him, Uncle if you please I will cut the Lineing out of the Toes and that will give you ease, and accordingly did so, his Wife ask'd him if he was going out, yes says he, I'll go and walk, but I shall be back in the Evening, when Night came she accordingly expected him, but not returning she was very much concerned at it, and the next day made all possible Enquiry, but after several days not hearing of him, published his Absence in the News Book. From Wednesday the 5th of March, to the 14th of April, notwithstanding all Endeavours, and the strictest Search that could be made, they received no Account where he was, or where he had been. But on Monday last he was found by a River side at Temple-Farm in Strow'd Parish near Rochester on this manner. A poor Boy walking by the Water-side upon some Occasion spied the Body of a Man dead and Stript, with only his Shoes and Stockings on, upon which he presently made a discovery of it to some others, which coming to the knowledge of a Gentleman, who had read the Advertisement in the Gazet, he immediately came up to London, and acquainted Mrs Halley with it, withal, telling her, that what he had done, was not for the sake of the Reward, but upon Principles more Honourable and Christian, for as to the mony, he desired to make no advantage of it, but that it might be given intirely to the poor Boy; who found him and justly deserved it.

Mrs Halley who had been all along most passionately troubled at her Husbands absence receiving this Intelligence sent down the Gentleman his Nephew to view the Corps, whither it was the body of Mr. Halley or no. It was judged by all appearances to have lain some time in the River, and afterwards by the motion of the Water driven a shore; the Face was so much disfigur'd he could not be known, one of the Eyes was injured, and several parts of the Body, but by what means 'tis not yet discovered. It was concluded by all, that he had not baen in the River ever since he was missing, for if he had, his Body would have been more Corrupted. The Gentleman knew him by his Shooes and Stockings, they being the same Shooes he had cut the Lineing out of, and on one leg he had four Stockings; and on the other three and a Sear-cloath. The Coroner sat upon him, & the Inquest brought him in Murthere'd. On Wednesday Night his Body was brought to his own house in Winchester Street, from whence it will be suddenly buried.

London Printed by E. Mallet 1684

It may savour of presumption to question the verdict of the twelve good and true men of Kent who "sat upon" the unfortunate soap-boiler, but the evidence with which we are supplied appears to point to mental aberration and to suggest a verdict of suicide¹ rather than of homicide. The luckless man's affairs were left in some confusion, and litigation between Edmond Halley the younger and his step-mother followed. From the voluminous documents dealing with the proceedings which are preserved in the Record Office, we learn that the gentleman to whom the broadside alludes as having come to London to acquaint

¹ *The Genealogist*, new series, vol. xxv, pp. 143-4, 271-2, 1908-9.

Mrs. Halley with her husband's fate, was one Adams, and that, so far from declining to accept a reward, he brought an action against the widow, claiming the full sum of £100. The Cause was heard by the famous, or notorious, Judge Jeffreys, who decided that Adams must be content with the sum of £20 and that the balance of £80 should be paid to the Churchwardens or Overseers of the Parish of Strood on behalf of John Byers, the poor boy who had first made discovery of the body.¹

The cost of the funeral was £91 *os. 6d.* This included £2 1*os.*, part of the penalty for burying the deceased in linen.²

HALLEY'S ARMS³

From the original in the Bodleian Library (MS. Aubrey)

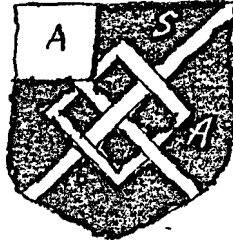

¹ Chancery Proceedings before 1714, Collins, 1694, No. 301, 2nd part: Halley *vs.* Cleator; Cf. *The Genealogical Monthly*, vol. i, No. 5, p. 108, London, 1929.

² *Ibid.* (cf. *Notes and Queries*, 11th series, vol. ii, p. 44, 1910).

³ Cf. *Notes and Queries*, vol. 156, p. 370, 1929.

APPENDIX II

EXTRACTS FROM INDIA OFFICE RECORDS (1676-78)¹

Court Book, vol. xxx, p. 58.

Extract from

A Court of Committees Holden 4th October 1676

A Lre from the King's most excellent Maty was this day DD unto the Court by Sr. Jonas Moore & read by the Governor, recommending unto the Court that Mr. Edmond Hally a Student of Queen's College in Oxford, with a friend of his might have their passage in the first ship bound for St. Helen' whether they are desirous to go & remayn for some time to make observation of the planets & starrs, for rectifying and finishing the celestial globe, being a place (he conceives) very fit and proper for that design; and that they may be received and entertained there, and have such assistance and countenance from the Compas officers as they may stand in need of. On consideration whereof had, It is ordered that Mr. Hally with his friend doe take their passage for St. Helena on the *Unity*² with their necessary provisions free of charge; and that a lre be written to the Governor & Council of the said Island to acomodate them with convenient lodging during their stay there, & afford them such assistance and countenance as may be for their encouragemt. to proceed in so useful an undertaking.

Extracts from East India Company's 'Court Minutes', 6 October 1676

It is ordered, that it be referred to the Comtees. for shipping to give directions for the accomodation of Mr. Edmo. Hally and his friend on board the *Unity* in order to the transportation of themselves and their necessaries for St. Helena, and that they be treated in their passage with all civilitie.

Mr. Edm. Hally
for St. Helena.

Letter Book, vol. 5 (1672-8)

*Extract from letter to the Governor and Council at St. Helena, dated
27th October 1676*

His Matie. haveing been pleased to recommend unto us, That Mr. Edwd. [sic. Edmd.] Halley, a Student of Queens Colledge in Oxford might with a friend of his have their passage for our Island St. Helena whither they are desirous to goe & remaine for about two years to make observation of the Plannets & Starrs for rectifying & finishing the Cælestiall Globe, being a place he conceives proper

¹ Reprinted here from my communication to *The Observatory*, vol. li, pp. 286-9, 1928. These extracts were generously supplied by Mr. W. T. Ottewill, Superintendent of Records, India Office, London, in 1928. Mr. Ottewill's notes are identified by his initials in brackets.

² The *Unity* is owned by Mr. Lethioulter, and commanded by Capt. William Cruft. There was a gap in the 'Consultations' from July 1676 to 1682, and the log of the *Unity* has disappeared. [W. T. O.]

for that design; Wee have thereupon ordered their passage on the Unity free of Charge, and doe order & direct that you accomodate them with convenient lodging in the howse of the Governor or his Deputy or in some other fitt & convenient habitation dureing their stay, & to afford them such assistance and countenance as may be for their encouragement to proceed in so usefull an undertaking, They being to provide diet at their own charge, Wee also recomend it to our Comandrs. to assist Mr. Halley upon his request in what they can for his furtherance in making his observations, And wee doe order That when Mr. Halley & his freind shall desire to return back for England; That you recommend him to some of our Comanders that are bound from our Island homewards, and in the mean time, while he shall inhabit with you to use him with all respect & kindenes.

Extract from Court Minutes, 20 February, 1677-8

On reading a report from the Comtees. for Shipping touching C. Gregory Field, Governor of St. Helena, (which follows in hec verba):

We having perused the lres from St. Helena, find there are several complaints touching the ill-living of C. Gregory Field yor. present Govr. there, & find yt his continuance on the Island will prove much to the Compas. prejudice, & for ought we can discern by the several advices from thence, the differences are so great that it may tend to the prejudice of the prosperity of the Island, Therefore doe offer it to the Court as altogether necessary, that said C. Field be removed from thence, & yt they will direct another Governor to be sent over by Ship Johannah, who may be of sober life & conversation and fit to take the governmt. of the said Island.

Math: Andrewes Rob: Thomson Sam. Moyer.

It is ordered that he be removed from the said employment, & that he take his passage on the first shipping that shall touch there after ye Johannah's arrival.

The Court receiving a good character of the integrity valour & prudence of Major John Blackmore,¹ were pleased to select him to be Governor of their Island St. Helena at the salary of 100*£* per annum to comence at his departure from Gravesend; & for his encouragemt. did order that 100*£* be given him for fitting himself with necessary accommodations for that employment, & also 25*£* for fresh provisions for himself, Wife, & such of his family as he shall take with him.

Halley's 'freind' appears to have been the Mr. Clerke referred to in *Court Minutes* of 21st August, 1678:

'On reading a Report from the Comttes for Shipping, touching Mr Edmo Halley & Mr. Clerke; the Court being satisfied by Certificates of their civil demeanor during their being on the Island of St Helena, & in the passage home, doe think fit to direct that the Ownrs and Commander of the *Golden Fleece*²

¹ Commission dated 20 February, 1677/8. [W. T. O.]

² Capt. John North. [W. T. O.]

be desired to deliver up the bond of 20*l* that was taken for their transportation; and this Court will accompt with them for their passage, according to Chraparty'

The date of Halley's return to England given in *The Dictionary of National Biography*¹ as October 1678 appears to be wrong. On the 15th July, 1678 the Court gave orders that the *Golden Fleece* should be surveyed with a view to being fitted out for another voyage and on 26th July a petition from Halley (presumably in connexion with the Bond) was referred to the Committee for Shipping.

¹ *Dict. Nat. Biog.*, vol. xxiv, p. 104. According to Birch (iii. 409), Halley returned into England shortly before 30 May 1678, and this date is confirmed by Hooke's MS. Diary; see Appendix III under date 30 May 1678.

APPENDIX III
EXTRACTS FROM THE UNPRINTED MS. DIARIES
OF ROBERT HOOKE

Richard Waller, in his *Life of Hooke*, mentions the latter's 'small pocket diary',¹ which has not, as yet, been found.

Fortunately, however, there are two MS. Diaries of Hooke in existence. One, a folio, covering the period 1671-82, is in the Guildhall Library, London. Another, which is a part of a continuation, is in the British Museum. The latter diary is 'a small oblong volume, made up with about one hundred leaves closely written on both sides. Each leaf has been mounted on a guard, and the whole bound in one volume. Examination of it revealed a lack of continuity. The leaves have been badly arranged, and are mostly out of order. This is, in part, due to the fact that Hooke often quoted the day only in some cases, and gave the date (day of the month) in others, whilst the year is only given at the commencement of each. This diary is entered in the *Index to the Sloane MSS. at the British Museum* as:

Petiver, James, F.R.S. Diary, 1688-1692/3 . . . 4024.

'James Petiver (Apothecary to the Charterhouse) was an eminent botanist and naturalist. He was noted for his collections of plants, etc., and, also, possessed many MSS. Sir Hans Sloane purchased his collections. Petiver, although many years younger, was on friendly terms with Hooke, and it seems very possible that when the latter died and his effects were disposed of by public auction, Petiver may then have acquired this portion of his Diary. The Diary at the Guildhall did not reach the sale, as it was then in the hands of one of Hooke's nieces, who gave it to Richard Waller, in 1708, three years after he had written his 'Life' of Hooke. The Diary at the British Museum is, undoubtedly, in Hooke's handwriting and many of its references give ample proof of its authorship. Apparently, the Diary reached the British Museum along with many MSS. of Petiver.

'The Diary commences on November 1, 1688 and runs on until March 9, 1690, and begins again at December 6, 1692 and ends at August 8, 1693. All entries for about two and one-half years (1690-92) are missing. This is very unfortunate, as that period was of special importance for our purpose, owing to Halley's occupation with his diving experiments and other interests at that time.'

The foregoing information was supplied by Mr. H. W. Robinson, Assistant Librarian of the Royal Society, who made a careful examination of the two diaries, by the aid of a reading glass. The entries are often in an extremely

¹ Waller, Richard: *Posthumous Works of Robert Hooke*, London, 1705; (see *Life of Hooke*, p. i).

small hand, the lines being placed very close together. Hooke's mode of writing, spelling, and punctuating was very peculiar, and often, as we should say, careless and incorrect. This, added to his many conventional abbreviations, often renders the entries quite indecipherable. The spelling and abbreviations have been retained as far as possible. Mr. Robinson extracted all the references to Halley. The entries before 1683 are, of course, from the earlier Diary in the Guildhall Library, while the later ones are from the 'continuation' in the British Museum. All in all, they furnish much interesting information concerning Halley's activities during these periods.

Extracts from the MS. Diaries of Robert Hooke.

S[unday, Feb. 17, 1677/8.] missed Sr. J. More at Tower. found him here. wth Journalls. Hallys letter. . . . Transcribed Hally.¹
 Th[ursday, May 30, 1678.] Councill 15 present. nought done. Mackenzie at ye Society. Hally from St. Hellena². wth Sr. J. More & Colwall at toothes.³
 Mun[day, June 10, 1678.] Lent Hally De la Hire's sheet.
 Fryday, [Oct. 25, 1678.] Shewd hally my Eclipse—he his to me.
 Thursday, [Oct. 31, 1678.] Hally gave me his hemisphere & booke.⁴
 Fryday, November the 1st. At Jonathans. Dr. Gale. Dr. Mapletoft. Hally. &c.

[Similar references to Halley being 'at Jonathans' occur two or three times each week during January, February, and March, 1679, and twice in the month of April. After April 25 no further reference to Halley is found until August 14 quoted below.]

Thurs[day, Aug. 14, 1679.] Here were in Repository Colwall. Hill. Hally returnd this day from Dantzick (Hevelius Rods in pickle)⁵ Flamsteed.

[Hooke records Halley's attendance 'at Jonathans' on several occasions during August and September 1679, after which there is no further reference to Halley until April 1680, when he visited Jonathans on April 1 and 15.]

W[ed. May 16, 1680.] At Jonathans. Spake to Hally for Dr. Pope. He told me Flamsteed endeavoured to supplant Dr. Pope and to get an interest for himself.

Tues. [Aug. 31, 1680.] at Hallys saw Streat's instrument reflecting.

¹ This probably refers to the letter from Halley to Moore, dated St. Helena, 22 Nov. 1677 (see p. 39-41). As about three months were then required for a voyage from St. Helena to England, it is evident that Sir Jonas Moore had only just received the letter at the time of Hooke's entry quoted above (cf. Birch, iii. 385, 387). ² Birch, iii. 409.

³ 'Toothes' and 'Jonathans' were either taverns or coffee-houses.

⁴ At a meeting of the Royal Society, 7 Nov. 1678, 'Mr. Hooke shewed the planisphere and description of the stars of the southern hemisphere made by Mr. Halley' (Birch, iii. 434).

⁵ Hooke refers, here, no doubt, to his own controversy with Hevelius, concerning the comparative merits of telescopic sights and plain sights. Hooke's account of that dispute, to settle which Halley went to Danzig, is given in Waller, R.: *Posthumous Works of Robert Hooke*, 1705 (see *Life of Hooke*, pp. xv-xix).

- Mu[n. Sept. 13, 1680.] named Hally for Aural examination.¹
 Th[ursd. Dec. 2, 1680.] Hally to Paris.²
 Wed. June 1, [1681.] Letter from Hally.³
 24 [Jan. 1682.] Mr. Hally from States.⁴
 31 [Jan. 1682.] Paid Hally 20sh. for Dr. Pope.
 March 10, 1682. Coming in ye evening from Jonathans wth Mr. Hally he asked me whether one might not use ye other eye to see the species of ye sun when one eye looks through a tube on the horizon. I told him that I had neer 20 years since shew'd ye Society such an Instrument to tri it wth the same eye which he thought not possible and that was mentioned in the Hist. of R.S.
 Tues. May 23, 1682. Hally married.⁵
 Tu. 27. [November 1688.] Hally here of Sr. J. Hosk[ins] Mr Hensh[aw] of leaving ye Soc[tiety]: of my ingaging for ye Sec: & Curator.
 Mun. 3. [December 1688.] fitted Lead funnell at Hallys.
 W. 9. [January 1688/9.] at ye meeting of R.S. Hally read Mr Boyle's Acct. of Expts of Fire.
 Tu. 22. [ditto.] At Jon. Hally much concerned for the . . . at Ld. Essex.
 W. [23.] [ditto.] at Jon. Pit[feild] Hally. A. Bristow . . . Hally at 9½ whilst I spoke of Flam[steed.] I talked with him about my Collections.
 Mu. 4. [February 1688/9.] with Hally to Caillous[?].
 Ash Wensday 13 [ditto.] R S met . . . Hally a paper of Infinites.
 Fr. 15. [ditto.] At Hallys met Newton—vainly pretended claim yet acknowledged my information. Interest has noe conscience. a posse ad esse non valet Consequentia.
 W. 20. [ditto.] R S. Hosk[ins] ascribed differ. pendul. to More and Hally falsely.
 M 4. [March 1688/9.] borrowd Speidell's book of Hally.
 Wens 6. [ditto.] Hally tea . . . R S met . . . Hally read a paper of Walking under Water. the same wth what I shewed ye Society 25 years since. Hoskins edged me as he does every time.
 Tu. 19. [ditto.] Hally here.
 Fry 22. [ditto.] Hally a sayling.
 We. 3. [April 1689.] Hally Returnd.
 W. 17. [ditto.] Waller & Hally here.

¹ The reference may mean that Hooke suggested Halley as an Examiner at the Mathematical School of Christ's Hospital.

² See p. 4, giving 1 Dec. 1680 as the date of Halley's departure from London, for the Continent. John Aubrey also gives 1 Dec. 1680 (*Brief Lives*, ed. Clark, vol. i, p. 283, Oxford, 1898).

³ See pp. 49–52, for this letter, dated: 'Saumeur, May 19/29, 1681'.

⁴ 'States' here undoubtedly means Holland. This indicates, that Halley returned from Paris by the way of Holland. Aubrey records the same date of the return into England, 24 Jan. 1682 (*Brief Lives*, vol. i, p. 283) and adds: 'He hath contracted an acquaintance and friendship with all the eminent mathematicians of France and Italie' (*ibid.*).

⁵ This entry, probably, means only that Hooke then first learned of Halley's marriage. The printed *Register of Marriages at St. James's, Duke's Place, Without Aldgate*, p. 246 (London, Phillimore & Co., 1900), contains this entry: '1682, April 20. Edmond Hailey, b. & Mary Tuke, s., Thomas Crosse' (cf. *Notes and Queries*, 11th series, vol. iv, pp. 85, 198, 1911).

- Wens 15. [May 1689.] Read Cutler letter to ye R S. present Henshaw Hill Hally Lodwick Waller . . . Shewd Hally his mistake about penetration of Salt & Δ.
- Wens. 12. [June 1689.] R S met . . . Hally arguing against change of Polarity.
- W. [19] [ditto.] Hill & Hally in the Gallery . . . at Jon. . . . Hally shewd me Leipsick Acta. feb. 89.
- Tu 20. [August 1689.] Lod[wick] here at Hallys . . . from Hally Journ. of 1686 & Minutes of 87, 88 & 89.
- Th. 19. [September 1689.] *Lent Mr. Hally my wooden quadrant.* 2 foot radius.
- Fry 20. [ditto.] At Jon. Hally Gof. Lod. Lingar Paulet. met and adjourned to Oct. 19 next.
- Sat 21. [ditto.] Hally returnd quadrant.
- We: 25. [ditto.] at Jon. . . . stay there with Lod till Hally. C. Wych. Hill came to whom I shewd my book. Wych invited Hally.
- Th. [26] [ditto.] at Jon. . . . Mr. Hally desird to see my 4 foot telescope which I shewd him. he took back his two Journall Bookes.
- Wen: 16. [October 1689.] R Society met . . . Hally read his observation on Guilded Silver Wire . . . at Jon. Hally spake to me to undertake his place.
- Wens. 30. [ditto.] at Jon. Observator. Hally Pit . . . R Soc met. Hally paper about Salts.
- Wens 27. [November 1689.] Hally here his Cousin¹ in the parlor . . . at Jon. Lod. Gof. Hally . . . Hally told of Resigning.²
- S. 8. [December 1689.] with Hally at Dr. Slones. saw his Map of the S Sea. NB. the new Islands under ye aequinoctiall.
- M. 23. [ditto.] Hally & Pit. here about Grillet . . . at Jon. Dr. Shandy Hally Grillet. meeting appointed. fryd. Jan. 3. 10 morn.
- Wens 22. [January 1690.] R S. Hally of Caesars Landing.
- Mu 3. February 1690. at Jon. Hain Hally Waller. all Running to Discord.
- Tuesd. 4. [ditto.] at Jon. Hains. Hally pretended to the glasse sights of sea quadrant. though it was printed in Hist. of R S before he went to School. Cap. Knox of Sea Instrumt. without Horizon.
- [The leaves of this Diary for over two and a half years are missing.]
- Wen. 7. [December 1692.] A Councell of R.S. Hosk[ins] & Hill. Shuffled of plot & Mr. Waller & made Hally to be Secretary. None els sayd anything. Soe Councell brak up. nothing done . . . R S met . . . Hally spake of a Way of his to solve ye moons motions: being an improvemt of Horrox: . . .
- Sat 10. [December 1692.] The shortest Day. Hally & Colson observed the occultation of the Pleiades by the moon at 5 pp.

¹ This reference to Halley's 'cousin' may mean his kinsman, Luke Leigh, who made observations, in Derbyshire, for Flamsteed, circa 1696. Cf. Baily, Francis: *Account of Flamsteed* (1835), pp. 63, 64, 236. Halley had a first cousin, Francis Halley, sen., born circa January 1673.

² Halley's 'resigning' refers, no doubt, to a temporary surrender of his Fellowship. At a meeting of the Council of the Royal Society, 27 January 1685/6, according to Birch (iv. 453), a rule was proposed, that the Clerk, if a Fellow, should resign his Fellowship. In these present extracts is an entry by Hooke, 11 Jan. 1692/3, 'Hally S.R.S.', which, certainly, means that Halley had been reinstated as a Fellow.

- Wen. 14. [December 1692.] at Jon. Gof. & Lod. I read my account of Burnet's Archaeologia to chap. 9. Well accepted. Corrected Hallys mistake of. . . . Hallys way to layh guns absurd.
- Satur. 17. [ditto.] at Jon. . . . I gave Hally table of Architecture for Hoskins.
- Wen. 11. [January 1692/3.] R S met. . . . Little said, nonsense about infinites. Hally S.R.S.¹ . . . Hally of going in Middleton's ship to discover²
- Wens. 18. [ditto.] at Jon. Gof. Lod. hain. flamsted married. rails at Hally.
- We. 1. [February 1692/3.] R Soc met. Hosk in chair. Hally Newton & Gregorys papers of squaring curves.
- Wens. [15] [March 1692/3.] R Soc met. . . . Hally read again his paper of curves. . . . more about Great Shell.
- W. 22. [ditto.] at Home Vincent Lod. Slone Pit. Perry Roberts Hill Herbert Pitf. Waller Hally noe sitting. Discourse of Hally on Mort. Bills of Breslaw. of Comets.
- Fr. 24. [ditto.] . . . Hally alleged spys. . . . Hally sayd Smith allowd him but 9s. for 12 transactions.
- W. 12 [April 1693.] R Soc met. . . . Hally & Middleton made proposalls of going into ye South Sea & Round the World. buoyed up by Herbert. Hill. &c.²
- [The only references to Halley during May are to his appearances at Jonathans.]
- W. 7. [June 1693.] At Jeremys. Sr. J Hoskins & flamsted of Mr. Townly. &c. Hally shewd him an account about his Mother-in-Law.³ At Jon. I. Mr. Gof. & Mr. Lod. witnessed Mr. Hallys Will. NB. . . . Paid Mr. Hally 9d for Dutch mineral press.
- M. 24. [July 1693.] At Jon. Lod. Spen. Pit. 2 east india ships sayd to be taken by French in India: not clear—Hallys trade taken by French.

The above extracts have been begun with Halley's letter to Sir J. Moore from St. Helena. There are earlier mentions of Halley's name, going back to June 1675.

¹ See p. 185, note 2.

² The paper is cut off sharp after the word 'discover'. The Journal Book of the Royal Society contains this reference, under date 12 April 1693:

'The President was pleased to propose to the Society a paper lately offered him by Mr. Benjamin Middleton, requesting the assistance of this Society to procure for him a small vessell of about 60 Tuns to be fitted out by the Government, but to be victualled and manned at his own proper charges. And this in order to compass the Globe, to make observations on the Magneticall Needle, &c. The President in the name of the Society promised to use his endeavours towards the obtaining such a vessell.'

³ Halley's mother-in-law was Mrs. Margaret Tooke (born Kinder), whose will was dated 13 Oct. 1710; cf. *Notes and Queries* (1907), vol. viii, pp. 221, 222, 373.

APPENDIX IV

SELECTED LETTERS FROM THE CORRESPONDENCE OF HEVELIUS, NEWTON, AND OTHERS

Béziat says¹ Hevelius had formed a collection which contained, arranged in chronological order, the minutes of his letters and the originals of those which he had received. This collection, forming sixteen or seventeen volumes, was bought at Danzig in 1725, according to certain authors, or in 1726, according to others, by the celebrated astronomer, Joseph Nicholas De l'Isle (1688-1768), and passed, subsequently, with other collections of the latter to the Dépôt des Cartes et Plans du Ministère de la Marine, Paris, and after the creation of the Bureau des Longitudes to the Library of the Observatory in Paris.² This collection was supposed to contain 2,700 'pieces', but of this number it appears that at least 570 were 'enlevées'.³ Among the originals thus unfortunately lost were four from Edmond Halley.⁴

Fortunately, Hevelius had caused to be made during his lifetime a fair copy of all this correspondence, consisting of sixteen volumes, in folio, of which vols. i-iv, xi-xv, and a part of vol. xvi are now in the Bibliothèque Nationale, Paris, under MSS. *Fonds Latin*, Nos. 10347, 10348, and 10349.⁵

The Royal Society's Library, London, possesses about seventy original letters of Hevelius, for the most part in his own hand, and others are known to exist.⁶

Johannes Ericus Olhoff or Ohlhoff, Secretary of the city of Danzig, published, at Danzig, in 1683, a collection entitled *Excerpta ex Literis Illustrum Virorum, ad . . . J. Hevelium*.⁷

Some account of the correspondence of Hevelius may be found in *Monatliche Correspondenz* (Zach), vol. viii, pp. 30-60, 403-10, Gotha, 1803, and in *Actorum Eruditorum Supplementa*, vol. ix, sect. viii, pp. 359-70, Leipzig, 1729.

From this correspondence, for the purposes of the present collection, only ten selected letters are printed, which have some interest as bearing on the relations between Halley and Hevelius. These are followed by three letters from Newton to Halley (one of which is reproduced in facsimile), two from Leibniz to Halley, and one from Bernoulli.

I. CROUNE to HEVELIUS.⁸

Vir Clarissime

Lond. April. 3 stylo veteri, 1679.

Cum Vir admodum ingeniosus et eruditus Dominus Edmundus Hallejus è

¹ Béziat, L. C.: 'La Vie et les Travaux de Jean Hévélius', in *Bullettino* . . ., ed. Boncompagni, vol. viii, p. 649, Roma, 1875.

² Ibid.

⁴ Ibid., note 10 on p. 650.

³ Ibid., p. 649, note 10, continued on pp. 650-1.

⁵ Ibid., pp. 649, 650, 651.

⁶ Ibid.

⁷ British Museum, press mark: 531.g.25. The Royal Society Library, also, contains a copy.

⁸ Reproduced from a photostat of a transcript (? made by Olhoff), preserved in the Biblio-

Societate nostra insigni prorsus erga studium Astronomicum amore jam pridem inclaruerit, eoque accensus longinquam Navigationem in Insulam Sanctæ Helenæ suscepit, ut Stellarum Australium quæ ob suam Polo Antartico vicinitatem hactenus ab Astronomis nostris inobservatæ fuerint, catalogum adornaret, Tychonico ceu Mantissæ loco adjiciendum (quod accurata observationum administratione egregie præstitit, earumque Longitudines et Latitudines in Tabulas digessit) Jam secundam peregrinationem Astronomiæ duntaxat causa instituat, utque Te Patrem et Principem Astronomorum hujus Seculi videre propius, et super his rebus consulere possit, Dantiscum excurrere cogitet; Voluit idcirco Societas nostra Virum tam eximie de re Astronomica meritum, suis ad Te literis cohonestare; Etsi satis perspectum habeat, quam Tu propenso affectu in eos sis, qui Divinam hanc Scientiam colunt atque amant intimius: Præcipue in Talem Virum, qui quantus in his studiis futurus sit, jam edito in publicum specimine satis ostendit. Scribebam Societatis jussu ac nomine.

Tuæ Claritatis Cultor Assiduus

Gulielm. Croun. M.D. Soc. Reg. Socius.

2. HEVELIUS to CROUNE.¹

Præclarissime atque Excellentissime Vir

Anni quinque fere abierunt, quod literis ad Dñ. Oldenburgium felicitis memoriæ consilium Animi mei, in publicum Astronomiæ emolumentum haud parum proficuum suggestisse me memini, de mittendo quodam in Orientalibus orbis terrarum oras observatore, qui adornato Stellarum Australium hucusque nobis inobservatarum catalogo aliquo quasi novo quodam Argumento Astronomiam locupletaret. Et successit plane ex voto quod Illustrissima Regia Societas huic opinioni meæ adeo adstipulaverit, ut persuasu ejusdem quidam

thèque Nationale, Paris (MSS. *Fonds Latin*, No. 10349, tome xiv, p. 14). The original of this letter may no longer exist. The letter was printed by Olhoff in his *Excerpta ex Literis . . . ad J. Hevelium*, p. 185, Gedani, 1683, and was reprinted (from Olhoff) in the *Biographia Britannica*, vol. iv, pp. 2497-8, London, 1757. It was carried by Halley from London, on his journey to Danzig, in May 1679 (*ibid.*, p. 2497, note [H], col. 2). The article adds: 'Dr. Croune's letter was read the same day it was dated before the Royal Society, and a copy of it is preserved in their letter-book, vol. viii, p. 73' (*ibid.*, p. 2498, side-note 21). Cf. Ward, John: *The Lives of the Professors of Gresham College*, p. 324, London, 1740.

The Royal Society Journal-book, however, does not contain any record that Dr. Croune's letter was actually read at the meeting on 3 April 1679, nor that Halley was formally 'deputed' to go to Danzig.

There is an interesting early reference to Halley's visit in a letter, dated 4 March 1679 (N.S.), from D. Cluver of Hamburg, then in London, to Hevelius. The reference is as follows:

'Est modo Anglus quidam Halli nomine, qui actus desiderio videndi observatorium Tuum Astronomicum itinere maritimo se accingit. Hortatu Societatis Regiæ in Insula Stæ Helenæ ultra Æquatorem 15 grad. sitæ, Astronomiæ operam navavit, corrigendo loca stellarum Hæmisphærii Australis, qua de re ipse plura coram tibi narraturus est.'

Cluver's letter, is, very partially, printed in Olhoff's Collection, p. 184.

In addition to Croune's letter, Halley seems to have carried at least one other, and, perhaps, more letters of introduction and recommendation to Hevelius. Cf. Birch: *Hist. Roy. Soc.*, vol. iii, pp. 488, 499, London, 1757.

¹ From a transcript of the original in Royal Society's archives. A transcript (? made by Olhoff) is also in Bibliothèque Nationale, Paris, MSS. *Fonds Latin*, No. 10349, tome xiv.

insigni in Uraniam accensus amore, in Insulam S. Helenæ suscepto itinere, habitis ibidem diligenter Astrorum contemplationibus expectationi nostræ plurimum satisfecerit. Quandoquidem vero ille sit Tuarum ad me traditor, Vir Clarissimus et scientiarum variarum studijs Excultissimus Dominus Edmondus Hallejus, non potuit non adventus ipsius mihi accidere longe gratissimus: præsertim cum tam Suffragatione Illustrissimæ Societatis cohonestatus quam ipse egregia modestiæ et eruditionis eximæ indole præditus mereatur propensam apud omnes benevolentiam atque favorem. Et sane nihil potius habebō, quam ut meum in se faventissimum animum certissimis argumentis modis omnibus experiatur. Plurimum vero et tibi debeo Vir Præclarissime, quod hâc simul presente occasione, quâ Illustr. Societatis nomine ad me scripsisti, tam manifesta tui in me affectus exhibuisti indicia, ut de novâ hâc notiæ et amicitæ tuæ accessione plurimum mihi gratulari habeam necesse. Summa animi contentione allaborabo vicissim de meo in te Vir Clarissime studio et paratissima inserviendi voluntate ut quam optima Tibi pollicere possis. Vale Vir Præclarissime et excellentissime, et Illustr. Regiam nostram Societatem, meo nomine officiosissime haud gravatim saluta, et promptissima servitia Ei defer; qui sum maneoque, &c.
A^o. 1679 die 10 Junii St. N. Gedani.

3. HEVELIUS to GREW.¹

Illustri Viro,

Dn. Nehemiæ Greevio,
Illustriss. Regiæ Societatis Secretario,
Amico honorando,
Johannes Hevelius, S. P. D.

Nunc quidem nullum ampliùs scribendi argumentum mihi suppetit, nisi ut Tibi significem, quòd Cl. & Doct. Dn. Hallejus hûc Dantiscum feliciter advenit, ac me die 26 Maji inviserit, cujus adventus mihi profectò gratissimus extitit, tum quòd Illustr. Regia Nostra Societas Eum mihi commendare voluerit, tum quòd jam pridem exoptaverim, ut aliquis, Rerum Astronomicarum benè gnarus, ex Vestratibus me inviseret, ut de rebus quibusdam, in quibus hactenus cum nonnullis non omninò convenimus, cum illo sermones reciprocare, mentemque ac rationem nostram observandi coràm factis, non nudis verbis, exponere mihi liceret, ac ille sic postea Vobis etiam eò meliùs de omnibus meis rationes reddere, & nonnullorum dubia solvere posset. Non dubito, quin Illustrissimæ Regiæ Societati rem omnem planè aliter suo tempore exponat, quàm quidem nonnulli de meis Instrumentis & observatis arbitrati sunt, & quòd organis & observatis meis etiam aliquid tribuendum; imò multò magis, quàm sibi unquam nonnulli persuasissent, tum quòd mihi injuriam fecerint, quòd scribere ausi fuerint, me vix duo, vel tria integra minuta prima Instrumentis, nudisque meis oculis exquisitè derimere posse; imò illos jugiter aberrasse; qui dixerunt, se posse instrumentulo unius spithamæ, telescopicis pinnacidiis instructo, sexagies accuratiùs rem omnem determinare, quàm ego illis meis majoribus Organis Orichalcicis. Quandoquidem in præsentia Cl. Dn. Halleji sæpiùs, tum Qua-

¹ Reprinted from Hevelii, *Johannis: Annus Climactericus*, p. 99, Gedani, 1685.

drantibus, tùm Sextante à nobis observatum est, nec non Cl. Hallejus multoties mecum, tàm cum coobservatore meo, easdem observationes tentavit; quousque verò inter se omnes observationes, cum illis olim toties per plurimos annos diversis instrumentis à me habitis, & nunc jam oculis omnium expositis convenient, observata ipsa, quæ Cl. Dn. Hallejo modò tradidi, affatim testabuntur. De cætero, cùm nuperrimè observatio quædam haud vulgaris, nimirùm Jovis à Lunâ tecti mihi obtigit, & quidem præsentè Cl. Hallejo deprehendere, ac rectè annotare: igitur non potui intermittere, quin illam quantocyùs Illustr. Reg. Societ. Nostræ transmitterem, quò simul posses eandem Illustrissimo Dn. Moooro, cui officia mea iterum iterumque submissè defero, tùm Cl. Flamstedio, aliisque harum Rerum Cultoribus communicare: quæ si etiam apud Vos, vel Parisienses simul observata est, rogo digneris eas ipsas annotatas transmittere. Quibus feliciter vale, & quàmprimùm ad priores meas, 24 Aprilis datas, responde. Dabam Gedani, Anno 1679, die ipso Solstitii Æstivi.

4. HEVELIUS to CLUVER.¹

Præclarissimo, atque Doctissimo Viro, Dn. Dithlero Clüvero, J. Hevelius, Sal.

Dominus Édmundus Hallejus, cujus mentionem in Literis Tuis fecisti, feliciter hûc Dantiscum Mense Majo advenit, cujus adventus mihi profectò gratissimus extitit: præprimis cùm jam pridem exoptaverim, ut aliquis ex Anglis, qui Instrumentis, pinnacidiis Telescopicis instructis, benè esset exercitatus ad me veniret, atque tale Instrumentum secum afferret, quò possimus ab utrâque parte, re ipsâ, non nudis Verbis, commonstrare, quid uterque nostrùm præstare valeat. Quod sicuti nunc tandem obtinui, sic maximoperè mihi exinde gratulor. Imaginati quidem sunt, uti scis, sibi aliqui, prout Dn. Hoockius, reliquos ut modò taceam, non haud posse duo, vel tria integra minuta prima exquisitè decernere; sed Dn. Hallejus, Veritatis aliàs amans, testabitur, sine omni dubio (quippe qui singulis ferè serenis noctibus, mecum observationibus operam dat, tùm multoties meis instrumentis, tùm mecum, tùm cum Coobservatore meo observat) rem planè aliter sese habere, & quòd præcisiùs me nudis oculis posse, meâ ratione, & distantias Fixarum, & Altitudines Meridianas determinare, etiam hoc tempore Solstitii lucidissimâ nocte, nec non Lunâ splendente, quàm unquam hactenus sibi ipsi imaginari potuerit, & quòd Ipsi abundè affatim satisfecerim; sed an Hallejano Instrumento mihi satisfacere potuerim, hâc vice taceo. Felicem sanè me nunc prædico, quòd nunquam illas dioptras Telescopicas amplexus fuerim, ut ut Dn. Hoockius aliter semper sustinuerit. Equidem quæ jam pridem in isto negotio mihi suboluerunt, ea nunc coràm in istis Instrumentis manifestè deprehendo; sic ut multò adhuc magis in sententiâ meâ modò confirmer. Iis, qui visu minimè pollent, & qui neutiquam sunt pinnacidiis nudis assueti, libenter ea Telescopica pinnacidia relinquam. Ego profectò illa retinebo, quæ nunquam à primâ Instrumentorum constructione commota, nec sine summâ aliquâ vi de loco suo debito commoveri possunt, quæ nunquam mihi abstergenda, corrigenda, examinanda, & quæ nullis vitrorum refractionibus, vel alterationibus quibusdam sunt obnoxia, quibus unam, eandemque distantiam toties, quoties velim, ex voto

¹ Reprinted from Hevelii, *Johannis: Annus Climactericus*, pp. 100-1, Gedani, 1685.

præcisè determinare possum, licet sit ante 10, vel 20 annos, jam cum diversis sociis habita; quæ pinnacidia initiò rigidissimo examini subjeci, ac quæ ampliori examine nunquam opus habent. Verùm quid illis meis pinnacidiis, meisque qualibus qualibus Instrumentis peregerim, & quousque semper observationes determinare quiverim, Tu, cum aliis, qui nullarum sunt partium, nunc ex opere meo edito, Uranicarum scilicet Rerum observationibus, dijudicare poteritis. De quibus omnibus etiam de Te Tuum expecto judicium, quod ut mihi pergratum accidet, sic allaboraturus, ut quâvis occasione Tibi rursus gratificari non nequeam. Vale quàm diutissimè. Dabam Gedani, Anno 1679, die 22 Junii.

5. HEVELIUS to CLUVER.¹

Dno. Dethlevo Cluvero. Londini. Præclarissime atque Doctissime Vir, Amice Honorande,

Nullas, nisi binas, post illam atrocissimam cladem meam a Te accipi literas; ad priores Tuas Ao. 1680, die 17 Febr. datas respondi, initio ni fallor hujus anni præteriti, an illas autem acceperis, dubito, cum in posterioribus Tuis a Dno Kõning mihi oblati, nullius plane earum feceris mentionem. Quare consultum esse duxi copiam illarum mearum hisce Tibi transmittere. Cum quibus simul literas dederam eo tempore ad Cl. Dn. Egmundum Hallejum, quas etiam plane periisse putabam, cum nullum omnino hucusque ab ipso acceperim responsum, nec quicquam ab ejus hinc discessu, de quo sane multum multumque miratus; percepi quidem in Galliam Italiamque discessisse, sed nihilominus potuisset 30 mensium spatio amicum, qui ipsi omnis generis officia humanitatis exhibuit, etiam ex Gallia, sive Italia, lineola una aut altera salutare atque condolare vices ejus, ob acerbissimum illatum infortunium; quod quale quantumque fuerit tanquam ocularis testis, præ aliis plurimis, optime novit.

Statum meum quod attinet, nihil nunc quicquam magis molior, quantum gravissimæ occupationes tantummodo permittunt, quam ut possim erectam meam, divina adjuvanti ope, Speculam, rursus necessariis instrumentis, Telescopiisque restaurare; quem in finem nunc simul quoque ad Præcl. Flamsted dedi literas, ut mihi subveniret in coemendis ære meo lentibus quibusdam Telescopicis, horologiis librisque, non dubito cum jam sponte sua res nonnullas mihi transmiserit, quin et hac in parte facilem, rei literariæ bono, se præbeat; Tu si quicquam pariter huic negotio contribuere potes, vitris horologiisque eligendis, examinandis, facies rem mihi multo gratissimam. Misit nuper mihi egregium Micrometrum, sed quomodo Tubo inseri, in eoque firmari, et cujus generis Tubo applicari debeat non addidit: idcirco perpensis rebus apud Cl. Flamstedium omnibus, describas rem omnem clare, vel delineatione quadam distincte exprimas rogo. De reliquo observationes nullas de Cometa novissimo in lucem edidi: nam cum illas non more meo pristino maximis instrumentis accuratissime, (Organis tum omnibus prorsus orbatus) peragere potuerim, nolui eas ruditer tantummodo administratas in publicum proferre. Parisiensium observationes nondum videre mihi obtigit, nec quicquam literarum vel observationum a Cl.

¹ From a photostat of the letter (? fair copy by Olhoff) in the Bibliothèque Nationale Paris (*Fonds Latin*, No. 10349, as before).

Cassino, nec ullo alio (si Bullialdum excipias) Parisiensium hucusque adhuc obtinui.

Gratulor Tibi, amice honorande, quod Ephemerides Tuæ jam sub prelo sint; faxit Deus omnipotens ut brevi lucem adspiciant, erunt profecto Orbi Literato gratissimæ, meque valde beabis, si quando (uti promittis) exemplar aliquod Dantiscum transmiseris, utinam vicissim re aliqua grata benevolum meum erga Te affectum contestari valerem. Spero, Deo dante, proxima ætate me quoque editurum Annum meum observationum Climactericum, nec non Globos meos cœlestes, atque Uranographiam delineaturum; quid Londini hactenus prodierit novi scire valde gestio, inprimis an acta philosophica ab obitu Cl. Oldenburgii continuata sint, et quis sit eorum continuator. Vale et me amare perge. Dabam Gedani Ao. 1681.

T. ex animo bene cupiens
J. Hevelius

6. FLAMSTEED to HEVELIUS.¹

Amplissimo Celeberrimoque Viro Do. Johanni Hevelio, Veteris Civitatis Gedanensis Consuli dignissimo, Meritissimo Astronomo, Amico plurimum honorando Joh: Flamsteedius S.p.d.

Octo jam Menses et amplius amicus noster communis Ds. Halleius in Gallia abfuerit inde in Italiam transiturus, cum literas ipsi a te datas pater ejus accepit aperuitque. Has perlegendi amico meo cuidam alio facta copia, qui mihi ijs a te scriptam narrat nullas a me te recepisse literas ex quo ædes vestræ conflagraverint, quod unde evenerit nescio, oro ne mea culpa accidisse putes, ingrattissimum enim meipsum haberem et amicitia tua prorsus indignum, si tamdiu vel ejus vel beneficij quo me nuper affecerat immemor esse potuissem, cujus nunquam fui oblitus. Epistolam enim ad te bene longam dederam, Heveli mihi Colendissime, quo tempore incertus rumor de ferali illo incendio ad aures nostras primus pervenerat. Hac receptam Machinæ tuæ Cœlestis partem posteriorem qua me donare et ditare placueras significavi, et pro charissimo mihi munere gratias egi quas potui maximas, deinde transcriptis triginta fixarum clariorum distantis e pagella protocolli mei, eodem ordine quo adnotatæ fuere ex iisdem cum tuis collatis, mirabilem utique Instrumentorum et observationum nostrarum consensum ostendi, scilicet, quod ex iis octodecim haud plus 30" ab invicem discreparent, e duodecim reliquis sex non amplius 40", et e sex residuis unica duntaxat integrum minutum porro e collatis etiam stellæ polaris nostris animadversionibus, altitudinum nostras observationes haud minus quam distantiarum consensuras collegi, Aliquid præterea de usu tuarum observationum in illa Epistola commentus sum, quam vix dimissem cum a Mercatoribus nostris intellexi, Famam non falsa omnia ut speraveram de rebus tuis retulisse. Dolui tunc animitus Casum hunc tibi et Astronomiæ studiosis omnibus gravissimum quorum certe intererat Historiam Cœlestem observationibus a teipso peractis idque iisdem instrumentis habere continuatum. Sed et valde pertimui ne illatum hoc incendio damnum Animum tuum ad curas magis

¹ From a photostat of the original in the Library of Trinity College, Cambridge.

necessarias abstraheret. Quamobrem ad te iterum dare literas distuli et a scribendo abstinere constitui ne nimium viderer et intempestive sollicitus donec ab Epistolis tuis ad Reg. Societatis nostræ Socios et Amicum communem intellexi Animum te egregio homine et Christiano vere dignum damnis hisce immotum illæsumque retinuisse et eadem qua ante hac mente studia assueta prosequi, sed adminicula quædam vitrorum tibi deesse, quæ quando hinc a Do. Halleio transmitti petis, eo absente, illas in me tibi comparandi curam necessario devolutam sensi, et gavisus sum, quod hac occasione opportunitas mihi oblata fuerit grati pro benevolentia tua animi indicium aliquod exhibendi; Objectivas ergo lentes pro tubis pedum 8. 16. et 24 ad te mitto cum ocularibus quibusdam et Micrometro propriæ meæ excogitationis, cui tamen solitas a facie inscribere divisiones Artificem vetui, facillime siquidem variis instrumenti locis, certe magis ad mentem tuam a teipso quam a quovis alio insculpi possint. Hæc a me accipias oro servesque tibi utcunque tenuia amicitia nostræ testimonia.

Observationes tuas Palilicij a luna tecti primo Januarij ultimum elapso, idem amicus cui Epistolam tuam perlegere concessum ab eadem transcriptas mihi communicavit, eandem hic videre eclipsin nubes non permisere ejusdem autem fixæ binas ante occultationes mensibus Septembre et Octobre præcedentibus observaveram, quarum Animadversiones inclusa tibi reddet chartula, una cum nuperi cometæ locis e propriis observationibus a meipso supputatis, quibus tamen indagandis non fixarum loca a Tychone mutuata adhibui, sed per distantias et altitudines meridianas a meipso captas correctæ, cujus propterea te admonendum duxi ne causam ignorares exiguæ differentia inter Cometæ loca a me et a Gallicis observatoribus determinata, si in manus tuas illa forsitan devenere. His addo Animadversiones hic habitas Eclipsis nuperæ lunaris. Cujus si quid a te Gedani adnotatum fuerit pergratum erit mihi intelligere.

Ds. Gale te salutari a me jubet quam officiosissime. Nec non et Ds. Grew. Deus tibi, Meritissime Astronomorum, damna tua omnia sanctificet, amissa restituet vel meliora teque quam diutissime sospitem conservet. Vale. Grenovici scriptum in Observatorio. Octobris 7/17. 1681.

7. HEVELIUS to HALLEY.¹

Clarissime ac Doctissime Vir, Amice Honorande,

Singularis Tuus amor, atque benevolus erga me affectus, non solum olim humanissimis literis, sed et præcipue coram abundè satis es contestatus; sic ut de Te gratissima quævis, quæcunque ab intimo amico unquam proficisci possunt mihi nunquam non polliceri queam. Verum enimvero undè evenerit, quod post Tuum à Nobis discessum, sive ante, sive post illud nefandum infortunium, quod mihi proh dolor! obtigerat ne ullâ literulâ me salutaveris, multò minus cum aliis deditissimis amicis in tantâ rerum mearum clade consolatoriis quibusdam mihi subvenire, fractumque animum erigere volueris; cum tamen pro-

¹ After a photostat from the transcript (? by Olhoff), now in the Bibliothèque Nationale, Paris, under MSS. No. 10349, tome xv, pp. 41-5. The original of this letter is in the Royal Society's Archives, and differs occasionally from this transcript.

penissimam meam erga Te voluntatem omnibus modis Tibi hic Gedani præsentī quoad patefieri à me totâque meâ familiâ unquam potuit, tunc quam pronus fuerim ad quævis gratissima officia Tui gratia subeunda, luculenter detexerim, nullas unquam rationes hactenus comminisci potui, quòd adeò constanter in alto illo silentio perstes, nec quicquam ad Dno. Olhoffii literas jam exeunte anno 1679 datas responderis, inprimis attento, quod jam aliunde tum ex literis modò dictis affatim cognoveris, me adhuc esse Gratiâ Divinâ in vivis, tum quonam in statu res meæ versentur. Verùm quicquid sit nihilominus tamen nolo quicquam adversi de Te augurari, multo minus nodum amicitiae nostræ, ob infortunium meum Te penitus resecare velle; sed è contrario, nullus planè dubito quin quantocyus ea, quæ hactenus neglecta fuere, crebrioribus literis sis resarciturus, illumque Te porrò ostendas, quem mihi de Te firmiter promittebam. Quid apud vos in re literariâ præsertim Astronomiâ agatur quæso perscribas, Ego post illam calamitosissimam stragem, vix quicquam, ut faciliè intelligis, præstare hucusque potui. Nam hactenus occupatissimus fui ædibus meis reædificandis, et nunc in erigendâ et restaurandâ speculâ meâ; quòd possim rursus ad pristinos meos annuente Divino Numine redire labores. Verùm cum plurima mihi denuò comparanda sint, quæ ferali incendio prorsus periire, utpote inter reliqua, nonnulla vitra Telescopica. Quare Te etiam atque etiam rogatum volo, ut mihi æquiori pretio ea comparare velis, 1. Lentes pro tali Telescopio construendo, quale Tecum hic Gedani habebas 8 circ. pedum. 2. Lentem optimæ etiam notæ, objectivam cum duobus vel tribus convexis ocularibus pro Telescopio 12 vel 15 circ. ped. 3. Lentem objectivam cum necessariis ocularibus pro Tubo 20 vel 24 circ. ped. 4. Operam dabis ut ejus generis tubulum rursus à Dno. Kock, si adhuc est in vivis, meliori pretio impetres, cum sc. duobus vitris convexis ocularibus constructum, una videlicet planiori majori, et altera gibbosiori, qualem planè Tubulum cum ejusmodi lentibus mihi olim miserat, pro isto Tubo 60 pedum; quippe et illæ perditæ sunt. Pleniorem descriptionem hujus Tubuli cum ejus annulis striatis quibus utraque lens includitur, invenies in Parte I. Machinæ meæ Cœlestis pag. 388 et ejus delineationem in fig. X et Y pag. 382 et 392. Obnixè autem rogo, ut primum omnes lentes debità explorare velis, an Tibi etiam satisfaciant, tum ut Tubulus ille non solùm unicâ illâ gibbosiori oculo viciniori lente sit constructus sed minimum tribus diversis peculiaribus ligneis capsulis inclusis, ut pro re exigente, hanc vel illam Tubulo adaptare possim. Non dubito, cùm optimè sciat Artifex quam immensam jacturam ex illo crudeli incendio fecerim, quin mihi omnia longè viliori pretio, quam aliis plerumque solet, concedat, præprimis attento, quod olim tam Telescopica, quam plurima Mycrosopia satis carè ab ipso emerim. Deinde etiam rogo, ut ea, quæ petieram cùm hic esses, conspicilia videlicet diversi generis, et vitra quædam Telescopica si alterius fortè generis sint, quam quæ supra jam indicavi, nec non libros illos à me desideratos mihi transmittas ut et omnia opuscula Dni Hooekii inprimis si latine sint reddita; nec non Tuum catalogum Fixarum Australium una cum duabus vel tribus peculiaribus Iconismis stellarum; adhæc delineationes Instrumentorum Flamstedii ejusque observatorii, vel quicquid hæc de re amplius hucusque prodiit, quandoquidem omnia illa, quæ etiam ex dono tuo possidebam penitus conflagrata sunt. Ferè oblitus eram transmittas etiam rogo

instrumentulum illud Tubo inserendum pro minoribus distantis capiendis; nam neminem nunc à manibus habeo qui mihi illud conficere potest. Adhæc pecuniam quam in res illas erogaveris Mercator Londinensis Jean Baptista van Laer qui has literas Tibi tradidit, procurante Nobiliss. Dno. De Grata Portarum Magistro quantocyus Tibi restituet, pariter novem cum dimidio illos imperiales, quos ex tunicâ Uxori meâ transmissâ Tibi solvere adhuc debemus. Adhæc nisi grave est sciscitari velis ex diversis Automathurgis quanti vendant minus quoddam portatile horologium singula minuta et secunda commonstrans, theca quâdam argentea inclusum duorum circiter pollicum in diametro vel aliquanto minori ut commodum vobis videbitur dum [?] accuratè confici possit; nec non quid velint pro aliquo majori in mensâ reponendo cum uno perpendicularo seu potius duobus novissimâ illâ ratione instructo, singula minuta et secunda commonstrante, quale apud me vidisti, absque pondere, sed calamo chalybeo adornato, unius circiter pedis altitudinis, absque ulla campanula; sed necesse ut sit accuratissimè elaboratum, ut officio in observationibus satisfaciat. Denique quanti etiam æstiment sexangulare aliquod horologium in diametro 4 vel 5 pollicum monstrans solummodo horas minuta et secunda, quippe omnia mea horologia aut incendio periere aut furto mihi ablata sunt. Cometam illum insignem quem à Die 2 Decemb. Anni 1680 ad 4 usque mane ante Solis ortum in ♄ et ♃ et Latit. Austr. et postmodum vesperi post Solis occasum in ♃, ♄, ♀, ♁, et denique in ♃ in Latit. hor. ad 18 Febr. observavi, non dubito quin Tu, alique Vestratum recte et debite annotastis. Quare Te etiam atque etiam rogatum velim, cùm illum ex animi sententia ob nondum plane Speculam meam restauratam haud observare potuerim ut mihi quantocyus vestras observationes tam matutinas quam vespertinas transmittas una cum Ephemeridibus Eruditorum omnibus quæ post num. 131 Anni sc. 1676. 2 Ianuarii prodierunt, vel si quid novi editum fuerit, valde me Tibi obstringes. Interea Illustr. Nostram Societatem officiosissimè salutes rogo; nec non Dn. Ioh. Wallisium Flamstediumque; quorum ultimus mei etiam plane oblitus quippe post meum illud infortunium ne semel quidem vel literulâ salutavit. Vale et me ama. Dabam Gedani Ao. 1681 die [date imperfect].

T. Cl. studiosissimus

J. Hevelius

8. HEVELIUS to HALLEY.¹

Clarissimo atque Doctissimo Viro Dno Egmondo Hallejo Matheseos Cultori Eximio amico honorando J. Hevelius S.

Abundè nunc liquet tam ex literis tuis Romæ 15 Novemb. datis quam meis, non nisi injuriæ temporum adscribendum esse, quod neuter nostrum vel quicquam literarum ab altero acceperit. Ut autem omnia redintegrentur, atque imposterum commercium nostrum literarium eò feliciter succedat, amicitiaque nostra magis magisque firmetur, rogo haud graveris copiam trium illarum literarum, quas ad me dedisti, commodâ quâdam occasione, cum rebus illis omnibus

¹ After a photostat from the transcript (? made by Olhoff), in the Bibliothèque Nationale, Paris, under MS. No. 10349, tome xv, pp. 107-9. The original of this letter is in the Royal Society's Archives.

tum adjunctis mihi transmittere, simul etiam nonnulla quæ adhuc desidero; nisi fortè ea Cl. Flamstedius mei gratia jam coemerit, vel elaborandum curaverit. Nam cum literæ meæ, quas initiò anni præteriti ad Te dederam, tandem in illius inciderint manus, factum est ut ex singulari ejus erga me amore protinus sponte suâ, res nonnullas, quas à Te expetieram, mihi nuper Mense Octob. transmiserit: utpote tres lentes objectivas, pro Tubo 8, 16, et 24 pedum, cum necessariis vitris ocularibus, nec non egregio Micrometro. Hinc perspecta ejus humanitate, rursus ad dictum Cl. Flamstedium scripsi, ne non pro ære meo, reliqua etiam, quæ à Te petieram, Te nimirum absente, ad restaurandam Uraniam meam mihi comparare ac coemere vellet. Quare, quamprimum redieris, loquaris peto cum illo ut percipias, quid mei causâ peractum sit, et si quædam adhuc restant, communicato consilio rem suscipiatis rogo; utpote Tubulum istum in literis meis N 4. descriptum à Dno Kock meliori pretio quantocyus obtineam, nec non libros atque opuscula desiderata, vel quæ insuper vobis videbuntur è re meâ esse. Deinde quæ de horologiorum pretio scire gestio fac etiam ut primo quoque tempore resciam, ut vobis detegere possim qualia horologia mihi comparanda atque transmittenda sint. Nihil enim nunc, reædificatis ædibus meis, atque Speculâ meâ, Divinâ annuente Gratiâ rursus erecta me magis anxium tenet, quàm ut possim Organis necessariis, Tubisque Uraniam meam restaurare: quò valeam ulterius, quoad Deo O. M. visum fuerit, studiis nostris sidereis invigilare, eaque pro tenui meo modulo, in Rei Literariæ commodum vobiscum promovere, atque exornare. De Parisiensium statu, studiis, observatorio, atque instrumentis quædam percipere avidissimè à Te exspecto: quandoquidem ab illis amicis omnibus, utpote Ill. Dno. Carcavi, Casino, Picardo, Gallois, Gallet, et P. Franc. de Schales (excepto unico Bullialdo) ne quicquam responsi adhuc ad meas jam anno 1679 die 24 Aprilis datas, cum unicuique illorum exemplar Part. I I. Machinæ meæ Cœlestis simul transmiserim, obtinui; an horrendum illud meum infortunium in causâ fuerit? an me responsione non amplius dignentur? an verò operas meas tanti non æstiment, profectò nescio; quicquid tamen sit, non absque ratione id factum esse, planè mihi persuadeo. Verùm lætor ex animo meâ culpâ id non contigisse, sed me Viros illos toto Orbe Celeberrimos semper in maximo habuisse honore, ac voluntatem meam quâvis occasione illis, pro tenuioribus meis studiis inserviendi, haud obscurè declarasse. Nullus non fortè inferre posset, se ad me scripsisse; sed cum aliquoties per amicum significatum fuerit, me nihil quicquam ab ullo eorum obtinuisse, potuissent minimùm copiam illarum responsionum transmittere. Attamen Amicis illis omnibus quævis felicissima comprecor; ut possint longè accuratiora, solidiora, ac majora quibusvis nostris in publicum producere. Alii namque ad inferiora, alii ad sublimiora nascuntur: Aliis ex voto succedunt omnia, aliis fata fortiter obstant, sed hæc omnia à Directore Rerum omnium cum proveniant, oportet, ut quilibet suâ sorte sit contentus; ac in voluntate Divinâ acquiescat: quibus etiam erigor in his meis atrocissimis adversitatibus. Vale, Amice Honoratissime, et me amare perge. Dabam Gedani Ao. 1682 die 9 Januarij

Tuæ Cl. Omni studio ac voluntate
Joh. Hevelius

9. HEVELIUS to HALLEY.¹

Dno. Egm. Hallejo, Londini. Clarissime atque Doctissime Vir, Amice Honorande.

Literas Tuas breviores die $\frac{7}{17}$ April. Londini datas nec non bina illa ocularia cum cistula rebusque illis ea inclusis absque tamen ullâ specificatione à Nauclero optimè accepi; sed proluxiores illas Literas Tuas per Tabellionem mihi transmissas hucusque neutiquam, quæ contenta arculæ exponere debebant, tum referre quid mei causâ expeditum, et erogatum fuerit; rogo itaque quam humanissimè, ut inquiras ubinam dictæ literæ remanserint, et ut primo Tabellario copiam illarum literarum mihi tutiori via transmittas; quò possim plenè Tibi ad omnia respondere. Interea gratias Tibi habeo maximas, quod adedè prompte desiderio meo satisfacere volueris; utinam rursus Tibi amicisque omnibus gratificari possem, facerem sanè animo perquam lubentissimo. Quamprimum a. nunc copiam illarum literarum cum delineationibus desideratis accepero plenissime Tibi sum responsurus, etiam proluxiores gratias acturus. Observationem meam Eclipseos Lunaris nuperæ Ill. Reg. Soc. transmissam nullo negotio à Præcl. Franc. Aston Ill. Reg. Soc. Secret. obtinebis. Quibus Te etiam atque etiam valere cupio. Dabam Gedani Ao. 1682 ipso die Solstitii Æstivi.

T. studiosissimus J. Hevelius.

10. HEVELIUS to ASTON.²

Illustrissimo Viro Dn. Francisco Astoni, Illustr. Reg. Societ. Secret. Ioh. Hevelius S.

Animitus exoptassem, ut Amicis in Anglia universis, Viris illis Clarissimis, citius respondere potuissem. Verùm occupationes variæ, quibus dstringor, et occasio, quam nullam hucusque commodam nancisci non nequivi, in causâ fuere, quò minùs id fieri potuerit. Nunc oblata occasione bellissimâ, qua Nauclerus Samuel Bloss hinc solvet, proluxius ac plenius Amicis singulis ad singula ipsorum literarum capita me respondisse planè persuasum habeo. Quibus etiam hâc vice exemplaria quædam Anni mei Climacterici nuper editi distribuenda transmissi, quæ ceu leviuscula munuscula æqui bonique ut consulant, est quod obnixè rogem. Totum Librorum fasciculum ad Dn. Jacobum Davidt, Mercatorem Vestratem Londinum direxit Dn. Walther Nostras, adedè ut non dubito, quoniam optimè illum recepturi sitis. Proluxiorem jam me in literis esse vetat valetudo mea minùs firma, quam per aliquot dies expertus sum. Spero tamen me Divinâ favente Gratiâ desideriis Vestris in posterum satisfacturum. De reliquo maximopere abs Te peto, ut Illustr. Regiam Societatem, omnesque nobis benè cupientes Amicos officiosissimâ nostrâ Salute impertias ac Valeas. Dabam Gedani d. 19 Maji St. n. Ao. 1685.

¹ After a photostat of the transcript (? made by Olhoff), in the Bibliothèque Nationale, Paris, under MS. No. 10349, tome xv, p. 168. The original was, probably, in the collection in the library of the Observatory, at Paris, but subsequently stolen (? by Libri). This letter appeared in Bersohn, M.: *Kilka Słow o Janie Heweliuszu*, p. 22, Warszawa, 1898.

² After a photostat of the original in the Royal Society's guard-book. Cf. Birch, Thomas: *History of the Royal Society*, vol. iv, p. 406, citing Royal Society Letter-book, vol. x, p. 142.

II. NEWTON *to* HALLEY.¹

Cambridge, Oct. 17th. 1695.

Sr.

I had writ a letter to you last week but stopt it because I had inserted a passage I was uncertain of. Your calculations have satisfied me that the Orb of the Comet of 1680/1 is Elliptical. And by a certain calculation grounded on them upon a supposition that the Latitudes in November as I drew them from ye course² Observations of others and printed them, are right; I seem to collect that this Comet rises about 10 or 12 times higher then the orb of Saturn & by consequence revolves in about 400 years. But the Parabolick Orb of this Comet as you have determined it seems to admit of rectification. For the errors in Latitude ought to be double to the errors in Longitude in ye months of Febr. & March, supposing the plane of the Orb to be rightly determined. The reason is because the angle of that plane wth the plane of the Ecliptick is about 60 degr. Wherefore considering that ye errors in Longitude (in your calculus) are something more then equal to the errors in Latitude, I diminish the angle wch the plane of ye comets Orb makes wth ye plane of ye Ecliptick by $24\frac{1}{3}$, making it only 60 degr. 56', & by consequence I place the Nodes in ≈ 2 degr. 2' & $\vee 2$ degr. 2' or thereabouts; adding about 9' to ye place we fixt it in before. Also the Latus rectum of ye Parabola, wch you make 0,0243 I increase by 0,002 so as to make it 0,0245, & the distance of the comet from ye earth between Decemb. 29 & Jan. 5 I suppose the same as in your calculations, & add 2' to ye time of the Comets Perihelium so as to make it Decemb. 8 d. 0 h. 6'. P.M. By this means the errors in Latitude will I think remain much the same as in your calculations, except that they will in ye end of the Comets motion be decreased about 10". And the errors in Longitude will be decreased both in the beginning & in the middle, & so much in the end as to remain but about half of the errors in Latitude as they ought to be in a parabolick Orb. But in my Observations of Feb. 25 there is an error of 1' in Longitude. It was printed off $\text{S } 26 \text{ } 19' \text{ } 22''$; but should be $\text{S } 26 \text{ } 18' \text{ } 22''$. I do not think it requisite you should give your self further trouble about this Comet, but if you do you need only calculate the places of ye Nodes & Perihelium from ye above mentioned data; & in the Parabolick Orb thus determined 3 or 4 places of the Comet, suppose Dec. 21, Jan 5 & 25 & Mar. 5. For it will then be easy to fill up the other places by interpolation & to assign such an Elliptick Orb as will answer all the Observations as exactly as can be.

You have made ye Orb of the Comet of 1664 answer Observations much beyond my expectation tho' wth double pains in calculating all the Observations anew. I can never thank you sufficiently for this assistance. I wish it in my way to serve you as much. I have sent you by Will. Martin ye Box of Brass Rulers & beam compasses & 8s for Vlac's Trigonometry wth many thanks. Those edges of the brass Rulers which look rough, I ground true to one

¹ From one of two copies of this letter in the Portsmouth Collection, University Library, Cambridge, both of which seem to be drafts, but one is in bad condition.

² 'course' in the other copy is 'various'.

another wth sand. If it will not give you too much trouble to make an extract of your calculated places of ye Moon you need send only those without your book but if you had rather send your book then an extract, it will be ye same thing to me. I am

12. NEWTON to HALLEY.¹

Dr. Halley

I received from you formerly a Table of the motions of the Comet of 1680 in an Elliptic Orb. You there put the Node ascendent in φ 2gr. 2'. The Node descendent ω 2gr. 2'. The inclination of the plane of the Orb to the plane of the Ecliptic 61 gr. 6'. 48". The perihelium of the Comet in this plane \nearrow 22 gr. 44'. 25. The equated time of the Perihelium Decem. 7 d. 23 h. 9'. The distance of the Perihelium from the ascending Node in the plane of the Ecliptic 9 gr. 17'. 35". The Axis transversus 13829571. And the Axis conjugatus 184812, the mean distance of the Earth from the Sun being 100000. And in this orb you computed the places of the Comet on November 3. 16 h. 47': November 5 15 h. 37' & Novem. 10 16 h. 18'. as follows.

1680.	Tempus verum	Long. comp.	Lat. comp.
Novem	d. h. '	° ' "	° ' "
	3. 16. 47	Ω 29. 51. 32	1. 17. 32 bor.
	5. 15. 37	Υ 3. 24. 32	1. 6. 9
	7. ² 16. 18	15. 33. 2	0. 25. 7

The first of these three places you have inserted into the Table of the motions of this Comet in an Elliptic Orb wch you have printed in your Astronomical Tables where you treat de motu Cometarum in Orbibus Ellipticis. I beg the favour of you to reexamin the two last of them, vizt. those on Novem. 5. 15 h. 37' & Novem. 10. 16 h. 18'.

In the same printed Table you have calculated the place of this Comet upon March 9. 8 h. 38' true time. I beg the favour of you to calculate its place in the Parabolic Orb also upon March 9. 8 h. 38' true time, & send me its computed Longitude Latitude & distance from the sun. For I would add them to the Table of the motion of this Comet in a Parabolic Orb printed in the third book of the Principia Mathematica pag. 459, Edit. II. By its distance from the Sun I mean its distance in parts whereof the Radius of the Orbis magnus is 100000. I am

In correcting the Parabolic orb of ye Comet of 1680 you may assume ye same plane of this Orb with that of the Elliptic Orb, & the same Axis in position, & the same time of the Perihelium in both cases; & then by any one good Observation determin the Latus rectum of the Parabola & by another good one examin the determination.

¹ From photostat of the draft, by Newton, in the Portsmouth Collection, University Library, Cambridge.

² 7 in Newton's original. A slip of the pen for 10?

13. NEWTON *to* HALLEY.¹

Orbells buildings in Kensington March 1st 1724.

Dr. Halley

I thank you for the Table you sent me of the motion of the Comet of 1680 in a Parabolic Orb so as to answer to Kirk's Observations as well as to Flamsteed's. It answers all their Observations well enough for my purpose. But you have omitted the distances of the Comet from the Sun in parts of the mean distance of the earth from the Sun divided into 100000 equal parts: such parts as the Latus rectum of this Parabolic Orb consists of 2508. These distances you have computed already in your papers in wch you calculated this Table, & you need only to copy them from thence. I have inclosed a copy of your Table with a vacant column for these distances, & beg the favour of you to fill it up by inserting these distances out of those your loos papers in wch you made your calculations of this Table. The distances are inserted in your Table published in the second edition of my Principles pag 459. I intend still to keep that Table & add this new one to it if you please to fill up the column of distances in the same manner that the two Tables may be like one another. And by the help of this new Table I shall be able to make the schemes of the motion of this Comet more perfect. I am

Yor humble servant
Isaac Newton.

14. LEIBNIZ *to* HALLEY.²

Nobilissimo et de utraque Republica meritissimo Viro Edmundo Halleio Godefridus Guilielmus Leibnitius

Faustissimi itineris voto aliud adderem prompti reditus nisi ex Te intellexissem conclamatarum in Italia Cæsaris rerum indicium fore. Quod absit itineri.

Cras scribam Kirchio, de observatione Cometæ anni 1680. Rmo. Menegatto, ut salutem a me, cum multa perpetui cultus significatione dicas oro.

Incomparabilem Newtonum hortare quæso ut quæ parata habet in publicum dare, diutius ne gravetur. Sin tardat, Te reducens in Angliam comitabor, ut junctis viribus expugnemus restitantem.

Udenariam meam Abjectionem hic adjectam mitto. Vale et fave. Dabam Hanoveræ 14 jul. 1703.

¹ From photostat of original in the Portsmouth Collection, University Library, Cambridge, where there is preserved also a draft, by Newton, of this same letter.

² This and the following letter are from transcripts supplied by Dr. Carl Meyer, librarian, vormals Königliche und Provinzial-bibliothek, Hanover, who has administered the Leibniz manuscripts for the last thirty years (*ante* 1928). See also the following letter from Leibniz to Halley, dated '8 Xbr. 1705'. Accompanying these two letters, in the archives at Hanover, is a note by Leibniz, as follows: 'Abjectio udenaria quæ si novenariæ jungatur difficilior error obrepere potest.' (Private letter to E. F. MacP., 19 July 1928, from Herr W. Linke, Director of the Historical Commission, Hanover.)

D^r Halley

Orbell's buildings in Kensington
March 1st 1725

I thank you for the Table you sent me of the motion of the Comet of 1680 in a Parabolic Orb so as to answer to Kirke's Observations as well as to Flamsteed's. It answers all their Observations well enough for my purpose. But you have omitted the distances of the Comet from the Sun in parts of the mean distance of the earth from the Sun divided into 100000 equal parts: such parts as the latus rectum of this Parabolic Orb consists of 2508. These distances you have computed already in your papers in w^{ch} you calculated this Table, & you need only to copy them from thence. I have inclosed a copy of your Table with a vacant column for these distances, & beg the favour of you to fill it up by inserting these distances out of those your loose papers in w^{ch} you made your calculations of this Table. The distances are inserted in your Table published in the second edition of my Principles pag 459. I intend still to keep that Table & add this new one to it if you please to fill up the column of distances in the same manner that the two Tables may be like one another. And by the help of this new Table I shall be able to make the schemes of the motion of this Comet more perfect. I am

Your humble servant.

Isaac Newton.

15. LEIBNIZ *to* HALLEY.

Celeberrimo Viro Edmundo Halleio Godefridus Guilielmus Leibnitius S. P. D.

Cum Te in mari pacifico sulcos ducere crederem, tutiore loco esse didici libens, gratulorque novum munus. Spero inter juvenes non defore, quibus has quas cogitabas excursiunculas, per aliquot millenas leucas, minore nostro metu mandes; ut tandem magnum Magnetis ænigma Tuo ingenio solutionem debeat.

Quas postulasti observationes Kirchii cometicas accepisses maturius, nisi semel ad me destinatæ perissent. Id serius rescivi: Nunc iterum acceptas Tibi mitto: si quid poterunt lucis afferre impedito argumento gaudebo certe. Interim harum observationum ope viginti et duos cometæ illius dies habebitis, cum antea novendialem tantum habueritis. Nam Monttenariana observatio 17/27 Novembris facta earum quibus Newtonianus calculus innitur prima est, nunc a 4/14 Novembr. cursum inchoare licebit.

Ajunt Te Apollonii librum de sectione rationis hactenus pro deperdito habitum eruisse. Idem ergo et novis das lucem, et antiquis reddis

Idem qui nasci teneris dedit ante Camœnis

Ex orco veteres suscitât Historias.

Sed spero Te facturum imposterum ne ego aliique amici cis mare, qui Te amant et colunt, nimis diu dubitent, utrum in America an in Europa verseris. Vale. Dabam Hanoveræ 8 Xbr. 1705.

16. JEAN BERNOULLI *to* HALLEY.¹

Viro Incomparabili Edmundo Halley, Mathematicum Professori Celeberr. S. P. D. Joh. Bernoulli.

Nescio unde verba depromam in gratiarum actionem Tibi Vir Celeberrime rite solvendam non pro uno beneficio sed pro pluribus quibus una vice me pene obruisti; non contentus enim quod Agnatum meum Te compellare audentem humanissime acceperis, exceptum postea multiplici favore et benevolentia complexus fueris, neque desieris ei benefacere ad abitum usque ejus ex Insula vestra, voluisti præterea splendidi cujusdam muneris vinculo nos devincire, loquor de Apollonii Conicis cura Tua Oxoniæ nuper editis, opere ut audio perquam pretioso et eleganti, cujus exemplar utrique nostrum dono dedisti: quod si hoc commonerem adjungamque reliquis beneficiis partim jam olim mihi, partim Agnato recens collatis, dubito sane an non æternus mansurus sim Debitor Tuus, cum vix ullam sperem occasionem me ab ære hoc in quo Tibi sum liberandi. Hoc equidem ausim promittere, si propensa voluntate qua sum erga Te Tuamque eruditionem exæquari debitum posset, neminem fore ad solvendum promptiorem atque ad mea Tibi officia offerenda æque ac abs Te jussa capessenda paratiorem. In Menelao Tuo qui nunc sub prælo sudat multa contineri audio egregia in Astronomorum usum facientia, interque alia insignem Tuam solutionem problematis de inveniendo puncto Eclipticæ lentissime supra horizontem ascendente. Quod regula mea transformandi curvas atque eas

¹ After photostat of original in Additional MSS. 23102, f. 19, British Museum.

reducendi ad arcus circulares per approximationem pro lubitu continuandam Tuo atque acutissimi Newtoni iudicio, quod mihi est instar omnium, ex omni parte, ut ex litteris Moyvreanis habeo, satisfecerit, mihi valde gratulor; hoc mihi animum addit, methodum totam reliquaue circa motum reptorium inventa fusius describendi atque in specimen dissertationis concinnandi, quam petenti et instiganti cl. Moyvreo submittam cura sua ut promittit juris publici faciendam: propositum exequar quamprimum per otium licuerit. Quod superest Vale, Vir Celeberrime! rei mathematicæ Decus! mihi que favere perge. Dabam Basileæ a.d. ix Kal. Decemb. MDCCLXXII.

APPENDIX V

HALLEY'S LATIN HEXAMETERS PREFIXED TO THE 'PRINCIPIA'

[Reprinted from Rigaud, S. P.: *Essay*. . . , pp. 85-7, Oxford, 1838, with the original notes.]

Halley prefixed to the *Principia* a set of Latin hexameters 'in viri præstantissimi D. Isaaci Newtoni opus hocce mathematico-physicum sæculi gentisque nostræ decus egregium.' There is, at the Royal Society, a copy of an unpublished letter to Valvasor, at the end of which Halley says, 'Quod autem ad . . . carmina spectat, velim tuo utaris arbitrio; corrige, omitte quod tibi videbitur. Si quid dictum sit, quod nomini et honori tuo minus conveniat, quæso, candide interpreteris.' This seems to indicate that he had addressed some verses to Valvasor, but none have been discovered. This is to be regretted; for it may be seen from what he printed with the *Principia* that his powers were not confined to those branches of study, in which he was most eminently distinguished. These lines have been constantly quoted for their appropriate praise of his author; and there can be little doubt of Voltaire having had them in his mind when he wrote the poem addressed to the Marquise du Chastellet, which was printed in the first editions of his *Philosophie de Newton*. Delambre¹ says of them, 'le dernier est,

'Nec fas est propius mortali attingere divos,

éloge que personne n'a taxé d'exagération, et sur lequel Voltaire a peut-être enchéri quand il a dit,

'Confidens du Très-Haut, substances immortelles,
Qui brûlez de ses feux, qui couvrez de vos ailes
Le trône, ou votre Maître est assis parmi vous,
Parlez: du grand Newton n'étiez-vous point jaloux?'

In the *Biographia Britannica*² it is suggested that Halley may have taken the plan of his verses from some, which were addressed by king James the First to Tycho Brahe; but there seems to be little similarity in the two compositions, excepting in the common object of eulogizing discoveries in Astronomy; and the royal author, even if he had in this case been the prototype, could not claim any superiority either in perspicuity or poetry. The text varies in the three editions of the *Principia*. There is in the Bodleian³ library a letter of Keill to

¹ *Histoire de l'Astronomie au dix-huitième siècle*, p. 2. He did not think it necessary to print the second and third lines of Voltaire's verses, but they are inserted here to complete the sentence.

² Vol. iv, p. 2506, note [Y]. Reference is there made to a translation of Halley's verses into English, which is printed in B. Martin's *Misc. Correspondence* (vol. i. p. 4); but it is not well done. Thorpe acted with good taste when he gave the original Latin with his translation of the first book of the *Principia* in 1777.

³ Ballard's Collection, vol. xxiv, No. 16.

Charlett, which contains the following observations: 'Oxford, July 18, 1713. You know there is a new edition of Sir Is. Newton's Principles. Published before them there was a copy of verses of Dr. Halley's, which in the new edition Dr. Bentley has made bold to emend, and alter in several places, without asking his leave. I am of opinion the emendations are not near so good as the original: some of them are intolerable. I will here write you one. Dr. Halley had in the first edition,

... 'Quas dum primordia rerum
Pangeret, omniparens leges violare Creator
Noluit, æternique operis fundamina fixit.'

'Dr. Bentley has turned it thus in the new edition:

... 'et quas dum primordia rerum
Conderet, omnipotens sibi leges ipse Creator
Dixerit; atque operum quæ fundamenta locarit.'

Halley's labour and expense in publishing the *Principia* were freely undertaken, and do not appear to have been considered by him as forming a claim to any right beyond that, which he had of course to the copies which he printed; but the verses were his own exclusive property, and in the third edition most of the original readings were restored.¹ Keill, however, though an able man, had not the varied talents of his brother professor; and, in his eagerness to notice what he thought was wrong, has unfortunately instanced the passage, in which alone Halley retained, in 1726, any thing considerable from the alterations, which had been made without his concurrence. Bentley's conduct, however, was not fair. There could be no competition of scholarship, nor any doubt of his being able to write better Latin than Halley, but every man has a right to determine how his own thoughts shall be expressed: and another person, in his improvement of grammatical precision or elegance of language, can never be secure of preserving the exact sense, which the author meant to convey.

[Reprinted from Brewster's *Newton* (1855), vol. i, pp. 457-9; with the original notes.]

The following is a copy of the verses written by Halley, and prefixed to the First Edition of the *Principia*. In imitation of Professor Rigaud, the original verses are printed in the larger type. The alterations made by Bentley, in the second edition of 1713, are in a smaller type, and the parts between brackets are the alterations adopted in the third edition, published by Pemberton in 1726.

HALLEY'S VERSES PREFIXED TO THE PRINCIPIA.

In
viri præstantissimi
D. ISAACI NEWTONI
opus hocce
mathematico-physicum
sæculi gentisque nostræ decus egregium.

¹ See App. XV. p. 57.

Vel qui curarum lenimen pressit ab Uva;
 Vel qui Niliaca monstravit arundine pictos
 Consociare sonos, oculisque exponere Voces;
 Humanam sortem minus extulit; utpote pauca
 In commune ferens miseræ solatia

[*tantum solamina*]

Respiciens miseræ solummodo commoda vitæ.
 Jam vero Superis convivæ admittimur, alti
 diæ

Jura poli tractare licet, jamque abdita cœcæ

Naturæ, et

Clastra patent Terræ, rerumque¹ immobilis ordo,
 præteritis latuere incognita sæclis.

Et quæ præteriti latuerunt sæcula mundi.
 justis

Talia monstrantem mecum celebrate Camœnis,
 [o *caelicolum gaudentes*]

Vos qui cœlesti gaudetis nectare vesci,
 Newtonum clausi reserantem scrinia Veri
 carum

Newtonum Musis charum, cui pectore puro
 Phœbus adest, totoque incessit Numine mentem:
 Nec fas est propius Mortali attingere Divos.

EDM. HALLEY.

It does not appear on what authority those changes were introduced into the third edition, which did not exist in the two first. It is quite certain that they were made without the authority either of Halley or Newton. It is probable, from the following anecdote, which we found in Conduit's manuscripts, that Pemberton was the author of them.

'Bentley,' says Conduit, 'altered Halley's verses when he printed the *Principia*. Halley told me that Sir Isaac Newton made him hope that in Pemberton's edition his verses would be printed from his own copy, but complained they were not, for he made it—

Æternique operis fundamenta fixit.

And it is printed,

Operumque fundamenta locavit.

And when I said that perhaps Sir Isaac Newton did not care for having anything appear before his book, that seemed to favour the idea that the world was eternal;—"Yes," said he, "that is what Pemberton would fix upon me, but *æternum* is only *æviternum*, and I meant no more."—Conduit's MSS.

¹ que—omitted in 1713, restored in 1726. The parts in italics are alterations, made in the third, though not in the second edition.

APPENDIX VI

ENGLISH VERSIFICATION OF HALLEY'S LATIN HEXAMETERS

A little-known English versification of Halley's hexameters, which according to Rigaud (*Historical Essay*, p. 86, note g) 'is not well done', appeared in Benjamin Martin's *General Magazine of Arts and Sciences*, vol. i, p. 4, London, 1755. The translation is reproduced here, from a photostat supplied by the Library of the Boston Athenæum, Boston, Massachusetts. Dr. J. M. Hoogvliet, of The Hague, in a little note, contributed, in 1910, to *Vragen en Mededeelingen* (Arnhem), I ser., i. 230, made the remark following: 'I never read the Latin text, so am not entitled to judge of the translation as a translation. I cannot help thinking Eugenio's verses in *themselves* quite meritorious, both in melodiousness and clearness.'

An Elogy on Sir Isaac Newton, translated from the Latin of Dr. Halley.

BEhold the regions of the heav'ns survey'd,
And this fair System in the balance weigh'd!
Behold the law, which (when in ruin hurl'd
God out of Chaos call'd the beauteous world)
Th' almighty fix'd, when all things good he saw!
Behold the chaste, inviolable law!
Before us now new scenes unfolded lie,
And heav'n appears expanded to the eye;
Th' illumin'd mind now sees distinctly clear
What pow'r impels each planetary sphere.
Thron'd in the center glows the king of day,
And rules all nature with unbounded sway;
Thro' the vast void his subject planets run,
Whirl'd in their orbits by the regal sun.
What course the dire tremendous comets steer
We know, nor wonder at their prone career;
Why silver Phœbe, meek-ey'd queen of night,
Now slackens, now precipitates her flight;
Why, scan'd by no astronomers of yore,
She yielded not to calculation's pow'r;
Why the Node's motions retrograde we call,
And why the Apsides progressional.
Hence too we learn, with what proportion'd force
The moon impels, erroneous in her course,
The refluent main: as waves on waves succeed,
On the bleak beach they toss the sea-green weed,
Now bare the dangers of th' engulfing sand,

HALLEIANA

Now swelling high roll foaming on the strand.
 What puzzling school-men sought so long in vain,
 See cloud-dispelling Mathesis explain!
 O highly blest, to whom kind fate has given
 Minds to expatiate in the fields of heaven,
 All doubts are clear'd, all errors done away,
 And truth breaks on them in a blaze of day.
 Awake, ye sons of men, arise! exclude
 Far from your breasts all low solicitude;
 Learn hence the mind's ætherial pow'rs to trace,
 Exalted high above the brutal race.
 Ev'n those fam'd chiefs who human life refin'd
 By wholesome laws, the fathers of mankind;
 Or they who first societies immur'd
 In cities, and from violence secur'd;
 They who with Ceres' gifts the nations blest,
 Or from the grape delicious nectar prest;
 They who first taught th' hieroglyphic stile
 On smooth¹ papyrus, native plant of Nile,
 (For literary elements renown'd)
 And made the eye an arbiter of sound;
 All these, tho' men of deathless fame, we find
 Have less advanc'd the good of human-kind:
 Their schemes were founded on a narrower plan,
 Replete with few emoluments to man.
 But now, admitted guests in heav'n, we rove
 Free and familiar in the realms above;
 The wonders hidden deep in earth below,
 And nature's laws, before conceal'd, we know.
 Lend me your aid, ye bright superior pow'rs,
 That live embosom'd in Elysian bow'rs,
 Lend your sweet voice to warble Newton's praise,
 Who searcht out truth thro' all her mystic maze,
 Newton, by every fav'ring muse inspir'd,
 With all Apollo's radiations fir'd;
 Newton, that reach'd th' insuperable line,
 The nice barrier 'twixt human and divine.

EUGENIO.

¹ An Egyptian plant, growing in the marshy places near the banks of the Nile, on the leaves of which the antients used to write. [Original note.]

APPENDIX VII

PRESENTATION OF THE 'PRINCIPIA' TO KING JAMES II

[Reprinted, with the original notes, from Rigaud, S. P.: *Historical Essay on the First Publication of Sir Isaac Newton's Principia*, pp. 87–8, Oxford, 1838. The subjoined 'Remarks' were added by the present editor.]

In 1687, and probably as soon as the *Principia* was ready for publication, a copy of it was presented to king James the Second,* accompanied by a paper, in which Halley gave a general account of the book, and more particularly explained the doctrine of the tides, as deduced by Newton from the effects of gravitation: this subject being chosen as one, which was most likely to interest the king, who had been lord high admiral, and had commanded the British fleet in the war with the United Provinces. It would seem, that the presentation was made at some special meeting which had been appointed for that purpose. Halley in the conclusion of his dissertation makes an offer of further explanation, if there should be occasion for it, and 'if your Majesty shall please to suffer me to be admitted to your presence.' This, at first sight, seems to imply that he was not at the time in the situation to which he alludes, but it may only be a courtly phrase, which is not to be construed with so much rigour. The paper was printed separately,† but it was afterwards introduced into the Philosophical Transactions for 1697.‡ The beginning and ending were omitted,§ and an apology was thought necessary, for this reprint, by Sloane who was the editor of the volume: he derived it from the tract having been well received, and being calculated for usefulness from its popular view of the subject.

* The Royal Society had then been established little more than twenty years; and Newton describes it, in his Dedication of the *Principia*, 'a serenissimo rege Carolo II. ad philosophiam promovendam fundata, et auspiciis potentissimi monarchæ Jacobi II. florenti.' In the second edition the expression is varied to 'auspiciis Augustissimæ Reginæ Annæ,' and Newton presented it to her on Monday, the 27th of July, 1713. (See Baily's Account of Flamsteed, pp. 98 and 229.) In the third edition the words are, 'serenissimi regis Georgii.'

† There is a copy in the British Museum: it has no titlepage.

‡ Vol. xix. p. 445.

§ The original tract is very scarce; and the omissions have been therefore reprinted in the Appendix, No. XXII. p. 77.

Remarks: The *Principia* was given to the public in June, 1687.¹ Halley sent twenty copies to Newton at Cambridge, 5 July 1687.²

Not long previously, King James II had had a controversy with the authorities of the Universities of Oxford and Cambridge, successively.³ In fact, so late as 7 May 1687, eight delegates from the University of Cambridge, of whom Newton was one, appeared before the notorious Lord Chancellor Jeffreys, at London.⁴

¹ Brewster's *Newton* (ed. 1855), vol. ii, p. 110.

² *Ibid.*, p. 111.

³ *Encyc. Brit.*, 11th ed., vol. xix, p. 588, Cambridge, 1911.

⁴ *Ibid.*

APPENDIX VIII

EXTRACTS REFERRING TO HALLEY FROM THE JOURNAL BOOKS OF THE ROYAL SOCIETY

Thomas Birch's *History of the Royal Society*,¹ reproduces the contents of the 'Journal Book' of the Society down to December 1687. In the third and fourth volumes there are numerous entries relating to Halley, some of which are quoted or cited elsewhere in the present collection.

The Journal Books for the period 1688, where Birch ends, to 1696, when Halley's clerkship practically ended, have been examined by Mr. H. W. Robinson, who made the extracts that follow. As remarked by him, one is 'astonished at the variety of subjects dealt with and the interesting details they contain, which give an entirely broader view of Halley's interests and outlook upon scientific endeavours and his general inquiries after knowledge from all points of view'. The extracts are reproduced detached from the context.

January 11, 1687/8. Halley produced a Figure whereby he shewed that from the severall cases of the Intersection of a Circle and a Parabola, he could determine the number of Roots in any Cubick or Biquadratick Equation how-ever affected, as also the Limits of the same.

The Same shewed the Construction of a new sort of Thermometer designed to shew the Quantity of the Evaporation of Liquors occasioned by heat, which he supposed might be more proportionate to the degree of Heat, than the Expansions and Contractions of Spirit of Wine, which seem only to librate between certain limits. He submitted the whole to the Examination of the Society.

January 18, 1687/8. As to Halley's new Thermometer Sr. J. Hoskins was of opinion that more than a double heat was requisite to evaporate a double quantity of water.

Halley burnt some grains of Cochinell in the flame of the Candle, and by the smell it was judged by all present to be an Animall and no vegetable substance. Animall substances yeilding a smell like Horn or hair when burnt, which was allowed to be a good Criterion to distinguish those substances in dubious cases.

February 1, 1687/8. Halley read part of a Treatise published in French about Barometers, Thermometers and Hygrosopes.

Mr. Halley read a paper of his own about the alteration of the Poles of the Earth, tending to prove that if there be any such change, it must needs be very slow: for comparing the observations of Bernard Walther made Anno 1487 with those of Mr. Wurtzelbaur made at Nurenburg anno 1686, the latitude and distance of the Tropicks is found exactly the same. And the latitude of Alexandria determined by Eratosthenes about 250 years before Christ was lately viz. anno 1638 found nearly the same by Mr. Greaves, whence he con-

¹ Four volumes, London, 1756/7 (no index).

cluded that so graduall a motion of the Poles could not account for the Phaenomena of the Universall Deluge.

February 8, 1687/8. Mr. Halley related that in the Island of St. Helena there was a sort of Adiantum, which bore perfect plants with a root on the Extremities of its leaves, and those sometimes will have others or Grandchild plants (if such an expression may be allowed) growing out of their leaves; and that when the parent plant decays, the young ones fall to the ground and there take root, and so shift for themselves.

February 29, 1687/8. Halley related a curious observation he received from Mr. Watts who keeps the Physick Garden at Chelsea, viz: that a Bell-glass being whelmed over a plant and pressed down hard that there shall be very little if any communication with the outward air, the plant shall notwithstanding grow and thrive rather better; but if so be a brown paper or any non-transparent thing be pasted on the same glass, the plant shall turn white and wither, and in a little time die, whence he conceived it was necessary to the maintenance of vegetable life that light should be admitted to the Plant.

Halley proposed an experiment to examine this,—whether it be really the Light or some other aetheriall substance, that only passes the pores of transparent bodies: viz by covering a Plant all the day time with an opaque bell, and when it was dark, by a transparent one, for in that case it would appear whether the Light was requisite or no.

March 14, 1687/8. Halley produced an account of some experiments by him made to ascertain the quantity of the dilatation of fluids by heat, the tryalls being made with fair water, spirit of wine and mercury. And it was found that water boyling to the highest degree, was a twenty sixt part lighter than cold water. Spirit of Wine did augment a $1/12$ part by heating, but would not bear a boyling heat without emitting so great a quantity of bubbles that the experiment could not be made beyond a certain degree, for the bubbles engendred on the bottom of the vessell rose so bigg and fast, as to make the whole bulk sensibly to swell and when those bubbles were gone the Liquor would subside again. Mercury with a strong boyling heat, was found to swell a $1/74$ th part or about a third part of the augmentation of water. It was remarkable that the mercury did rise with a very gentle heat at first, whereas the water did not swell considerably till it was near scalding hott.

March 28, 1688. Halley read a discourse of his own showing how to account for the Variations, which the diversity of the Airs pressure will occasion in the Thermometers wch are made upon the principle of the contraction and dilatation of the Air, proposing that this sort of Thermometer thus rectified would be much nicer and more intelligible than those now in use, and promising to show a construction of such an Instrument at the next day.

April 11, 1688. Halley read a discourse concerning the construction and graduation of a Thermometer to show the degrees of heat and cold by the dilatation and contraction of the Air. He proposed the beginning of the divisions to be obtained from the temper of a subterranean Grotto where neither the heat of the sun nor cold air doe penetrate, as has been found by experiment; and having found by triall that the contraction and dilatation of the air between

extreme heat and cold is about a tenth part of its bulk, he contrives his cane to hold somewhat more than a tenth part of the ball, and divides the same into 20 equall parts in respect of solidity, beginning from the mark of Temperature before found, thereby exhibiting 10 degrees of heat and cold, which will be intelligible, for that they express, how much the Air is more or less expanded than in a Temperature, and by this rule all Thermometers may be made to agree as well as if adjusted by a standard. He showed likewise the experiment of making water or mercury stand at any hight assigned, by leaving a quantity of Air in the head of the cane; which did exactly answer his expectation, scarce missing the breadth of a thred.

April 25, 1688. Halley read a discourse being an attempt to explicate the rising of vapours out of water; showing that if the particles of fluids might be supposed to be infinitely little bubbles whose cavity might be supposed a very refined matter next to vacuity, that those parts might from severall causes, particularly heat, be blown up and distended so as to have their specifick gravity very considerably altered; whence he conceived that the rising of vapour out of water into the air might in some measure be rendered intelligible: for that otherwise the difficulty would seem insuperable to explain how any matter 800 times heavier should be imbibed, elevated and sustained in any fluid.

May 2, 1688. Halley promised against the next meeting to have a discourse ready, concerning the true state of that famous problem of finding the Longitude.

May 9, 1688. Halley said that in summer time, when there blows a N.East wind for any continuance, it is found to make the Town of Greenwich very unhealthy and subject to agues, which he conceived to proceed from the vapours, which those winds coming over the marshes on both sides the River, bring along with them.

Halley read a discourse of his own concerning the Longitude, being a full state of the case of that most famous problem, wherein he reckoned up the severall methods that have hitherto been used to discover it showing the conveniencys and inconveniencys of each of them, and in what they are deficient. He concluded that it would be scarce possible ever to find the Longitude at sea sufficient for sea uses, till such time as the Lunar Theory be fully perfected.

May 16, 1688. Halley read a paper of his own being the description of an instrument easy to be procured, but yet of sufficient exactness to observe the Longitude by the means of a Pendulum clock, which he proposed to be of excellent use to rectify Geography, requiring no more skill than any person, how little soever Mathematicall, may easily attain.

June 13, 1688. Halley said that the port of Winchelsea, by some such means, has been deserted by the sea, which having been heretofore a good sea-port town was now above the high-water mark.

July 4, 1688. Halley read a discourse of his concerning the equation of time wherein he shewed the severall forms thereof according to the severall Astronomers, some whereof make the diurnall revolutions in equal times about the axis, others making them unequal, some on one account, some on another, all which he considered as in a Synopsis, concluding that the inequalities attributed to the

Earths revolutions were really in the Moons motion, and the returns of the Meridian to the same fixt starr are precisely equall. In conclusion he shewed the effect of this Hypothesis upon pendulum clocks, and how to adjust them so as always to answer to the mean or equall time.

The same shewed the proportion of the Ounce Troy to the Ounce Avoir du poize to be as 73 to 80 or 94 to 103 and the pound Troy to the pound Avoirdupoize as 60 to 73 or as 83 to 101 whence the Ounce Avoirdupoize is nearest 438 grains. Hence the cube of the London foot in water weighing 76 lbs Troy and the cube of the French foot having been found to contain 69 lbs 12 ozs. of the French weights, he deduced the proportion of the pound Avoirdupoize to the French pound as 35 to 38. The French ounce to be 475 grains or to the Troy ounce as 95 to 96, but the Grain at Paris to be to ours as 19 to 23.

The Roman Congius he concluded, (from its holding 10 lbs Roman of water or 120 ozs avoir du poize, and from its being $\frac{2}{15}$ of the cube of the Roman foot, as Mr. Greaves has observed), to contain $207\frac{1}{2}$ London cube inches, wherof the standard wine-gallon pott at Guild-hall holds 224 such inches, tho vulgarly reputed 231. Hence the Amphora = 8 Congii holds 1660 inches; the Sextarius = $\frac{1}{6}$ Congii but 35 inches, and the Modius aequall to 16 Sextarii or $\frac{8}{3}$ of the Congius holds 554 Cube inches or a Peck London measure praecisely.

August 1, 1688. Halley produced severall shells found in Harwich¹ cliff by himself, about 90 foot above the surface of the sea in a bed of them at least two foot thick, wch run in an oblique ascent very slowly rising for all ye length of the Cliff, which seemed to demonstrate that that bedd had once been the bottom of the sea, notwithstanding its being so much above it now. This bedd was on the topp covered with another of Gravell and Earth mixed with stones, for the thickness of ten foot, where was the top of the Cliff.

The same read a discourse of his own containing the severall popular arguments whereby the diurnall Motion of the Earth is evinced, without entring on the Mathematicall, which requiring a full knowledge of Astronomicall Terms cannot so easily be apprehended.

November 7, 1688. Halley was ordered to see if he could make a bargain with Mr. Smith the Bookseller for a considerable parcell of the Book de Piscibus, the praemium already allowed being supposed too small to engage the Booksellers to undertake to dispose of them.²

January 16, 1688/9. Halley gave an account of the cure of a Tetter by a certain Liquor or Oyle drawn from a stick of Genista or Broom, being a condensation of the smoak thereof. Of this he said he had seen the experience, and believed that it was a perfect cure; for that it seemed not so much to dric it up, as to correct the Vice of the Skin; since that upon the first application the

¹ This reference to Harwich may imply that Halley had visited Holland. He may have had occasion to confer with Huygens or other Dutch scholars, or, perhaps, conduct some negotiations for the Royal Society.

² Samuel Smith, printer and bookseller, at the Prince's Arms in St. Paul's Churchyard, London.

humour does not abate, but sensibly encreases; tho after some repetitions the Skin become perfectly whole.

February 6, 1688/9. Halley observed that the large horse Muscle found in fresh waters did use to walk upon its shells as with Leggs and that he had seen their tracks on the Mudd.

[NOTE: All the above entries are in the handwriting of Halley. Now follows another hand.]

February 13, 1688/9. Mr. Hally read a Discourse wherein he shewed the severall species of infinite quantity; where besides infinite length and infinite surface or area, he proved that there are three sorts of infinite solidity, each of which are infinitely greater the one, than the other, and have no more proportion or relation than there is between a line, a plane and a solid, or between a finite magnitude, and an infinite, yet that all magnitudes infinite in the same degree, are assignable in proportions to one another; These 3 species arising from the infinity of one, two, or else all three dimensions, which latter is the abyse or infinitum of space, and which is properly called infinite. To this was shewn the proportion which the Solids of Cones, Pyramids, &c infinitely extended do bear.

March 6, 1688/9. Halley read a Paper of his own concerning a diving Engine, which he had contrived so as to be moveable by the person that should goe under water, and yet contain Air enough for a Man to be a very considerable time under water; Which was by putting a pair of weighty wheeles under a Diving Bell of a considerable capacity so as the weight of the whole might be nearly aequiponderate with water, and according to the depth intended a quantity of compressed Air in Vessells to be carried down so as to drive out the water, whereby a Man might have his Bell as a house over his head, and stand on the bottom almost drie.

March 13, 1688/9. Halley was ordered to inform himself (if it might be) of the Contrivance of the pulling Clocks and Watches that repeat and strike the hour and quarter, which he undertook to do against the next day.

March 20, 1688/9. Halley having been ordered to endeavour to obtaine the secret of the Repeating Clocks that strick the hour, and quarter, reported that the Principall contrivance was in a wheel on which there were twelve teeth set in a Spirall commonly call'd Archimedes Spirall; of which he gave the figure, but said that he was promised to be shewn the whole matter, when his friend had occasion to put one of these watches together.

Halley read a Latin Letter he had drawn up to be sent with 30 of the books of Sr. Malpighius,¹ as a present to the Author, which was ordered to be sent forthwith.

May 1, 1689. Halley described the Polypus of St. Helena, which emits such an Inky Juice, but of a dark russet colour. This fish, called there a Cuttfish, will walk on the dry land, on its points, as it were with Leggs, raising itselfe like a great long leggd spider, and being pursued he makes to the water, where immediately he reciprocates by a motion not unlike respiration, the water

¹ The book was Malpighi's tract *De Glandularum Structura*, ordered to be printed Dec. 4, 1688.

through a glandulous substance in his body, whereby the water becomes troubled, and opake but if so be this will not secure him, he will stick so fast to the rocks by the means of severall acetabula on his points, or leggs, that he will be torn in pieces before he will let go his hold.

Halley related the manner of keeping flounders all the year long for sale in corfs in the salt-marshes on the sea coasts, but that they will not breed by reason of the muddy or ousey bottome, which destroyeth the spawn.

May 15, 1689. Halley read an account of the experiment to examine, whether Sea-Salt and Sal Gemmæ were specifically different, viz, that having sated a quantity of water with ordinary salt; so as that it would imbibe or dissolve no more, he had found that a piece of Sal Gemmæ of an ounce and half had continued suspended in the solution for near 3 hours without loosing one single grain of its weight; whence it was reasonable to argue, that there is no specificall difference between the Sea-Salt, and Sal-gemmæ by the way it was observed, that the water which weighed $357\frac{1}{2}$ grains and half had imbibed 77 grains of salt, and would take no more.

May 29, 1689. Halley reported that in an accurate triall he had found, that a solution of $\frac{1}{4}$ part of Sea-salt in water beares proportion to water as 33 to 29. that Sal Gemm. by triall on 3 severall pieces seemingly of different texture, was in specifick gravity as to water as 17 to 8. whence that solution ought to be to water as 85 to 76; whereas it was found as 85 to $73\frac{1}{2}$ or as 33 to 29. Whence it must be argued that either there is a penetration of some part of the salt into the water, or else that the specifick gravity of salt in flour, or when dissolved, is near half as heavy again as that of sal Gemmæ after the same manner, as water is much heavier than ice; but whether this be enough to solve so great a disproportion may meritt consideration.

June 12, 1689. Halley related the manner of the first generation of the atoms of salt, having carefully viewed them in a Microscope, as they coagulated out of water, viz, that when they first begin to appear out of the liquour, the figures are exactly square, and all of a magnitude; that the edges of the square are first coagulated, whilst the insides continue fluid.

The same said, that having made a strong solution of Nitre and lett it stand, he had observed that the Nitre shott as by a kind of vegetation out of and above the water, and that at first it rose on the sides of the glass, which was not full by an inch, up to the very top; and after it proceeded to emitt branches, resembling those of trees; which stood up for half an inch high on the top of the glass all round. It was queried how this could come to pass, or whether it could be conceived to be performed by filtration.

July 3, 1689. Halley produced his Sea-draught of the Mouth of the River of Thames, wherein he saith, that he hath corrected severall very great, and considerable faults in all our Sea-Carts hitherto published.

July 10, 1689. Halley related the Demands & Proposals of a certain Person for recovering the Goodwin Sands, or any other Sands, that Ebb dry. Particularly that he would undertake to build a Light-house on the tayle of the Goodwin, that he talked of the Modell of an Engine for doing it, but kept his contrivance wholly conceal'd.

Halley shewed again the Experiment of the Mixture of Sal-Gemmæ and water to shew evidently the Penetration of the Salt into the water. And the salt being putt in dry into the neck of the Bolt-head, the water was found to subside gradually as the Salt melted and $5\frac{5}{16}$ ozs of salt-gemm. being equall in bulk to $2\frac{1}{2}$ ozs of water, being dissolved in about 3 lbs of water the space in the can filled by $2\frac{1}{2}$ of water was found but filled with $5\frac{5}{16}$ of Sal-Gemm after it was fully dissolved.

July 17, 1689. Halley said that in blowing up houses, or any other great explosion of Gun-powder the windows near adjoining are not blown inwards into the houses, as is generally supposed, but alwaies outward into the street, of which he assigned the reason that the air being rarified and consumed by the flame, the pressure of that in the rooms of houses exceeding that in the street, the windows come to be thrust out thereby.

July 24, 1689. Halley said, that before the late great frost, he having used to water Rosemary, and other tender plants with soap suds much diluted, and only a little blewish with soap, he found that these plants throve well, and bore the hard winter better than in other gardens. This was thought to be a very proper meane for the earth by reason of the oyle and alchaly-salt in soape, but what degree of salt was proper in this case was a question not easy to determine.

Halley observed, that there is not one Tree to be seen in all the Island of Foulness. The reason, why Trees would not grow in Canvey and Foulness, was conceiv'd to be from the openness of the county to the sea winds, together with the looseness of the Isle, but that the difficulty to produce grains at the first recovery of the land was from the abundance of salt left in the Earth.

October 16, 1689. Halley produced a piece of rich silver oar from Potosi, that weighing 37 ounces was almost all pure Silver, which needs no other refining, but onely to be beaten to powder, and then mixing it wth Quicksilver, the impurities are thorough separated, there being no other Metall admitted.

The same read a Paper of his own concerning a Computation he had made of the thickness of the Gold, that covers the best guilt wire, which is made of one part of gold to 48 of silver, and the fineness such that 2 yards weigh but one grain, whence he calculated from the given Specifick Gravities of the two Metalls viz Silver $10\frac{1}{3}$ and Gold $18\frac{2}{3}$, that the Diameter of the wire was but the $\frac{1}{386}$ part of an inch, and the thickness of ye Gold but the $\frac{1}{134560}$ part of an inch, and the 100000th. part of a grain of Gold visible. Whence he concluded, that if Gold be supposed to consist of Atoms that are not to be compressed, that those particles are necessarily less than the $\frac{1}{2433000000}$ part of the cube of the hundred part of an inch, and probably many times lesser, if the united surface of the Gold without Pores or Interstices be considered.

He likewise gave an account of the last great Eclipse of the Moon, which hapned September 19th. after Midnight; that he had foreseen by calculation all the Phases thereof within 2 or 3 Minutes of time, from which he concluded two things, which he was enabled to doe by the help of the Eclipse, that was observed on September ye 8th. 1671. First that the whole course of the Moon is regular for the said intervall of 18 years and 11 days, and that in all parts of that period, if the Motion of the Moon were exactly observed, it might be for

the future predicted by a Calculus that would be sufficient to find the Longitude at Sea.

October 30, 1689. Halley read a Paper of his own concerning the Experiments he had made about the Specifick gravities of the severall sorts of Salt. Which by severall repeated trialls he had found to be Sal Armoniac to Water as $14\frac{1}{2}$ to 10. Allom and Borax as 12 to 7. Niter as 19 to 10. Sal Gemmae as 15 to 7. Blew vitriol as 13 to 6.

November 13, 1689. Halley said, that by comparing severall distances of places now well known from Astronomicall observation, he had found, that the Miles in the Itinerary of Antoninus are very short, not exceeding the 100th part of a degree, and that so reduced the distances there laid down might be of good use to rectifie things both in the Ancient and modern Geography.

November 27, 1689. Halley said the way that Poultrers¹ knew, whether wild-fowl is fresh, or no, is by the foot, for they conclude, that the foot being dry it is certain, they are stale, if not, they are esteemed fresh.

January 15, 1689/90. Halley haveing occasionally said, that he took it to be very clear from Caesar's Commentarys, that Julius Caesar landed in the Downs, he was ordered to bring in against the next day an account of that matter.

January 22, 1689/90. Halley read a Discourse tending to prove, that Julius Caesar first landed in Britain Anno 55 ante Christum on August 26th in the afternoon to the Northward of the South forland and in all probability in the Downs near the place, where now the Town of Deale stands: this he made out by the description given of this Expedition in Caesar's Commentarys, and by Dion Cassius in his 39th. book.²

January 29, 1689/90. Halley related some thing like this, to have befallen himself, in takeing a large Dose of Theriaca Andromachi, wherein he believed the Opium not to have been well mixed; for instead of sleep, which he did design to procure by it, he lay waking all night, not as if disquiet with any thoughts but in a state of indolence, and perfectly at ease, in whatsoever posture he lay.

February 5, 1689/90. Halley related, that in the Barbadoes they had formerly made their Hedges or Fences with the prickle-pair or Indian Figg, which by their thickness, and long prickles were not to be attempted by Hogs or any sort of cattle.

February 12, 1689/90. Halley read a Discourse concerning the Method used by nature to return the Copious Vapours raised out of the Sea by the Action of the Sun again into it, this he supposed was performed 3 waies partly by the fall of the Vapours upon the Cool of the night into the Sea itself in Dews or else in rains: 2dly. by the Rivers, which he shewed to owe their rise to these

¹ By the marriage of a first cousin, in 1696, Halley became related to some Poulterers with whom he may have been previously acquainted. (Cf. *Notes and Queries*, 10th series, vol. viii, pp. 44-5; *ibid.*, 11th series, vol. ii, p. 45; *ibid.*, vol. cliv, p. 214.)

² See *Philos. Trans.*, 1691, vol. xvii, p. 495; or Hutton's *Abr.*, 1809, vol. iii, p. 438. The subject of Caesar's landing-place is further discussed in *Archæologia*, vol. xxxiv, 238; Hasted, Edward: *History of Kent*, vol. i, pp. viii-xi et seq., Canterbury, 1778; Cardwell, Rev. E., in *Archæologia Cantiana*, vol. iii, pp. 1-18, London: Kent Archæological Society, 1860.

vapours brought by the winds to the topps of the high ridges of Mountains, where they are condensed into water, and lastly by severall intermediate falls on the Earth and rising again in Vapour, till at length they come either to the Mountains, or else fall in Vapours in the Sea.

February 26, 1689/90. Halley read a Discourse, shewing that the power of the Suns heat being in the proportion of the Sines of the Altitude, it would follow, that the whole action of the Tropicall Sun in 24 hours at the Pole, where he runs round the Horizon at the height of $23\frac{1}{2}$ degrees, was considerably greater, taken in one summ, than that of the Sunn under the Equinoctiall, when he comes verticall rising, and setting at 6. Promising against the next day, to give a generall solution of the problem of collecting the Sum of all the Sines of the Suns Altitude in an oblique sphaere to any Latitude and declination given.

March 5, 1689/90. Halley shewed the Rule of collecting the whole action of the Sun, in any declination and Latitude given, which he was ordered to bring in in writing against the next meeting.

March 19, 1689/90. Mr. Halley read his account of the Rule for collecting the Heat of the Sun in any Latitude, and at any Declination given, either for the whole day or any part thereof; by bringing it to the Probleme of finding the Surface of a Cylindrick hoof [*sic*] or any part thereof.

March 26, 1689/90. Halley presented to the consideration of the Society some queries, which he conceived to containe the principall difficulties, that are found in our Theorys of Light Pellucidity, and Refraction.

June 4, 1690. Halley said, that Hurricanes are found in the Latitude of the Caribbe Islands in many parts of the World, as in the Bay of Bengall and in the China-Seas; and that the time of these storms is generally in the latter end of August or September soon after the return of the Sun over the Zenith of these places. The like observed about the Mauritius Island, and the Southpart of St. Laurens, where those Storms are observed in January, or February, and at no other time.

The same said, that Chalk, as he had been told, would prevent Ants from climbing up Trees, for that the small Atoms of Chalk, adhering very little to the Tree, would fall off with the feet of the Ants, so that they could not pass the place so covered with Chalk.

Halley shewed a proposition of great use, as he conceived, for saving of powder in the casting of Bombs into a place, that is either higher or lower than the gunn, and besides more certain, viz by placing the Line of Direction of the chase of the piece, so as to divide equally the angle betwixt the Object and the Zenith into two parts, for that in that case the ball would be cast farthest on the line tending to the Object with the same charge, and the distance of the Object being given, he shewed how to find the charge of powder necessary by the following analogy as the Radius to the Tangent of the Angle of Elevation of the piece, so the Horizontal Distance of the Object, to the Distance the Charge required would hit on the Horizon, when the piece is elevated to 45 degrees: Which being found, and the Gunner having a Table of the Charge of powder requisite to Shoot the so found distance, on the Horizon, when his piece is elevated 45 gr., will be able to make therewith his shott at

the Tower or Castle entended, and that with the greater certainty, for that 4 or 5 Degrees of Elevation will make in this case no sensible difference in the fall of the shott. He shewed likewise that as Projections made on the plan of the Horizon equally distant in Elevation above or below 45 degrees, would hitt the same Object, so in this case of Objects above, and below the Horizon the two Elevations, that would strike the same mark, are equally distant above and below the line, that bisects the Angle at the Gun between the Zenith, and the said mark.

July 2, 1690. Halley related that he had observed in Guienne, and Langvedoc, that to the westward of Carcasson no Olive Trees will thrive, which seemd to be occasion'd by the Pyrenean Mountains, being to the Southward, and by their great height chilling the Air, that is brought by the Southerly winds, whereas to the Eastward, where the Southwind comes immediately from the Mediterranean Sea, the Olives thrive well, and the Country is much hotter.

The same said, that the fitness of the shott to the bore of a piece was of great consequence in Gunnery, that he was well assured, that, by observing this, more powder might be saved, than would pay for the turning our great cannon shott, that another great advantage arising from it was that a shott would be made with much more certainty, and a third, that Gunns need neither to be so long or so weighty as are now in use and yet do the same, or more execution, which is of exceeding use for the ease of Carriage of Artillery by land, & for to ease the sides of shippes at Sea. To confirm this he said he had often seen a brass shott of 14 lb weight cast by 2 ounces of powder from a barrell about 10 inches deep, above 550 yards; which could not have been unless the shott had been truely fitted to the bore.

July 23, 1690. Halley produced a Pocket book of his wherein among other Mathematicall things there is long since written a proposition lately published in the Acta Lipsiensia as new by one Mr. Bernoulli, who values himself upon the Invention: The proposition is, that the Parameter, or latus rectum of any Conick Section is alwaies equall to the Diameter of ye Circular base of the Cone cutt at the same perpendicular Distance from the apex thereof, whence it is, that all Conick Sections passing at the same distance from the Apex have the same latus rectum.

October 15, 1690. Mr. Halley produced two pieces of the Asbestos stone from Cyprus, which he was told was of a considerable staple so as to be well spunn. It being beaten was found of a much finer filament than any of those formerly shewn before the Society.

Mr. Halley produced the Mathesis Eucleata of Sturmius, being a concise Treatise of Geometrie.

The same shewed a Book of Mr. Kirk in High-Dutch,¹ about the great Comet, which appeard in Novembr. 80 and 81. This he observed ten days sooner, than any of our Astronomers, and Novembr ye 4th in the morning found it about the beginning of Virgo with about a degree of North Latitude.

The same shewed an accurate Draught of the Situation of Limrick in Ireland taken at the time, when it was besieged by the Parliament's forces in 1652.

¹ See p. 234, note 1.

Mr. Halley likewise produced two Geometricall Propositions for shewing the Focus of all rais Parallell to the Axis falling either on the plain or convex-side of a plane-convex lens, these Mr. Hook said he had formerly shewn the Society in the year 1681, and the Journal of that year being turned to, it was found that he had performed some such thing, but the Demonstration and schemes were wanting.

Halley shewed also a Compendious Method of finding the respective foci of Rais inclined to the Axis as proceeding from a near point; the former of these being of use in Telescopes, and the Latter in the Construction of Double Microscopes.

The same presented the R. Society from Mr. Jedd a peice of an Elephants tooth, wherein there was lodged a leaden bullet, it had been long in it, and the hole was grown upp, so that the lead was perfectly encompassed by the Ivory, but the wound had altered the Texture of the Ivory, and the tooth was grown hollow, or rotten.

October 22, 1690. Halley related, that he had been credibly informed, that Stronbolo one of the Isles of Lipara blows up every quarter of an hour night and day with a great noise, and casting out fire, and red hot stones which seemes to intimate somewhat of the manner of the Explosions occasioning Earth-quakes.

October 29, 1690. Mr. Halley read a Paper of his concerning a Method of makeing observation for determining the Longitude: by placing a Circle accurately turned in the focus of the glass, and noting the entrance, and exit of the Moon and a Star whereby the Difference of Rt. Ascension of the Moon and star are exactly determined.

November 5, 1690. Halley observed, that the Thames rising in Low grounds has as [*sic*] great fall, and consequently carries with it but a small quantity of Earth. Whence the flat low Lands at the Mouth thereof are not very considerable; whereas ye Rhine, ye Rosne, the Danube &c rising in Hilly Countries by their falls, and rapidity carry down proportionably much more Earth, than the Thames, whence came those great flats or plains at the mouth of their Rivers.

Halley said, that he had seen a peice of Lough Neagh petrified wood burn and flame, which Sir John H. supposed to be for yt the wood remained in some measure in it, and the petrifying juice resisting burning the woody-fibres only flame. And the like he supposed for the Inverness Stone, wherein the unctious or inflammable parts only burn away, while the Figure of the Stone remains entire.

Halley shewed the Experiment of a Magneticall Cart swimming on the surface of water, the Paile being turned round with a quick Motion did not alter the position of the Cart at first, but it was doubted whether this by the various interruptions a Ship meets with from the waves would do better, than the ordinary Compass, especially considering the opposition the Cart meets with from the contact of so much water.

December 17, 1690. Halley proposed, that the blood of Animalls, that freeze, and revive again, may be of such a sort of substance, that does not expand itself

upon glaciation analogous to oyle or waxie matters, which are found always to contract themselves with cold.

Halley said, that he being at Portsmouth the day before the late great Tide on the 9th Instant, observed, that the wind blew there very hard at West, whereas in the Eastern Seas it was then NW. Whence the water was accumulated and brought in by both winds aiding the Flood, and resisting the Ebb, and he supposed, that we should hear news of damages done on the Coast of Holland & Flanders.

The same observed, that Firr, and Birch are the woods, that bear frost above all others, and therefore are almost the only woods found in Norway and Iceland.

December 31, 1690. Halley said, that the force of the wind to give such a velocity as 7 German miles in an hour, is so great, that the Air itself is hardly in the violentest Storm impelled with a greater swiftnes, whence it seemed hardly credible that this Chariot should move twice as fast, as the swiftest motion of a Ship.

January 7, 1690/1. Halley shewed many Instances of the Congruity of the Numbers in the Itinerary of Antoninus for Britain with those of the late Survey of Ogilby, whence he concluded, that the said Itinerary might be of good use to correct and ascertain even the present Geography of other Countries, as to the places which are still known, and retain their names: And that the measures there set down however some of them may be corrupted or omitted are generally true, and were observed by an actual Survey.

January 14, 1690/1. Mr. Halley produced his Map of ancient Brittain, According to the Itinerary of Antoninus, and Ptolomeus's Geography.

January 21, 1690/1. Halley shewed the Experiment of the Refraction of a Diamond by finding two points perpendicular to two of the little plains by help of the reflection of a Candle, by which he had the Angle of the Inclination of those plains, then placing a Candle perpendicular to that plain, that was remotest from the Object, and observing the refracted species of the Candle, he had the Angles of incidence on both places, and the Sum of the Refracted angles, by which Method he found the ratio of the Sinus to be as 1000 to 408 or nearly as 5 to two, whence he concluded, that a Diamond would be the most proper Material to make a Microscope withall, it gathering the beams at a third part of the distance of a glass of the same figure, & consequently magnifies 3 times as much.

January 28, 1690/1. Halley read a Paper of his own concerning the Experiment he shewed the last day of the Refraction of a Diamond, and giving an account of severall others he had made in other bodies in order to trie, if there could be any proportion found to determine, wherein the opposition, the rays of light meet with, and which causes refraction consists. And having found out a green past, or artificiall glass, that was near double the weight of a Diamond being about 6 times its weight in water, yet found to have a less refraction. viz as 6 to 11. whereas that of a Diamond is as 6 to 15. a bitt of this green past being ground to a Prism, he shewed the Experiment, and it was found, that the Proportion of the Sinus was 50 to 27 exactly, as it had been found in a

former Experiment. Thence it was argued, that the quantity of Matter, was no Argument of Refraction, and it was humbly recommended to this Society to consider of the reasons of the differing refractions of bodys.

February 11, 1690/1. Halley shewed a Figure of the severall appearances of Mercury in Sole, and of the Succession of the same viz that in October every 13 years, the Planet being new, his node does ascend 8 minutes towards the North: and every seven years the same descends towards

[NOTE: The entry for this day ends as above, and there is nothing to indicate its proper conclusion. The following page is left blank.]

February 18, 1690/1. Halley shewed a generall Rule for finding the Focus of all sort of Sphericall Glasses, made of what materiall soever, whose refraction is known as well for finite as indefinitely distant objects, or which is all one, for converging, diverging, or parallel rays, whether with, or without consideration of the thickness of the Lens, this accommodated to double convexes, but he shewed how the same might be accommodated to concaves by putting $-R$ for the Radius of a Concave, and changing the signs $+$ and $-$ in all parts of the aequation, wherein the same $-R$ is found; as likewise for converging Rais by putting $-D$ for the distance of the point of concurrence of the Rais from the glass on the same side thereof, as is the Focus. This was ordered for the Transactions.

The same said, that he had engaged one Mr. Jett, a friend of his to undertake to polish a small diamond to make the object glass a Microscope thereof, of which he hoped a very good effect.

February 25, 1690/1. Halley shewed in two pieces of Crystall, the one of Iceland, and the other of Rock-Crystall found in the County of Kenry in Ireland, that each of them had a double Refraction though that of the Rock-Crystall was but little, and not discernable to those, that did not mind it, and that the double objects therein appeared in nearly the line that was the Axis of naturally grown polygonall Prism: after the same manner as the more visible double species of the Iceland Crystall appears in a line nearly parallel to the lesser Diagonall of the Rhombs that Substance naturally splitts into.

The same shewed, that in the said Iceland Crystall the Refraction might be accurately found by help of the native Plains thereof without any other polish, for that the Angle, which Mr. Hugens has found to be 75 degrees, was not too great to lett the coloured species pass, and that therefore the Refraction thereof might be found after the same manner, as he shewed lately in a Diamond; The same observed, that where as a Diamond does far exceed all other pellucid solids in hardness, and thence it might be thought, that according to the degree of hardness the Refraction ought to be more or less yet this pellucid Crystall being very soft, so as to be cut with a knif and not heavier, had yet a much greater refraction, than ordinary Crystall, which is much harder than it or glass itself. Whence it is demonstrated, that neither the weight nor hardness have any relation to the cause of Refraction in transparent Bodies, and that therefore the reason of the great variety of Refraction in different bodies must be else where sought for.

March 18, 1690/1. Halley read a Paper concerning the Velocity imprest on

a bullet by the explosion of the Pouder, which he derived from the Velocity of Fluids, which press through a hole, and herein observed a difference between the assertions of Mr. Mariotte, and one of Mr. Newton's Propositions, the one making the Velocity thereof sufficient to carry it to the whole hight of the Reservatory the other only to half of yt hight; but that the Experiment of the Quantity of Water evacuated by a reservatory of 13 foot by a bore of $\frac{1}{4}$ of an inch did agree with Mr. Newton's Prop: 37. lib: II and therefore he desired, that this might be ascertained by Experiment, which was ordered accordingly to be shewn at next meeting.

March 25, 1691. Halley observed that the Albicores and Bonitoes see not in the night time, for that it is ordinary to tow alnight after the shipp half a dozen of Artificiall flying fish for bait, and not to catch one fish, but in the morning as soon as it is light most of the hooks shall be full, which would not be, if the fish saw the bait in the night as in the day.

Halley read a paper, wherein he proved, that if it were true that the water of Ject d'eau did arise up to the hight of the level of the incumbent surface of the water, yet the quantity of water evacuated, as alledged by Mr. Mariotte, did not exceed what might issue out by a velocity capable of no greater an altitude, than half that of the reservatory, the cause whereof he did recommend to be examined by further Experiments.

April 22, 1691. Halley read a Paper concerning the Velocity of water running out at a hole, which haveing appeard the last day to have been equall to that, which is capable to cast it to the hight of the Reservatory; he shewed the Velocitys to be in subduple ratio, or as the square roots of the said hights, whence he deduced a rule for the time of the efflux of water through a hole by dividing the ordinate of a Parabola equally, to answer equal times, and then letting fall perpendiculars on the Curve thereof; the length of those perpendiculars shew, how much the water subsides in that time. By this method he shewed, that in the first second of time in the said Experimt: there passed 5 cub. inch. $\frac{63}{100}$ which is near half less than what ought to have passed by the bore, if it were $\frac{1}{4}$ of an inch: according to the velocity requisite to attain that hight: which agreed exactly with the quantity observed the other way by keeping the Vessell always at the same hight. It remained to assigne the reason of this want of quantity, when the Velocity is ascertained.

The same made a report of the success of a small Mortar made by him by the Society's order. viz that the Piece being onely 24 lb. and but one single diameter of the shott in length of chase did with no more than $1\frac{1}{2}$ ozs of powder cast a solid shott of $12\frac{1}{4}$ lb a full quarter of a mile by help of a Tompion of Lignum Vitae. Without which it did not cast it 100 yards: and softer woods, tho they encreased the force, had yet a less effect in proportion to their softness. He said that his Lignum Vitae Tompions being well fitted to lie on the pouder without thrusting it in, but just fitting the Chamber, had had a wonderfull effect in point of exact shooting for five shott in 6 fell within ye compass of less than 5 yards square at a full quarter of a Miles distance.

May 6, 1691. Halley said, that he had been told, that steel heating to a red heat, and turning violently round in the Air is the best way to harden it, the

cool Air applying successively to the Iron, and thereby giving it a more equal temper, than by dipping in water.

The same said, that firing his Mortarpiece against a brick wall the hole in the wall was very hot, but the bullet cool.

Halley shewed the Figure of an Engine he had contrived for forcing Air under water for the use of divers, which was a barrell of 5 inches Diameter to strike 10 inches at a stroke, having 2 Cocks, the one to let in the Air, and the other to keep down the compressed Air after the stroke.

May 13, 1691. Halley shewed the Method he intended to use in raising the Ship.

[NOTE: There are no minutes of meetings after this date until 12 Aug. 1691. Halley was away during part of this time at Pagham in Sussex, experimenting on board ship.]

Aug. 12, 1691. Halley related the success of his Experiments of going under water in his diving bell, which he was ordered to bring in writing against the next meeting.

August 26, 1691. Mr. Halley read an Account of his late Experiment of the Diving Bell, wherein he had maintained 3 Men 1 h. $\frac{3}{4}$ in ten fathom deep. He described the shape, and contrivances thereof, and shewed by what method he got the Air down into the Bell. Which he proposed as practicable for any depth, and number of men required.

September 23, 1691. Mr. Halley read his Paper about the means of finding the distance of the Sunn from the Earth by help of two observations of φ in the sun observed at two convenient places, which he supposed might determine the Sun's Parrallax to the 500th. part.

The same related, that he had contrived a way to goe out of the diving bell, and stay in the water, as long as he pleased, and be at liberty to do what he pleased there, by a vessel a man may carry on his head, like a cap, and by forcing to him with bellows, or such like means the Air contained in the diving Bell, he might go all round about it for a Circle of 4 or 5 fathom radius.

September 30, 1691. Mr. Halley read a Paper concerning the Motion, which occasions sound, supposed usually to be a vibration of the Air; but which as he conceived would not in that case be heard, wherewith the Air was perfectly excluded; as it is by glass and water. To ascertain which he shewed an experiment; of a striking watch under water, and included in a glass, of a good thickness, and at the same time swimming in water, so that no part thereof might touch the exterior glass, and so communicate any part of the tremor of the stroke to the Vessel, and it was found, that the sound was well heard through the glass, when in the Air, and when the glass, and watch was wholly immersed under water, yet the stroke of the watch was very audible when near a foot under the surface of the water.

October 7, 1691. Mr. Halley produced his Pipe for the Conveyance of Air out of the Diving Bell into a small vessel to be worn on the head of the Diver like a Capp. The Pipe was made with a small wire covered over with a Tape sewed thereon, and then severall folds of gutts drawn over it, which being dried

became perfectly tight so as to contain the Air, and was withall so flexible, as to be tied into a close knott, and yet leave free passage through it.

Halley said that the great Burning Glass at Paris will Vitrifie slate bricks and even lime itself, and many other substances not otherwise to be calcined or melted.

Halley proposed an Instrument for keeping fire under water by means of a crooked Siphon, bringing the fresh Air under the flame of a Candle, which he supposed would draw it, as it was evacuated at the top of the Vessell. Of this he tried the Experiment, but for want of a fit Vessell for the purpose the effect was not so convincing as was hoped, however it was plain, that by such a Siphon the flame of a wax candle under a glass-funnell immersed in water considerably was longer preserved, than without it, and by raising, and sinking the said funnell in the water alternately, the Flame was maintained in it without diminution, the Air being reciprocally expelled and received again by the ascent & descent of the water in the funnell.

October 21, 1691. Halley read a Paper of his containing an Art for any person though not able to swim, to go down to any depth, and come up again at pleasure by help of a small portable vessel, to be worn like a Cap on the head of him that dives.

The same likewise shewed a certain Method for weighing of Shippes by affixing cask and chests full of water and consequently easily manageable to all the places, on which fastening can be made on a shipp, and then driving out the water out of these Vessells by means of his Air Tubb. Of this he shewed the Conveniency in that all things are affixt below, nor agitated by the waves, and the shipp to be weighd rises up at once to the surface of the water, be the depth never so great.

Halley related the manner of raising the great stone in Shotland Yard.

The same gave an account of the Methods used by the Artificers of St. Paul's Church to remove and unshipp a great marble stone of 19 Tuns, viz. that they lifted it with two pair of geers, with each a double Tackle, and a windeless, so that with this purchase 6 or 8 mens strength sufficed to raise that great weight.

October 28, 1691. Halley shewed the manner and use of the Pullies used on board Shippes for raising great weights, called a Runner and Tackle, he shewed that the Runner doubled the force of the Tackle, and that in all Tackles with two blocks, the force is encreased as is the number of parts, whereby the weight hangs, that is either double, quadruple, sextuple &c. But with the Runner, it was either Quadruple, Octuple, or dodecuple, the force of the hand, or power acting.

Halley gave an account of two Instruments he had contrived, the one for shewing the Depth of the water to the persons within the diving tubb, at which they are under its surface, which was a bended Syphon, including Air, and adjusted so as to have the liquor in aequilibrio in the two shanks thereof in the Air, but the pressure of the water will raise the liquor in the closed end, so as the part full of Air will be alwaies as the depth of water + 33 foot reciprocally, and he shewed how to divide this Instrument by help of the Asymptotes of an equilaterall Hyperbola.

The other was an Instrument for blowing up the Decks of Shipp under water, or houses in case of fire, which was a sort of a Mortar-peece capable of 10 or 12 lb of powder made with fortification to resist the force of the blast, with a touchole and fire-lock to be placed on a piece of timber so as to fit exactly from Deck to Deck leaning on the beams and when so placed the tricker being drawn will give fire to it, and the whole force of the powder being caused & directed by the Chamber of the peece must necessary raise the beam, only for under water work the powder must be well secured against the water by Pitch or the like substance.

November 4, 1691. Halley shewed the Demonstration of the force of the Runner, and Tackle used on Shipboard, and made it appear, that in all Tackle or Pullies used for raising of weight, the force applied is encreased as 1 to the number of Ropes, deducting that the hand draws, but in the manner of a runner and tackle the force is as the number of parts of the Runner multiplied into the number of parts of ye tackle less by 1, and that by this Instrument with 2 pair of double pullies, one Man is able to lift a tun weight with his hands.

November 11, 1691. Halley read a Paper of his own, concerning the Computation of the weight, or force of a stream against a body suspended, or standing erect in it, as likewise concerning the opposition of round bodyes to a stream.

It was ordered, that the Society doe give a recommendatory Letter to Mr. Halley signifying their opinion of his abilities to perform the Office of Professor of Astronomy in Oxford now vacant, as likewise to testifye, what he has done for the advancement of the said Science, and that Dr. Gale be desired to draw up the Testimoniall.

November 18, 1691. Halley read a Paper of his concerning the force of the wind estimated according to the proportion he shewed the day before for measuring the force of a stream, which he then proved to be equall to the weight of a cylinder of water capable to engender in the beginning of its fall, a velocity equall to that of the stream. He now shewed, that the force of a stream of other liquors was to that of water of the same velocity as 1 to $\sqrt{\text{of the Specifick gravity}}$, and consequently that a stream of Air 29 times as swift as that of water was of equall force, he likewise proposed, that the velocity given to a Shipp by its saile might be estimated by the force of the wind multiplied by the Area of shipp's bough into the force of a stream of water equall in velocity to the shipp's way, allowance being made for the curvity and sharpness of the Boughs.

November 25, 1691. Halley read a Paper concerning an Hypothesis of the Cause of the Variation of the Variation of the Magnetical Compass, which he supposed to be caused by the Motion of one or more concave Spheres contained within the exterior surface of our Globe, all which he supposed to have the same center, and to turn round with a diurnall motion about the same Axis, that each of these Spheres have their magnetical Poles at some distance from the Poles of their Axes; And that the internall ones move somewhat slower in their revolutions, than the externall, and all of them slower than 24 hours time; but so as to make but a difference of about a degree in 365 revolutions, whence the magnetical Poles of these Spheres do gradually seem to move Westwards, that there does not want an Instance of such a Cavity in the ring

of Saturn, which hangs on the same Center without any contact, that this Theory was an improvement of the great mass of solid matter, that so there might instead of one inform lump be a sett of habitable globes one within another, all of which might be bigger than the Moon. That this was confirmed by the dipping needle, pointing down below. Whence it is evident the cause of this magneticall virtue is very deep within the Earth. That it is no argument against the Hypothesis, that the Sunn cannot shine there, whereas there are severall other means of producing light, which may be sufficient to illuminate these internall Spheres, and for warmth it is certain, that there is continuall temperature deep under ground. He was ordered to consider further of this matter, and give the Society a farther account thereof.

December 2, 1691. Mr. Halley shewed a figure containing his Hypothesis of the Variation of the Variation viz. that there might be within the Surface of this Globe of Earth severall concave spheres, the magneticall Matter of the Universe serving to line, and secure from falling in the severall Arches of the Concavities, that there may by this means be within our globe 3 other globes as big as the Planets Venus, Mercury, and the Moon, and that the means we know of producing light being so many, and so different, it cannot be doubted but the wisdom of the Creator has provided for it.

December 23, 1691. Halley read a Paper of his containing a way of estimating the necessary swiftness of the wings of Birds to sustain their weight in the Air, and having found, that the Area of each wing of a Pigeon weighing $8.8/10$ ozs was 35 square inches, he shewed that the force of a wind blowing upward able to bear that weight on that surface could not be less than at the rate of $6\frac{1}{2}$ in a second, he likewise shewed that wings necessary to sustain the weight of a Man, and moved with the aforesaid velocity could not be less than 12 times as bigg in all dimensions as those of the Pigion produced.

December 30, 1691. Halley gave an account that he had lately discovered the seat of the ancient Mediolanum in Brittain, answering to the Distances of the Itinerary of Antoninus, that it was a Garrison placed in the Midway between the nearest banks of the Rivers Dee and Severn at about 23 miles from Uriconium and 30 from Deva or Chester. And that the Mediolanum of Italy now Milain had just such a situation in the middle between the Adda and Ticino, and that in the welsh Glan signifying a Bank, Mediglan may most probably be taken for the name of a Town so situated.

January 13, 1691/2. Halley proposed an Instrument for measuring the way of a Ship by letting a Ball of brass, or the like matter curiously turnd hang into the sea by a line, and then observing the Angle, whereby the line is enclined to the perpendicular, which he shewed how to compute the velocity by.

January 27, 1691/2. Halley read an Essay to account for the cause of the Variation of the Variation of the Magneticall Needle, which he had formerly proposed to the Society, it was ordered to be inserted in the Transactions.

February 3, 1691/2. Halley shewed, that the Hypothesis that all Springs are from Rains could not well hold, both because that all the principall fountains run from the hills, with great rapidity, and consequently the greatest part of the water is there collected; that considering the breadth of the Valleys in pro-

portion to the tract of hills, a great river drains the Valley, as Lombardy for instance is very much longer, than the hilly grounds from whence the Rivers run, and besides the frost and snow in the winter moneths, which according to Mr. Ray would hinder the condensation of vapours into water, it seems plainly to demonstrate, that this water is then collected in the Caverns of the Earth, and condensed by the cold of the circumambient Ice and Snow into water like distillation in an Alembick, nor can the moisture of the Earth in the Summer Moneths be such as to keep so great Rivers perpetually running down, and the diminution of the Springs in winter seems to arise from the want of the Supplys of rains, the Rivers being only the result of the condensation of vapour & what falls down in Rains, and dews upon the lower grounds.

Halley read an account of an Invention of his being a Contrivance for conveying Air out of the diving Bell, to the distance of thirty or forty foot from the Bell, whereby a Diver may work as long as he pleases without a necessity of returning to the Bell, the force driving the air along the Pipes, being equall to a Cylinder of water of the hight of the topp of the Bell from the Surface of water, that compresses it.

February 24, 1691/2. Halley proposed an Engine for grinding long glasses for Telescopes, which he supposed the easiest possible viz. by a Center aloft perpendicularly over the Dish, and turning a Radius of the Sphere.

March 16, 1691/2. Halley produced a small Pipe designed for conveying of Air; Which was near 40 foot long and very flexible, through which the Air might be blown with the least breath. It was observed, that the breath upon blowing into it did pass out with a very sensible steam in the same instant as it was blown into it.

March 23, 1691/2. Halley gave an account of an Experiment lately made by one Mr. Constable¹ of Reading: viz that water did run out faster at the same hole in a Vessell of $13\frac{1}{2}$ Diameter, than at $22\frac{1}{2}$ Diameter, and this by repeated experience, the water being carefully kept at the same hight. This appeared to the Company to be occasioned by the fall of the water poured into the Vessell, which being determined downwards encreased the force of the water pressing out at the hole more in the small Vessell, than in the greater.

Mr. Halley produced a draught of an Instrument for observing at Sea, which was by reflecting one Object, and seeing the other direct in the same Telescope; so that both Sun and Horizon being seen to coalesce in the same point, would shew with great exactness the true altitude of the Sun, especially being guided by a screw, whose parts would divide the Angle most Minutely.

Aprill 6, 1692. Mr. Halley produced a Rule for finding the apparent Magnitude of Objects seen under water, or in any depth in a fluid, whose Refraction is known.

Aprill 27, 1692. Halley produced the Figure of the Caepia.

May 11, 1692. Halley produced a contrivance for a point for a magneticall Needle to turn upon, which was by a small glass cane strut on the brass pin, on which it formerly turned, which cane was curiously pointed by drawing the end at a Lamp and then melting the small end down to a globule of Glass, which

¹ A mistake for Chamberlaine.

was smaller than the brass point, on which it was used to play: The roundness smallness and smoothness of this blebb of glass caused the needle to vibrate much longer, and faster, than formerly: and seemed to be much better fixt for finding the Variation than before.

May 18, 1692. Halley read a farther part of his Discourse concerning the cause of the Variation of the Variation of the Magneticall needle being in answer to severall objections he conceived would be made to his Hypothesis.

June 1, 1692. Halley read a Paper, being a vindication of his Observations made at St. Helena from some groundless Exceptions of Mr. Flamsteeds, because of a difference found between his Observations, and these of one Pere Thomas made at Siam lately published by Pere Gony at Paris. He shewed the near agreement of his St. Helena Observations with those of Mr. Richer made at Cayenne about the year 1672, and that the principall differences between Pere Thomas and him fall out where he and Richer do perfectly agree; And Mr. Flamsteed being a Member of the Society he desired the Society's leave publicquely to vindicate himself in print from this aspersion, which was permitted him: All personall reflexion being to bee forborn.

June 9, 1692. Halley's Liqueur for his Leather Suites was said by him to consist of equall parts of Bees wax, Tallow, Turpentine, and as much Train oyle as all the rest, dipping therein, when all is scalding hott.

July 6, 1692. Halley said that he had found Cancellus in old Shells overgrown with green on the inside. And he promised to send up for the Society, some of these Cancellus, to be considered by them.

October 19, 1692. Halley read a paper, wherein he endeavoured to prove that the opposition of the Medium of the Æther to the Planets passing through it, did in time become sensible. That to reconcile this retardation of the Motions the Ancients and Moderns had been forced to alter the differences of Meridians preposterously. That Babylon was made more westerly than it ought by near half an hour, both by Ptolomæus, and those since him. And to reconcile the Observations made by Albategnius at Antioch, and Aracla on the Euphrates, they have been forced to make these places ten degrees more Easterly, than they ought, particularly Mr. Street has made Antioch of Syria in his Table of Longitudes, and Latitudes of places half an hour more Easterly than Babylon, whereas in truth it is about 40 minutes more Westerly. That this difference is found by 4 Eclipses observ'd about the year 900 and that by an Artist not capable of mistaking, that they all 4 agree in the same result and are noe other ways to be reconciled. Hence he argued, that the Motions being retarded must necessarily conclude a finall period and that the eternity of the World was hence to be demonstrated impossible. He was ordered to prosecute this Notion, and to publish a discourse about it.

October 26, 1692. Halley produced a passage in Keplers Epitome of Astro-nomiae Copernicanæ favouring his Hypothesis of a Nucleus included within the bowells of the Earth, which he supposed as a salvo for an objection against his Magneticall fibres, whereby he supposed the Earth, and the rest of the Planets to steer their courses eccentrically to the Vortex of the Coelestiall matter.

Halley shewed the Figure, and Description of two Sorts of Tackles used on board shipp, the one whereof he demonstrated to have a fivefold purchase, and the other a triple, tho' both made with three blocks.

The same produced a Modell of the Sea-crabb made to take up things from the bottom of the Sea, which appeared to lay hold of anything, and bring it up with it, onely it seemed very difficult to direct this Instrument at any depth in the Sea, where the sight will not help.

November 2, 1692. Halley shewed an Engine and Experiment thereon, whereby he proposed, that 2 Men should raise to the hight of about as great a quantity of Earth, as ten Men should fill below, and this by the help of the single Runner, and Tackle applyed to a Windlass, and that the Vessell, the Earth should be raised in, be contrived, to shoot its load, when at top, and erect itself again, when empty after the manner of Sr. Christopher Wrens Instrument for measuring the quantity of Rain. He was ordered to consider farther of this Instrument, and to provide against, what objections hee could foresee.

The same gave an account of the Eclipses of the Sun and Moon to be computed by an easy calculus, from the Consideration of the Period of 223 Months, shewing how to aequate between the extreame of the excess of the odd hours above even days, which is always between 6.20 and 8.50. He produced a Table ready calculated for this purpose, and shewed the use thereof. Which he promised to exemplify against the next Meeting.

November 9, 1692. Halley shewed a Paper wherein he had computed the Eclipses of the Moon in severall Series, and said, that he found, that he could very well represent them all; much nearer than they were observed by the severall observers; And this he doubted not, but it would succeed in yeares to come, as he found it did ever since Tycho Brahes time.

November 16, 1692. Halley read a Paper concerning a manner of managing of a long telescope by a reflecting plate. Which he shewed how to turn so upon an Axis parallell to the Axis of the World so as to make it cast the beams of the Sun or any other object through the tube. He proposed that the most convenient position of the Tube might be such as the reflected beams might be cast into the Parallell of Declination opposite to that of the Object intended to be viewed, and the tube laid Horizontall respecting the Point, where the object either rose, or Setts; the reflecting plate alwaies moved with half the swiftness of the object, and respecting the Equator.

November 23, 1692. Halley read a Paper concerning a manner of moving the reflecting Plate of a Telescope by two wheels. The bigger carrying the Plate, and the lesser next the Hand, whereby he shewed, that the observer standing immoveable without the assistance of any other person might move the reflecting Plate so as to answer the Motion of the Heavens onely with this caution, that the Tube were directed into the Parallell of Declination.

Halley produced an Hypothesis of the Motion of the Moon, which he said upon triall he had found to answer the Inequalities thereof better than any of the Theorys now extant, which he was ordered further to illustrate against the next meeting.

December 7, 1692. Halley produced three Sentences of the severall Theorys

of the Moon. viz Copernicus's by a whole Eccentricity, encreasing as the Moon approach'd the Quadratures. An equivalent to the Theory Tycho brahes placing the Center of equall motion $\frac{2}{3}$ of the Eccentricity on the other side the Center of the Orb, but encreasing after the manner of Copernicus, and lastly Horrox's, where the Eccentricity is made to increase so as to reclaime the same center of the Orb, but his encrease being accordingly to the Suns Position in respect of the Apogae.

December 14, 1692. Halley produced a Paper containing a Method of enabling a Ship to carry its Guns in bad weather, which was by carrying the breeching tackles of the Guns to the opposite side of the Shipp, whereby he shewed that the weight of the Guns on the lower side as a Ship rouls, would be made to bind the sides together, whereas in the ordinary manner opens, and streines the sides very much.

December 21, 1692. Halley read a Paper concerning a Method of observing the Moons place by the difference of her Rt. ascension from the fixt starrs: These he proposed might be obtained every cleare night, and might be a very proper and practicable Medium for finding the Longitudes of places: He shewed likewise, how by a Diagonall thread placed at an angle of 45 gr. with the Meridian, the difference of times, between the transit of the said diagonall and the upright thread in the Focus of a Telescope, would accurately measure the difference of declination of any two objects passing through the Telescope. In order to this purpose he produced a Table he had calculated, exhibiting the points of Intersection, and the Angle of the Moons way with the Equator for the ready finding at all times, when the Moon would be in the same parallell of declination with any starr proposed.

January 11, 1692/3. Halley produced a Paper, whereby he offered to illustrate, what he had lately printed about the severall Species of Infinite quantity, shewing by a Figure representing the sections of a Globe into 8 quadrantes, how the said Quantitys were derived, and the relation they have one to the other.

January 25, 1692/3. Mr. Halley shewed a Method of finding the Moment of the Tropick by any three observations of the difference of the Suns declination near the said Moment. He brought the Problem to that of describing a Parabola about a given Triangle, the Position of whose Axis was likewise given, the Solution of which Problem he likewise produced.

February 8, 1692/3. Halley shewed a Proposition he had discovered for determining the Moment of the Tropick by 3 observations near it, which he had brought to a plain Equation, tho it were encombred with all variety in the Cases thereof.

February 15, 1692/3. Halley related, that he had seen a Person, who had his little, and ring finger grown down, that he could not open them, and that this was hereditary, his Father being so too, and that this lameness of the son grew upon him gradually, he in his youth having not been so. Having first his little fingers and those one after the other, then his ring fingers in, and that now his middle fingers begin to be affected, wherein he exceeds his Father.

March 8, 1692/3. Halley read some Considerations on the Bills of Mortality

of Breslaw, giving a Table of an Estimate of the Ages of the whole People of that City, and thereby shewing the proportion of Mortality in each age, and a rule to estimate how long any person may reasonably be supposed to live.

March 15, 1692/3. Halley produced a Paper wherein he shewed a Method of computing the Value of Annuitys for one two or three lives, with all the cases of the reversions of them, either after any one, or any two lives of three proposed, which was ordered to be printed in the Transactions.¹

Aprill 12, 1693. Halley produced a paper shewing the Method of determining the day of the Shortest Crepusculum in any latitude, or, which is all one, to find, when the Sun Ascends, or descends 18 degrees swiftest. This he shewed to be, when the Sun being due East, or West was 9 degrees below the Horizon. Demonstrating it from the Motion of the Zenith tending directly into the East, whence all Objects ascend on that point with the same, and also with the greatest possible swiftness in south Latitude, and that that swiftness of Ascent was to the swiftness of the Equinoctial Motion as Radius to the secant of the given Latitude.

May 31, 1693. Halley produced a gage for shewing the depth, to which the Bell descends in the Sea by the Compressure of the Air included in one Legg of a Syphon hermetically sealed. Shewing that Method of dividing the Syphon so as to shew the depth by a Scale annexed.

July 26, 1693. Halley gave an account of some observations he had made of the Lobsters and Crabbs shooting their Claws, and new ones growing again out of the stumps of them; that Nature has furnished them with the means of discharging themselves of their Limbs, when disabled, by haveing certain creases in the smallest part of their Claws, which parts are endued with the buds as it were of new Claws, from out of which Stumps he said he had seen a Lobster with two new Claws beginning to budd forth, perfectly formed, and articulated, and which by the relation of the fishermen in a few years would grow nearly as bigg, as if they had never been broke off. They say likewise, that if the Claws be broke off in any other place but at this crease; the Lobster will certainly die thereof. Crabbs have likewise the same Faculty, but they can likewise discharge their small leggs, on which they crawle, and they will grow again. This seeming to be brought to pass by a Principle in Nature, of which there are not many Instances in the whole History of Animalls. Vide Mr. Boyle of the Usefulness of Exp: Phil. Part II. Sect. I. pag: 18.

October 18, 1693. Halley read a Paper of his own, concerning a Demonstration of the Contraction of the year, and promising to make out thereby the necessity of the worlds coming to an end, and consequently that it must have had a beginning, which hitherto has not been evinced from any thing, that has been observed in Nature. Of this he was ordered to print a Dissertation.

October 25, 1693. Halley shewed severall amendments he had made to the numbers, and translation of Albategnius in his observations of four Eclipses of the Sun, and Moon about 800 years since, which numbers were so vitiated, that they were not to be understood, yet it was necessary to adjust them in order to ascertain the time, that the Author Albategnius took for the moments of those Eclipses.

¹ Cf. *Biog. Brit.*, vol. iv, p. 2511, note [GG], col. 2, London, 1757.

The same read an account of a rare case in Chirurgery, which befell Mr. C. Barnerd in St. Bartholomews Hospitall viz: that the heart of a Man was grown to his left side, and by the Continuall Pulsation of the Ventricle, had worn away three of the ribbs, one entirely, and two other in the middle of them. So that the heart beat out in a lump as bigg as ones fist, without the thorax, and what was most strange severall peices of ribb were found sticking within the ascending trunk of the great Artery.

November 8, 1693. Halley read his Account of the Observations of Albalonius [*sic*], which he had drawn up in Latin, in order to be inserted into the Transactions, having, as he supposed, amended the many faults, that are in the Editions of that Author, as far as concerns his Observations, and requesting the assistance of the skilfull of the Arabick language to compare, and confirm the Emendations from the Authority of the Originall if it be to be found in Europe.

November 15, 1693. Halley produced his draught of the West coast of Sussex between Selsey and Arundell with the line form and situation of the dangerous shoales called the Owers.

January 10, 1693/4. Ordered, that the Certificate ordered the last Meeting be omitted, and that instead thereof Mr. Halley write a Letter to Mr. Marshall signifying, that his way of grinding glasses having been examined by Order of the Royall Society, the Report made thereupon to them has bin much to their satisfaction.

January 31, 1693/4. Halley produced a Paper, containing a Method for extracting the Roots of aequations however affected, which he said was generall, and as he conceived, new, the Demonstration whereof he promised against the next meeting.

February 7, 1693/4. Halley read a Paper of two very extraordinary cases of Dropsies, The one an Ascites in a Woman, out of whose belly were drawn near 20 gallons of water, The other of an extraordinary Hydrops uteri, wherein the outter tunicles of the womb were distended by water so as that she seemed to be big with Child for near three years, and at first was taken so to be.

February 14, 1693/4. Halley shewed the Propagation of the Tides about the Island of great Brittain, That in six houres time the Western flood was carried on through the Chanell, but that the Northern flood from Bachanness to the foreland required 12 houres time, that the whole North part of the Irish Sea was full at a time filling both ways, the like in the Eastern part of the Chanell, wherein ij h. Moon makes high water for all the length of Kent, and Sussex for above 100 miles together.

February 21, 1693/4. Halley produced a Projection of the Sphere he had drawn after the nature of the Analemma, but all in streit lines, for exhibiting the hour of the Suns Altitude, and è contra the Altitude by the hour for the whole year by inspection only.

March 21, 1693/4. Halley shewed a Method he had discovered for contracting the work of his Series for exhibiting the Roots of Equations; by the extraction of a square root, which gives the roots somewhat greater, than the truth, but nearer than the former.

May 2, 1694. Halley produced a Book printed in Low Dutch¹ Anno 1623. describing the Coasts of America and Africa between the Tropicks, and particularly Brasile. The Authors name Dirick Ruiters.

May 9, 1694. Halley said he had been credibly informed, that Duck-Eggs would certainly kill a Lark or Nightingale, whereas Hen-Eggs boiled hard are a very proper food for them.

May 16, 1694. Halley read an account of the quantity of Vapour, which he finds to have been 8 inches of water in a years time simply without the immediate presence of the Sun, or being exposed to the wind.

May 30, 1694. Halley proposed a Method of makeing Cattle take salt, when kild, viz, by putting them for some time into a cave in the Earth to let them Cool, then killing and Salting them in the same place, which at any great depth under ground has always a temperature very like our September weather.

July 11, 1694. Halley produced his Method of extracting the roots of pure, or adfected aequations, which he was ordered to put into the Transactions.

October 24, 1694. Halley related that he had considered the Observations made with the pendulum Clock at Cayenne, which he finds to have retarded just two minutes and an half p. diem, or the 24th part of an hour or the $1/576$ of a day, whence it follows that the pendulum that kept time in France would loose $1/576$ part under the Equator; wherefore the pendulum ought to be $1/288$ th part shorter under the Line than in France, and for a second swing about $2/15$ of an Inch shorter.

October 31, 1694. Halley said that near Reading he had been credibly informed that there was found a very large bed of oyster shells, which lay bare to the open air, and covered good part of the surface of a large valley.

November 14, 1694. Halley read a paper of his own, being an account of the Tables for computing the motion of the first Satellite of Jupiter and its Eclipses lately published by Mr. Cassini, with the application thereof to the ascertaining the Longitudes of the Ports of France. He promised to reduce these Tables to the Julian account and the Meridian of London in order to publish them in the Transactions.

December 12, 1694. Halley read an account of his Hypothesis for explaining the strange changes that seem to have hapned in the superficial parts of the Earth: which he shewed might be made out, by supposing the Choc of some Comet or other great body, striking against the Earth after any sort. This would produce a new Axis and poles of Diurnall Rotation, and a new length of the Day and year, but, above all, so great an agitation of the Waters as may account for all these strange marine things found on ye Tops of hills and deep under ground. He supposed that the Caspian Sea might have been the depression occasioned by such a Collision, and that the extream Cold of the Nor West parts of America may be occasioned by those parts having once been the North Pole of the World.

January 16, 1694/5. Halley said he had seen and eaten a sort of Caviare at

¹ One authority states that Halley 'spoke German fluently', in 1698. It seems just possible that Halley may also have had some knowledge of Dutch, but there is no direct evidence of this. Cf. *Notes and Queries* (1928), vol. clv, p. 87.

Leghorn calld there Constantinople Caviare of a smaller grain than the Russian and made of the row of the common Sturgeon taken in the Palus Mæotis and Bosphorus Cimmerius and brought from Caffa in Crimea to Constantinople, whence it has its name Caffiale.

February 20, 1694/5. Halley presented the foot of an Eagle with its four Talons very sharp and large which was ordered for the Repository.

The same shewed the mapp of the South Pole wheron he had drawn the severall Variations, exhibiting at one view the severall tracts wherin the Variations of the Magneticall Needle are regularly East or West, and it was observed that in the Parallel of 40 gr South, it is almost all round the Globe nothing else but Sea.

March 6, 1694/5. Halley shewed a Method he had found out for producing the Logarithms at once; this he was ordered to draw up and insert in the Transactions.

March 13, 1694/5. Halley shewed in a Scheme he had drawn, how small a quantity of Water would suffice to drown the whole Globe of the Earth, 2 Miles deep; and that a six hundredth part of wh. water might be included in a shell of Earth of a hundred Miles thick would suffice for the purpose.

March 20, 1694/5. Halley shewed a Demonstration of the Method, whereby Mr. des Cartes did, or easily might, obtain his rule for Constructing all Equations of the sixth power, involving the Cubo-cube, wherewith he concludes his Geometry: this being what Des Cartes has wholly conceald. He promised to draw up a discourse concerning a generall Method of Constructing all such Equations.

April 10, 1695. Halley gave in a description of the Mill near Marybone made with Horizontall Sailes, to raise Water: viz, that the four vanes were fixed two and two upon Moveable Axes, and placed nearly at right angles to one another, so as to have the one Vane horizontall and the other perpendicular, and consequently to draw but one at a time. It was ordered that a Model be made thereof.

April 17, 1695. Halley related that upon triall in a Mold of Hardned Steel with Diamond powder, Mr. Jett had found that it was impracticable to grind a Diamond Sphaericall, to make the object glass of a Microscope.

April 24, 1695. Halley related that on the West side of the Isle of Wight to the Northwards of Atherfield and Chaile there is a very great long beach of small stones not much bigger than Grey-peas and hardly any other or bigger stones to be found on that Shore.

April 30, 1695. Halley related that Mr. Bird the Stone cutter at Oxford had informed him that in sawing a great block of Stone, he had found a harder part which his saw would not cutt, but having broken it asunder with wedges, there was found in the middle a cell of a harder substance that included a Toad of a greater magnitude than the usuall Toads are: That Bishop Wilkins then Warden of Wadham Coll: caused him to cutt out all the said Cell out of the Stone, and that he included the Toad therein and buried him in his Garden, but that he soon died.

Halley produced a paper of his own shewing the rule for computing the

Quantity of water flowing out at a hole in the side of a Cistern at any given pressure. viz. that the said quantities of water are alwaies proportionall to the Solids which have for base the Aperture of the Hole and are terminated by a Parabola whose vertex is in the surface of the Water and whose axis is the perpendicular passing by the aperture.

June 5, 1695. Halley produced a draught of an actual Survey of the New River commonly so called; brought by Middleton from Ware to furnish London with Water.

July 17, 1695. Halley produced a very compendious Method he has found, for composing the Logarithms, which he promised to insert in the Transactions together with the Solution of the Reverse of the Problem. Viz from the Logarithm given to find the Number.

July 31, 1695. Halley shewed a further improvement of his method of making Logarithms, exhibiting eight several series for that purpose; one of them giving the Logarithms to 24 places, by the three first steps or members of the series.

November 20, 1695. Halley read an account he had collected of the severall passages in History, concerning Palmyra; and of the Antient flourishing condition thereof and of the time and occasion of the Suddain ruine and Subversion of the City.

December 18, 1695. Halley produced a Passage out of Appian de Bellis Civilibus Rom. lib v, concerning the condition and state of the City of Palmyra about the year 40 ante Christum.

The same shew'd a Palmyrene Inscription he had copied out of Mr. Spens Miscellanies, wherein there are two lines in the Old Syrian Character, which he compared with the Inscription taken by our travellers at Palmyra.

The same produced a Series he had discover'd for exhibiting the three roots of Cubick Aequations without ambiguity.

January 8, 1695/6. Halley read his account of Palmyra, which with the approbation of the Society he intended to publish in the next Transactions, with some remarks on the Inscriptions there found.

January 15, 1695/6. Halley related that Mr. Hevelius, when he visited him at Dantzick, had assured him that what we call Spruce-beer, was after it was drawn of from the Malt boyl'd for 24 hours together which gave it that glutinous thickness it usually hath.

January 22, 1695/6. Halley produced a generall rule for projecting the Sphere from an Eye placed at any point within or without the Surface of the Sphere, and for finding readily the diameter of any projected Circle, whereby the Rules of the severall usual projections are demonstrated as Corollaries.

January 29, 1695/6. Halley gave a relation of the manner practised at the Exchequer for melting down the Old Money in order to its recoinage.

Halley shewed the Rule he had found to exhibit, the intervall of Meridionall parts in the Mercators Chart; answering to any intervall or intermediate Arch in the Quadrant, which he was orderd to Publish in the Transactions.

February 5, 1695/6. Halley reported that he had consider'd the Records

cited by the Ld. Viscount Tarbat, and that he had found a passage in Buchanans history, which did demonstratively clear the point of the Legitimacy of Robert III King of Scotland.

February 12, 1695/6. Halley produc'd a general proposition for shewing at one view the diameters, parameters and Foci of any Conic Section given, by the same Theoreme, as well in the Scalene as in the right Cone. viz That all sorts of Conic Sections that pass at the same perpendicular distance from the Apex of the Cone, have their Foci in the intersection of the Axis of the Section with an Hyperbola whose Asymptotes are the Sides of the Cone and Vertex in the Center of that Circle of the Base, whose Diameter is the common parameter of all those Sections.

February 19, 1695/6. Halley produc'd another general proposition whereby he shew'd the Parameters and foci of all Conic Sections having their Vertices in the same point of the side of the Cone.

February 27, 1695/6. Halley related that several persons having drunk an Infusion of a root they took to be Gentian, were all seized with madness after differing manners but by using proper means they were all restored in a few days.

March 4, 1695/6. Halley produced and read a demonstration of the Analogy between ye meridian line, by which the nautical Charts are laid down, and the Scale of Logarithm Tangents: which he did from the consideration of the Stereographicall projection of the Sphere, wherein he prov'd that the Angles in the projection are ever equall to the Sphericall Angles they represent, whence the Rhumb-lines on yt projection become all proportionall spirals.

March 26, 1695/6. Halley related that as he was going up Abchurch lane on this day sennight about two of the Clock it raining at the same time a thick small rain, he had seen a very distinct Rainbow crossing the Street like an Arch, within the houses, not much above his head.

The same shewed a Proposition for determining the semidiameter of the Iris, by the ratio of refraction given; he having reduced it to a Geometricall Problem.

April 1, 1696. Halley read a paper containing the rule for computing the diameters both of the primary and Secondary Iris, by a Direct process; and shew'd that if the refractive Power of Water were as two to one, there could be no primary Iris; and if it were as three to one there could be no Secondary.

April 22, 1696. Halley shewed that the Lemma he had made use of for determining Geometrically the diameter of the Iris, was also applicable to the finding the Times of the Stations of the Planets. He was ordered to explain this in the Transactions.

May 6, 1696. Halley related that the three men lately executed for Treason were observd to be dead in 10 Seconds of Time, which he supposed to be by apoplexy, the ligature hindering the return of the Blood by the Jugulars. But that a man hanged some years since at Barnet having been much wounded in the Head, and bleeding exceedingly, was observd to be so long in dying, that the like had not been known, being near half an hour; the great expence of Blood hindering the Apoplexy which generally kills, long before they can be supposed to die for want of Breath.

The same read a paper wherein he shew'd that the Itinerary of Antoninus and other Antient Authors, mentioning the distances of Places, where the numbers are not Vitiated by time might be much relied on, for adjusting the Geographical Situation of places and Countries of which we have at present but very short accounts particularly that it is not more than 40 grs of Longitude from London to Scanderoon, supposing no deflection of the Roads, as is agreeable to the Observations of Eclipses made at Aleppo, whereas Geographers generally extend the Mediterranean several degrees too much to the East.

May 20, 1696. Halley read a paper of his own containing his desire that some persons, qualified with skill and Instruments would please to observe the Occultations and Transits of the fixt Stars by the Moon, there being as he conceives no surer method to determine the Longitudes of Places, than by such Observations, especially by the Occultations of Stars on the dark limb of the Moon, which are instantaneous.

The same related that in the Chimney piece in the Ante Chamber to the Council Chambers at Whitehall, there are several sorts of shells as Bivalves, Conchæ, and Cochliæ in the black marble stone, petrified and polished with the Stone, others yet shells and spoiling the polish. He said also that he had seen the like in a Red marble Table in the Yard at the Rummer in Queen Street.

June 3, 1696. Halley produced the Elements of the Calculation of the Motion of the two Comets that appear'd in the Years 1607 and 1682, which are in all respects alike, as to the place of their Nodes and Perihelia, their Inclinations to the plain of the Ecliptick and their distances from the Sun; whence he concluded it was highly probable not to say demonstrative, that these were but one and the same Comet, having a Period of about 75 years; and that it moves in an Elliptick Orb about the Sun, being when at its greatest distance, about 35 times as far off as the Sun from the Earth.

July 1, 1696. Halley read a Paper of his own wherein he gave the Elements of the Motion of the famous Comet of 1618, supposing it to move in a Parabolicall Orb, which he had so fixt as to answer the Phenomena of that Comet, and he concluded that it had gone within the Orb of Mercury. But by reason of the Coursness of the Observations left us, it was not possible to reconcile all of them, but he had founded his Calculus on such of them as seem'd best circumstanced and most certain.

[NOTE. In copying and printing the above 'Extracts' the endeavour has been to follow as far as possible the actual spelling and punctuation found in the Journal Books. Want of uniformity is partly due to the fact that the records were written by different persons at different times.

Halley left London in the summer of 1696 to take up his duties at the Mint at Chester. For some years there are no further entries relating to him, other than those recording the receipt of occasional letters from him.

The above remarks also apply to the 'Extracts from the Council Minutes' which follow.]

APPENDIX IX

EXTRACTS REFERRING TO HALLEY FROM THE COUNCIL MINUTES OF THE ROYAL SOCIETY

Maïi 30, 1688. Ordered that Mr. Perry and E. Halley do inquire upon what terms the Divinity professors Lodgings in Gresham Coll. are to be lett.

June 20, 1688. Ordered that Mr. Perry and E. Halley do make a conclusive bargain with Mr. Wells the Divinity professor for his Lodgings in Gresham Coll.

October 22, 1690. Ordered that the Treasurer do pay to E. Halley one hundred pounds being two years Salary due to him on Jan. 27, 1688/9. And that the year and $\frac{3}{4}$ salary now accruing due to him be allowed him to all intents and purposes as if he had obtained an order for the payment thereof.

November 19, 1690. Ordered that Mr. Cramer and Mr. Sharp do attend Mr. Waller as Secretary, and that his report of their abilities do determine, whether of the two shall be accepted as a Deputy to E. Halley during his absence.

January 21, 1690/1. Mr. Waller reported that he had not done any thing in relation to Mr. Cramer and Mr. Sharp by reason that E. Halley was returned to London and entred again into his place as Clerk to the Society.

A Discourse arising about publishing the Philosophical Transactions again, it was referred to the next Councell to determine thereof: E. Halley not being now present.

January 28, 1690/1. There being a full Councell it was resolved that there shall be Transactions printed, and that the Society will consider of the means for effectually doing it. And Dr. Tyson, Dr. Slone, Mr. Waller and Mr. Hook were desired to be assistent to E. Halley in compiling and drawing up the Transactions.

March 25, 1691. Ordered that a Letter be drawn up by E. Halley and presented to the President to be signed by him, and sent to Dr. N. Vincent in answer to a proposition made by him to the Society in relation to his Will.

May 13, 1691. Ordered that the Treasurer pay to E. Halley 100 £ in full for all Salary due to him from the Society till Jan. 27, 1690/1.

November 25, 1691. Ordered that it be referred to the judgment of E. Halley to conclude which of the papers and letters of ye Society are proper to be entred upon their books, and that the entrys thereof be made by Lady Day next.

November 16, 1692. Ordered that E. Halley have 37 £. 10 s. paid him for $\frac{3}{4}$ of a years Salary due October 27, 1691.

December 7, 1692. Halley offered that if it shall be undertaken to print a book of Philosophicall matters such as the Transactions used to consist of, that he would undertake to furnish de proprio five sheets in twenty.

November 21, 1694. Ordered that Halley be paid one years Salary due to him October 27, 1693 being 50 £.

April 29, 1696. The Vice Presdt. signed an order for 50 £ to be paid to E. Halley for one years salary due Octob. 27 1695.

[NOTE: All the above Minutes are in Halley's handwriting.]

July 6, 1698. It was ordered that the Treasurer pay to Edm. Halley 50 £ in full for his Salary to 27 of October 1696.

January 11, 1698/9. It was ordered that any Clark shall be payd that the Secretary employs in any business of the Society durement the absence of Mr. Halley.

February 8, 1698/9. The Vice President & Secretary informing the Council that Mr. Halley acquainted them that he had left a Deputy Dr. Arburthnett to officiate in his place as Clerk to the Society; the Council ordered the bookes to be searched about this office and what was done in it to be looked into next meeting of the Council.

February 15, 1698/9. It was proposed and balloted that Mr. Halley being absent upon a particular service, & no provision being yet made by the Council for supplying his place, it was ordered that Dr. Sloan should propose the names of 2 or 3 persons to be assistant to the Secretarys as Clerk; and it was carryd in the affirmative nem: contr:

APPENDIX X

HALLEY AT THE MINT, AT CHESTER

[Reprinted from Brewster, Sir David: *Memoirs of the Life, Writings and Discoveries of Sir Isaac Newton*, vol. ii, pp. 194-6, Edinburgh, 1855; with the original notes.]

The elevation of Newton to the Mint led to the promotion of his friend, Dr. Halley, to an office in the same establishment. He was made Deputy-Comptroller of the Mint at Chester, in 1696, the office of Comptroller being at that time held by Mr. Thomas Molyneux. Soon after his appointment, disturbances of a very serious kind arose among the officers. Mr. Halley, and Mr. Woodall the Warden, feeling it their duty to see the King's business well and faithfully performed, had insisted upon correcting certain irregularities in the proceedings of Bowles and Lewis, two clerks in the establishment. The Master of the Mint, a Mr. Clark, espoused the cause of the clerks, and, 'pretending to take offence at something that nobody else had observed in the company, went and borrowed Bowles his sword, to waylay the Warden as he went home.' He did not, however, fulfil his threat, but some time after he sent a challenge to the Warden, which was accepted. 'He appeared, however, on the ground,' says Halley, 'before the hour, with his man and horses, and staid not after it, by which means they fought not, and I demonstrated the folly of such decisions that went no farther.'¹ In the same spirit, Lewis, the clerk of the Warden, threw a standish at Mr. Woodall, and he and the Master brought forward all sorts of charges against Halley and Woodall. Halley was accused of showing a preference to individuals in the purchase of silver, and of committing professional blunders in adding an alloy to what is called *schissell*, and thus diminishing the purity of the coin; while the Warden was charged with having used expressions of a treasonable nature, dangerous to the Government. Halley was at first greatly annoyed by these dissensions, and, in requesting Newton to interfere for his protection, he expressed the hope 'that his potent friend, Mr. Montague, would not forget him, if there should be occasion.'² When Parliament had voted the continuance of the five country mints, Halley requests 'that Lewis may appear face to face with him before the Lords, there to answer to his throwing the standish at Mr. Woodall, the giving the undue preference to Palford, and some other accusations of that nature, I am prepared to lay before their Lordships. I came to town purposely to charge that proud, insolent fellow, whom I humbly beg you to believe the principal author of all the disturbance we have had at our mint, whom if you please to see removed all will be easy; and on that condition I am content to submit to all you shall prescribe to me. Nevertheless, as I have often wrote you, I would urge you to nothing but what your great prudence shall think proper, since it is to your particular favour I owe this post, which it is my chiefest ambition to maintain

¹ Letter to Molyneux, August 25, 1697.

² August 2, 1697.

worthily, and next to that to approve myself in all things.'¹ In the same letter he speaks of his resignation, but as he is unwilling 'that Lewis and Clark should interpret it to be any other than a voluntary cession,' he thinks it necessary to prosecute the charges against them.²

Before these dissensions had come to this crisis, Newton had offered, in February 1697, to procure for Halley an 'engineer's place,' through a Mr. Samuel Newton. Halley³ expressed his willingness to accept of this kind offer, provided Sir Martin Beckman was of opinion that the post was likely to be durable; but two days before the date of Halley's letter, Newton⁴ had offered him a situation worth ten shillings a week, to teach the mathematical grounds of engineering two hours a day to the engineers and officers of the army; but he seems to have declined both these situations. When the five country mints were discontinued in 1698, Halley, at his own desire, was appointed by the King to the command of the *Paramour Pink*, which sailed in November 1698, in order that he might study the variation of the needle in different parts of the globe.

¹ Letter to Newton, dated December 30, 1697.

² These facts are gleaned from four unpublished letters to Newton, and three to Molyneux.

³ February 1697.

⁴ *Macclesfield Correspondence*, vol. ii. p. 420.

APPENDIX XI

THE ADMIRALTY'S INSTRUCTIONS TO HALLEY

(15 October 1698)

[From a photostat made direct from the Admiralty Minutes, in Public Record Office, London.]

Instructions for proceeding to Improve the knowledge of the Longitude and Variations of the Compasse.

Whereas his Maty. has been pleased to lend his Pink the Paramour for your proceeding with her on an Expedition, to improve the knowledge of the Longitude and variations of the Compasse, which Shipp is now compleatly Man'd, Stored and Victualled at his Mats. Charge for the said Expedition; you are therefore hereby required and directed, forthwith to proceed with her according to the following Instructions.

You are to make the best of your way to the Southward of the Equator, and there to observe on the East Coast of South America, and the West Coast of Affrica, the variations of the Compasse, with all the accuracy you can, as also the true Scituation both in Longitude and Latitude of the Ports where you arrive.

You are likewise to make the like observations at as many of the Islands in the Seas between the aforesaid Coasts as you can (without too much deviation) bring into your course: and if the Season of the Yeare permit, you are to stand soe farr into the South, till you discover the Coast of the Terra Incognita, supposed to lye between Magelan's Streights and the Cape of Good Hope, which Coast you are carefully to lay downe in its true position.

In your returne home you are to visit the English West India Plantations, or as many of them as conveniently you may, and in them to make such observations as may contribute to lay them downe truely in their Geographical Scituation. And in all the Course of your Voyage, you must be carefull to omit no opportunity of Noteing the variation of the Compasse, of which you are to keep a Register in your Journall.

You are for the better lengthning out your Provisions to put the Men under your Coñmand when you come out of the Channel, to Six to four Mens Allowance, assuring them that they shall be punctually pay'd for the same at the End of the Voyage.

You are dureing the Term of this Voyage, to be very carefull in conforming your selfe to what is directed by the Generall Printed Instructions annex'd to your Coñmission, with regard as well to his Mats. honor, as to the Government of the Shipp under your Coñmand, and when you returne to England, you are to call in at Plymouth and finding no Orders there to the contrary, to make the best of your way to the Downes, and remaine there till further Order. Giving Us an Accot. of your arrivall. Dated the 15 Octor. 98.

H P. I H: I K. G W

By &c. J. B.

To Captn. Edmd. Halley Coñmandn. of his Mats. Pink the Paramour. River.

APPENDIX XII

HALLEY'S TWO VOYAGES, 1698-1700

'We do not often think of him as a sailor; and yet, previous to Cook, Capt. E. Halley was our first scientific voyager.'¹

Halley had long been interested in the subject of terrestrial magnetism. He wished for an opportunity to test his theory by making observations of the variation of the magnetic needle in different parts of the world. 'To this end, he procured an application to be made to King William the Third, who appointed him Commander of the *Paramour Pink*, August 19, 1698, with express orders to seek by observations the discovery of the rule of the variation.'²

'The rest of his commission runs thus: to call at his Majesty's settlements in America, and make such further observations as are necessary for the better laying down the longitude and latitude of those places, and to attempt the discovery of what land lies to the south of the western ocean.'³

Halley's 'Journal' or 'Log' of these two voyages was published by Sir Alexander Dalrymple,⁴ as mentioned in Captain James Burney's condensed account,⁵ which now follows:

[*Captain James Burney's account*]

Between November 1698 and June 1700, Dr. Edmund Halley, in two Voyages to the Southern *Atlantic*, made his celebrated attempt to discover the laws by which the Variation of the magnetic needle is governed.

As this was an object of great public interest, and undertaken at the recommendation of the Royal Society, Dr. Halley was accommodated with one of the King's ships, a *Pink* named the *Paramour*, and though he was not bred up in the Navy, nor to the profession of a mariner, that his plans might not suffer obstruction from any wilfulness or caprice of other persons, he was himself appointed to command her.

The *Paramour* sailed from Deptford October the 20th, 1698. In going down channel, she proved so leaky that it was necessary to have her hull

¹ Oliver, Capt. S. P., in *The Observatory*, vol. iii, p. 349, Greenwich, 1880.

² *Biog. Brit.*, vol. iv, p. 2502.

³ *Ibid.*, side-note. See also our Appendix XI, p. 243.

⁴ Dalrymple, Sir Alexander: *Collection of Voyages to the South Atlantic*, London, 1775. (Copies are in the British Museum, London, and in the New York Public Library, New York City, U.S.A.)

⁵ Burney, James: *Chronological History of the Voyages and Discoveries in the South Sea*, vol. iv, pp. 384-7, London, 1816.

Both Burney's and Dalrymple's Collections "are by men well qualified by science, learning, research and devotedness to their object, to perform well what they undertook on any subject connected with geography and discovery". Stevenson's *Voyages and Travels*. Quoted in Allibone's *Dict. of Authors*, vol. i, p. 469, Philadelphia, 1897.

examined, for which purpose she put in at *Portsmouth*, where she was taken into dock. The Variation in *Portsmouth* Harbour was then 7° West.

November the 22d, the ship went out of the harbour, and anchored in *St. Helen's Road* at the East end of the *Isle of Wight*. Admiral Bembow's flag was flying there, which the *Paramour* saluted with five guns; and the Admiral, to mark his respect for Dr. Halley, returned the salute with the same number of guns. Respect for science, however, did not operate sufficiently strong on the Officers of Dr. or rather Captain, Halley's ship, to prevent their taking offence at being put under the command of a man who had risen without going through the regular course of service in the Royal Navy; and this proved to be the occasion of his making two voyages, instead of concluding his experiments in a single voyage. The 29th, the *Paramour* sailed from *St. Helens*. Dr. Halley's Journal of his navigation in the *Atlantic*, was published by Mr. Dalrymple from the original manuscript, in a *Collection of Voyages to the Southern Atlantic*. London, 1775.

The first part of Dr. Halley's track was to the *Cape de Verde Islands*. January the 17th, they were not far by the reckoning from the Island *Fernando Loronho*, which Dr. Halley was desirous to make. He says, 'January the 18th, 1699, this morning between two and three o'clock, looking out, I found that my Boatswain who had the watch, steered away NW, instead of West, I conclude with design to miss the Island and frustrate my intent, though they pretended the candle was out in the Binacle and that they could not light it.' At another time, on making the Island *Barbadoes*, he says, 'my Lieutenant having the watch, clapt upon a wind, pretending we ought to go to windward of the Island. He persisted in this course, which was contrary to my orders given over night, and to all sense and reason, till I came upon deck; when he was so far from excusing it, that he pretended to justify it, not without reflecting language. I commanded to bear away NW and NWbN, and before 11, we came to an anchor in *Carlisle Bay*.' This passed in April 1699. Afterwards, but within the course of the same month, being at *Antigua*, he says, 'I was unwilling to wait here any longer, finding it absolutely necessary to change some of my officers, which I found I could not do without returning to *England*.' He sailed accordingly for *England*.

Dr. Halley departed on his second voyage in September, 1699. November the 16th, he crossed the equinoctial line. In the course of many traverses made by him in a high Southern latitude, he observed indications at different times of being near to land; as appear in the following extracts from his Journal:—

'January (1700) Saturday the 20th, latitude by good observation $43^{\circ} 12'$ S. longitude $49^{\circ} 32'$ W from *London*. The colour of the sea is changed to a pale green.'

'Sunday the 21st, latitude $44^{\circ} 22'$ S. longitude $49^{\circ} 29'$ W. Last night the sea appeared very white: abundance of small sea-fowl were about us, and several beds of weeds drove by the ship, of which we took up some for a sample, being of a kind our people had not seen elsewhere.'

'January the 27th. Latitude 50° S. longitude 43° W: penguins were seen.'

'February the 11th. Latitude by account $43^{\circ} 51'$ S. longitude $25^{\circ} 50'$ W. It has been foggy all the morning. Yesterday in the afternoon, we had above twenty alcatrasses about the ship; and this morning, our people saw one of the animals which swim twisting its tail into a bow. I suspect we are near some land or rock by the birds.'

Dr. Halley calculated his longitude and corrected his reckoning from observations of the moon's place in the Heavens, not measured with an instrument, but by noting the time of contact with some star; and sometimes by computing only from their near approximation in a favourable position, at what time they were on the same meridian. The longitude of the Island *Trinidad* was determined in the manner following:

'Thursday April the 11th (1700.) Last night the moon applied to the *Contiguæ in facie Tauri* and I got a very good observation, whence I concluded myself $2^{\circ} 00'$ more to the Westward than by my account. Sunday the 14th, at half past ten in the forenoon, we saw the Islands, or rather Rocks, of *Martin Vaz*. In the afternoon, we saw the Island of *Trinidad*. By my observation of the moon on the 11th instant, I allow it to be in longitude from *London* $29^{\circ} 50'$ W;¹ the North part in latitude $20^{\circ} 25'$ S, the South part in $20^{\circ} 29'$ S at the most.'

Dr. Halley arrived in the *River Thames* on his return from his second voyage, September the 6th, 1700. In 1701, he published his Map of Magnetic Variations. [*Conclusion of Capt. Burney's account.*]

In the Memoir of Halley printed in this volume, these remarks appear: 'In which whole Voyage, he has told me, he was attended with a particular piece of good Fortune, which was, that, tho' he in that time 4 times crost the Line, and went directly from thence into the cold Climates of the South, he lost not one Man, but brought home every Soul with him he Carried out, in good health; a particular, probably, more than to Fortune, owing to his own great Care and that humanity to his Men, which was a very distinguishing part of his Character.'

Substantially the same remarks occur in the corresponding portion of Mairan's 'Eloge' of Halley,² and also in the sketch published in the *Biographia Britannica*, which was based partly upon MS. memoirs supplied by Halley's son-in-law, Henry Price.³ The latter contains the following passage: 'However, this happiness was dashed with the misfortune of losing a favourite boy, who by some unlucky accident was thrown overboard and drowned, and the Captain was so deeply affected with the loss that during his whole life afterwards he never mentioned it without tears.'⁴

If the account by Folkes is correct in the statement, that Halley 'brought

¹ In the requisite Tables published by the Board of Longitude (*London*, 1802) the Longitude of *Trinidad Island* is set down $29^{\circ} 33'$ West of the Meridian of *Greenwich*, which is $13'$ more West than by the Spanish Observations published. [Original note by Capt. James Burney.]

² See the English translation of Mairan's 'Eloge' in *The Gentleman's Magazine*, vol. xvii, p. 455 &c., *London*, 1747; quoted in *Biog. Brit.*, vol. iv, p. 2503, note [o].

³ *Biog. Brit.*, vol. iv, p. 2494, side-note (b).

⁴ *Ibid.*, p. 2503, note [o].

home every Soul with him he Carryed out', we might infer that the 'favourite boy' may have been taken aboard, by Halley, at some island¹ at which he called on his second voyage. We have no evidence of this. The boy's name was Manly White (see Dalrymple: *Voyages in the South Atlantic*, p. 79, London, 1775). If the boy was actually taken out from England, Halley may have meant that he brought back into England every 'man' that he took out.

¹ Perhaps St. Helena. It is known that Halley called at St. Helena, *circa* 30 March 1700. See p. 133 *ante*.

APPENDIX XIII

HALLEY'S TWO MISSIONS TO VIENNA

(1702/3)

The Emperor of Germany, having come to a resolution to make a convenient and safe harbour for shipping, in that part of his dominions which borders upon the Adriatic, Captain¹ Halley was sent this year [1702] by Queen Anne to view the two ports on the Dalmatian coast lying to that sea.²

Ld Treasurer

Whitehall Octo. 26, 1702.

My Lord—The Queen thinking it fitt to employ Mr Edmond HAWLEY in some matters of importance to her Service abroad, has commanded me to acquaint you that shee would have you advance to him the sume of two hundred pounds towards his charges in that employment.

I am, &c.

Nottingham.³

1702. Oct. 26. Letter from the Earl of Nottingham to the Lord High Treasurer. The Queen would have 200 l. advanced to Mr. Edmund Hawley for his charges in going abroad on matters of importance. Dated Oct. 26, 1702. (1 page quarto.)⁴

A.D. 1702, Nov. 6. Edmund HALLEY: to Germany on private business with servants.—Latin. (Full copy.)

Edmd. HAWLEY arm. Lræ Salvi Conductus.

Anna Dei Gratia Magnæ Britannîæ, Franciæ, et Hiberniæ Regina, Fidei Defensor &c. Omnibus et singulis ad quos præsentis Literæ pervenerint Salutem. Quando quidem fidelis et dilectus Nobis Edmundus HALLEY Armiger Nobis humillime supplicaverit, ut veniam ipsi concederemus ad partes transmarinas proficiscendi, præcipue vero Germaniam, locaque vicina adeundi, propter Negotia quædam sua privata, Visum Nobis est ipsius precibus annuere, et quo tutius iter suum tam eundo quam redeundo peragat Literis hisce Nostris Salvi Conductus munire; Rogamus itaque omnes et singulos Imperatores, Reges ac Principes cujuscunque Dignitatis atque Ordinis, Status, Respublicas, et Liberas Civitates, Amicos Nostros et Fæderatos, per quorum Ditiones transiturus est, nec non provinciarum Gubernatores, Exercituum Classiumque Duces, præfectos Limitaneos, Arciumque Custodes, reliquosque in universum Officiales Ipsorum, ac Ministros (id quod Subditis Nostris, quorum ullo modo intererit firmiter injungimus) ut præfato Edmundo HALLEY una cum famulis, sarcinisque suis quibuscunque, non solum ubique locorum liberam et securam eundi, transeundi,

¹ After his two voyages in 1698–1700, and his survey of the English Channel in 1701, Halley was known as 'Captain Halley'.

² *Biog. Brit.*, vol. iv, p. 2512, London, 1757.

³ State Papers Domestic, Entry-book 104, pp. 147–8, Public Record Office, London.

⁴ *Calendar of Treasury Papers, 1702–7*, ed. Redington, London, 1874, p. 71.

redeundi commorandique, prout lubitum erit potestatem faciant, neque aliquam moram Impedimentumve injiciant, aut injici patiantur, verum etiam Eundem Omnibus Humanitatis et Benevolentiae Officiis excipiant adjuventque, ac Novis insuper Salvi Conductus Literis, si res ita postulaverit, communiunt; Quod quidem Nos pari data occasione parate agnoscemus, et vicissim repensuræ sumus. Dabantur in Palatio Nostro Divi Jacobi. Sexto die mensis Novembris, Anno Domini 1702, Regnique Nostri primo.

Anna R.¹

He [Halley] embarked in the Thames on the 27th of November, 1702, went over to Holland, and passed thence through Germany to Vienna, and having conferred with Mr. Stepney,² the English minister there, he proceeded to Istria, with a view of entering on the execution of the Emperor's design; but some opposition being then given to it by the Dutch, he returned to Vienna, where being introduced by Mr. Stepney to Leopold, he gave him an account of two harbours on the Istrian coast. Whereupon his Imperial Majesty presented him with a rich diamond ring from his own finger,³ and gave him a letter of high commendation, written with his own hand to Queen Anne. He was likewise received with great respect by the King of the Romans, by Prince Eugene, and the principal officers of that court.⁴

Presently after his arrival in England, he was dispatched again upon the same business. This time he passed through Osnabruck and Hanover [1703], where he supped with his present [1757] British Majesty,⁵ then Electoral Prince, and his sister the Queen of Prussia.⁶

Arriving at Vienna, he was presented the same evening to the Emperor, who directly sent his chief engineer to attend him to Istria, where they repaired and added some new fortifications to that of Trieste, the port of Boccari being found by the Captain fit to receive all kinds of shipping with safety.⁷ Having seen the work finished, he returned to England, where he arrived just before the great storm which happened November 26, 1703.⁸

¹ State Papers Domestic, Entry-book 389, pp. 30-1; Public Record Office, London.

² George Stepney. Further information regarding Halley's missions to Vienna might be recovered from the inedited correspondence of George Stepney at Vienna and other courts. Addit. MSS. 7058-60, 7063, 7066, 7071-7, 9387, in the British Museum, London. Those papers have not, as yet, been examined in this connexion. (Cf. *Notes and Queries*, 2nd series, vol. xi, p. 225; 10th series, vol. vii, p. 8; 12th series, vol. v, p. 37.)

³ 'The emperor, by the hands of count Mansfelt (president of the council of war at Vienna) presented captain Haley, the famous mathematician sent to view the imperial harbours in Istria, with a diamond ring of great value, and treated him with all the marks of esteem imaginable.' Luttrell, *Brief Relation of State Affairs*, vol. v, p. 285 (1857). (Cf. *ibid.*, vol. v, pp. 228, 265, 278, 306.)

⁴ *Biog. Brit.*, vol. iv, p. 2512.

⁵ George II.

⁶ *Biog. Brit.*, vol. iv, p. 2512. There seems to be no record preserved in the Archives at Hanover, of this visit of Halley, in 1703. It may, perhaps, be mentioned in some of the despatches from the British Resident there, at that time. Addison visited Hanover, in 1703, in company with Alexander Cunningham (1654-1737).

⁷ 'Tuesday, 2 June, 1703. Several engineers are ordered after captain Hawled to fortify the emperors ports on the coasts of Italy, for the security of our men of war, which are to winter there.' Luttrell, *Brief Relation*, vol. v, p. 306.

⁸ *Biog. Brit.*, vol. iv, p. 2512.

1703/4. January 14. Letter from the Earl of Nottingham to the Lord High Treasurer, asking him to order 36 l. to be repaid to Mr. Stepney, her Majesty's Envoy Extraordinary at Vienna, he having paid that amount to Mr. Halley. Dated 14 Jan. 1703-4. *Minuted*:—'25 Jany. 1703/4. Ordered out of secret service.' 1 page.¹

¹ *Calendar of Treasury Papers, 1702-7*, ed. Redington, London, 1874, p. 226 (refers to MS. vol. lxxxix, No. 16).

APPENDIX XIV

AN ACCOUNT OF HALLEY'S INAUGURAL ADDRESS AS SAVILIAN PROFESSOR OF GEOMETRY, AT OXFORD¹

[In a letter from Thomas Hearne, the Oxford Antiquary, to the Rev. Dr. Smith 'at his Lodgings in Dean-Street Soho London', dated Oxford, June 8. 1704:—]

. . . Mr. Hally made his Inaugural Speech on Wednesday May 24. which very much pleased the Generality of the University. After some Complements to the University, he proceeded to the Original and Progress of Geometry, and gave an Account of the most celebrated of the Ancient and Modern Geometricians. Of those of our English Nation, he spoke in particular of Sr. Hen. Savil; but his greatest Encomiums were upon Dr. Wallis and Mr. Newton, especially the latter, whom he styled his Numen etc. Nor could he pass by Dr. Gregory, whom he propos'd as an Example in his Lectures; but not a word all the while of Dr. Bernard

¹ From a transcript of a memorandum in MSS. Rawlinson, Letters 37, No. xi, Bodleian Library, Oxford.

APPENDIX XV

ORIGIN OF THE ROYAL SOCIETY CLUB

[By the kind permission of the Royal Society Club,¹ we are enabled to reprint the account following, from Geikie, Sir Archibald: *Annals of the Royal Society Club*, pp. 6-9, London, 1917; with the original notes.]

The oldest surviving document in the archives of the Royal Society Club bears the date of 27th October 1743. But there can be no doubt that a recognised organisation of members, subscriptions and regular meetings existed before that date. In the 'Sketch of the Rise and Progress of the Royal Society Club' by Admiral W. H. Smyth, there is appended 'An Additional Word,' containing a memorandum from the manuscript collection of the Rev. Sir Richard Kaye, preserved in the British Museum, which affirms that the Club began about the year 1731 under the auspices of the illustrious Dr. Halley. This memorandum is here reproduced, but, as will be shown, its historical value is hardly so great as the Admiral believed it to be.

'Institution of the Philosophical Club, from Sir Joseph Ayloff, an original Member, communicated July 26, 1776.

'Dr. Halley used to come on a Tuesday from Greenwich the Royal Observatory to Child's Coffee-House, where literary people met for conversation, and he dined with his sister, but sometimes staid so long that He was too late for Dinner, and they likewise at their own home.

'They then agreed to go to a house in Dean's Court between an Ale-house and a Tavern, now a Stationer's shop, where there was a great Draft of porter, but not drank in the House. It was kept by one Reynell. It was agreed that one of the Company should go to Knights and buy fish in Newgate Street, having first informed himself how many meant to stay and dine.

'The Ordinary and Liquor usually came to half-a-crown, and the Dinner only consisted of Fish and Pudding. Dr. Halley never eat any Thing but Fish, for he had no Teeth.

'The number seldom exceeded five or six. Sir Joseph Ayloff and Dr. Watson were original members. It began to take place about 1731.

'Soon afterwards Reynell took the King's Arms in St. Paul's Church Yard and desired Dr. Halley to go with him there. He and others consented and they then began to have a little meat. On Dr. Halley's Death, Martin Folkes took the Chair.

'They afterwards removed to the Mitre for the convenience of the situation with respect to the Royal Society, and as It was near Crane Court and numbers wished to become Members, It was necessary to give it a form.

'The number was fixed at Forty Members, one of whom was to be Treasurer and Secretary and three official Members, Secretaries of the Royal Society.

¹ Letter dated 29 August 1928, from Colonel Sir Henry Lyons, Honorary Treasurer of the Royal Society Club, London.

TOASTS.

The King	King of Poland ¹
The Queen	The President (<i>if absent</i>)
Arts and Sciences	Lord Charles Cavendish
Royal Philosophers. ²	

In printing for the first time this communication of Sir Joseph Ayloffé made in 1776, Admiral Smyth pointed out that it contains some obvious inaccuracies, yet he was disposed to accept it as substantially trustworthy and to regard the Royal Society Club as having been actually established by Dr. Halley.

The document purports to have been communicated by its writer in 1776, that is, some thirty or forty years after the occurrence of the incidents to which it refers. It was obviously written from recollection, and without reference to authorities by which lapses of memory could be checked.

The meetings of the Royal Society took place on Thursday and not on Tuesday. Sir Joseph Ayloffé styles himself 'an original member.' But the Club minute-book clearly shows that he was elected on 23rd August 1744 and subsequently lost his membership from non-attendance, his place being filled up on 27th July 1749.² He says in his memorandum that the meetings 'began to take place about 1731.' But the evidence quoted above shows that there were dinners and suppers of the Fellows of the Royal Society long before that year. Sir Joseph Ayloffé was elected into the Royal Society on 27th May 1731, and he may about that time have taken part in some of the social gatherings of the Fellows. His weak memory seems to have led him to believe that the organised Dining Club began then, and that his much later connection with it went back to the same period. Admiral Smyth cites convincing evidence that the dinners which drew Halley on Thursdays to Child's Coffee-house were attended by him many years before he became Astronomer Royal and lived at Greenwich. There are extant letters of Flamsteed to Abraham Sharp, in one of which, dated as far back as 1712, allusion is made to Halley and his associates at the gatherings in that tavern. The Admiral pronounces a well-deserved eulogium of Halley when he describes him as 'at once proudly eminent as an astronomer, a mathematician, a physiologist, a naturalist, a scholar, an antiquary, a poet, a meteorologist, a geographer, a navigator, a nautical surveyor and a truly social member of the community.' But when he claims that this illustrious man was also the founder of the Royal Society Club his enthusiasm has undoubtedly carried him further than the evidence warrants.

The truth would appear to be that informal dinners or suppers, such as took place in the time of Pepys, still continued in the first half of the eighteenth century. These were attended not only by Fellows of the Royal Society, but by friends whom they brought with them, and even sometimes by intruders who chose to dine or sup at the same tavern and, without any introduction, thrust themselves into what they recognised to be a varied and pleasant company. If the President of the Society was present he would naturally be asked to take

¹ How this monarch in particular came to be one of the Club's toasts is suggested in the record of the year 1754.

² He was afterwards balloted for and re-elected into the Club on 25th July 1771.

the chair, if in such improvised gatherings any chairman were desired. But the miscellaneous character of these assemblages coming at last to be too inconvenient, the need would be felt for some organisation that would allow a small number of men of congenial tastes and habits to come into closer touch with each other, and would exclude undesirable visitors.

The earliest trace of such an attempt to obtain more privacy is to be found in the document of 27th October 1743 already alluded to. But some kind of organisation would appear to have been tried before the fresh start recorded in that document. In the Club's first Minute-book, under date January 3rd, 1750,¹ in the presidentship of Martin Folkes, the following minute occurs:—

'At this meeting it was proposed that David Papillon Esq. [F.R.S. 1720] who had been an ancient member of this Club, before the present Establishment (of which he was the first proposer), and the method of standing the Ballott as a Candidate being uncertain, he desired to be admitted a Member on paying the old fine and an arrear of two shillings; and in consideration of services done this Society his request was complied with, and it was resolved that this election should not be a precedent for the future.'

In a subsequent minute in the same volume reference is made to Phillip Miller [F.R.S. 1729] as 'an ancient Member of this Society' (*postea*, p. 46). It would seem probable that some attempts had been made before October 1743 to organise a Club, but that these had fallen into abeyance.

The first distinct evidence of the formation of an organised company which could develop into a Club is to be found in the document of 27th October 1743 which records the result of a meeting of eight gentlemen on that day. It is written on a page of now much foxed foolscap paper which has been preserved by being carefully pasted into the beginning of the first Minute-book of the Royal Society Club. Its contents are these:

	Oct. 27th 1743.
Mr. Postlethwaite -	6s.
Mr. Birch -	6s.
Mr. Colebrooke -	6s.
Mr. Dixon -	6s.
Mr. Watson -	6s.
Captn Middleton -	6s.
Mr. R. Graham -	6s.
Mr. Burrow -	6s.
	} Paid for a month.

£2 8s. paid to Mr. Colebrooke, Treasurer.

A dinner to be ordered every Thursday for 6 at 1/6 per Head Eating=9/ certain.

¹ Minute-book No. 1, p. 13. This date would be 1751 new style.

APPENDIX XVI

HALLEY'S WILL, WITH COMMENTS

'In the name of God, I Edmond Halley, Doctor of Laws and Astronomer in the royal Observatory in Greenwich park being in good health of body, as well as of perfect and sound mind and memory, considering the certainty of death and uncertainty of the time of it, in order when it shall happen, to leave behind me my family in peace, Do therefore make and Declare this my last Will and Testament in manner and form following; Imprimis: I recommend my Soul to the Mercy of Almighty God, And as to my Body, my Will and Desire is that it may be Interred in the same grave with that of my Dear Wife lately deceased, in the Churchyard of Lee in Kent. Next, since my son Edmond is in actual possession of the best part of the Real Estate of the family and may Inherit the rest after my Decease, the whole being of greater Value than the personall Estate I have to leave my two daughters Margaret Halley and Katherine now wife to Mr. Henry Price, And besides he being retained in the Service of the Crown as a Surgeon seems to be sufficiently provided for, my Desire is that he may therewith be Contented and accept of Twenty pounds for mourning. As for my personal Estate consisting in the remainder of a Lease of a House in Cannon St., London, now in the occupation of Mrs. Mary Camm or her Assigns, as likewise in Goods, ready Money, Plate, Books, &c., I give them to my said two Daughters Margaret and Katherine to be equally divided between them, hoping that the division may be made amicably. Lastly I hereby constitute and appoint my said Two Daughters joint Executrices of this my last Will and Testament which is written with my own hand. *Signed:* Edmond Halley. Dated 18th June, 1736. Witnesses: James Bradley, Ellener Simpson. Proved 9th February, 1741-2, by Margaret Halley, spinster, and Katherine the wife of Henry Price. (P.C.C., reg. Trenley, fo. 53.)'¹

The greater portion of the landed estates which, in 1736, were in the 'actual possession' of Edmond Halley, junior, a surgeon in the Royal Navy, had been inherited by him from his mother, Mrs. Mary Halley (born Tooke), who died 30 Jan. 1735/6² and was buried at Lee, 14 Feb.³ That particular property was described as follows: '10 acres of land in Upwell, in the county of Norfolk; 15 acres in Upwell, in a place called Netmore, in the occupation of John May; also lot of 16 acres called Lake's End, in Upwell, in the occupation of John Raper.'⁴ All those lands were once owned by Margaret Tooke (born Kinder) who, in her will, dated 13 Oct. 1710, proved 9 Dec. 1714,⁵ established an entail in favour, successively, of her daughters, Elizabeth Pierson and Mary

¹ See *The Genealogist*, new series, vol. xxv, p. 10 (1908-9).

² Boyer's *Political State of Great Britain*, vol. li, p. 215.

³ *Register of St. Margaret, Lee*, p. 56; and *Notes and Queries*, vol. cliii, p. 212 (1927).

⁴ *Notes and Queries*, 10th series, vol. viii, pp. 221-2, 373 (1907).

⁵ *Ibid.* (Cf. *ibid.*, vol. cliv, p. 208, 1928.)

Halley, and the latter's son, Edmond Halley, junior, and his heirs; failing such, then to his two sisters, Margaret and Catherine.¹

Surgeon Halley died at or near Portsmouth, 7 Feb. 1740/1, and was buried at Gosport, 9 Feb., as shown by an entry in the register of Holy Trinity Church.² He was married but seems to have died without issue, for all the properties in county Norfolk, mentioned in the will of his grandmother, Margaret Tooke (*ob.* 1714), are again described in the will of his younger sister, Mrs. Catherine Price (formerly Butler, born Halley), dated 8 July 1764, proved 14 Nov. 1765.³ The latter named, as her eventual heir, Halley Benson Millikin, who appears to have been a great-grandson of Margaret Tooke.⁴ Halley Benson Millikin married Elizabeth Parry. Both are mentioned in the will of the latter's mother, Susannah Parry, widow, of Leytonstone, Essex, dated 25 April 1780, proved 13 Nov. 1784.⁵ Halley Benson Millikin is mentioned, again, in the will of his aunt, Margaret Entwisle, dated 29 April 1789, proved 2 Mar. 1793.⁶

Soon after the death of the astronomer Halley's elder surviving daughter, Margaret Halley, 13 Oct. 1743, an indenture was made, 26 Nov. 1743, of which there is a record, in the index of fines, at the Public Record Office, London. It is described as follows:

'1743 {
Norf.
Midd. } Francis Smith, plnt.
Lond.)

and Henry Price, of Upwell, in the county of Norfolk, and often in the parish of St. Mary Matfelan, in the county of Middlesex, and often in the parish of St. Olave, Silver St., deft.' The original document, which is missing, may be preserved among the title-deeds of the present owner of the lands in county Norfolk.⁷ Most of these lands appear to have been converted to public use. The sixteen acres at Lake's End, Upwell, were said to be owned, *circa* 1924, by Mr. Arthur Stevens, and occupied by Mr. William Turner.⁸

We have still to consider the 'rest' of the Halley properties which were in the possession of the astronomer when he made his will, dated 18 June 1736. As he made no change in his will after the death of his son, Edmond, junior, 7 Feb. 1740/1, and as we find no record of the grant of any letters of administration to make disposition of any such Halley properties, we may infer that the astronomer sold or transferred them previously to his own death, 14 Jan. 1741/2. This, however, is not entirely clear. Mrs. Catherine Price, as of the parish of St. Mary Woolnoth, London (*ob.* 1765), mentions in her will (in

¹ *Notes and Queries*, 10th series, vol. viii, pp. 221-2, 373 (1907).

² *Ibid.*, vol. cliii, p. 410 (1927).

³ *Ibid.*, 10th series, vol. iii, p. 6 (1905); 12th series, vol. xi, p. 532 (1922); vol. xii, p. 191 (1923); vol. cliv, p. 208.

⁴ *Ibid.*, 10th series, vol. viii, pp. 221-2, 373 (1907).

⁵ *Ibid.*, 12th series, vol. xii, p. 191 (1923); vol. cxlvii, p. 16 (1924).

⁶ *Ibid.*, vol. cliii, p. 251 (1927).

⁷ *Ibid.*, 10th series, vol. viii, p. 222 (1907).

⁸ *Ibid.*, vol. cxlvii, p. 16 (1924).

addition to the lands in county Norfolk) certain other properties: 'also the "Hen and Chickens" in Whitechapel High Street, in the occupation of John Allen; also one undivided third part of tenements in Noble Street, in the parish of St. Olave, Silver Street.'¹ The latter may have come to her from her first husband, Richard Butler,² or from her second husband, Henry Price.³ It has been suggested that the 'Hen and Chickens' may, originally, have been a seat of the astronomer's grandfather, Humphrey Halley, vintner. The latter's will, however, does not mention any entail⁴ and, as before stated, there appears to be no grant of letters of administration for an intestate portion, if any, of the astronomer's property. Therefore, it is not easy to see how Mrs. Price could have acquired it from, or through, her father.

Some dealings with the 'Hen and Chickens', by Mrs. Catherine Price, are shown by entries in the records of the Middlesex Land Registry, *circa* 1743/4. Mrs. Price seems to have put her properties in the hands of her cousin, Francis Smith, silk dyer, in trust for herself and her husband, Henry Price. A search of the index at the Middlesex Land Registry, for the period 1730-70, did not reveal the name of Halley. If any land in the county of Middlesex (this, of course, does not include the city of London), passed by will or by sale, during that period, a record of the fact would, or should, have been made in the Middlesex Land Registry.

The litigation, *post* 1684, between the astronomer Halley and his step-mother, Mrs. Joane Cleator (? Chester),⁵ leads one to think that there were houses in London, but, as previously suggested, they may have been, probably were, sold or transferred by the astronomer, during his lifetime.

Other data may, perhaps, be recovered in future, which, possibly, will cause a modification of the views expressed herein, as to some details. The facts presented indicate that the astronomer Halley had no grandchildren.⁶

¹ *Notes and Queries*, 10th series, vol. iii, p. 6 (1905).

² Richard Butler, of St. Martin's-le-Grand, widower, and Catherine Halley, of Greenwich, were married 2 Oct. 1722 (*Register of St. Margaret, Lee*, p. 13).

³ Henry Price, as of St. Andrew's, Holborn, made his will, dated 31 May 1755, which was proved 20 January 1764, making his wife his sole heir. (*The Genealogist*, new series, vol. xxv, p. 12, 1908-9.)

⁴ *Ibid.*, p. 6.

⁵ Chancery Proceedings before 1714, Hamilton, bundle 181, No. 90, 'Edmund Halley v. Robert Chester [? Cleator] and Joane, his wife'; also 'Clater v. Young', 1694 (280, No. 71).

⁶ *Notes and Queries*, vol. cliv, pp. 208, 250 (1928). No search has, as yet, been made for any Chancery Proceedings, *post* 1735, relating to 'Halley' or 'Price'.

APPENDIX XVII

INSCRIPTIONS ON HALLEY'S TOMB AT LEE

Halley died at Greenwich, 14 January 1741/2¹ and was buried six days later, in the church-yard of St. Margaret, Lee.² 'Over the grave, which is near the fence on the east side of the church-yard, there stands a handsome tomb of Portland stone, erected by his two surviving daughters, upon the face of which is the following inscription in Latin.'³

Sub hoc marmore
Placide requiescit, cum uxore carissima,
EDMUNDUS HALLEIUS, LL. D.
Astronomorum sui seculi facile princeps.

Ut vero scias lector
Qualis quantusque vir ille fuit,
Scripta ejus multifaria lege;
Quibus omnes fere artes & scientias
Illustravit ornavit amplificavit.

Æquum est igitur
Ut quem cives sui vivum
Tantopere coluere,
Memoriam ejus posteritas
Grata veneretur.

Natus } Est A. C. { MDCLVI.
Mortuus } { MDCCXLI.

Hoc saxum optimis parentibus
Sacrarunt duæ filiæ pietissimæ
Anno MDCCXLII.

Here also is interred Mrs. Margaret Halley,
Eldest daughter of the above Dr. Halley,
Who died on the 13th of Octob. 1743.
In the 55th year of her age.

The above inscription is thus rendered into English:

'Under this marble, together with his beloved wife, rests Edmund Halley, LL. D. unquestionably the greatest astronomer of his age. But, to conceive an adequate idea of the excellencies of this great man, the reader must have recourse

¹ i.e. 25 January 1742, n.s. *Notes and Queries*, 9th series, vol. xi, p. 366 (1903). 'On Thursday night died, aged 82 [sic], at Greenwich-Park, Dr. Edmund Halley, Astronomy-Professor to his Majesty' (*The Daily Advertiser* [London], Saturday, 16 January 1742, p. 1).

² *Register of St. Margaret, Lee*, p. 58 (Lee, 1888); and *Lysons' Environs of London* (1811), vol. i, p. 555.

³ *Biog. Brit.*, vol. iv, p. 2517, London, 1757. The inscription and translation, as presented here, are from a photostat copy of the printed text in *Hughson's London* (1809), vol. vi, p. 348. Cf. *Notes and Queries*, vol. cliii, pp. 159, 192 (1927).

to his writings; in which almost all the sciences are in the most beautiful and perspicuous manner illustrated and improved. As when living, he was so highly esteemed by his countrymen, gratitude requires that his memory should be respected by posterity.

Born) in the year (1656.
Died) (1741.

To the memory of the best of parents their affectionate daughters have erected this monument, in the year 1742.¹

Other inscriptions were added later:¹

Also Mrs Catharine Price youngest
daughter of the above Dr Halley
Who died Novr the 10th 1765 aged 77 Yer
And Mr Henry Price her husband

On the west end of the tomb is the following:²

Restored
by
The Lords Commissioners
of the Admiralty
1854.

John Pond (1767–1836), a later Astronomer Royal, was buried in Halley's tomb.³

The inscription relating to Halley appears also in some extracts made by T. T. Wilkinson from Reuben Burrow's manuscript 'Journals'.⁴ Immediately after the inscription, Wilkinson quotes an entry by Burrow, as follows: 'Mem. To call on Lord Cavendish next Tuesday at 10 o'clock.'⁵ This close juxtaposition appears to be entirely irrelevant, for there is a space of two pages between the inscription and the 'Mem.', in the original manuscript 'Journal'. The extracts printed by Wilkinson, from the manuscript Journals, show that Burrow was employed by Lord Charles Cavendish to make some mathematical calculations. All this, evidently, has no connexion whatsoever with Halley and may be dismissed.

When Halley's tomb was restored, in 1854, the original tombstone was moved, for security, to Greenwich, where it was let into the wall of the Royal Observatory, in an upright position.⁶

In 1909 the Admiralty decided to repair Halley's tomb, at the public expense.⁷

In *The Putney News-Letter*, 29 January 1910, p. 9, was reproduced a

¹ *Notes and Queries*, 9th series, vol. xi, p. 496 (1903); vol. cliii, p. 159 (1927).

² *Ibid.*, vol. cliii, p. 159 (1927).

³ *Ibid.*, pp. 116, 159, 192, 228, 410 (1927).

⁴ *Mathematics and Mathematicians*. The Journals of the late Reuben Burrow. By T. T. Wilkinson Esq., F.R.A.S. *The London, Edinburgh and Dublin Philosophical Magazine*, 4th series, vol. v p. 517 (1853).

⁵ *Ibid.*

⁶ *Notes and Queries*, 10th series, vol. ix, p. 166 (1908).

⁷ *The Spectator*, 20 Nov. 1909, in a review of the *Story of the Comets*, by G. F. Chambers, F.R.A.S.

photograph of Halley's tomb. In the same year, Mr. Edward North, verger of St. Margaret's, Lee, kindly sent to the present editor a copy of that photograph, which is again reproduced herewith.¹

There is also in the Library of the British Museum an old drawing of the inscription, with a representation below of the tomb itself.²

¹ Mr. Charles North, parish clerk of St. Margaret's, Lee, also generously transmitted some useful information.

² Of this drawing of the inscription and tomb a photograph was kindly supplied by Mr. F. W. Nunn, of Lee, formerly Honorary Secretary of the Greenwich Antiquarian Society.

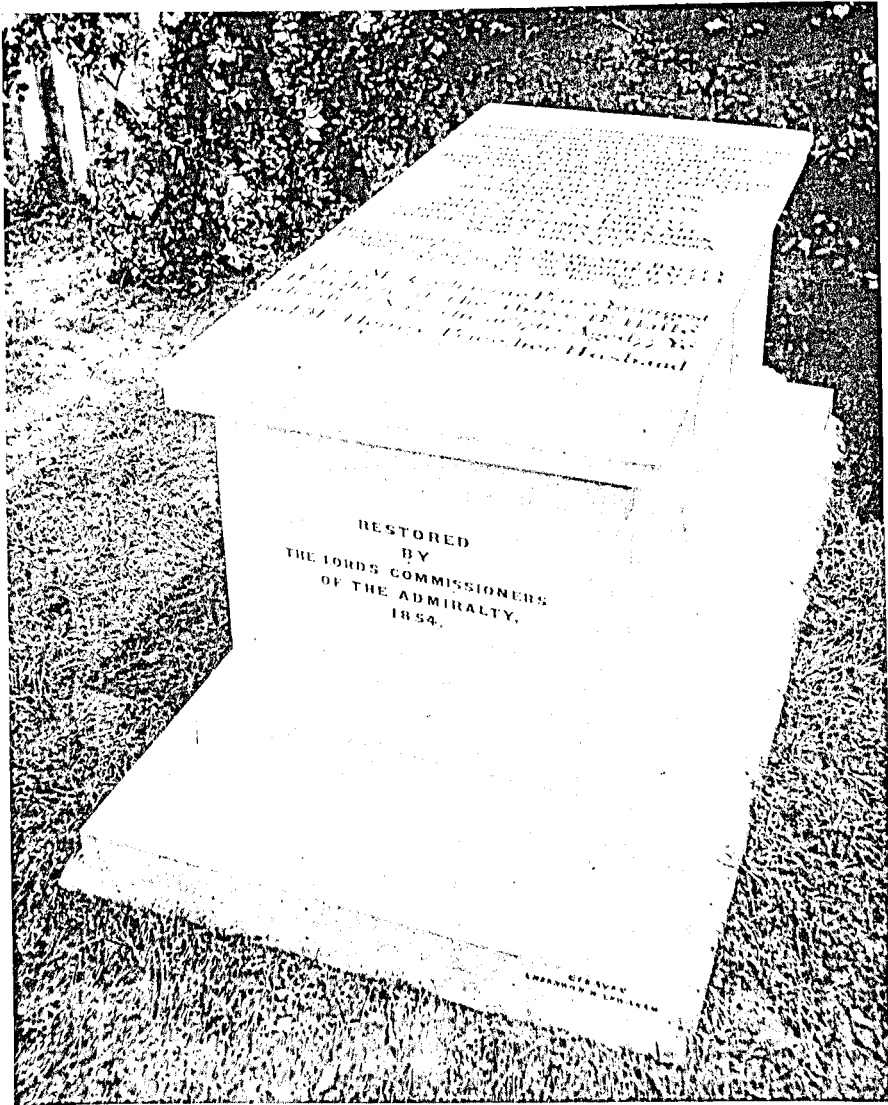

HALLEY'S TOMB IN LEE CHURCHYARD

APPENDIX XVIII

HALLEY'S CHARACTER AND PERSONALITY

One of the earliest characterizations of Halley is that in the *Biographia Britannica*,¹ which I give here in my first paragraph.

'With regard to Dr. Halley's character it may be observed, that in his person he was of a middle stature, inclining to tallness, of a thin habit of body, and a fair complexion, and always spoke as well as acted with an uncommon degree of sprightliness and vivacity. As he was a member² whose name reflects an honour upon the Royal Academy of Sciences at Paris, Mr. Mairan, a member thereof, read, according to custom, the Éloge . . . of him before that Academy in 1742.³ Wherein after an oratorical account of the universality of his genius, and the boldness of his philosophical hypotheses, the conclusion presents us with the following particulars relating to the character of our author's temper and manners, communicated by Mr. Folkes,⁴ who succeeded him in the French Academy, and was then President of the Royal Society. He, Dr. Halley, says this Éloge writer, possessed all the qualifications necessary to please princes who were desirous of instruction, great extent of knowledge, and a constant presence of mind; his answers were ready, and at the same time pertinent, judicious, polite and sincere. When Peter the Great, Emperor of Russia, came into England [1698], he sent for Mr. Halley, and found him equal to the great character he had heard of him. He asked him many questions concerning the fleet which he intended to build, the sciences and arts which he wished to introduce into his dominions, and a thousand other subjects which his unbounded curiosity suggested; he was so well satisfied with Mr. Halley's answers,⁵ and so pleased with his conversation, that he admitted him familiarly to his table, and ranked him among the number of his friends, a term which we may venture to use with respect to a prince of his character; a prince truly great, in making no distinctions of men but that of their merit. But Mr. Halley, continues this writer, possessed still more of the qualifications necessary to obtain him the love of his equals. In the first place, he loved them; naturally of an ardent and glowing temper; he appeared animated in their presence with a generous warmth which the pleasure alone of seeing them seemed to inspire; he was open and punctual in his dealings; candid in his judgment; uniform and blameless in his manners, sweet and affable, always ready to communicate and disinterested. He opened the way to wealth by all that he had effected for the improvement of navigation. To the glory of which he has added that of having done nothing to enrich himself; he lived and died in that mediocrity so extolled

¹ *Biog. Brit.*, vol. iv, pp. 2517-19, London, 1757.

² Halley was admitted a foreign member of the Academy in August 1729 (cf. *Histoire de l'Académie des Sciences*, 1742, p. 183, Paris, 1745).

³ Mairan: 'Éloge de M. Halley', as translated into English in *The Gentleman's Magazine*, vol. xvii, pp. 455-8, 503-7, London, 1747.

⁴ Martin Folkes (1690-1754).

⁵ *Notes and Queries*, vol. clv, p. 87 (1928).

by philosophers, the free choice of which implies a great degree both of virtue and wisdom.'

'The reputation of others gave him no uneasiness, and a restless jealousy and anxious emulation were strangers to his breast. He was equally ignorant of those extravagant prejudices in favour of one nation which are injurious to all others. The friend, countryman and disciple of Newton, he spoke of Des Cartes with respect; and successor to Dr. Wallis, he did justice to the memory of our ancient geometricians, and in the introduction to an algebraical memoir which he read to the Royal Society, he made no difficulty to acknowledge that Harriott, Oughtred, and many others, as well English as foreigners, had taken from Viete all that was valuable in whatever they had published on that subject.'

'To conclude, these uncommon and valuable qualifications were tempered, in Mr. Halley, with a vein of gaiety and good humour which neither his abstracted speculations, the infirmities of old age, nor the palsy itself which seized him some years before his death, could impair, and this happy disposition, the gift of Nature, was the more perfect as it was still attendant upon that peace of mind which is the nobler endowment of virtue.'

'Halley was open-hearted, generous, and quick to lend a hand. He was free from jealousy and much more enthusiastic about the success of Newton's *Principia* than regarding anything that he himself accomplished, yet his own many achievements made him the 'second most illustrious of Anglo-Saxon philosophers'.

About a century ago, a rather bitter controversy with regard to the moral and religious character of Newton and Halley was precipitated by the publication of some aspersions cast upon them in the private correspondence of John Flamsteed, the first Astronomer Royal, of whom a long 'Account', by Francis Baily, appeared in 1835.⁴ An article on this work appeared in *The Quarterly Review* (vol. lv, pp. 96-128, London, 1836) and added fuel to the flames of dispute. A pamphlet by the Rev. Wm. Whewell, M.A., Fellow and Tutor of Trinity College, Cambridge, took up the defence of Newton.⁵ Other articles and notes followed.⁶ Baily printed, in 1837, at his own expense, a 'Supplement' to his *Account of Flamsteed*. (The parent volume and the 'Supplement' are paginated continuously.)

We refrain from making any comments on the controversy between Newton and Flamsteed, as being outside our present purpose. So far as Flamsteed's reflections upon Halley may be concerned, the matter seems to have been summarized⁷ in the paragraphs following: 'Halley, however, the Edinburgh

¹ and ² Mairan's 'Éloge', as translated in *The Gentleman's Magazine*, 1747, vol. xvii, pp. 506-7.

³ *Nature*, vol. xxi, 1880, p. 303; quoted in *Notes and Queries*, 9th series, vol. xii, p. 465 (1903).

⁴ *An Account of the Rev. John Flamsteed . . .*, by Francis Baily, Esq., F.R.S., &c., London, 1835, 4to, 672 pages (printed, at the public expense, by the Lords Commissioners of the Admiralty).

⁵ Whewell's pamphlet was subsequently revised and reprinted.

⁶ *The Quarterly Review*, vol. lv, pp. 568-72; *The Edinburgh Review*, vol. lxii, pp. 359-97; *The London & Edinburgh Philosophical Magazine and Journal of Science*, vol. viii, pp. 139-47, 214, 220, 225, 1836.

⁷ *Lond. & Edinb. Philos. Mag.* (as above), wherein, preceding this quotation, are some

Reviewer adds, "was better acquainted with Flamsteed's business, that is, with practical astronomy, than any other individual; and hence Flamsteed's anxiety, of which some amusing instances occur, to keep him in ignorance of what he was doing." Flamsteed, as our extracts have made evident, entertained a most exalted opinion of his own importance, and the superiority of his knowledge of astronomy. Halley commenced his scientific career as an astronomer, and by making a catalogue of stars; and therefore from the first was placed in a situation of direct rivalry with him. He had likewise acquired, by the versatility of his pursuits and employments, a large share of popular fame, of which Flamsteed appears to have been not a little envious. *The Quarterly* asserts that Halley was "low and loose in his conduct, and a shameless infidel." On this subject the *Edinburgh* says: "It has been surmised that Flamsteed's aversion to Halley arose from the libertine conduct and infidel opinions¹ which the latter entertained, and took no pains to conceal. *We have no evidence of this!*"²

"Flamsteed's charges are exaggerated to a degree that at the present time makes them appear almost ludicrous."³

"To this more might be added from the records of the time in proof of Flamsteed's bad disposition and disingenuousness,⁴ of which what is called his piety cannot be received as an extenuation, as it appears to have consisted in claiming the Deity as his partisan in all his quarrels. Nor can his belief in judicial astrology be lost sight of, nor his journey to Ireland to be touched for the benefit of his diseased body by a gentleman, "whose gift," he tells us, "was of God."

'Halley was of a jovial and convivial disposition, fond of society and enjoyment, and from Flamsteed's remarks⁵ on his disposition to raillery and banter, we may suppose that he sometimes exercised those talents at the expense of the astronomer; for which, indeed, the numerous salient points of his character afforded abundant temptation. Yet these companionable qualities would seem to have produced their usual effect even on the reserved and precise character of Flamsteed. 'I hate his ill manners, not the man: were he either honest,

remarks about Flamsteed's objections against any 'visitors' being appointed by the Royal Society to supervise his administration of the Royal Observatory at Greenwich.

¹ 'It appears that Newton sometimes gravely and kindly expostulated with Halley upon the latter subject: Flamsteed reviled him and calumniated his moral character' (original note by the editor of *The Lond. & Edinb. Philos. Mag.*, vol. viii, p. 146, 1836). Cf. Seward's *Anecdotes*, vol. ii, pp. 324-5, 1798; and Nichols's *Literary Illustrations*, vol. iv, p. 33.

² These italics were added by the writer of the article in *The Lond. & Edinb. Philos. Mag.*, when quoting from *The Edinburgh Review*, vol. lxii, pp. 393-4.

³ Cf. *The Edinburgh Review*, loc. cit.

⁴ 'See his conduct with regard to Hooke, in the Royal Society, Nov. 2, 1681, and Feb. 15, 1682, when he attempted to escape the disgrace due to his confident ignorance by a low fraud' (original note by editor of *The Lond. & Edinb. Philos. Mag.*, vol. viii, p. 146, 1836).

⁵ 'Dr. Wallis is dead—Mr. Halley expects his place—who now talks, swears and drinks brandy like a sea-captain,' *The Edinburgh Review*, vol. lxii, p. 393, note, quoted from *The Quarterly Review*, vol. lv, p. 112, as an extract from a letter, dated 'The Observatory Greenwich Dec. 18, 1703', from Flamsteed to Abraham Sharp (cf. Baily, *Account of Flamsteed*, pp. 215-16, 1835). 'Flamsteed was of a morose, unsociable disposition; and in the latter part of his life, was upon bad terms with most of his contemporaries' (Thomson, T., *History of the Royal Society*, p. 335, London, 1812).

or but *civil*, there is none in whose company I would rather desire to be."¹

There is no doubt that Halley did hold liberal views on religion and was very outspoken concerning the subject. His frankness is proof of his honesty and sincerity, as De Morgan has pointed out.² Yet Halley was by no means an atheist; he often asserted his belief in the deity; nor should we construe, as being merely formal, the wording of his will written by his own hand.³

When Halley applied, in 1691, for the Savilian Professorship of Astronomy, at Oxford,⁴ his orthodoxy was doubted, and he had an encounter with Bishop Stillingfleet, who was rather confident of his own superiority.⁵ Of the latter's arbitrary and arrogant attitude, there are several incidents in proof. In the *Table-talk of Bishop Hough*⁶ appears this anecdote:

'Bishop Stillingfleet fell very foul upon the famous Dr. Halley too on the same account, who came to expostulate with him upon the occasion. The bishop began to ask him some questions. The Doctor told him, "My Lord, that is not the business I came about. I declare myself a Christian and hope to be treated as such."⁷

It appears that Halley was questioned also by Dr. Bentley, chaplain to Bishop Stillingfleet. Whiston, in his *Memoirs*, says:⁸

'And now, before I quite leave Dr. Bentley,⁹ and bishop Stillingfleet, I will add another thing which I also had from Dr. Bentley himself. Mr. Halley was then thought of for successor, to be in a mathematick professorship at Oxford; and bishop Stillingfleet was desired to recommend him at court; but learning that he was a skeptick, and a banterer of religion, he scrupled to be concern'd; 'till his chaplain, Mr. Bentley, should talk with him about it; which he did. But Mr. Halley was so sincere in his infidelity, that he would not so much as pretend to believe the christian religion, tho he thereby was likely to lose a professorship; which he did accordingly; and it was then given to Dr. Gregory:¹⁰

¹ *The Edinburgh Review*, vol. lxii, p. 393.

² See *Cabinet Portrait Gallery of British Worthies*, vol. xii, pp. 8, 10, 13-15, London, 1847. This unsigned essay on Halley is evidently by Augustus De Morgan, as stated by Professor Jourdain in his edition of *Essays on the Life and Work of Newton*, p. 21, note 2, Chicago, 1914.

³ See Appendix XVI, p. 255.

⁴ In competition with Dr. David Gregory (1661-1708).

⁵ *Collectanea*, 2nd series, edited by Montagu Burrows, M.A., vol. ii, p. 399, Oxford, 1890.

⁶ *Ibid.*

⁷ In Hearne's *Remarks*, vol. iii, pp. 472-3, is this entry: 'Mr. Proast sd yt a friend of Mr. Hallys told him, yt Mr. Hally bilieud a God, & yt was all. & yr was a story that Mr Hally went to Dr. Stillingfleet, & yt he told him yt he bilieud a God & that was all' (quoted by Hearne from a memorandum 'in the handwriting of Dr. Thomas Crosthwait', given to Hearne by Dr. Hudson, 8 Oct. 1712).

⁸ *Memoirs of the Life and Writings of Mr. William Whiston, containing Memoirs of Several of his Friends also. Written by Himself.* The second edition, corrected. London, 1753, p. 108.

⁹ Edward Rud's *Diary, 1709-1720*, ed. Luard (London, 1860), contains a number of remarks about Bentley, showing his arbitrary character. Luard, in his Preface (*ibid.*, p. iv), says of Bentley: 'Utter want of principle and an overbearing tone and manner to all who opposed him are very manifest.' Cf. Nichols: *Illustrations of the Literary History of the XVIIIth Century*, vol. iv, pp. 32-3, London, 1822.

¹⁰ In certain of the MSS. Rawlinson, in the Bodleian Library, Oxford, there are several

Yet was Mr. Halley afterwards chosen into the like professorship there without any pretence to the belief of christianity.¹ Nor was there any enquiry made about my successor Mr. Sanderson's christianity, even when the university of Cambridge had just banished me for believing and examining it so thoroughly, that I hazarded all I had in the world for it.'

Arago, in his brief biography of Halley,² pays a high tribute to him, which, at the same time, gives us a point of view that is typically French. 'Halley fut l'ami de Newton, plus âgé que lui de quatorze ans; ceci peut être cité comme un titre de gloire même pour un homme du mérite de Halley. Il arracha à son ami, en 1686, la *Philosophie naturelle*, que ce grand homme ne s'empressait pas de publier, et s'en rendit l'éditeur. Cette union de deux hommes célèbres ne fut obscurcie par aucun nuage. Ce fait est d'autant plus digne de remarque que Newton était profondément pieux, et que Halley, comme l'assurent tous ses contemporains, portait le scepticisme jusqu'à ses dernières limites.³ La tolérance dont ces hommes illustres se montrèrent animés, le respect que des opinions consciencieuses leur inspirèrent réciproquement, méritent d'être offerts dans tous les temps en exemple à des esprits qui voudraient imposer d'autorité leurs systèmes ou leurs croyances sans avoir les mêmes titres à la confiance publique.

'Halley méritera de vivre dans la postérité comme un des savants qui ont le plus contribué aux progrès de l'astronomie. Son génie scientifique fut apprécié de bonne heure, parce qu'il était uni au plus noble caractère.'

We may allow the case to rest here, with the extracts following,⁴ from the able pens of S. P. Rigaud and Sir David Brewster. First come Rigaud's remarks, the original printed text of which was accompanied by one note, of which we reprint here a part, identified by initials in brackets: [S.P.R.]. Next following the remarks by Rigaud, are those of Sir David Brewster, together with his original notes in full, without any addition or change, except only that the first note has been amplified to give specific reference to the *Biographia Britannica*, 2nd edition, vol. ii, pp. 256-7 (London, 1780). Therefore, Brewster's notes require no further identification, but his initials are added in brackets, thus: [D.B.].

sketches of Halley and a few anecdotes about him. One, in part, is as follows: 'These and such like stories made the Dr. to be taken for a very free thinker, and hindered him of one of the Savile Professorships at Oxford in his competition with Dr. Gregory. Upon which a Scot a stranger came several times to a Coffee House wch Dr. Halley used, and often asked the man after him. But the Dr. not happening to come, the man enquired after his pressing business. Why Sr (says he) I would fain see the man that has less religion than Dr. Gregory.' (MS. Rawlinson, J. No. 4. 2.)

¹ Halley was appointed Savilian Professor of Geometry at Oxford in 1704.

² Arago, François, *Œuvres*, vol. iii, pp. 367-9, Paris, 1855.

³ Arago, at this point, goes too far. Halley did not deny the existence of a deity. (Cf. MS. Rawlinson, J. 4. 2, fos. 105 and 106, in Bodleian Library, Oxford.)

⁴ Printed from photostat copies supplied by The John Crerar Library, Chicago, of the original printed texts, as follows: Rigaud, S. P., Paper on Newton, Whiston, Halley and Flamsteed in *The London & Edinburgh Philosophical Magazine*, vol. viii, pp. 219-21 (1836); Brewster, Sir David, *Memoirs of the Life, Writings and Discoveries of Sir Isaac Newton*, vol. ii, pp. 164-6 (Edinburgh, 1855).

[*S. P. Rigaud's Remarks*]

I have not the slightest wish to take in any way from what may be justly due to Flamsteed; on the contrary, I honour his self-devotion to that department of science in which he was qualified so eminently and so usefully to excel; I honour his independence and noble application of his own property to his great (and it ought to have been national) object; I respect his religion, but I fear that I do not adopt so high a view of it as some of his indiscriminating admirers. I do not mean to express any doubts of his opinions on the great truths of Revelation, or of his general intention to conform his conduct to the dictates of Christianity; but his unhappy temper, irritated by disease, was suffered to become ungovernable. 'If any man seem to be religious and bridleth not his tongue, but deceiveth his own heart,' the apostle has told us the state to which he may be reduced. I presume to judge no one or to pronounce that 'his religion is vain'; but, with every allowance for the weakness of human nature, I must say, that professions of forgiveness too frequently repeated, and constant assumption of the special favour of Heaven, are, when unaccompanied by kind thoughts and mild language, the sources of very painful impressions.

To enter fully into the character of Halley would require more time and space than can now be assigned to it; but there is one point which must not be passed over. To call him a 'self-convicted infidel' is, to say the least, strong language, which when applied to the mighty dead, should not have been used without mature consideration. The authority, from which it is derived, was probably Whiston's account of the election in 1691 to the Savilian Professorship. The application, that Whiston makes of it to his own case, might have suggested the possibility of some bias in the direction which he gives to the story; and as the question is now about Halley's own view of his opinions, we have much better evidence in a letter which he wrote on the 22nd of June, in the same year, to Mr. Abraham Hill, which proves that, so far from submitting of necessity to an examination, in which he was likely to bear himself, as Whiston reports, with unbending defiance towards Bentley, *he courted the inquiry in confidence of being able to clear himself from the charge which was brought against him*. The letter likewise supplies us with the definite nature of this charge; for it mentions a *caveat* having been entered against him till he could show that he was 'not guilty of asserting the eternity of the world.' This objection necessarily¹ involved his being an atheist, and not merely a sceptic as Whiston says, which shows again the inaccuracy of his relation. It may be from the fault of a bad memory, it may be from a limited extent of reading, but I can at this moment recall to my recollection no one passage, in which Halley has published anything profane; and I may add that in some disquisitions on the general deluge, which he published in the Philosophical Transactions, he treats the Scripture account with all due respect. These disquisitions seem also to supply

¹ This, perhaps, should not be assumed as a necessary consequence, lest injustice should be done to those philosophers, both heathen and Christian, who, *salvâ pietate*, have entertained the notion of the eternity of the world as the coexistent effect of an Eternal Intelligent Cause; the Stoics, for instance, Volkelius, &c. [S.P.R.]

a clue to the cause of the *caveat*; for having reasoned on the dislocations visible on the earth's surface, he subjoined an explanation of his hypothesis, because it was suggested to him that those changes might rather have happened in times before the Mosaic creation, (when a former world was possibly reduced to chaos, out of whose ruins the present might be formed,) than at the period of the Deluge. This, in the eyes of many religious persons, may then have amounted to a heinous offence; but whether it did so with justice may now be safely left to the determination of Christian geologists. The passage immediately referred to occurs indeed in the Philosophical Transactions for 1724; but Halley had treated of the Deluge in the 190th number of the same collection, which, having been published in 1687, makes it not improbable that he may then, in discussing the subject among his friends, have used the same topics, and have thus raised the storm which burst on him in 1691. But to return to the term originally objected to: it was proposed, in 1691, to send in testimonials of Halley's character to the electors of the Savilian Professor; and the form, in one part, said that his friends recommended him from their 'own long experience of his mathematical genius, probity, sobriety, and good life.' This passage is copied from a paper in Halley's own handwriting, and shows that 'self-convicted' is the last term which can with propriety be applied to him. I hope that I feel as much as any man a deep abhorrence of irreligion, and I would not say a word to palliate its baneful nature; but to overload accusations of this kind with unsupported prejudice seems to me to be the surest way of destroying their effect.

[*Sir David Brewster's Remarks*]

He [Halley] was a man of the world, much esteemed in society, but was generally supposed to entertain infidel opinions. Under this impression, Bishop Stillingfleet refused to recommend him to the Savilian Chair of Geometry in Oxford, when he was a candidate along with David Gregory; and Bishop Berkeley, on very imperfect information, rashly ventured to dedicate the Analyst to him as an 'infidel mathematician.' 'Mr. Addison,' as has been stated,¹ 'had given Bishop Berkeley an account of their common friend Dr. Garth's behaviour in his last illness, which was equally displeasing to both these advocates of revealed religion. For when Mr. Addison went to see the Doctor, and began to discourse with him seriously about preparing for his approaching dissolution, the other made answer, "Surely, Addison, I have a good reason not to believe these trifles, since my friend Dr. Halley, who has dealt so much in demonstration, has assured me that the doctrines of Christianity are incomprehensible, and the religion itself an imposture." ' Flamsteed never scrupled to denounce Halley as a libertine and an infidel; and we regret to see that a modern writer has ventured to say that Halley was low and loose in his moral conduct, and an avowed and shameless infidel.² Had such been his character, he never would have been the friend and companion of Newton. It is quite true that

¹ *Biog. Brit.* [2nd ed.], vol. ii. p. 256 [-257, London, 1780], or, *The Works of GEORGE BERKELEY*, D.D., Bishop of Cloyne, p. viii. Lond. 1837. [D.B.]

² *Quarterly Review*, vol. lv. p. 112. [D.B.]

Halley was sometimes checked by Newton when he had said anything that appeared disrespectful to religion, by the mild reproof, 'I have studied these things—you have not;' and I have found a memorandum signed by Mrs. Conduitt, in which she says that Newton 'could not bear to hear any one talk ludicrously of religion, and that he was often angry with Dr. Halley on that score, and lessened his affection for Bentley.' Thus placed in the same category with Dr. Bentley, we have no doubt that Halley's speaking ludicrously of religion amounted to nothing more than his maintaining certain opinions about the existence of a pre-Adamite earth, and ridiculing vulgar errors which have been too frequently associated with religious truth.¹

These three eminent individuals were, in the years 1694 and 1695, engaged in nearly the same researches. They were all intently studying the irregularities of the moon's orbit,² and had Halley not been a party, there is reason to believe that no difference would have arisen between Newton and Flamsteed. We have failed, like Mr. Baily, to discover the ground of Flamsteed's virulent antipathy to Halley, evincing a degree of hatred which no Christian could rightly cherish, and which no honourable man could avow, and still less record. The charge of infidelity and libertinism was, we fear, but the mask under which personal feelings were too readily expressed; and if David Gregory's memorandum of him be true, we have a satisfactory explanation of the origin of Flamsteed's enmity to Halley, in what Mr. Rigaud calls 'his detected act of dishonesty.' 'Newton,' says Gregory, 'often told me, but especially in December 1698, that these tables (Flamsteed's lunar ones) were first made and computed by Edmund Halley, and communicated to Flamsteed, and published by him without the knowledge of Halley, and that this theft was the origin of the eternal quarrels between Halley and Flamsteed. Newton said that he had seen the handwriting of Halley.'³

I pass on now to a few remarks on Halley's political leanings. The revolution of 1688 caused various public commotions, 'of which, if the following story which passed current several years afterwards concerning his behaviour then, has any foundation, Mr. Halley was far from being an unmoved spectator. The story is this: That the grateful sense of the favours he had received from the two preceding princes,⁴ lying always near his heart, he continued to express

¹ We recommend to the reader the able *Defence of Halley against the Charge of Religious Infidelity*, by the Rev. S. J. RIGAUD, M.A., of Ipswich, Oxford, 1844. Professor Rigaud, the author's distinguished father, a man of genuine piety, entertained the same opinion of Halley. [D.B.]

² We owe to Halley the discovery of the secular equation of the moon. [D.B.]

³ 'The following curious memorandum,' says Mr. Rigaud, 'is written by Dr. Gregory in the margin of his annotations on the *Principia*, p. 162. The subject to which he has annexed it, is the mention of Flamsteed's lunar tables, derived from the hypothesis of Horrox, (Schol. p. 462, first edit. of *Principia*.) "Newtonus mihi saepe dixit, nominatim Decembri 1698, Londini, tabulas hasce fuisse ab Ed. Halleio primum factas et supputatas, et cum Joh. Flamstedio communicatas, et ab illo, *inscio* Halleio, editas, et propter hoc factum æternas natas esse inter Halleium et Flamstedium rixas. Newtonus dixit se vidisse autographum Halleii.'"—*Defence of Halley*, p. 20 [D.B.].

⁴ King Charles II, by a letter to the East India Company, had procured for Halley a free passage to the island of St. Helena (see Appendix II, p. 179), and on the latter's return into

it with his usual warmth and openness after the Revolution: That after some time the matter reaching the ears of King William, His Majesty upon the first news was a little alarmed, and thought the behaviour of a person of so great reputation, and so conspicuous in the learned world, as Mr. Halley then was, should not be neglected; but upon a nearer enquiry, being truly informed that the warmth of our author's zeal for the ejected prince, was the pure effect of his gratitude, and without any mixture of particular dislike to his successor, and especially observing he was continually employed, at his telescope, determined not to disturb his speculations; being satisfied from his character, that his close attachment to these, would effectually prevent him from pushing his affection any further at most than drinking a health. The credit of this story is left to the reader. . . .¹

Halley was well known to be a Tory. Yet William III appointed him as captain of the *Paramour Pink*, in 1698.² We have seen, also, that Queen Anne or her Tory Ministry, in 1702/3, sent Halley on two missions to Vienna.³ After the death of Anne, in 1714, when the Elector of Hanover became King George I of England, Halley adhered to the new dynasty, much to the discomfiture of Thomas Hearne, the antiquary, who was a non-juror.⁴ Hearne says, under date of 'Jan. 22 (Wed.) 1717/18', that: 'The said Sir Isaac Newton is a great Whig. And so is Dr. Halley, tho' he pretends to be a Tory. In short, Dr. Halley hath little or no Religion. The said Dr. Halley defends taking all manner of Oaths, & as soon as ever King George came over, he went to Westminster & took ye Oaths publicly, & bragged of what he had done afterwards, in as publick a manner, particularly in the Coffee-Houses.'⁵

Again, on 'Feb. 11 (Tu.) 1717/18', Hearne writes: 'Being in company last Night with Dr. Halley, he took occasion to mention Will. of Neuburg that I am now printing, & to ask whether he was for Hereditary Right? I said he was, & yt he called K. Stephen, and other *reges illegitimi*, by no softer word than *tyranni*. So yt I suppose this (said I) will please you. For my part says the Dr, I am for the King in Possession. If I am protected, I am content. I am sure we pay dear enough for our Protection, & why should we not have the Benefit of it?'⁶ Thus this Gentleman is for Confusion, & if all were of his Mind, all Government would soon be at an end.'⁷

Halley's place among the world's geniuses, as estimated by various authorities, is a subject of some interest. Lalande may have been the only writer to term England, secured for him the degree of M.A., at Oxford (see p. 3, notes 4 and 5). King James II gave an audience to Halley, circa June-July, 1687, to permit the latter to present a copy of Newton's *Principia* (see Appendix VII, p. 209). If either of these monarchs granted any other favours to Halley, there appears to be no published record of them now. Editor's note.

¹ *Biog. Brit.*, vol. iv, p. 2507, note BB.

² See p. 8, note 2.

³ See Appendix XIII, p. 248.

⁴ *Notes and Queries*, vol. cliii, p. 410, 1927.

⁵ Hearne, *Remarks*, vol. vi, p. 132, Oxford, 1902. Cf. Wheatley, H. B., *London, Past and Present*, vol. i, p. 390; vol. ii, pp. 147-8, London, 1891.

⁶ This sounds much like Newton's wording of a letter, dated 21 Feb. 1688/9, addressed to Dr. Covell: 'Allegiance and protection are always mutuall; and, therefore, when K. James ceased to protect us, we ceased to owe him allegiance by ye law of ye land. And, when King W. began to protect us, we began to owe him allegiance.' (Brewster, *Memoirs of Newton*, ed. 1855, vol. ii, pp. 459-60.)

⁷ Hearne, *Remarks*, vol. vi, pp. 139-40.

Halley 'the greatest of English astronomers',¹ but the belief has been quite generally expressed that, 'in the history of astronomy, the name of Halley will stand not far from that of Newton'.² 'He was second only, and a good second, to Newton in gravitational astronomy.'³

'Posterity has retained a grateful recollection of those princes who at different periods of history have distinguished their reign by a munificent patronage of learning and science; but, among all those who have thus contributed indirectly to the progress of knowledge, there is none who exhibits such a bright example of disinterestedness and self-sacrificing zeal as the illustrious superintendent of the first edition of the "Principia".'⁴

'While we thought the eulogium of an astronomer, a naturalist, a scholar and a philosopher our whole subject, we have been insensibly surprised into the history of an excellent mariner, an illustrious traveller, an able engineer, and almost a statesman.'⁵

'... It was Delambre who, speaking of Halley's "Synopsis Astronomiæ Cometicæ," said (*Hist. Ast. XVIII. Siècle*, p. 130): "Violà bien, depuis Kepler, ce qu'on a fait de plus grand, de plus beau, de plus neuf en astronomie."

'It is a fact hardly yet appreciated in England or America, that Dr. Edmund Halley is second only to Isaac Newton, whose friend and contemporary he was (Newton's "Principia" was first printed in 1686/7 at Halley's expense), and that it is to this close contemporaneity alone that the bright light of Halley's star has suffered diminution of lustre from the brilliant rays of his world-renowned neighbouring luminary.

'No biographer has yet appeared to write the life of this great man, nor does any public monument yet adequately represent the national estimation which is so richly deserved by the second most illustrious of Anglo-Saxon philosophers.'⁶

'There can be little doubt that the fame as an astronomer which Halley ultimately acquired, great as it certainly was, would have been even greater still had it not been somewhat impaired by the misfortune that he had to shine in the same sky as that which was illumined by the unparalleled genius of Newton.'⁷

Lord Macaulay remarks that, in the history of purely physical science, 'the transcendent lustre of one immortal name casts into the shade all others'. We have ventured elsewhere to express the hope that the light of later appreciation will so penetrate that shadow as to throw into stronger relief the figure of one who deserves to share in greater measure than at present the fame of his immortal contemporary.⁸

¹ 'Il fut le plus grand astronome de l'Angleterre.' Lalande, *Astronomie*, 3^e Edit., Tome 1, p. 180, sect. 533, Paris, 1792.

² Brewster, Sir D., in *Imperial Dictionary of Universal Biography*, vol. ii, p. 788.

³ H. P. Hollis in *The Observatory*, vol. xxii, p. 354 (1899).

⁴ Grant, Robert, *History of Physical Astronomy*, p. 31, London, 1852.

⁵ Mairan: 'Eloge de M. Halley', as translated in *The Gentleman's Magazine*, vol. xvii, p. 504, London, 1747.

⁶ *Nature*, vol. xxi, p. 303, London, 1880.

⁷ Ball, Sir R. S., *Great Astronomers*, p. 162, London, 1895.

⁸ Cf. *Notes and Queries*, 9th series, vol. xii, p. 465, London (1903).

HALLEY'S HOROSCOPE

248 33

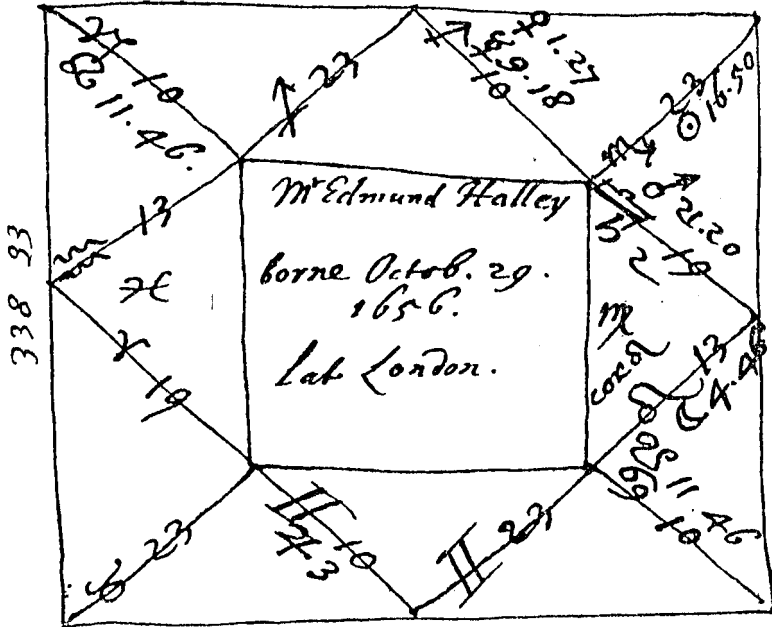

From the original in the Bodleian Library (MS. Aubrey).

APPENDIX XIX

LIST OF HALLEY'S PUBLISHED WRITINGS, ARRANGED CHRONOLOGICALLY

1676. *Methodus directa et geometrica, cujus ope investigantur aphelia, eccentricitates, proportionesque Orbium Planetarum primariorum, absque supposita æqualitate anguli motûs, ad alterum ellipsews focum, ab Astronomis hactenus usurpatâ.* (*Phil. Trans.*, vol. xi, 1676, pp. 683-6.)
 Observations concerning the Spots in the Sun appearing in July and August, 1676. [Extract.] (*Ibid.*, pp. 687-8.)
 Observations concerning the occultation of Mars by the Moon, made at Oxford, Anno 1676. Aug. 21, P.M. (*Ibid.*, p. 724.)
1677. Letter dated Novemb. 22, 1677, from St. Helena, with an observation on the Transit of Mercury, Oct. 28, 1677. (In Hooke, Robert, *Lectures and Collections; Cometa*, 1678, pp. 75-7, London, 8vo.)
1679. *Catalogus Stellarum Australium, sive supplementum Catalogi Tychonici exhibens longitudes et latitudes Stellarum fixarum, quæ prope polum antarcticum sitæ, in horizonte Vraniburgico Tythoni inconspiciuæ fuere . . . ad annum 1677 completum correctas: cum ipsis observationibus in insula S. Helenæ . . . depromptis, &c. Londini, 1679. 4to.*
Catalogue des Etoilles Australes, ou Supplement du Catalogue de Thycho, &c. Paris, 1679. 12mo.
- 1681/2. Observations made at Ballasore, in India, serving to find the Longitude of that place, and rectifying very great errors in some famous modern geographers. (*Philos. Collect.*, 1682, No. 5, p. 124-6.)
1683. A correction of the theory of the motion of the Satellite of Saturn. (*Phil. Trans.*, vol. xiii, 1683, pp. 82-8.)
 A theory of the Variation of the magnetical Compass. (*Ibid.*, pp. 208-21.)
1684. Account of the course of the Tides at Tonqueen, with a theory of them, at the barr of Tonqueen. (*Ibid.*, vol. xiv, 1684, pp. 677-88.)
1686. A discourse concerning Gravity, and its properties, wherein the descent of heavy bodies, and the motion of projects is briefly, but fully handled; together with the solution of a problem of great use in Gunnery. (*Ibid.*, vol. xvi, 1686-7, pp. 3-21.)
 Two astronomical observations of the Eclipses of the Planet Jupiter, by the Moon in March and April, 1686, at London. (*Ibid.*, pp. 85-7.)
 A discourse of the rule of the decrease of the hight of the mercury in the Barometer, according as places are elevated above the surface of the Earth; with an attempt to discover the true reason of the rising and falling of the mercury, upon the change of weather. (*Ibid.*, pp. 104-16.)
 An historical account of the Trade Winds, and monsoons, observable in the seas between and near the tropicks; with an attempt to assign the phisical cause of the said winds. (*Ibid.*, pp. 153-68.)

1687. De Constructione Problematum Solidorum sive æquationum tertię vel quartę potestatis, unica data parabola ac circulo efficienda; dissertatiuncula. (Ibid., pp. 335-43.)

An estimate of the quantity of Vapour raised out of the Sea by the warmth of the Sun. (Ibid., pp. 366-70.)

De Numero Radicum in Æquationibus solidis ac biquadraticis, sive tertię ac quartę potestatis, earumque limitibus, tractatulus. (Ibid., pp. 387-402.)

An Account of some Observations lately made at Nuremburg by Mr. P. Wurtzelbaur, shewing that the Latitude of that place has continued without sensible alteration for 200 years last past; as likewise the obliquity of the ecliptick; by comparing them with what was observed by Bernard Walther in the year 1487. (Ibid., pp. 403-6.)

[Letter to King James II.] Begins: May it please the King's Most Excellent Majesty. [A paper on the Tides.] 12 pp. London, 1687, fol.

NOTE. Printed copy of letter by Halley accompanying the copy of Sir Isaac Newton's *Principia* presented by him to James II.

[See also 1697.]

1691. An Account of the Circulation of the watry Vapours of the Sea, and of the cause of springs. (*Phil. Trans.*, vol. xvii, 1691-3, pp. 468-73.)

A Discourse tending to prove at what time and place, Julius Caesar made his first descent upon Britain. (Ibid., pp. 495-501.)

De visibili Conjunctione inferiorum Planetarum cum Sole, dissertatio astronomica. (Ibid., pp. 511-22.)

Emendationes & notę in tria loca vitiose edita in textu vulgato Naturalis Historię C. Plinii. (Ibid., pp. 535-40.)

An Account of the measure of the thickness of Gold upon Gilt-wire, together with a demonstration of the exceeding minuteness of the atoms or constituent particles of gold. (Ibid., pp. 540-2.)

An Account of the several species of Infinite Quantity, and of the proportions they bear one to the other. (Ibid., pp. 556-8.)

1692. An Account of the cause of the change in the Variation of the Magnetical Needle; with an hypothesis of the structure of the internal parts of the Earth. (Ibid., pp. 563-78.)

1693. An Estimate of the degrees of the Mortality of Mankind; drawn from curious tables of the births and funerals at the city of Breslaw; with an attempt to ascertain the price of Annuities upon lives. (Ibid., pp. 596-610; 654-6.)

An Account of several Experiments made to examine the nature of the Expansion and Contraction of Fluids by heat and cold, in order to ascertain the divisions of the Thermometer, and to make that instrument, in all places, without adjusting by a standard. (Ibid., pp. 650-6.)

A Discourse concerning the proportional Heat of the Sun in all latitudes, with the method of collecting the same. (Ibid., pp. 878-85.)

Emendationes ac notę in vetustas Albatēnii Observationes astro-

nomicas, cum restitutione Tabularum Lunisolarium ejusdem Authoris. (Ibid., pp. 913-21.)

An instance of the excellence of the Modern Algebra, in the resolution of the problem of finding the foci of optick glasses universally. (Ibid., pp. 960-9.)

Some Queries concerning the nature of Light, and diaphanous bodies. (Ibid., pp. 998-9.)

1694. Methodus nova accurata & facilis inveniendi Radices \mathcal{A} equationum quarumcumque generaliter, sine prævia reductione. (Ibid., vol. xviii, 1694, pp. 136-48.) [See also 1720.]

An Account of the Evaporation of Water as it was experimented in Gresham Colledge in the year 1693. With some observations thereon. (Ibid., pp. 183-90.)

Monsieur Cassini his new and exact Tables for the Eclipses of the first Satellite of Jupiter, reduced to the Julian Stile, and Meridian of London. (Ibid., pp. 237-56.)

1695. A Discourse concerning a method of discovering the true moment of the Sun's ingress into the Tropical Signs. (Ibid., vol. xix, 1695-7, pp. 12-18.)

A most compendious and facile Method for constructing the Logarithms, exemplified and demonstrated from the nature of numbers, without any regard to the hyperbola, with a speedy method for finding the number from the logarithm given. (Ibid., pp. 58-67.)

A Proposition of general use in the art of Gunnery, showing the rule of laying a mortar to pass, in order to strike any object above or below the horizon. (Ibid., pp. 68-72.)

Propositio generalis Arearum Dimensionem exhibens in universo illo Curvarum genere, quæ revolutione æquabili circuli super basin quamvis, vel rectilineam vel circulare describi possint; nempe omnium cycloidum vel epicycloidum, quovis modo genitarum. Cum demonstratione quadraturæ portionis epicycloidis a Domino Caswell inventæ, (num. 217, p. 114, promissa). (Ibid., pp. 125-8.)

Some Account of the ancient state of the City of Palmyra; with short remarks on the inscriptions found there. (Ibid., pp. 160-75.)

1696. An easie Demonstration of the analogy of the Logarithmick Tangents to the Meridian Line or sum of the secants: with various methods for computing the same to the utmost exactness. (Ibid., pp. 202-14.)

Part of a Letter from Mr. Halley at Chester, October 26, 1696; giving an account of an Animal resembling a Whelp voided per anum by a male greyhound; and of a Roman altar found there, &c. (Ibid., pp. 316-18.)

1697. The true Theory of the Tides, extracted from that admired treatise of Mr. Isaac Newton, intituled, *Philosophiæ Naturalis Principia Mathematica*; being a discourse presented with that book to the late King James. (Ibid., pp. 445-57.) [See also 1687.]

A Letter from Mr. Halley at Chester, giving an account of an extraordinary Hail in these parts, on the 29th of April last. (Ibid., pp. 570-2.)

A Letter from Mr. Halley of June the 7th. 97. concerning the Torricellian Experiment tryed on the top of Snowdon-hill and the success of it. (*Ibid.*, pp. 582-4.)

Part of a Letter of Mr. Halley, dated Chester, Octob. 25, 1697, giving an account of his observations there of the Eclipse of the Moon, on the 19th of the last month. (*Ibid.*, p. 784.)

1698. An Account of the appearance of an extraordinary Iris seen at Chester in August last. (*Ibid.*, vol. xx, 1698, pp. 193-6.)
1700. De Iride, sive de arcu cœlesti, dissertatio geometrica, qua methodo directa Iridis utriusque diameter, data ratione refractionis, obtinetur: Cum solutione inversi problematis, sive inventione rationis istius ex data arcus diametro. (*Ibid.*, vol. xxii, 1700-1, pp. 714-25.)
1700. Apollonii Conicorum, libri III, posteriores, ex Sermone Arabico in Latinum conversi; cum Pappi Lemmatibus, Græce et Latine. Subjicitur lib. VIII. ab Halleio restitutus. Oxford, 1700.
- 1701 (?). A New and Correct Chart shewing the Variations of the Compass in the Western and Southern Oceans.
1701. An Account of Dr. Robert Hook's invention of the marine Barometer, with its description and uses. (*Phil. Trans.*, vol. xxii, 1700-1, pp. 791-4.)
1702. A New and Correct Sea Chart of the Whole World shewing the Variations of the Compass as they were found in the year M.D.C.C.

An Account of the appearance of several unusual Parhelia, or Mock-suns, together with several circular arches lately seen in the air. (*Phil. Trans.*, vol. xxiii, 1702-3, pp. 1127-8.)

1705. Astronomiæ Cometicæ Synopsis. (*Ibid.*, vol. xxiv, 1704-5, pp. 1882-99.)
Astronomiæ Cometicæ Synopsis. Oxon., 1705. fol.
- A Synopsis of the Astronomy of Comets. London, 1705 8vo.
1706. Apollonii Pergæi de Sectione Rationis Libri Duo ex Arabico MS Latine versi. Accedunt Ejusdem de Sectione Spatii Libri Duo restituti. . . Opera & Studio Edmundi Halley. Oxonii, 1706. 8vo.
1710. Apollonii Pergæi Conicorum Libri Octo et Sereni Antissensis de Sectione Cylindri & Coni Libri Duo. . . edidit Edmundus Halleius. Gr. & Lat. Oxoniæ, 1710. fol.
1714. An Account of several extraordinary Meteors or lights in the Sky. (*Phil. Trans.*, vol. xxix, 1714-16, pp. 159-64.)

Some Remarks on the Variations of the Magnetical Compass published in the Memoirs of the Royal Academy of Sciences, with regard to the general Chart of those variations made by E. Halley; as also concerning the true longitude of the Magellan Streights. (*Ibid.*, pp. 165-8.)¹

1715. Observations of the late total Eclipse of the Sun, on the 22nd of April last past [1715]. (*Ibid.*, pp. 245-62; 314-16.)

A short Account of the cause of the Saltness of the Ocean and of the several lakes that emit no rivers; with a proposal, by help thereof, to discover the age of the world. (*Ibid.*, pp. 296-300.)

¹ The assigned Latin paper following this is probably Halley's. It contains an account of Kirch's observations of the Comet of 1680.

A short History of the several New-Stars that have appear'd within these 150 years; with an account of the return of that in Collo Cygni, and of its continuance observed this year 1715. [Anon.] (Ibid., pp. 354-6.)

An Account of several Nebulæ or lucid spots like clouds, lately discovered among the fixt stars by help of the telescope. [Anon.] (Ibid., pp. 390-2.)

An Account of Mr. Dodwell's Book *De Cyclis* in a letter to Robert Nelson, Esq. (In Brokesby, F., *The Life of Mr. Henry Dodwell*, London, 1715, pp. 611-38. 8vo.)

A Description of the passage of the shadow of the Moon over England in the total Eclipse of the Sun on the 22nd day of April, 1715, in the morning. By E. H.

1716. A Series of observations on the Planets, chiefly of the Moon, made near London . . . being a proposal how to find the Longitude, &c. By Dr. Edmund Haley. (In Street's *Astronomia Carolina*. 3rd edit. 4to. London, 1716.)

An Account of the late surprizing appearance of the Lights seen in the Air, on the sixth of March last; with an attempt to explain the principal phænomena thereof. (*Phil. Trans.*, vol. xxix, 1714-16, pp. 406-28.)

A Description of the Phenomenon of March 6 last, as it was seen on the ocean, near the coast of Spain. With an account of the return of the same sort of appearance on March 31, and April 1 and 2, following. [Anon.] (Ibid., pp. 430-2.)

Methodus singularis qua Solis Parallaxis sive distantia a Terra, ope Veneris intra Solem conspiciendæ, tuto determinari poterit. (Ibid., pp. 454-64.)

An Account of the cause of the late remarkable appearance of the Planet Venus, seen this summer [1716], for many days together, in the day time. (Ibid., pp. 466-8.)

The Art of living under Water: or, a discourse concerning the means of furnishing air at the bottom of the sea, in any ordinary depths. (Ibid., pp. 492-9; vol. xxxi, 1721, pp. 177-80.)

1717. Postscript in vindication of his Sea-chart made to show the Variations of the Compass, &c. (In Frezier, A. F., *A Voyage to the South-Sea . . . in . . . 1712, '13 & '14*. London, 1717. Translated from the French.)

An Advertisement to Astronomers of the advantages that may accrue from the observation of the Moon's frequent appulses to the Hyades, during the three next ensuing years. [Anon.] (*Phil. Trans.*, vol. xxx, 1717-19, pp. 692-4.)

An Account of a small telescopic Comet, seen at London on the 10th of June 1717. (Ibid., pp. 721-3.)

Considerations on the change of the Latitudes of some of the principal fixt Stars. (Ibid., pp. 736-8.)

1719. An Account of the extraordinary Meteor seen all over England, on the 19th of March, 1718/9. With a demonstration of the uncommon height thereof. (Ibid., pp. 978-90.)

An Observation of the end of the total Lunar Eclipse, on the 5th of March 1718, observed near the Cape of Good Hope, serving to determine the longitude thereof. With remarks thereon. (*Ibid.*, pp. 992-4.)

An Account of the phænomena of a very extraordinary Aurora Borealis, seen at London on November 10, 1719, both morning and evening. (*Ibid.*, pp. 1099-1100.)

1720. A New, Exact, and Easy Method of finding the Roots of any *Æquations* Generally, &c. (In Newton, Sir I., *Universal Arithmetick*, London, 1720.) [See also 1694.]

A New and Correct Chart, shewing the Variations of the Compass in the Western Atlantic and Southern Oceans as observed in ye year 1700 . . . by E. H. [1720 ?]

Some Remarks on a late Essay of Mr. Cassini, wherein he proposes to find, by observation, the parallax and magnitude of Sirius. (*Phil. Trans.*, vol. xxxi, 1720-1, pp. 1-4.)

Of the Infinity of the sphere of fix'd Stars. (*Ibid.*, pp. 22-4.)

Of the Number, order, and light of the fix'd Stars. (*Ibid.*, pp. 24-6.)

Some Remarks upon the method of observing the differences of Right Ascension and Declination by cross hairs in a telescope. (*Ibid.*, pp. 113-16.)

A Proposal for measuring the Height of places, by help of the Barometer of Mr. Patrick, in which the scale is greatly enlarged. (*Ibid.*, pp. 116-19.)

1721. Some Remarks on the allowances to be made in Astronomical observations for the Refraction of the Air. With an accurate table of refractions. (*Ibid.*, pp. 169-72.)

The Variation of the magnetical Compass, observed by Capt. Rogers, Commander of the ship *Duke*, in his passage from Cape St. Lucar in California to the Isle of Guam or Guana, one of the Ladrões, with some remarks thereon. (*Ibid.*, pp. 173-6.)

An Addition to the description of the Art of living under Water, publish'd in *Phil. Transact.* No. 349. (*Ibid.*, 177-80.)

On the Method of determining the places of the Planets by observing their near appulses to the fixed Stars. (*Ibid.*, pp. 209-11.)

Observation of a Parhelion, Oct. 26th. 1721. (*Ibid.*, pp. 211-12.)

1722. The Longitude of Buenos Aires, determin'd from an observation made there by Pere Feuillée. (*Ibid.*, vol. xxxii, 1722-3, pp. 2-4.)

Observatio Eclipsis Solaris. Novem. 27^o 1722. p.m. Grenovici. (*Ibid.*, p. 197.)

1723. Observations on the Eclipse of the Moon, June 18, 1722; and the longitude of Port Royal in Jamaica determined thereby. (*Ibid.*, pp. 235-6.)

The Longitude of Carthagenia in America. (*Ibid.*, pp. 237-8.)

1724. Some Considerations about the cause of the universal Deluge, laid before the Royal Society, on the 12th of December, 1694. (*Ibid.*, vol. xxxiii, 1724-5, pp. 118-25.)

1725. An Account of the appearance of Mercury, passing over the Sun's disk, on the 29th of October 1723, determining the mean motion, and fixing the nodes of that planet's orb. (*Ibid.*, pp. 228-38.)
1726. *Cometographia*. (In Gregory, D., *D. Gregorii . . . Astronomiæ . . . Elementa*. Genevæ, 1726.) 4to.
1727. Remarks upon some dissertations lately publish'd at Paris, by the Rev. P. Souciet, against Sir Isaac Newton's Chronology. (*Phil. Trans.*, vol. xxxiv, 1726-7, pp. 205-10; vol. xxxv, 1727-8, pp. 296-300.)
1728. Astronomical Observations made at Vera Cruz, by Mr. Joseph Harris. Revised. (*Ibid.*, vol. xxxv, 1727-8, pp. 388-9.)
1731. A Proposal of a method for finding the Longitude at sea within a degree, or twenty leagues. With an account of the progress he hath made therein, by a continued series of accurate observations of the Moon, taken by himself at the Royal Observatory at Greenwich. (*Ibid.*, vol. xxxvii, 1731-2, pp. 185-95.)
1732. Observations of Latitude and Variation taken on board the Hartford, in her passage from Java Head to St. Helena, Anno Dom. 1731-2. (*Ibid.*, pp. 331-6.)
 Methodus inveniendi radices æquationum sine prævia reductione.—Constructio æquationum tertix et quartæ potestatis ope circuli et datæ parabolæ.—Tractatus de numero et limitibus radicum in æquationibus solidis et biquadraticis. (In Newton, Sir I., *Arithmetica universalis*. Lugduni Batavorum, 1732.)
1737. Observation made on the Eclipse of the Moon on March 15, 1735/6. (*Phil. Trans.*, vol. xl, 1737-8, p. 14.)

Posthumous.

Edmundi Halleii Astronomi dum viveret Regii Tabulæ Astronomicæ, accedunt de usu Tabularum Præcepta. Londini, 1749. 4to. [Edited by John Bevis.]

Astronomical Tables with Precepts both in English and Latin for computing the places of the Sun, Moon, &c. London, 1752. 4to.

Menelai Sphæricorum libri III, quos olim, collatis MSS. Hebræis et Arabicis, typis exprimendos curavit . . . E. Halleius. Oxonii, 1758. 8vo.

Dr. Halley's First Voyage: a journal of a voyage made for the discovery of the rule of the variation of the compass . . . 1699 and 1700. (In Dalrymple, A., *A Collection of Voyages chiefly in the Southern Atlantick Ocean*, London, 1775. 4to.)

APPENDIX XX

GROUPED REFERENCES FOR HALLEY'S LIFE AND WORK

These references, though by no means exhaustive, may still be of service to students in their present form.

(1) *Birth and Ancestry*

- Biographia Britannica*, vol. iv, p. 2494. London, 1757.
Aubrey, John: *Letters Written by Eminent Persons*, vol. ii, p. 365. London, 1813.
Brief Lives, ed. Clark, vol. i, p. 282. Oxford, 1898.
The Genealogist, vol. xxv, pp. 5-14. London, 1908.
Notes and Queries, 9th series, vol. xi, p. 366, 1903; 11th series, vol. vi, p. 497, 1912; vol. vii, p. 203, 1913; vol. clii, pp. 389-90, 1927; vol. cliii, pp. 123, 212, 410, 1927.

(2) *Early Life*

- Mémoires de l'Académie Royale des Sciences*, 1742 (Histoire), p. 172. Paris, 1745.
The Gentleman's Magazine, vol. xvii, p. 455. London, 1747.
Biog. Brit., vol. iv, pp. 2494-5. London, 1757.
Aubrey, John: *Letters Written by Eminent Persons*, vol. ii, p. 365. London, 1813.
Brief Lives, ed. Clark, vol. i, p. 282. Oxford, 1898.
Foster, Joseph: *Alumni Oxonienses (1500-1714)*, vol. ii, early series, p. 635. Oxford, 1891.
McGrath, John Richard, D.D. [ed.]: *The Flemings in Oxford*, vol. i, p. 267, note. Oxford, 1904.

(3) *Relations with Flamsteed*

- Thomson, Thomas: *History of the Royal Society*, p. 335. London, 1812.
Baily, Francis: *An Account of the Revd. J. Flamsteed . . . compiled from his own manuscripts*, 1835, and *Supplement*, 1837; pp. xxxi, 193, 213, 669, 670, 709, 710, 731, 747.
The London and Edinburgh Philosophical Magazine, vol. viii, pp. 139-47, 214, 220, 225. London, 1836.
Brewster, Sir David: *Memoirs of the Life, Writings and Discoveries of Sir Isaac Newton*, vol. ii, pp. 164-6. Edinburgh, 1855.
The Observatory, vol. xlv, p. 293 *et passim*. London, 1922.
Notes and Queries, vol. cliii, p. 124, 1927.

(4) *Expedition to St. Helena (1676-8)*

- Gentleman's Mag.*, vol. xvii, p. 456. London, 1747.
Biog. Brit., vol. lv, p. 2495. London, 1757

- Birch, Thomas: *The History of the Royal Society of London*, vol. iii, p. 434. London, 1757.
- Rigaud, S. P. and S. J. [eds.]: *Correspondence of Scientific Men*, vol. i, pp. 228, 241 *passim*. Oxford, 1841.
- Baily, Francis: 'Preface to Halley's Southern Catalogue', in *Memoirs of the Royal Astronomical Society*, vol. xiii, pp. 36-7. London, 1843.
- [Oliver, S. P.]: *The Journal of Science*, vol. xvii, pp. 92-3. London, 1880.
- Oliver, S. P.: 'Proposed Monument to Halley', at St. Helena, *The Observatory*, vol. iii, pp. 348-50. London, 1880.
- Nature*, vol. xxi, pp. 303-4. London, 1880.
- Gill (Mrs. David): *Six Months in Ascension*, p. 33. London, 1878.
- C[lerke], A[gnes] M.: *Dictionary of National Biography*, vol. xxiv, p. 104. London, 1890.
- Calendar of State Papers—Domestic, 1677*, ed. Daniell, p. 314. London, 1909; *ibid.*, 1678, p. 517. London, 1913.
- Notes and Queries*, vol. cliii, p. 192, 1927.

(5) *Degree of M.A., at Oxford (1678)*

- Wood, Anthony: *Fasti Oxonienses*, pt. ii, p. 368. London, 1820. (Cited in *Notes and Queries*, 9th series, vol. xi, p. 205, 1903.)
- Calendar of State Papers—Domestic, 1678*, ed. Daniell, pp. 517, 528. London, 1913.

(6) *Election to and association with the Royal Society*

- Birch: *Hist. Roy. Soc.*, 4 vols. London, 1756-7. (No index.)
- Thomson: *Hist. Roy. Soc.*, pp. 207, 335-40; Appendix, p. xxvii. London, 1812.
- Weld: *Hist. Roy. Soc.*, 2 vols. London, 1848. (See index.)
- Gunther, R. T.: *Early Science in Oxford*, vol. iv, 'The Philosophical Society', pp. 91, 186, 196, 199, 204. Oxford, 1925.

(7) *Visit to Hevelius (1679)*

- Hevelii, Johannis: *Annus Climactericus*. Gedani, 1685.
- [Wallis, John]: [Account of] Johannis Hevelii, 'Annus Climactericus', Gedani, 1685; in *Philosophical Transactions (1685)*, vol. xv, pp. 1162-83. (The authorship of this review has, erroneously, been ascribed to Hooke. Halley's name therein is consistently spelled 'Hally'.)
- Molyneux, William: [Account of] Johannis Hevelii, 'Annus Climactericus', Gedani, 1685; MS. in Archives¹ of Royal Society (cf. Birch: *Hist. Roy. Soc.*, vol. iv, p. 450). Another copy in Archives of Philosophical Society of Oxford, in their 'Letter-book' (cf. Gunther, R. T.: *Early Science in Oxford*, vol. iv, p. 171, note. Oxford, 1925).

¹ This account by Molyneux exists in two versions among the Royal Society's papers, one a transcript of the manuscript original; the other a Latin version in Molyneux's hand, prepared (as it appears) by Dr. Musgrave's desire. The Latin version has a postscript dated 13 Feb. 1686.

- Waller, Richard: *The Posthumous Works of Robert Hooke*, pp. xv-xvi. London, 1705.
- Ward, John: *Lives of the Professors of Gresham College*, pp. 177-8, 324. London, 1740.
- Mairan: 'Éloge de M. Halley', in *Mémoires de l'Académie Royale des Sciences*. Paris, 1742. (See 'Histoire', p. 176.)
- Gentleman's Mag.*, vol. xvii, p. 457. London, 1747.
- Biog. Brit.*, vol. iv, pp. 2498-9. London, 1757.
- Birch: *Hist. Roy. Soc.*, vol. iv, p. 406. London, 1757.
- Baily, Francis: 'Preface to Halley's Southern Catalogue', in *Memoirs of the Royal Astronomical Society*, vol. xiii, pp. 38-9; and 'Preface to Hevelius' Catalogue', *ibid.*, p. 42. London, 1843.
- Béziat, L. C.: 'La Vie et les Travaux de Jean Hévélius', in *Bullettino di Bibliografia e di Storia delle Scienze matematiche e fisiche*, B. Boncompagni, ed., vol. viii, pp. 618-20. Roma, 1875; reprinted in book form, Roma, 1876.
- Ball, Sir Robert S.: *Great Astronomers*, p. 171. London, 1895. (Cited in *Notes and Queries*, 9th series, vol. xi, p. 205, where some errors in Sir R. S. Ball's sketch of Halley are pointed out.)
- Notes and Queries*, 9th series, vol. xi, p. 205, 1903; vol. cliii, pp. 212, 410, 1927; vol. clv, p. 87, 1928.

(8) 'The Grand Tour' (1680-1)

- Gentleman's Mag.*, vol. xvii, p. 457. London, 1747.
- Biog. Brit.*, vol. iv, p. 2500. London, 1757.
- Birch, Thomas: *The Works of Dr. John Tillotson, Archbishop of Canterbury*, vol. i, pp. lvi, lvii, lviii. London, 1820.
- Weld: *Hist. Roy. Soc.*, vol. i, p. 267. London, 1848.
- Aubrey, John: *Brief Lives*, Clark, vol. i, pp. 282-3. Oxford, 1898.
- C[lerke], A[gnès] M.: in *Dict. Nat. Biog.*, vol. xxiv, p. 104.
- Notes and Queries*, vol. clv, p. 87, 1928.

(9) The Publication of the 'Principia' (1687)

- Rigaud, Stephen Peter: *Historical Essay on the First Publication of Sir Isaac Newton's Principia*. Oxford, 1838.
- Brewster, Sir David: *Memoirs of the Life, Writings and Discoveries of Sir Isaac Newton*, 2 vols. Edinburgh, 1855. (See Index.)
- Edleston, J.: *Correspondence of Sir Isaac Newton and Professor Cotes*. London, 1850. (See 'Synoptical View of Newton's Life', 'Notes', *passim*.)
- Ball, W. W. Rouse: *An Essay on Newton's Principia*. London, 1893.
- A Catalogue of the Portsmouth Collection of Books and Papers written by or belonging to Sir Isaac Newton, the scientific portion of which has been presented by the Earl of Portsmouth to the University of Cambridge*. 56 pp. Cambridge, 1888.
- Gray, George J.: *A Bibliography of the Works of Sir Isaac Newton, together*

with a List of Books illustrating his Works. Second Edition, Revised and Enlarged. 80 pp. Cambridge, 1907. (See Index.)
C[lerke], A[gnès] M.: in *Dict. Nat. Biog.*, vol. xxiv, p. 105.

(10) *At the Mint, in Chester*

Brewster, Sir David: *Memoirs of . . . Sir Isaac Newton*, vol. ii, pp. 194-6. Edinburgh, 1855.
A Catalogue of the Portsmouth Collection . . ., p. 36. Cambridge, 1888.

(11) *Halley and Peter the Great (1698)*

Mairan: 'Éloge de M. Halley', in *Mémoires de l'Académie Royale des Sciences*. Paris, 1742. (See 'Histoire', p. 186.)
Gentleman's Mag., vol. xvii, p. 506. London, 1747.
Biog. Brit., vol. iv, p. 2517. London, 1757.
Barrow, Sir John: *A Memoir of the Life of Peter the Great*, p. 93. London: Murray, 1832.
The Life of Peter the Great. Edinburgh, n.d.
The Spectator, 12 March 1910. London.
Notes and Queries, 9th series, vol. xii, p. 127, 1903; 10th series, vol. xi, p. 64, 1909; vol. cliv, p. 152, 1928; vol. clv, p. 87, 1928.

(12) *The Two Voyages (1698-1700)*

Gentleman's Mag., vol. xvii, pp. 457, 503-4. London, 1747.
Biog. Brit., vol. iv, p. 2502. London, 1757.
Frézier, Amédée François: *A Voyage to the South Sea and along the Coasts of Chili and Peru, in the years 1712, 1713 and 1714*. London, 1717. (Contains, on pp. 278, 291, a criticism of some of Halley's observations, and on pp. 320-2, a postscript by Halley in reply.)
Mountaine, William, and Dodson, James: *An Account of the Methods used to describe Lines on Dr. Halley's Chart of the Terraqueous Globe; shewing the Variations of the Magnetic Needle. . .* London, 1746.
Dalrymple, Sir Alexander: *Voyages in the South Atlantic*. London, 1775.
Burney, James: *Chronological History of the Voyages and Discoveries in the South Sea*, vol. iv, pp. 384-7. London, 1816.
Herschel, Sir John: in *The Quarterly Review*, vol. lxvi, pp. 276-7. London, 1842.
Luttrell: *Relation of State Affairs*, vol. iv, pp. 532, 533, 538, 687. Oxford, 1857.
Calendar of Treasury Papers, 1697-1702/3, ed. Redington, p. 210. London, 1871.
Oliver, S. P.: 'Early History of Magnetism', in *Nature*, vol. xiii, p. 523. London, 1876.
Weld: *Hist. Roy. Soc.*, vol. ii, pp. 431-5. London, 1848.
'Halley's Magnetic Chart', from the original in British Museum. Reproduced by Airy, as an Appendix to the Magnetical and Meteorological section

- of the Greenwich Observations for 1869. London, 1871. (Mentioned by Capt. S. P. Oliver, in *Journ. of Sci.*, vol. xvii, pp. 95-8. London, 1880.)
- Notes and Queries*, 2nd series, vol. ix, p. 297, 1860.
- Thomson, Sir William (afterwards Lord Kelvin): *Popular Lectures and Addresses*, vol. iii, 'Navigational Affairs', pp. 268, 270-1. London, 1891.
- Bauer, L. A.: 'Halley's Earliest Equal Variation Chart', reproduced in facsimile, in *Terrestrial Magnetism*, vol. i. Washington, 1896.
- 'Halley's Charts', *Nature*, vol. lii (1895), pp. 79, 106, 197, 343; vol. liv (1896), pp. 126, 196.
- Jordan, William Leighton: *Essays in Illustration of the action of Astral Gravitation in Natural Phenomena*, p. 87. London, 1900.
- Turner, Herbert Hall: *Halley's Comet*, pp. 20-1. Oxford, 1908.
- Bellamy, F. A.: 'Edmund Halley', in *Knowledge*, vol. xxxiii, p. 168. London, 1910.
- Bauer, L. A.: 'Magnetic Results of Halley's Expedition, 1698-1700', in *Terrestrial Magnetism*, vol. xviii, 1913, pp. 113-26.
- Ault, J. P., and Wallis, W. F.: 'Halley's Observations of the Magnetic Declination, 1698-1700. Explanation of Table and Methods', in *Terrestrial Magnetism*, vol. xviii, 1913, pp. 126-32.
- Bauer, L. A.: 'The Earth's Magnetism', in the *Smithsonian Report for 1913*, pp. 195-212. Reprinted, Washington, 1914.

(13) *The Two Missions to Vienna (1702-3)*

- Calendar of State Papers—Domestic, 1702/3*, ed. Mahaffy, vol. i, pp. 278, 412. London, 1916.
- Calendar of Treasury Papers, 1697-1702/3*, ed. Redington, p. 210. London, 1871.
- Calendar of Treasury Papers, 1702-7*, ed. Redington, pp. 71, 226. London, 1874.
- Gentleman's Mag.*, vol. xvii, p. 504. London, 1747.
- Biog. Brit.*, vol. iv, p. 2512. London, 1757.
- Luttrell: *Brief Relation of State Affairs*, vol. v, pp. 228, 265, 278, 285, 306. Oxford, 1857.
- [Oliver, S. P.]: in *The Journal of Science*, vol. xvii, pp. 98-9. London, 1880.
- Royal Hist. MSS. Com.: '1702-6: Correspondence of George Stepney at Vienna and other Courts': cites Add. MSS. 7058-60, 7063, 7066, 7071-7, 9387, in British Museum (*not examined*).
- Notes and Queries*, 2nd series, vol. xi, p. 225, 1861; 10th series, vol. vii, p. 8, 1907; 12th series, vol. v, p. 37, 1919.

(14) *Savilian Professor of Geometry (1703)*

- Gentleman's Mag.*, vol. xvii, p. 505. London, 1747.
- Biog. Brit.*, vol. iv, pp. 2512-13. London, 1757.
- Luttrell: *Brief Relation of State Affairs*, vol. v, p. 379. Oxford, 1857.
- Calendar of State Papers—Domestic, 1703/4*, ed. Mahaffy, vol. ii, p. 191. London, 1924.

(15) *Degrees of LL.D. and D.C.L., Oxford (1710)*

Hearne, Thomas: *Remarks*, vol. iii, p. 25.

C[lerke], A. M.: *Dict. Nat. Biog.*, vol. xxiv, p. 106.

Notes and Queries, 9th series, vol. xi, p. 463, 1903; vol. cliv, p. 152, 1928.

(16) *Astronomer Royal (1721)*

[Lisle, Joseph Nicholas de]: *Lettres de M. de L'isle . . . sur les Tables Astronomiques de M. Halley . . .* Paris [Quillau], 1749. (See p. 33, of first letter, about Halley's withholding his tables of the moon.)

Bradley, James: *Miscellaneous Works*, ed. Rigaud, p. 382. Oxford, 1832.

Baily, Francis: 'Some Account of the Astronomical Observations made by Dr. Edmund Halley, at the Royal Observatory at Greenwich', in *Memoirs of the Royal Astronomical Society*, vol. viii, pp. 169-90. London, 1835.

Rigaud, S. P.: 'Some particulars respecting the principal Instruments at the Royal Observatory at Greenwich in the time of Dr. Halley', in *Memoirs of the Royal Astronomical Society*, vol. ix, p. 205. London, 1836.

Rigaud, S. P.: in the *London and Edinburgh Philosophical Magazine*, vol. viii, p. 224. London, 1836.

Grant, A. R.: *History of Physical Astronomy*. London, 1852, p. 480.

Calendar of Home Office Papers, 1760-5, ed. Redington, p. 435. London, 1878. (Quotes a letter, dated 10 August 1764, from the Earl of Halifax to Lord Morton, President of the Royal Society, referring to the meeting of the Council of the Royal Society, held 2 March 1726/7.)

Calendar of Treasury Books and Papers, 1729-30, ed. Shaw, pp. 429, 442. London, 1897.

Ball, Sir Robert S.: *Great Astronomers*, p. 177. London, 1895.

C[lerke], A[gnès] M.: in *Dict. Nat. Biog.*, vol. xxiv, p. 107.

Hearne, Thomas: *Remarks*, vol. ix, p. 293. Oxford, 1914.

(17) *The Royal Society Club*

Smyth, Admiral W. H.: *An Additional Word on the Pristine Establishment of the Royal Society Club*, pp. 4-7. London, 1861. Addendum to his *Sketch of the Rise and Progress of the Royal Society Club*. London, 1860. [Private print.]

Geikie, Sir Archibald: *Annals of the Royal Society Club*, pp. 6-9. London, 1917.

The Pall Mall Gazette, No. 14,032, for 11 April 1910; article, 'Halley's Club'.

Turner, Herbert Hall: *Halley's Comet*, p. 23. Oxford, 1908.

(18) *Death and Burial*

The Daily Advertiser. London, Saturday, 16 January 1742, p. 1.

Biog. Brit., vol. iv, p. 2517. London, 1757.

Lysons, Daniel: *Environs of London*, 2nd edition, vol. i, p. 555. London, 1811.



EDMOND HALLEY

*From an engraving by Vertue of the
original portrait by R. Phillips*

- Weld: *Hist. Roy. Soc.*, vol. i, p. 488. London, 1848. (Cites Smyth: *Cycle of Celestial Objects*, vol. i, p. 55, referring to the burial of John Pond, in Halley's tomb.)
- London and Edinburgh *Philosophical Magazine*, vol. v, p. 517. London, 1853.
- Register of the Church of St. Margaret, Lee*, p. 58. Lee, 1888.
- Musgrave, William: *Obituary*, vol. iii, p. 123; Harleian Society, vol. xlvi. London, 1900.
- Notes and Queries*, 9th series, vol. xi, p. 366, 1903; vol. cliii, p. 159, 1927.
- The Genealogist*, vol. xxv, p. 11. London, 1908.

(19) Portraits

- Biog. Brit.*, vol. iv, p. 2502, side-note 39. London, 1757.
- The Annual Register* (1768), vol. xi, p. 258.
- Bromley, H.: *Catalogue of Engraved Portraits*, p. 291. London, 1793.
- O'Donoghue, Freeman: *Catalogue of Engraved British Portraits Preserved in the Department of Prints and Drawings in the British Museum*, vol. ii, p. 418. London, 1910.
- Notes and Queries*, 9th series, vol. x, p. 362, 1902; vol. xi, p. 85, 1903; vol. xii, p. 125, 1903.
- The Genealogist*, new series, vol. xxv, p. 11. London, 1908.
- A.L.A. Portrait Catalogue*, p. 642. Washington, 1906.
- Imperial Dictionary of Universal Biography*, vol. ii [? 1860].
- Knight: *Gallery of Portraits with Memoirs*, vol. i. London, 1833. (Portrait.)
- Good Words*, vol. xxxvi, p. 736. London, 1895. (Portrait.)
- Ball, Sir Robert S.: *Great Astronomers*. London, 1895. (Portrait.)
- Turner, Herbert Hall: *Halley's Comet*, p. 22. Oxford, 1908. (Portrait.)
- Bellamy, F. A.: 'Edmund Halley', in *Knowledge*, vol. xxxiii, p. 164. London, 1901. (Portrait.)
- NOTE: In MS. Rawlinson, J. 4. 2, folio 102 (Bodleian Library, Oxford), is a reference to 'a picture of Dr. Halley at Mr. Whooods a painter in Bloomsbury'.

(20) Biographies

- Mairan, J. J. d'Ortous de: 'Éloge de M. Halley', in *Mémoires de l'Académie Royale des Sciences* (Histoire) 1742, pp. 172-88. Paris, 1745.
- The same, in English; in *Gentleman's Mag.*, vol. xvii, pp. 455-8, 503-7. London, 1747.
- [? Birch, Thomas]:¹ in *Biog. Brit.*, vol. iv, pp. 2494 et seq. London, 1757.
- Annual Register*, vol. ii, pp. 283-90. London, 1759.
- Martin, Benjamin: *Biographia Philosophica. Being an Account of the Lives, Writings and Inventions of the Most Eminent Philosophers and Mathematicians . . . from the Earliest Ages to the Present Time*, pp. 432-43. London, 1764.

¹ It has been suggested that this sketch may have been written by Thomas Birch, as some rough notes therefor are preserved among the Birch MSS. in the British Museum. It appears just possible, however, that the sketch may have been prepared by John Machin (1679-1751), or that the latter may have collaborated in writing it.

- Baillly, J. S.: *Histoire de l'Astronomie Moderne*. Paris, 1785. (See vol. ii, pp. 432, 580, 613, 658; vol. iii, pp. 229, 265.)
- [Pugh, Edward]: *London*, by David Hughson, [pseud.] London, 1809. (See vol. vi, pp. 333-49.)
- Chambers, A.: *General Biographical Dictionary*. London, 1812-17. (See article, 'Halley, Edmund'.)
- Thomson, T.: *Hist. Roy. Soc.* London, 1812. (See pp. 207, 335-40.)
- Hutton, Charles: *Philosophical Transactions: Abridged*, vol. ii (1672-83). London, 1809. (See pp. 326-8.)
- A Philosophical and Mathematical Dictionary*. London, 1815. (See vol. i, pp. 624-6.)
- Birch, Thomas: *The Works of Dr. John Tillotson, Archbishop of Canterbury*. London, 1820. (See vol. i, pp. lvi, lvii, lviii.)
- Delambre, J. B. J.: *Histoire de l'Astronomie au XVIII^e siècle*. Paris, 1827. (See pp. 116, 310, 386, 493, 607.)
- Whewell, W.: *History of the Inductive Sciences from the earliest to the present Times*. London, 1837. (See vol. ii, pp. 150, 210, 237.)
- The Penny Cyclopædia*, vol. xii, pp. 19-21 (article, 'Halley'). London, 1838.
- Grant, A. R.: *History of Physical Astronomy*. London, 1852. (See pp. 27, 48, 60, 102, 289, 372, 477, 480, 545, 554.)
- Arago, François: *Œuvres*. Paris, 1854-62. (See vol. iii, pp. 365-9.)
- The English Cyclopædia*, conducted by Charles Knight. London, n.d. (See vols. iii and iv, 'Biography', article, 'Halley, Edmund', cols. 268-70.)
- Maily, E.: in *Annuaire de l'Observatoire*. Bruxelles, 1864. (See p. 305.)
- Mädler, J. H.: *Geschichte der Himmelskunde*. Braunschweig, 1873. (See vol. i, p. 88.)
- Wolf, R.: *Geschichte der Astronomie*. München, 1877. (See p. 463.)
- Cunningham, George Godfrey: *Lives of Eminent and Illustrious Englishmen*. Glasgow, 1836-7. (See vol. iv, pp. 453-6.)
- The English Nation*. Edinburgh, n.d. (See vol. iii, pp. 359-62.)
- [De Morgan, Augustus]: 'Halley', in Knight's *Gallery of Portraits with Memoirs*, vol. i, pp. 161-8. London, 1833.
- 'Halley', in *Cabinet Portrait Gallery of British Worthies*, vol. xii, pp. 5-15. London, 1847.
- Brewster, Sir David: in *Imperial Dictionary of Universal Biography*, vol. ii, p. 788 [? 1860].
- Oliver, S. P.: in *The Journal of Science*. London, 1880. (See vol. xvii, pp. 91-100.)
- 'Proposed Monument to Halley', at St. Helena, in *The Observatory*, vol. iii, p. 348. London, 1880.
- Ball, Sir Robert S.: *Great Astronomers*. London, 1895. (See pp. 162-86.)¹
- C[lerke], A[gnès] M.: 'Halley, Edmund', in *Dict. Nat. Biog.*, vol. xxiv, pp. 104-9, 1890. Reissue, vol. viii, pp. 988-93, 1908, contains a few

¹ Some corrections to Sir R. S. Ball's text were suggested in *Notes and Queries*, 9th series, vol. xi, p. 205, 1903.

corrections and additions (cf. *Notes and Queries*, 9th series, vol. x, p. 361, 1902; vol. xi, pp. 205, 366, 463, 1903.).

Bellamy, F. A.: 'Edmund Halley', in *Knowledge*, vol. xxxiii, pp. 165-8, 215-18, 258. London, 1910.

Turner, Herbert Hall: *Halley's Comet*. Oxford, 1908.

'The Stars in their Courses', in *Bedrock*, vol. i, pp. 88-107. London, 1913.

(21) *Bibliographies*

Maty, Paul Henry: *A General Index to the Philosophical Transactions, from the first to the end of the seventieth volume*. London, 1787. (See pp. 643-8.)

Reuss, J. D.: *Repertorium Commentationum a Societatibus Litterariis editarum. Scientia Naturalis*, tom. ii, p. 581; tom. iii, p. 214; tom. iv, p. 405; tom. v, p. 539; tom. vii, p. 499; tom. viii, p. 654; tom. ix, p. 221. [Index to references.], Gottingæ, 1802-10. 4to.

Watt, Robert: *Bibliotheca Britannica*. Edinburgh, 1824. (See vol. i, Authors, sections 4590 to 460 f, and vol. iii, Subjects, no pagination, article, 'Halley, Edmund'.)

Houzeau, J. C., and Lancaster, A.: *Bibliographie Générale de l'Astronomie*, tome ii. Bruxelles, 1882. (See Index, cols. 1922-3.)

British Museum, London: *Catalogue of the printed maps, plans and charts in the British Museum*. London, 1885. (See vol. i, A-K, cols. 1733-4.)

Catalogue of Printed Books. Hag-Hal. London, 1888 (see cols. 273-6); and 'Supplement', 1903. (See col. 102.)

C[lerke], A[gnès] M.: in *Dict. Nat. Biog.*, vol. xxiv, p. 109. (See also reissue, vol. viii, p. 993, containing some additions.)

MacPike, E. F.: 'Dr. Edmond Halley' (a Bibliography, with notes), in *Notes and Queries*, 9th series, vol. x, pp. 361-2, 1902; vol. xi, pp. 85-6, 205-6, 366, 463-4, 1903; vol. xii, pp. 125-6, 185, 266-7, 464-5, 1903; 10th series, vol. ii, p. 224 et seq., 1904.

Rudolph, Alexander J.: 'Some material for a bibliography of Dr. Edmond Halley', in *Bulletin of Bibliography*, vol. iv, no. 4, pp. 53-7. Boston (Mass.), 1905.

The same, with the late author's typographical corrections (in the possession of the present editor).

Bibliothèque Nationale, Paris: *Catalogue Général des Livres Imprimés de la Bibliothèque Nationale*, tome lxxvii. Paris, 1917. (See cols. 1191-4.)

APPENDIX XXI

*Key to Sources of Original Material.*¹

The references which appear below,² have been arranged geographically, for the convenience of any future student of the subject.

Oxford, &c.

- i. Bodleian Library: Rigaud papers³; MSS. Rawlinson; MSS. Ballard.
- ii. Radcliffe Observatory Library: MS. Life of Halley.
- iii. Library of the Earl of Macclesfield, at Shirburne Castle: Halley's commonplace-book and some original MSS. (Mentioned in Aubrey, John: *Brief Lives*, Clark, vol. i, p. 283, note. Oxford, 1898.)

Cambridge

- i. University Library: Portsmouth Collection.
- ii. Trinity College Library: Volume of Letters addressed to the Oxford Philosophical Society; Letters bequeathed by Dr. J. W. L. Glaisher.

London

- i. Royal Society Library: Letter Books; Register Books; Council Minutes; MS. Letters; Archives⁴; Library.
- ii. Royal Astronomical Society: MS. attested copy, made by direction of Francis Baily, of Halley's MS. observations (originals preserved at Greenwich); other MSS.
- iii. British Museum: Add. MS. 4222, fo. 177; Egerton MS. 2331, fo. 186; MS. 2334, fo. 32; Sloane MSS.; Stowe Collection; Harleian MS. 3781, art. 3.
- iv. Public Record Office: Chancery Proceedings; Admiralty Archives (1698-1701).
- v. India Office: St. Helena (1676-8).

¹ A note under the heading 'Halleiana Inedita' was contributed by the present editor to *The Observatory*, vol. xxix, pp. 137-8 (London, March 1906), but this Appendix has been entirely rewritten and contains new matter. The ultimate biographer of Halley will, no doubt, wish to make an exhaustive search for unpublished material. We have not set ourselves that task. (See *Notes and Queries*, vol. clv, p. 24.)

² Cf. *Dict. Nat. Biog.*, vol. xxiv, p. 109; and the reissue, vol. viii, p. 993.

³ An account of the Rigaud Papers appears in the *Monthly Notices of the Royal Astronomical Society* (1875-6), vol. xxxvi, p. 54. A condensed list of those papers was printed in the *Smithsonian Miscellaneous Collections*, vol. xlviii, pp. 229-31 ('Notes'), Washington, 8 Sept. 1905.

⁴ Cf. *Catalogues of the Miscellaneous Manuscripts and of the Manuscript Letters in the possession of the Royal Society*, pp. 18, 54, London, 1840; and Church, A. H., *The Royal Society: Some Account of the 'Classified Papers' in the Archives [1606-1741], with an index of authors.* [Private print, 1908.]

- vi. Royal Observatory, Greenwich: Halley's original MSS. of his observations. (A MS. attested copy is deposited in the Library of the Royal Astronomical Society, London.¹)

Certain Continental libraries, museums, &c., probably contain some unpublished material on Halley.²

Libri asserted³ that he acquired, in 1842, 'les manuscrits et la correspondance autographe du célèbre Huet', which, amongst many other items, included 'une multitude de pièces d'Halley, de Fermat, d'Hevelius, d'Huyghens, de Leibnitz, &c., &c.' What was the ultimate fate of all these pieces we do not know.

¹ See Baily, Francis, 'Supplement' (1837) to his *Account of Flamsteed* (1835), p. 731; and his description of Halley's observations at Greenwich, in *Memoirs of the Royal Astronomical Society*, vol. viii, p. 169.

² *Notes and Queries*, vol. clv, p. 24.

³ Cf. Béziat, L. C., 'La Vie et les Travaux de Jean Hévélius', in *Bullettino . . .*, ed. Boncompagni, vol. viii, p. 659, Roma, 1875.

ADDENDA TO APPENDIX XIX

1705. Of Compound Interest and Annuities. (Printed in H. Sherwin's *Mathematical Tables . . . with their Construction and Use*, 1705.)
1712. *Historiæ Cœlestis Libri Duo, quorum Prior exhibet Catalogum Stellarum Fixarum Britannicum . . . Londini 1712*, fol.

[Conclusive proof that this Catalogue, based on Flamsteed's observations, was largely compiled, as well as edited, by Halley is furnished by the original MS. volume in the possession of the Radcliffe Observatory.]

INDEX

- Adiantum* at St. Helena, 211.
 Admiralty's instructions to Halley, 243.
 Air, compression of, 60, 62.
 influence of, in the kindling of phosphorus, 137.
 Albatenius—his observations of Eclipses of the Sun and Moon, 233.
 Alberghetti's tables for shooting bombs, 167, 168.
 Albicores cannot see at night, 223.
 Allen, Benjamin, 35.
 Altar-piece dug up at Chester, 98.
 Ancestry of Halley, 173.
 Animal substances, determination of, by burning, 210.
 Animals' blood that freezes and revives again, 220.
 Annuities, method of computing the value of, 232.
 Anstis, John 33; letter to, 130.
 Antoninus—itinerary of Britain, 166, 217, 221, 227, 238.
 Ants—chalk stops them climbing trees, 218.
 Arms of Halley, 178.
 Asbestos stone from Cyprus, 219.
 Ashe, St. George, 30, 31, 35; letter to, 61.
 Aston, Francis, 56, 58; letter from Hevelius to, 197.
 Atoms of salt, first generation of, 215.
 Aubrey, John, 4 n., 30, 35; letter to, 47.
 Aylofffe, Sir Joseph—his account of the origin of the Royal Society Club, 252.
 Barbadoes—hedges and fences of prickly-pear or Indian-fig, 217.
 Barometer improved by Hooke, 59, 61, 65.
 Beever, Ralph J., Halley's ancestry, 173.
 Bernoulli, Jean, 36; letter to Halley, 201; his nephew's visit to Halley, 201.
 Bevis, John, 36.
 Bianchini, M. 24.
 Bibliography of the published writings of Halley, 272.
 Bills of mortality of Breslau, 89, 231.
 Birch and fir bear frost above all other woods, 221.
 Birch, Thomas, 210.
 Bird, Mr., the stone cutter at Oxford, 235.
 Birds, necessary swiftness of the wings of, 159, 227.
 Bliss, Nathaniel, succeeds Halley at Oxford, 13.
 Blood of animals that freeze and revive again, 220.
 Blowing up ships under water or houses in case of fire, instrument for, 155, 226.
 Bombs, saving of powder in the casting of, 218.
 Bonitoes cannot see at night, 223.
 Books, inquiries and accounts of French, 49.
 Boucher, Charles, 29, 34, 37.
 Bradley, James, 36, 129; succeeds Halley as Astronomer Royal, 13, 24.
 Brahé, Tycho, 16, 26.
 Breslau Mortality Tables, 89, 231.
 Brewster, Sir David, on Halley's character, 267.
 Britain, Itinerary of Antoninus for, 166, 217, 221, 227, 238.
 British Channel, map of, 9.
 Bullets, height and velocity of, 147, 223.
 Burchett, James, 32, 33, 36; letters to, 103-15, 116-20, 122-3.
 Burney, Capt. James—his account of Halley's voyages, 244.
 Burning glass at Paris, 225.
 Cæpia, figure of the, 228.
 Cæsar, landing of Julius, in Britain, 217.
 Cancellus in old shells, 229.
 Candler, Barth., 36.
 Canvey—why trees will not grow there, 216.
 Carbery, Lord, elected President of the Royal Society, 75.
 Caribbe Islands, hurricanes found in the latitude of the, 218.

- 'Carmina Encomiastica', by Halley.
- Cassini, Jean Dominique, 15, 30, 36; his observations, 48, 49, 51, 72, 73; his tables for computing the motion of the first satellite of Jupiter and its eclipses, 234.
- Casting of bombs, saving of powder in the, 218.
- Caswell, John, of Hart Hall, Oxford, 31, 34; letter to, 67.
- Catalogue of Southern Stars, Halley's, 2, 3, 16, 17, 41.
- Caviare, Constantinople, 234.
- Cayenne, pendulum clock observed at, 234.
- Celestial motions, 80; instrument to observe the, 162, 230.
- Chalcedony tincture, 69.
- Chalk prevents ants from climbing trees, 218.
- Chanterell, Captain, 88.
- Character of Halley, 22, 26, 261.
- Charles (King), II, 2, 17.
- Charlett, Arthur, 33; letter to, 125.
- Chart of the variation of the magnetic needle, 9, 22.
- Chelsea Physick Garden, 211.
- Chester—the ancient city and its antiquities, 97; magnetic variation at, 97; an altar-piece dug up at, 98; nature of the stone at, 99; Halley at, 241.
- Chirurgery, rare case in, 233.
- Christ's Hospital, 90.
- Ciampini, Sigr., 79.
- Circle, quadrature of, 123.
- Clock at Cayenne, observations made with the pendulum, 234.
- Clocks, repeating, 214.
- Clocks and watches, contrivance of, 214.
- Cluver, Dethlef, letters from Hevelius to, 190, 191.
- Coast, survey of a, 120.
- Coining at Chester, 99, 100, 101.
- Comet of 1607 and 1682, calculation of the motion of the, 238.
of 1618, motion of the famous, 238.
Kirch's observations of, 201.
of 1664/5, 95.
of 1680, 5, 18, 132.
- Comet of 1680/1, 51, 92, 93, 94, 95, 96, 198, 199, 200.
of 1682, 92.
of 1683, 91, 94.
- Commercium Epistolicum, French translation of, 128.
- Compass, Halley's observations of the rule of the variation of the, 8, 19, 21, 55, 63, 64, 97, 226, 227, 229, 235; Halley's chart, 9, 22.
- Conduitt, John, 36.
- Conic sections, 219; general proposition for showing diameters, parameters, and foci of, 237.
- Constantinople caviare, 234.
- Constellation of the Oak, Halley's, 17.
- Cotes, Roger, 36.
- Cotton seed, Leeuwenhoek's observation of, 56.
- Council Minutes of the Royal Society, extracts relating to Halley, 239-40.
- Crabs which shoot their claws, 232.
- Craige, John, 35.
- Crepusculum of any latitude, method of determining the day of the shortest, 232.
- Croune, William, letter to Hevelius, 187; letter from Hevelius to, 188.
- Crystal, refraction of, 222.
- Cubic and biquadratic equation, the number of roots in any, 210.
equations, series showing the three roots of, without ambiguity, 236.
- Curves, Newton's quadratures of, 91.
- Cylindrick hoof, problem of finding the surface of a, 218.
- Cyprus, asbestos stone from, 219.
- Dantzic, Halley's visit to Hevelius at, 3, 18, 42, 187, 188, 189, 190, 280.
- Death by hanging, 237.
- De Lisle, Joseph Nicolas, 21.
- Depth of water, instrument for showing the, to persons in diving bell, 155, 225.
- Derham, William, 36.
- Des Cartes, René, 15, 27, 146, 235.
- Diamond, attempt to polish a small, 222; impracticable to grind an object glass, 235; refraction of a, 146, 221.

- Distance of Sun from earth, method of finding, 224.
- Diurnall motion of the earth, 213.
- Diving bell, a relation of the, 150, 224; conveyance of air into the, 152, 224; conveyance of air out of the, 224, 228; instrument for showing depth of water to persons in the, 155, 225; gauge for showing depth it descends, 232; walking under water in the, 144, 214; working under water in the, 154, 225.
- Dominical letters, 130.
- Dropsy, two extraordinary cases of, 233.
- Drum of the ear under water, protecting the, 168.
- Duck-eggs would kill a lark or nightingale, 234.
- Dutch (High-), Halley shows book by Kirch in, 219.
- (Low-), Halley produces book in, 234.
- Du Val, V. J., 36.
- Eagle, foot of an, presented by Halley, 235.
- Ear, protecting drum of, under water, 168.
- Earth, alteration of poles of the, 210; changes on surface of the, 234; diurnall motion of the, 213; Halley to measure a degree of the, 67, 70; Hooke's hypothesis concerning its surface, 77, 81.
- Eclipse of the moon, 38; of November 1686, 73; of September 19, 1689, 216; of 1696, 100; of 1697, 103.
- Eclipse of the sun at Smyrna in May 1687, Halley's directions for observing, 82.
- Eclipses of Sun and Moon, Albatenius' observations of, 232; computed by an easy calculus, 230; at St. Helena, 40.
- Eels, slime and scales of, 57.
- Eimmart, G. C., 35.
- Elephant's tooth with bullet embedded in it, 220.
- Engine for grinding glasses for telescopes, 228; for raising weights, 230.
- Equation of time, 212.
- Equations, determination of roots of, 210; method for extracting roots of, 233, 234; of the sixth power, rule for constructing, 235; series showing the three roots of cubic, 236.
- Evacuating water by pressure, 165, 235.
- L'Eveque de Soissons, an unaccountable effect of lightning in France, 79.
- Expansions of liquors by heat, 138, 211.
- Explosion of gunpowder—effect on windows of houses, 216.
- Fir and birch bear frost above all other woods, 221.
- Fire under water, instrument for keeping, 225.
- Fixed stars, of the Southern Hemisphere, Catalogue of the, 2, 3, 16, 17, 41; occultations and transits of the, 238.
- Flamsteed, John, 2, 11, 15, 16, 23, 29, 30, 33, 34, 90, 91, 92, 93, 174, 229; letters to, 37, 42, 127, 129; his observations demanded, 129; his Catalogue, 129; letter to Hevelius, 192; sends lenses to Hevelius, 193; remarks on astronomical observations, 193; his opinion of himself and of Halley, 263.
- Flounders, manner of keeping, 215.
- Flow of water from vessels, rate of, 160, 228.
- Focus of all rays parallel to the axis, 220.
- Folkes, Martin, 22.
- Force of the magnet at several distances, 135; of the magnetic needle and its variation, 136; of running water, 156, 226; of the wind, 158, 226.
- Foulness—why trees will not grow there, 216.
- Fountains, height of, 149, 223.
- France and Italy, Halley's Tour of, 4, 18, 53, 281.
- French books, inquiries and account of, 49.
- Gale, Roger, letter to, 126.
- Gale, Thomas, 1, 15.
- Gauge for showing the depth to which the diving bell descends, 232.
- Geography of the Ancients and Moderns, 166, 217, 238.

- George (King), I, 12, 23.
 Gilt wire, thickness of gold on best, 216.
 Glasses for telescopes, engine for grinding, 228; rule for finding the focus of spherical, 222.
 Gold, thickness of, on best gilt wire, 216.
 Goodwin Sands, proposals for recovery of, 215.
 Graham, George, 12.
 Grand Tour, the, 4, 18, 53, 281.
 Gravehau, Mr., 128.
 Gravitation, Newton's theory of, 63.
 Greaves, John, 211, 213.
 Gregory, David, 33, 35.
 Grew, Nehemiah, letter from Hevelius to, 189.
 Greyhound that voided an animal, 98.
 Grouped references for Halley's life and work, 279.
 Gunnery, shot to fit the bore of a piece, of great consequence in, 219.
 Gunpowder, effect of explosion of, on windows of houses, 216.
 Guns, method of enabling a ship to carry its, in bad weather, 164, 231.
- Halley, Catherine (Halley's daughter), 5 *n.*, 255, 256, 257, 259.
 Halley, Edmond (Halley's Father), I, 2; death of, 6 *n.*; broadsheet relating to his mysterious death, 176-7.
 Halley, Edmond.
 Memoir of his life, 1-13; Éloge by D'Ortous de Mairan, 15-27; parentage, birth, and education, I, 15, 173, 279, 280; his first paper, I, 15; visit to St. Helena, 2, 16, 39, 179, 279; M.A. (Oxford), 3, 17, 280; F.R.S., 3, 17; his Southern Catalogue, 3, 16, 17, 41; visit to Hevelius at Dantzic, 3, 18, 42, 187, 188, 189, 190, 280; journey to France and Italy, 4, 5, 18, 48, 53, 281; Comet of 1680, 5, 18; his marriage, 5, 19; his children, 5, 27; lives at Islington, 6; observations of the moon, 6; friendship with Newton begins, 6, 20; his father's death, 6 *n.*; litigation with his step-mother, 6, 257; his many papers, 7, 13, 20, 24; appointed Assistant Secretary (Clerk) of the Royal Society, 7, 58; publishes the *Philosophical Transactions*, 7, 11, 239; appointed Deputy-Comptroller of the Mint at Chester, 7, 27, 241, 282; his help to Peter the Great, 7, 8, 26, 282; appointed Commander of the 'Paramour Pink', 8, 9, 21, 242, 243, 244; voyages in Atlantic Ocean, 8, 9, 21, 103-20, 244, 282; his grief at the loss of a favourite boy, 8, 246; publishes his chart of the variations of the compass, 9, 22; observes the course of the tides, 9, 22; publishes map of British Channel, 9; missions to Vienna, 9, 22, 248, 283; chosen Savilian Professor at Oxford, 10, 23, 283; publishes translation of Apollonius, *De sectione Rationis*, 10, 24; publishes Apollonius' *Conics* and Serenus' *Sections of Cone and Cylinder*, 10, 24; prints Menelaus' *Sphericks*, 11; chosen Secretary of the Royal Society, 11, 23; created D.C.L., 11, 284; prepares Astronomical Tables, 11, 24; recommended and appointed to succeed Flamsteed as Astronomer Royal, 11, 23; obtains new instruments for the Observatory, 12; his solar and lunar observations, 12, 23, 24; his constitution, 12, 24; paralytic seizure, 13, 24; death and burial, 13, 24, 284; his theory of the variation of the compass, 19, 55, 63, 64; his character, 22, 26, 261; chosen Foreign Associate of Academy of Sciences of Paris, 24;

Halley (*cont.*)

correspondence of, 29-36;

letters of, 37-133;

Letters to:

Anstis, 130;

Ashe, 61;

Aubrey, 47;

Burchett, 103-15, 116-20, 122-3;

Caswell, 67;

Charlett, 125;

Flamsteed, 37, 42, 127, 129;

Gale, 126;

Hayley, 82;

Hevelius, 41, 44, 53, 54, 72;

Hill, 88;

Hooke, 48, 49;

Hudson, 125;

Keill, 128;

King James II, 85;

Leeuwenhoek, 56, 66;

Molyneux, 57, 64;

Moore, 39;

Neumann, 88;

Newton, 91, 92, 95, 96, 131, 132;

Olhoff, 45;

Pound, 129;

Reisel, 68;

Sharp, 90, 123;

Sloane, 89, 97, 98, 100, 102, 115,

127, 128, 131, 132;

Southwell, 120;

Sturm, 55, 62;

Valvasor, 86;

Wallis, 66, 70, 74, 75, 77, 80, 85;

his early observations, 37;

observes eclipse of the moon, 38, 40;

his observations at St. Helena, 40, 229;

intends going to Denmark, 43;

offers to procure books for the Royal Society's Library, 48;

his lost letters to Hevelius of 1679, 1680, and 1681, 53;

transmits articles to Hevelius, 54;

invites correspondence from Molyneux, 58;

endeavours to measure a degree of the earth, 67, 70;

his directions for observing eclipse of the sun at Smyrna in May 1687, 82;

his 'Carmina Encomiastica', 87;

on board ship, 88, 96, 224;

absence from the Royal Society, 89;

account of his voyages and travels in

letters to Burchett, 103-20;

account of monies spent in command of

the 'Paramour Pink', 122;

unprinted papers of, 135-70;

his diving bell, 150, 224;

his mortar-piece, 156, 223, 224, 226;

his ancestry, 173;

his arms, 178;

extracts from Robert Hooke's Diaries relating to, 182-6;

letters from Hevelius, 193, 195, 197;

Newton, 198, 199, 200;

Leibniz, 200, 201;

his second visit to Italy, 200;

letter from Jean Bernoulli, 201;

Latin hexameters prefixed to the 'Principia', 203, English versification of, 207;

extracts from the Journal Books of the Royal Society relating to, 210-38;

his map of ancient Britain, 221;

his instrument for keeping fire under water, 225;

recommended for Professor of Astronomy at Oxford, 226;

his liquor for his leather suits, 229;

his draught of the west coast of Sussex, 233;

extracts from Council Minutes of the Royal Society relating to, 239-40;

payments to, as Clerk to the Royal Society, 239, 240;

his instructions when in command of the 'Paramour Pink', 243;

receives diamond ring from the Emperor Leopold, 9, 249;

his inaugural address as Savilian Professor of Geometry at Oxford, 251;

Admiral Smyth's eulogium of, 253;

his will, 255;

his tomb at Lee, inscription on, 258; restoration of, 259;

his character and personality, 261;

his political leanings, 268;

his place among the world's geniuses, 269;

- his horoscope, 271;
 list of his published writings, 272;
 his life and work, grouped references
 for, 279;
 his portraits, xiii, 285;
 biographies, 285;
 bibliographies, 287.
- Halley, Edmond (Halley's son), 5 n., 255,
 256.
- Halley, Francis, 174.
- Halley, Humphrey (Halley's grandfather),
 173, 174, 175.
- Halley, Margaret (Halley's daughter),
 5 n., 255, 256, 258.
- Halley, Mary (née Tooke), Halley's wife,
 5, 19; death and burial, 5 n., 258.
- Hand, mal-formation of, 231.
- Hanging, death by, 237.
- Harriot, Thomas, 27.
- Harwich, shells found at, 213.
- Hayley, William, 35; letter to, 82.
- Hearne, Thomas—his account of Halley's
 inaugural address as Savilian Pro-
 fessor of Geometry, 251; his opinion
 of Halley, 269.
- Heat, expansion of liquors by, 138, 211;
 of the sun in any latitude, rule for
 collecting the, 218.
- Hedges and fences of Barbadoes, 217.
- Hercules, Nebula in, 129.
- Hereditary infirmities, 231.
- Hermaphrodite at Tholose, 81.
- Hevelius, Johannes, 2, 4, 16, 30, 31, 34,
 91, 94, 95, 236; Halley's visit to,
 3, 18, 42, 187, 188, 189, 190, 280;
 fire at his observatory, 4; controversy
 with Hooke about telescopic sights, 3,
 57, 60, 65; Halley's opinion of, 60,
 65; his instruments and observations,
 42, 44; rumoured death of, 45; letters
 to, 41, 44, 53, 54, 72; selected letters
 of, 187; letter from Croune to Heve-
 lius, 187; letter to Croune, 188;
 letter to Grew, 189; letters to
 Cluver, 190, 191; letter from Flam-
 steed to, 192; letters to Halley, 193,
 195, 197; letter to Aston, 197; his
 observations with plain sights with
 Halley, 189, 190; restoration of his
 observatory, 191; rumour of his great
 fire, 192; complains of Halley's
 silence, 193; requests new lenses,
 books, &c., 194; inquires prices of
 clocks and requests observations of
 comet of 1680/1, 195; purchase
 of lenses, 196; complains of silence
 of French astronomers, 196; receives
 package of lenses, &c., from Halley,
 197; his correspondence with English
 friends, 197.
- Hevelius, Madame, Halley sends dress for,
 46.
- Hexameters prefixed to the 'Principia',
 203; English versification of, 207.
- Hill, Abraham, 31; letter to, 88.
- Hill, Thomas, 36.
- Hooke, Robert, 4, 30, 34, 99; letters to,
 48, 49; improvement of the baro-
 meter, 59, 61, 65; his level, 60, 61,
 65, 69; controversy with Hevelius
 about telescopic sights, 3, 57, 60, 65;
 his amplifying barometer, 69; his
 hypothesis concerning changes in
 earth's surface, 77, 81; extracts from
 his MS. Diaries relating to Halley,
 182.
- Horoscope of Halley, 271.
- Houghton, John, 31.
- House, Halley's, at Islington, 6; at
 Oxford, 125.
- Hudson, T., 33; letter to, 125.
- Hurricanes in the latitude of the Caribbe
 Islands, 218.
- Huygens, Christian, 16, 146.
- Hyde, Thomas, 36.
- India Office Records relating to Halley's
 visit to St. Helena, 179.
- Indian Fig, hedges and fences of, 217.
- Infinite quantity, several species of, 214.
- Infirmity that was hereditary, 231.
- Inscription on an altar piece at Chester,
 98, 99; on a stone, 126; on Halley's
 Tomb at Lee, 258.
- Instrument for keeping fire under water,
 225; for showing depth of water to
 persons in Diving Bell, 155, 225;
 for blowing up Ships under water,
 or houses in case of fire, 155, 226;
 for measuring way of a Ship, 160,

- Instrument (*cont.*)
 227; for observing at Sea, 161, 162, 228, 230; to observe celestial motions by reflexion, 162, 230.
- Iris, proposition for determining the semi-diameter of the, 237; rule for computing the diameters of the primary and secondary, 237; lemma used to determine the diameter of the, 237.
- Isle of Wight, stones found at the, 235.
- Islington, Halley's observatory at, 6.
- Italy, Halley in, 5.
- Itinerary of Antoninus for Britain, 166, 217, 221, 227, 238.
- James (King), II, 7, 31; letter to, 85; presentation of copy of 'Principia' to, 85, 209.
- Jects d'Eau, height and velocity of spirting waters in, 147, 149, 223.
- Jedd, Mr., *see* Jett.
- Jett, Mr., undertakes to polish a small diamond, 222; impracticable to grind a diamond spherical, 235; presents a piece of elephant's tooth, 220.
- Journal Books of the Royal Society, extracts relating to Halley from the, 210-38.
- Jupiter, tables for computing motion of first satellite of, and its eclipses, 234; occultation of, 72.
- Jurin, James, succeeds Halley as Secretary to the Royal Society, 11.
- Justel, Henri, 34, 35, 48, 88; engine that consumes smoke, 60, 62.
- Keill, John, 33; letter to, 128.
- Key to sources of original material relating to Halley, 288.
- Kirch, Gottfried, his comet observations, 201; great comet of 1680/1, 219.
- Kirk, Mr., *see* Kirch.
- La Condamine, C. M. de, 36.
- Lake of Zircknitz, remarkable properties of, 86.
- Latin Hexameters prefixed to the 'Principia', 203.
- Leather suits, liquor for, 229.
- Leeuwenhoek, Antony van, 30; letters to 56, 66; asked for copies of his engraved portrait, 66.
- Leibniz, G. W., 36, 128; letters to Halley, 200, 201; asks Halley to urge Newton to publish, 200.
- Leopold, Emperor, 9, 22; presents diamond ring to Halley, 9, 249.
- Letters, from Halley, list of, 29-33; to Halley, 34-6.
- Level by Hooke, 60, 61, 65.
- Lightning in France, an unaccountable effect of, 79.
- Limerick, draught of in 1652, 219.
- Liquors, expansion of, by heat, 138, 211; rarification of, 138, 211.
- Lobsters and crabs which shoot their claws, 232.
- Logan, James, 36.
- Logarithm tangents, analogy between the meridian line and the scale of, 237.
- Logarithms, 90; method of composing the, 235, 236.
- Longitude, problem of finding the, 212; observed by means of the pendulum clock, 212; determination of the, 220, 238.
- Macclesfield, Earl of, recommends Halley to succeed Flamsteed as Astronomer Royal, 11, 23.
- Machin, John, 36.
- Maclaurin, Colin, 36.
- Madness, cases of, after drinking an infusion of a root, 237.
- Magnet, the force of the, at several distances, 135.
- Magnetic compass, variation of the, 8, 19, 21, 55, 63, 64, 97, 226, 227, 228, 229, 235; Halley's Chart, 9, 22.
- Magnetic needle, force of, and its variation, 135, 136.
- Magnetical cart, experiment of a, swimming on the surface of water, 220.
- Magnitude of objects under water, rule for finding, 228.
- Mairan, J. J. d'Ortous de, *Éloge de M. Halley*, 15-27.
- Malpighi, Marcello, letter and books sent to, 214.

- Map of British Channel, 9; of ancient Britain, Halley's, 221; of South Pole, 235.
- Marshall, John, letter signifying satisfaction with his way of grinding glasses, 233.
- Meat, method of salting, 234.
- Mediolanum, in Britain, discovery of site of, 227.
- Mercator's Chart, interval of meridional parts in, 236.
- Mercury, Transit of, 3, 17; appearances of, 222.
- Meridian line, analogy between the, and the scale of logarithm tangents, 237.
- Meridians, differences of, 229.
- Miles, differences in distance of ancient and modern, 217.
- Mill near Marylebone, description of, 235.
- Miller, Philip, 36.
- Mills, two curious, at Chester, 100, 101.
- Mint at Chester, 97, 241.
- Molyneux, William, 30, 31, 32, 34, 35, 82; letters to, 57, 64.
- Money, manner of melting down old, 236.
- Monies spent in Command of 'Paramour Pink', 122.
- Moon, Albatenius' observations of eclipses of the, 233; eclipse of, observed by Halley, 38, 40; eclipse of, 1686, 73; of 1696, 100; of 1697, 103; of Sept. 19, 1689, 216; eclipses computed by an easy calculus, 230; motion of the, 230; observations of the, 6; theory of the, 230; method of observing its place, 231; occultations of stars by, 238.
- Moore, Sir Jonas, 2, 3, 16, 20; letter to, 39; death of, 45 *n.*, 46.
- Mortality tables of Breslau, 89, 231.
- Mortarpiece made by Halley, 156, 223, 224, 226.
- Muscle, large horse, 214.
- Musgrave, William, 35.
- Nebula in Hercules, 129.
- Nelson, Robert, Halley's companion in journey to Paris and Italy, 4; 33.
- Neumann, Caspar, 32, 35; letter to, 88.
- New River, draught of survey of, 236.
- Newton, Sir Isaac, 18, 24, 25, 27, 30, 31, 32, 34, 35, 36; friendship with Halley begins, 6, 20; his 'Principia', 6, 20, 68, 80, 85; Halley's Latin hexameters prefixed to, 203; their English versification, 207; presentation of copy to King James II, 85, 209; theory of gravitation, 63; his quadratures of curves, 91; letters to, 91, 92, 95, 96, 131, 132; letters to Halley, 198, 199, 200.
- Nicholas, William, 36.
- Nottingham, Earl of—letter to Lord High Treasurer with reference to Halley's mission to Vienna, 248.
- Nucleus within the earth, hypothesis of a, 229.
- Oak, Halley's constellation of the, 17.
- Objects under water, rule for finding magnitude of, 228.
- Observations for 1714/5 demanded of Flamsteed, 129.
- Observing at sea, instrument for, 161, 162, 228, 230.
- Occultations and transits of the fixed stars by the Moon, 238.
- Oil of turpentine found at Hogsdon near London, 70.
- Oldenburg, Henry, 29, 30.
- Olhoff, Johann Eric, 30; letter to, 45.
- Olive trees—where they thrive, 219.
- Orb of comet of 1680/1, 92, 198, 199, 200; of Comet of 1683, 91.
- Original material relating to Halley, key to sources of, 288.
- Oughtred, William, 27.
- Oxford, Halley's house at, 125.
- Oyster shells, bed of, found near Reading, 234.
- Palmyra, account of, 236; inscriptions found there, 236.
- Papers of Halley, 135-70.
- Papin, Denis, his hydraulic instrument, 68; his experiment of compression of air, 60, 62; his experiment of quantity of air produced by explosion of gunpowder, 78.

- Paramour Pink, Halley's appointment to, 8, 9, 21, 242, 243, 244.
- Paris, bulk and people of, 52; Halley's visit to, 4, 18, 48, 281.
- Pendulum clock to observe the longitude, 212; at Cayenne, observations made with the, 234.
- Personality, Halley's character and, 261.
- Peter the Great, 7, 26, 261.
- Petrified wood burns and flames, 220.
- Petty, Sir William, his vital statistics, 89.
- Phosphorus, influence of air in kindling of, 137.
- Pigott, Thomas, 47.
- Planets, finding times of stations of, 237.
- Plants at St. Helena, peculiarities of, 211; at Chelsea Physick Garden, 211.
- Poles of the earth, alteration of the, 210.
- Polypus of St. Helena, description of the, 214.
- Portraits of Halley, note on, xiii.
- Portsmouth, great tide at, 221.
- Potosi, rich silver ore from, 216.
- Pound, James, 33, 36; letter to, 129.
- Powder, saving of, in the casting of bombs, 218.
- Prescot, Mr., of Chester, 99.
- Pressure, evacuating water by, 165, 235.
- Price (formerly Butler), Catherine (*née* Halley), 5 *n.*, 255, 256, 257, 259.
- 'Principia', 6, 20, 68, 80, 85; Halley's Latin hexameters prefixed to, 203; English versification of, 207; presentation of copy to King James II, 85, 209.
- Prickle pear, hedges and fences of, 217.
- Prideaux, Humphrey, 126.
- Prism to transmit only red light, 169.
- Projectiles, Halley's paper on the motion of, 20.
- Projection of the Sphere, 233, 236.
- Pulleyn, Octavian, 35.
- Pulleys, use and power of, 225, 226, 230.
- Pyke, Isaac, 36.
- Quadrature of the circle, 123.
- Quadratures of curves, 91.
- Queen Anne, 9, 22; letter of, 248.
- Rainbow crossing a street like an arch, 237.
- Rarification of liquors, 138, 211.
- Ray's *History of Plants*, 68.
- Rays parallel to the axis, focus of, 220.
- Reading, bed of oyster shells found near, 234.
- Red light, prism to transmit only, 169.
- Refraction of the beams of Light, 146; of Crystal, 222; of Diamond, 146, 221; of Liquors, 145.
- Reisel, Salomon, 31, 34, 35; letter to, 68.
- Repeating clocks, 214.
- Richer, Jean, his observations at Cayenne, 229.
- Rigaud, Stephen Peter, on Halley's character, 266.
- Robert III, King of Scotland, legitimacy of, 236.
- Roberts (Robartes, Francis), 98.
- Roman city at Chester, 97.
- Rooke, W., 35.
- Roots of equations, determination of number of, 210; method for extracting, 233; of pure or adfected equations, 234.
- Royal Society, extracts from Council Minutes, 239-40; extracts from Journal Books, 210-38.
- Royal Society Club, origin of the, 252, 284.
- Ruiters, Dirick—his book describing the coasts of America and Africa, 234.
- 'Runner and Tackle', use and power of, 225, 226, 230.
- St. Helena, Halley at, 2, 16, 39, 179, 279; his observations at, 40, 229; Adiantum at, 211; Polypus of, 214.
- Salting meat, method of, 234.
- Salts, examination of, 215, 216; specific gravities of, 217.
- Saunderson, William, 36.
- Sea, instrument for observing at, 161, 162, 228, 230.
- Sea-crab, model of a, 230.
- Sea-draught of the mouth of the River Thames, 215.
- Sharp, Abraham, 32; letters to, 90, 123.
- Shells, cancellus in old, 229; found at Harwich, 213; in black and red marble, 238.
- Sherwin, Henry, 33.

- Ship, an instrument for measuring the way of a, 160, 227; method of enabling a, to carry its guns in bad weather, 164, 231.
- Ships, method of weighing of, 225; instrument for blowing up, 155, 226.
- Shirt wove without seam from India, 67, 69.
- Shooting bombs, Alberghetti's tables for, 167, 168.
- Shot to fit bore of gun, 219.
- Silver ore from Potosi, 216.
- Sloane, Sir Hans, Halley succeeds him as Secretary of the Royal Society, 11; 32, 33; letters to, 89, 97, 98, 100, 102, 115, 127, 128, 131, 132.
- Smith, Samuel (printer and bookseller), 213.
- Smith, Thomas, 34, 36.
- Smyth, Admiral W. H., his eulogium of Halley, 253.
- Sound under water, 153, 224.
- Sources of original material relating to Halley, key to, 288.
- South Pole, map of, showing variations, 235.
- Southern Stars, Catalogue of, 2, 3, 16, 17, 41.
- Southwell, Sir Robert, 33; letter to, 120.
- Sphere, projection of the, 233, 236.
- Spiriting waters in 'Jects d'Eau', height and velocity of, 147, 149, 223.
- Spruce-beer, 236.
- Stars of the Southern Hemisphere, Catalogue of, 2, 3, 16, 17, 41.
- Stars, occultations and transits of the fixed, 238.
- Statistics, 52, 89, 232.
- Stepney, George, 9, 22, 249.
- Stones of Chester, nature of, 99; of the Isle of Wight, 235.
- Strength and force of running water, 156, 226.
- Stronbolo, one of the Isles of Lipara, constantly blows up, 220.
- Sturm, Johann Christoph, 30, 34; letters to, 55, 62; his *Mathesis Enucleata*, 219.
- Sun, eclipses of, 40, 82; Halley's directions for observing eclipse of, at Smyrna in May, 1687, 82; rule for collecting the heat of the, 218; Albatenius's observations of eclipses of, 232.
- Sun and Moon, eclipses of, computed by an easy calculus, 230.
- Sunderland, Earl of, 12, 23.
- Survey of a coast, 120; of New River, 236.
- Sussex, Halley's draught of the West Coast of, 233.
- Sykes, A. A., 10.
- Taylor, Brook, 36.
- Telescope, engine for grinding glasses for a, 228; manner of moving the reflecting plate of a, 230.
- Telescopic sights, controversy between Hooke and Hevelius, 3, 57, 60, 65.
- Testimonial to Halley for Professorship of Astronomy at Oxford, 226.
- Tetter, cure of a, 213.
- Thames, comparison of fall of, with that of other rivers, 220; sea-draught of mouth of the River, 215.
- Theriaca Andromachi, effect of dose of, 217.
- Thermometer, construction of, 142, 211; a new, and the rarification of liquors, 138, 211; in which degree of heat may be measured by amount of vapour given off by a liquid, 137, 210.
- Thomas, Père, observations made at Siam, 229.
- Tide at Portsmouth, great, 221.
- Tides, course of the, 9, 22, 86; round Great Britain, 233.
- Tillotson, Archbishop, 88.
- Time, equation of, 212.
- Toad found in a great block of stone, 235.
- Tooke, Mary, marriage to Halley, 5, 19; death and burial, 5 n., 258.
- Trade winds, cause of, 74, 75, 80; history of, 20.
- Transit of mercury, 3, 17.
- Transits of the fixed stars by the Moon, 238.
- Trees will not grow in Canvey and Foulness, 216.
- Tropic, moment of the, 231.

- Turpentine found at Hogsdon near London, 70.
- Valvasor, Johann Weichart, letter to, 86.
- Vapour, quantity of, accumulated in a year, 234.
- Vapours returned to the sea, 217; rising out of water, 140, 212.
- Varen, Mr., 49.
- Variation of the magnetic compass, 8, 19, 21, 55, 63, 64, 97, 226, 227, 229, 235; Halley's Chart, 9, 22.
- Velocity of water, 147, 149, 223.
- Verses by Halley prefixed to the 'Principia', Latin, 203; English, 207.
- Vienna, a nobleman of, 30.
- Vienna, Halley's missions to, 9, 22, 248.
- Vital statistics, 89, 232.
- Wallis, John, 4 n., 10, 23, 31, 34, 35, 36; letters to, 66, 70, 74, 75, 77, 80, 85.
- Walther, Bernard, 210.
- Watches, contrivance of clocks and, 214.
- Water, amount required to drown the whole world, 235; apparent magnitude of objects under, 228; evacuation by pressure, 165, 235; flow from vessels, 160, 228; rising of vapours out of, 140, 212; sound under, 153, 224; strength and force of running, 156, 226; velocity of spirting, 147, 149, 223; walking under, 144, 214; working under, 154, 225; fire under, 225.
- Watts, Mr., of Chelsea, 211.
- Way of a ship, instrument for measuring the, 160, 227.
- Weighing of ships, method of, 225.
- Weight or force of the wind, 158, 221, 226.
- Weights, engine for raising, 230; method of raising and removing great, 225, 226; comparison of English and French, 213.
- Whiston, William, 25, 36.
- Wild-fowl—how to know whether fresh or not, 217.
- Wilkins, Bishop, 235.
- William (King), III, 7, 27.
- Williamson, Sir Joseph, 2, 16.
- Willoughby's *Natural History of Fishes*, 66, 68.
- Winchelsea deserted by the sea, 212.
- Wind, weight or force of the, 158, 221, 226.
- Windmills at Chester, 100, 101.
- Wood, petrified, burns and flames, 220.
- Woods that bear frost above all others, 221.
- Wright, Thomas, 36.
- Writings, list of Halley's published, 272.
- Wurtzelbaur, J. P., 210.
- Year, contraction of the, 232.
- Zircknitz, remarkable properties of Lake of, 86.