

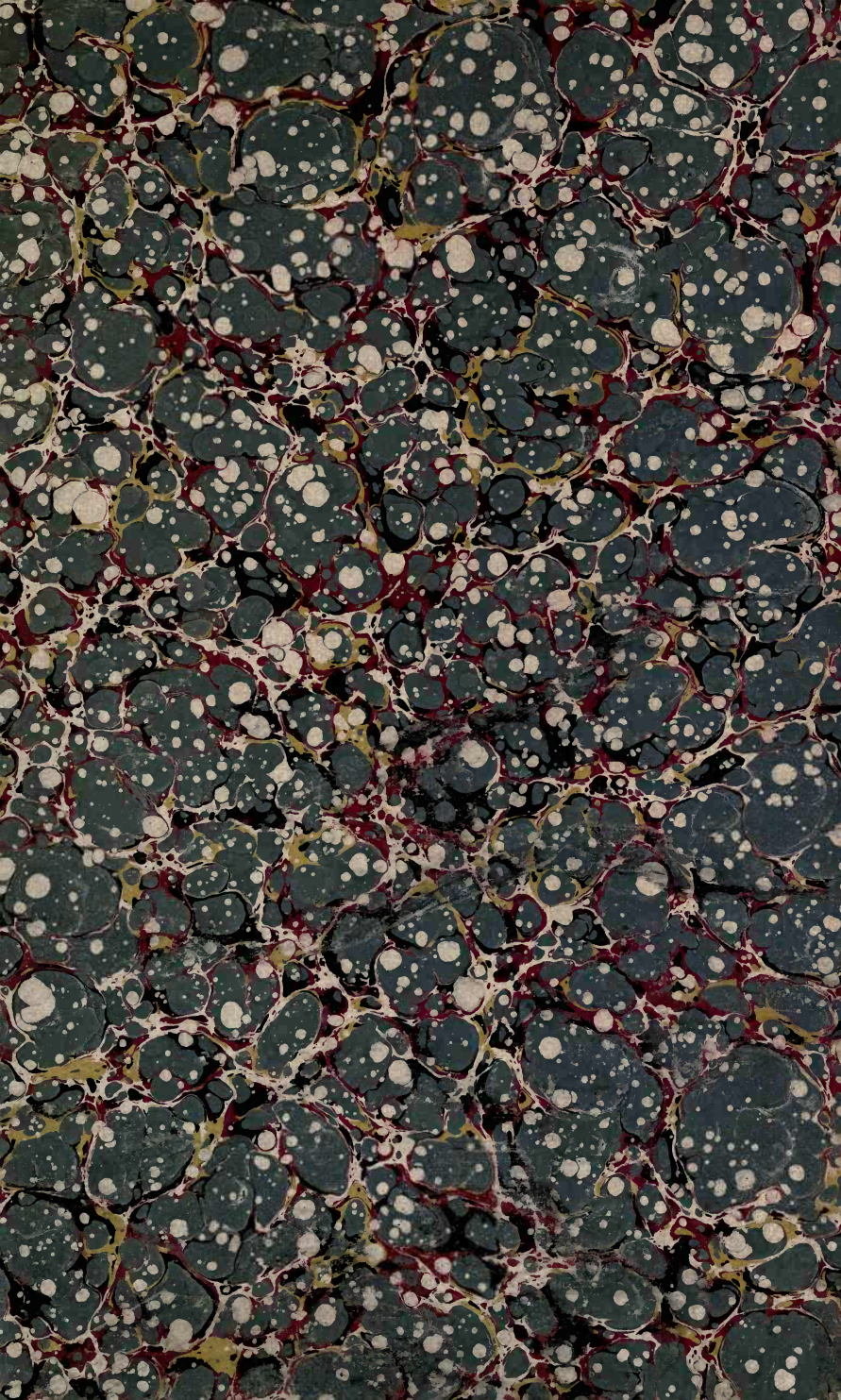

LIBRARY
OF THE
UNIVERSITY OF CALIFORNIA.

Accession 30264. Class



DYNAMO-ELECTRIC
MACHINERY.



WYOMING ELECTRIC
MACHINE

DYNAMO-ELECTRIC MACHINERY:

A MANUAL
FOR STUDENTS OF ELECTROTECHNICS.

BY

SILVANUS P. THOMPSON, D.Sc., B.A.;

PRINCIPAL OF, AND PROFESSOR OF PHYSICS IN, THE CITY AND GUILDS OF LONDON TECHNICAL
COLLEGE, FINSBURY;

LATE PROFESSOR OF EXPERIMENTAL PHYSICS IN UNIVERSITY COLLEGE, BRISTOL;

MEMBER OF THE SOCIETY OF TELEGRAPH-ENGINEERS AND ELECTRICIANS;

MEMBER OF THE PHYSICAL SOCIETY OF LONDON;

MEMBRE DE LA SOCIÉTÉ DE PHYSIQUE DE PARIS;

HONORARY MEMBER OF THE PHYSICAL SOCIETY OF FRANKFORT-ON-THE-MAIN;

FELLOW OF THE ROYAL ASTRONOMICAL SOCIETY.

SECOND EDITION, ENLARGED AND REVISED.



E. & F. N. SPON, 125, STRAND, LONDON.

NEW YORK: 35, MURRAY STREET.

1886.

TK2181
T4

General

30264



PREFACE

TO THE SECOND EDITION.



SINCE the publication of the first edition of this work in the autumn of 1884, much has been done towards perfecting the dynamo, both in practice and in theory. Additional matter has accordingly been added, involving an increase of one hundred and ten in the number of pages and of ninety-four in the number of cuts.

The new matter is partly embodied in the text and is partly added in the form of Appendices. The latter half of Chapter V. on the Reactions between the Armature and the Field Magnets has been re-written, introducing a section on the heating of pole-pieces. The dynamos of Class I. are now divided into two sub-classes, those in which the windings are united into a closed coil, and those in which an open-coil arrangement is adopted. Many additional forms of dynamo, including the latest designs of Gramme and of Siemens, have been added: and the reader will not fail, on comparing the latest Gramme (Fig. 92) with the latest Siemens (Fig. 129) to perceive a curious assimilation of type. Chapter XI. on Machines for Electroplating and Metallurgy is entirely new. Chapter XIX. on Coupling two or more Dynamos in one Circuit is also new: the author is indebted to Mr. W. M. Mordey for the section upon the coupling of compound dynamos, and to Mr. R. M. Walmsley, B.Sc., for the summary of Hopkinson's researches upon the coupling of alternate-current dynamos and for the geometrical illustrations which accompany it. Some additional information is given respecting electric motors; and much of the various sections which relate to the methods of making dynamos self-

regulating has been re-written. In the Appendices a considerable addition has been made to the summary of formulæ relating to electromagnets, notably the formula of Lamont. The note on Joubert's equations which formerly occupied Appendix IV. has been omitted, and is replaced by a summary of the recent researches of Frölich and of Rücker on the mathematical theory of the dynamo. The Appendices on the forms of field magnets, on the influence of pole-pieces, and on electric governors are entirely new.

During the fourteen months which have elapsed since the publication of the former edition a translation of the work into French has appeared. The author is indebted to the able pen of Monsieur E. Boistel for the skill and fidelity with which he has discharged his functions as a translator; and in the preparation of the present revised edition he has not failed to avail himself freely of numerous suggestions and additions derived from M. Boistel's labours. He has further to thank M. Baudry, the publisher of M. Boistel's translation, for permission to reproduce a considerable number of cuts relating chiefly to the newer types of the machines of Siemens and of Gramme. The author is indebted to the publishers of Fontaine's *Electrolysis* for most of the cuts in Chapter XI., and to the publishers of *Engineering*, the *Electrician*, and the *Electrical Review*, for sundry additional cuts, as also to several of the firms mentioned in the preface to the former edition.

The thanks of the author are also due to many friends and correspondents who have kindly furnished him with suggestions and information.

In view of the possibility of further editions being called for at a future date, the author will be glad to receive further statistical information of the kind of which a few samples are given in Appendix XI.; and, in particular, information is desired concerning constant-current generators and self-regulating motors. It is in these two departments of the subject of dynamo-electric machinery that the next advances are to be expected. The experiments now being prepared by M. Marcel Deprez at Creil, and the papers which that able

engineer has lately published on the subject, show how far even so experienced an authority still is from attaining finality in the solution of the problem he has undertaken.

It is, however, in the theory of the dynamo that the truest progress has been made. Prior to the appearance of the former edition of this work, there were, with one exception, no equations by means of which the current or potential of any given dynamo might be written down with both simplicity and accuracy. The expressions deduced by Mascart were simple but not accurate, and those of Clausius, though theoretically complete, were anything but really simple. The one exception was afforded by the theory of Frölich, propounded in the year 1881, based upon extremely simple assumptions, and, as applied by him to the one case of the series-wound machine, of sufficient accuracy and great simplicity. But Frölich's equation for the series-dynamo (see Appendix IV.) involved a formula for the electromagnet which the author could only regard as an approximation; and it was the knowledge that this formula was only an approximation, and not an exact expression of fundamental truth, that made him write, "Until we know the true law of the electromagnet, there can be no true or complete theory of the dynamo." Nevertheless, believing that Frölich's formula for the law of the electromagnet was sufficiently true for practical purposes, the author essayed in the former edition of this book to complete the theory of the dynamo upon the foundation thus laid. Starting from the point where Frölich stopped short, the author added expressions for the terminal potential of the series-wound dynamo, and for the currents and potentials of shunt-wound and compound-wound dynamos, and was agreeably surprised to find how closely these theoretical expressions corresponded to the observed facts. The author was also led to point out an important relation between the saturation coefficient of the field-magnets of the dynamo and the working limit of its electromotive-force. The expressions he deduced have been still further elaborated during the present year by Dr. Frölich in a remarkable series of papers, of which a summary account is given in Appendix IV. These expres-

sions, and the still more complete generalisations of Professor Rücker, are found to correspond with extraordinary accuracy to the observed facts. But if the law of the dynamo, as deduced from Frölich's formula for the electromagnet, is so marvellously true, its correspondence with the facts proves the truth of Frölich's formula for the electromagnet. There is, therefore, no other conclusion possible than that Frölich's formula for the electromagnet—a mere empirical formula in itself—is more true than the formulæ of Müller and of Weber which are to be found in the ordinary text-books of electricity. Yet it is a mere empirical formula, destitute of physical meaning, and therefore cannot itself be a complete or fundamental expression. This difficulty the author believes he has surmounted in the identification of Frölich's formula with a formula given in 1867 by the late Professor Lamont, and which the author believes to contain the true expression of the mathematical law of the electromagnet. Lamont's formula is indeed based upon a rational theory of magnetism, apparently originated by him, and which in a closely allied form has lately been put forward by Bosanquet; namely, that the magnetisability of a bar of iron depends at every instant upon the degree in which the iron is yet left unmagnetised. It would be a noteworthy circumstance if the theory of induced magnetism modestly put forward by Lamont eighteen years ago, and ignored by every writer on magnetic subjects since, were thus proved to be the true law that has so long been wanting to complete our knowledge. Should this be so, it will furnish one more example of the debt which abstract science owes to its technical applications.

FINSBURY TECHNICAL COLLEGE,
LONDON,
November 1885.

PREFACE

TO THE FIRST EDITION.

THE appearance of the present volume is caused by a demand for copies of the Cantor Lectures on Dynamo-electric Machinery, delivered by the author before the Society of Arts in the autumn of 1882. Those lectures, which appeared first in the Journal of the Society of Arts, were reproduced in the pages of the *Electrician*, the *English Mechanic*, and other technical journals; they were also reprinted in pamphlet form and published by Messrs. E. & F. N. Spon. A translation of them into French from the able pen of M. E. Boistel has recently appeared in Paris, and the author takes this opportunity of acknowledging his indebtedness to the courtesy of M. Boistel for introduction thus given to a wider circle of readers. Another edition has been brought out in New York by Mr. Van Nostrand, with the editorial assistance of Mr. F. L. Pope. Though the cheque which high authorities assure British authors never fails to accompany an American reprint has not yet reached this side of the Atlantic, the author acknowledges with appropriate gratitude the honour done to his earlier work.

The present volume, though based upon the author's lectures, is in no sense a mere reprint of them. A series of chapters has been added on the Mathematical Theory of Dynamo-electric Machines and of Electric Motors. Another section deals with the Graphic Method of Calculation as applied to the Characteristic Curves of Dynamos. A large amount of matter has been added to the earlier chapters, which now contain descriptions of all the recent inventions of importance. The author's aim has been to make the work

a Manual for Students of Electrotechnics, for whom no textbook of this branch of science has hitherto been available. In order not to swell the volume to undue proportions, no descriptions have been given of many obsolete forms of machine such as those of Pixii, Stöhrer, Clarke, Wilde, Holmes, Nollet, Hjörth, &c., which are chiefly of historical interest. For these the student is referred to the existing standard works, such as Dredge's *Electric Illumination*, Spons' *Dictionary of Engineering*, and to the treatises of Schellen, Niaudet, and Higgs.

The author's thanks are due to numerous friends who have given him assistance in the preparation of the work. To his colleague Mr. Edward Buck, M.A., and to his friend Mr. W. M. Moorsom, M.A., he is indebted for numerous suggestions in the mathematical treatment of the subject. The author also acknowledges his obligation to an article from the pen of his friend Professor Oliver J. Lodge, D.Sc., which appeared in the *Electrician*, which forms the basis of the calculation of the fluctuations of the current at the close of Chapter XII.

The author's thanks are also due to Dr. J. Hopkinson, F.R.S., and to Messrs. R. E. Crompton, Gisbert Kapp, W. M. Mordey, R. J. Gülcher, Paterson and Cooper, and to Messrs. Siemens Brothers, for valuable details and statistics respecting various forms of machine. He is indebted for the use of sundry cuts to the following: to the Council of the Society of Arts for a large number of cuts used to illustrate his lectures; to the publishers of *Engineering*; to the publishers of the *Electrician*; to the publishers of the *Electrical Review*; to Messrs. Macmillan and Co.; to Professors Ayrton and Perry; to Messrs. R. Hammond and Co.; to the Anglo-American Electric Light Corporation; to the Maxim-Weston Electric Light Co.; to the Rev. F. J. Smith, B.A.; to Dr. H. Schellen; to Messrs. Elphinstone and Vincent; to Messrs. Ganz and Co.; to Messrs. P. Brotherhood and Sons; and to Messrs. Mather and Platt.

In a branch of science which is of such recent growth, a treatise which embraces many new points cannot be free from errors, many of which time and experience will doubtless

reveal. The author will be grateful to any of those who work amongst electric machinery, who can furnish him with any observations that will throw light on the points which still remain obscure in the action of dynamos of different kinds. Particularly in relation to the various points of the mathematical theory developed in this work, and to the practical deductions therefrom, the author is desirous of obtaining additional evidence, especially such evidence as can be gleaned from other types of machine than those with which he has had the opportunity of working. Any statistical information with respect to the distribution of electric energy with a constant current, and with respect to alternate-current and unipolar dynamos, will be most acceptable, and will aid in forming truer generalisations on these matters.

Much is yet wanting to make the mathematical theory of the dynamo complete. The elaborate papers of Clausius, masterly as they are in many ways, are so far barren of results. Those papers, published in Wiedemann's *Annalen* in the winter of 1883, take cognisance, by means of a set of arbitrary constants, of a number of the minuter secondary influences at work in machines. These constants are for the most part capable of being determined by direct experiment for each machine or type of machines. But, taking constants that can be so determined, and having built up his equations to a high degree of elaboration that makes them too complicated for immediate application, their author reduces them at the close of his memoir to an extraordinary apparent simplicity by the substitution of another set of constants, compiled from the former. This mathematical *tour de force* is, however, fatal. The new constants have no physical significance whatever, and simplicity is gained by sacrificing their utility. The mathematical triumph remains a Pyrrhic victory.

The true mathematical theory of the dynamo can, indeed, only be written when the true basis for writing it shall have been discovered. That basis, the exact law of induction of magnetism in the electro-magnet, does not yet exist. Some information on what has been already done toward this subject will be found in Appendix III. ; but it still remains true that

we do not know the exact law, and content ourselves with formulæ which, though they are approximately near to the truth, rest on no basis of first principles, and are *known* to be incorrect. Of the laws of induction of magnetism in circuits consisting partly of iron, partly of strata of air or of copper wire, we know, in spite of the researches of Rowland, Stoletow, Strouhal, Ewing, and Hughes, very little indeed. Our coefficients of magnetic permeability and magnetic susceptibility, though convenient as symbols, are little more than convenient methods of expressing our ignorance. We want some new philosopher to do for the magnetic circuit what Dr. Ohm did for the voltaic circuit fifty years ago. Until we know the true law of the electro-magnet, there can be no true or complete theory of the dynamo.

Turning from theory to practice, the field for further work is equally wide. Enormous as is the progress that has been made in the past decade in the design and construction of electric machinery of all kinds, it may safely be said that there is no such thing yet as a best dynamo. As with the different kinds of voltaic batteries, some of which are used for telegraph work, others for electric bells, and others for blasting, so is it also with dynamos. One form is best for one purpose, and another for another. One gives steadier currents, another is less liable to heat, a third is more compact, a fourth is cheaper, a fifth is less likely to reverse its currents, a sixth gives a greater volume of current, while a seventh evokes a higher electromotive-force. Indeed, in the present transitional state of our knowledge with respect to dynamo-electric machinery, it is safe to assert that for a long time to come there will be no finality attained to. As with the steam-engine, so also with the dynamo machine, there will probably be a constant and progressive evolution, finally settling down upon two or three typical forms, which will survive the many comparatively crude machines which, as yet, have taken shape and come into active service.

CONTENTS.

PREFACE	PAGE
	v

CHAPTER I.

INTRODUCTORY.. .. .	I
---------------------	---

CHAPTER II.

* PHYSICAL THEORY OF DYNAMO-ELECTRIC MACHINES ..	7
--	---

CHAPTER III.

+ ORGANS OF DYNAMO-ELECTRIC MACHINES	20
--	----

CHAPTER IV.

+ ON THE INDUCTION OF CURRENTS IN ARMATURES, AND THE DISTRIBUTION OF POTENTIALS AROUND THE COLLECTOR	49
--	----

CHAPTER V.

+ REACTIONS IN THE ARMATURE AND MAGNETIC FIELD ..	70
---	----

CHAPTER VI.		PAGE
† GOVERNMENT OF DYNAMOS		91
Note on Capacity of Dynamos		
CHAPTER VII.		
TYPES OF MACHINES.—DYNAMOS OF CLASS I. (A) Closed-coil Armatures		113
CHAPTER VIII.		
TYPES OF MACHINES.—DYNAMOS OF CLASS I. (B) Open-coil Armatures		175
CHAPTER IX.		
TYPES OF MACHINES (<i>continued</i>).—DYNAMOS OF CLASS II. Sub-class:—Alternate-current Dynamos		204
CHAPTER X.		
TYPES OF MACHINES (<i>continued</i>).—DYNAMOS OF CLASS III...		223
CHAPTER XI.		
DYNAMOS FOR ELECTROPLATING AND ELECTRO-METALLURGY		231
CHAPTER XII.		
* ALGEBRAIC THEORY OF THE DYNAMO—ELEMENTARY BASIS OF CALCULATIONS		241
CHAPTER XIII.		
THE MAGNETO-DYNAMO, OR MAGNETO-ELECTRIC MACHINE		261

Contents.

XV

CHAPTER XIV.

PAGE

EFFICIENCY AND ECONOMIC COEFFICIENT OF DYNAMOS .. 267

CHAPTER XV.

× THE SERIES (OR "ORDINARY") DYNAMO 276

Note on the Saturation Coefficient.

Note on the Geometrical Coefficient.

Note on the Coefficient of Magnetic Permeability.

CHAPTER XVI.

× THE SHUNT DYNAMO 288

CHAPTER XVII.

× SELF-REGULATING DYNAMOS 299

CHAPTER XVIII.

× ALTERNATE-CURRENT DYNAMOS 325

CHAPTER XIX.

ON COUPLING DYNAMOS IN A CIRCUIT 335

CHAPTER XX.

THE GEOMETRICAL THEORY OF THE DYNAMO 350

CHAPTER XXI.

THE DYNAMO AS A MOTOR 393

CHAPTER XXII.

THEORY OF ELECTRIC MOTORS 404

	PAGE
CHAPTER XXIII.	
REACTION BETWEEN ARMATURE AND FIELD MAGNETS IN A MOTOR	423
CHAPTER XXIV.	
SPECIAL FORMS OF MOTOR	428
CHAPTER XXV.	
REVERSING GEAR FOR MOTORS	439
CHAPTER XXVI.	
RELATION OF SPEED AND TORQUE OF MOTORS TO THE CURRENT SUPPLIED	442
CHAPTER XXVII.	
GOVERNMENT OF MOTORS	445
CHAPTER XXVIII.	
MOTOR PROBLEMS SOLVED BY GRAPHIC METHODS	457
CHAPTER XXIX.	
TESTING DYNAMOS AND MOTORS	462

APPENDICES.

	PAGE
APPENDIX I.—MEASUREMENT OF SELF-INDUCTION OF A COIL	472
„ II.—MEASUREMENT OF MUTUAL INDUCTION BETWEEN TWO COILS	472
„ III.—ON THE FORMULÆ USED FOR ELECTRO-MAGNETS	474
„ IV.—RECENT ADVANCES IN THE THEORY OF THE DYNAMO	480
„ V.—ON THE ALLEGED MAGNETIC LAG	491
„ VI.—ON THE MOVEMENT OF THE NEUTRAL POINT..	493
„ VII.—ON THE FORMS OF FIELD MAGNETS	495
„ VIII.—ON THE INFLUENCE OF POLE-PIECES	501
„ IX.—ON THE INFLUENCE OF PROJECTING TEETH IN ARMATURES	502
„ X.—ELECTRIC GOVERNORS	504
„ XI.—STATISTICS OF SOME DYNAMOS	509
<hr style="width: 30%; margin: 0 auto;"/>	
INDEX	513

$$-\frac{kx_1^2}{2} + \int_{x_1}^{x_2} kx_1 dx = \frac{mv_1^2}{2}$$

$$P_{rc} = \frac{kx_1^2}{2} - \int_0^{x_2} kx_1 dx + \frac{mv_1^2}{2} + \frac{kx_2^2}{2} - \int_0^{x_2} kx_2 dx$$

$$= \frac{mv_1^2}{2} + \frac{mv_2^2}{2} + \frac{kx_2^2}{2} + \frac{kx_1^2}{2}$$

$$P_t = \int_0^t (x_1 - x_2) dt + mv_1$$

$$\int_0^t (x_1 - x_2) dt = -mv_2$$

$$P_t = mv_1 + mv_2$$

$$P_t + \int_0^t (x_1 - x_2) dt = \int_0^t (x_1 - x_2) dt + mv_1 + mv_2$$

$$P_t = mv_1 + mv_2$$

DYNAMO-ELECTRIC MACHINERY.

CHAPTER I.

INTRODUCTORY.



BY "Dynamo-electric Machinery," in the most general etymological sense of the term, is meant machinery for converting the energy of mechanical motion into the energy of electric currents, or *vice versâ*. From this wide definition must be excepted machines like the well-known statical induction-machine of Holtz, the action of which is purely electro-static. In the definition are included only those machines the action of which is dependent on the principle of electro-magnetic induction, discovered by Faraday in 1831. It is, however, not quite easy to decide what machines shall be called dynamo-electric machines, because the sense in which the term is commonly used is narrow, and restricted in a manner not quite logical.

The name dynamo-electric machine appears to have been first employed by Dr. Werner Siemens, in his communication of January 17th, 1867, to the Berlin Academy, in which he described a machine for generating electric currents by the application of mechanical power, the currents being induced in the coils of a rotating armature by the action of electro-magnets which were themselves excited by the currents so generated. The machine was, in fact, a self-exciting dynamo with the field magnets and armature united "in series" to the external circuit, or what we now call a "series-dynamo," a diagrammatic

Dynamo-electric Machinery.

representation of which is given in Fig. 1. But the term dynamo-electric machine, then introduced into electric technology, has not remained thus restrained to its narrowest meaning. It was next applied to machines of kindred nature, in which, though self-excited, only a portion of the entire current generated by the rotating armature was applied to

FIG. 1.

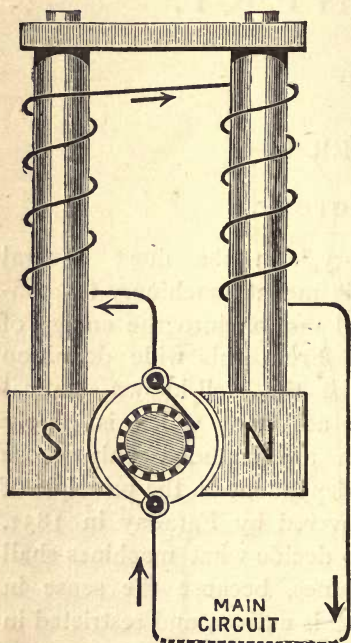

THE SERIES DYNAMO.

FIG. 2.

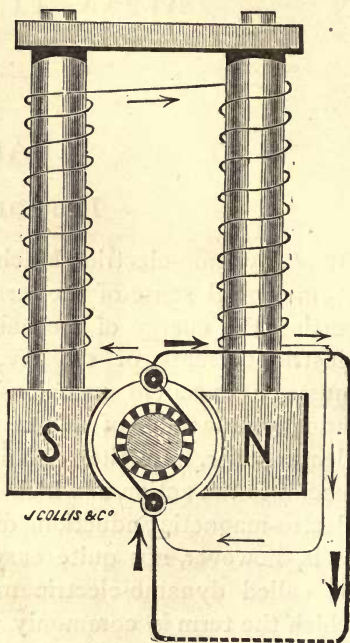

THE SHUNT DYNAMO.

excite the field magnets (see Fig. 2). This principle of working (now known as that of the "shunt-dynamo"), first introduced by Wheatstone, is but a variation of the former arrangement in detail, and no violence is done to the original term to apply it to both cases. In fact, the name was welcomed as being convenient in practice for distinguishing such machines from those which were not self-excited—those in which either steel magnets or separately-excited electro-magnets were used to produce the magnetic field.

But since the great development of electric lighting took place, it has been found convenient to use generating machines in certain combinations, in which the self-exciting principle is abandoned. Some systems of electric lights require alternating currents, produced in machines which cannot excite their own magnets with a continuous magnetisation ; and there are other systems where continuous currents are employed, in which also practice has shown that the currents are better regulated when the magnets of the dynamos are separately excited by currents derived from an external source. There is, then, a third class of dynamo-electric machine, the

FIG. 3.

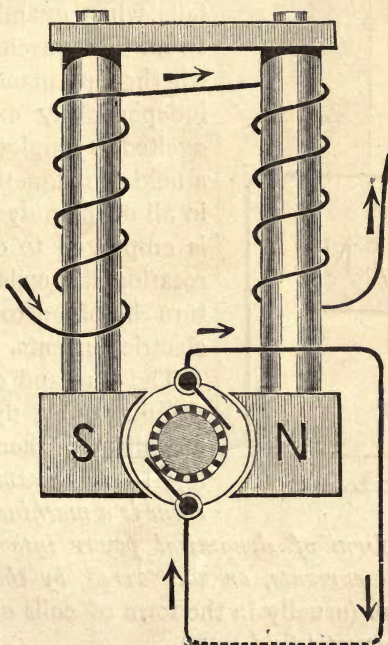

THE SEPARATELY-EXCITED DYNAMO.

“separately-excited dynamo” (Fig. 3), which was indeed earlier than either of the preceding, having been brought out by Wilde in 1866. A dynamo is a dynamo, in fact, whether

its magnets be excited by the whole of its own current, or by a part of its own current, or by a current from an independent source. The source of the magnetising power is indifferent, provided a magnetic "field" of sufficient intensity be produced wherein the generating coils can be rotated. Now, as it does not matter where the magnetising power comes from, it is clear

FIG. 4.

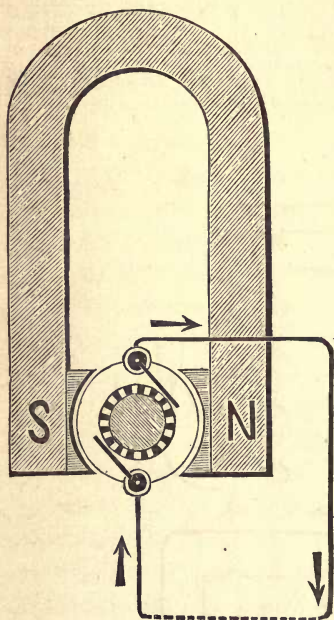

THE MAGNETO DYNAMO.

that we must include amongst possible sources the magnetism of permanent steel magnets. In short, the arbitrary distinction between so-called magneto-electric machines (see Fig. 4) and dynamo-electric machines fails when examined carefully. In all these machines a magnet, whether permanently excited, independently excited, or self-excited, is employed to provide a field of magnetic force. And in all of them dynamical power is employed to do the work of rotating the coils of the armature in order to generate the electric currents.

The true and comprehensive definition of a dynamo-electric machine is, then, the following:—*A dynamo-electric machine is a machine for converting*

energy in the form of dynamical power into energy in the form of electric currents, or vice versa, by the operation of setting conductors (usually in the form of coils of copper wire) to rotate in a magnetic field.

Inasmuch, however, as every dynamo-electric machine, in the most general sense of the term as now laid down, will work as a motor, and becomes a source of mechanical power when supplied with electric currents, it is possible to discuss dynamo-electric machinery from two opposite points of view

in serving the two converse functions. In short, it is possible to treat the dynamo on the one hand as a *generator*, on the other hand as a *motor*. And though both these functions are embraced in one theory of the most general mathematical form, they will be considered separately in this work.

The mathematical theory of the dynamo is, indeed, very complex, and takes different forms for its expression in the various classes of machine now included under the one name of "dynamo." For every different variety in each of these classes, there is a fresh variety of mathematical symbols. The theory of alternate-current machines is entirely different from that of machines which are to furnish continuous and constant currents. Every form of armature and coils requires its own specific treatment in symbols; and the simple consideration of putting iron cores into the coils, when treated mathematically, introduces such complex expressions as to yield little hope of a satisfactory general solution except by the free use of empirical "constants" which require to be determined by experiment in each machine.

The theory of the dynamo, then, which will be developed in the present work, will not be a general mathematical theory. The aim will be to deal with physical and experimental rather than mathematical ideas, though of necessity mathematical symbols must be used here as in every kind of engineering work. A physical theory of the dynamo is not new, though none of any great completeness has yet been given,* most of such explanations being devoted to single machines of some particular type.

There are, in fact, three distinct methods of dealing with the principles of the dynamo: (1) a physical method, dealing with the lines of magnetic force and lines of current in which these quantities are made, without further inquiry into their why or how, the basis of the arguments; (2) an algebraical

* See J. M. Gaugain, *Annales de Chimie et de Physique*, 1873; Antoine Breguet, *Annales de Chimie et de Physique*, 1879; Du Moncel, *Exposé des Applications de l'Électricité*, vol. ii.; Niaudet, *Machines Électriques*; Dredge's *Electric Illumination*; Schellen, *Die Magneto- und Dynamo-elektrischen Maschinen* (3rd edition, 1883); Cunynghame, *The Law of Electric Lighting*, 1883.

method, founded upon the mathematical laws of electric induction and of theoretical mechanics ; and (3) a graphical method, based upon the possibility of representing the action of a dynamo by a so-called "characteristic" curve, in the manner originally devised by Dr. Hopkinson, and subsequently developed by Frölich, Deprez, and others.

These three methods are really three aspects of the theory. The number of lines of magnetic force, with which we deal in the next chapter, may be expressed by a certain length of line geometrically, or by the symbol N algebraically, or they may be represented optically by a mere pictorial demonstration. What some people write N for, other people indicate by drawing a line of a certain length in a certain direction. We approximate, in fact, toward the true theory by various processes : sometimes by algebra ; sometimes by geometry ; sometimes by diagrams ; and each of these processes is of value in its turn.

It will be our aim first to develop a general physical theory, applicable to all the varied types of dynamo-electric machines, and to trace it out into a number of corollaries bearing upon the construction of such machines. Having recited these consequences, which we shall deduce from theory, it will then remain to see how they are verified and embodied in the various forms assumed by the dynamo in practice. After that come chapters on the algebraic and geometrical methods of treating the subject. The last section of the book deals with the dynamo in its functions as a mechanical motor.

CHAPTER II.

PHYSICAL THEORY OF DYNAMO-ELECTRIC MACHINES.

ALL dynamos are based upon the discovery made by Faraday in 1831, that electric currents are generated in conductors by moving them in a magnetic field. Faraday's principle may be enunciated as follows:—When a conductor is moved in a field of magnetic force in any way so as to cut the lines of force, there is an electromotive-force produced in the conductor, in a direction at right angles to the direction of the motion, and at right angles also to the direction of the lines of force, and to the right of the lines of force, as viewed from the point from which the motion originates.*

This induced electromotive-force is, as Faraday showed, proportional to the number of lines of magnetic force cut per second; and is, therefore, proportional to the intensity of the magnetic "field," and to the length and velocity of the moving conductor. For steady currents, the flow of electricity in the conductor is, by Ohm's well-known law, directly proportional to this electromotive-force, and inversely proportional to the resistance of the conductor. For sudden currents, or currents whose strength is varying rapidly, this is no longer true. And it is one of the most important matters, though one too often overlooked in the construction of dynamo-electric machinery, that the "resistance" of a coil of wire, or of a circuit, is by no means the only obstacle offered to the generation of a momen-

* A more usual rule for remembering the direction of the induced currents is the following adaptation from Ampère's well-known rule:—Supposing a figure swimming in any conductor to turn so as to look along the (positive direction of the) lines of force. Then, if he and the conductor be moved towards his right hand, he will be swimming with the current induced by this motion.

tary current in that coil or circuit ; but that, on the contrary, the "self-induction" exercised by one part of a coil or circuit upon another part or parts of the same, is a consideration, in many cases quite as important as, and in some cases more important than, the resistance.

To understand clearly Faraday's principle—that is to say how it is that the act of moving a wire so as to cut magnetic lines of force can generate a current of electricity in that wire—let us inquire what a current of electricity is.

A wire through which a current of electricity is flowing looks in no way different from any other wire. No man has ever yet seen the electricity running along in a wire, or knows precisely what is happening there. Indeed, it is still a disputed point which way the electricity flows, or whether or not there are two currents flowing simultaneously in opposite directions. Until we know with absolute certainty what electricity is, we cannot expect to know precisely what a current of electricity is. But no electrician is in any doubt as to one most vital matter, namely, that when an electric current

flows through a wire, the magnetic forces with which that wire is thereby, for the time, endowed, reside not in the wire at all, but in the space surrounding it. Every one knows that the space or "field" surrounding a magnet is full of magnetic "lines of force," and that these lines run in tufts (Fig. 5*) from

FIG. 5.*

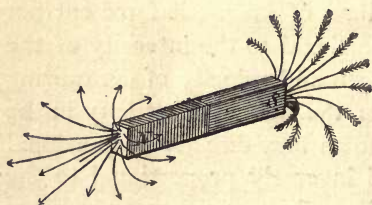

LINES OF FORCE OF BAR-MAGNET.

the N-pointing pole to the S-pointing pole of the magnet, invisible until, by dusting iron filings into the field, their presence is made known, though they are always in reality there (Fig. 6). A view of the magnetic field at the pole of a

* For the use of Figs. 5, 6, 7, 8, and 9, I am indebted to the kind courtesy of the editors and publishers of *Engineering*, who permit me to reproduce them from the volume, *Electric Illumination*, recently issued under the editorship of Mr. James Dredge, C.E.

bar-magnet, as seen end-on, would of course exhibit merely radial lines, as in Fig. 7.

FIG. 6.

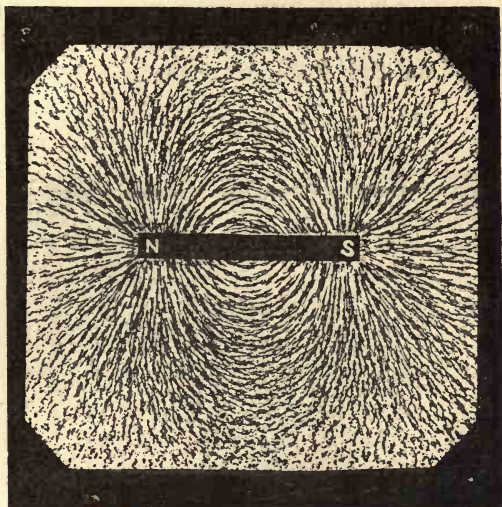

MAGNETIC FIELD OF BAR-MAGNET.

FIG. 7.

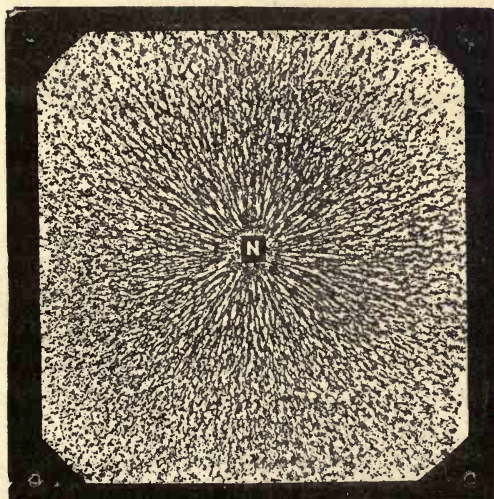

MAGNETIC FIELD ROUND ONE POLE, END-ON.

Now, every electric current (so-called) is surrounded by a magnetic field, the lines of which can be similarly revealed. To observe them, a hole is bored through a card or a piece of glass, and the wire which carries the current must be passed up through the hole. When iron filings are dusted into the field they assume the form of concentric circles (Fig. 8)

FIG. 8.

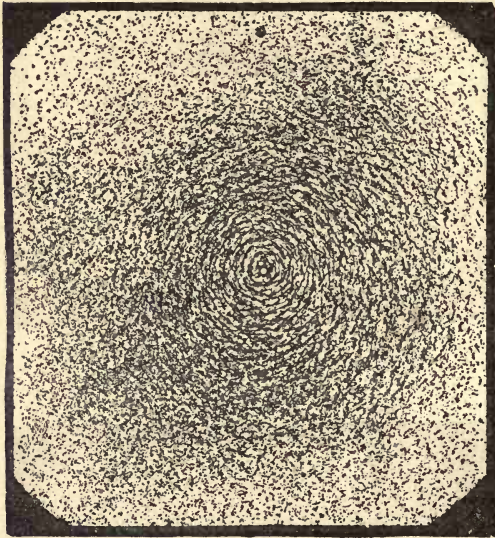

MAGNETIC FIELD SURROUNDING CURRENT. THE CONDUCTING WIRE
SEEN END-ON.

showing that the lines of force run completely round the wire, and do not stand out in tufts. In fact, every conducting wire is surrounded by a sort of magnetic whirl, like that shown in Fig. 9. A great part of the energy of the so-called electric current in the wire consists in these external magnetic whirls. To set them up requires an expenditure of energy; and to maintain them requires also a constant expenditure of energy. It is these magnetic whirls which act on magnets, and cause

them to set, as galvanometer needles do, at right angles to the conducting wire.

Now, Faraday's principle is nothing more or less than this:—That by moving a wire near a magnet, across a space in which there are magnetic lines, the motion of the wire, as it cuts across those magnetic lines, sets up magnetic whirls round the moving wire, or, in other language, generates a so-called current of electricity in that wire. Poking a magnet-pole into a loop or circuit of wire also necessarily generates a momentary current in the wire loop, because it momentarily sets up magnetic whirls. In Faraday's language, this action increases the number of magnetic lines of force intercepted by the circuit.

It is, however, necessary that the moving conductor should, in its motion, so cut the lines of force as to alter the number of lines of force that pass through the circuit of which the moving conductor forms part. If a conducting circuit—a wire ring or single coil, for example—be moved along in a uniform magnetic field, as indicated in Fig. 10, so that only the same lines of force pass through it, no current will be generated. Or, if again, as in Fig. 11, the coil be moved by a motion of translation to another part of the uniform field, as many lines of force will be left behind as are gained in advancing from its first to its second position, and there will be no current generated in the coil. If the coil be merely rotated on itself round a central axis, like the rim of a fly-wheel, it will not cut any more lines of force than before, and this motion will generate no current. But if, as in Fig. 12, the coil be tilted in its motion across the uniform field, or rotated round any axis in its own plane, then the number of lines of force that traverse it will be altered, and currents will

FIG. 9.



MAGNETIC WHIRL
SURROUNDING
WIRE CARRYING
CURRENT.

be generated. These currents will flow round the ring coil in the positive* sense (as viewed from the point toward which the lines of force run), if the effect of the movement is to diminish

FIG. 10.

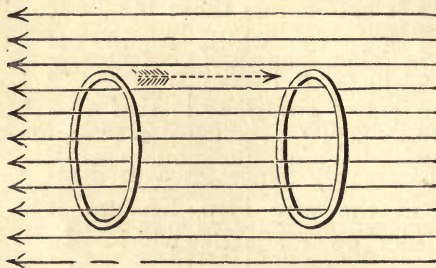

CIRCUIT MOVED WITHOUT CUTTING LINES OF FORCE OF UNIFORM MAGNETIC FIELD.

the number of lines of force that cross the coil ; they will flow round in the opposite sense, if the effect of the movement is to increase the number of intercepted lines of force.

FIG. 11.

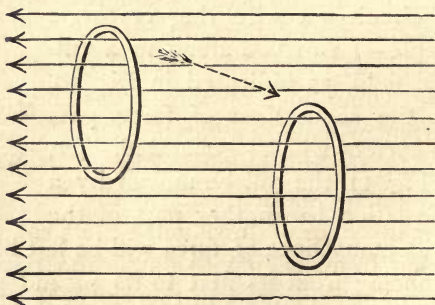

CIRCUIT MOVED WITHOUT CUTTING ANY MORE LINES OF FORCE.

If the field of force be not a uniform one, then the effect of taking the coil by a simple motion of translation from a place where the lines of force are dense to a place where they are

* The positive sense of motion round a circle is that opposite to the sense in which the hands of a clock go round.

less dense, as from position 1 to position 2 in Fig. 13, will be to generate currents. Or, if the motion be to a place where

FIG. 12.

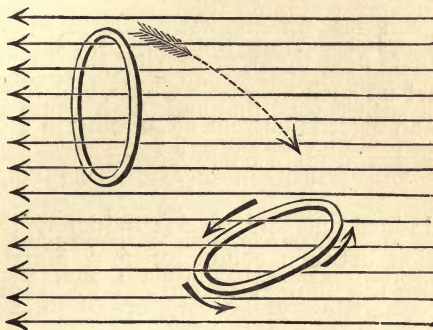

CIRCUIT MOVED SO AS TO ALTER NUMBER OF LINES OF FORCE THROUGH IT.

the lines of force run in the reverse direction, the effect will be the same, but even more powerful.

FIG. 13.

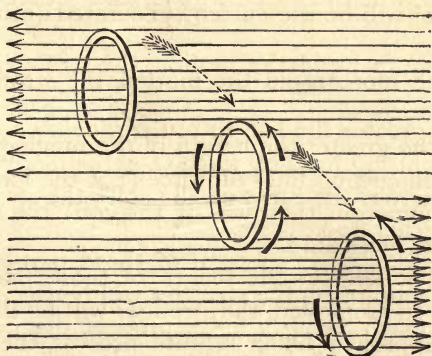

MOTION OF CIRCUIT IN NON-UNIFORM MAGNETIC FIELD.

We may now summarise the points under consideration and some of their immediate consequences, in the following manner:—

- (1.) A part, at least, of the energy of an electric current

exists in the form of magnetic whirls in the space surrounding the conductor.

(2.) Currents can be generated in conductors by setting up magnetic whirls round them.

(3.) We can set up magnetic whirls in conductors by moving magnets near them, or moving them near magnets.

(4.) To set up such magnetic whirls, and to maintain them by means of an electric current circulating in a coil, requires a continuous expenditure of energy, or, in other words, consumes power.

(5.) To induce currents in a conductor, there must be relative motion between conductor and magnet, of such a kind as to alter the number of lines of force embraced in the circuit.

(6.) Increase in the number of lines of force embraced by the circuit produces a current in the opposite sense to decrease.

(7.) Approach induces an electromotive-force in the opposite direction to that induced by recession.

(8.) The more powerful the magnet-pole or magnetic field the stronger will be the current generated (other things being equal).

(9.) The more rapid the motion, the stronger will be the currents.

(10.) The greater the length of the moving conductor thus employed in cutting lines of force (*i. e.* the longer the bars, or the more numerous the turns of the coil), the stronger will be the currents generated.

(11.) The shorter the length of those parts of the conductor not so employed, the stronger will be the current.

(12.) Approach being a finite process, the method of approach and recession (of a coil towards and from a magnet pole) must necessarily yield currents alternating in direction.

(13.) By using a suitable commutator, all the currents, direct or inverse, produced during recession or approach, can be turned into the same direction in the wire that goes to supply currents to the external circuits, thereby yielding an almost uniform current.

(14.) In a circuit where the flow of currents is steady* it makes no difference what kind of magnets are used to procure the requisite magnetic field, whether permanent steel magnets or electro-magnets, self-excited or otherwise.

(15.) Hence the current of the generator may be itself utilised to excite the magnetism of the field magnets, by being caused, wholly or partially, to flow round the field-magnet coils.

A very large number of dynamo-electric machines have been constructed upon the foregoing principles. The variety is indeed so great, that classification is not altogether easy. Some have attempted to classify dynamos according to certain constructional points, such as whether the machine did or did not contain iron in its moving parts (which is a mere accident of manufacture, since almost all dynamos will work, though not equally well, either with or without iron in their armatures); or whether the currents generated were direct and continuous, or alternating (which is in many cases a mere question of arrangement of parts of the commutator or collectors); or what was the form of the rotating armature (which is, again, a matter of choice in construction, rather than of fundamental principle). The classification which I shall adopt, is one which I have found more satisfactory and fundamental than any other. I distinguish three genera or main classes of dynamos.

Class I.—Dynamos in which there is rotation of a coil or coils in a uniform † field of force, such rotation being effected (as in the manner indicated in Fig. 12, p. 13), round an axis in the plane of the coil, or one parallel to such an axis.

* For currents that are not steady, there are other considerations to be taken into account, as will be shown hereafter.

† Or approximately uniform. A Gramme ring, or a Siemens drum armature, will work in a by no means uniform field, but is adapted to work in a field in which the lines of force run uniformly from one side to the other. But in such a field, a multipolar armature of many coils, such as that of Wilde, or such as is used in the Gramme alternate-current, or in the Siemens alternate-current machine, is useless and out of place. Indeed, the classification almost amounts to saying that in machines of Class I. there is one field of force, while in machines of Class II. there are many fields of force, or the whole field of force is complex.

EXAMPLES.—Gramme, Siemens (Alteneck), Edison, Lontin, Bürgin, Fein, Schuckert, Brush, Thomson-Houston, Crompton, &c.

Class II.—Dynamos in which there is translation* of coils to different parts of a complex field of varying strength, or of opposite sign. Most, but by no means all, of the machines of this class furnish alternate currents.

EXAMPLES.—Pixii, Clarke, Holmes, Niaudet, Wallace-Farmer, Wilde (alternate), Siemens (alternate), Hopkinson and Muirhead, Thomson-Ferranti (alternate), Gordon (alternate), Mechwart-Zipernowsky (alternate), Siemens-Alteneck (Disk Dynamo), Ayrton and Perry (Oblique-coiled Dynamo), Edison (Disk Dynamo), Thomson (Wheel-Dynamo), De Meritens.

Class III.—Dynamos having a conductor rotating so as to produce a continuous increase in the number of lines of force, cut, by the device of sliding one part of the conductor on or round the magnet, or on some other part of the circuit.

EXAMPLES.—Faraday's Disk-machine, Siemens' "unipolar" Dynamo, Forbes' "non-polar" Dynamo.

There are a few nondescript machines, however, which do not fall exactly within any of these classes; † one of these is the extraordinary tentative dynamo of Edison, in which the coils are waved to-and-fro at the ends of a gigantic tuning-fork, instead of being rotated on a spindle.

* The motion by which the individual coils are carried round on such armatures as those of Niaudet, Wallace-Farmer, Siemens (alternate), &c., is, of course, not a pure translation. It may be regarded, however, as a combination of a motion of translation of the coil round the circumference of a circle, with a rotation of the coil round its own axis, which, as we have seen above, has *no* electrical effect. It is, of course, the translation of the coil to different parts of the field which is the effective motion.

† There are a few dynamos, including the Elphinstone-Vincent, the four-pole Schuckert, and the four-pole Gülcher, which, though really belonging to the first class, are not named above, because they are, in reality, multiple machines. The Gülcher with its double field-magnets and four collecting brushes, is really a double machine, though it has but one rotating ring. The same is the case with an octagonal-pattern Gramme which has four brushes. The Schuckert-Mordey, or "Victoria" dynamo, though it has only two brushes, belongs to the same category. The Elphinstone-Vincent machine, a remarkable one in many respects, is a triple machine, having six brushes, or, in the newest machines, two brushes only; and may, indeed, be used as three machines, to feed three separate circuits.

Suppose, then, it were determined to construct a dynamo upon any one of these plans—say the first—a very slight acquaintance with Faraday's principle and its corollaries would suggest that, to obtain powerful electric currents, the machine must be constructed upon the following guiding lines:—

(a.) The field magnets should be as strong as possible, and their poles as near together as possible.

(b.) The armature should have the greatest possible length of wire upon its coils.

(c.) The wire of the armature coils should be as thick as possible, so as to offer little resistance.

(d.) A very powerful steam-engine should be used to turn the armature, because,

(e.) The speed of rotation should be as great as possible.

Unfortunately, it is impossible to realise all these conditions at once, as they are incompatible with one another; and, moreover, there are a great many additional conditions to be observed in the construction of a successful dynamo. We will deal with the various matters in order, beginning with the speed of the machine.

Relation of Speed to Power.

Theory shows that, if the intensity of the magnetic field be constant, the electromotive-force should be proportional to the speed of the machine. Numerous experiments, by many different workers, have shown that this is true, within certain limits, for those machines in which the field magnets are independent of the main circuit; that is to say, for magneto and separately-excited dynamos. It is not, however, quite exact, unless the resistance of the circuit be increased proportionately to the speed,* because the current in the coils itself reacts on the magnetic field, and alters the distribution of the magnetism. The consequence of this reaction is that,

* If this precaution be observed, the rule holds good also for series dynamos; but not for shunt dynamos. If, in the latter case, however, the resistance of the shunt coil be also proportionately increased, the rule still holds approximately.

firstly, the position of the "diameter of commutation" is altered; and, secondly, the effective number of lines of force is reduced. So that, with a constant resistance in circuit, the electromotive-force, and therefore the current, are slightly less at high speeds than the proportion of the velocities would lead one to expect. Moreover, the retarding action due to self-induction in the separate sections of the armature increases with the speed, and consequently the resistance of the armature is *apparently* higher at high speeds, than at low ones (see the curves in Chapter XX.). Since the product of current into electromotive-force gives a number proportional to the electric work of the machine, it follows that, for "independently-excited" machines, the electric work done in a given time in a circuit of given resistance, is nearly proportional to the square of the speed, and the work drawn from the steam-engine will be similarly proportional to the square of the speed.

In self-exciting machines, whether "series," "shunt," or "compound" in their arrangements, a wholly different law obtains. If the iron of the field magnets be not magnetised nearly to saturation, then, since the increase of current consequent on increase of speed produces a nearly proportional increase in the strength of the magnetic field, this increase will react on the electromotive-force, and cause it to be proportional more nearly to the square of the velocity, which again will cause the current to increase in like proportion. But since the magnetisation of the iron is, even when far from saturation point, not exactly proportional to the magnetising force, but something less, it is in practice found that the electric work of the machine is not proportional to the fourth power of the speed, is not even proportional to the third power of the speed, but to something slightly less than the latter.

As mechanical considerations forbid too high a velocity in the moving parts, it is clear that, if there be a limiting speed at which it is safe to run any given armature, the greatest amount of work will be done at that speed by using the most powerful magnets possible—electro-magnets rather than magnets of steel.

Moreover, it is absolutely essential for many purposes that the dynamo shall produce and maintain the currents at a constant "potential" (or as some people term it "pressure"), so that the lamps, whether many or few are in circuit, shall be of one constant degree of brightness. To this end various self-regulating devices have been suggested, the most satisfactory of which for most purposes is the "compound-wound" dynamo, of which much is said further on in this work.

In all the self-regulating methods based upon the winding of the coils, everything depends, however, upon the condition that the driving speed shall be uniform. For all the best kind of electric work, a gas-engine is wholly out of the question as a source of power, because of its extreme inequalities in speed. Even with the best steam-engines, a specially sensitive valve is required; and probably such valves will, in the future, be operated electrically by self-acting electro-magnetic gearing. In any case, where the driving is at all liable to be uneven, the obvious and simple precaution should be taken of placing a heavy fly-wheel on the axle of the dynamo. It is, indeed, singular that this is not more generally done.

Other methods of securing automatic regulation without the employment of a compound winding, and which do not all depend on the maintenance of a uniform speed, are described in Chapter VI. and in Appendix X.



CHAPTER III.

ORGANS OF DYNAMO-ELECTRIC MACHINES.

To make more clear the considerations which will occupy us when discussing individual types of dynamo, we will next examine some fundamental points in the general mechanism and design of dynamo machines; and in particular those of Class I., which includes the great majority of the actual machines in use. This will lead directly to a closer scrutiny of the construction and design of the various organs composing the dynamo and essential to its action.

Ideal Simple Dynamo.

The simplest conceivable dynamo is that sketched in Fig. 14, consisting of a single rectangular loop of wire rotating in a

FIG. 14.

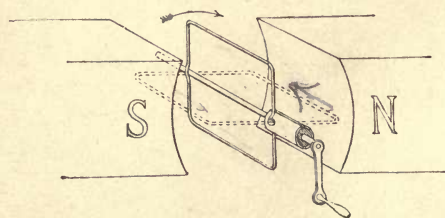

IDEAL SIMPLE DYNAMO.

simple and uniform magnetic field between the poles of a large magnet. If the loop be placed at first in the vertical plane, the number of lines that pass through it from right to left will be a maximum, and as it is turned into the horizontal position the number diminishes to zero; but on continuing the rotation

the lines begin again to thread through the loop from the opposite side, so that there is a negative maximum when the loop has been turned through 180° . During the half-revolution, therefore, currents will have been induced in the loop, and these currents will be in the direction from back to front in the part of the loop which is rising on the left, and in the opposite direction, namely from front to back, in that part which is descending on the right. On passing the 180° position, there will begin an induction in the reverse sense, for now the number of negative lines of force is diminishing, which is equivalent to a positive increase in the number of lines of force; and this increase would go on until the loop reached its original position, having made one complete turn. To commute these alternately-directed currents into one direction in the external circuit, there must be applied a commutator consisting of a metal tube slit into two parts, and mounted on a cylinder of hard wood or other suitable insulating material; each half being connected to one end of the loop, as indicated in Fig. 14. Against this commutator press a couple of metallic springs or "brushes" (Fig. 15), which lead away the currents to the main circuit. It is obvious that if the brushes are so set that the one part of the split tube slides out of contact, and the other part slides into contact with the brush, at the moment when the loop passes through the positions when the induction reverses itself, the alternate currents induced in the loop will be "commuted" into one direction through the circuit. We should expect therefore the brushes to be set so that the commutation shall take place exactly as the loop passes through the vertical position. In practice, however, it is found that a slight forward lead must be given to the brushes, for reasons which will presently appear. In Fig. 16 are shown the brushes B B', displaced so as to touch the commutator not exactly at the highest and lowest points, but at points displaced in the direction of the line D D, which is called the "diameter of commutation." The argument is in nowise

FIG. 15.



TWO-PART COMMUTATOR OR COLLECTOR.

changed if for the single ideal loop we substitute the simple rectangular coil represented in Fig. 17, consisting of many turns of wire, in each of which a simultaneous inductive action

FIG. 16.

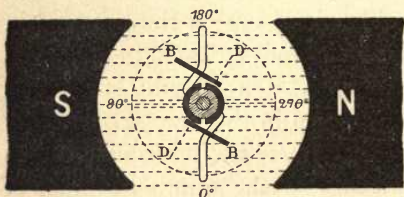

SIMPLE LOOP IN SIMPLE FIELD.

FIG. 17.

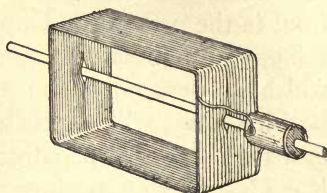

SIMPLE RECTANGULAR COIL.

is going on, making the total induced electromotive-force proportionally greater. This form, with the addition of an iron core is, indeed, the form given to armatures in 1856 by Siemens, whose shuttle-wound ar-

FIG. 18.

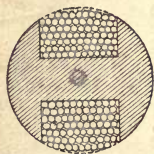

SECTION OF OLD SHUTTLE-WOUND SIEMENS ARMATURE.

mature is represented in section in Fig. 18. A small magneto-electric machine of the old pattern having the shuttle-wound armature is shown in Fig. 19. Though this form has now for many years been abandoned, save for small motors and similar work, it gave a great impetus to the

FIG. 19.

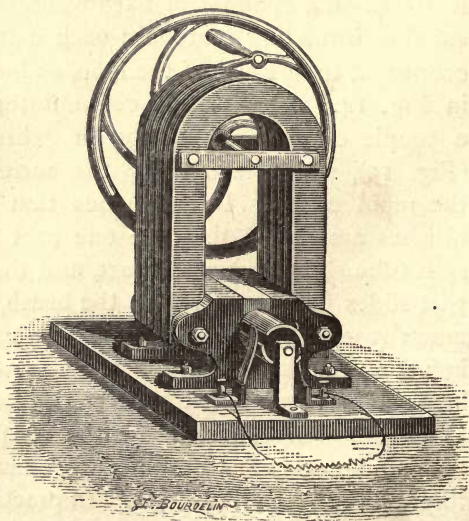

OLD SIEMENS MACHINE, WITH SHUTTLE-WOUND ARMATURE AND PERMANENT MAGNETS.

Though this form has now for many years been abandoned, save for small motors and similar work, it gave a great impetus to the

machines of its day ; but for all large work it has been entirely superseded by the ring armatures and drum armatures next to be described.

Armatures.

Returning to the ideal simple loop we may exhibit it in its relation to the 2-part commutator somewhat more clearly by referring to Fig. 20. The same split-tube or 2-part commutator will suffice if a loop of two or more turns be substituted, as shown in Fig. 21, for the single turn.

But we may substitute also for the one loop a small coil consisting of several turns wound upon an iron ring. This coil (Fig. 22), which may be considered as one section of a

FIG. 20.

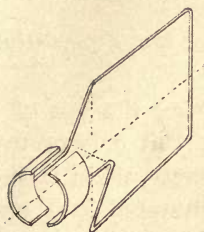

FIG. 21.

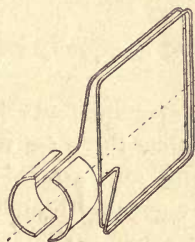
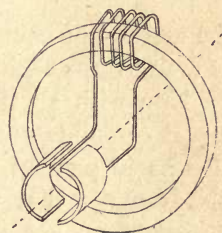

FIG. 22.

SIMPLE LOOP ARMA-
TURE.LOOP ARMATURE OF
TWO TURNS.SIMPLE RING ARMATURE
WITH ONE COIL.

Pacincti or Gramme ring, will have lines of force induced through it as the loop had. In the position drawn, it occupies the highest point of its path and the induction of lines of force through it will be a maximum. As it turns, the number of lines of force threaded through it will diminish, and become zero when it is at 90° from its original position. But a little consideration of its action will suffice to show that if another coil be placed at the opposite side of the ring it will be undergoing exactly similar inductive action at the same moment, and may therefore be connected to the same commutator. If these two coils are united in parallel arc, as shown in Fig. 23, the joint electromotive-force will be the same as that due to either separately ; but the resistance offered to the current by the two jointly is half that of either. It is evident that

we may connect two parallel loops in a similar fashion to one simple 2-part collector. If the two loops are of one turn each, we shall have the arrangement sketched in Fig. 24; but

FIG. 23.

SIMPLE RING ARMATURE WITH
TWO COILS IN PARALLEL.

FIG. 24.

SIMPLE LOOP ARMATURE WITH
TWO COILS IN PARALLEL.

the method of connecting is equally good for loops consisting of many turns each.

Now with all these arrangements involving the use of a 2-part commutator, whether there be one circuit only or two circuits in parallel in the coils attached thereto, there is the disadvantage that the currents, though commuted into one direction, are not absolutely continuous. In any single coil without a commutator, there would be generated in successive revolutions, currents whose variations might, if the coil were destitute of self-induction, be graphically expressed by a recurring sinusoidal curve, such as Fig. 25. But if by

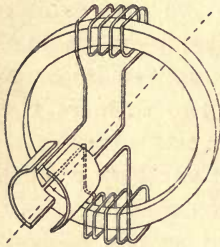
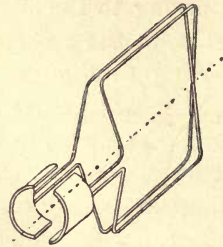
FIG. 25.



the addition of a simple split-tube commutator the alternate halves of these currents are reversed, so as to rectify their direction through the rest of the circuit, the resultant currents will not be continuous, but will be of one sign only, as shown in Fig. 26, there being two currents generated during each revolution of the coil. The currents are now "rectified," or "redressed" as our Continental neighbours say, but are

not continuous. To give *continuity* to the currents, we must advance from the simple 2-part commutator to a form having a larger number of parts, and employ therewith a

FIG. 26.



larger number of coils. The coils must also be so arranged that one set comes into action while the other is going out of action. Accordingly if we fix upon our iron ring two sets of coils at right angles to each other's planes, as in Fig. 27, so that one comes into the position of best action, while the other is in the position of least action (one being parallel to the lines of force when the other is normal to them), and their actions be superposed, the result will be, as shown in Fig. 28, to give a current which is continuous, but not steady, having four slight undulations per revolution. If any larger number of separate coils are used, and their effects, occurring at regular intervals, be superposed, a similar curve will be obtained, but with summits proportionately more numerous and less elevated. When the number of

FIG. 27.

FOUR-PART RING
ARMATURE (CLOSED-COIL).

FIG. 28.



coils used is very great, and the overlappings of the curves are still more complete, the row of summits will form practically a straight line, or the whole current will be practically constant. As arranged in Fig. 27, the four coils are all united together in a *closed* circuit, the end of the

first being united to the beginning of the second, and so forth all round, the last section closing in to the first. For perfect uniformity of effect the coils on the armature ought to be divided into a very large number of sections (see calculations, Chap. XII.), which come in regular succession into the position of maximum induction at regular intervals one after the other. In Fig. 29 a sketch is given of a drum armature wound with two pairs of coils at right angles one to the other, and connected to a 4-part collector.

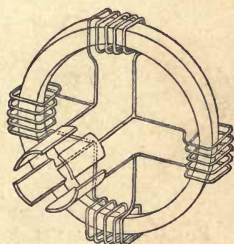
FIG. 29.

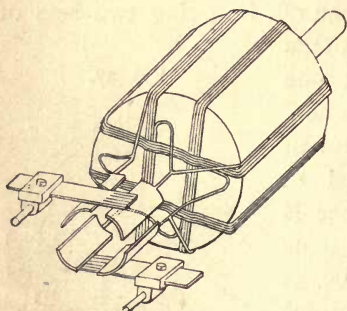

FOUR-PART DRUM ARMATURE
(CLOSED-COIL).

the other, and connected to a 4-part collector. A little examination of Figs. 27 and 29 will show that each section of the coils is connected to the next in order to it; the whole of the windings constituting therefore a single closed coil. Also, the end of one section and the beginning of the next are both connected with a segment of the collector. In practice, the collector segments are not mere slices of metal tubing, but are built up

of a number of parallel bars of copper, gun-metal, or phosphor-bronze, such as may be seen in Fig. 125, p. 155, placed round the periphery of a cylinder of some insulating substance. It will also be noticed that, owing to the fact that there is a continuous circuit all round, there are two ways in which the current may flow through the armature from one brush to the other, as in all the ring and drum armatures; of which, indeed, Figs. 27 and 29 may be taken as simplified instances. The same reasoning now applied to 4-part armatures holds good for those having a still larger number of parts, such as is shown in Fig. 30. Of these more will be said in the subsequent chapters. Let it suffice to say here that in all closed-coil armatures, whether of the "ring" or the "drum" type, there must be just as many segments to the collector or

commutator as there are sections in the coils of the armature. The special case of *open-coil armatures* is considered in Chapter X., p. 175. In these machines the separate coils are not connected up together in series, and a special commutator is used instead of the usual collector.

As already explained, the "brushes" press against the commutator or collector, being usually held in position by a

FIG. 30.

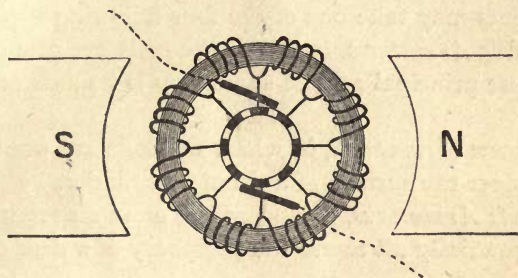

SIMPLE RING ARMATURE SHOWING CONNEXIONS OF CLOSED COIL.

spring. As the collector rotates, each of the bars passes successively under the brush, and makes contact with it. At one side—that towards which the two currents in the armature are flowing—the current flows from the collector-bar into the brush. At the other side the return current flows from the negative brush into the collector-bar in contact with it, and thence divides into two parts in the two circuits of the armature. If the brushes press strongly against the collector-bars, then when one collector-bar is leaving and the next coming up into contact with the brush, there will be contact made for a moment with two adjacent bars; and the coil, or section, whose two ends are united to these two bars, will, for an instant, be short-circuited. The effect of this will be considered in dealing with the reactions in armatures at a later stage.

So far, the only types of armature considered have been

the "drum" type, and the "ring" type; but these are not the only possible cases. The object of all such combinations of coils is to obtain the practical continuity and equability of current explained above. To attain this end it is needful that some of the individual coils should be moving through the position of maximum action, whilst others are passing through the neutral point, and are temporarily idle. Hence, a symmetrical arrangement of the individual coils or groups of coils around an axis is needed; and such symmetrical arrangements may take one of the four following types:—

(1.) *Ring Armatures*, in which the coils are grouped upon a ring whose principal axis of symmetry is its axis of rotation also.

(2.) *Drum Armatures*, in which the coils are wound longitudinally over the surface of a drum or cylinder.

(3.) *Pole Armatures*, having coils wound on separate poles projecting radially all round the periphery of a disk or central hub.

(4.) *Disk Armatures*, in which the coils are flattened against a disk. These armatures are appropriate to dynamos of Class II.

Ring armatures are adopted in practice in the dynamos of Pacinotti, Gramme, Schuckert, Gülcher, Fein, Heinrichs, De Meritens, Brush, Jürgensen, and others. Drum armatures are found in the Siemens (Alteneck), Edison, Elphinstone-Vincent, Weston, and other machines. Pole armatures are used in the dynamos of Allan, Elmore, and of Lontin. There are several intermediate forms. The Bürgin armature consists of eight or ten rings, side by side, so as to form a drum. The Lontin (continuous-current dynamo) has the radial poles affixed upon the surface of a cylinder. The Maxim armature is a hollow elongated drum wound like a Gramme ring, and a similar construction is used in several excellent recent machines by Crompton, Cabella, Gramme, Paterson and Cooper, Kapp, and Mather and Hopkinson. One early form of the Weston armature has the drum surface cut up into longitudinal poles; there is a similar armature by Jablochhoff, in which the poles are oblique.

Ring armatures are found in many machines, but the ingenuity of inventors has been exercised chiefly in three directions:—The securing of practical continuity; the avoidance of eddy currents in the cores; and the reduction of useless resistance. In the greater part of these machines, the armatures are constructed with closed-coils: but there is no reason why open-coil armatures should not be constructed in the ring form, as indeed is the case with the well-known Brush dynamo (p. 180). Most inventors have been content to secure approximate continuity by making the number of sections numerous. One inventor, Professor Perry, has built up a ring with coils wound obliquely so that the one coil reaches the neutral point before the preceding one has passed it. I cannot help doubting the advantage of this arrangement; which, moreover, presents mechanical difficulties in construction. Pacinotti's early dynamo had the coils wound between projecting teeth upon an iron ring. Gramme rejected these cogs, preferring that the coils should be wound round the entire surface of the endless core. To prevent wasteful currents in the cores, Gramme employed for that portion a coil of varnished iron wire of many turns. In Gülcher's dynamo, the ring core is made up of thin flat rings cut out of sheet iron, furnished with projecting cogs, and laid upon one another. In the Schuckert-Mordey (Victoria) dynamo the core is built of hoops. The parts of the coils which pass through the interior of the ring (in spite of the late M. Antoine Breguet's ingenious proof that some of the lines of force of the field turned back into the core in this interior region) cut very few lines of force as they rotate, and therefore offer a certain amount of wasteful resistance. But this resistance in well-designed machines is insignificant compared with that of the external circuit, and the disadvantage is largely imaginary. Inventors have essayed to amend this, by either fitting projecting flanges to the pole-pieces (Fein and Heinrichs), or by using internal magnets (Jürgensen), or else by flattening the ring into a disk form, so as to reduce the interior parts of the ring coils into an insignificant amount (Schuckert and Gülcher.) Indeed the flat-ring arma-

tures may be said to present a distinct type from those in which the ring tends to the cylindrical form.

“ Pole ” armatures, having the coils wound upon radially projecting poles have been devised by Allan, Lontin, and Weston. They are also used by Gramme in some forms of alternate-current machine (Figs. 157 and 158), and in the large Mechwart-Zipernowsky dynamo shown in 1883 at Vienna. The principle of Lontin's machine, in which the coils are connected like the sections of a Pacinotti or Gramme ring, is indicated in Fig. 31. Here the diameter of commutation

FIG. 31.

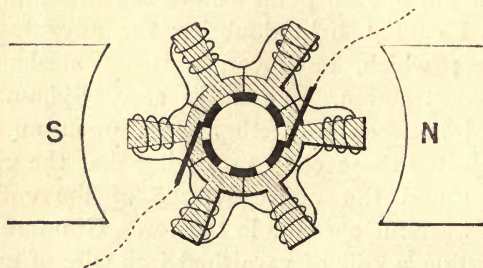

SIMPLE POLE ARMATURE SHOWING CONNEXIONS.

is parallel to the polar diameter, because the number of lines of force in this case is a maximum in the coils that are on the right and left positions. This armature is structurally a difficult one, because it is not mechanically strong unless the cores are solid; and solid cores are electrically bad owing to their heating. It is impracticable, too, in this form to have very many sections, and the coils act, by reason of their position, prejudicially on one another. This form of armature is practically obsolete.

Armature Cores.

(a.) Theory dictates that if iron is employed in armatures, it must be slit or laminated, so as to prevent the generation of eddy currents. Such iron cores should be structurally

divided in planes normal to the circuits round which electro-motive-force is induced; or should be divided in planes parallel to the lines of force and to the direction of the motion. Thus, drum-armature cores should be built of disks of thin sheet iron. Ring armatures, if of the cylindrical or elongated type, should have cores made up of rings stamped out of sheet iron and clamped together side by side; but if of the flat-ring type they should be built of concentric hoops. Cores built up of varnished iron wire, or of thin disks of sheet iron separated by varnish, asbestos paper, or mica, partially realise the required condition. The magnetic discontinuity of wire cores is, however, to a certain extent disadvantageous: it is better that the iron should be without discontinuity in the direction in which it is to be magnetised. It should therefore be laminated into sheets, rather than subdivided into wires. Pole armatures, however, ought to have wire cores. For this reason they are structurally unsatisfactory. Cores of solid iron are quite inadmissible, as currents are generated in them and heat them. The Wallace-Farmer armature, in which the coils were mounted on a solid disk of iron, used to grow very hot. Cores of solid metal other than iron—for example, of gun-metal, or of phosphor-bronze—should on no account be used in any armature.

(b.) Armature cores should be so arranged that the direction of polarity of their magnetisation is never *abruptly* reversed during their rotation. If this precaution is neglected, the cores will be heated. This is a defect in armatures of Niaudet's type.

(c.) There ought to be so much iron in the armature that it is magnetised just up to the dia-critical degree of saturation (*vide* Note at end of Chap. XV.) when the dynamo is generating its maximum working current.

Armature Coils.

(d.) All needless resistance should be avoided in armature coils, as hurtful to the efficiency of the machine. The wires should therefore be as short and as thick as is consistent with

obtaining the requisite electromotive-force without requiring an undue speed of driving. In some dynamos in which the armature resistance must be kept as low as possible—as, for example, some of Siemens' dynamos as used for electro-plating—several wires separately wound have their ends united in parallel arc. It is easier to wind four wires side by side than to coil up one very thick and unbendable wire.

(*e.*) Theoretically, since the function of armature coils is to enclose magnetic lines of force, the best form ought to be that which with minimum length of wire gives maximum area—namely a circle. In the Thomson-Houston machine the armature is spherical, and the coils circular; and in some ring armatures, the section of the ring is circular. A drum armature whose longitudinal section is rectangular, ought to be as broad as long to preserve maximum area with minimum length of wire. Convenience of construction appears to dictate greater longitudinal dimensions.

(*f.*) The wire should be of the very best electric conductivity. The conductivity of good copper is so nearly equal to that of silver (over 96 per cent.) that it is not worth while to use silver wires in the armature coils of dynamos.

(*g.*) In cases where rods or strips of copper are used instead of mere wires, care must be taken to avoid eddy currents by laminating such conductors, or slitting them in planes parallel to the electromotive-force, that is to say, in planes perpendicular to the lines of force and to the direction of the rotation.*

(*h.*) We have seen that in order to obviate fluctuations in the current, the rotating armature coils must be divided into a large number of sections, each coming in regular succession into the position of best action. If these sections, or coils, are independent of each other, each coil, or diametral pair of coils must have its own commutator (as in the Brush machine). If they are not independent, but are wound on in continuous connexion all round the armature, a collector is needed

* It will be observed that the rule for eliminating the eddy current is different, in the three cases, for magnets and their pole-pieces, for moving iron armature cores, and for moving conductors in the armature.

consisting of parallel metallic bars as numerous as the sections, each bar communicating with the end of one section and the beginning of the next.

(*i.*) In any case, the connexions of such sections and of the commutators, or collectors, should be symmetrical round the axis; for, if not symmetrical, the induction will be unequal in the parts that successively occupy the same positions with respect to the field magnets, giving rise to inequalities in the electromotive-force, sparking at the commutator or collector, and other irregularities.

(*j.*) In the case where the coils are working in parallel, it has been considered advantageous to arrange the commutator to cut out the coil that is in the position of least action, as the circuit is thereby relieved of the resistance of an idle coil. But no such coil should be short-circuited to cut it out, otherwise the harmful effects of self-induction in the short-circuited part will soon make themselves apparent by heating.

(*k.*) In the case of pole armatures, the coils should be wound on the poles rather than on the middles of the projecting cores; since the variations in the induced magnetism are most effective at or near the poles. (See p. 41.)

(*l.*) Since it is impossible to reduce the resistance of the armature coils to zero, it is impossible to prevent heat being developed in those coils during their rotation; hence it is advisable that the coils should be wound with air spaces in some way between them, that they may be cooled by ventilation. In a well-ventilated armature a current-density of nearly 2500 ampères per square inch of the conductor may be attained.

(*m.*) The insulation of the armature coils should be ensured with particular care, and should be carried out as far as possible with mica and asbestos, or other materials not liable to be burned or melted if the armature coils become heated.

(*n.*) Care must be taken that the coils of armatures are so wound and held that they cannot fly out when rotating. Armatures have been known to become stripped of their

insulating covering, and even to fly to pieces for want of simple mechanical precautions.

(o.) Armatures ought to be very carefully balanced on their axles, otherwise when running at a high speed they will set up detrimental vibrations, and will tend to bend the axles. Great care should therefore be taken to secure symmetry in winding.

Some further considerations respecting the reactions between the armature and the field magnets are reserved for consideration until the rules for design of field magnets have been considered.

Field Magnets.

The coils of the field magnets of a dynamo cannot be constructed so as to offer no resistance. They inevitably waste some of the energy of the currents in the form of heat. It has, therefore, been argued that it cannot be economical to use electro-magnets instead of permanent magnets of steel, which have only to be magnetised once for all. Nevertheless, there are certain considerations which tell in favour of electro-magnets. For equal power, their prime cost is less than that of steel magnets, which, moreover, are not permanent, but require remagnetising at intervals. Moreover, as we have seen, from the fact that there is a limiting velocity at which it is safe to run a machine, it is important, in order not to have machines of needlessly great size, to use the most powerful field magnets possible. But if we do not get our magnetism for nothing, and find it more convenient to spend part of our current upon the electro-magnets, economy dictates that we should so construct them that their magnetism may cost us as little as possible. To magnetise a piece of iron requires the expenditure of energy; but when once it is magnetised, it requires no further expenditure of energy (save the slight loss by heating in the coils, which may be reduced by making the resistance of the coils as little as possible) to keep it so magnetised, provided the magnet is doing no work. Even if it be doing no work, if the current flowing round it be not

steady, there will be loss. If the magnet does work in attracting a piece of iron to it, then there is an immediate and corresponding call upon the strength of the current in the coils, to provide the needful energy. This point may be illustrated by the following experiment:—Let a current from a steady source (see Fig. 32) pass through an incandescent lamp, and

FIG. 32.

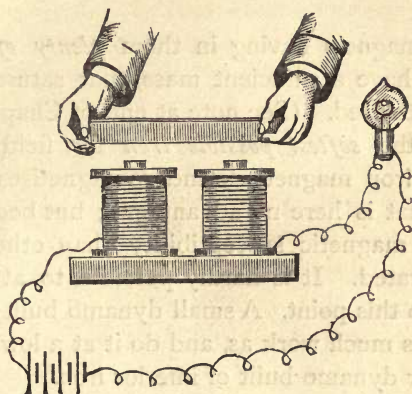

REACTION OF MOVING MASS OF IRON ON AN ELECTRO-MAGNET.

also through an electro-magnet, whose cores it magnetises. When once established, the current is perfectly steady, and none of its energy is wasted on the magnet (save the negligible trifle due to the resistance of the coils). But if now the magnet is allowed to do work in attracting an iron bar towards itself, the light of the lamp is seen momentarily to fade. When the iron bar is snatched away, the light exhibits a momentary increase; in each case resuming its original intensity when the motion ceases. Now, in a dynamo there are, in many cases, revolving parts containing iron, and it is of importance that the approach or recession of the iron parts should not produce such reactions as these in the magnetism of the magnet. Large, slow-acting field magnets are therefore advisable. The following points embody the conditions for attaining the end desired.

(*p.*) The body of the field magnets should be solid. Even in the iron itself, currents are induced, and circulate round and round, whenever the strength of the magnetism is altered. These self-induced currents tend to retard all changes in the degree of magnetisation. They are stronger in proportion to the square of the diameter of the magnet, if cylindrical, or to its area of cross-section. A *thick* magnet will, therefore, be a slow-acting one, and will steady the current induced in its field.

(*q.*) Use magnets having in them *plenty of iron*. It is important to have a sufficient mass, that saturation may not be too soon attained. (See note at end of Chapter XV.)

(*r.*) Use the *softest possible iron* for field magnets, not because soft iron magnetises and demagnetises quicker than other iron (that is here no advantage); but because soft iron has a higher magnetic susceptibility than other iron—is not so soon saturated. It is hardly possible to attach too great importance to this point. A small dynamo built of really good iron will do as much work as, and do it at a lower speed than, a much larger dynamo built of inferior iron.

(*s.*) Use *long* magnets. Again, the use of long magnets is to steady the magnetism, and therefore to steady the current. A long magnet takes a longer time than a short magnet to magnetise and demagnetise. It costs more than a short magnet it is true, and requires more copper wire in the exterior coils; but the copper wire may be made thicker in proportion, and will offer less resistance. There is of course a practical limit to length; for if a magnet is too long in proportion to its thickness, the lines of force induced by the coils, instead of all passing down the iron into the pole-pieces, leak away at the sides. According to Deprez the length should not be greater than three times the thickness.

(*t.*) Employ iron cores of such a cross-section, that there shall be as much iron as possible enclosed within the coils. The best cross-section might be expected to be circular; as this requires less wire. Many constructors, however, prefer slabs of iron of rectangular section, but rounded at the edges.

(*u.*) The magnetism so obtained should be utilised as

directly as possible ; therefore place the field magnets or their pole-pieces as close to the rotating armature as is compatible with safety in running.

(*v.*) Avoid edges and corners on the magnets and pole-pieces if you want a uniform field. The laws of distribution of the magnetic lines of force round a pole are strikingly akin to those of the distribution of electrification over a conductor. We avoid edges and points in the latter case, and ought to do in the former. If the field magnets or their pole-pieces have sharp edges, the field cannot be uniform, and some of the lines of force will run uselessly through the space outside the armature instead of going through it. Theoretically, the very best form to give externally to a magnet is that of the curves of the magnetic lines of force.

(*w.*) It is of great importance that the magnetising effect of the field magnets on the iron core of the armature should be much greater than the magnetising effect due to the current generated in the armature coils. If the latter is relatively powerful, there will be a great lead and much sparking at the brushes. The lead of the brushes, and its variation under different loads, can be reduced, and the tendency to spark can therefore be reduced, by making the field magnets very powerful in proportion to the armature.

(*x.*) Reinforce the magnetic field by placing iron, or better still electro-magnets, within the rotating armature. In most cases this is done by giving the armature coils iron cores which rotate with them ; in other cases, the iron cores or internal masses are stationary. In the former case there is loss by heating ; in the latter, there are structural difficulties to be overcome. Siemens has employed a stationary mass within his rotating drum armature. Internal electro-magnets, serving the function of concentrating the magnetism of the field, have been used by Lord Elphinstone and Mr. Vincent. A similar device obtains in Sir W. Thomson's "mousemill" dynamo, and in Jürgensen's dynamo.

(*y.*) In cases where a uniform magnetic field is not desired, but where, as in dynamos of the second class, the field must have varying intensity at different points, it may be advisable

specially to use field magnets with edges or points, so as to concentrate the field at certain regions.

(z.) It is of great importance that the iron should present no physical discontinuity in structure in the direction in which it is to be magnetised. The grain of the iron should lie in the direction of the lines of magnetic force that run through it. The maximum magnetic susceptibility of wrought iron is in the direction of its grain. Further, at all surfaces of the field magnets which are destined to be polar surfaces, where, therefore, the lines of force will run *out* of the iron *into* the air, the grain of the iron ought to be end-on. This rule is not observed in the construction of Siemens dynamos, in which there are arched pieces of wrought iron as cores for the field magnets, arranged as shown in Fig. 33, so as to be magnetised

FIG. 33.

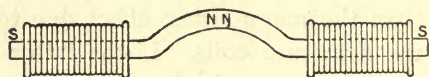

SIEMENS FIELD MAGNET.

from both ends with a "consequent pole" in the middle of the arch. Here the lines of force run along the grain to the middle, and then have to run out across the grain of the iron.

The student should contrast with Siemens' arrangement, that which is employed in the Edison dynamo (Fig. 131), which is more like that used by Wilde in 1865 (see Fig. 3). The ordinary Gramme has consequent poles at the middle of each of the electro-magnets (see Figs. 89 and 90). The modified double Gramme machine constructed by Marcel Deprez is sketched in Fig. 34. Other forms are considered in Appendix VII.

(aa.) A great advantage is gained by thus working as nearly as possible with closed magnetic circuits; that is to say, with a nearly continuous circuit of iron to conduct the lines of magnetic force round into themselves in closed curves. The enormous importance of this was pointed out so far back

as 1878 by Lord Elphinstone and Mr. C. W. Vincent, whose dynamo embodies their idea. Every electrician knows that if a current of electricity has to pass through a circuit, part of which consists of copper and part of liquids—such as the acid in a battery, or the solution in an electrolytic cell—the resistance of the liquid is, as a rule, much more serious than the resistance of the copper. Even with dilute sulphuric acid the resistance to the flow of the current by a thin stratum is 200,000 times as great as would be offered by an equally thick stratum of copper. And in the analogous case of using

FIG. 34.

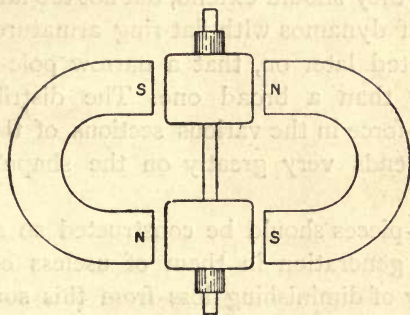

FIELD MAGNETS OF DEPREZ'S DOUBLE GRAMME DYNAMO.

a field magnet to magnetise the iron core of an armature, the stratum of air—or, it may be, of copper wire—in between the two pieces of iron, offers what we may term a relatively enormous resistance to the magnetic induction. If we take the magnetic permeability of air as 1, then the permeability of iron will be represented by values lying between 40 and 20,000 according to the quality of the iron. The permeability of copper is not very different from that of air. Or, in other words, a stratum of air or copper offers from 40 to 20,000 times as much resistance to the magnetic induction as if the space were filled up with soft iron. Obviously, then, it would be a gain to diminish as much as possible the gaps between the portions of iron in the circuit. The values of the magnetic

permeability for iron, air, and copper, have been known for years, yet this simple deduction from theory has been set at defiance in the vast majority of cases. This would show that the Pacinotti ring, with projecting iron teeth, was essentially right in principle. *p. 114*

Pole-pieces.

(*ab.*) If pole-pieces are used they should be massive, and of the softest iron, for reasons similar to those urged above.

(*ac.*) The pole-pieces should be of shapes really adapted to their functions. If intended to form a single approximately uniform field, they should extend, but not too far, on each side. In the case of dynamos with flat-ring armatures, it is found, as demonstrated later on, that a narrow pole-piece is more advantageous than a broad one. The distribution of the electromotive-force in the various sections of the coils on the armature depends very greatly on the shape of the pole-pieces.

(*ad.*) Pole-pieces should be constructed so as to avoid, if possible, the generation in them of useless eddy currents. The only way of diminishing loss from this source is to construct them of laminæ built up so that the mass of iron is divided by planes in a direction perpendicular to the direction of the currents, or of the electromotive-forces tending to start such currents.

(*ae.*) If the bed-plates of dynamos are of cast iron, care should be taken that these bed-plates do not short-circuit the magnetic lines of force from pole to pole of the field magnets. Masses of brass, zinc, or other non-magnetic metal may be interposed; but are at best a poor resource. In a well-designed dynamo there should be no need of such devices.

Field-magnet Coils.

(*af.*) In order to be of the greatest possible service, the coils of the field magnets should be wound on most thickly at the middle of the magnet, not distributed uniformly along its

length,* nor yet crowded about its poles. The reason for this is two-fold. Inspection of Fig. 6 (p. 9) will show that many of the lines of force of a magnet "leak out" from the sides of the magnet before reaching its poles, where they should all emerge if the mass of the magnet were perfectly equally magnetised throughout its whole length. Internally, the magnetisation of the magnet is greatest at its centre. At or near the centre, therefore, place the magnetising coils, that the lines of force due to them may run through as much iron as possible. The second reason for not placing the coils at the end is this; any external influence which may disturb the magnetism of a magnet, or affect the distribution of its lines of force, affects the lines of force in the neighbourhood of the pole far more than those in any other region. It is for this reason that in Bell's telephones, and in Hughes' magnets, where it is desired to make a magnet most sensitive to variations in the strength of the current, the coils are fixed on at the pole. In the field magnet of a dynamo, on the contrary, where the magnet is wanted to be as steady and constant as possible in its magnetic power, the coils should not be placed on the poles.

(*ag.*) The proper resistances to give to the field-magnet coils of dynamos have been calculated by Sir Wm. Thomson,† who has given the following results:—

For a "Series Dynamo," make the resistance of the field magnets a little less than that of the armature. Both of them should be small compared with the resistance of the external circuit.

For a "Shunt Dynamo" the rule is different. The best proportions are when such that

$$R = \sqrt{r_s r_a},$$

* This recommendation which appeared as above in my Cantor Lectures, has been objected to by the late Comte du Moncel as incorrect. The Comte maintained that an even distribution gave when put to the test of experiment the strongest magnetic effect. This may have been so if the experiments were made with long cores of uniform thickness. It does not hold with cores that are thicker in the middle than at the ends.

† *British Association Report*, 1881, p. 528.

or that

$$r_s = \frac{R^2}{r_a},$$

where the symbols R , r_s , and r_a , stand respectively for the resistances of the external circuit, of the shunt coils, and of the armature. The proof of this rule, as deduced from the economic coefficient, is given in due place in Chapter XVI. on the Algebraic Theory of the Shunt Dynamo. The rule for shunt dynamos when worked out shows that the resistance of the shunt coils ought to be at least 364 times as great as that of the armature, otherwise an efficiency of 90 per cent. is quite unattainable.

Field Magnets in Practice.

In the classification of dynamos laid down in Chapter II., we found that those of the first class required a single approximately uniform field of force, whilst those of the second class required a complex field of force differing in intensity and sign at different parts. Accordingly, we find a corresponding general demarcation between the field magnets in the two classes of machine. In the first, we have usually two pole-pieces on opposite sides of a rotating armature. In the second, a couple of series of poles set alternately round a circumference or crown, the coils which rotate being set upon a frame between two such crowns of poles.

Confining ourselves, at first, to the first class of machines, we find that, in practice, their magnets differ widely in construction and design. In very few of the existing patterns is there much trouble taken to secure steady magnets, by making them long, heavy and solid, or with very heavy pole-pieces. I have repeatedly, in testing dynamos, had to report that an unnecessary amount of wire had been wound upon the field magnets; and I find that the usual reply is, that with less wire the machine does not work so well. If, however, it is found necessary to wind on so many coils upon the magnets as to bring these practically to saturation long before the machine

is doing its maximum work, it is clear that either the iron is insufficient in quantity, or it is deficient in quality. In the Bürgin machines, where cast-iron field magnets are employed, the smaller magnetic susceptibility of this metal is made up for by employing a great weight of it: but cast-iron magnets give only about 60 per cent. of the effect that wrought-iron field magnets of an equal size will give. In Siemens' smaller dynamos, the amount of iron employed in the field magnets would be quite insufficient if it were not of high quality. As it is, the mass of it (especially in the polar parts) might with advantage be increased.* In some of the early machines of Wilde, and in Edison's well-known dynamos, long field magnets with heavy pole-pieces are found. Edison's dynamos, indeed, are all remarkable in this feature; the pole-pieces and the yoke connecting the iron cores of the coils are made abnormally heavy. This is not more noticeable in the giant dynamos used at the Holborn Viaduct (see Fig. 133, p. 163) than in the smaller machines used in isolated installations for sixty and for fifteen lights. The Edison-Hopkinson dynamos are still heavier, but shorter in build (see Fig. 136, p. 167).

The principle of shaping the magnets so that their external form approximates to that of the magnetic curves of the lines of force, is to some extent carried out in such widely differing types of machine as the Gramme with "Jamin" magnet, the Jürgensen dynamo (Fig. 97, p. ¹²⁶125), and Thomson's "mouse-mill" dynamo. The two machines last named exhibit several curious contrasts. In the Jürgensen, the field magnets have heavy pole-pieces; in the Thomson there are none; and in the Thomson machine the iron core is thicker at the middle than at the ends. In both there are auxiliary internal electromagnets, fixed within the rotating armature, to concentrate and augment the intensity of the field, according to the device patented by Lord Elphinstone and Mr. Vincent (see p. 172). In the Thomson machine the coils are heaped on more thickly at the middle of the field magnets; in the Jürgensen, the coils are crowded up around the poles. The latter arrangement is

* Reference to Figs. 129 and 130, will show that in the newest Siemens' machines this course has been partially adopted.—S.P.T.

not justified from the point of view of theory. If we may judge from a report on this machine by Professors Ayrton and Perry,* the arrangement is not satisfactory in practice, as there are more coils than suffice to magnetise the magnets. Is it possible that the mistake is not in having too many coils, but in having them in the wrong place ?

Another suggestion, indicated above from theoretical considerations, is of laminating the pole-pieces so as to prevent the production in them of wasteful eddy currents. So far as I am aware, there are only two machines in which this precaution is carried into effect. One is the disk dynamo of Drs. Hopkinson and Muirhead, the field magnets of which are made up of laminæ of iron, cast into a solid iron backing. The other is the Weston dynamo. *p. 171*

Commutators, Collectors, and Brushes.

(*ah.*) Commutators and collectors being liable to be heated through imperfect contact, and liable to be corroded by sparking, should be made of very substantial pieces of copper, or else of gun-metal ; or, better still, of phosphor-bronze. Some makers cast the metal in the form of a hollow cylinder and saw it up into parallel strips. More frequently the metal is cast or drawn in rods of the form of the bars, which are afterwards filed up true and fitted into their places. Collectors of substantially such type as is here described are common to all dynamos of the first class, except only the Brush dynamo, in which there is a multiple commutator, instead of a collector. The collector of Pacinotti's early machine differed only in having the separate bars alternately a little displaced longitudinally along the cylinder, but still so that the same brush could slip from bar to bar. Niaudet's modification, in which the bars are radially attached to a disk, is a mere variety in detail, and is not justified by successful adoption. In the collector once used in Weston's dynamo, and in some forms of Schuckert's dynamo, the bars are oblique or curved, without,

* See *Electrical Review*, September 23, 1882.

however, any other effect than that of prolonging the moment during which the brush, while slipping from contact with one bar to contact with the next, short-circuits one section of the coil.

(ai.) In the case of a collector made of parallel bars of copper, ranged upon the periphery of a cylinder, the separate bars should be capable of being removable singly, to admit of repairs and examination.

(aj.) The brushes should touch the commutator or the collector at the two points, the potentials of which are respectively the highest and the lowest of all the circumference. In a properly and symmetrically built dynamo, these points (called *neutral points*) will be at opposite ends of a diameter.

(ak.) In consequence of the armature itself, when traversed by the currents, acting as a magnet, the magnetic lines of force of the field will not run straight across, from pole to pole, of the field magnets, but will take, on the whole, an angular position, being twisted a considerable number of degrees in the direction of the rotation. This reaction of the induced current will be more particularly dealt with presently. In consequence of this and other reactions, the diameter of commutation (which is at right angles to the resultant lines of force in machines of the Siemens and Gramme type, and parallel to the resultant lines of force in machines of the Lontin type) pp. 30, 2 will be shifted forward. In other words, the brushes will have a certain *angular lead*. The amount of this lead depends upon the relation between the intensity of the magnetic field and the strength of the current in the armature. This relation varies in the four different types of field magnets. In the series dynamo, where the one depends directly on the other, the angle of lead is nearly constant whatever the external resistance. In other forms of dynamo, the lead will not be the same, because the variations of resistance in the external circuit do not produce a proportionate variation between the two variables which determine the angle of lead.

(al.) Hence, in all dynamos, it is advisable to have an adjustment, enabling the brushes to be rotated round the commutator or collector to the position of the diameter of commutation for the time being. Otherwise there will be

sparkling at the brushes, and in part of the coils at least the current will be wasting itself by running against an opposing electromotive-force.

(*am.*) The arrangements of the collector or commutator should be such that, as the brushes slip from one part to the next, no coil or section in which there is an electromotive-force should be short-circuited, otherwise work will be lost in heating that coil. For this reason, it is well so to arrange the pole-pieces that the several sections of coils on either side of the neutral point should differ but very slightly in potential from one another.

(*an.*) The number of contact points between the brush and the collector-bar should be as numerous as possible, for by increasing the number of contacts, the energy wasted in sparks will be diminished inversely as the square of that number. The brushes might with advantage be laminated, or made of parallel loose strips of copper, each bearing edgeways on the collector.

(*ao.*) The segments of the collector or commutator should be efficiently insulated from one another and from the axle. Many makers place layers of vulcanised fibre, asbestos paper, or mica between and below them. Others leave air spaces. If care is not taken the insulation may be spoiled by copper-dust worn off the brushes, or by the formation of a film of charred oil. The latter accident sometimes occurs where asbestos is employed; and is the more annoying as it is often accompanied with an unaccountable falling off in the power of the dynamo, due to an invisible short-circuiting through a charred carbonaceous mass beneath the surface. The only remedy is to remove the insulating material and replace with new. On this account some experienced engineers prefer to treat the collector with French chalk instead of oil. In Hochhausen's dynamo the collector-bars are L-shaped, and are firmly bolted to an end-plate of slate, leaving air gaps between the bars. Some makers drive air from a fan between the separate collector-bars to prevent dust lodging there and to keep them cool. It may be mentioned that several makers now apply an insulated ring of steel to keep the collector-bars from flying.

The collector should never be allowed to wear into ruts or to run untrue, otherwise there will be an altogether unnecessary and detrimental amount of sparking, which will rapidly ruin the machine. Whenever needed, the collector should be filed or turned down until it runs truly.

Brushes.

The kind of brush most frequently used for receiving the currents from the collector, consists of a quantity of straight copper wires laid side by side, soldered together at one end, and held in a suitable clamp. The number of points of contact secured by this method is advantageous in reducing sparking. Two layers of wires are often thus united in a single brush, as shown in Fig. 35.

Brushes are also made of broad strips of springy copper, slit for a short distance so as to touch at several points, Fig. 36. Such are used in the Brush and Thomson-Houston dynamos.

Edison used as brushes a number of copper strips placed edgewise to the collector, and soldered flat against one another at the end furthest from the collector, Fig. 37. Here, also, the object in view was the subdividing of the spark at the contact.

In the latest Edison machines, a compound brush made up alternately of layers of wire, like Fig. 35, and slit strips of copper, like Fig. 36, has been adopted.

Rotating brushes in the form of metal disks have been tried by Gramme, and others have been suggested by Sir W. Thomson and Mr. C. F. Varley.

In those cases where, as in alternate-current machines, and in dynamos of the "unipolar" type, a brush is used to

FIGS. 35, 36, 37.

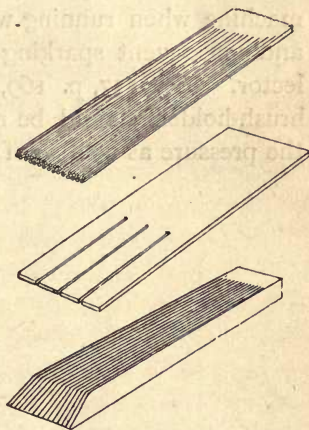

DIFFERENT KINDS OF BRUSHES.

obtain a sliding contact against an undivided collar or cylinder, the brush may be replaced by a slab of fine-grained and good conducting carbon. This valuable suggestion is due to Professor G. Forbes.

The brushes of the dynamo should be properly trimmed before the machinery is set into motion. Neglect of this simple point will result in rapid deterioration.

Brush-holders.

The brush-holders should be furnished with springs to bring a steady and even pressure to bear upon the points of contact. If the pressure is too light the vibrations of the machine when running will cause a jumping of the brushes and consequent sparking and destruction of brushes and collector. Fig. 137, p. 169, shows a spring brush-holder. All brush-holders should be made doubly adjustable in respect of the pressure as well as of the position of the brushes.



CHAPTER IV.

ON THE INDUCTION OF CURRENTS IN ARMATURES AND THE DISTRIBUTION OF POTENTIALS AROUND THE COLLECTOR.

IN considering the case of an ideal simple dynamo, it was shown that the induction in the rotating loop or coil was zero at the position where it lay in the diameter of commutation, and that the induction increased (as the sine of the angle) to its maximum value at 90° (see Fig. 14, p. 20). In other words, the coils get more active as they approach the pole-piece, and less active as they recede from the pole-piece, according to a regular law of fluctuation. In fact Fig. 38, which re-

FIG. 38.

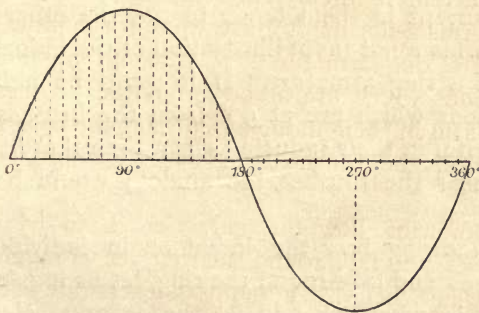

CURVE OF INDUCTION.

presents a curve of *sines*, will serve to represent, by the height of the curve, the amount of induction going on in an armature at every 10° round the circle. If there are, for example, thirty-six sections in a ring armature, so that the sections

are spaced out at 10° apart, the least active sections will be those at 0° and 180° , whilst the most active are those at 90° and 270° . But in all the ordinary "closed-coil" armatures, the separate sections are connected together so that any electromotive-force induced in the first section is added on to that induced in the second, and that in the third is added to these two, and so on all the way round to the brush at the other side. The separate electromotive-forces are added together just as are the separate electromotive-forces of a battery of voltaic cells united in series. A ring of battery cells united in series, but having one-half the cells set so

FIG. 39.

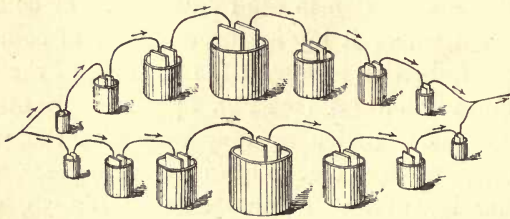

RING OF CELLS.

that the current in them tends to run the other way round the ring, forms a not inapt illustration of the inductions in the sections of a ring armature. If it could be indicated that those sections which are at 90° from the brushes are much more powerful in their inducing effect than those that occupy positions near the brushes, the analogy would be still more perfect.*

Now, knowing how the induction in individual coils or sections rises and falls round the ring, let us inquire what this will result in when we add up the separate electromotive-forces, so as to find the total effect. We shall have to add up the effects of all the sections round, from the negative brush at 0° on one side, to the positive brush at 180° on the other

* In Fig. 39 the middle cells of each row are drawn larger to suggest this; only, unfortunately, *large* cells do not possess a higher electromotive-force than small ones, though they have less resistance internally.

side : and the result will be the same in each half of the ring, because of symmetry. Suppose we take the side from 0° by 90° to 180° (on the left in Figs. 14 and 16). If we look at the curve given above (Fig. 38), we shall see that as the heights of the dotted lines represent the amount of induction, the total effect will be got by adding up the lengths of all those from 0° to 180° ; and of course, the sum is equal to the sum of the negative lengths between 180° and 360° . But we may do the thing in another way, which beside giving us the final total, will show us how the sum

grows as each length is successively added on. We should find that the sum grew slowly at first, then rapidly, then slowly again as it neared its highest value. The sum of the effects would grow, in fact, in a fashion represented on a reduced scale in the curve of Fig. 40. This process of adding up a continuously-varying set of values is called by mathematicians *integrating*. Fig. 40 is got by integrating the values of the curve Fig. 38 between the limits of 0° and 180° . Now in the actual dynamo this integration

is effected by the very nature of things, in consequence of the fact that each section is united to those on either side of it.

It is possible to investigate by experiment both these effects : the induction in the individual coils, and the total or integrated potential.

The electromotive-force induced in a single section as it passes any particular position, may be examined by means of a voltmeter or potential-galvanometer in the following way. Two small metal brushes are fixed to a piece of wood at a distance apart equal to the width between two consecutive bars of the collector. These brushes are united by wires to the voltmeter terminals, so that any difference of potentials

FIG. 40.

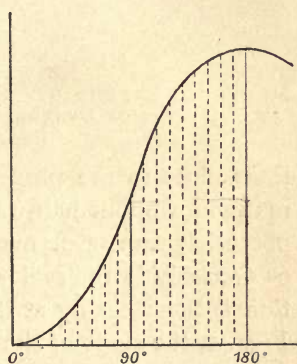
INTEGRATED CURVE OF
POTENTIALS.

between them will be indicated on the dial of the instrument. The two brushes are placed against the collector, as shown in Fig. 41, while it rotates ; and as they can be applied at any point, they will give on the voltmeter an indication which

FIG. 41.

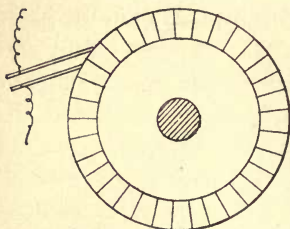
METHOD OF EXPERIMENTING
AT COLLECTOR OF DYNAMO.

measures the amount of electromotive-force in that section of the armature which is passing through the particular position in the field corresponding to the position of the contacts. This method was devised independently by the author and by Dr. Isenbeck. The author found, in the case of a small Siemens dynamo which he examined, that the difference of potential indicated was almost *nil* at the sections

close to the proper brushes of the machine, and was a maximum about half-way between. In fact, the difference of potentials rose most markedly at 90° from the usual brushes, or precisely in the region where, as seen in Fig. 39, the induction is theoretically at its highest point, and where, as seen in Fig. 40, the slope of the curve of total potential is greatest.

After the experiment above detailed, the author experimented on his Siemens dynamo in another way. The machine was dismantled, and its field magnets separately excited. Two consecutive bars of the collector were then connected with a reflecting galvanometer having a moderately heavy and slow-moving needle. A small lever clamped to the collector allowed the armature to be rotated by hand through successive angles equal to 10° , there being thirty-six bars to the collector. The deflexions obtained, of course measured the intensity of the inductive effect at each position. The result confirmed those obtained by the method of the two wire brushes.

The rise of the totalised (i. e. "integrated") potential round the armature can be measured experimentally by a method first suggested by Mr. Mordey, and also involving the use of a voltmeter.

In a well-arranged dynamo of the first class, if one measures the difference of potential between the negative brush and the successive bars of the collector, one finds that the potential increases regularly all the way round the collecting cylinder, in both directions, becoming a maximum at the opposite side where the positive brush is.

Mr. W. M. Mordey, who first drew the author's attention to the fact that this distribution was irregular in badly designed machines, had devised the following method of observing it. One terminal of a voltmeter was connected to one of the brushes of the dynamo, and the other terminal was joined by a wire to a small metallic brush or spring, which could be pressed against the rotating collector at any desired part of its circumference. The author then made the suggestion that these indications might with advantage be plotted out round a circle corresponding to the circumference of the collector. Figs. 42 and 43, which are reproduced from his

FIG. 42.

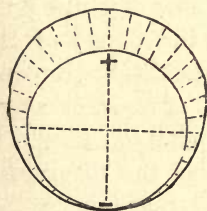
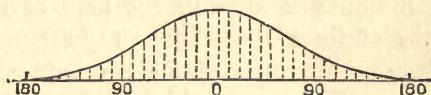

DIAGRAM OF POTENTIAL
ROUND THE COLLECTOR
OF GRAMME DYNAMO.

FIG. 43.



HORIZONTAL DIAGRAM OF POTENTIALS AT
COLLECTOR OF GRAMME DYNAMO.

Cantor Lectures, serve to show how the potential in a good Gramme machine rises gradually from its lowest to its highest value.

It will be seen that, taking the negative brush as the lowest point of the circle, the potential rises perfectly regularly to a maximum at the positive brush. The same values as are plotted round the circle in Fig. 42 are plotted out as vertical ordinates upon the level line in Fig. 43, which is nothing else than Fig. 40 completed for both halves of the collector. Fig. 40 is, however, a theoretical diagram of what the distribution ought to be, whilst Fig. 43 is an actual record taken from an "A" Gramme. If the magnetic field in which

the armature rotated were uniform, this curve will be a true "sinusoid," or curve of sines; and the steepness of the slope of the curve at different points will enable us to judge of the relative idleness or activity of coils in different parts of the field. The points marked + and - are termed the *neutral points*.

The rise of potential is not equal between each pair of bars, otherwise the curve would consist merely of two oblique straight lines, sloping right and left from the neutral point. On the contrary, there is very little difference of potential between the collector-bars immediately adjoining either of the neutral points. The greatest difference of potential occurs where the curve is steepest, at a position nearly 90° from the brushes, in fact, at that part of the circumference of the collector which is in connexion with the coils that are passing through the position of best action. Were the field perfectly uniform, the number of lines of force that pass through a coil ought to be proportional to the sine of the angle which the plane of that coil makes with the resultant direction of the lines of force in the field, and the rate of cutting the lines of force should be proportional to the cosine of this angle. Now the cosine is a maximum when this angle = 0° ; hence, when the coil is parallel to the lines of force, or at 90° from the brushes, the rate of increase of potential should be at its greatest—as is very nearly realised in the diagram of Fig. 43, which, indeed, is very nearly a true "sinusoidal" curve. Such curves, plotted out from measurements of the distribution of potential at the collector, show not only where to place the brushes to get the best effect, but enable us to judge of the relative "idleness" or "activity" of coils in different parts of the field, and to gauge the actual intensity of different parts of the field while the machine is running. If the brushes are badly set, or if the pole-pieces are not judiciously shaped, the rise of potential will be irregular, and there will be maxima and minima of potential at other points. An actual diagram, taken from a dynamo in which these arrangements were faulty, is shown in Fig. 44, and again is plotted horizontally in Fig. 45; from which it will

be seen, not only that the rise of potential was irregular, but that one part of the collector was more positive than the positive brush, and another part more negative than the negative. The brushes, therefore, were not getting their proper difference of potential; and in part of the coils, the currents

FIG. 44.

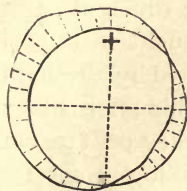
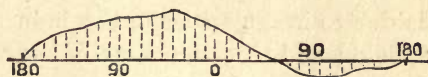

DIAGRAM OF POTENTIAL
ROUND THE COLLECTOR
OF A BADLY-ARRANGED
DYNAMO.

FIG. 45.



HORIZONTAL DIAGRAM OF POTENTIALS AT
COLLECTOR OF FAULTY DYNAMO.

were actually being forced against an opposing electromotive-force.

This method of plotting the distribution of potential round the collector has proved very useful in practice, and elucidates various puzzling and anomalous results found by experimenters who have not known how to explain them. In a badly arranged dynamo, such as that giving a diagram like Fig. 44, a second pair of brushes, applied at the points showing maximum and minimum potential, could draw a good current without interfering greatly with the current flowing through the existing brushes! In fact, I find that this bad distribution, giving rise to anomalous maxima and minima, has actually been patented by one inventor, who puts brushes on *six* different points of a collector!

Curves similar to those given can be obtained from the collectors of any dynamo of the first class—Gramme, Siemens, Edison, &c.—saving from the open-coil machines, which having no such collector, give diagrams of quite a different kind. It is, of course, not needful in taking such diagrams that the actual brushes of the machine should be in place, or that there should be any circuit between them, though in such cases the field magnets must be separately excited. It should also be remembered that the presence of brushes, drawing a current at any point of the collector, will alter the distribution of potential in the collector; and the manner

and amount of such alteration will depend on the position of the brushes, and the resistance of the circuit between them.

One immediate result of Mr. Mordey's observations on the distribution of potential, and of the author's method of mapping it, may be recorded. The author pointed out to Mr. Mordey that in a dynamo where the distribution was faulty, and where the curves of total potential showed irregularities, the fault was due to irregularities in the induction at different parts of the field; and that the remedy must be sought in changing the distribution of the lines of force in the field by altering the shape of the pole-pieces. The author was able after the lapse of fifteen months, to congratulate Mr. Mordey on the entire and complete success with which he has followed out these suggestions. He entirely cured the Schuckert machine of its vice of sparking. The typical bad diagram given in Fig. 44, was taken from a Schuckert machine before it received from his hands the modifications which have been signally successful, and which are detailed in pp. 144 and 148.

These methods have been dwelt on at some length here because of their great usefulness when applied to dynamos in which any such defect appears. They are also very closely related to the researches of Dr. August Isenbeck, which next claim attention.

Dr. Isenbeck described, in the *Elektrotechnische Zeitschrift* for August 1883, a beautiful little apparatus for investigating the induction in the coils of a Gramme ring, and for examining the influence exerted by pole-pieces of different form upon these actions.

Isenbeck's apparatus (Fig. 46) consists of a circular frame of wood placed between the poles of two small bar magnets of steel, each 25 centimetres long, lying 25 centimetres apart. On the frame, which is pivoted at the centre, is carried a ring of wood or iron, upon which is placed at one point a small coil of fine wire. This corresponds to a single section of the coils of a Pacinotti or of a Gramme ring, of which the ring of wood or iron constitutes the core. The coil can be adjusted to any desired position on the ring, and the ends communicate with a galvanometer. On vibrating it isochronously with the swing

of the needle of the galvanometer, the latter is set in motion by the induced currents, and the deflection which results shows the relative amount of induction going on in the particular part of the field where the coil is situated. The vibrations of the frame are limited by stops to an angle of $7^{\circ} 5'$. Pole-pieces of soft iron, bent into arcs of about 160° , so as to embrace the ring on both sides, but not quite meeting, were constructed to fit upon the poles of the magnets. In some of the experiments a disc of iron was placed internally within the ring; and in some other experiments a magnet was placed

FIG. 46.

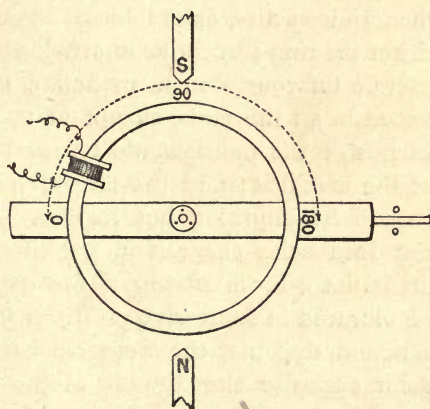

ISENBECK'S APPARATUS.

inside the ring, with its poles set so as either to reinforce or to oppose the action of the two external poles. In Dr. Isenbeck's hands this apparatus yielded some remarkable results. Using a wooden ring, and poles destitute of polar expansions, he observed a very remarkable inversion in the inductive action to take place at about 25° from the position nearest the poles.

Fig. 46 is a sketch of the main parts of Isenbeck's instrument, and shows the small coil mounted on the wooden ring, and capable of being vibrated to and fro between stops. When vibrated at 0° , or in a position on the diametral line at right angles to the polar diameter, there is no induction in the

coil ; but as the coil is moved into successive positions round the ring towards the poles, and vibrated there, the induction is observed first to increase, then die away, then begin again in a very powerful way, as it nears the pole, where the rate of cutting the lines of force is a maximum. This powerful induction near the poles is, however, confined to the narrow region within about 12° on each side of the pole. It is beyond these points that the false inductions occur, giving rise in the coil, as it passes through the regions beyond the 12° , to electromotive-forces opposing those which are generated in the regions which are close to the poles.

These inverse inductions were found by Isenbeck to be even worse when an iron disc, or an internal opposing magnet, was placed within the ring ; but a reinforcing magnet slightly improved matters. Of course such an action in a Gramme armature going on in all the coils, except in those within 12° of the central line of the poles, would be most disastrous to the working of the machine ; and the rise of potential round the collector would be anything but regular. In Fig. 47 I have copied out Isenbeck's curve of induction for the consecutive four quadrants. From 0° to 90° the exploring coil is supposed to be vibrated in successive positions from the place where, in the actual dynamo, the negative brush would be, round to a point opposite the S. pole of the pointed field magnet. From 90° to 180° it is passing round to the positive brush ; from 180° to 270° it passes to a point opposite the N. pole ; and from 270° to 360° returns to the negative brush. Now, since the height of this curve, at any point, measures the induction going on in a typical section as it moves through the corresponding region of the field, and since in the actual Pacinotti or Gramme ring the sections are connected all the way round the ring, it follows that the actual potential at any point in the series of sections will be got by adding up the total induced electromotive-force up to that point. In other words, we must integrate the curve to obtain the corresponding curve of potential, corresponding with the actual state of things round the collector of the machine. Fig. 48 gives the curve as integrated expressly for me from Fig. 47 by the aid of the

very ingenious curve integrator of Mr. C. Vernon Boys. The height of the ordinate of this second curve at any point is proportional to the total area enclosed under the first curve up to the corresponding point. Thus the height at 90° in the second curve is proportional to the total area up to 90° below the first

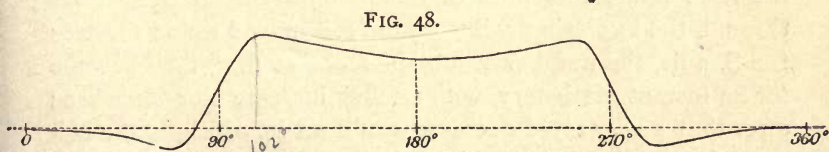
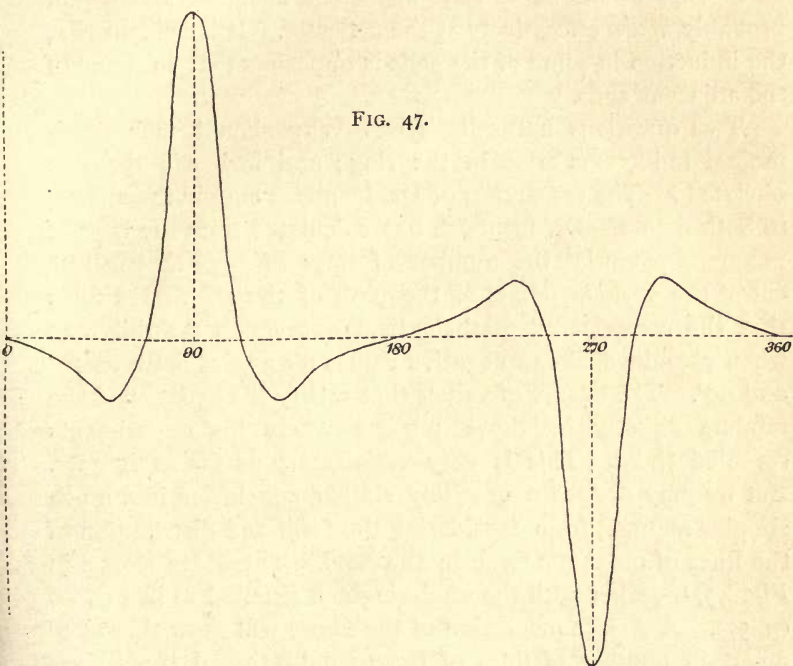

curve. And it will be noticed that though the induction (first curve, Fig. 47) decreases after 90° , and falls to zero at about 102° , the sum of the potentials (second curve, Fig. 48) goes on increasing up to 102° , where it is a maximum, and after that falls off, because, as the first curve shows, there is from that point onwards till 180° an opposing false induction. If this

potential curve were actually observed on any dynamo, we might be sure that we could get a higher electromotive-force by moving the brush from 180° to 102° , or to 258° , where the potential is higher. Any dynamo in which the curve of potentials at the commutator presented such irregularities as Fig. 48 would be a very inefficient machine, and would probably spark excessively at the collector. It is evident that the induction in some of the coils is opposing that in some of the adjacent coils.

Two questions naturally arise—Why should such detrimental inductions arise in the ring; and how can they be obviated? The researches of Dr. Isenbeck supply the answer to both points. Dr. Isenbeck has calculated from the laws of magnetic potential the number of lines of force that will be cut at the various points of the path of the ring. He finds that the complicated mathematical expression for this case when examined, shows negative values for angles between 12° and 90° . The curves of values that satisfy his equations have minima exactly in those regions where his experiments revealed them. This is very satisfactory as far as it goes. But we may deduce a precisely similar conclusion in a much simpler manner, from considering the form and distribution of the lines of magnetic force in the field. These are shown in Fig. 49, together with the exploring coil situated as in Fig. 46 (p. 57). A simple inspection of the figure will show that at 0° a certain number of lines of force would thread themselves through the exploring coil. As the coil moved round towards the S. pole, the number would increase at first, then become for an instant stationary, with neither increase nor decrease; after that a very rapid decrease would set in, which, as the coil passed the 90° point, would result in there being no lines of force through the coil. But at the very same instant the lines of force would begin to crowd in on the other side of the coil, and the number so threaded through negatively, would increase until the coil turned round to about the position marked T, where the lines of force are nearly tangential to its path, and here the inversion would occur, because, from that point onwards to 180° , the number of lines of force threaded through

the coil would decrease. We see, then, that such inversions in the induction must occur of necessity to a *small* coil rotating in a magnetic field in which the lines of force are distributed in the curved directions, and with unequal density. The remedy is obvious ; either arrange a field, in

FIG. 49.

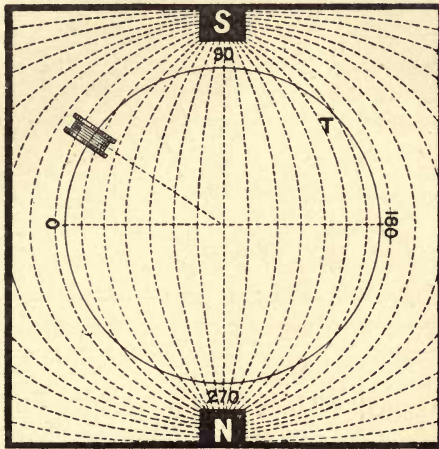

which the lines of force are more equally distributed, and are straighter, or else use a coil of larger aperture. Another remedy is to abandon the *ring* armature and use a *drum* armature which gives no inversions.

If an iron core be substituted for the wooden core, the useful induction is greater, and the false induction less ; there is still an inversion, but it takes place at about 25° from the pole, and is quite trifling in amount. The introduction of iron pole-pieces extending in two nearly semicircular arcs from the magnets on either side has, if the wooden ring be still kept as a core, the effect of completely changing the induction, so that the curve, instead of showing a maximum at 90° from starting, shows one at about 10° , and another at 170° . This is given in Fig. 50.

The integrated curve of potential given in Fig. 51 is curious : there are no reversals ; but the potentials rise and fall so very suddenly on either side of the 0° and 180° points that any

small displacement of the brushes might produce disastrous inversions.

If, however, we make the double improvement of using the iron pole-pieces and the iron core at the same time, the effect

FIG. 50.

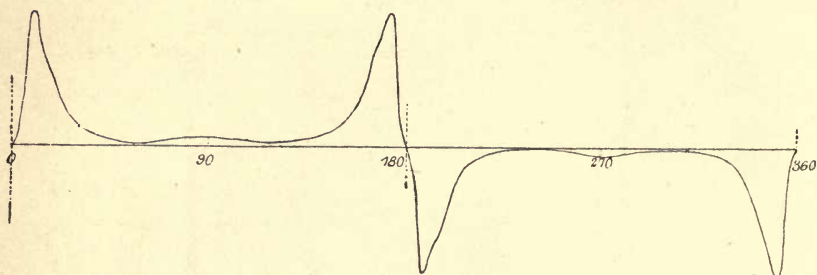
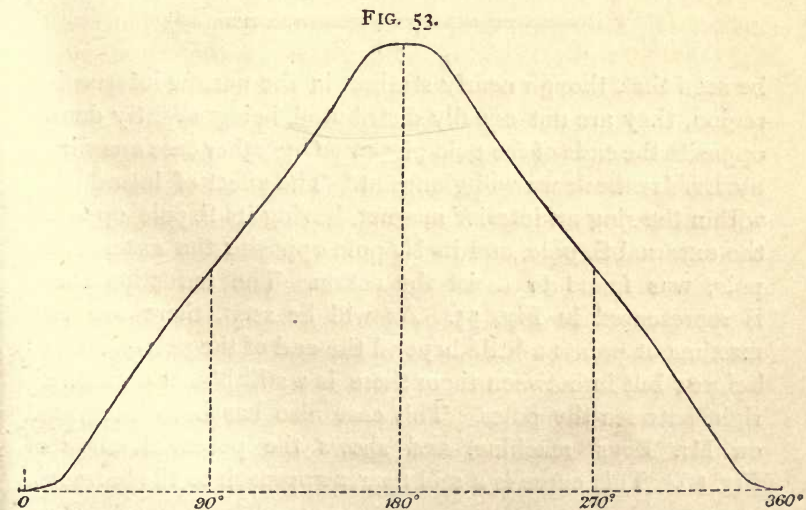
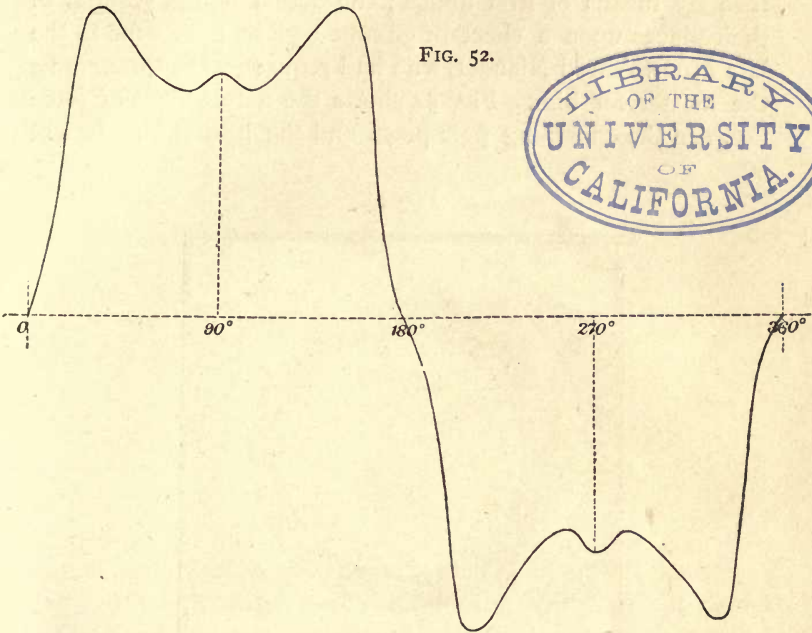

FIG. 51.



is at once changed. There are no longer any inversions, though the induction still shows some peculiarity. Fig. 52 shows the curve of induction adapted from Dr. Isenbeck's paper, and Fig. 53 the curve of potential which I have had integrated from it. Looking at Fig. 52, we see that on starting from 0° , induction soon mounts up, and becomes a maximum at about 20° , where the coil is getting well opposite the end of the encircling pole-piece. From this point on, though the induction is somewhat less, it still has a high value, showing a slight momentary increase as the coil passes the pole at 90° , and there is another maximum at about 160° , as the coil passes the other end of the pole-piece. My integrated curve (Fig. 53) tells us what would go on at the collectors if this were the action in the connected set of coils of a Pacinotti or Gramme ring. The potential rises from 0° all the way to close upon 180° . Still this is not perfect. In the perfect case the potential curve would rise in a perfect harmonic wave form, like that shown in Fig. 40 (p. 51). Fig. 53 departs widely from this, for it is

convex from 0° to 90° , and concave between 90° and 180° . But there are no inversions. The cause of the improvement is easily told : the field—such as there is between the pole-piece



and the core—is “straighter,” and the density of the lines of force in it more uniform. I proved this experimentally in 1878, by the simple process of examining the lines of force in such a field by means of iron filings; the actual filings, secured in their places upon a sheet of gummed glass, were sent to the late Mons. Alfred Niaudet, who had requested me to examine the matter for him. Fig. 54 shows the actual lines of force between the encircling pole-piece and the iron ring. It will

FIG. 54.

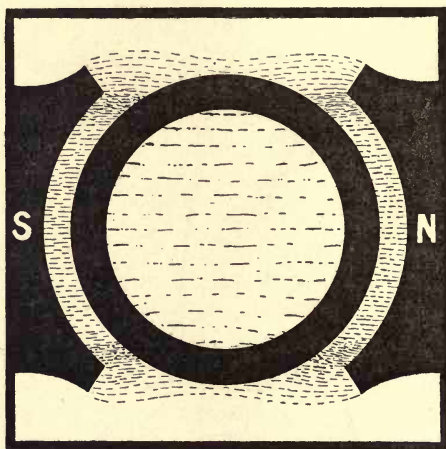

be seen that, though nearly straight in the narrow intervening region, they are not equally distributed, being slightly denser opposite the ends of the pole-pieces. One other case examined by Dr. Isenbeck we will glance at. The effect of introducing within the ring an interior magnet, having its S. pole opposite the external S. pole, and its N. pole opposite the external N. pole, was found to assist the action. The induction curve is represented in Fig. 55. As will be seen, there are two maxima at points a little beyond the end of the pole-pieces, as before; but in between them there is a still higher maximum, right between the poles. This case also has been integrated on Mr. Boys' machine, and shows the potential curve of Fig. 56. This curve is a still nearer approach to the harmonic

FIG. 55.

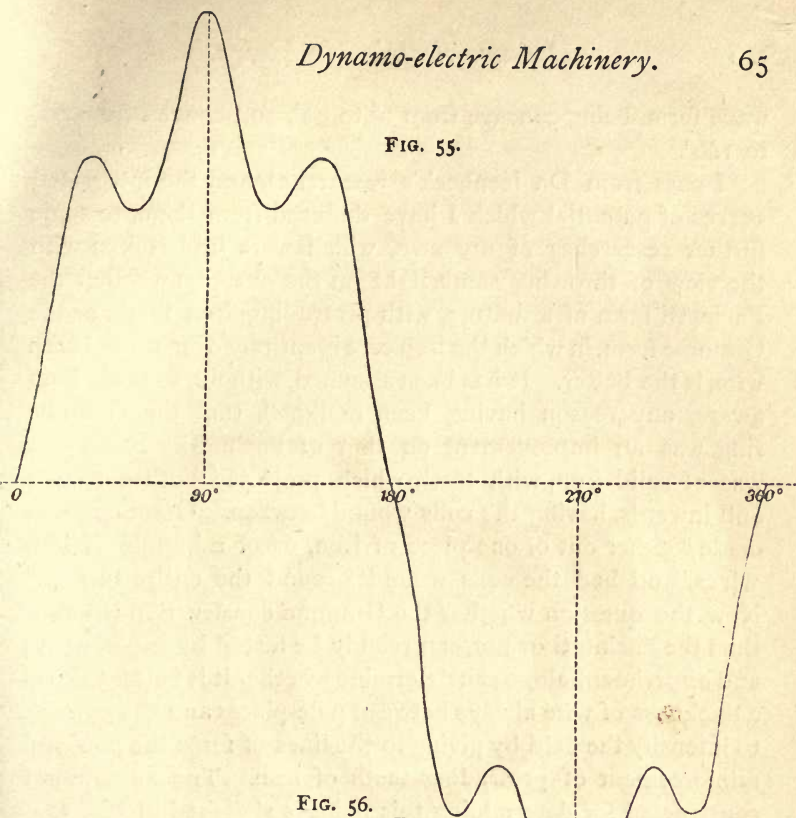
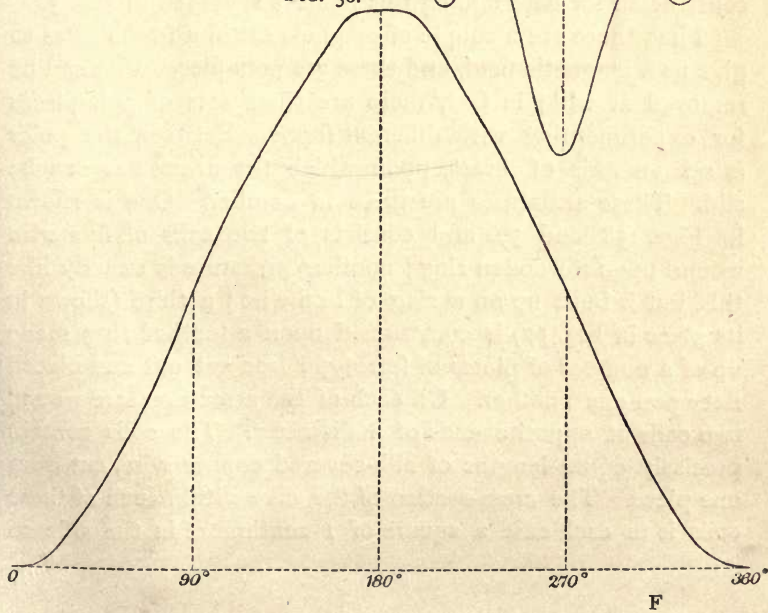

FIG. 56.



wave form, being concave from 0° to 90° , and convex from 90° to 180° .

I pass from Dr. Isenbeck's researches, and the integrated curves of potential which I have deduced from them, to some further researches of my own, which were undertaken with the view of throwing some light on the question whether the Pacinotti form of armature, with protruding iron teeth, or the Gramme form, in which the iron core is entirely over-wound with wire, is the better. It has been assumed, without, so far as I am aware, any reason having been assigned, that the Gramme ring was an improvement on that of Pacinotti. Pacinotti's was of solid iron, with teeth which projected both outwards and inwards, having the coils wound between. Gramme's was made "either out of one piece of iron, or of a bundle of iron wires," and had the coils wound "round the entire surface." Now the question whether the Gramme construction is better than the Pacinotti or not, can readily be tested by experiment; and experiment alone can determine whether it is better to keep a thickness of wire always between pole-pieces and the core, or to intensify the field by giving to the lines of force the powerful reinforcement of protruding teeth of iron. The apparatus I constructed for determining this point is sketched in Fig. 57.

First, there are a couple of magnets set in a frame so as to give us a magnetic field, and there are pole-pieces that can be removed at will; in fact, there are three sets of pole-pieces for experimenting with different forms. Between the poles is set an axis of brass, upon which the armatures can be slid. These armatures are three in number. One is shown in Figs. 58 and 59, and consists of two coils of fine wire wound upon a wooden ring; another armature is exactly like this, but is built up on a ring of iron wire; a third (shown in its place in Fig. 57) is constructed upon a toothed ring made up of a number of plates of ferrotype iron cut out and placed flat upon one another. On each of the armatures are wound two coils at opposite ends of a diameter. The coils contain precisely equal lengths of silk-covered copper wire, cut from one piece. The cross-section of the core within each of these coils is in each case a square of 1 centimetre in the side, so

that the number of turns in each coil is as nearly equal as possible. I can slip any one of these armatures into the field,

FIG. 57.

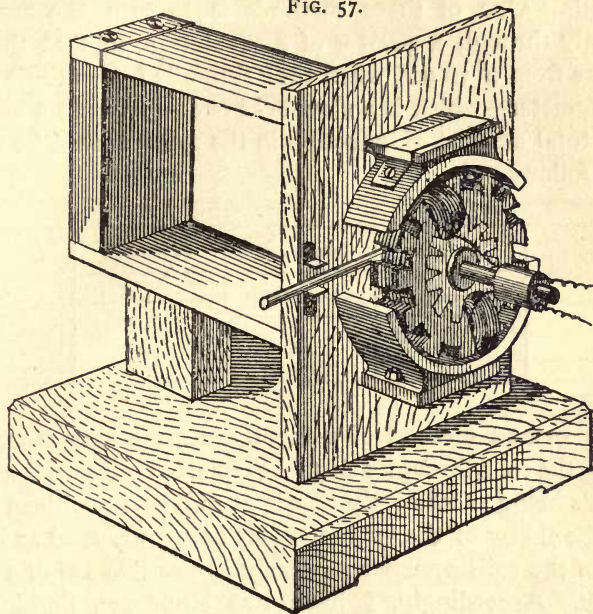

APPARATUS FOR INVESTIGATING INDUCTION OF ARMATURES.

FIG. 58.

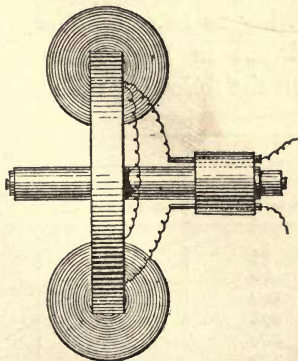
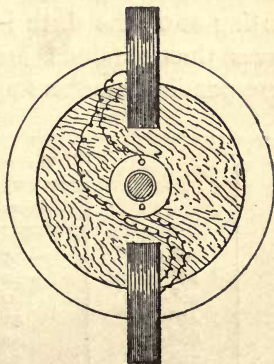

FIG. 59.



EXPERIMENTAL ARMATURE.

and connect it with a galvanometer. There is a lever handle screwed to the armature, by means of which it can be moved. I have used two methods of proceeding in order to compare the coils. One of these methods is to turn the armature suddenly through a quarter of a revolution, so that the coils advance from 0° to 90° , when the "throw" of the needle of the galvanometer—which is a slow-beat one—gives me a measure of the total amount of induction in the armature. The results are as follows :—

	GRAMME.	GRAMME.	PACINOTTI.
	Wooden Ring.	Iron Ring.	Iron Toothed Ring.
	5	24	50

My second method of using these armatures consists in jerking the coils through a distance equal to their own thickness, the coils being successively placed at different positions in the field, the throw of the galvanometer being observed as before. Each of the coils occupies as nearly as possible 15° of angular breadth. Accordingly, I have two stops set, limiting the motion of the handle to that amount, and at the back there is a graduated circle enabling me to set the armature with the coils in any desired position. If we move the coils by six such jerks, through their own angular breadth each time, then, starting at 0° , the sixth jerk will bring us to 90° . The three curves thus obtained are plotted out in Fig. 60, and the corresponding numbers are given in the following table :—

	GRAMME.	GRAMME.	PACINOTTI.
	Wooden Ring.	Iron Ring.	Iron Toothed Ring.
$0^\circ-15^\circ$	— 5	25	30
$15^\circ-30^\circ$	— 10	60	70
$30^\circ-45^\circ$	0	120	140
$45^\circ-60^\circ$	45	195	320
$60^\circ-75^\circ$	40	200	380
$75^\circ-90^\circ$	30	220	360

These figures leave no doubt as to the question at issue. The Gramme pattern of ring armature, so far from being an

FIG. 60.

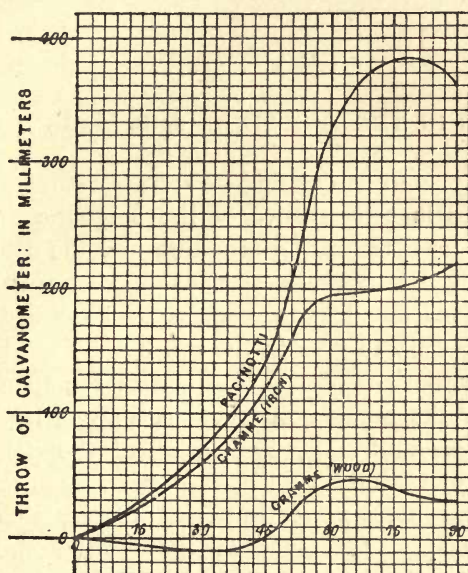

improvement on the Pacinotti, is theoretically a retrograde step; always supposing that the cost of construction, liability to heating, and other kindred matters be equal for the two.

In practice, however, there are two objections to the use of the toothed armature. The first is that the presence of these discontinuous projections causes heating in the pole-pieces of the field magnets. The second is that when there are projecting teeth it is less easy to secure durable insulation for the armature coils than when no such teeth project.

It ought not to be omitted that induction-curves, very similar to those of Isenbeck, were obtained in 1873 by Mons. J. M. Gaugain in an investigation into the action of the Gramme ring; an exploring coil being displaced through angles of 10° . Gaugain's work was published in the *Annales de Chimie et de Physique*, March 1873.

CHAPTER V.

REACTIONS IN THE ARMATURE AND MAGNETIC FIELD.

WHEN a dynamo is running, a set of entirely new phenomena arises in consequence of the magnetic and electric reactions set up between the armature and the field magnets, and between the separate sections of the armature coils. These reactions manifest themselves by the "lead" which it is found necessary to give to the brushes, by sparking at the brushes, by variations of the lead and of the sparking when the speed or the number of lamps is altered, by heating of armature cores and coils, by heating of the pole-pieces of the field magnets, and by a discrepancy between the quantity of mechanical horse-power imparted to the shaft and the electric horse-power evolved in the electric circuit. The nature of these reactions demands careful attention.

Obliquity of Resultant Magnetisation.—We have seen (p. 50 and Fig. 39) that any closed-coil armature may be regarded as acting like a double voltaic battery, the two sets of coils acting like two rows of cells united "in parallel." We have now to show that a ring armature may be regarded also as a double magnet. Suppose a semi-ring of iron to be surrounded, as in Fig. 51, by a coil carrying a current, it will become as every one knows a magnet having a N. pole at one end, and a S. pole at the other. If a complete ring be similarly over-wound, but with an endless winding, and if then electric currents from a battery or other source are introduced into this coil at one point, flowing round the two halves of the ring to a point at the other side, and then leave the coil by an appropriate conductor, each half of the ring will be magnetised. There will be, if the currents circulate as represented by the arrows in Fig. 62, a double S pole at the

point where the currents enter, and a double N. pole at the place where the currents leave. The currents circulating in a Gramme ring, will therefore tend to magnetise the ring in this

FIG. 61.

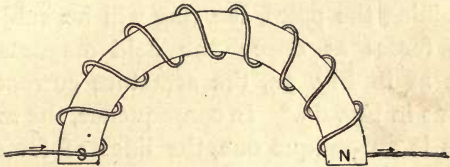

fashion. Let us see how such a magnetisation is distributed inside the iron itself. Fig. 63 shows the general course of the magnetic lines of force as they run through the iron ; where

FIG. 62.

FIG. 63.

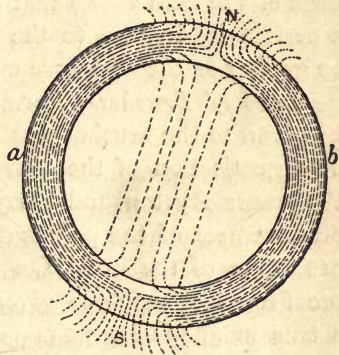
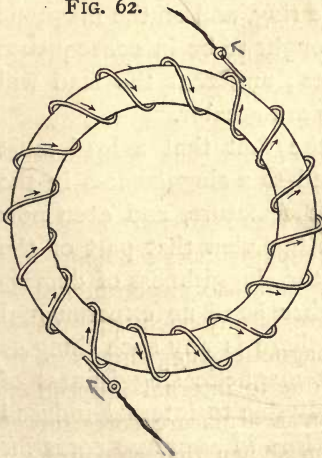

they emerge into the air are the effective poles of the ring regarded as a magnet. Fig. 63 should be very carefully compared with Fig. 62. It will be noticed that though the majority of the lines of force pass externally into the air at the outer circumference, a few of the lines of force find their way across the interior of the ring, from its N. to its S. pole. This part of the magnetic field would in an actual dynamo be deleterious if the number of lines of force were not so few.

Now turn back to Fig. 54, p. 64, and observe the way in which the field magnets tend to magnetise the ring when it is standing still, or at least when there is no current circulating in the armature coils. It is evident that when the dynamo is at work, if the brushes were set on a diameter at right angles to the line joining the poles, the ring will be subjected to two magnetising forces at once: the field magnets tending to magnetise it as in Fig. 54, the armature current tending to magnetise it as in Fig. 63.* In consequence, the magnetisation which results is an oblique one, the lines of force in the field between the armature and the field magnet being twisted round. But if the magnetic field is itself twisted round, the brushes must be correspondingly shifted, or else commutation will not take place at the moment when the number of lines of force is a maximum. This first reaction of the armature currents on the magnetisation of the ring, and on the magnetic lines of the field shows that there ought to be in consequence a certain lead given to the brushes; and that the lead will be greater as the armature currents are greater.

Lead of Brushes.—Formerly the fact that a lead must be given to the brushes was ascribed to a sluggishness in the demagnetisation of the iron of the armature, and even now Professors Ayrton and Perry take the view that part of the displacement of the pole is due to the sluggishness of demagnetisation of the iron. On the other hand no experimental proof has ever yet been given that there is any such thing as a true magnetic lag; the apparent magnetic sluggishness of thick masses of iron is demonstrably due to internal induced currents; † and no one uses solid iron in armature cores for this very reason. Neither has it been shown that thin iron plates or wires, such as are used in armature cores, are slower in demagnetising than magnetising. Indeed, the reverse is probably true; and, until further experimental evidence is forthcoming, I shall assume that there is no true magnetic lag

* On the effect of a cross-magnetisation in diminishing magnetism of core, see Siemens, *Wied. Ann.* xiv., p. 634, 1882, and Schültze, *ib.* xxiv., p. 663, 1885; see also A. Oberbeck, *Habilitations-Schrift*, 1878.

† The reader is referred to Appendix V. for further evidence on this point.

in properly laminated iron cores. For further discussion of this, see Appendix V.

In 1878, the late M. Antoine Breguet suggested as a reason for the oblique position of the diameter of commutation, the influence of the actual current circulating round the armature coils, which would tend to produce in the iron of the armature a magnetisation at right angles to that due to the field magnets. Breguet showed as above that there would be a resultant oblique direction of the lines of magnetism in the field, and therefore, since the "diameter of commutation" is at right angles to this direction, the brushes also must be displaced through an equal angle. Clausius accepts this view in his recent theory, and adopts for the angle of the resultant field that whose tangent is the ratio of the two magnetising forces due to the current in the armature and field magnets respectively. It will be shown presently that this rule is not correct, and that the sine, not the tangent of the angle of lead, represents the ratio of the two forces.

It may, however, be pointed out that, assuming as a first approximation that either the sine or the tangent of the angle of lead represents the ratio between the magnetising power of the field magnets and of the armature coils, the lead may be diminished to a very small quantity, by increasing the relative power of the field magnets, a course which is for many other reasons advisable. All practice confirms the rule that the magnetic moment of the field magnets ought to be very great as compared with that of the armature.* Further than this, there ought to be so much iron in the armature as to be magnetised to near the critical point of saturation when the dynamo is working at its greatest activity. If there is less than this, it will become saturated at a certain point, and when any currents greater than this are employed

* The field magnets ought to be so powerful as entirely to overpower the armature. I have seen a dynamo in which, on the contrary, the armature overpowered the field magnets. When the brushes had a small lead there was a good electromotive-force, but it sparked excessively. With a large lead the sparks disappeared, but the electromotive-force also vanished!

the lead will alter, for then the magnetic effect due to the current in the armature will be of less importance relatively to that due to the field magnets. For the same reason, the lead will be more constant when the field magnets are under their saturation point, than when quite saturated. In short, every cause that tends to reduce the lead, makes the lead more constant, and therefore tends to reduce sparking at the brushes; and the best means to secure this is obviously to use an unstinted quantity of iron—and that of the softest kind—both in the field magnets and in the armature, for then the currents circulating in the armature will have less chance of perturbing the field.

Diminution of Effective Magnetisation.—In relation to the magnetisation of field magnets, it may be pointed out that the “characteristic” curves of dynamo machines (see Chap. XX.), which are used to show the rise of the electromotive-force of the machine in relation to the corresponding strength of the current, are sometimes assumed, though not quite rightly, to represent the rise of magnetisation of the field magnets. Now, though the magnetisation of the magnet may attain to practical saturation, it does not, under a still more powerful current, show a diminished magnetisation. But the characteristics of nearly all series-wound dynamos show—at least for high speeds—a decided tendency to turn down after attaining a maximum; and in some machines, for example the older form of Brush with cast-iron ring (see Fig. 160), this reaction is very marked. The electromotive-force diminishes, but the magnetism of the field magnets does not. An explanation of this dip in the characteristic has lately been put forward by Dr. Hopkinson, in his lecture on “Electric Lighting,” before the Institution of Civil Engineers, attributing this to the reaction of self-induction and mutual induction between the sections of the armature. No doubt this cause contributes to the effect, as all such reactions diminish the effective electromotive-force. I am inclined, however, to think that the greater part of the effect is due to the shifting of the effective line of the field in consequence of the iron of the armature becoming saturated at a different rate from the iron

of the field magnets, and partly to the reaction of the cross-magnetisation. (See note, p. 72.)

It is at least significant that in the older form of Brush machine, where the reduction of electromotive-force is very great, there is also such a mass of iron in the armature, and so variable a lead at the brushes.

Theory of Angle of Lead.—A reference to Fig. 54, which represents the state of things when there is no current in the ring, shows that in the field between the ring and the pole-pieces the lines of force are nearly parallel and nearly uniform, with, however, a slight tendency to take a greater density near the outer extremities of the pole-pieces. Consider what will be the effect of inducing a current into the ring, thereby superimposing upon it the magnetisation which was shown in Fig. 63. The result, carefully thought out for a particular case, is shown by the lines of Fig. 64, where,

FIG. 64.

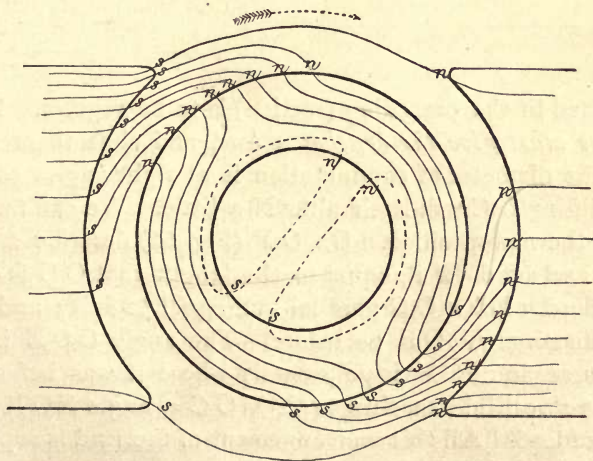

MAGNETIC REACTIONS BETWEEN FIELD MAGNETS AND ARMATURE IN GENERATOR.

however, a slight further development has been introduced. Suppose that at first the brushes were set to touch at two points on the vertical diameter. The field magnets tend to

magnetise the ring, so that its extreme left point is a N. pole, and the currents tend to magnetise it so that its highest point, where the brush is, is a N. pole. The consequence of this will be a resultant magnetisation in an oblique direction. Draw a line OF (Fig. 65) to represent the magnetising force due to the field magnets, and a line OC at right angles to represent the magnetising force due to the armature current, then the diagonal OR of the parallelogram will represent the direction of the resultant magnetisation. Draw a circle round O , and the point N will show how far the resultant induced pole is shifted round from the horizontal line. But the diameter of commutation where the brushes touch ought to be at right angles to the resultant poles in the ring, if the rise of potential round the commutator, as

FIG. 65.

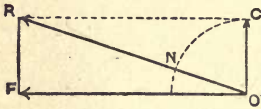
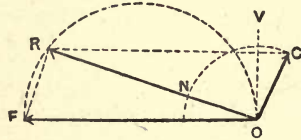

FIG. 66.



explained in the preceding (section) is to be regular. *Therefore we must give the brushes a lead*, and shift them round until the diameter of commutation is at right angles to ON . But shifting OC will itself alter N a little. We can find out easily the new position. On OF (Fig. 66) describe a semi-circle, and set off FR , equal to the length that OC is to be, as a chord. Draw OC parallel and equal to FR ; and draw also the diagonal OR as before. The angle CON is now a right angle, and N is very nearly where it was before. If OV be a vertical line, then angle $VO C =$ angle FOR is the angle of lead. All this rearrangement of the lead is supposed to have been done in Fig. 64.

But a reference to Fig. 64 will also show that the magnetism of the ring reacts on the magnetism of the pole-pieces. The lines of force in the iron of the left pole-piece are crowded up towards the top corner, and in the right pole-piece are crowded toward the bottom, as if the polarity had

been attracted upwards on one side and downwards on the other. The density of the field is completely changed from what it was in Fig. 54. The lines of force at the upper left side are crowded together and are twisted across. The resultant N. pole of the ring—marked n, n, n , where the lines of force emerge from the ring—attracts the S. pole—marked s, s, s , where the lines of force enter the field magnet—and the steam-engine which drives the dynamo has to do hard work in dragging the armature round against these attractions. The stronger the current in the armature the stronger will be the poles in the ring, and in the field magnets the stronger will be the attraction of n, n, n toward s, s, s , and the steam-engine must work still harder to keep up the speed. It will also be noticed in this figure that a *few* of the lines of force due to the current in the armature—two of them are shown dotted in the figure—leak across internally and contribute nothing to the external field. The oblique direction of this internal field marks the angle of lead of the brushes. It will be remarked that the innermost layers of iron of the ring are magnetised differently from the outermost, for the “ n ” pole of the outer layers of iron occupies a region lying obliquely on the left, while the “ n ” pole of the inner layers lies to the right of the highest point. All these phenomena—the shifting of the field—its concentration under the pole-piece—the weak internal field—the discrepancy between the positions of the induced poles on the inner and outer sides of the ring, can all be observed in an actual dynamo. Fig. 67 shows the pattern produced experimentally in iron filings by placing a magnetised ring between the poles $S N$ of a field magnet, which would tend to induce in it poles n', s' , and giving its own poles n, s , the proper lead. It should be compared with Figs. 54 and 64. It may perhaps be objected that in Fig. 64 the internal poles marked do not lie exactly at right angles to the external poles of the ring. Nor do they in actual dynamos. The position of the internal poles is determined by the lead given to the brushes, and *the brushes are so set that the diameter of commutation lies at right angles to the diameter in which the average density of the*

field is the greatest. This direction is not exactly opposite the induced external poles in the ring, because the induced poles in the ring are always a little in advance of the poles in the field magnets, and tend to be dragged back to them.

FIG. 67.

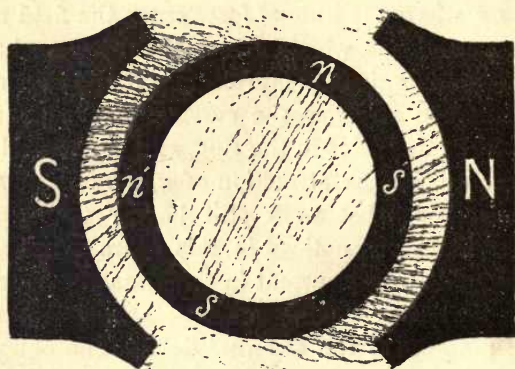

FIELD OF DYNAMO.

Returning for a moment to Fig. 66, it will be seen that if OF or RC represents the intensity of the magnetic force due to field magnets, and OC or FR that due to the armature current, then

$$\frac{OC}{RC} = \sin CRO = \sin FOR,$$

or the ratio of the two magnetic fields is proportional to the sine of the angle of lead—not to the tangent, as assumed by Breguet.

In the case of drum armatures, the phenomena, though of the same kind, are a little less easily traced. In consequence of the over-wrapping of the windings on the outside of the armature, the currents in some of the windings are partially neutralised in their magnetising effect on the core by those that lie across them, and consequently the polarity due to the current is not so well marked as with ring armatures. Neither can there be any internal field of any account. But, with these exceptions, the same considerations apply as those

we have traced out above. In fact drum armatures are less liable to induction troubles of all kinds than are ring-armatures.

That the obliquity of the diameter of commutation, and the resulting lead of the brushes is chiefly due to the obliquity of the effective magnetisation of the armature core, is finally demonstrated by the following facts. In those dynamos which are arranged to give a constant difference of potentials at the terminals, the current in the field magnet rises very nearly *pari passu* with the current in the armature, and the lead in such machines is very constant, whether the currents are large or small. Moreover, in these dynamos if (as is the case in all good modern machines) the magnetism induced by the field magnets in the armature core, is very much more powerful than that induced by the armature coils, there is practically no lead at all; for the cross-magnetisation being negligible, $\sin \text{FOR}$ (Fig. 66) will be = 0 and the angle of lead $\text{VOC} = 0^\circ$ also. On the other hand, in those dynamos which are designed to yield a constant current (for arc-light circuits), there ought on this theory to be, and is in fact, a considerable lead, and one which varies with the resistance introduced into the circuit. For OC is constant, whilst OF must vary very nearly in proportion to the resistance of the circuit. The author has therefore suggested that in a constant current dynamo, there should be an automatic arrangement, to continually adjust the angle of lead, so that its sine shall be proportional to the magnetism of the field magnet.

Causes of Sparking.—Sparking at the brushes is due to several causes, chiefest amongst them being defective adjustment of the brushes; long flashing sparks will inevitably be produced if the brushes are not set close to the neutral point. Hence the need of the adjustment mentioned on page 47. Another cause of sparking is want of symmetry in the winding of the armature: some of the older forms of the Siemens armature were defective in this respect. If the coils of one half of the armature are either more numerous or *nearer to the iron core*, on the average, than those of the other half, the two induced electromotive-forces in the two halves

of the armature will be unequal, and, consequently, at every revolution, the neutral points will shift first forward, then backward, giving rise to sparks. Jumping of the brushes when the collector is untrue, or when the brush-holders are defective, is another prolific cause of sparking.

Reactions due to Induction.—We have next to consider certain effects due to self-induction, and to mutual induction.

In the armature when at work, half the current flows *up* the coils on one half of the ring—say on the left—and the other half of the current flows *up* those in the other half of the ring on the right. If the brush is near the top, the current flows from left to right through the section on the left of the brush, and from right to left through the section that is on the right of the brush. But the section on the left of the brush is gliding round (to the right in almost all these diagrams), and will presently belong to the other half of the ring. It is clear then that as each section passes the brush the current in it is stopped and reversed. Of course, if things are properly arranged, it will itself not be actively inducing any current at the moment when it passes the brush, but it is receiving the current generated in the other sections. Moreover, there is just an instant when the two collector-bars, to which the ends of this section of the coil are connected, are *both* in contact with the brush; and therefore, just for an instant, this section of the coil will be short-circuited.

At the moment of being short-circuited the coil ought not to be cutting any lines of force. If, as in ring-armatures, there is an internal field (p. 71, bottom), then the true neutral point will be at such a point of the field that the algebraic sum of the lines of force which enter and leave the ring at that point is zero. Even if the induction at the moment of short-circuiting is zero, still short-circuiting produces a reaction.

We know that every electric current possesses a property sometimes called “electric inertia,” sometimes called “self-induction,” by virtue of which it tends to go on. Just as a fly-wheel once set in motion tends to go on spinning, so a current circulating round a coil tends to go on circulating, even

though the connexion with the source be cut off. True, the current lasts in most cases only for a small fraction of a second, but it *tends* to go on. It is also known that this quasi-inertia is connected with its magnetic properties (see the Introductory Remarks, p. 10), and that it is in its own magnetic field that this inertia of self-induction resides.

A current circulating round an iron core has a much greater electric inertia (or self-induction), because it has a more intense magnetic field, than one without an iron core. It requires an expenditure of energy to *start* a current because of this property; and that energy may be considerable. We know that—to return to a mechanical analogy—it requires much energy to set a heavy grindstone spinning; when once spinning it does not require much energy to keep it going, only enough in fact to overcome the friction of the pivots. Also, if we stop the spinning grindstone, say by holding a piece of wood against it as a “brake,” it will give up the energy that has been put into it and will manifest this energy in the form of heat. So also the electric current circulating in a coil possesses energy, and if we stop it by opening the circuit, that energy will show itself by a spark, the spark of the so-called (but mis-named) “extra-current.” If we short-circuit the coil, its current will also be stopped by the internal quasi-friction which we commonly call the “resistance” of the wire, and the wire will be heated. A frequent accident to dynamos is the burning of the insulation, or even the fusion of the wire of one section of the armature which has become short-circuited.

Spurious Resistance.—Now all these things clearly have a bearing on that which happens as the sections of the coils pass the brushes. In each section the current tends to go on, and in fact does actually go on for a brief time after the brush has been reached. Then the energy of the current in that section is wasted in heating the copper wire during the interval when it is short-circuited; and as it passes on, energy must again be spent in starting a current in it in the inverse direction. All these reactions are of course detrimental to the output of current by the dynamo: especially the loss in short-

circuiting. It has been shown by M. Joubert * that the loss of energy due to the mere reversals of the current in the sections of a ring armature is equal to $\frac{n L i_a^2}{4}$ per second, where n is

the number of revolutions per second, L the coefficient of self-induction for the entire ring, and i_a the armature current. Professors Ayrton and Perry have more recently pointed out † that the matter may be conveniently expressed in another way. Since the energy per second conveyed by a current running through a resistance r is equal to $r i^2$, it is evident that the energy lost per second by self-induction is the same as if there were an additional resistance ‡ in the armature of the value

$r = \frac{n L}{4}$. There is, therefore, in a rotating armature, an

apparent increase of resistance proportional to the speed, and this apparent increase, due to self-induction, cannot be got rid of by increasing the number of sections of the armature. It can be diminished in degree by using in the armature more iron and fewer turns of wire, in other words by diminishing the magnetic moment of the coil while giving the field magnet an increased advantage. The existence of an apparent resistance varying with the speed was first pointed out by M. Cabanellas.§

Eddy-Currents.—There are two other inductive reactions in the armature to be considered. In the iron of the armature cores, internal eddy-currents (the so-called “Foucault currents”) may be set up, absorbing energy and producing detrimental heat; and such currents may be even produced within the conductors which form the coil of the armature, if these are massive as are the bars in Edison’s dynamo.

* *Comptes Rendus*, June 23, 1880, March 5, 1883; and *L’Électricien*, April 1883.

† *Journ. Soc. Electr. Eng. and Electr.*, vol. xii., No. 49, 1883, where, however, the letters n and L are used in a slightly different sense.

‡ Professor O. J. Lodge has given the more accurate value of the spurious resistance as $r = n \frac{L}{4} + \frac{(\pi n L)^2}{8 R + 2 n L}$; see *Electrician*, July 31, 1885.

§ *Comptes Rendus*, January 9, 1882; see also Picou, *Manuel d’Électrométrie*, p. 123.

Frölich, in 1880,* pointed out the effect of the presence of these currents; and to them he attributed not only the otherwise unexplained deficit in the work transmitted electrically by a generator to a motor, but also the diminution in the effective magnetism (discussed above as a result of cross-magnetism, and found by Frölich to amount to 25 per cent. of the whole magnetism) observed with great currents and high speeds; and further he attributed to this cause the apparent increase in the number of "dead-turns" † at high speeds. Doubtless such currents exist, and the energy they waste will be nearly proportional to the square of the speed: but they may be indefinitely diminished by proper lamination, insulation, and disposition of the structures of the armature. The new laminated armature of the Brush Machine (Fig. 157), when used in place of the old solid armature (Fig. 156), was found to diminish greatly the number of dead turns, as well as not wasting so much energy in heating.

Effects of Mutual Induction.—Some forms of armature are peculiarly defective in the matter of being so constructed as to allow of much induction between neighbouring sections or parts of the coil, causing the rise of the current in one section to exert an opposing induction on a neighbouring section, and thereby, though not necessarily wasting any energy, making the machine act as if it were a smaller machine. The Bürgin armature, which has six or eight rings side by side on one spindle, suffers from induction between each section, and those belonging to the rings on the right and left of it: and it is only by a careful alternation of positions that this defect has been mitigated. In armatures of the Niaudet and Wallace-Farmer type each of the parallel coils acts inductively on its neighbour. Beyond doubt the armature with least of this defect is the Siemens (Altneck) drum armature as used in Siemens, Edison, and Weston machines. Clausius has shown ‡ that after a coil has been

* Berlin Academy, *Berichte*, Nov. 18, 1880, and *Elektrotechnische Zeitschrift*, vol. ii. p. 174, May 1881.

† See Appendix IV.

‡ Wiedemann's *Annalen*, Nov. and Dec. 1883, and *Phil. Mag.*, Jan. and Feb. 1884.

short-circuited on passing a brush, it exercises a deleterious inductive effect on the neighbouring coil in advance of it, and that this effect is proportional to the number of turns in the section. It can, therefore, be diminished by increasing the number of sections, thereby diminishing the number of turns of wire in any one section of the armature.

Lag due to Self-Induction.—This electric inertia of the current which circulates in the sections affects slightly the lead that must be given to the brushes, and it also reacts on the neighbouring coils. Whenever a coil is short-circuited, the sudden rush of its own current round itself tends by mutual induction to stop the current in the coil behind it, and to accelerate the inverse current in the coil in front of it. These actions are diminished by increasing the number of sections and making the individual sections consequently smaller. The self-induction even extends to the iron of the cores. In every particle of the iron at the moment when it arrives at the position where its magnetism must be reversed, an internal current is set up which retards the reversal of the magnetism and makes it *apparently* lag in its magnetisation, as well as grow hot. This effect can also be diminished by properly laminating the core and arranging it so that its magnetism is reversed gradually instead of suddenly. Niaudet's armature, Fig. 175, is essentially defective from this latter point of view.

Induction is of enormous importance in alternate-current machines; and indeed everywhere, throughout dynamos in general, but we cannot dwell longer on its effects at this point.

Remedy for Induction Troubles.—There is one way, and one way only, of diminishing these deleterious reactions: and happily that way is a very simple one. It is shown in Chapter XII. that the electromotive-force of the dynamo is proportional to three things, the speed n , the average intensity of the magnetic field H , and the "equivalent total area" A of the armature coils. Now this latter term is proportional to the number of turns of wire in the armature; and therefore for a given size of armature, the inductive reactions are also proportional to A . If we can decrease A while increasing either of the other

terms, we may thereby decrease the deleterious reactions and yet keep the same electromotive-force as before. Now it is inconvenient to increase the speed, and moreover some of the deleterious reactions, mechanical (such as friction) as well as electrical, increase when the speed increases. The only way then is to increase H , the intensity of the magnetic field. This can be done by having enormously strong field magnets which will entirely overpower the armature. If the field magnets are large, and of wrought iron, and if there is plenty of iron in the armature core, then, without increasing the speed, we may get the same electromotive-force while using fewer turns of wire in the armature. The ideal dynamo of the future has but one turn of wire to each section. It will have practically no lead at the brushes, will not spark, and its internal resistance will be practically *nil*.

Heating of Cores.—It is impossible to prevent the cores of armatures from heating; and this is in every case detrimental to the action of the dynamo. Hot iron has a lower magnetic susceptibility than cold iron, and therefore requires a greater expenditure of current to magnetise it to an equal degree. This causes the output and efficiency of a dynamo to be less when hot than when cool. To say nothing of the risks of destruction by overheating, this is an additional reason for so designing dynamos as to secure proper ventilation of armatures.

Heating of Magnets.—All field magnets are liable to heat: the cores by reason of eddy-currents induced in them, the coils because even the purest copper offers resistance. The amount of heat developed per second in a coil is the product of the resistance into the square of the strength of the current. To avoid waste, therefore, no unnecessary resistance should be introduced into the coil. It is easy to show that with a coil of *given volume*, the heat-waste is the same for the same magnetising power, no matter whether the coil consist of few windings of thick wire or many windings of thin wire. The heat per second is $i^2 r$, and the magnetising power is $S i$; i being the current, r the resistance, and S the number of turns. But r varies as the square of S , if the volume occupied

by the coils is constant : for suppose we double the number of coils, and halve the cross-sectional area of the wire. Each foot of the thinner wire will offer twice as much resistance as before ; and there are twice as many feet of wire. The resistance is quadrupled therefore. The heat is then proportional to $i^2 S^2$: and therefore the heat is proportional to the square of the magnetising power. If, therefore, we apply the same magnetising power by means of the coil, the heat-waste is the same, however the coil is wound. To magnetise the field magnets of a dynamo to the same degree of intensity requires the same expenditure of electric energy, whether they are series-wound or shunt-wound, provided the volume is the same. But if the *volume* of the coil (and the weight of copper in it) may be increased, then the heat-waste may be proportionally lessened. For example, suppose a shunt coil of resistance r has Z turns, if we wind on another Z turns in addition, the magnetising power will remain nearly the same, though the current will be cut down to one-half owing to the doubling of the resistance ; and the heat loss will be halved, for $2 r \times (\frac{1}{2} i)^2$ will be $\frac{1}{2} i^2 r$. In fact one ought to wind on so much copper wire that the annual interest on the prime cost is exactly equal to the annual cost of the electric energy spent in the inevitable heating. This law is not quite exact, because the outermost turns do not produce a magnetising effect equal to that of the turns that are nearer the iron. It is also assumed in the foregoing argument that we get double the number of turns on if we halve the sectional area of the copper wire. This is not quite true, because the thickness of the insulating covering bears a greater ratio to the diameter of the wire for wires of small gauge than for wires of large gauge. In designing dynamos, moreover, one ought to be guided by the question of economy, not by the accident of there being only a certain volume left for winding. If there is insufficient space round the cores to wind on the amount of wire that economy dictates, new cores should be prepared having a sufficient length to receive the wire which is economically appropriate.

But there is another cause of heating in field-magnet

cores. Whenever, either from a change in the strength of the exciting current, or from a change in the reactive influence of the armature, any variation in the magnetisation of the core occurs, such variation is inevitably accompanied by a generation of internal induced currents. Every one knows how, in the ordinary induction-coil, the changes of magnetisation of the core induce transient currents in the secondary wire. The same is true of dynamos; any change in the magnetism arouses transient currents in the surrounding coil (which acts both as primary and secondary), or in the core, or in both. If the core is solid it heats. Ought we then to laminate the entire structure, or build our field magnets of bundles of iron wire? If we do they will certainly heat less, but any changes in their magnetisation that occur, will occur much more suddenly; the momentary extra-currents induced in the external coils will be fiercer and more dangerous. The necessity for keeping the magnetism of the field magnets steady, dictates solidity (p. 36). In certain cases (p. 180) a copper envelope is purposely placed around field-magnet cores to absorb the induced extra-currents that arise from variations in the magnetism of the core. They add, electrically speaking, to the stability of the field magnets, for the induced extra-currents always circulate in such a sense as to oppose the change of magnetisation which gives rise to them.

Heating in Pole-pieces.—If the masses of iron in the armature are so disposed that as it rotates, the distribution of the lines of force in the narrow field between the armature and the pole-piece is being continually altered, then, even though the total amount of magnetism of the field magnet remains unchanged, eddy-currents will be set up in the pole-piece and will heat it. This is shown by Figs. 68 to 72, which represent the effect of a projecting tooth, such as that of a Pacinotti ring, in changing the distribution of the magnetism of the pole-piece. Figs. 71 and 72 (corresponding respectively to Figs. 69 and 70) show the eddy-currents, grouped in pairs of vortices. The strongest current flows between the vortices and is situated just below the projecting tooth, where the magnetism is most intense; it moves onward following the

tooth. Fig. 73 shows what occurs during the final retreat of the tooth from the pole-piece. These eddy-currents penetrate into the interior of the iron, although to no great depth. Clearly the greatest amount of such eddy-currents will be generated at that part of the pole-piece where the magnetic perturbations are greatest and most sudden. A

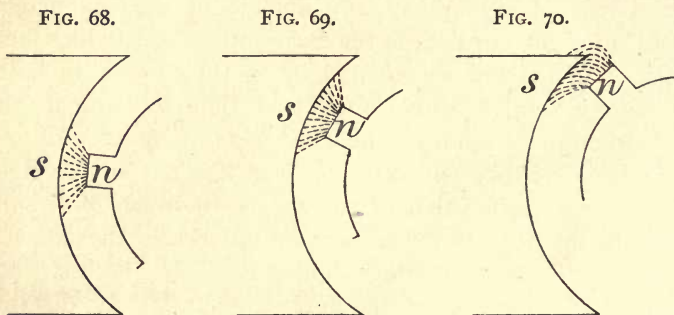

ALTERATION OF MAGNETIC FIELD DUE TO MOVEMENT OF MASS OF IRON IN ARMATURE.

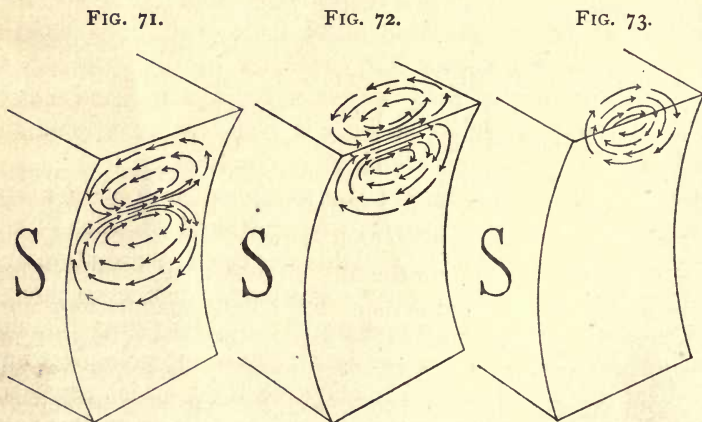

EDDY-CURRENTS INDUCED IN POLE-PIECES BY MOVEMENT OF MASSES OF IRON.

glance at Figs. 64, 67, 72 and 73, will at once tell us that this should be at the leading corner or "horn" of the pole-piece of the generating dynamo. As a matter of fact, when any dynamo which has horned pole-pieces (such as the Gramme)

has been running for some time as a generator this is found to be the case. The leading horns a and c , of Fig. 74, are

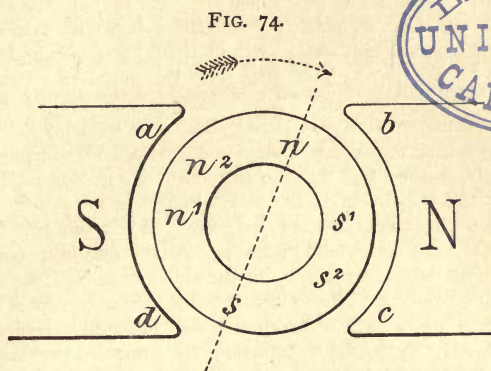

found to be hot, whilst the following horns b and d are found to be comparatively cool. When the dynamo is used as a motor, the reverse is found to be the case: the leading horns a and c are cool, the following horns b and d are hot. A reference to the magnetic field of the motor, as drawn in Chap. XXIII., will explain the latter case.

Closely connected with this effect is another, first pointed out to the author by M. Cabanellas. A Gramme magneto machine with permanent magnets is observed to lose power during its use as a motor; the field magnets decrease in strength. If, then, it is used as a generator, the field magnets regain their magnetism. This seems at first sight impossible, because the magnetic fields respectively due to the field magnet and to the armature help one another in the motor (Chap. XXIII.), whilst they oppose one another's actions (p. 74) in the generator. The effect is explicable* when the magnetising effect of the eddy-currents is taken into consideration.

* The following explanation was given by the author at the International Conference of Electricians at Philadelphia 1884 (see report in *Electrical Review*, Dec. 13, 1884). "To explain these facts, and their mutual relation, I must relate one other observation which I have made, and which connects both sets of facts. . . . Suppose you take a horse-shoe magnet, having the usual armature or 'keeper' of iron. You can purchase such an instrument of any optician,

who will probably give you instructions never to pull the armature off suddenly for fear you injure the magnetism. He could not possibly give you worse directions. Take such a magnet and try what the effect really is. Fasten it down upon a board with brass screws, and fix a magnetometer near it—a common compass will answer—and notice how much the magnet pulls the needle round. Then put on the armature, by placing it at the bend of the magnet; draw it slowly to its usual position, and suddenly drag it off. You will find that by this action your magnet will have grown stronger. Do this twenty times, and you will make it considerably stronger. I have made a magnet 1·2 per cent. stronger by putting on the armature very gently and pulling it off suddenly. If you reverse the operation, by letting the armature slam suddenly against the poles and then detaching it gently, you will find that the magnetism will go down. I have made magnets lose 1·3 to 2·1 per cent. in this way. Why does this occur? How does it explain the two phenomena noticed just now? If you suddenly take away a piece of iron from a magnet, you do work against the magnetic attraction, and the induced currents which are set up in the iron or steel of the magnet are always (as we know from Lenz's Law) in such a direction as to oppose the motion; that is to say, they are in such a direction as will make the magnet pull more strongly than before. By suddenly detaching the armature, we magnetise the magnet more strongly than before, by means of currents circulating within its own mass and within the mass of the armature. In the reverse motion, when you allow the armature to slam up, there are induced currents which are in such a direction as to oppose the motion of slamming; they, therefore, decrease the magnetism of the magnet. Apply this to the dynamo and to the motor. You magnetise more highly by pulling off the armature. That is precisely what is occurring in the field when the machine is being used as a generator. You are dragging away the armature from the active horn *a* of the pole-piece, and the effect is to generate induced currents in that horn. It therefore gets hot. So does the other leading horn *c*, for the very same reason. In the case of the motor the horns *b* and *d* are the active ones, and the armature is being continually dragged up toward them, and they get hot from internally induced currents. It is for this reason that in my Cantor Lectures (and also p. 40, *ante*) I recommended that pole-pieces should always be laminated. The presence of these induced currents explains the heating effect, and it also explains how it is that when a magneto machine is used as a motor the magnet is weakened, and when used as a generator the magnet is strengthened.

CHAPTER VI.

GOVERNMENT OF DYNAMOS.

Methods of Exciting the Field Magnetism.

THE four simple methods of exciting the magnetism of the field in which the armatures revolve, have already been alluded to at the outset of this work ; but nothing has been said about the advantages or disadvantages of the four systems, or about the combinations of these methods.

Magneto-dynamo.—The magneto-dynamos (Fig. 4, p. 4) have the advantage, in theory at least, that their electromotive-force is (for equal currents) very nearly exactly proportional to the velocity of rotation ; though, of course, the difference of potential between the terminals of the machine will vary with any variation in the resistance of the external circuit. They possess the disadvantage that, since steel cannot be permanently magnetised to the same degree as that which soft iron can temporarily attain, they are not so powerful as other dynamos of equal size.

Separately-excited Dynamo.—The separately-excited dynamo (Fig. 3, p. 3) has the same advantage as the magneto machine, its electromotive-force being independent of accidental changes of resistance in the working circuit, but it is more powerful. It has, moreover, the further advantage that the strength of the field is under control. For by varying either the electromotive-force or the resistance in the exciting circuit, the strength of the magnetic field is varied at will. It has the disadvantage of requiring a separate exciting machine.

Series Dynamo.—The ordinary, or series dynamo (Fig. 1, p. 2), is usually a cheaper machine, for equal power, than any of the other forms, as its coils are simpler to make than those

of a shunt machine, and it wants no auxiliary exciter. It has the disadvantages of not starting action until a certain speed has been attained, or unless the resistance of the circuit is below a certain limit. It is also liable to become reversed in polarity, a serious disadvantage when this machine is applied for electro-plating or for charging accumulators.

Any increase of the resistance in the circuit of the series-wound machine lessens its power to supply current because it diminishes the current in the coils of the field magnet, and therefore diminishes also the strength of the magnetic field. Hence the series dynamo is theoretically better adapted for use with lamps arranged in parallel arc than for lamps in series. An additional lamp switched in, if the lamps are in series as on a "Brush" circuit, adds to the resistance of the circuit, and diminishes the power of the machine to supply current. While, on the other hand, an additional lamp in parallel reduces the total resistance offered by the network of the circuit, causes the total current to increase, and adds to the power of the machine to provide the needed current. It is easy to regulate the currents given by a series dynamo, by introducing a shunt of variable resistance across the field magnet, thus altering the magnetising influence of the current.

Shunt Dynamo.—The shunt dynamo (Fig. 2, p. 2) has several advantages over other forms. It is less liable to reverse its polarity than the series dynamo. Formerly it was considered as providing the magnetising power to the magnets with less waste of current.* For a set of lamps in series, the power of a shunt dynamo to supply the needful current increases with the demands of the circuit, since any added resistance sends additional current round the shunt in which the field magnets are placed, and so makes the magnetic field more intense. On the other hand, there is a greater sensitiveness to inequalities of driving in consequence of the great self-

* This opinion has no good foundation, however, for it requires the same expenditure of electric energy to magnetise an electro-magnet to the same degree, whether the coil consist of many turns of thin wire or of a few turns of thick wire, provided the *volume* occupied by the coil be alike in the two cases, and provided the insulation is relatively of same thickness.

induction in the shunt. As previously pointed out, when there are sudden changes in the electromotive-force acting in a complex circuit, the momentary currents thus set up do not distribute themselves in the various parts of the circuit in the simple inverse ratio of the resistances, for their distribution depends also, and in some cases chiefly, upon the self-induction in the various parts. As previously explained (p. 79) self-induction is an effect like inertia. It is more difficult to set up a sudden current in a circuit whose self-induction is great (or which, for example, consists of many turns wound closely together, so that they exercise great inductive action on each other, especially if they be wound about an iron core) than in one in which the self-induction is small. We cannot here follow further the mathematical law of the action of self-induction on momentary changes of electromotive-force; but the application to the shunt-wound dynamo is too important to be passed over.

The shunt part of the circuit in the present case consists of a fine wire of many turns wound upon iron cores. It therefore has a much higher coefficient of self-induction than the rest of the circuit; and, consequently, any sudden variations in the speed of driving cannot but affect the current in the main circuit more than in the shunt. Briefly, the shunt-winding, though it steadies the current against perturbations due to changes of resistance in the circuit, does not steady the current against perturbations due to changes in speed of driving. In the series-wound dynamo, the converse holds good. Any of these systems may be applied in direct-current machines. For alternate-current machines, the two first methods only are applicable. Each of these four systems of exciting the field magnetism has its own merits for special cases, but none of them is perfect. Not one of these methods will insure that, with a uniform speed of driving, either the potential at the terminals or the current shall be constant, however the resistances of the circuit are altered.

But though theory tells us that none of these systems is perfect, theory does not leave us without a guide. Thanks to M. Marcel Deprez, to Professor Perry, to Mr. Paget Higgs,

to Mr. Bosanquet, to Messrs. Crompton and Kapp, to Herr Schuckert, to Messrs. Watson and Mordey and others, we have been taught how to combine these methods so as to secure in practice a machine which shall, when driven at a constant speed, give either a constant potential or a constant current. These methods are carefully developed in the chapter on the Algebraic Theory. They will be described here also so as to complete our summary of the organs of dynamos.

Combination Methods.

The discovery of the method of rendering a dynamo machine automatically self-regulating when driven at a uniform speed, is due to M. Marcel Deprez, and is a result arising from the study of the diagrams of the characteristic curves of dynamos.* There are two distinct cases for which self-regulation is required.

As the first function of a dynamo in practice is to feed with sufficiency and regularity a system of lamps, and as those lamps are always† in practice arranged either in parallel or in series, it is clear that in the former case *a constant difference of potentials*, and in the latter *a constant current* between the mains, is required.

Suppose a dynamo to have an armature without internal resistance, and to have its field magnets excited from some independent constant source. At a constant speed it would give a constant potential at its terminals whatever the resistance in the circuit. But if it had internal resistance, the external potential will be less than the whole electromotive-force, and the discrepancy will be greater according as the internal resistance and the current are greater. Any resistance-less, separately-excited, or shunt dynamo would thus be self-regulating.

* See *La Lumière Électrique*, December 3, 1881, and Jan. 5, 1884.

† I am aware that occasionally incandescent lamps have been arranged with two or three lamps, in series, in each parallel, or on a multiple series plan. I am not aware of any such arrangement having been satisfactory. The Savoy Theatre appears to be an exception.

Now it is, we know, impossible to have an armature of no resistance. But if, knowing the resistance of the armature of our dynamo, we find out what additional magnetising power is necessary to increase the working electromotive-force of the dynamo, so that the nett electromotive-force (after discounting the part needed to overcome the internal resistance) shall be constant, and then, having found it out, provide for this variable part of the magnetisation by putting on coils in series, our dynamo thus reinforced will act as if it had no internal resistance, and will give, within certain limits, a constant difference of potentials at its terminals.

On the other hand, if a shunt dynamo were constructed with an armature of considerable resistance, the electromotive-force which it would develop at a constant speed, would be nearly proportional to the external resistance, for doubling the external resistance would very nearly double the proportion of current thrown round the shunt, and therefore (always assuming the iron cores to be far from saturation) the magnetism of the field magnet would be doubled; in other words there would be an approximately constant current.* In this case, a high internal resistance in the armature would not be economical. But if we ascertain the internal resistance of the shunt dynamo, and make a similar calculation as to the amount of additional electromotive-force requisite in order that there shall always be enough current for the shunt circuit over and above that current which goes to the external circuit; and if we provide from some external constant source for this additional electromotive-force, either directly or by adding to the magnetisation, then the shunt dynamo so aided will give a constant current in the external circuit, no matter how great or how small the resistance of the circuit may be.

* In the first edition of this work it was not adequately explained at this point, as it is in Chapter XVII. fully, how the conditions for obtaining either a constant potential or a constant current are related to the winding of the coils, and to the various resistances of the machine and circuit. These rules admit, as yet, of no practical solution for constant-current work. Brush lamps are always in series, and want constant current; yet no Brush machines are shunt-wound, and the expense of the fine wire, for winding the shunts would probably be prohibitive: there would have to be nearly a mile of wire for every lamp supplied! For constant-current work other modes of regulation have been used. See p. 105.

For distribution *at a constant potential*, we must have, therefore, combinations of a *series* dynamo with some auxiliary independent constant excitement.

For distribution *with a constant current*, we must have combinations of a *shunt* dynamo with some auxiliary independent constant excitement.

Combinations to give Constant Potential.

(1.) *Series and Separate (Deprez).*—This method, illustrated in Fig. 75, can be applied to any ordinary dynamo, provided the coils are such that a separate current from an

FIG. 75.

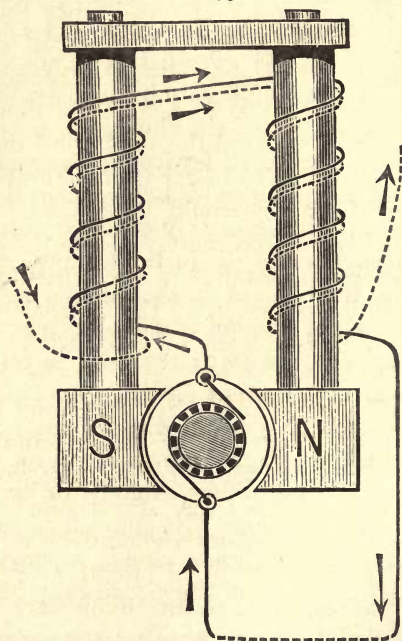

COMBINATION OF SERIES AND SEPARATE.

independent source can be passed through a part of them, so that there shall be an initial magnetic field, independent of the main-circuit current of the dynamo. When the machine is running, the electromotive-force producing the current will

depend partly on this independent excitement, partly on the current's own excitement of the field magnets. If the machine be run at such a speed that the quotient of the part of the electromotive-force due to the self-excitement, divided by the strength of the current, is numerically equal to the internal resistance of the machine, then the electromotive-force in the circuit will be constant, however the external resistances are varied. M. Deprez has further shown that this velocity can be deduced from experiment, and that, when the critical velocity has once been determined, the machine can be adjusted to work at any desired electromotive-force by varying the strength of the separately-exciting current to the desired degree.

(2.) *Series and Magneto (Perry)*.—The initial electromotive-force in the circuit required by Deprez's theory, need not necessarily consist in there being an initial magnetic field of independent origin. It is true that the addition of a permanent magnet, to give an initial partial magnetisation to the pole-pieces of the field magnets, would meet the case to a certain extent; but Professor Perry has adopted the more general solution of introducing into the circuit of a series dynamo a separate magneto machine, also driven at a uniform speed, such that it produces in the circuit a constant electromotive-force equal to that which it is desired should exist between the leading and return mains.*

* Professor Perry gives, in his specification, the following numerical illustration, to which the only exception that can be taken is, that with so high a resistance as that of 3 ohms in the machine the system must be very uneconomical: "As an example, if there is only one dynamo machine, and if the resistance of the main cable, return cable, and machines, in fact of that part of the total circuit which is supposed to be constant, be, let us suppose, 3 ohms, then we find that the dynamo machine ought to be run at such a speed that the electromotive-force, in volts, produced in its moving parts, is three times the current, in ampères, which flows through the field magnets; consequently this speed can readily be found by experiment. Suppose the constant electromotive-force of the magneto machine to be 50 volts, its resistance 0.3 ohms, and the resistance of the dynamo machine and of the other unchanging parts of the circuit 2.7 ohms; and suppose that the speed is that at which the electromotive-force produced by the rotating armature of the dynamo is three times the current. Now, let there be a consumers' resistance of 2 ohms, the total resistance is 5 ohms. Evidently the electromotive-force produced in the dynamo is 75 volts (for call this electromotive-force x , then the current will be $x \div 3$, whence it

This arrangement, which is depicted in Fig. 76,* may be varied by using a shunt-wound dynamo, the magnets being,

FIG. 76.

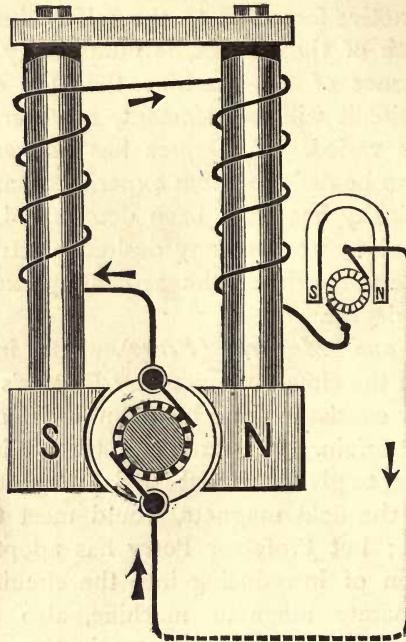

SERIES AND MAGNETO.

follows that $\frac{x + 50}{5} = \frac{x}{3}$, or $3x + 150 = 5x$, or $x = 75$, and the total electromotive-force in the circuit is, therefore, 125 volts, and as the total resistance is 5 ohms, the current is 25 ampères, giving an electromotive-force of 50 volts between the ends of the consumers' part of the circuit. Now, if the consumers' resistance increases to, say, 12 ohms, by some of the consumers ceasing to use their circuits, there is an instantaneous alteration of the electromotive-force produced in the dynamo to $12\frac{1}{2}$ volts, or $62\frac{1}{2}$ volts in the whole circuit, and $62\frac{1}{2}$ divided by 15 gives $4\frac{1}{6}$ ampères; and this means $4\frac{1}{6}$ multiplied by 12 or 50 volts as before, between the ends of the consumers' part of the circuit." (Here, again, the calculation is $\frac{x + 50}{15} = \frac{x}{3}$, whence $3x + 150 = 15x$, or $12\frac{1}{2} = x$.—S.P.T.)

* Some exception has been taken by Professors Ayrton and Perry to this figure on the ground that the magneto-machine is drawn relatively too small. It was not intended that the figure should represent the sizes, but rather to indicate that the arrangement was essentially one of a *series* dynamo, plus an auxiliary independent excitement. So also with Fig. 80. The reader should refer to Professor Ayrton's lecture at the London Institution, Feb. 23, 1883, of which an abstract is given in *The Electrician*, March 10, 1883.

as before, included in the part of the circuit outside the machines. The combination of a permanent magnet with electro-magnets in one and the same machine, is much older than the suggestions of either Deprez or Perry, having been described by Hjörth in 1854.

(3.) *Series and Shunt (Brush).*—A dynamo having its coils wound, as in Fig. 77, so that the field magnets are excited

FIG. 77.

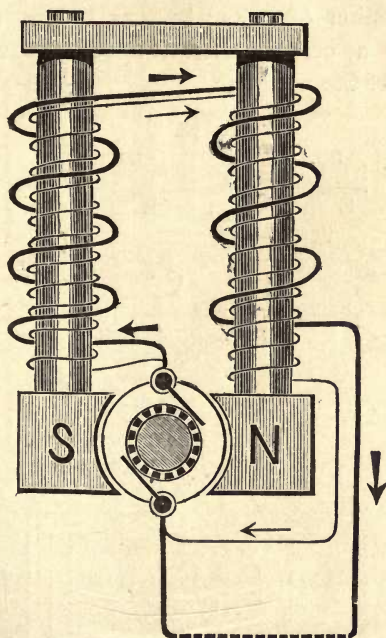

SERIES AND SHUNT.

partly by the main current, partly by a current shunted across the brushes of the machine, is no novelty, having been used in Brush dynamos* for some years past. The arrangement as used originally by Brush made the machine into one

* The shunt part of the circuit, originally called the "teazer," was adopted at first in machines for electro-plating, with the view of preventing a reversal of the current by an inversion of the magnetisation of the field magnets, but has been retained in some other patterns of machine on account of its usefulness in "steadying" the current. Messrs. Siemens Bros., Messrs. Crompton and Co., and many other firms have used this combination with great success for some years past.

that was very nearly self-regulating, there being less than one volt of variation in the potential within a wide range of current. If the shunt coils be comparatively few, and of high resistance, so that their magnetising power is small, the machine will give approximately a uniform potential of but few volts ; whereas, if the shunt be relatively a powerful magnetiser, as compared with the few coils of the main circuit, the machine will be adapted for giving a constant potential of a great number of volts ; but, as before, each case will correspond to a certain critical speed, depending on the arrangements of the machine.

FIG. 78.

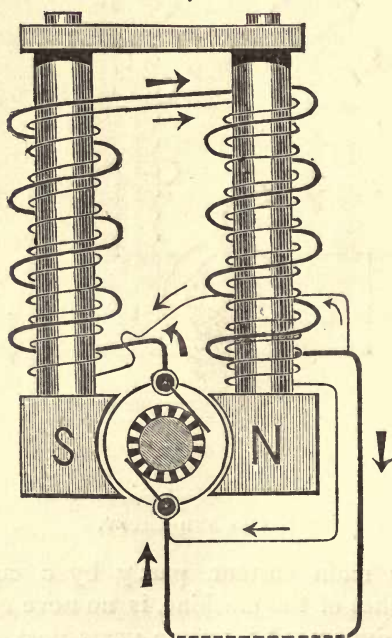

SERIES AND LONG SHUNT.

(4.) *Series and Long Shunt.*—In 1882 the author proposed to give this name to a combination closely resembling the preceding, which had not then, so far as he was aware, been actually tried for this purpose, though it had been, like the preceding, described by Brush. If, as in Fig. 78, the magnets

are excited partly in series, but also partly by coils of finer wire, connected as a shunt *across the whole external circuit*, then the combination should be more applicable than the preceding to the case of a constant electromotive-force, since any variation in the resistance of the external circuit will produce a greater effect in the "long shunt" than would be produced if the resistance of the field magnets were included in the part of the main circuit external to the shunt.

In 1882 it was the author's opinion that although the last two combinations were not such perfect solutions of the problem as those which precede, they were more likely to find an immediate application,* since they can be put into practice upon any ordinary machine, and do not require, as in the first two combinations, the use of separate exciters, or of independent magneto machines. This opinion has been fully justified in the great progress made since in the "compound" or "self-regulating" machines.

Combinations to give Constant Current.

(1.) *Shunt and Separate (Deprez).*—When it is desired, as in the case of a set of arc lamps in series, to maintain the current in the circuit at one constant strength, the previous arrangement of Deprez must be modified, as indicated in Fig. 79, by combining a shunt-winding with coils for a separately-exciting current. This arrangement is, in fact, that of a shunt dynamo, with an initial magnetic field independent of the strength of the current in the circuit.

Seeing that the only object in providing the coils for

* The invention of the "series and shunt" winding is claimed for several rivals. Brush undoubtedly first used it, but whether with any knowledge of all its advantages is doubtful. It was, however, mentioned as having some advantages by Alexander Siemens in *Journ. Soc. Telegr. Eng.*, April 1880. It is also claimed for Lauckert (see note by M. Boistel, p. 100 of his translation of this work); Paget Higgs (*Electrical Review*, vol. xi. p. 280, and *Electrician*, Dec. 23, 1882); J. W. Swan, see Bosanquet (*ib.*, Dec. 9, 1882); J. Swinburne (*ib.*, Dec. 23, 1882); S. Schuckert (*ib.*, Oct. 13, 1883); it is claimed in America by Edison; and it has been patented by Messrs. Crompton and Kapp (*ib.*, June 9, 1883). See also Hospitalier (*L'Électricien*, No. 20, 1882). Students should also consult a series of articles in *The Electrician*, vol. x., beginning Dec. 16, 1882, by Mr. Gisbert Kapp.

separate excitation is to secure an initial and independent magnetic field, it is clear that other means may be employed to bring about a similar result.

FIG. 79.

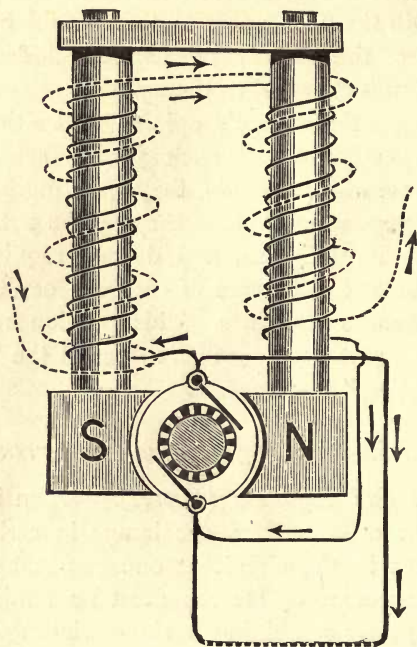

SHUNT AND SEPARATE.

(2.) *Shunt and Magneto (Perry).*—Perry's arrangement for constant current is given in diagram in Fig. 80, and consists in combining a shunt dynamo with a magneto machine of independent electromotive-force, this magneto machine being inserted either in the armature part or in the magnet-shunt part of the machine. As before, a certain critical speed must, on Professor Perry's plan, be found from experiment and calculation. In the chapter on Algebraic Theory, I have given, as a deduction from the equations, a practical method of ascertaining the necessary winding to be adopted when the speed is given beforehand.

(3.) *Shunt and Series.*—There are, as mentioned above, a

great many claimants to the discovery of the use of the "compound winding" for the purpose of obtaining a constant potential, but the use of the compound winding for the purpose of obtaining a constant current was first described by the author of this book in his Cantor Lectures in December 1882, in the paragraph reprinted above, which states that for this purpose, the essential part of the magnetisation will be that due to the shunt coils. The theory of this winding in both

FIG. 80.

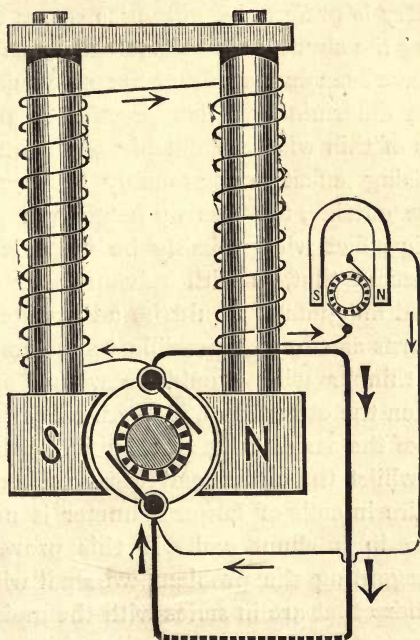

SHUNT AND MAGNETO.

its varieties is given for the first time in this book on pp. 320 to 322, and the practical method for ascertaining the right number of coils is briefly described on p. 322.

Arrangements of Compound Winding.

Compound windings may be arranged in several different ways. If wound on the same core the shunt coils are sometimes wound outside the series coils : less frequently the series

coils are outside the shunt. In some of Siemens' dynamos they are wound on separate frames and slipped on side by side over the same core. In other cases, where (as in Siemens' usual patterns) the pole is at the middle of the magnet core, one end of the core may carry the shunt coils, the other the series; or both the coils on one of the cores may be series coils, and both those on the other, shunt coils. Mr. P. Higgs strongly advocates the winding of the two sets on separate cores uniting at a common pole-piece. On the whole, symmetry is preferable. Practice seems to be drifting toward winding the shunt coils outside the series coils.

It might have been expected that theory would have something to say in determining which practice is preferable. If the shunt coils of thin wire are outside, the prime cost for an equal magnetising effect will probably be greater. If the series coils are outside, the loss by heating in producing an equal magnetic effect will probably be increased. It might have been expected that, as with galvanometer coils, so with the coils of field magnets, it would be advantageous to get as many of the turns as close as possible to the core, and therefore that the thinner wire should be wound on before the thicker. But, on the other hand, it is advisable to keep down the resistance of the series coils, as they will form part of the main circuit; whilst the additional resistance necessitated by winding the wire in coils of larger diameter is not altogether a disadvantage in a shunt coil. If this proves to be the right way of regarding the problem, we shall wind the shunt coils outside those that are in series with the main circuit.

Theory gives us, however, one further clue. In machines designed for yielding a constant potential the excitement due to the shunt coils is (or should be) constant, whilst that due to the series coils should vary promptly and proportionately to the demands of the load of lamps in circuit. Following out the principle laid down on page 41, we should then wind the series coil close to the poles where they will be most advantageously placed for producing changes in the magnetisation, whilst the shunt coils should be wound nearer the yokes of the magnets.

The method of compound winding, though theoretically applicable to constant-current machines as well as to those for constant-potential, is less practicable in the former case in consequence of the cost. For constant-current work, other methods of governing are employed.

Other Methods of Automatic Regulation.

Brush's Automatic Regulator.—An ordinary series dynamo may be made to yield a constant current by introducing across the field magnets a shunt of variable resistance, the resistance of the shunt being adjusted automatically by an electro-magnet whose coils form part of the circuit. The system is shown in the accompanying diagram (Fig. 81).

FIG. 81.

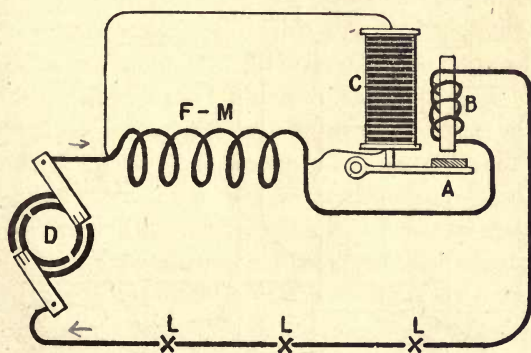

BRUSH'S AUTOMATIC REGULATOR.

The dynamo at D pours its current into the circuit, leaving the commutator (as drawn) by the upper brush, whence it flows through the field magnets F M, and round the circuit of lamps L L, back to the negative terminal. Suppose now some of the lamps to be extinguished by switches which short-circuit them; the resistance of the circuit being thus diminished there will be at once a tendency for the current to increase above its normal value unless the electromotive-force of the dynamo is at once correspondingly reduced. This is done by the solenoid B in the circuit. When

traversed by the normal circuit it attracts its armature A with a certain force just sufficient to keep it in its neutral position. If the current increases, the armature is drawn upward and causes a lever to compress a column of retort-carbon plates C, which is connected as a shunt to the field magnets. These plates when pressed together conduct well, but when the pressure is diminished their imperfect contact partially interrupts the shunt-circuit and increases its resistance. When A rises and compresses C, the current is diverted to a greater or lesser extent from the field magnets which are thus under control.

Edison's Regulator.—In Edison's system for supplying mains at a constant potential a shunt-dynamo is employed, a variable resistance R being introduced into the shunt-circuit (Fig. 82). A lever moved by hand, whenever the

FIG. 82.

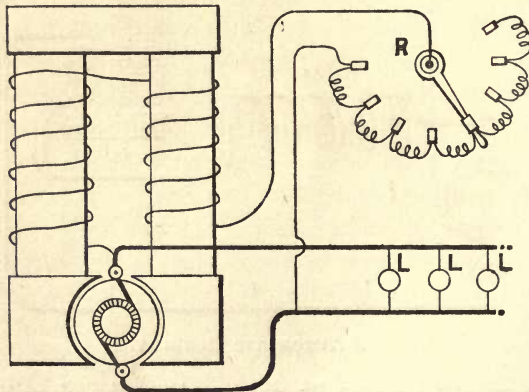

EDISON'S SYSTEM OF REGULATING.

potential rises or falls below its proper value, makes contact on a number of studs connected with a set of resistances, and thus controls the degree of excitation of the field magnets. A similar device has been used in several other systems. To make the arrangement perfect the variable resistance should be automatically adjusted by an electromagnet whose coils are an independent shunt across the mains. Edison has indeed used such a device.

Lane-Fox's Automatic Regulator.—A relay, the coil of which itself forms a shunt to the mains, is employed to actuate a regulator to introduce more or less resistance into the shunt-circuit of the dynamo. Fig. ¹²⁰148, p. ¹⁴⁵143, shows a form of the regulator as modified for use with the Victoria dynamo in the system of the Anglo-American Brush Corporation. The relay, shown in the upper part of the figure, consists of a solenoid having a core suspended from a spring. The regulator which stands on the right contains two columns of carbon-plates which can be more or less compressed by turning a wheel concealed in the base of the instrument. This wheel can be turned in either direction by bevelled driving gear actuated by an external pulley which is kept running by a light band from the axle of the dynamo. Two electro-magnets, also enclosed in the base of the regulator, actuate armatures which throw one or other of the bevelled drivers into gear. These electro-magnets are so arranged that a branch current is thrown into one or other of them by the relay. If the potential of the mains falls by reason of more lamps being switched in, the attraction of the solenoid of the relay diminishes and the core is raised by the spring above its normal position. The tongue of the relay rises and makes contact for one of the two electro-magnets in the regulator, which immediately throws the driving gear into action and compresses the carbons. As the carbons form part of the exciting circuit of the dynamo, more current immediately flows round the field magnets, thus bringing up the potential of the mains to its proper value.

Automatic Regulation by shifting the Brushes.—Several systems have been proposed for securing automatic regulation by shifting the brushes round the collector. Reference to the curve of potentials (Fig. 42), will show that if the brushes do not touch at the neutral points (marked + and -) the difference of potentials between them will be less than the maximum which the armature can give. Maxim prepared an automatic regulator based on this method. Similar adjustments have been used by Elihu Thomson, and also by Hochhausen. As applied to collectors of

ordinary closed-coil dynamos the method is hardly successful. As applied to the commutator of the open-coil dynamo in the Thomson-Houston system (see Fig. 171, p. 199) it answers satisfactorily (see Appendix X.).

Section Method of Regulation.—Another method has been suggested by Brush, who winds the field magnets in a number of separate sections any number of which can be switched into circuit by a controlling electro-magnet. Very similar suggestions have been made by Cardew and by Deprez.

Electric Governing of Engine.—Yet another way of accomplishing automatic regulation is possible in practice, and this without the condition of a constant speed of driving. Let the ordinary centrifugal governor of the steam-engine be abandoned, and let the supply of steam be regulated, not by the condition of the velocity of driving, but by means of an electric governor operated by the electric current itself. Several of these governors are described in detail in Appendix X. For many purposes they are more suitable and reliable than any of the arrangements which necessitate a constant speed of driving. One great advantage of the electric governor is that it cuts down the consumption of steam to the actual demands made upon the electric circuit, and prevents injury both to the dynamo and to the steam-engine.

Dynamometric Governing.—One other method of governing dynamos is too important to be omitted. Engineers are all aware that the horse-power transmitted along a shaft is the product of two factors, the speed and the moment of couple; or, as it is now often termed, of speed and torque. If ω stands for the angular velocity and T for the torque (or turning moment) then

$$\omega T = \text{mechanical work per second, or "activity."}$$

But the "activity," or work per second, or horse-power, of a dynamo can be measured electrically, by the product of its electromotive-force into the current it drives through the circuit. If E stands for the electromotive-force, and i for the current, then

$$E i = \text{electric work per second.}$$

In a good dynamo the electric work, though not equal to the mechanical work, will exceed 90 per cent. of it. Now we know that, other things being equal, the electromotive-force E of a series dynamo or of a magneto machine is proportional to ω , the angular velocity or speed of driving. It follows at once that *the torque will be proportional to the current i* . This at once suggests that a series dynamo may be driven so as to give a constant current provided it be driven from a steam-engine governed *not by a centrifugal governor to maintain a constant speed, but by a dynamometric governor to maintain a constant torque or turning moment*. Some good transmission dynamometer, such as that of Morin, or one of the later varieties, such as those designed by Ayrton and Perry, or best of all that designed by the Rev. F. J. Smith,* and described in Chapter XXIX., may be adapted to work an equilibrium valve, and would fulfil the above condition of governing.

Prof. E. Thomson has suggested the use of a dynamometric apparatus to govern a constant-current dynamo by the method of rotating the brushes as explained in Chapter X. A description of this governor is given in Appendix X.

Governing by Steam-Pressure.—It was remarked above that electric power and mechanical power are each a product of two factors. But in an ordinary steam-engine the work per second also consists of two factors, viz. speed of piston and steam-pressure; and the angular velocity of the shaft is proportional to the former, and its transmitted torque to the latter. Therefore the condition of maintaining a constant current ought to be fulfilled if the pressure is always constant. If the valves are such as to admit a fixed quantity of steam at each stroke, and if the boiler pressure is really kept up, then the average pressure behind the piston ought to be constant. In practice this is never attained on account of the friction of the steam against the steam-pipes and port-holes of the valves. The internal friction in the engine plays the same part in preventing absolutely true self-regulation, as does the internal electrical resistance in the dynamo. An approximation is

* See the excellent little book, recently published by Messrs. E. & F. N. Spon, from the pen of this able author, on 'Work-measuring Machines.'

all that is possible. In an experiment made by M. Pollard with a Gramme dynamo, the current gave deflections on a galvanometer, varying only from 59° to 54° , while additional resistances were introduced into the circuit, which caused the speed to run up from 436 to 726 revolutions per minute. Theoretically, therefore, a constant current ought to be one of the easiest things to maintain with a series dynamo. Have adequate boilers, keep the steam-pressure always at one point, abandon all governors, and admit equal quantities of steam at each stroke whatever the speed: the result *ought* to be a constant current. The condition of maintaining a constant potential cannot be similarly solved, except by employing a shunt dynamo. In the shunt dynamo, as explained on p. 95, the current will be constant if the velocity is constant, provided the resistance of the armature be great. That is to say, i is approximately proportional to ω . With a shunt dynamo, then, E will be nearly proportional to T , and therefore if the condition of driving be such that T is constant, E will also be approximately constant. With adequate boilers, giving a constant steam-pressure, and properly set valves, a shunt dynamo ought, without any governor at all, to give an approximately constant potential, the speed varying in proportion to the current required for the lamps. Of course this cannot be realised in practice, because a high resistance in the armature means bad economy; and there are internal reactions of the dynamo which prevent accurate correspondence.

But it is possible to go further toward realising such results. The existing method of maintaining a constant steam-pressure is to put upon the boiler a pressure-gauge which indicates to the stoker when he is to add more fuel and when to damp down the fire. Let the pressure-gauge be abandoned, and instead, let there be provided at the side of the furnace either an ampère-meter, if the dynamo is to give a constant current, or else a volt-meter, if it is to give a constant potential, and let the stoker feed or damp his furnace fires according to the requirements of the

electric system of distribution. Is there any valid reason why such a method of government should not be efficient in practice, at least in the case of the series dynamo for constant currents?

Finally, to render the system truly automatic, it is conceivable that mechanical stoking appliances might be arranged, under the control of the ampère-meter or volt-meter, to supply the fuel in proportion to the number of lamps alight.

NOTE ON CAPACITY OF DYNAMOS.

A convenient system of describing the capacity of a dynamo to supply electric energy has lately been introduced: it is based on the fact that the output of electric energy per second is found by multiplying together (1) the quantity of the electric current driven through the circuit, and (2) the difference of potential through which it is moved. The current being expressed in *ampères*, and the difference of potential between the terminals of the dynamo in *volts*, the product will be a certain number of *volt-ampères*, or, as it is more usually termed, of *watts*. For example, suppose a dynamo to drive a current of 10 ampères through a circuit of arc lamps by exerting a potential of 800 volts at its terminals, the activity, or output of electric energy per second will be 8000 *watts*. Under the provisions of the Electric Lighting Act, the Board of Trade has issued regulations in which 1000 watts of output are termed "one unit." The output of the above-mentioned machine would therefore be briefly expressed as 8 Board-of-Trade-units, or more simply as 8 units. (Since 746 watts = one electric horse-power, it is clear that one Board-of-Trade-unit = 1.34 electric horse-power.) Now for every dynamo there is a certain limit of output, determined by the mechanical and electrical conditions of its design and construction. It must not give a current of more than a certain strength, or it will become overheated. It must not be run too fast or its bearings will heat, or some portion will fly. The maximum output at which a machine is able to be worked is termed its capacity. If, in the instance given above, 8000 watts were the safe working maximum output of the machine, it would be known as an 8-unit machine. A machine capable of giving 100 ampères at a potential of 80 volts (for incandescent lighting) or one capable of giving 2000 ampères at 4 volts (for electrolysis) would equally be called an 8-unit machine. Taking incandescent lamps as they are now manufactured, a 20-candle lamp requires approximately 50 watts of output. A "one-unit" dynamo will therefore supply about 20 lamps of 20 candle-power each. Again, taking arc lamps of approximately 2000 candle-power as requiring 10 ampères of current at 50 volts of potential, or 500 watts per arc, it will be seen that a "one-unit" dynamo will supply about two arc lamps.

It may be added that, for a given type of dynamo, the capacity is very

nearly proportional to the weight. But an enormous difference is to be found between the relative capacities of dynamos of equal weight, but of different types. Very great improvements have been made since 1882 in improving the capacity of machines, and especially in improving their capacity relatively to the weight of copper in the armature. Some data as to the number of watts per pound weight of copper in the armatures of different machines will be found in the succeeding chapters and in Appendix XI.

CHAPTER VII.

TYPES OF MACHINES.

Dynamos of Class I. (A).

CLOSED-COIL ARMATURES.

THE method of closing the armature coils upon themselves, first invented by Pacinotti, in the form of a ring, is adopted in the armatures of the Gramme, Siemens, and Edison dynamos, and in fact in the armatures of the majority of dynamos, which, though their armatures may have the form of a drum or a disk instead of a ring, are equally constructed with *closed coils*; that is to say, having the coils grouped in sections which communicate with successive bars of a collector, and which are connected continuously together into one closed circuit. The armatures of almost all the machines described in this and the next chapter are *closed-coil armatures*. There are other ways of winding a ring or a drum, in which the successive sections of the coil are not so connected together, and do not form a closed coil. These armatures may be called, for the sake of distinction, *open-coil armatures*. Dynamos having open-coil armatures are chiefly used for providing constant currents in arc-light circuits. Chiefest amongst them are the Brush dynamo and the Thomson-Houston dynamo. They are considered separately in Chapter X. on *Open-coil Dynamos*.

We now deal with the two main types of closed-coil armatures.

(i.) Ring Armatures.

Pacinotti's Machine.—This machine, depicted in Fig. 83, was described in the Italian journal *Il Nuovo Cimento* in 1864. The armature was an iron ring, shown separately in Fig. 84, having sixteen equal teeth supported by four brass arms B B.

Between the teeth, on wooden frames, were wound sixteen coils, each of nine turns. From the ends of each section, the wires were led downwards to the commutator. This was a cylinder of wood having sixteen strips of brass let into grooves.

FIG. 83.

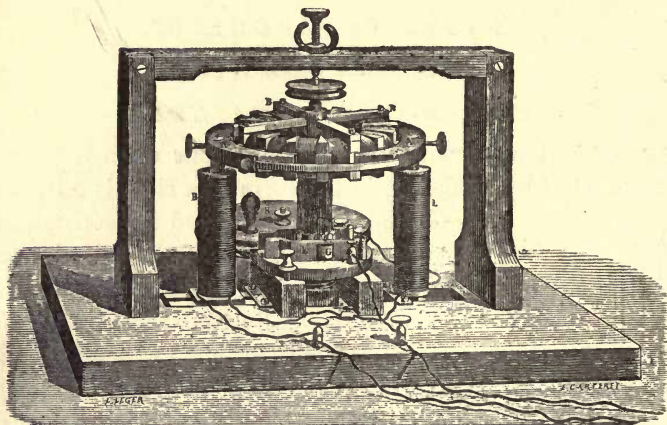

PACINOTTI'S DYNAMO.

Each strip of brass was soldered to the end of one section and to the beginning of the next. Two metal brushes pressed against the commutator at points on a diameter at right angles to the line joining the poles of the vertical electro-magnets, which were provided with wide pole-pieces. The ring was described by Signor Pacinotti as a "transversal electro-magnet," and though the machine was denominated an electric motor, its function as a generator was announced in the most specific terms.

FIG. 84.

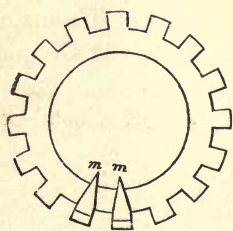

PACINOTTI'S RING.

"It seems to me," said Professor Pacinotti, "that that which augments the value of this model is the facility which it offers of being able to transform this electro-magnetic machine

into a *magneto-electric machine with continuous currents*. If instead of the electro-magnet there were a permanent magnet,

and if the transversal electro-magnet [i. e. the ring] were set turning, one would have made it into a magneto-electric machine, which would give a continuous induced current directed always in the same sense." Professor Pacinotti also separately excited the field magnets from a battery, obtaining on rotation a continuous current in the ring circuit. He also added the following significant remarks on the reversibility of his machine. "This model shows, moreover, how the electro-magnetic machine [motor] is the reciprocal of the magneto-electric machine [generator], since in the first the electric current which has been introduced by the rheophores [brushes], by circulating in the coils, enables one to obtain the movement of the wheel and its mechanical work ; whilst in the second, one employs mechanical work to cause the wheel to turn and to obtain, by the action of the permanent magnet, a current which circulates in the coils in order to pass to the rheophores, to be led thence to the body on which it is to act."

In spite of its extreme value, this model lay forgotten amongst the collection of instruments in the University of Pisa, until after all its fundamental points had been rediscovered and put into practice by other hands.

Gramme Dynamo.—The essential point of the Gramme machine is its ring. This is usually constructed as shown in Fig. 85. A quantity of soft iron wire is wound, upon a special frame or mould, into a ring to serve as the core. It is shown at A cut away to exhibit the internal structure. On this core the separate sections B B, of insulated copper wire, are wound. Each section is separately coiled by hand between temporary cheeks to ensure its being of exactly the right width ; the wire for each section being threaded in and out of the ring on a shuttle. The end of each coil and the beginning of the next are connected to one another, and to an insulated radial piece R, which forms one bar of the collector. When all the sections are wound, a wooden hub is driven in, and the ring mounted on a spindle.

The specification of Gramme's British Patent (of 1870), states that the armature may be of the form of a solid or

hollow ring cylinder or other suitable endless shape constructed either out of one piece of iron, or of a bundle of iron wires, and round the entire surface of which endless core is laid a series of coils of suitably isolated wire, of copper or other good conductor of electricity, in such a manner that the said coils or helices of wire may be considered as forming one continuous series of small bobbins; each being connected with the next so as to constitute one large endless bobbin.

FIG. 85.

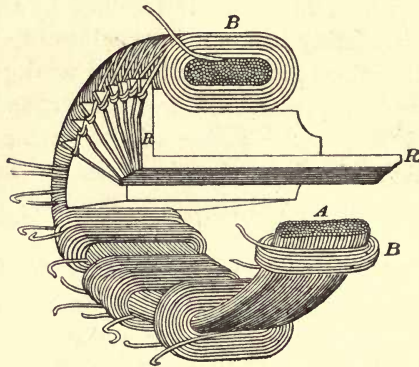

GRAMME'S RING.

As it rotates there will be set up in the core a continuous displacement or advancing of the magnetism. The inventor also states that the coils of wire may be replaced by coils made of strips or ribbons of brass or other good conductor suitably isolated.

Innumerable forms have been given to the Gramme machine at different dates since its appearance in 1871, varying from small laboratory machines with permanent steel magnets such as are shown in Fig. 86, to large machines absorbing 30 or 40 horse-power. Those who desire more detailed information concerning the various patterns of Gramme dynamo, should consult the treatise of the late M. A. Niaudet, entitled *Machines électriques à courants continus, systèmes Gramme et congénères* (1881). Fig. 87 shows the ordinary "A" Gramme,

FIG. 86.

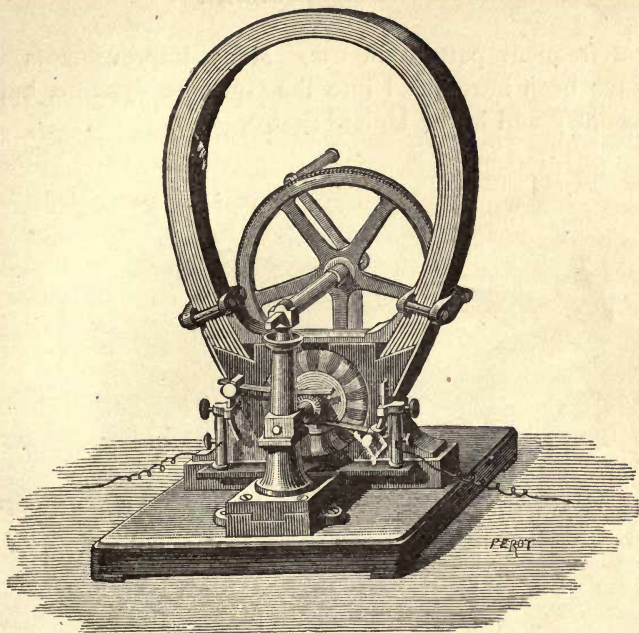

GRAMME MACHINE, LABORATORY PATTERN.

FIG. 87.

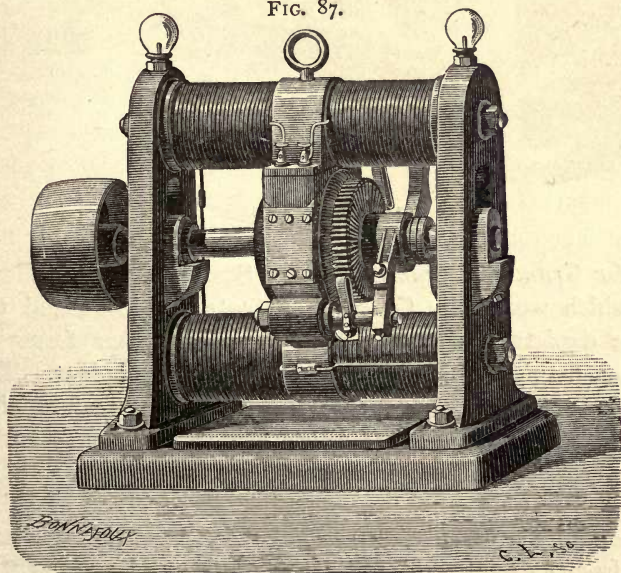

GRAMME DYNAMO, "A" PATTERN.

the most frequent pattern in use. Many improvements in detail have been introduced into the Gramme dynamo, both in this country and in the United States.

FIG. 88.

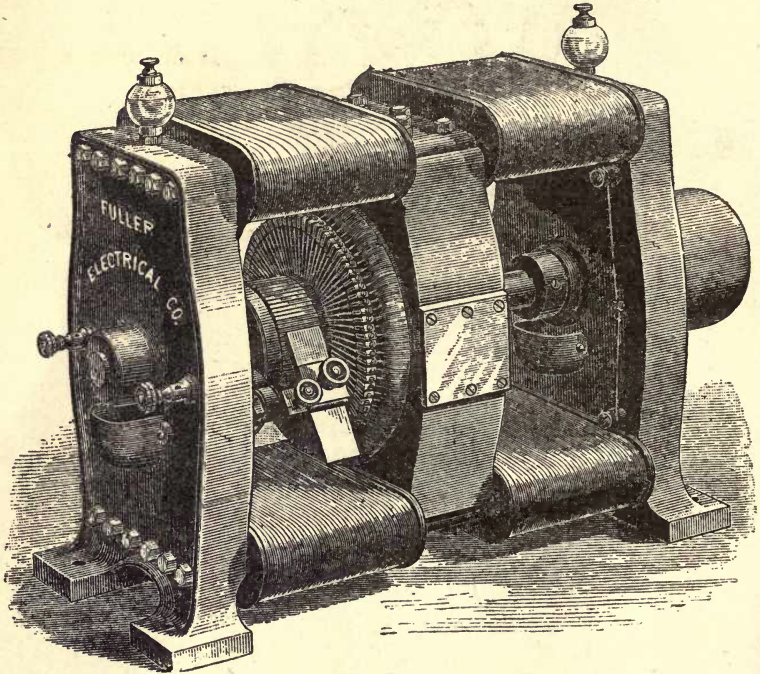

FULLER-GRAMME DYNAMO.

Fuller-Gramme Dynamo.—In the States the Fuller Company, which works the Gramme patents, has produced the machine depicted in Fig. 88, and several other forms in which mechanical skill of a high order is apparent. The field magnets, frames, and pole-pieces are very substantial. The ring, which is depicted separately in Fig. 89, is better built than the older European types, and is also connected to the shaft by an internal gun-metal spider, instead of being driven on to a wooden hub; and the collector-bars are prevented from flying to pieces by the addition of an insulated ring shrunk on over their ends. The cut also shows how the

coils are kept in their place by external bindings of fine wire, securely soldered together.

FIG. 80.

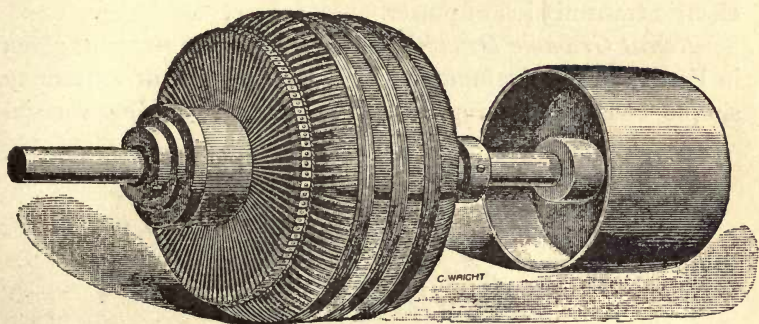

ARMATURE OF FULLER-GRAMME DYNAMO.

Deprez's Gramme Dynamo.—In France, too, the machine has received important modifications at the hands of M. Marcel Deprez. M. Deprez's dynamo has two Gramme rings upon one axle, which lies between the poles of two opposing field magnets, each of the two-branched, or so-called horse-shoe form (see Fig. 34, p. 39). These are laid horizontally, so that the N. pole of one is opposite the S. pole of the other, and *vice versa*; the poles being provided with curved pole-pieces between which the rings revolve. In almost all the larger Gramme machines of ordinary pattern, the pole-pieces are in the middle of long iron cores, which are so wound as to give a consequent pole at the central point. M. Deprez, who has given much attention to the question how to design a machine which, with the least expenditure of electric energy, gives the greatest actual couple at the axle, is of opinion that the horse-shoe form of electro-magnet is the most advantageous. The iron cores and yokes of his field magnets are very substantial; but the pole-pieces are not very heavy. M. Deprez's machine has a very elaborate system of sectional windings of the field magnets, and a switch board enabling him to couple up the connexions in

various ways. The circuits of the two rings are quite distinct, and each armature has its own collector and brushes. M. Deprez has also constructed other Gramme machines, with armatures of very fine wire, for his experiments on the electric transmission of power.

Recent Gramme Dynamos.—Amongst the later forms given in France to the Gramme machine, we find one of extremely simple construction, represented in Fig. 90, having vertical

FIG. 90.

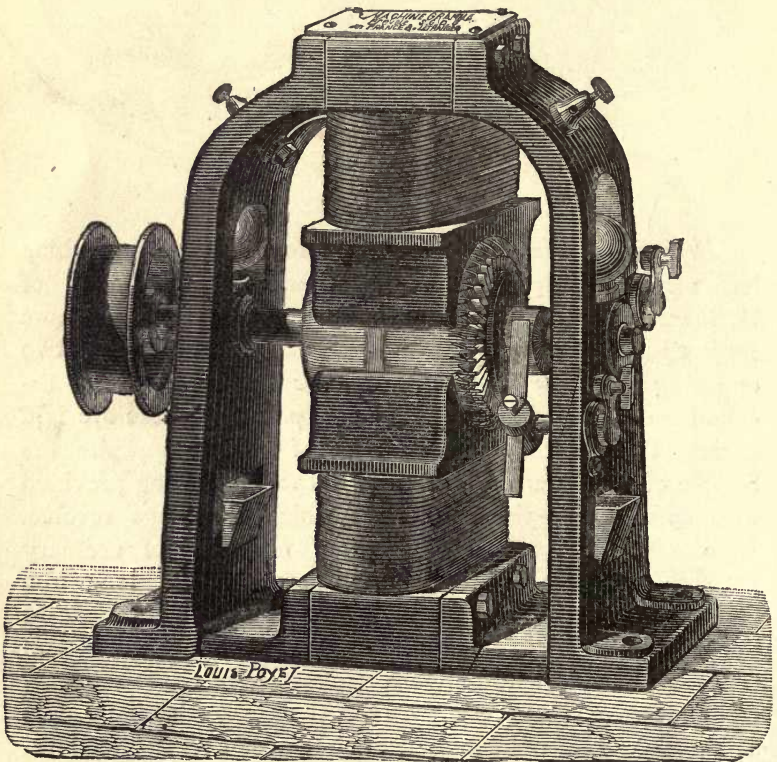

GRAMME DYNAMO, VERTICAL PATTERN (1881.)

electro-magnets. These are made of cast iron put together in four pieces. The structure is heavy, since, on account of the lower permeability of cast iron, a much greater bulk than of

wrought iron must be employed. It will be observed that this pattern differs from that of the better-known "A" Gramme in using *salient poles*, instead of having the "consequent poles" at the middle points of the electro-magnets. This is one of the forms of machine employed by Deprez in the transmission of power. In a still more recent form, four salient poles are employed. The field magnets of this type are still more simple, for the four cores, the external octagonal frame, and one of the two brackets which carry the shaft are all cast in one piece (Fig. 91). The object of this is to secure a strong,

FIG. 91.

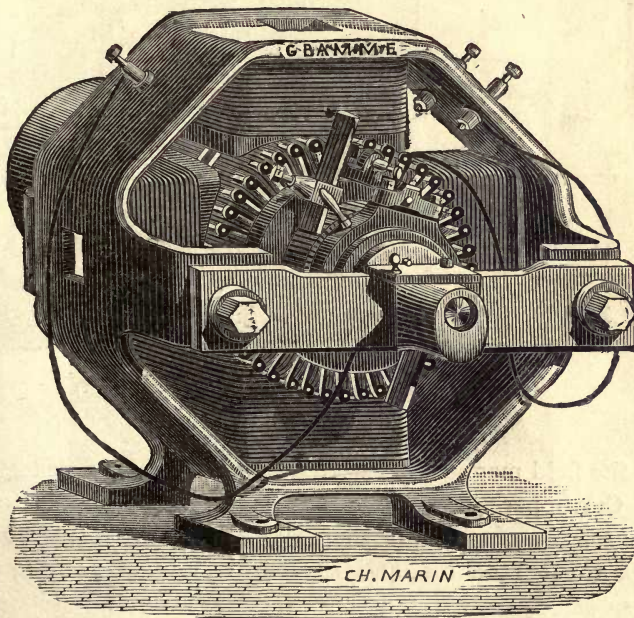

PORTABLE GRAMME DYNAMO (1885).

light, and portable machine, suitable for temporary lighting. The coils are wound on a separate mould, and slipped on and secured in their places. Some of these machines are constructed with two poles only. The weight of copper in them is relatively very small.

Yet another vertical pattern of machine quite lately designed by the firm of Breguet, is shown in Fig. 92. Here

FIG. 92.

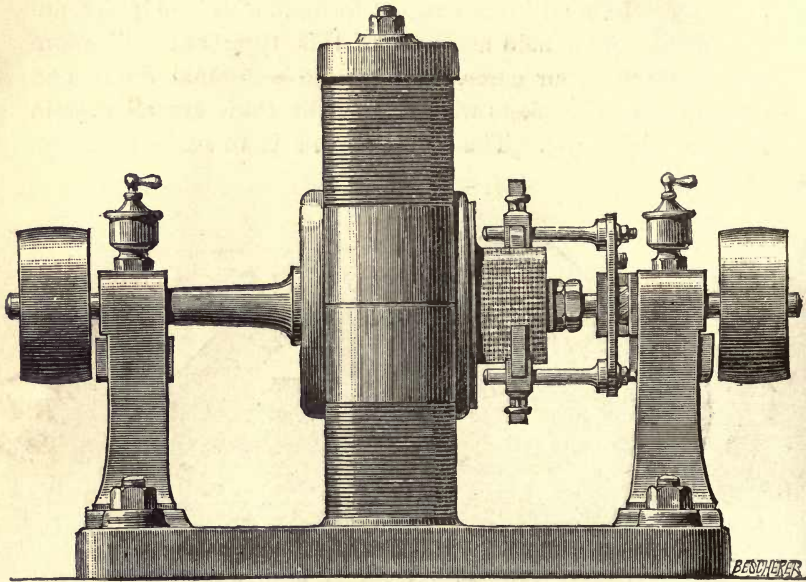

GRAMME DYNAMO (BREGUET, "B" AND "C").

also the field magnets are of cast iron, and are constructed so that the upper half can be removed from the lower. The same solidity of structure characterises these machines, which weigh about 1500 lbs., and have an output of 5400 to 6050 watts.

For furnishing very powerful currents, M. Gramme is now constructing machines of the type depicted in Fig. 93, which somewhat resembles an older form, constructed in 1873, in having multiple cores united to a common pole-piece. As many as 14 columnar electro-magnets may be found in some machines. This is an entirely mistaken construction. The most interesting part of this machine is its armature, which

is shown separately in Fig. 94. This consists of a hollow cylinder, built up of 100 wedge-shaped copper bars, each covered with a bitumenised paper wrapping, and then put

FIG. 93.

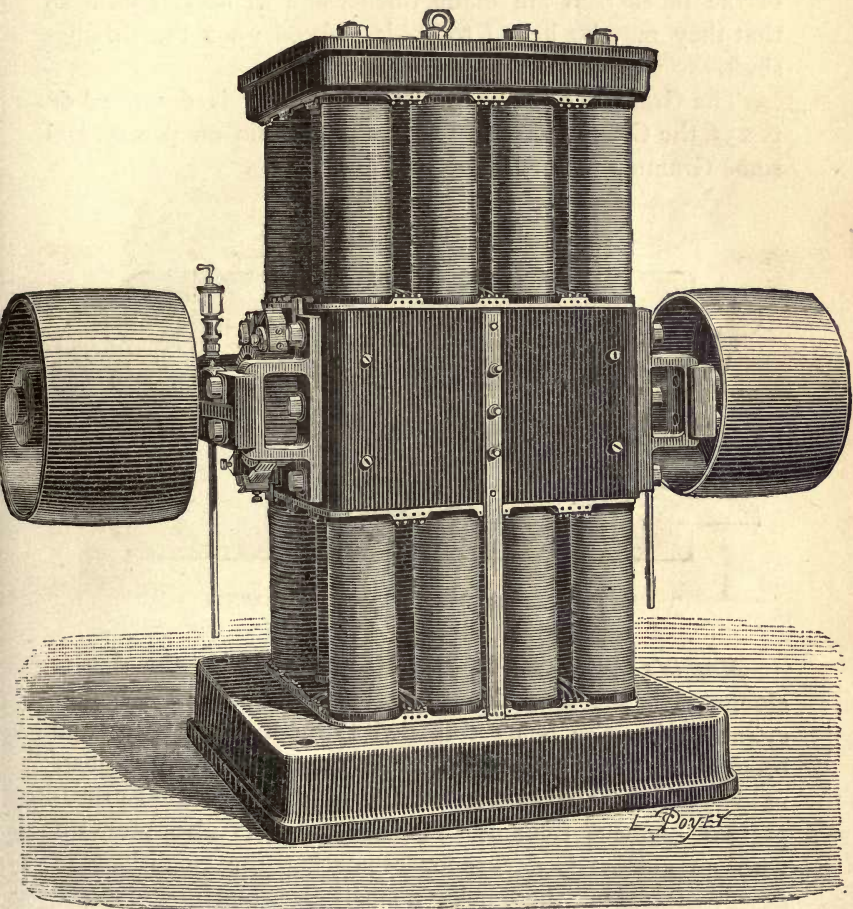

GRAMME DYNAMO FOR LARGE CURRENTS (1884).

together. Each bar has two radial projections of copper. The protruding ends of the copper rods form the collectors, of which there are two. The space between the two sets of radial projections is filled with windings of varnished iron wire,

which constitute the core, and finally 100 other bars of copper of flatter section are connected exteriorly from the projecting lug at one end of one bar to the lug at the other end of the next bar, so connecting the bars into a closed coil. Several of the inner bars are made thicker and of special form so that they may be keyed to spiders fixed upon the driving-shaft.

The Gramme dynamo for electro-plating is described on p. 235, the Gramme alternate-current dynamo on p. 215, and some Gramme motors on pp. 436 and 437.

FIG. 94.

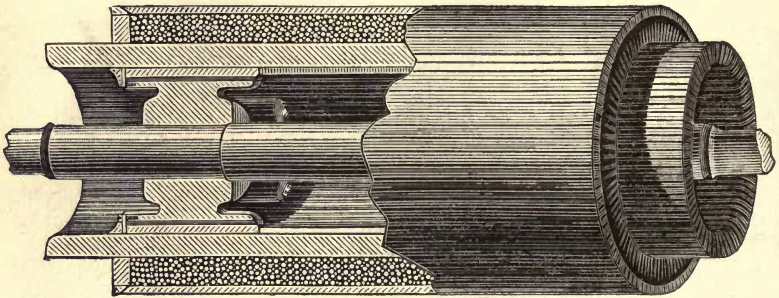

GRAMME ARMATURE FOR LARGE CURRENTS.

Maxim's Dynamo.—In the Maxim machine the ring is elongated in the axial direction so that it becomes a hollow cylinder, the wire being threaded through the interior and brought back over the exterior of the ring. The field magnets used by Maxim are of the general form adopted in the vertical-pattern Siemens dynamo. This dynamo is also provided with an automatic device for regulating the conditions of supply of current, there being a small electro-magnetic motor mounted upon the machine to shift the brushes forward or backward, and by thus altering the lead to correct the variations of potential at the terminals.

Cabella's Armature.—A form of ring armature recently devised by Signor B. Cabella closely resembles the form of Gramme armature shown in Fig. 94. The Figs. 95 and 96

show its general arrangements. It is built up of copper strips. These are separately cut out, and consist each of a straight piece $a k$, having two arms $d e$ and $h i$ project-

FIG. 95.

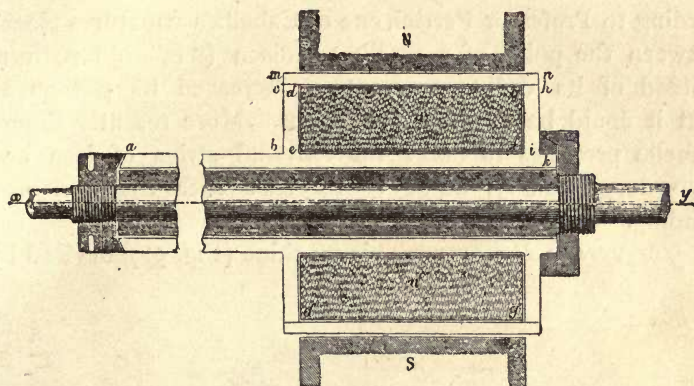

CABELLA'S ARMATURE (Section).

ing at right angles. A sleeve of insulating material is placed over the axle, and round this these copper pieces are arranged to the number of some 240 or so, having their arms $d e$ and $h i$ projecting symmetrically round in two radial sets, one near one end and the other near the other. The channel formed thus between the two sets is lined with insulating material, and then entirely filled up with soft iron wire wound round. Then straight strips of copper $m n$, 8 millimetres broad and 2 millimetres thick, are screwed across the outside, nearly parallel to the axis, from the ends of one set of radial projections to the ends of the others, forming a parallelogram section. But in order to connect the ring all round in a continuous circuit, these external strips of copper are connected at their two ends

FIG. 96.

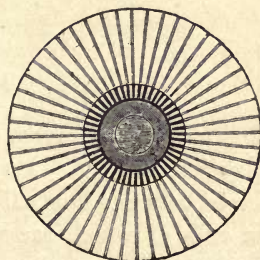

CABELLA'S ARMATURE
(End view).

to pieces which project, not from the same internal copper strip, but from adjacent strips. Thus an external bar will connect the anterior end of the first strip with the posterior end of the second ; and so on. Every third strip is carried along the axle and connected to a segment of the collector. According to Professor Ferrini, one of Cabella's armatures placed between the poles of a 60-light Edison ("Z," old pattern) instead of its ordinary armature, increased its powers so that it could be used for 150 lamps. More recently Signor Cabella proposes to make the external strips of iron and very deep radially, so as to dispense with the iron wire winding.

Jürgensen's Dynamo.—This machine (Fig. 97), devised by

FIG. 97.

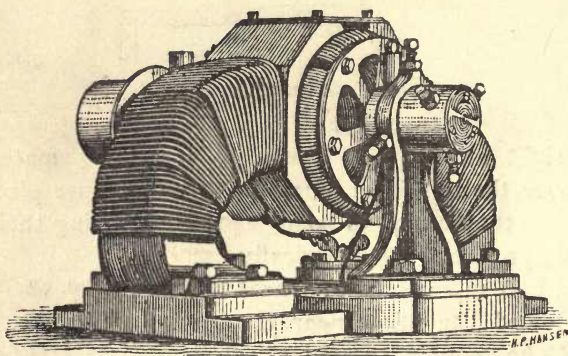

JÜRGENSEN'S DYNAMO.

Jürgensen and Lorenz, of Copenhagen, attracted considerable attention in 1882. Its armature is a hollow cylindrical ring placed between two salient poles of an arched electro-magnet, the coils of which are wound most thickly close to the pole. There is also an electro-magnet placed inside the ring to reinforce the polarity of the ring. This feature, indeed, gives its interest to the machine.*

Hochhausen's Dynamo.—In this dynamo, shown in Fig. 98, the armature is an elongated ring : but it is constructed in a

* For further description, see *Electrical Review*, Sept. 23, 1885.

novel fashion of four separate curved iron frames, upon which the previously wound coils are slipped, and which are then bolted together and secured to strong end plates. The field magnets of this machine are disposed in a manner similar to that of the Gramme machine shown in Fig. 90, the ring being placed between two straight electro-magnets placed vertically over one another. The upper magnet is held in

FIG. 98.

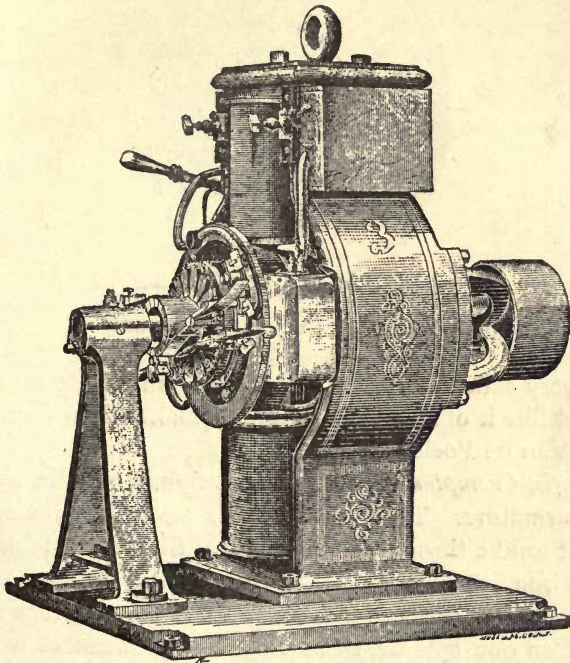

HOCHHAUSEN'S DYNAMO.

its place by curved flanking-pieces of iron, which run down the two sides of the machine, and connect the topmost point of the upper magnet with the lowest part of the lower. This arrangement strikes the eye as being both mechanically and magnetically bad ; nevertheless the machine appears to be a very good working machine. Like the Maxim dynamo it is provided with a small motor arrangement to adjust the lead

of the brushes, and which is supposed to be automatic in its operation. The collector segments, which are very massive, have air gaps between them, and are bolted to a substantial disk of slate. This arrangement is exhibited in Fig. 99,

FIG. 99.

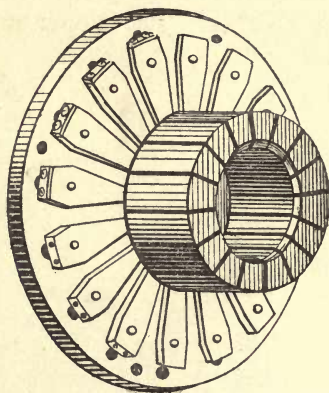

COLLECTOR OF HOCHHAUSEN DYNAMO.

and is very satisfactory. Another dynamo closely resembling this, and like it of American origin, is known from its inventor as the Van de Poele dynamo.

Bürgin-Crompton Dynamo.—This dynamo is distinguished by its armature. The field magnets are of a horizontal pattern, not unlike those of the horizontal Siemens machines, but of cast iron. The armature of the original Bürgin machine, as it came from Switzerland, consisted of several rings set side by side on one spindle, these rings being made of iron wire wound upon a square frame, and carrying each four coils. In this form it is described in Professor Adams' Cantor Lectures on Electric Lighting in 1881. But in the hands of Messrs. R. E. Crompton and Co., it has undergone a remarkable course of development. Mr. Crompton changed the square form to a hexagon having six coils upon it (Fig. 100), and increased the number of rings to ten. It was thus described in 1882 :—"Each ring is made of a hexagonal coil of iron wire, mounted upon light metal spokes, which meet the corners of

the hexagon. Over this hexagonal frame, six coils of covered copper wire are wound, being thickest at the six points intermediate between the spokes, thus making up the form of each ring to nearly a circle. Each of the six coils is separated from its neighbour, and each of the ten rings is fixed to the axis one-sixtieth of the circumference in advance of its neighbour, so that the sixty separate coils are in fact arranged equidistantly (and symmetrically as viewed from the end) around the axis. There is a 60-part collector, each bar of which is connected to the end of one coil and to the beginning of the coil that is one-sixtieth in advance; that is, to the corresponding coil of the next ring. This armature has the great practical advantages of being easy in construction, light, and with plenty of ventilation."

FIG. 100.

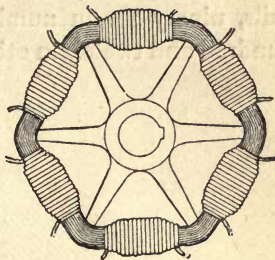

SINGLE RING FROM CROMPTON-BÜRGIN ARMATURE.

This form, however, suffered from the harmful effects of induction between contiguous rings, and it was found advisable to alternate the positions of the rings, instead of placing them in a regular screw-order on the spindle as shown in most of the published drawings of this well-known machine. The next step was to increase the quantity of iron in the hexagonal cores, and to ascertain by experiment what was the best relative proportion of iron and copper to employ. At the same time, Mr. Crompton and Mr. Kapp introduced their system of "compounding" the windings of the field magnets. Another change in the armature followed, the rings being made much broader and fewer in number, four massive hexagonal rings, united to a 24-part collector, replacing the ten slighter rings and their 60-part collector.

Crompton-Kapp Dynamo.—This remarkable machine shows what may be done in the way of improvement by careful attention to the best proportions of parts and quality of material. Its field magnets are of the very softest Swedish wrought iron,

compound-wound. The armature is a single ring of the elongated or cylindrical pattern, and its coils are wound upon an iron core made up of disks of very thin soft iron fixed upon a central spindle by means of short arms, which are dovetailed into notches cut in the inner circumference of the disks. At intervals gaps are left between the disks, for ventilation. The coils, ninety-six in number in some of these machines, one hundred and twenty in others, are threaded through the cylinder

FIG. 101.

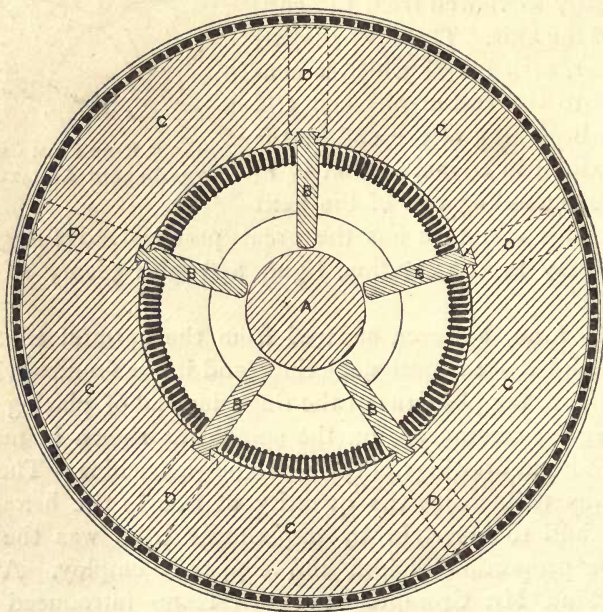

SECTION OF CROMPTON-KAPP ARMATURE.

as in the Maxim ring, and kept in their places by small boxwood wedges and by an external strap of thin brass wires. Fig. 101 shows a sectional view of the armature as constructed for the latest machines. This armature is 2 feet 4 inches in length, and $12\frac{3}{4}$ inches in external diameter. The steel shaft A is grooved with five deep slits to receive five flange-like spokes B which dovetail into notches in the iron disks C.

Mr. Crompton's method of connecting with the driving shaft by grooves in the latter is shown in Figs. 102 and 103, which illustrate a shaft with three grooves. At every 2 inches of the length there are inserted the pieces D, which are $\frac{1}{8}$ inch thick, to preserve ventilating gaps. There

FIG. 102.

FIG. 103.

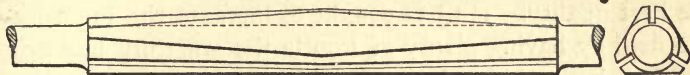

DRIVING SHAFT OF CROMPTON'S DYNAMO.

FIGS. 104-7.

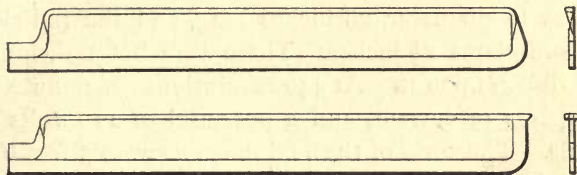

WINDINGS OF CROMPTON'S ARMATURE.

are 120 turns in the coil, every third turn being brought down to one segment of a 40-part collector. The coils are built up of drawn copper rod of nearly rectangular section and about a square centimetre of sectional area. The parts of the winding which pass through the interior are of a narrow form, to admit of closer packing, and turn up at both ends somewhat like the copper strips of the Cabella armature. The forms of these conductors are shown in Figs. 104 to 107. The insulation is peculiarly carefully carried out with pieces of hard vulcanised fibre, cut so as to admit of wrapping at intervals round the copper conductors, but leaving ventilating spaces. A method of arranging the coils, in those cases where wires are used, is shown in Fig. 108, one layer of coils only lying on the external surface.

FIG. 108.

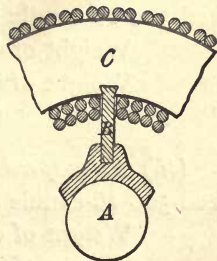

CROMPTON'S WIRE-WOUND ARMATURE.

Mr. Crompton has also designed armatures in which the coils lie in deep grooves in the core, the principle of great radial depth being still preserved.

As there are so few turns of wire on the armature, it was essential in this machine to employ a magnetic field of extraordinary power. Mr. Crompton's great aim has been to have as complete a magnetic circuit as possible, and that of the best quality. He has sought to increase the intensity of the field by having plenty of iron in the armature, and bringing that iron as closely as possible into proximity with the pole-pieces. The result is an extraordinary increase in the "output," or "activity" of the machine.

In a recent machine of this pattern the armature was 12 inches in diameter, 28 inches long, and the radial depth of the core-plates $2\frac{1}{2}$ inches. There were but 69 windings of copper ribbon upon it. At 440 revolutions per minute it gave 229 ampères of current, and a potential of 110 volts at the terminals. The cores of the field magnets were 3 feet 6 inches long, 24 inches broad, $4\frac{1}{2}$ inches thick, and required about 24,000 ampère turns, in total, to magnetise fully.

The quantity of copper in these machines is small as compared with the quantity of iron, especially in those machines that are designed to run at slow speeds. Two examples have been furnished by Mr. Crompton:—

(i.) *Fast-speed Machine* (1400 revolutions per minute), to feed 300 16-candle lamps:—

Weight of copper in armature coil .. 45 lbs.

Weight of iron in armature core .. 131 „

Copper : iron = 1 : 2.9.

(ii.) *Slow-speed Machine* (500 revolutions per minute), to feed 500 16-candle lamps:—

Weight of copper in armature coil .. 130 lbs.

Weight of iron in armature core .. 550 „

Copper : iron = 1 : 4.25.

The power of the field magnets is such that at all speeds, and under all conditions of the external circuit the intensity

of the field is undisturbed by the magnetising action of the currents in the armature coils. There is, therefore, hardly any lead at all at the brushes, and what lead there is, is absolutely constant. There is no sparking, and it is impossible to tell by looking at the brushes whether the current is off or on. Messrs. Crompton and Kapp have found that machines constructed with cast-iron field magnets, instead of wrought-iron, give, at the same speed, an electromotive-force about 40 per cent. lower than those with wrought iron, all other things remaining the same.

During the progress of manufacturing and developing the Bürgin-Crompton dynamos, and those of the more recent type, Mr. Gisbert Kapp was led to employ an empirical formula for calculating in a practical way the (total) electromotive-force of dynamos of the cylinder-ring type. This formula is:—

$$E = \frac{\mu c t a^3 b n}{10^6};$$

where c is the number of segments in the collector, t the number of turns of wire in one section of the winding, a the thickness of the iron core measured in the radial direction, b the length of the core measured parallel to the axis, n the number of revolutions per minute, and μ the "modulus" of the machine. When a and b are expressed in inches, and E in volts, the modulus for machines of the Crompton-Bürgin type is found to vary from 35 when the field-magnet cores are of cast iron to 42 when they are of wrought iron; the fields being in all cases as much excited as is economically profitable in the practical working of the machine. The modulus μ , in fact, expresses the goodness of the field magnetism; and according to Mr. Kapp's observations it may be itself expressed as,

$$\mu = \frac{1}{\alpha} \tan^{-1} \beta P;$$

where P is the number of ampère-turns in the exciting current round one limb of the field magnets, and α and β constants depending on the quality, form, and quantity of iron. Doubtless μ might be equally or more conveniently expressed in the

form given for the quantity "H" in the Algebraic Theory in Chapter XV., and might be written :—

$$\mu = G \kappa P \frac{I}{1 + \sigma P};$$

where G is a geometrical coefficient depending on the size and form only of the magnets, κ the coefficient of magnetic permeability depending only on the quality of the iron, and σ a saturation-coefficient depending both on the quantity and quality of the iron.

In Mr. Kapp's formula for E the product of the four quantities $c t a^3 b$ may be looked upon as constituting a value, for these machines, of the armature-coefficient "A" employed in the equations of Chapter XII. At first Mr. Kapp employed instead of $a^3 b$ the simple cross-sectional area of the armature core: but finding that in the cores composed of iron wire (as in Gramme and Bürgin armatures) the outer layers appeared to shield the inner layers from the magnetising influence of the field magnets, or at least that the inner layers were apparently less susceptible to magnetisation, he found the $\frac{2}{3}$ -power of the thickness of the core in the radial direction to express the facts better.

In the former edition of this work the author put forward the conjecture that this apparent lower susceptibility of the inner layers might be due to the discontinuity of the layers of iron-wire core in the radial direction. The correctness of this view is supported by later investigations. Mr. Crompton has now constructed a whole series of machines in which a (the radial thickness of the core) varies from .75 to 3.5 inches. He finds μ to be constant if a is used in the formula, and very inconstant if a^3 is used. The most recent values obtained for μ are: Swedish iron, 37; English scrap-iron, forged and annealed, 33; cast iron, 25.5. With steel cores for the field magnets very variable results were obtained.

Kapp's Dynamo.—Mr. Kapp has lately designed dynamos of a kindred type which work at very low speeds. Fig. 109 shows a general view of this machine, and Figs. 110 and 111 give some further details. The field magnets consist of two semicircular wrought-iron cores, screwed to cast-iron pole-

pieces. The coils are wound on six light cast-iron bobbins which slide over the cores. Fig. 110 is a transverse section of this compact and powerful arrangement. Fig. 111 shows a longitudinal section of the armature. This is built up upon a cylinder of gun-metal perforated with ventilating apertures,

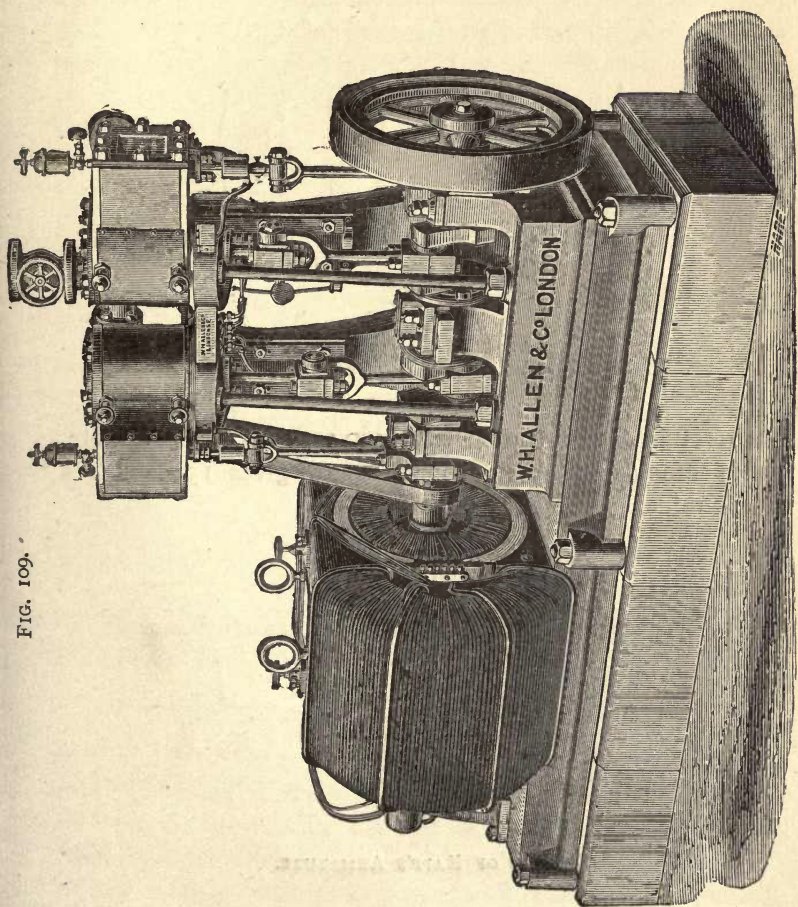

FIG. 109.

KAPP'S DYNAMO.

cast in one solid piece with projecting flanges F and horns H to prevent slipping of the coils, and is keyed to the shaft by two sets of arms. The core is of soft charcoal-iron wire wound over a thin iron plate, the iron being carefully insu-

lated from the driving cylinder. The armature is 16 inches in diameter, and 24 inches in length. Two hundred turns of copper wire of square section, weighing 90 lbs., constitute

FIG. 110.

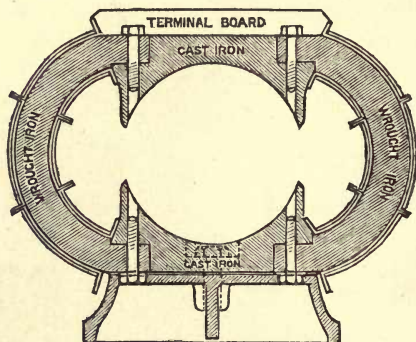

KAPP'S DYNAMO, SECTION OF FIELD MAGNETS.

the armature coil. At a speed of 340 revolutions per minute, this dynamo (which is compound-wound) gives 150 ampères with terminal potential of 110 volts.

FIG. 111.

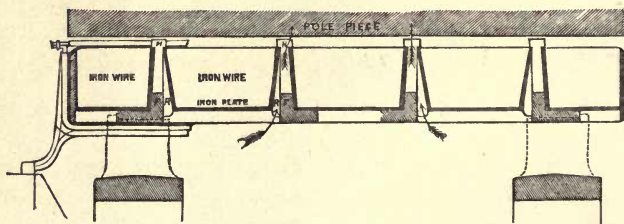

SECTION OF KAPP'S ARMATURE.

Paterson and Cooper's Dynamo.—The "Phoenix" dynamo constructed by Messrs. Paterson and Cooper has also a modified cylindrical ring armature, built up of a number of very thin toothed rings of Swedish iron separated from one another by paraffined paper and secured to two end

frames by three bolts passing through insulated bushes in the plates. There are no air spaces in the armature for ventilation, nor interior teeth to keep the coils apart: neither are there in this armature, as in the Lumley dynamo manufactured at one time by this firm, interior projections to conduct the heat developed in the iron core to the central spindle. In fact there is comparatively little heating in this armature, the projecting teeth appear to act efficiently as radiators. These machines, of which Fig. 112 shows the first form, give

FIG. 112.

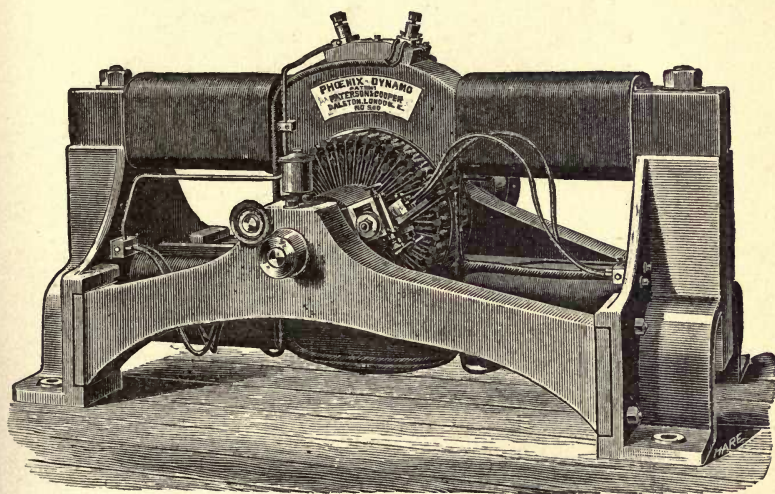

THE PHOENIX DYNAMO.

no trouble from sparking. The field magnets are of forged iron of square section. The pole-pieces of the field magnets are so proportioned as to give at the collector a potential diagram of perfect regularity, on the method indicated by the author of this book in 1882 and described on p. 52. This dynamo (a 39-unit machine), running at 500 revolutions per minute, yielded 372 ampères with a potential of 105 volts; being at the rate of 223 watts per pound of copper on the armature, and showing also 0.905 volt per yard of copper in the armature coil. A still more recent machine shown at the

Antwerp Exhibition (of 65 units) gave 372 watts per pound of copper, and 1.31 volts per yard of coil. The ratio of copper to iron in the armature is 1:3.03. The resistances are: armature, 0.0055 ohm; shunt, 10.00 ohms; series coil, 0.004 ohm.

McTighe's Dynamo.—Fig. 113 depicts a machine which has been used with some success in the States, its armature

FIG. 113.

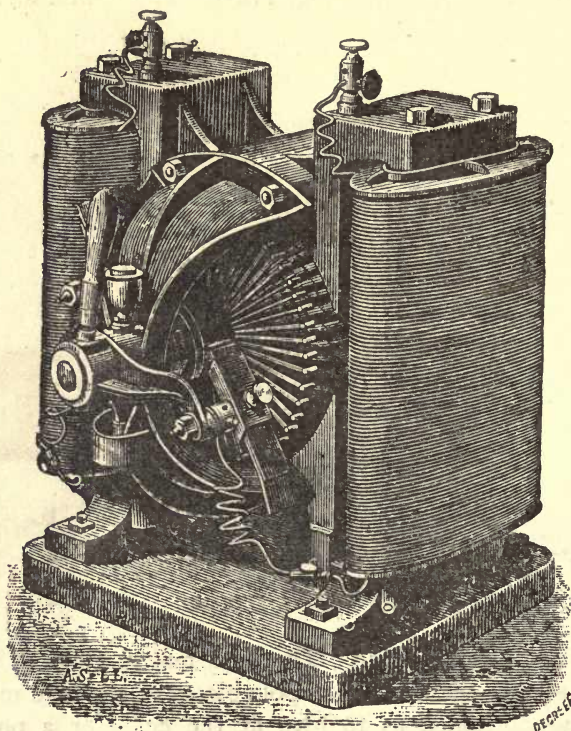

MCTIGHE'S DYNAMO.

being a modified Gramme ring. The interesting feature is, however, the field magnet, which is of extremely simple form, there being two vertical cores on either side to receive the coils, united above and below by yokes of iron, which are specially formed so as to serve also as pole-pieces. Field

magnets of an almost identical form have recently been used by Mr. Joel in his so-called "Engine Dynamo,"* and also by Messrs. Elwell and Parker.† In Joel's dynamo the pole-pieces are grooved on the polar surface. The armature is a modified Pacinotti ring built up in interlocking sections bolted together.

Mather and Hopkinson's Dynamo.—The field magnet of this well-designed machine, shown in Figs. 114 and 115, closely resembles the preceding; but the wrought-iron cores are

FIG. 114.

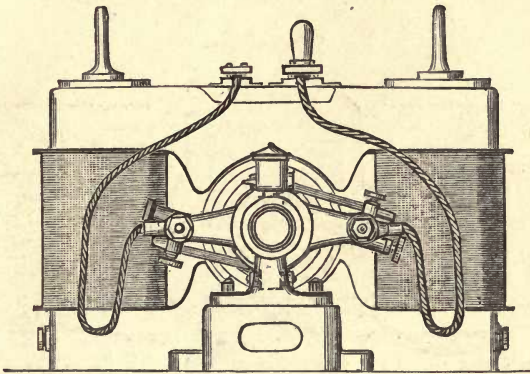

MATHER AND HOPKINSON'S DYNAMO (End Elevation).

cylindrical and the cast-iron yokes very massive. It was designed by Dr. Edward Hopkinson. The armature, designed by Dr. J. Hopkinson, F.R.S., and Dr. Edward Hopkinson, is a modified Gramme, with low resistance and careful ventilation. The collector is unusually substantial, and consists of 40 bars of toughened brass insulated with mica. In a 24-unit machine (designed for 300 lamps) of this pattern the armature cores are 12 inches long and 12 inches in diameter, with 120 turns of wire. The resistances are : armature, 0.023 ohm ; shunt, 19.36 ohms ; series coil, 0.012 ohm. With a speed of 1050 revolutions per minute the current was 220 ampères, the machine being nearly self-regulating for 111 volts. This

* *Electrical Review*, xvi., p. 370, April 1885.

† *Ibid.*, p. 202, February 1885.

machine is known as the "Manchester" dynamo; its efficiency is 90·9 per cent.

Heinrich's Dynamo.—This machine has a ring armature with an iron-wire core of a U-shaped cross-section, enclosed almost entirely within the polar extensions of the field magnets, which in some respects resemble those of the Siemens dynamo. The intent of this form of armature was to expose as much of the wire as possible to the action of the field.

FIG. 115.

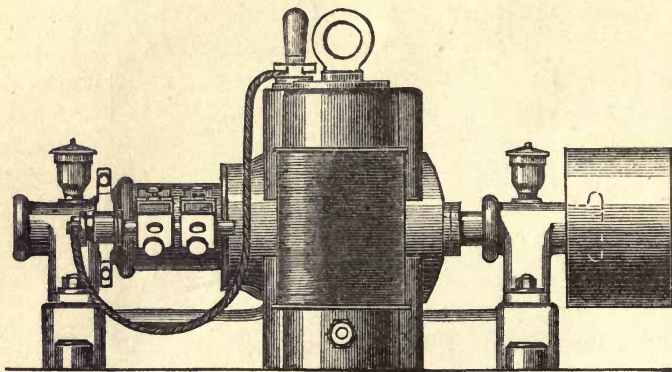

MATHER AND HOPKINSON'S DYNAMO (Front Elevation).

Some recently published tests of a series-wound Heinrich's dynamo, which, at a speed of 1680 revolutions per minute, gave 234 volts and 21·01 ampères, show a gross efficiency of 97 to 98·9 per cent., and a nett efficiency of about 83 per cent.

Flat-ring Armatures.

We next come to the class of machines in which the armature is of the *flat-ring* type. The earliest of these is—

Schuckert's Dynamo.—The armature of the Schuckert machine is a flat ring, the core of which is built up of a number of thin iron disks, insulated from one another. The

FIG. 116.

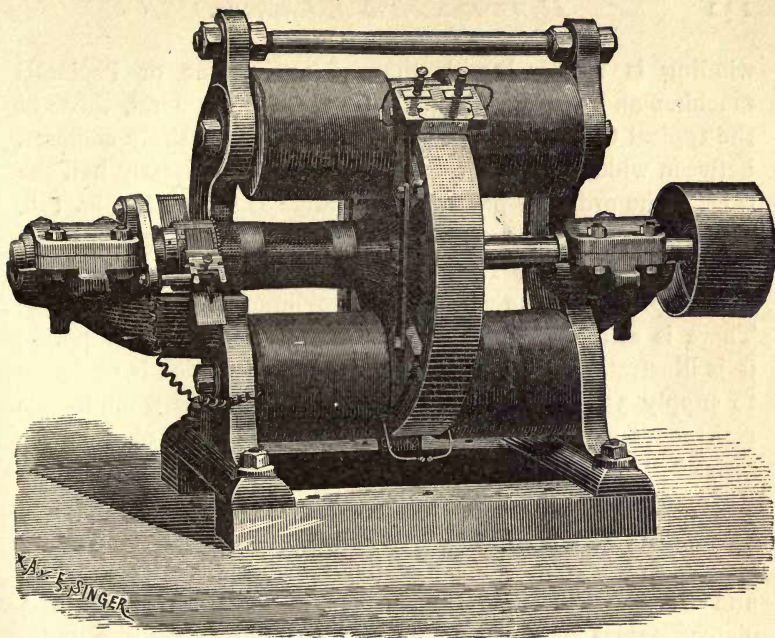

SCHUCKERT'S DYNAMO, WITH FLAT-RING ARMATURE.

FIG. 117.

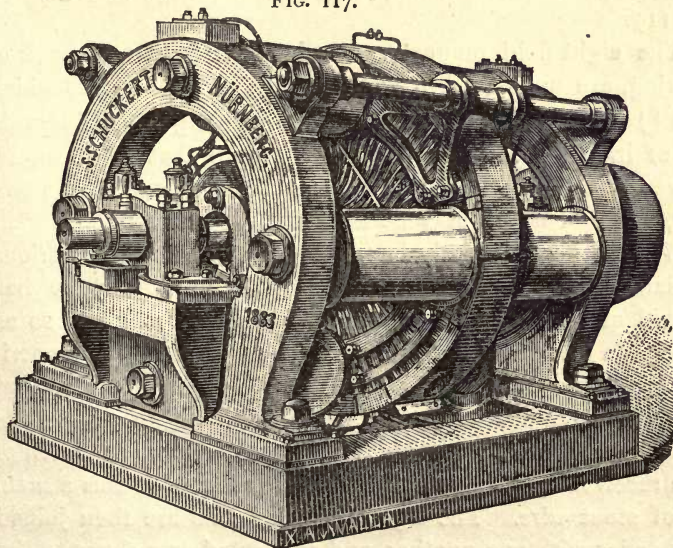

SCHUCKERT'S 4-POLE COMPOUND DYNAMO.

winding is identical with that of a Gramme or Pacinotti machine, and the field magnets resemble, in general, those of the typical Gramme. But the ring is almost entirely enclosed between wide pole-pieces, each of which covers nearly half the ring. The ordinary pattern of machine is shown in Fig. 116, which shows the device for removing the armature. The flat ring was designed by Herr Schückert, to give better ventilation and employ less idle wire than the cylindrical pattern of ring. There is also a newer type of machine, having four poles; it is illustrated in Fig. 117. This machine, which is designed to supply 350 incandescent lamps, is compound-wound. Its resistances are 0·01 ohm in the armature, 0·015 ohm in the series coil, and 32 ohms in the shunt coil of the field magnets. This machine has two pairs of brushes.

Gülcher's Dynamo.—The best known of Gülcher's machines is also a 4-pole machine, the poles being alternately of N. and S. polarity. The ring, which is built up of flat iron plates, passes at four points within hollow box-like pole-pieces of iron, cast upon wrought-iron cores, upon which the coils are wound. The typical form is shown in Figs. 118 and 119.

The eight field magnets, placed at the front and back of the ring, are united in pairs to the hollow pole-pieces which form U-shaped cases over the ring, covering a considerable part of it. The collector is identical with that of Gramme, but very substantial. There are four brushes, coupled in two pairs, either of which may be used alone.

Mr. Gülcher has lately improved his dynamo in its various mechanical and electrical details. In particular, he has devoted attention to the winding of the field magnets so as to secure a constant potential at the terminals. After experimenting with various methods of compounding, he finds that the best results are arrived at in the following way:—In his 4-pole dynamo there are eight cores to be wound. Each of these receives a shunt coil of fine wire, and outside this a main coil of stout wire. The eight fine-wire coils are then joined up in series with one another, and connected as a shunt to the terminals; whilst the eight main-circuit coils are joined up

in parallel. The machines show a very fair approximation to a constant potential, and an actually attained constancy for a considerable range (see curve, Fig. 277). For example, a

FIG. 118.

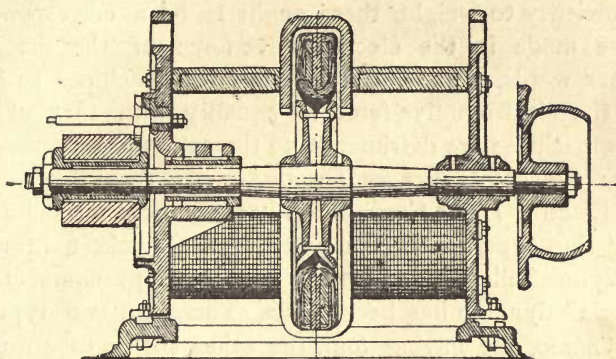

GÜLCHER'S DYNAMO (Section).

FIG. 119.

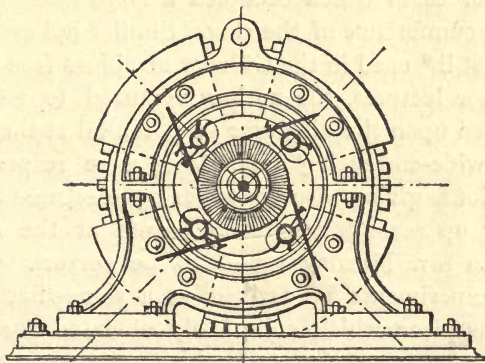

GÜLCHER'S DYNAMO (End Elevation).

4-pole machine, intended to give 65 volts, gave that figure exactly, when the external current varied from 30 to 88 ampères; and gave 64 volts at 105 ampères, 63·5 volts at 130 ampères. With 1 ampère only, the potential was 61·5 volts. Mr. Gülcher adds, that in spite of all possible

care in manufacture, very large machines do not give results as satisfactory as those given by machines of somewhat smaller dimensions, though the machines are of identical type and their parts calculated from the same formulæ. He thinks this to indicate, that to obtain the same ratio of output and efficiency to weight, there ought to be a corresponding increase made in the electromotive-force of the machine. In other words, the means taken in large machines to keep down the electromotive-force to equality with that of the smaller machines are detrimental to the action of the machine.

The Schuckert-Mordey Dynamo.—The Anglo-American Brush Electric Light Corporation has produced a dynamo of the flat-ring type, under the patents of Schuckert, Mordey, and Wynne-Sellon, to which the not very apt name of the "Victoria" dynamo has been given. There are two types of this dynamo, one having four, the other six poles arranged round the ring. Great attention has been given to the form of the pole-pieces. These pole-pieces in the earlier Schuckert machines, consisted, as mentioned above, of hollow iron shoes or cases which occupied a large angular breadth along the circumference of the ring. Similar hollow polar extensions are still * used in the Gülcher machines (see Fig. 118). In his Cantor lectures, the author ventured to express his opinion, based upon the diagrams of potential at the collector, that these wide-embracing pole-pieces were responsible for false inductions, giving rise to opposing electromotive-forces and setting up secondary neutral points at the collectors. That opinion Mr. Mordey found to be correct. By long-extended experiments he arrived at a somewhat narrower form of pole-piece which completely obviated these effects. As will be seen from Fig. 120, which represents the 4-pole Victoria dynamo, the pole-pieces, though they embrace the ring through its whole depth, from external to internal periphery, are quite narrow, and do not cover more than 30° of angular breadth of the circumference of the armature. They are of cast iron, and are cast upon the cylindrical cores

* The Gülcher dynamos shown at the International Exhibitions in 1884 and 1885 have the pole-pieces narrow.

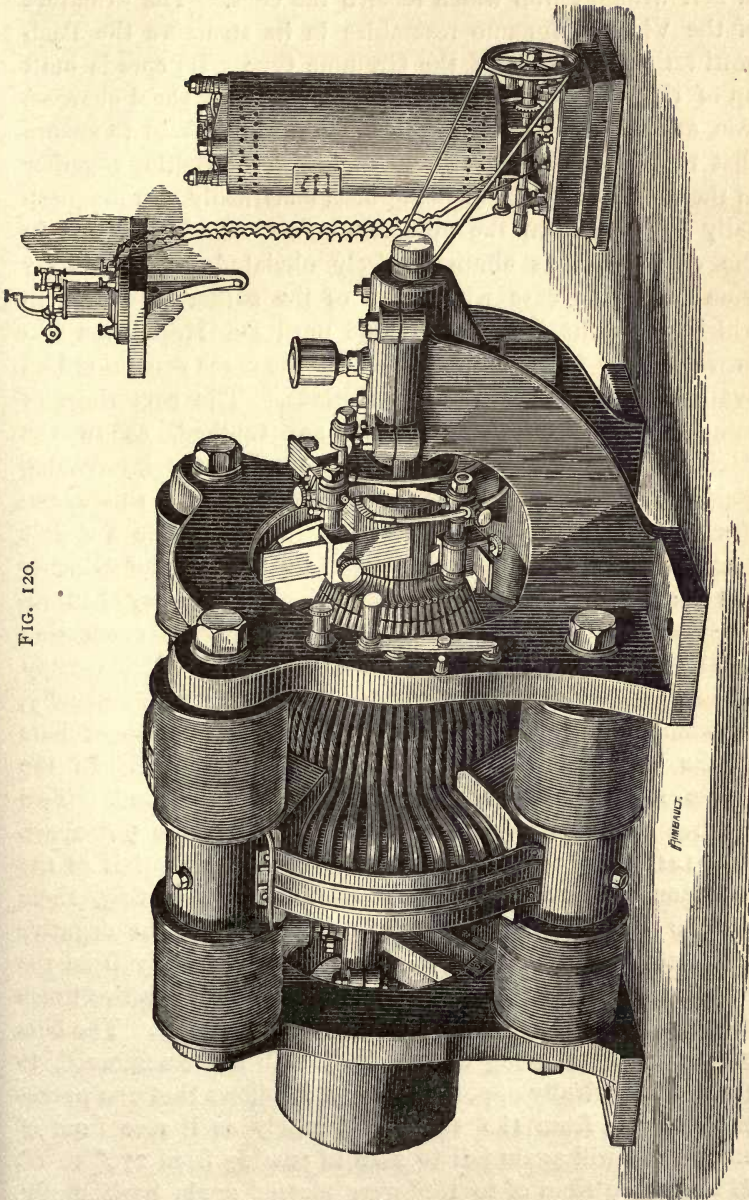

FIG. 120.

VICTORIA (SCHU CKERT-MORDEY) DYNAMO, WITH AUTOMATIC REGULATOR OF ANGLO-AMERICAN (BRUSH) CORPORATION.

of soft wrought iron which receive the coils. The armature of the Victoria dynamo resembles in its structure the Pacinotti rather than that of the Gramme type. Its core is built up of rings, or better still of hoops, cut from sheet charcoal iron, and special pains have been taken throughout to ensure that there are no electric circuits made in the bolting together of these cores, each layer being both electrically and magnetically insulated from the adjacent layers. Eddy currents in the core are thus almost entirely obviated. This was far from being the case with some of the earlier machines, in which, as in the Edison machine until Dr. Hopkinson improved it, the bolts holding together the cores constituted an available path for wasteful inductions. The core rings of some of the Victoria dynamos are toothed, as in the Pacinotti ring, and the wires are wound in the intervening gaps. There is, moreover, ample ventilation in this armature, a point not to be overlooked. Formerly, in a 4-pole machine, four brushes were necessary—as in the Gülcher dynamo and the 4-pole Gramme. Mr. Mordey has reduced the number to two, by the device, firstly, of connecting together those segments of the armature coils which occupy similar positions with respect to the poles; and, secondly, of connecting together, by metallic connexions, those bars of the collector which are at the same potential. In the 4-pole machine opposite bars are thus connected. Two brushes only are then necessary, and these are 90° apart. Fig. 121 gives the actual diagram of the potentials at the collector. There being sixty sections in the ring, there will be fifteen segments of the collector from the negative brush to the positive. The potential rises steadily from the negative brush, and becomes a maximum at the positive brush at 90° , whence it again diminishes to zero at 180° . The bars of the collector being connected, it will be remembered, to those diametrically opposite to them, it follows that the potential will rise from 180° to 270° , precisely as it rose from 0° to 90° , and will again fall to zero in passing from 270° to 0° . If the curve from 0° to 180° were plotted again horizontally, we should clearly see how nearly regular the rise and fall is.

Dynamo-electric Machinery.

If from this curve we were to construct another one, in which the heights of the ordinates should correspond to the tangent of the angle of slope of this potential curve—in other words, if we were to differentiate the curve—we should obtain a second curve—the curve of induction. It would show a positive maximum at about 30° , and a negative maximum at

FIG. 121.

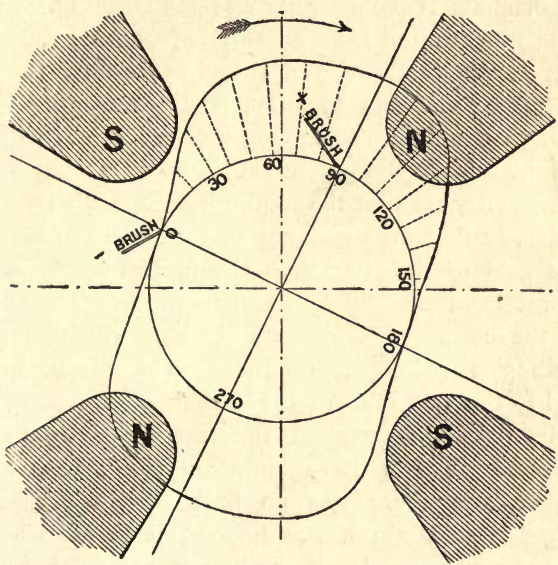

DIAGRAM OF POTENTIALS AT COLLECTOR OF VICTORIA DYNAMO.

about 120° , where the slope up and slope down are steepest in the potential curve. These maxima of induction are situated very nearly opposite the edges of the pole-pieces, on the side toward which the armature is rotating. Apparently the lines of force of the field are the thickest here. In this displacement of the maximum of induction, we have, probably, the explanation of the inferiority of the earlier machines with broad polar expansions. In those machines the maximum position of induction was displaced to the very edge of the broad pole-piece, and therefore the induction was sudden and

irregular. It is a singular result that while in those machines in which the ring armature is extended cylinderwise, there must be wide-embracing pole-pieces, in those in which the ring is flattened into a disk shape the pole-pieces must be narrow unless the field magnetism is very intense.

The Victoria dynamo is now usually compound-wound, having all the eight field-magnets wound with main-circuit coils inside and shunt coils outside. The external "characteristic" of this machine is wonderfully straight (see Fig. 277). In a "D²" machine, wound for a potential of 60 volts, the following values were obtained:—Open circuit, 58 volts; 10 ampères, 58·5 volts; 20 ampères, 59 volts; 60 ampères, 59·7 volts; 90 ampères, 59·9 volts; 120 ampères, 60 volts. It will be seen that for small loads the potential drops a little; but it is under these circumstances that the engine speed usually rises slightly in practice, so that the constancy of the potential between the mains is somewhat better than the figures would show. In actual practice, the regulation is marvellous. The author has opened the circuit of a Victoria dynamo which at the time was feeding 101 lamps, 100 being at a distance, 1 lamp attached to the terminals of the machine. On detaching the main wire from the terminal, the 100 lamps were suddenly extinguished. The solitary lamp on the machine did not even wink, and there was no flash at the brushes. The sparking was so slight it was impossible to tell whether the machine was an open circuit or whether it was doing full work. The lead was the same under all loads. There are not many dynamos that can show a result of this kind. According to measurements made by the Anglo-American Corporation's electricians, who have published the figures entire, the factor of conversion or "gross efficiency" of this machine is 96·15 per cent., the electrical efficiency 85·68 per cent. These values assume the B.A. unit of resistance as the true ohm, and are, therefore, probably about $1\frac{1}{2}$ per cent. too high. Some of these machines are wound for slow speeds for ship lighting. These machines have an electrical activity slightly higher, and an efficiency slightly lower, than the high-speed machines. They also have field-magnet cores slightly heavier, requiring,

therefore, the expenditure of rather more electrical energy in maintaining the field. These remarks refer, of course, to a comparison between machines wound to light an equal number of lamps, and to work at an equal electromotive-force.

The development of the Victoria machine from the original Schuckert machine commenced, under the auspices of the electricians of the Brush Corporation, with the discovery by Mr. Mordey, by the aid of his method of examining the distribution of potentials round collectors, that there was in the machine a point at a considerable distance in front of each brush, having the same potential as the brush, and that the whole of the portions of the armature between these equipotential points were useless, or worse than useless, as they were occupied only in producing an opposing electromotive-force. In some of the Schuckert dynamos these useless portions occupied more than half of the armature. By reducing the size of the pole-pieces, space was found for a 4-pole field, the effect of the change being that, from the same ring as employed by Schuckert with a 2-pole field, the electrical output was doubled, without increase of speed.

A larger type of Victoria machine, having six poles alternately N. and S. set round the ring, has also been constructed by the Anglo-American Corporation. This machine (Fig. 122) illuminates 500 incandescent lamps. As each segment of the collector is connected with those situated at 120° and 240° distance round the set, only two brushes are required.

M. Gramme has recently designed a dynamo having a flat-ring armature rotating within a crown of twelve poles. The pole-pieces are broad, nearly meeting one another. One would confidently predict from such a design the vice of sparking at the brushes. Moreover, there are no fewer than twelve brushes! Think of the friction of twelve brushes, and the labour of making the complicated holders. It appears that in England we are at least a few steps a-head of France in the matter of designing dynamo machines.

The present drift toward multipolar dynamos of this type is very significant. There is little difference save in detail between the 4-pole machines of Gülcher, and of Schuckert, and the more recent Victoria dynamo, albeit these dif-

FIG. 122.

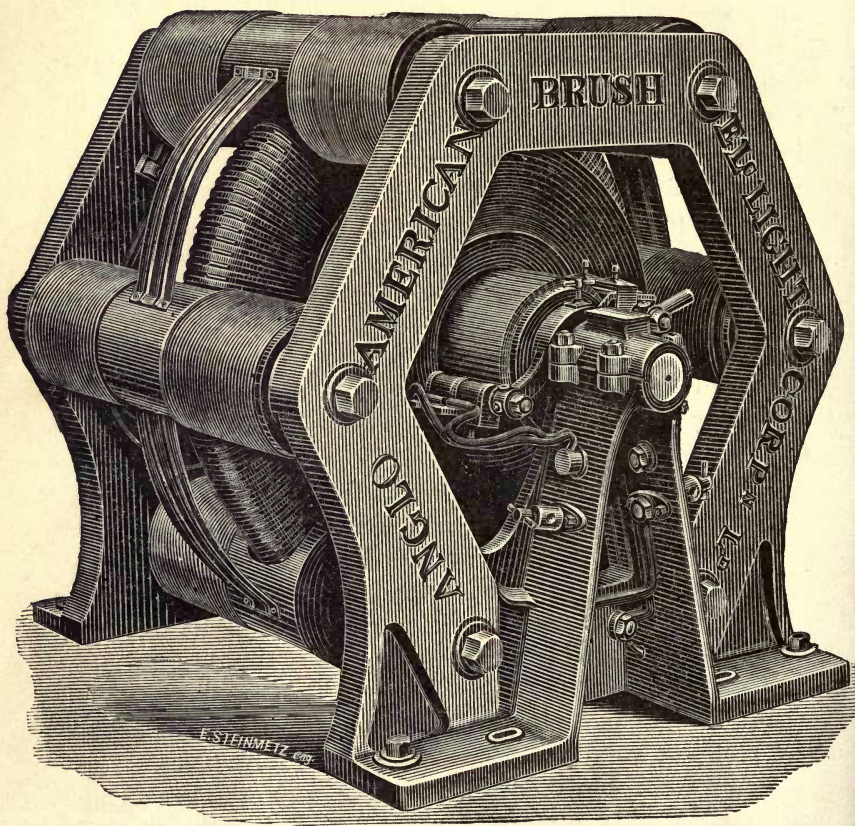

VICTORIA (SCHUCKERT-MORDEY) DYNAMO (6-POLE).

ferences are not unimportant. But all these constructors agree in adopting the flat ring. The advantage originally claimed for this construction, namely, that it allows less of the total length of wire to remain "idle" on the inner side of the

ring, is rather imaginary than real, for the total resistance of the armature is but a small fraction of the whole resistance of the circuit; and it is possible to spread the field so as to make all parts of the wire active without any gain whatever, if by this spreading there is no increase on the whole in the total number of lines of force in the field. The real reasons in favour of multipolar flat-ring armatures appear to be the following:—First, their excellent ventilation; second, their freedom from liability to be injured by the flying out of the coils by the tangential inertia (often miscalled centrifugal force) at high speeds; third, their low resistance, due to the fact that the separate sections are cross-connected, either at the brushes or in the ring itself, in parallel arc. To these may be added that, with an equal peripheral speed, the armature rotating between four poles undergoes twice as much induction as when rotating between two poles; since it cuts the lines of force twice as many times in the former case as in the latter. Another reputed point of advantage is less easy to express. It would appear from some experiments of M. Marcel Deprez, that for an electro-magnet to work most advantageously its length must not be greater than three times its average thickness. The flat ring, regarded as an electro-magnet, works at greater advantage when there are four poles instead of two, because the length from pole to pole is shorter relatively to the thickness of the ring.

It may be mentioned that as in Messrs. Crompton's compound dynamos, so also in those of the Anglo-American Corporation, the series coils are wound direct upon the iron cores, and the shunt coils outside them, thus reversing the practice adopted by Messrs. Siemens and by Mr. Gülcher.

Other Ring-armature Dynamos.—Several other ring-armature dynamos exist. In that of Fein, the pole-pieces are carried round to the inner circumference of the cylindrical ring in the hope of utilising the wire on the inner face. A similar device is adopted by Schwerd and Scharnweber. In a machine by Fitzgerald, the ring is almost entirely surrounded by the comparatively small electro-magnets. Edelmann of Munich constructs a dynamo with a cylindrical ring placed

between the ends of two substantial horizontal magnets. The Lumley dynamo has also a cylindrical ring wound upon a core built up of rings stamped out of thin iron having lugs projecting internally to carry off heat to the central spindle by conduction. A machine was shown in 1881 at the Paris Exposition by Messrs. Siemens, in which the field magnet, of simple shuttle-wound form, rotated within a fixed ring armature. The brushes of this so-called "Topf-Maschine" rotated against a fixed collector. Information respecting several of these dynamos, and of others of less note, may be found in Dredge's *Electric Illumination*, in the official report of the Munich Exhibition of 1882, in Schellen's *Magnet-und-Dynamo-Elektrischen Maschinen*, and in the periodical journals devoted to electricity. The peculiar ring used in the Brush dynamo is described below in the chapter on "Open-coil" Dynamos.

Drum Armatures.

Siemens' Dynamo.—The drum armatures of all types may all be regarded as modifications of Siemens' well-known longitudinal shuttle-form armature of 1856, a multiplicity of sections of the coils being employed to afford practical continuity in the currents. The drum pattern was invented in 1872 by Von Hefner Alteneck, of the firm of Siemens and Halske of Berlin.

The advantages of the drum form of armature appear to be (1) requiring somewhat less wire than the ring armature of equal size, (2) being free from liability to false inductions (p. 61) and therefore more independent of the form of the pole-pieces. Drum armatures are, however, more difficult of construction in general, and are not so readily ventilated as ring armatures.

In some of the earlier patterns of Siemens' machines the cores of the drum are of wood, overspun with iron wire circumferentially before receiving the longitudinal windings. In another of their machines there is a stationary iron core, outside which the hollow drum revolves; in other machines, again, there is no iron in the armature beyond the driving-

spindle. In all the Siemens armatures the individual coils occupy a diametral position with respect to the cylindrical core, but the mode of connecting up the separate diametral sections is not the same in all. In the older of the Alteneck-Siemens windings the sections were not connected together symmetrically, the connexions (for an 8-part collector) being as in Fig. 123. In the more recent machines a symmetri-

FIG. 123.

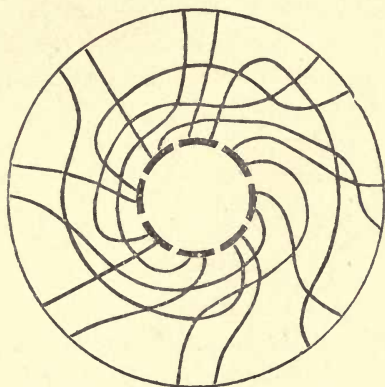

DIAGRAM OF CONNEXIONS OF SIEMENS WINDING (OLD).

cal plan has been adhered to, as shown in Fig. 124. In this system, as in the Gramme ring, the successive sections of coils ranged round the armature are connected together continuously, the end of one section and the beginning of the next being both united to one segment or bar of the collector. A symmetrical arrangement is, of course, preferable, not only for ease of construction, but because it is important that there should never be any great difference of potential between one segment of the collector and its next neighbour; otherwise there will be increased liability to spark and form arcs across the intervening gap.

In Fig. 124 the eight sections are shown for simplicity as if each consisted of one turn only. For example, beginning at the segment of the collector marked 1, the wire ascends to 1', thence passes along the drum, descends along a diameter,

returns longitudinally along the lower side of the drum to the point marked 1", whence it is brought up to the second segment of the collector; from the second segment the second section of the winding proceeds in like manner. In ordinary Siemens armatures there are in reality eight turns in each section: the wire after ascending to 1, wrapping eight times round the cylinder and finally turning

FIG. 124.

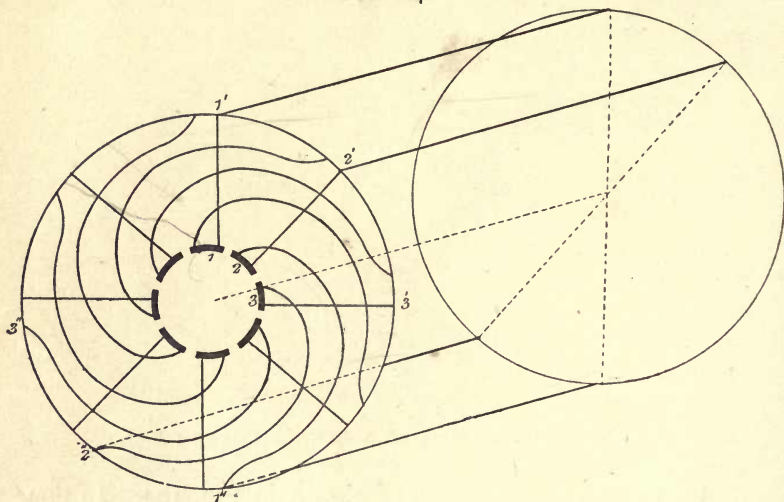
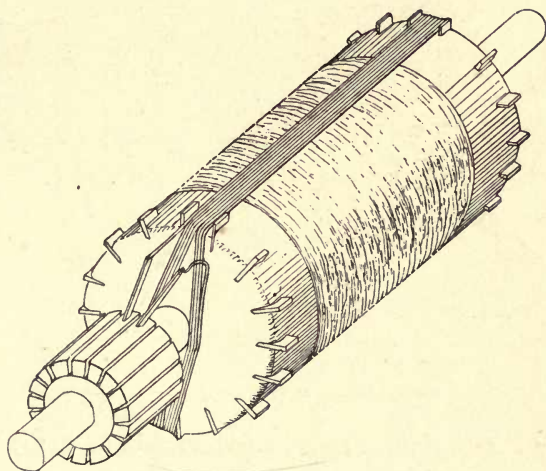

DIAGRAM OF CONNEXIONS OF SIEMENS WINDING (NEW).

down to join the second segment. The actual present process of constructing the armature is shown in Fig. 125. Upon the axle are secured by pins two stout cheeks of gun-metal to form the ends of the drum. Between these, and resting on an inner projecting rim, is wrapped a thin sheet of iron, and over this a quantity of soft iron wire is wound to form a core, as in the Gramme armature. A number of cuts equal to the proposed number of segments, are sawn radially in the end faces of the gun-metal cheeks, and in these cuts small boxwood wedges are inserted to facilitate the winding. The coiling of the sections is done in the following manner:—The wire is carried along the drum, as shown, four of the strands passing to the left, four to the right of the axle at

either end, and is then ready to be turned over to meet the connecting piece of the second segment of the collector. From this point the next section will start in a like manner; but before the second section is wound the drum is turned completely over, and the section diametrically opposite to section No. 1 is wound on the top of the eight strands already wound. Thus, in a 16-part armature, section No. 9 lies on the top of section No. 1, No. 10 on the top of No. 2, and so on, there being two layers of coils all over the drum. The object of this arrangement is to ensure that parts which

FIG. 125.



METHOD OF WINDING SIEMENS ARMATURE.

are at very different potentials shall never come in contact with one another. Although, for the sake of rendering the connexions more intelligible, the collector is shown in Fig. 125 in its place on the axle, it is not, as a matter of fact, put into its place until after all the sections have been wound, the ends of the wires being temporarily twisted together until all can be soldered to the connecting strips of copper. In some of the armatures intended for electro-plating machines there are four layers of wire, and the wires are connected together four or eight in parallel to reduce the resistance.

The field magnets in the earlier patterns of Siemens dynamo were horizontally placed (Fig. 126) and consisted of a row of wrought-iron cores, arched where they passed near the armature, and bolted together at their outer extremities : the coils, which are wound on flat brass frames, being slipped on before the cores are bolted down. In some more recent

FIG. 126.

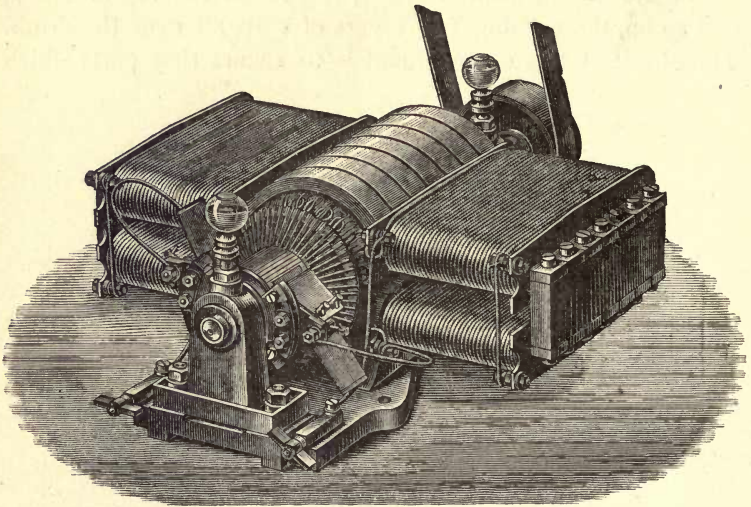

SIEMENS DYNAMO, HORIZONTAL PATTERN.

machines a vertical position is preferred, as in Figs. 127 and 128. In all these forms the arched cores are removable, and in the larger sizes the top half of the machine can be unbolted and removed from the lower half. In the most recent machines there is a provision for ventilating the cores of the magnets, an air space being left in the brass frames of the coils on the outer side. Some account of the compound-wound machines made by the firm has been given by Herr E. Richter in the *Elektrotechnische Zeitschrift*. It appears that three methods of combination have been tried. The shunt and series coils have been wound on different arms of the magnets ; they have been wound on separate short frames, and slipped on to the cores side by side, and they have been also wound

over one another. In the latest machines, the series coils are wound outside the shunt windings. The regulation, judging by the curves given by Herr Richter, is not perfect. The best regulation was from a "g D 17" machine, of which two of the magnet limbs were wound with shunt coils of twenty-

FIG. 127.

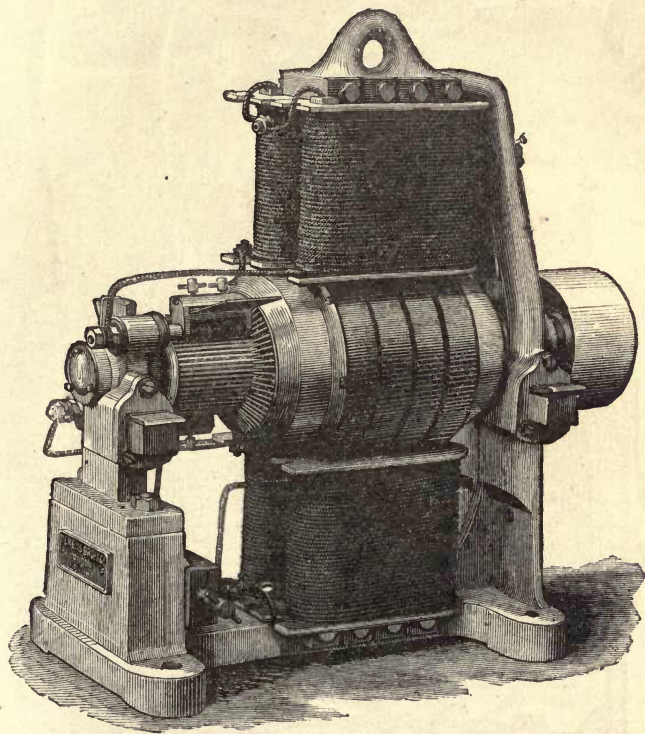

SIEMENS DYNAMO, VERTICAL PATTERN.

nine layers of a 1-millimetre wire, and the other two with two layers of a 3.5-millimetre wire. The potential varied from 64 to 69 volts when the number of lamps was reduced from twenty to nine (see curve, Fig. 277).

Since then the firm has constructed dynamos in which the potential does not vary 1 per cent. between the limits of

FIG. 128.

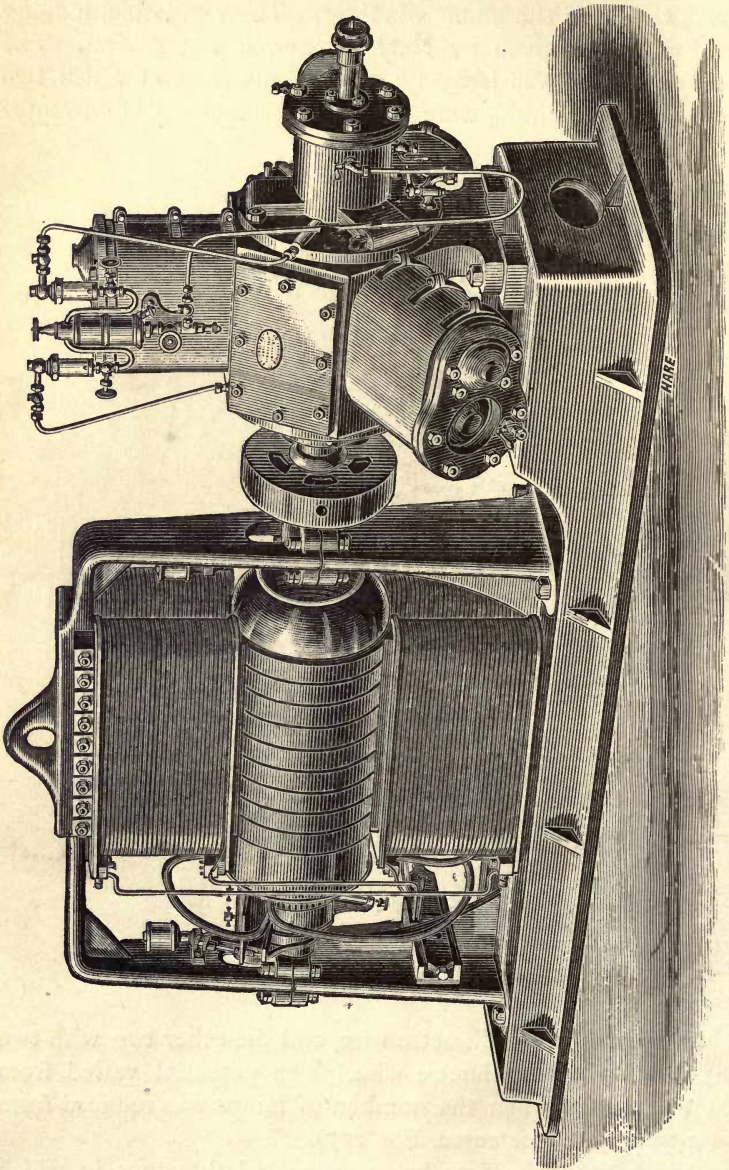

SIEMENS COMPOUND DYNAMO DRIVEN BY BROTHERHOOD ENGINE.

working.* Some very large machines of the vertical pattern but with many improvements in detail have been constructed, including three 112-unit compound-wound dynamos, "B 13" pattern, for use at the Inventions Exhibition of 1885. Each

FIG. 129.

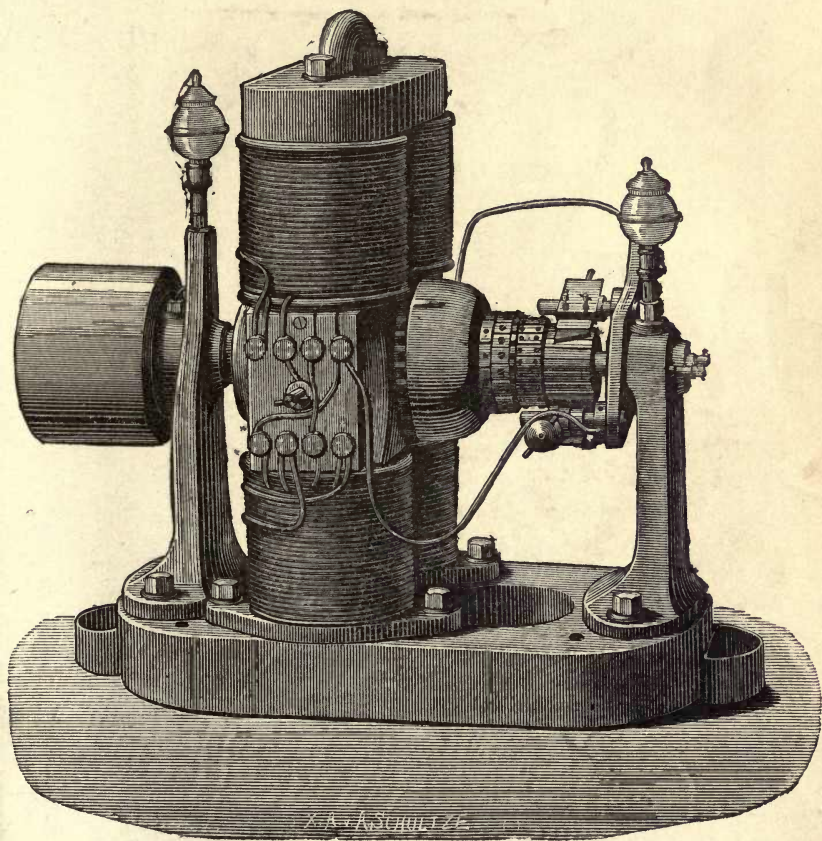

SIEMENS DYNAMO (1885) "F 17."

of these is capable of yielding 450 ampères at a potential of 250 volts, making an output of 112,500 watts, when running

* See series of papers in the *Elektrotechnische Zeitschrift*, March—June 1885, by Dr. O. Frölich.

at 300 revolutions per minute only. The armatures are wound with flat strip-copper.

The newest patterns of Siemens dynamo show progress in

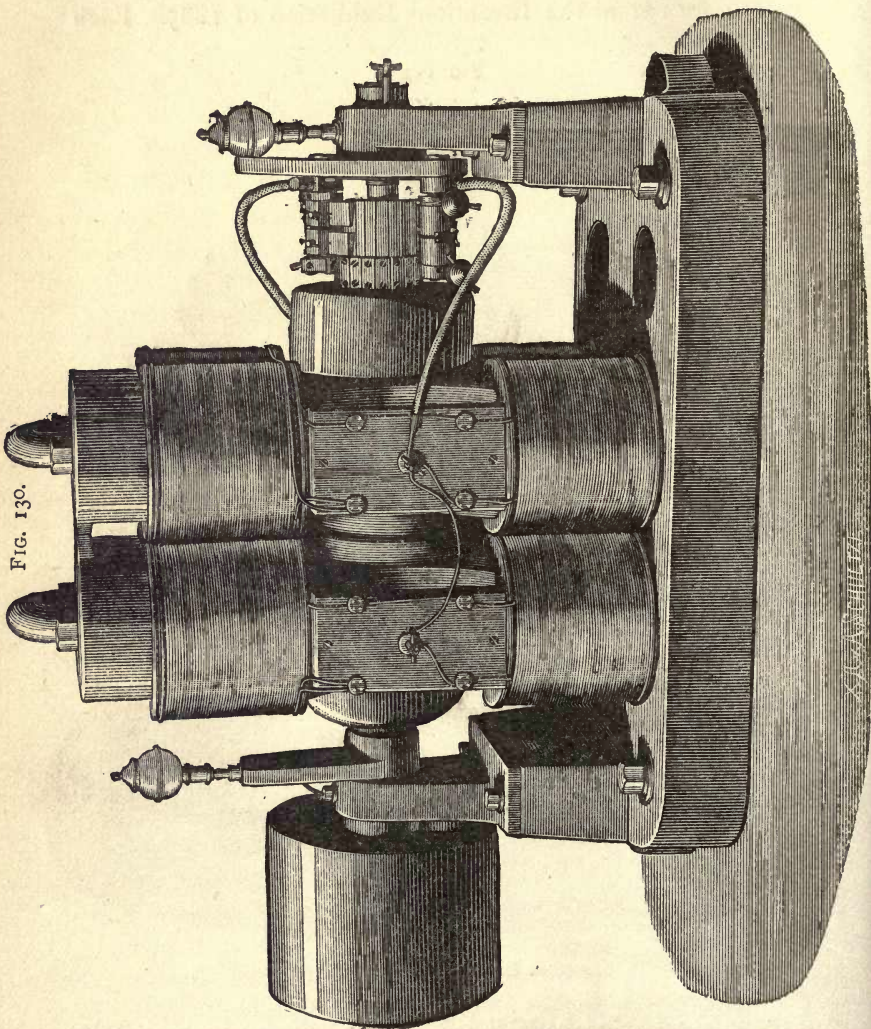

the direction of increasing the quantity of iron in the electro-magnets. The form of the new machines may be judged from Fig. 129, the substantial proportions of which the reader

should compare with those of the older form (Fig. 127). The cores are heavy, adding to the mechanical stability of the machine as well as to its electrical steadiness; but they are of cast iron, a retrograde step. The pulleys are also considerably enlarged in these machines, with great advantage to regularity of driving. The form shown in Fig. 130 has been adopted for enabling a machine of double power to be constructed with the same pattern of casting. The device of grouping the field magnets in parallel sets is bad, for the reasons discussed in Appendix VII., though used by Gramme (p. 123), Edison (p. 163), and others. The collectors of the new machines are more massive, and insulated by air-gaps. The brushes are now made adjustable; and they are trimmed with oblique ends so as to touch two collector-bars at once. Still more curious, not only do the pole-pieces *not* embrace any great arc of the armature (as in the ring-armature machines), but they are made considerably *thinner* than the rest of the field-magnet cores. This latter feature does not accord with the recommendations of the author or with the general practice of constructors; the former is unimportant, for in dynamos with drum armatures the arc embraced by the pole-piece affects the distribution of the induction less than is the case with ring armatures.

The Siemens alternate-current dynamo (Fig. 183) is described on p. 210; the Siemens unipolar dynamo (Fig. 202), on p. 225; and the Siemens electro-plating machine (Fig. 210), on p. 237.

The Edison Dynamo.—There are several forms of Edison dynamo, all having drum armatures rotating between heavy iron pole-pieces. The “Z” machine, capable of working sixty Edison lamps, is shown in Fig. 131. The field magnets are of extraordinary length, and of circular section, with a heavy yoke at the top. There is but one layer of wire on the cores. In Edison’s modification of the drum armature, the winding, though symmetrical in one sense, is singular, inasmuch as the number of sections is an odd number. In the first machines there were seven paths, as shown in Fig. 132, taken from Edison’s British Patent Specification. In his giant “steam-

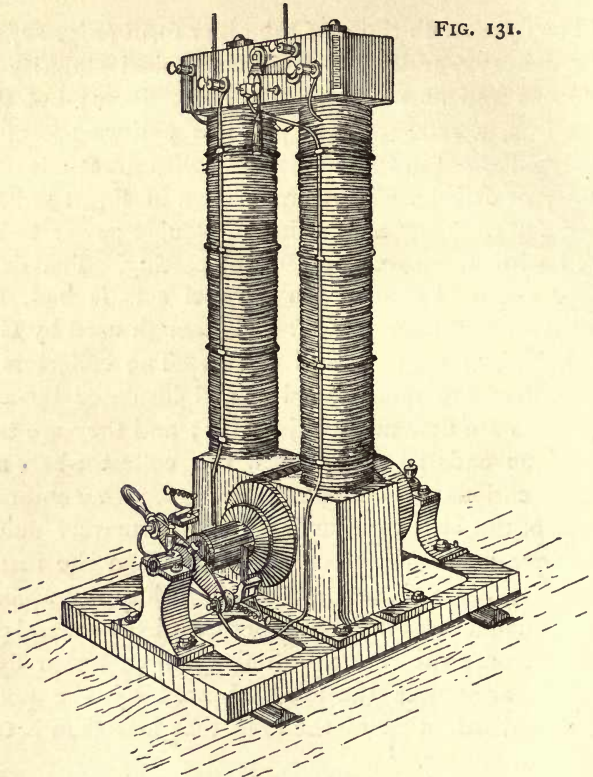

FIG. 131.

EDISON DYNAMO, "Z" PATTERN.

FIG. 132.

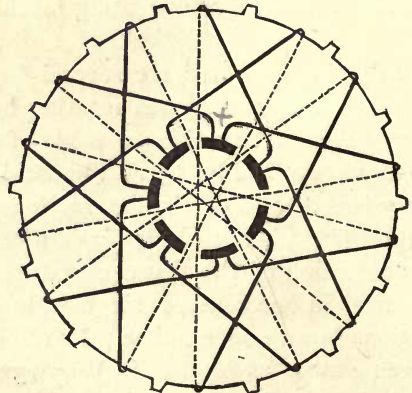
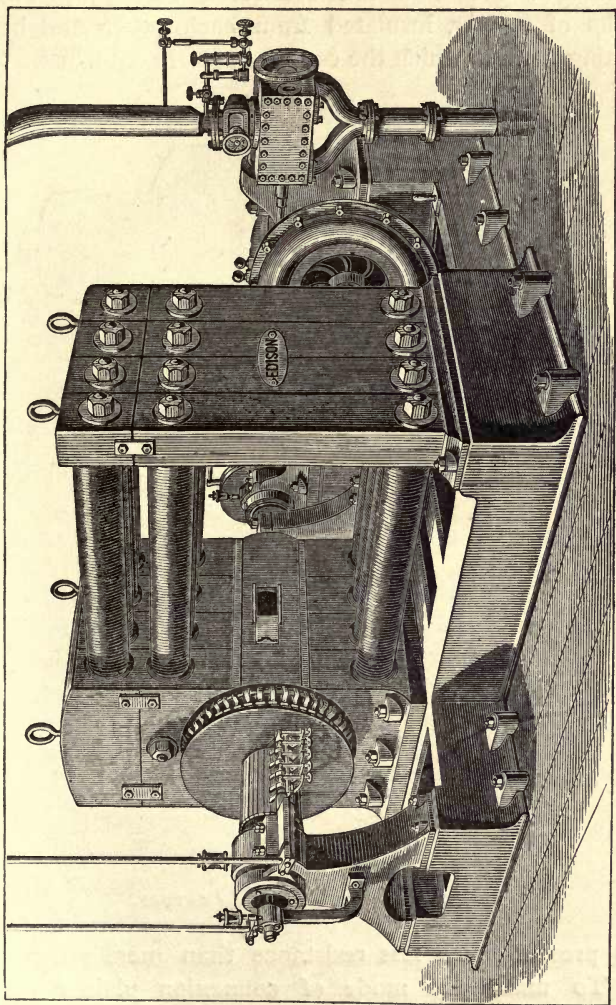

DIAGRAM OF EDISON ARMATURE.

dynamo" (Fig. 133) the number of sections is forty-nine. One consequence of this peculiarity of structure is, that if the brushes are set diametrically opposite to one another, one will

FIG. 133.



EDISON'S "STEAM DYNAMO."

touch the middle of a bar of the collector at the instant when the other slides from bar to bar. In Edison's larger dynamos the armature is not wound up with wire, but, like some of

Siemens' electro-plating dynamos, is constructed of solid bars of copper, arranged around the periphery of a drum. Fig. 134 shows the armature removed from the machine. The ends of the bars are connected across by washers or disks of copper, insulated from each other, and having projecting lugs, to which the copper bars are attached. Such

FIG. 134.

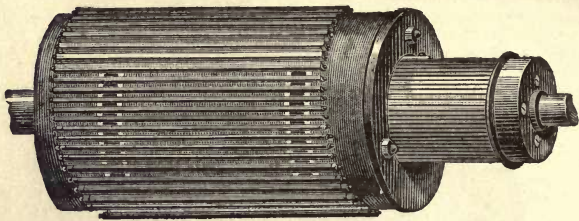

ARMATURE OF EDISON DYNAMO.

FIG. 135.

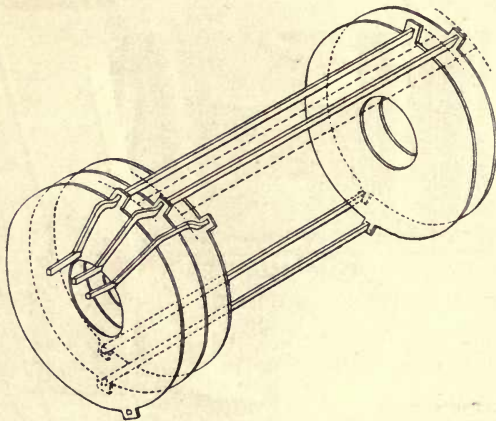

CONNEXIONS OF EDISON ARMATURE.

disks present much less resistance than mere strips would do. To make the mode of connexion plainer the diagrammatic sketch of Fig. 135 is given. The connexions are in the following order:—Each of the forty-nine segments of the collector is connected to a corresponding one of the forty-nine disks at the anterior end of the drum;

and this disk is connected, by a lug-piece on one side, to one of the ninety-eight copper bars. The current generated in this bar—say, for example, the highest of the three bars shown in Fig. 135—runs to the further end of the machine, enters a disk at that end, crosses the disk, and returns along a bar diametrically opposite that along which it started. The anterior end of this bar is attached to a lug-piece of the next disk but one to that from which we began to trace the connexions: it crosses this disk to the bar next but one to that first considered, and so round again. The two lug-pieces of the individual disks at the anterior end are, therefore, not exactly opposite each other diametrically, as the connexions advance through $\frac{1}{48}$ of the circumference at each of the forty-nine paths. To simplify matters, in the drawing the alternate disks and bars are only indicated in dotted lines. Just as the two bars shown at the bottom are the returns for the currents in the top bars, so there must be top bars provided as returns for the currents in those bars (not shown) which start from the segments of the lower half of the collector. The dotted lines show the position of these return bars. It will be noticed in Fig. 133,* that the collector is very substantially built and that a screen is fixed between the collector and the rest of the armature, to prevent any copper-dust from flying back or clogging the insulation between the bars or disks. There are no fewer than five pairs of brushes, the tendency to sparking being thereby greatly reduced. The figure does not show the structure of the armature itself, nor indicate the means taken to suppress eddy currents. The core of the armature is made of very thin disks of iron, separated by mica or paper from each other, and clamped together. Some exception may be taken to the use of such stout copper bars, as being more likely to heat from local currents than would be the case if bundles of straps, or laminæ of copper were substituted; and, indeed, the presence of the 4 horse-power fan to cool the armature, is suggestive that continuous running is liable to heat the armature.

* Taken, by permission of Messrs. Macmillan and Co., from the author's *Elementary Lessons in Electricity and Magnetism.*

The field magnets of all the larger machines turned out by Edison have a number of stout iron columns as cores to receive the coils. Experience has shown that this arrangement is defective.

The Edison dynamo has recently received very material improvements at the hands of Dr. John Hopkinson. Some of these improvements relate to the field magnet; others to the armature. Dr. Hopkinson has, in the first place, abolished the use of the multiple-field magnets, which in Edison's "L," "K," and "E" machines were united to common pole-pieces; and instead of using two, three, or more round pillars of iron, each separately wound, he puts an equal mass of iron into one single solid piece of much greater area of cross-section and somewhat shorter length. One such iron mass, usually oval or oblong cross-section, is attached solidly to each pole-piece, and the two are united at the top by a still heavier yoke of iron. The machines have, consequently, a more squat and compact appearance than before (Fig. 136). It may be remarked, in passing, that the use of multiple pillars of iron (used by Edison in the "L," "K," and "E" machines) must have been prejudicial, because the currents in those portions of the coils which pass between two adjacent iron pillars must have been opposing each other's magnetising effect. Dr. Hopkinson has also introduced the improvement of winding the magnets with a copper wire of square section, wrapped in insulating tape. This wire packs more closely round the iron cores than an ordinary round wire. In the armature the following change has been made. The iron core in the older Edison machines was made of thin iron disks, separated by paper, slipped on over a sleeve of *lignum vitæ*, and held together by six longitudinal bolts passing through holes in the core plates, and secured by nuts to end plates. These bolts are now removed, and the 500 plates are held together by great washers, running upon screws cut on the axle of the armature. The size of the central hole in the plates has been diminished, thus getting into the interior more iron, and providing a greater cross-section for the magnetic induction. By these improvements, a machine

occupying the same ground space, and of about the same weight as one of the older "L" 150-light machines, is able to

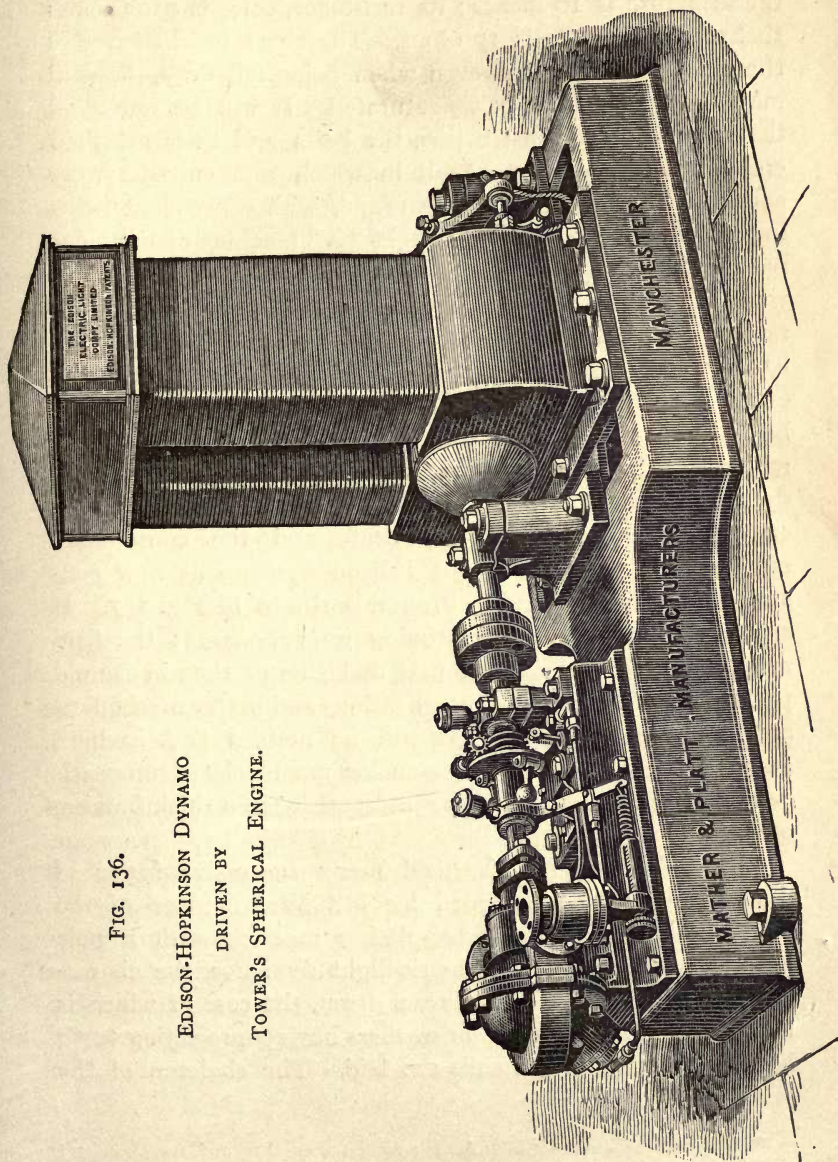

FIG. 136.

EDISON-HOPKINSON DYNAMO
DRIVEN BY
TOWER'S SPHERICAL ENGINE.

supply 250 lights, the economic coefficient being at the same time higher. In the new 250-light machine, the diameter of the armature is 10 inches; its resistance, cold, is 0.02 ohm; that of the magnets is 17 ohms. The characteristic curve of the machine shows that even when doing full duty, the field magnets are far from being saturated. It will be remarked that, in the older construction, the bolts and their attached end-plates furnished a circuit in which idle currents were constantly running wastefully round, with consequent heating and loss. An Edison 60-light "Z" machine of the older pattern, tested by the Committee of the Munich Exhibition, was found to give an efficiency which, if measured by the ratio of external electric work to total electric work, exceeded 87 per cent.; but its commercial efficiency—the ratio of external electric work to mechanical energy imparted at the belt—was only, at the most, 58.7 per cent. In some tests made by Mr. F. J. Sprague, at Manchester, on a 13-unit dynamo (a 200-light machine), the efficiency of electrical conversion exceeded 94 per cent., and the commercial efficiency 85 per cent.* The Edison dynamo as now constructed in America and in France, is shown in Fig. 137. It embodies many of the preceding improvements: the field magnets being more substantial and shorter than in the old pattern (Fig. 131), with longer bearings and better mechanical arrangements in general. It will be noticed that in both forms the pole-pieces of the machine are insulated magnetically from the bed-plate by the interposition of a thick framing of zinc or brass.

Weston's Dynamo.—A good many successive forms of dynamo have been designed by Mr. Weston; one of the earliest being a small electro-plating machine with a pole armature. In Weston's electric light dynamos, the characteristic feature is the armature, a drum, the core of which is built up of thin iron disks or washers having projecting teeth between which the wire coils are laid. The skeleton of the

* These values assume the B.A. unit as the true ohm, and are, therefore, about $1\frac{1}{2}$ per cent. too high.

FIG. 137.

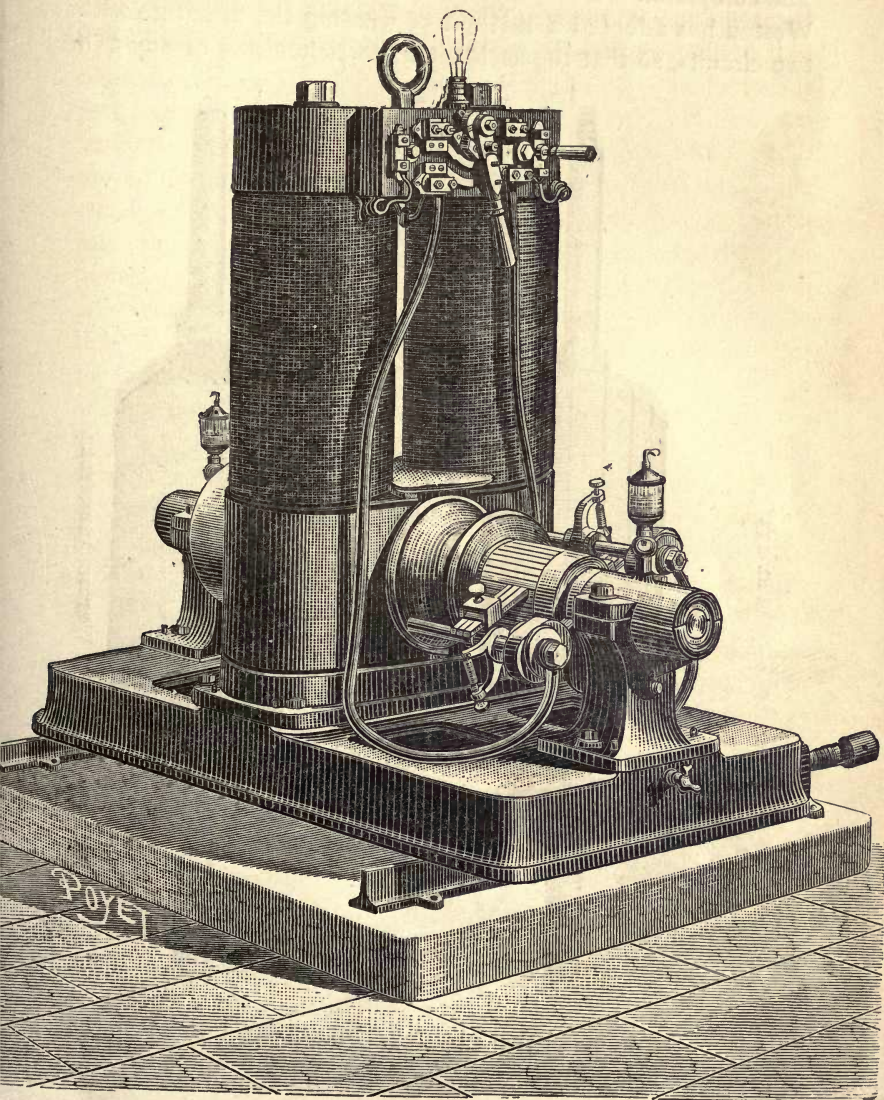

THE EDISON DYNAMO (1885).

armature is depicted in Fig. 138, together with one of the disks. The completed armature is shown in Fig. 139. Recently Mr. Weston has adopted a method of winding the armature with two circuits, so that the accidental short-circuiting of any two

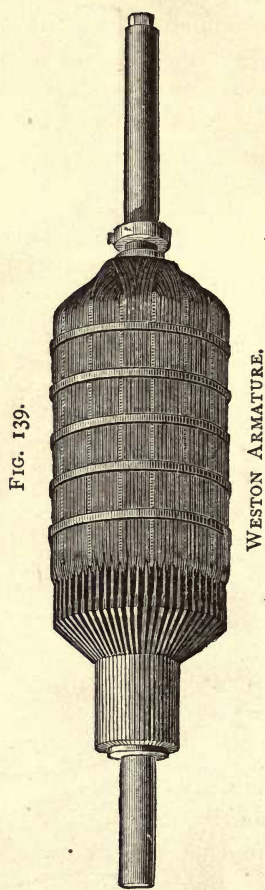
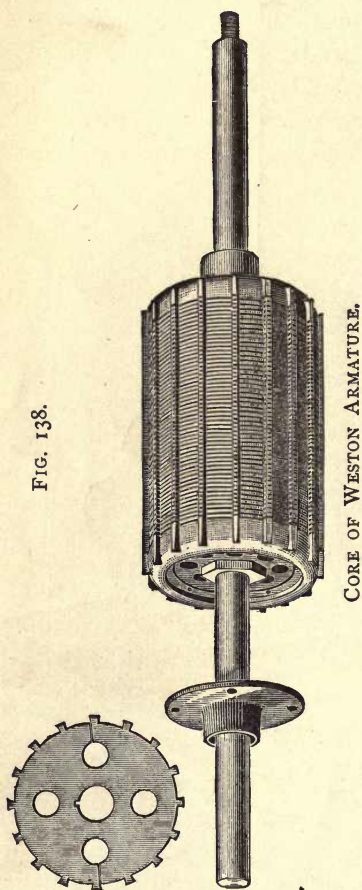

adjacent segments of the collector shall not cause the armature to break down by the over-heating of the short-circuited section.

The recent Weston machines show substantial design, and many improvements in detail upon the older forms. In this

machine, as is also evident from Fig. 140, the pole-pieces are laminated, to obviate eddy currents and heating. The magnets are shunt-wound; and Mr. Weston succeeded in working up the intensity of the field to such a degree that the number of turns of wire on the armature could be reduced in a manner previously unattained, though since surpassed. His armature has a 24-part collector and there are twenty-four sections *each of one turn only* and of very thick wire. The resistance of the armature is therefore excessively low, and is practically negligible. As a consequence of the very small

FIG. 140.

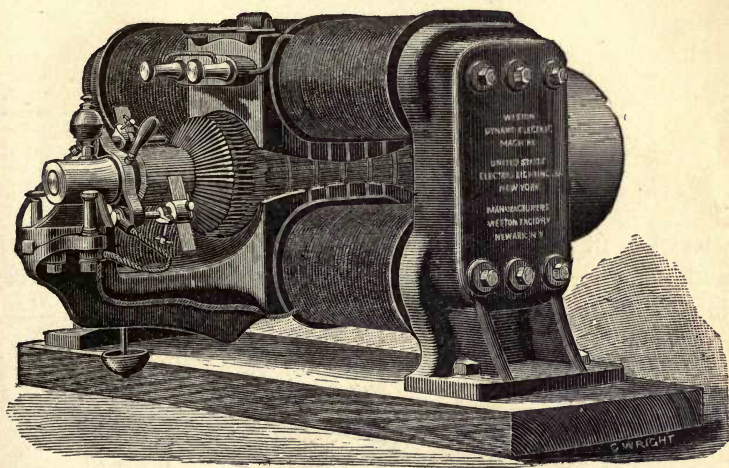

WESTON DYNAMO.

number of coils, the armature current produces very little shifting of the field; and in consequence of the very small internal resistance, the difference of the potential at the terminals is, with a constant speed, practically constant. With this machine, which is not compound-wound, but which is self-regulating simply because its internal resistance is *nil*, it is possible to turn off 99 out of 100 lamps at once, leaving one lamp burning. The armature resistance is inappreciable in comparison with that of the 100 lamps in parallel, that is to say inappreciable beside half an ohm.

The Elphinstone-Vincent Dynamo.—In the Elphinstone-Vincent dynamo there is a drum armature of a somewhat distinct order, the separate coils being laid upon the sides of a hollow *papier-mâché* drum in an overlapping manner, and

FIG. 141.

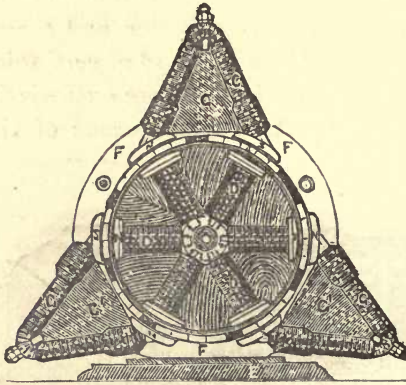

ELPHINSTONE-VINCENT DYNAMO (Section).

curved to fit it. The field is a complex one, with six external and six internal poles, as shown in Fig. 141, and is very intense, owing to the proximity of these poles. The sections

FIG. 142.

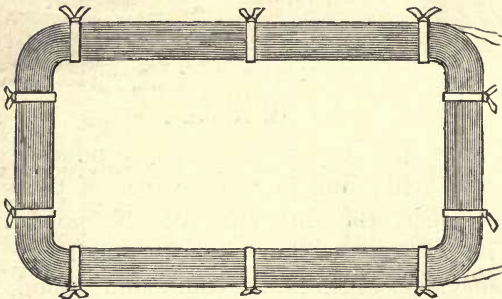

SINGLE COIL OF ELPHINSTONE-VINCENT DYNAMO.

of the armature of this machine are wound separately in parallelogram forms like that shown in Fig. 142, and the separate sections are then fixed upon the periphery of the *papier-mâché* cylinder, which is mounted so as to rotate between the ex-

ternal and internal field magnets whose poles reinforce one another. In the recent machines, the parallelograms of wire are so arranged that the overlapping ends lie outside the

FIG. 143.

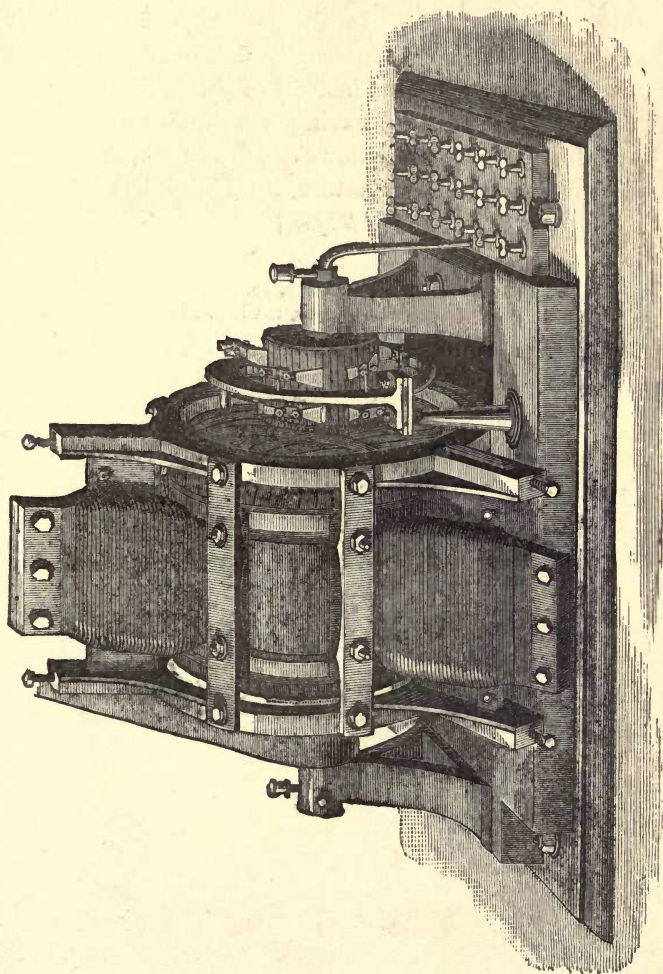

ELPHINSTONE-VINCENT DYNAMO.

ends of the polar surfaces of the field magnets, which, therefore, can be brought very close to the surface of the rotating cylinder. The parallelogram-shaped coils may be connected together so as to work as three machines, and

feed three pairs of brushes; which may again be united, either in series or in parallel, or may be used to feed three separate circuits. A general view of the "E" machine (Fig. 143), shows the arrangements of the parts and the mounting of the brushes. In the latest machines the segments of the collector are internally cross-connected, so that only two brushes are needed instead of six as formerly.

A very similar machine, having a hollow drum armature, has been designed by Zipernowsky;* and another dynamo with an almost identical armature, by Thury, has lately been described in *La Lumière Électrique*.†

* *Electric Illumination*, p. 10.

† *La Lumière Électrique*, t. xii. p. 212.

CHAPTER VIII.

TYPES OF MACHINES (*continued*).

Dynamos of Class I. (B).

OPEN-COIL ARMATURES.

As explained on p. 28, it is possible to construct armatures in which the separate coils or sections of the windings are not united together into one closed circuit. An example is given in Fig. 144. This diagram (which should be compared

FIG. 144.

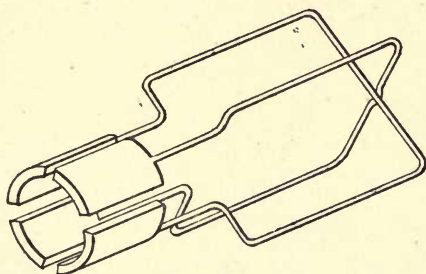

SIMPLE OPEN-COIL ARMATURE.

with Fig. 20, p. 23) shows an armature consisting of two separate loops, set in planes at right angles to one another, so that when one is passing through the inactive region the other is in the position of maximum action. There is no reason why these two loops should not have each a separate 2-part commutator like that of Fig. 20; and one pair of brushes might press on both commutators. It is, however, obviously more convenient to unite these two commutators into a single one of four parts, as in Fig. 145; and then it will at once be seen that as this rotates between its pair

of brushes one loop only will be in action at once, the other loop being cut out of circuit for the time being. It would clearly be possible to arrange any number of loops or coils in this way so that only that loop or coil which was passing through the position of maximum action should be feeding the brushes, all the rest being meantime open-circuited. A ring armature wound in sections might of course be similarly arranged, so that the pairs of sections had each a separate commutator; and Fig. 145 (which should be compared with

FIG. 145.

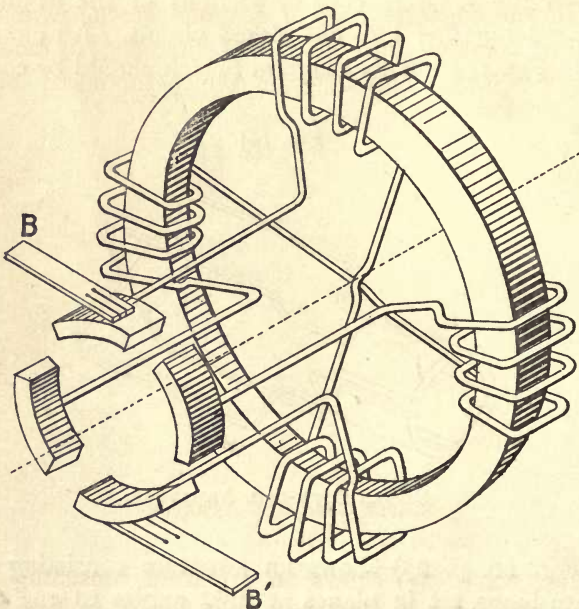

FOUR-PART OPEN-COIL RING ARMATURE.

Fig. 27, p. 25) shows such a ring, but with the two commutators cut down and formed into a 4-part collector.

It will be noticed that each coil is joined at the back to the one diametrically opposite to it, and that the front ends of the coils pass to the commutator. As a matter of fact, it would make no difference in either of these armatures were

the wires which cross at the back all united where they meet. In order further to follow the action we will refer to Fig. 146.

FIG. 146.

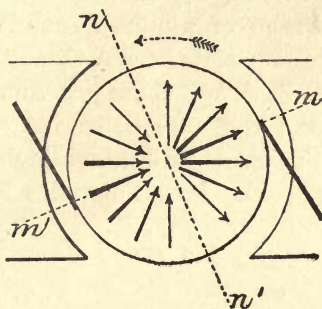

INDUCTION OF CURRENTS IN ARMATURE.

This diagram represents by means of radial arrows the electromotive-forces induced in a loop or loops rotating (*left-handedly*, as it happens, in this figure) in a magnetic field. The action is a maximum along the line of the resultant magnetic field $m m'$ (which would be horizontal were it not for the reactions explained in Chapter V.), and is a minimum along the line $n n'$. The reader will remember that line $n n'$ is the neutral line which lies at right angles to the line of maximum magnetisation; and that, for those armatures in which all the coils are joined together in a closed circuit, it is at $n n'$ that the brushes have to be placed. But when each coil is independent of the others it is no use putting the brushes at $n n'$; they must be put at $m m'$; the line of maximum action coinciding in this case with the diameter of commutation. But those coils which lie very near the line $m m'$ are undergoing induction very nearly as strongly as the actual pair that lie in that line: it would therefore naturally occur that the current might be simultaneously collected from more than one coil at once, either (1) by making the pieces of the commutators overlap, or (2) by connecting to the brushes that touch on the line $m m'$ another pair having either a forward or a backward lead. If we now consider Fig. 147 we shall see this a little more

clearly. This figure is a diagram of such an armature, the coils or loops being here represented merely by wavy lines.

The wavy line A C may represent either a pair of coils such as there are in Fig. 145 on the ring, or may represent a single loop or group of windings round a drum. There is a pair of commutator-plates for A C, and another at right angles for B D. Coils A and C are just coming into the position of best action; they are delivering a current to the brushes P P', and this current will accordingly increase a little, and then decrease again. Meantime coils B and D are idle.

FIG. 147.

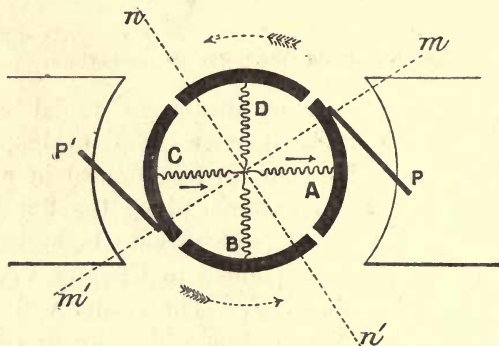

If the four parts of the compound commutator each occupy just a quarter of the circumference, it is clear that when A comes into action its plane makes an angle of 45° with $m m'$, and that just as it leaves contact with the brush makes again an angle of 45° on the other side, being in contact in all intermediate positions; and so with each coil as it passes the brushes. There will be a momentary break of current and a spark as the two successive segments pass under the brush, unless the brush touches both at once. Remembering that Fig. 25, p. 24, represents the alternating currents from a single loop or pair of coils, and that Fig. 26, p. 25, represents the same currents rectified by the use of a simple 2-part commutator, we shall be able to represent the effect of our new arrangement by some such diagram as Fig. 148.

The angles marked below are reckoned from the neutral line nn' . When coil A has gone round 90° from this position it is in the position of maximum induction: but because the segment A of the commutator is itself 90° in breadth, the current will be collected from 45° to 135° . The shaded portions of the curve show the discontinuous effect due to the coils A and C coming into circuit during two quarters of the rotation. The coils B and D come in

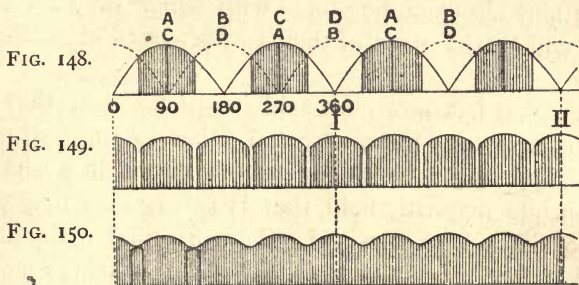

CURVES ILLUSTRATING THE PRODUCTION OF CURRENTS BY USING AN OPEN-COIL FOUR-PART ARMATURE.

in the intervals, as indicated by the dotted lines. The induced currents will therefore present an approximate continuity depending on the arrangements of the commutator and the brushes. Fig. 149 represents the effect when there are gaps between the segments of the commutator; and it will be noticed that the currents, though all of the same sign, are discontinuous. If the brushes thus left contact with one segment of the commutator before the next came into contact there would inevitably be a considerable amount of sparking. Fig. 150 shows the result of making contact with one set before the other set is cut out; the induced current being now continuous, but with undulating fluctuations of strength. During the time when both sets of coils are in contact with the brushes, they are, of course, in parallel with one another. During this stage of the action the resistance of the armature is half as great as when one of the coils is cut out; but it is necessary to cut out the idle coil, otherwise some of the current from the active coil would

flow back uselessly through the idle coil that was in parallel with it. During the time when the two sets of coils are in parallel they are not equally active. The induced electromotive-force is increasing in one and diminishing in the other; there is but a moment when they are equally active—when they make equal angles with mm' . At all other moments the higher electromotive-force of the more active coil tends to send a back-current through the less active coil: and the nett electromotive-force with which they act on the brushes will be the mean of their two separate electromotive-forces.

From what has now been said it will be clear that open-coil armatures may be constructed either as rings, drums, or disks. They may be arranged to run either in a simple or in a multiple magnetic field, that is to say they may belong either to Class I. or Class II. The principal dynamos constructed upon this plan are the Brush machine and the Thomson-Houston machine: but there are a few others also coming in the category of open-coil dynamos.

Brush's Dynamo.—One of the best-known and least understood of these machines is the Brush dynamo. Its general form and the disposition of the field magnets may be gathered from Fig. 151. The field magnets are very substantially built. The magnet heads are insulated with sheets of the so-called vulcanised fibre, thoroughly varnished. The field-magnet cores are, however, first surrounded with a thin sheet of copper soldered together at the edges so as to form a continuous tube or envelope. The object of this copper coating is to absorb the induced extra currents which otherwise would be set circulating in the core whenever a variation of the magnetism occurred. Over the copper envelope are wound four or five thicknesses of very heavy paper saturated with shellac varnish to insulate the wire from the iron. In many of the Brush dynamos, there is a double winding, a shunt or “teazer” circuit being added to maintain the magnetism of the field magnets when the main circuit is opened. The automatic regulator, described briefly on p. 105, is used with arc-lighting Brush machines.

The armature—a ring in form, not entirely over-wound with coils, but having projecting teeth between the coils, like the Pacinotti ring—is a unique feature. Though it so far resembles Pacinotti's ring, it differs more from the Pacinotti armature than that armature differs from those of Siemens, Gramme, Edison, Bürgin, &c. ; for in all those the successive sections are united in series all the way round, and constitute, in one sense, one continuous bobbin. But in the Brush armature there is no such continuity. The ring itself was formerly made of malleable cast iron. The wire-spaces are planed or milled out, and all angles and corners are carefully rounded. All iron parts which are to adjoin the wire of the "bobbins" are covered first with a layer of strong heavy canvas saturated with shellac varnish, and in the case of the armatures of the larger machines there are additional layers of tough paper saturated with shellac varnish. A sheet of strong cotton-cloth inserted occasionally separates contiguous layers of wire from each other both in the armature bobbins and in the coils of the field magnets. All the bobbins are wound by hand in the same direction, and the inner ends of diametrically opposite bobbins are soldered together and carefully insulated from all other wires and adjacent metal. The free outer ends of each pair of bobbins are separately carried along the shaft, through the journal, and connected to diametrically opposite segments of the commutator. In the "sixteen-light" machine the ring is 20 inches in diameter. In each of the eight coils there are about 900 feet of wire of .083 inch gauge. Thus connected, the machine is adapted to deliver a current of ten ampères. By connecting the two bobbins of each pair in parallel, instead of in series with one another, the machine may be used to deliver a 20-ampère current. For electro-plating, much stouter wires are used.

For each pair of coils there is a separate commutator. In the No. 7 size of machine, which is depicted in Fig. 151, there are eight coils on the armature, four commutators grouped in two pairs, and two sets of brushes. This size is commonly known as a "sixteen-light" machine, though it will as now improved, supply from 24 to 25 arc lights.

FIG. 151.

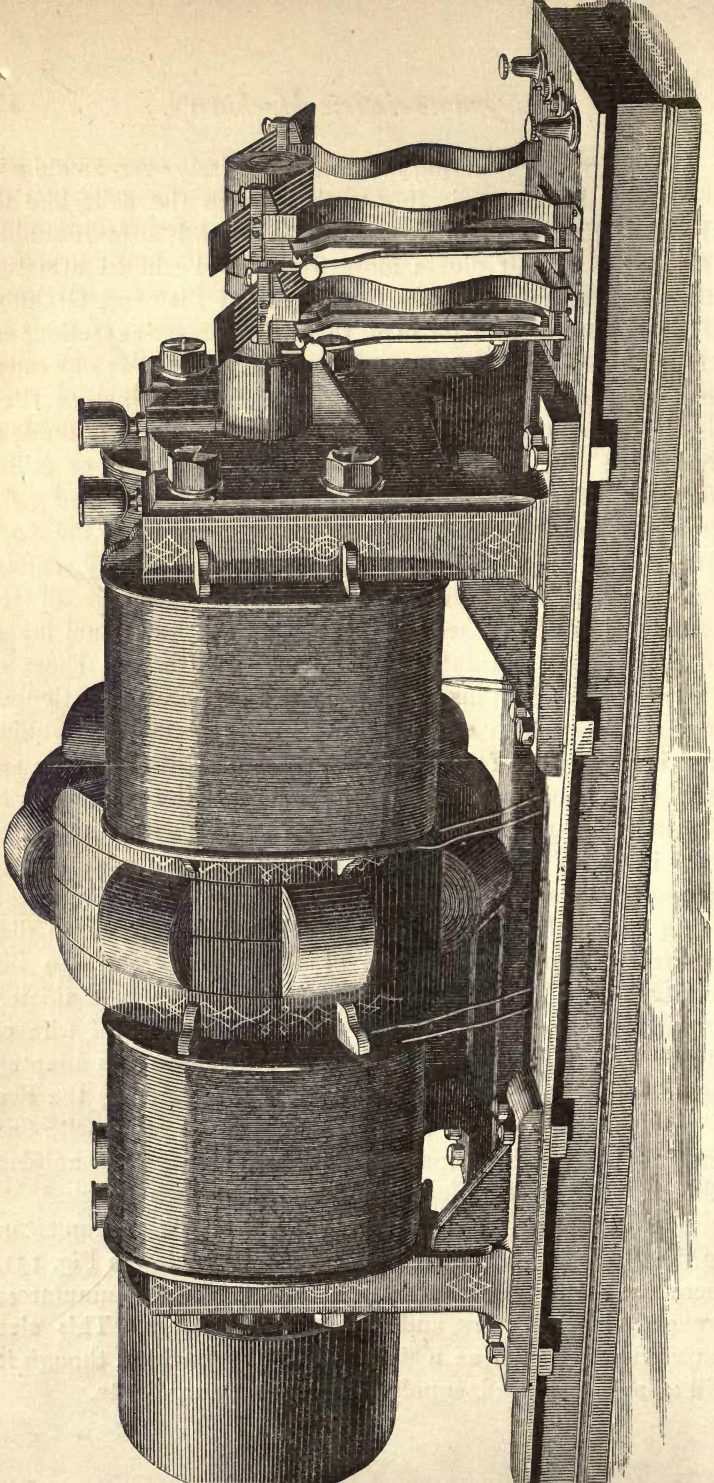

BRUSH DYNAMO. NO. 7 (TWENTY-FIVE LIGHT).

The larger Brush dynamos ("sixty-light machines") have twelve coils upon the ring, connected as six pairs. There are three pairs of brushes, and three pairs of commutators, each pair being set one-twelfth of a rotation (30°) in advance of the next pair. These machines have the enormous electromotive-force of nearly 3000 volts; and, with the recent improvements, will supply sixty or more arc lights in a single circuit. They formerly supplied forty lights only.

The brushes are arranged so as to touch at the same time the commutators of two pairs of coils, but never of two adjacent pairs; the adjacent commutators being always connected to

FIG. 152.

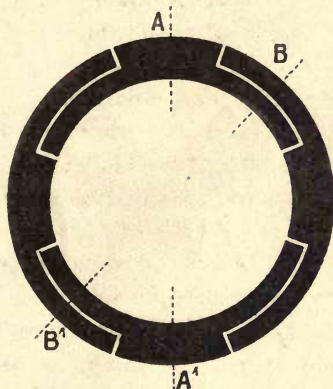

PAIR OF OVERLAPPING COMMUTATORS.

two pairs of coils that lie at right angles to one another in the ring. Continuity is obtained in the currents by making the two parts of the commutator of each pair of coils overlap those of the commutator belonging to the pair of coils that is at right angles, one pair of brushes resting on both commutators. Fig. 152 is a diagram illustrating this device. Each pair of segments overlaps the other to the extent of 45° . Each of the two pairs of coils is thus cut out twice during a revolution: it is twice in circuit alone, as when the brushes are at $A A'$, and four times in circuit along with

the pair that are at right angles, when the brushes are at BB'. Fig. 153 shows the way in which the commutator is arranged in all 8-coil Brush armatures,—that is in machines for supplying from one to twenty-five arc lights. There are really four commutators here, corresponding to the four pairs of coils, grouped in pairs; one pair of commutators being set one-eighth of a rotation (45°) in advance of the other. It will be seen from this figure that while the brushes AA' (shown in dotted lines) are receiving current

FIG. 153.

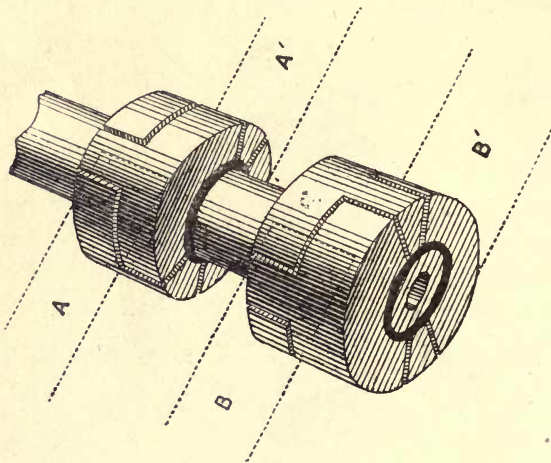

BRUSH COMMUTATOR FOR ARMATURE WOUND WITH FOUR PAIRS OF COILS.

from *one pair* of coils only, the brushes BB' are at the same instant receiving the current from *two pairs* of coils which are joined in parallel with one another in consequence of both of their commutators touching the same pair of brushes. The arrangement may be still further studied by the aid of Fig. 154, which also illustrates the way of connecting the brushes with the circuit. In this figure the eight coils are numbered as four pairs, and each pair has its own

commutator, to which pass the outer ends of the wire of each coil, the inner ends of the two coils being united across to each other (not shown in the diagram). In the actual

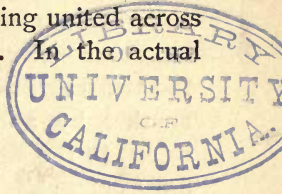
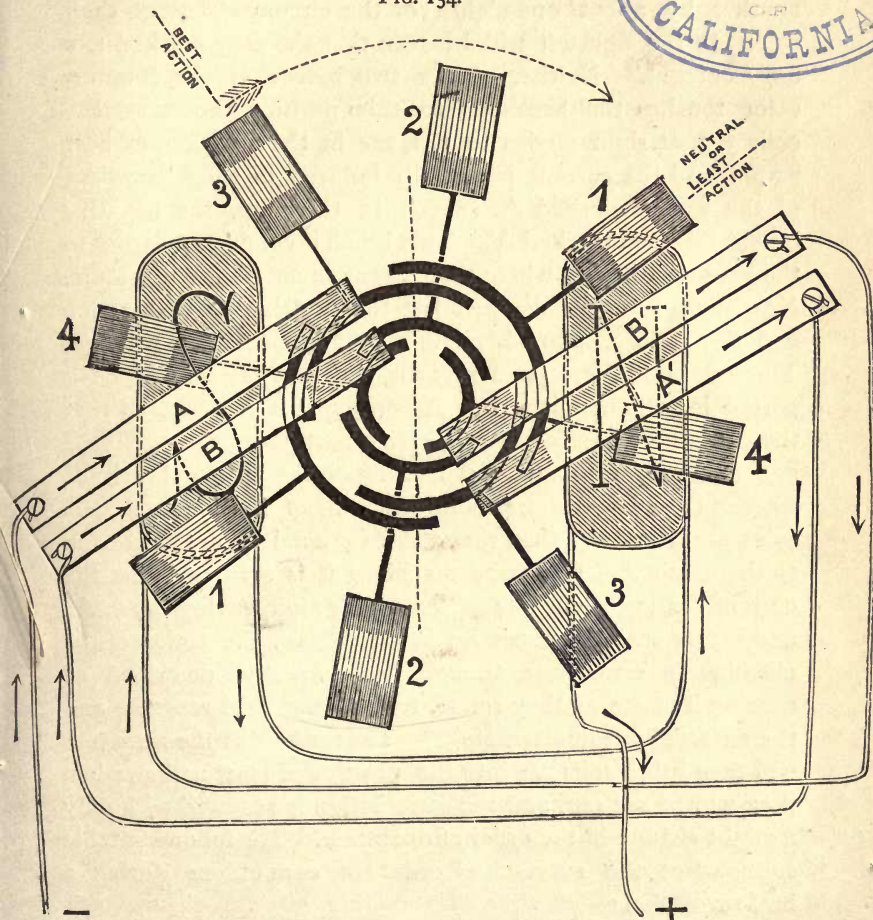

FIG. 154.



CONNEXIONS OF BRUSH DYNAMO.

machine, each pair of coils, as it passes through the position of least action (i.e. when its plane is at right angles to the direction of the lines of force in the field, and when the

number of lines of force passing through it is a *maximum*, and the rate of change of these lines of force a *minimum*) is cut out of connexion. This is accomplished by causing the two halves of the commutator to be separated from one another by about one-eighth of the circumference at each side. In the figure it will be seen that the coils marked 1, 1 are "cut out." Neither of the two halves of the commutator touches the brushes. In this position, however, the coils 3, 3, at right angles to 1, 1, are in the position of best action, and the current powerfully induced in them flows out of the brush marked A (which is, therefore, the negative brush) into that marked A'. This brush is connected across to the brush marked B, where the current re-enters the armature. Now the coils 2, 2 have just left the position of best action and the coils 4, 4 are beginning to approach that position. Through both these pairs of coils, therefore, there will be a partial induction going on. Accordingly, it is arranged that the current, on passing into B, splits, part going through coils 2, 2 and part through 4, 4, and reuniting at the brush B', whence the current flows round the coils of the field magnets to excite them, and then round the external circuit, and back to the brush A. (In some machines it is arranged that the current shall go round the field magnets after leaving brush A', and before entering brush B; in which case the action of the machine is sometimes, though not correctly, described as causing its coils, as they rotate, to feed the field magnets and the external circuit alternately.) The rotation of the armature will then bring coils 2, 2 into the position of least action, when they will be cut out, and the same action is renewed with only a slight change in the order of operation. The following table summarises the successive order of connexions during a half-revolution:—

First position. (Coils 1, 1 cut out.)

A-3-A'; B $\begin{array}{c} \diagup 4 \\ \diagdown 2 \end{array}$ B'; Field magnets-External circuit-A.

Second position. (Coils 2, 2 cut out.)

A $\begin{array}{c} \diagup 1 \\ \diagdown 3 \end{array}$ A'; B-4-B'; Field magnets-External circuit-A.

Third position. (Coils 3, 3 cut out.)

$A-1-A'$; $B \begin{matrix} \diagup 2 \\ \diagdown 4 \end{matrix} B'$; Field magnets - External circuit - A.

Fourth position. (Coils 4, 4 cut out.)

$A \begin{matrix} \diagup 3 \\ \diagdown 1 \end{matrix} A'$; $B-2-B'$; Field magnets - External circuit - A.

From this it will be seen that whichever pair of coils is in the position of best action, is delivering its current direct into the circuit; whilst the two pairs of coils which occupy the secondary positions are always joined in parallel, the same pair of brushes touching the respective commutators of both; and the remaining pair of coils being cut out.

One consequence of the peculiar arrangement thus adopted is, that measuring the potentials round one of the commutators with a voltmeter gives a wholly different result from that obtained with other machines. For one-eighth of the circumference on either side of the positive brush, there is no sensible difference of potential. There then comes a region in which the potential appears to fall off, but the falling off is here partly due to the shorter time during which the adjustable brush connected with the voltmeter and the fixed positive brush are both in contact with the same part of the commutator. Further on there is a region in which the voltmeter gives no indications, corresponding to the cut-out position; and again, on each side of the negative brush, there is a region where the polarity is the same as that of the negative brush.

Fig. 155 is a diagram of a 6-light Brush taken at one commutator, the main + brush being, however, allowed to rest (as in its usual position) in contact with both this commutator and the adjacent one.

From the foregoing considerations, it will be clear that the four pairs of coils of the Brush machine really constitute four separate machines, each delivering alternate currents to a commutator, which commutes them to intermittent unidirectional currents in the brushes; and that these indepen-

FIG. 155.

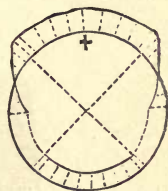

POTENTIALS AT
COMMUTATOR OF
BRUSH DYNAMO.

dent machines are ingeniously united in pairs by the device of letting one pair of brushes press against the commutators of two pairs of coils. Further, that these paired machines are then connected in series, by bringing a connexion round from brush A' to brush B.

The core of the Brush ring, as formerly made, was of malleable cast iron channelled at the sides, so as in some degree to obviate eddy currents. The coils are wound in deep radial recesses. The form of the ring, with its coils, may be discerned in Fig. 151, and the channelled cast-iron ring itself is shown in Fig. 156. The solid masses of iron in

FIG. 156.

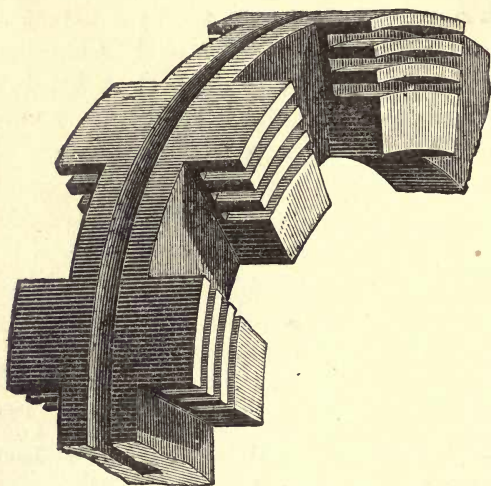

CORE OF BRUSH RING (Old pattern).

this now obsolete form of armature gave rise to wasteful eddy-currents, the production of which heated the ring and absorbed considerable power. In the newer Brush machines a ring is employed which is built up of a thin iron ribbon 1.5 millimetres thick. Figs. 157 to 159 show its construction, though in reality a larger number of pieces of thinner iron than is shown are used. The ribbon is wound

upon a circular foundation ring A' , projecting cross-pieces of the same thickness and of the form shown in Fig. 159 (and also marked H in Figs. 157 and 158), being inserted

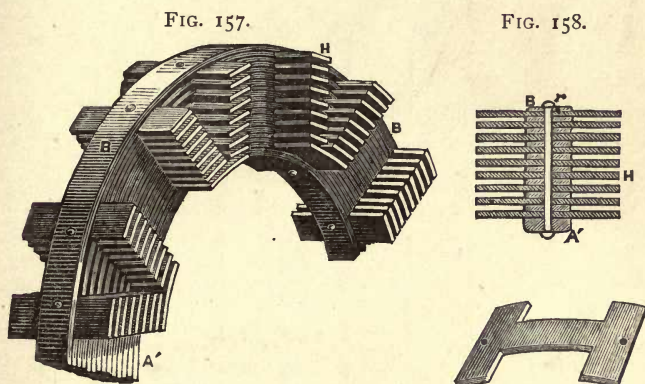

CORE OF BRUSH RING (New pattern).

at intervals to separate the convolutions, admit of ventilation, and form suitable projections between which to wind the coils. In the larger armatures there are 45 turns of the ribbon. It is secured by well-insulated radial bolts. The gain in coolness is great; and the old machine, which formerly supplied 40 arc lamps, when provided with the new ring can supply 65 lamps at the same speed as before. The smaller 16-light machine with an armature of the new type lights 25 lamps, showing that the deleterious reactions have been fairly eliminated; and it may even be run at higher speeds with perfect safety.

The most striking way of realising the great improvement which has thus been made is to compare the speeds required to develop equal electromotive-forces in the two machines. The experiments were made with identical machines. Both armatures were of the same size, with same length and weight of wire; and the field magnets were identically excited with a 10-ampère current. The results are shown in the two curves of Fig. 160. At 800 revolutions the

old cast-iron armature gave about 730 volts: the new laminated armature gave over 1000 volts.*

FIG. 160.

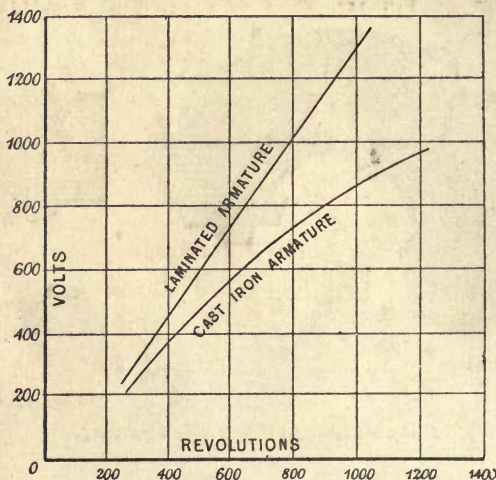

CURVES OF OLD AND NEW PATTERNS OF BRUSH MACHINE.

Thomson-Houston Dynamo.—This machine, which is equally remarkable, was designed by Professors Elihu Thomson and Edwin J. Houston of Philadelphia. Its spherical armature is unique among armatures; its cup-shaped field magnets are unique amongst field magnets; its three-part commutator is unique among commutators. A general view of the machine is given in Fig. 161, and a sectional one in Fig. 162. As will be seen from these cuts, the field-magnet core consists of two flanged iron tubes furnished at their inner ends with hollow cups cast in one with the tubes, and accurately turned to receive the armature. Upon the tubes are wound the coils C C', and afterwards the

* More surprising still, the power absorbed in driving the old armature giving 730 volts was 17 horse-power, whilst that absorbed in driving the new, giving 1020 volts was only 16 horse-power. The old armature could not be run above 800 revolutions per minute without dangerous heating. The new armature may be safely run at a much higher speed, without risk of heating or other danger.

FIG. 161.

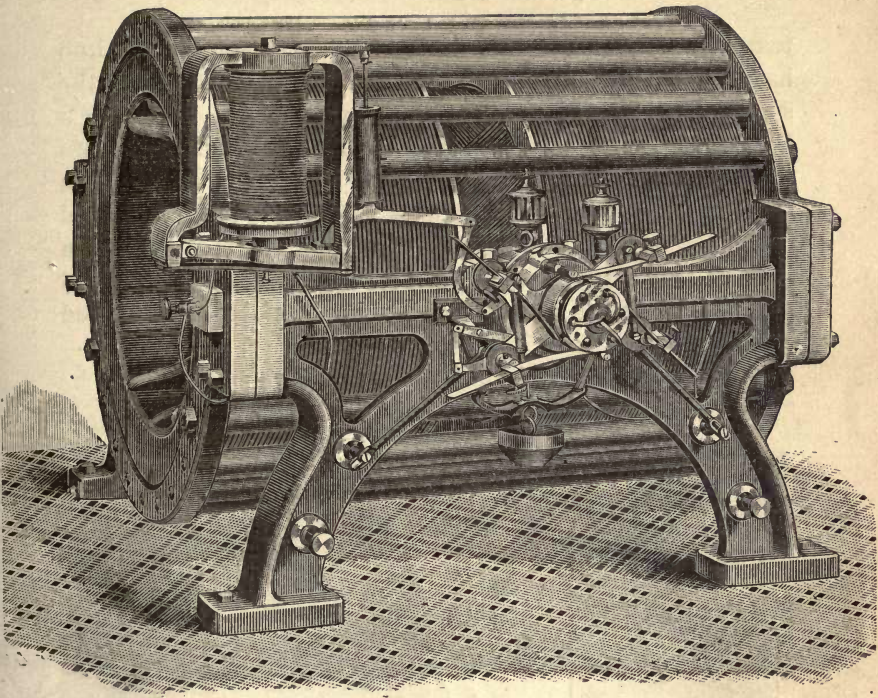

THOMSON-HOUSTON DYNAMO.

FIG. 162.

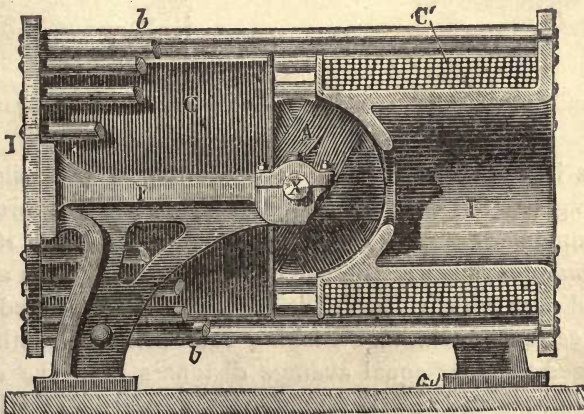

THOMSON-HOUSTON DYNAMO (part Section).

two parts are united by means of a number of wrought-iron bars *bb* which constitute the yoke of the magnet and at the same time protect the coils. The magnets are carried on a framework, which also supports the bearings for the armature shaft X. The armature, which is spheroidal rather than spherical, is constructed as follows. Upon the shaft are keyed two concave iron disks S, S (Fig. 163), the space between them being bridged by light ribs of wrought iron, *d, d*. Wooden pins J, J are driven at intervals into appropriate holes drilled

FIG. 163.

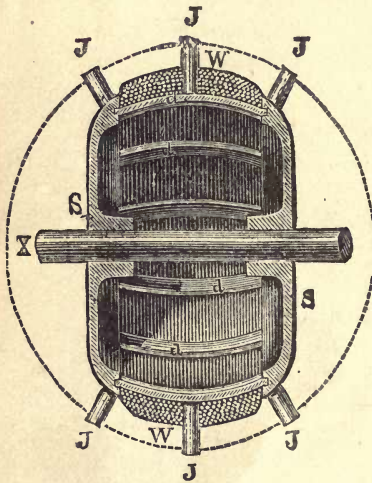

THOMSON-HOUSTON ARMATURE (Section).

FIG. 164.

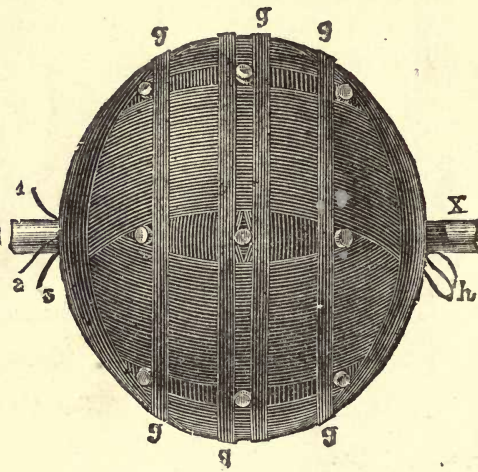

THOMSON-HOUSTON ARMATURE.

in the iron shell to facilitate the winding of the coils. The winding itself is very remarkable. There are but three coils. The inner ends of these are united together (at *h*, Fig. 164), and not connected to any other conductor. The three wires are then wound over the shell (which is covered with varnished paper) in three sets of windings making 120° with one another, and arranged to be at equal average distances from the core by the following device. Beginning at the junction at *h*, half the No. 1 coil is wound. Then the armature is turned through

120° and the No. 2 coil is wound on to half its length. Then coil No. 3 is wound, starting from h , and finishes off at 3. Then the second half of No. 2 is completed; lastly, the second half of coil No. 1. The three coils are therefore, on the average, equidistant from the iron core: their overlapping makes the external form nearly spherical. They are held in place by the binding wires $g g$. When this armature is rotated within the cavity between the cup-shaped poles alternate currents are generated in each separate coil in turn, and it now remains to consider how these alternate inductions are rectified and combined by the commutator. In the diagrams which follow, the rotation is represented as left-handed, as viewed from the commutator-end of the shaft, as it is in practice. Fig. 165 represents the arrangement in diagram.

FIG. 165.

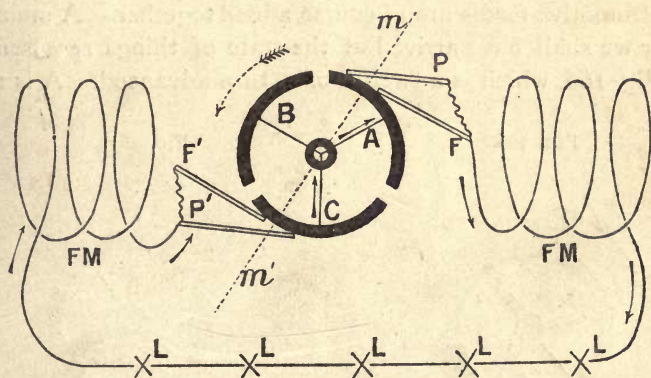

COMMUTATOR AND CIRCUIT OF THOMSON-HOUSTON DYNAMO.

The three coils represented diagrammatically by the three lines A B C, are united at their inner extremities, each outer end being led to one segment of a 3-part commutator. There are two positive brushes P and F, and two negative brushes P' and F'. The current delivered to P and F first flows round one of the field magnets, thence goes to the outer circuit of lamps, returning through the other field magnet to P' and F'. The reader should now compare this diagram with

Fig. 146, p. 177, and observe that in that figure the neutral line $n n'$ divides the rotation obliquely into two halves, the induced currents flowing outwardly from centre to commutator in all coils that are rising through the right-hand half of this obliquely divided circle; and inwardly from commutator to centre in all coils descending through the left-hand half of the rotation. Accordingly in Fig. 165 there will be an outward current in A and an inward one in C; B being for the moment cut out of circuit as it passes through the neutral position. Continuity is obtained by the device discussed on p. 178, of having the second pair of brushes $F F'$ following the pair $P P'$. In this position of the armature A and C make about equal angles with the line of maximum action $m m'$, hence the two electromotive-forces in these coils are for the moment about equal, but that in A is increasing, that in C decreasing. As these coils are now in series, their separate electromotive-forces are of course added together. A moment later we shall have arrived at the state of things represented in Fig. 166, which is a twelfth of a turn advanced. A is now

FIG. 166.

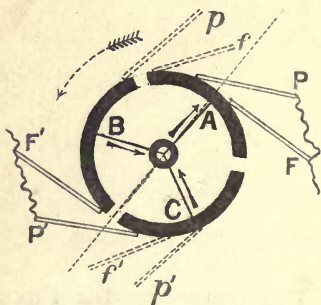
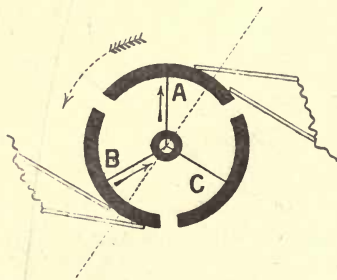

FIG. 167.



in the position of maximum induction; C is rapidly approaching the neutral position but is not yet cut out; B has again begun to have electromotive-force induced in it, and has just come into circuit. B and C are in parallel with one another and in series with A. The next twelfth of a turn brings us to the stage shown in Fig. 167. C is now at the neutral position

and is out of circuit, A has passed the maximum on one side and B is approaching the maximum on the other ; and they are in series. Another twelfth of a turn and we arrive at Fig. 168. A is fast approaching the neutral position ; B is at its maximum ; C has passed the neutral stage, and has just come into circuit again by touching the positive following brush. Another instant and C will occupy the place where A was in Fig. 165, a whole third of a revolution having been completed, and the actions recommence, A occupying the place of B, and B that of C. The following table exhibits the round of changes during a third of a revolution :—

FIG. 168.

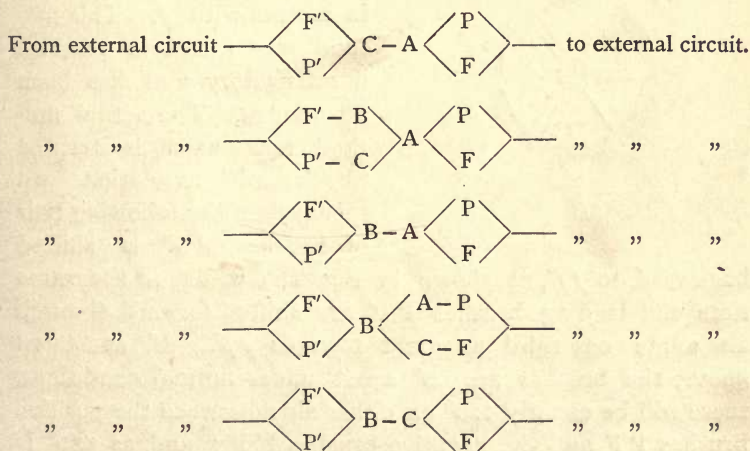
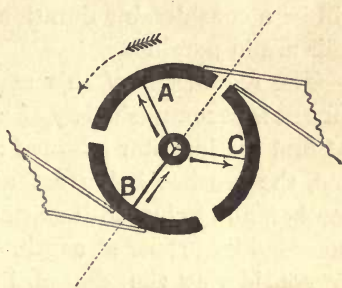

and so forth.

If the width of the gaps between the segments of the commutator be equal to the width between the adjacent

brushes, each coil will be cut out of circuit whenever it is more than 60° from the position of maximum action, and the time during which any two coils are in parallel will be practically nil. But if the following brushes $F F'$ are at a considerable angle—about 60° in practice—behind the brushes $P P'$, there will be a considerable duration of the stage during which two coils are in parallel.

The regulation of this machine to maintain a constant current is accomplished by an automatic shifting of the brushes. At first the inventor adopted a method of "forward" regulation, the brushes being set at only 35° in advance of one another, and being both shifted forward whenever the current exceeded its proper strength. The effect of this will be seen by considering the dotted lines $p p'$ and $f f'$ in Fig. 166.

FIG. 169.

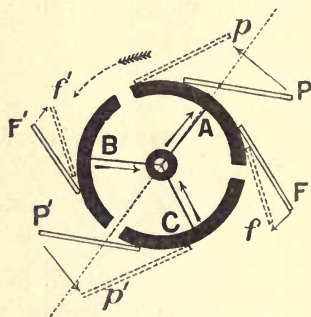

Clearly, if p maintained contact with B *after* it had passed the neutral line, its electromotive-force would tend to diminish that of A which is in contact with f . This method was found in practice unsatisfactory, and has been abandoned. The actual method now used is termed "backward" regulation. In this system the following pair of brushes $F F'$ is shifted

backward, to $f f'$, as shown in Fig. 169, whilst at the same time the leading brushes $P P'$ are shifted forward through an angle one-third as great towards $p p'$. If, as stated above, the brushes are 60° apart under normal conditions, there will be exactly 120° on either side between the positive brushes $P F$ and the negative brushes $P' F'$; and, as 120° is the exact length of each segment of the commutator, no coil will be cut out, and parallelism will subsist between two coils through angles of 60° : that is to say, there will always be two of the three coils in parallel with one another and

in series with the third coil. The six stages of change will be :—

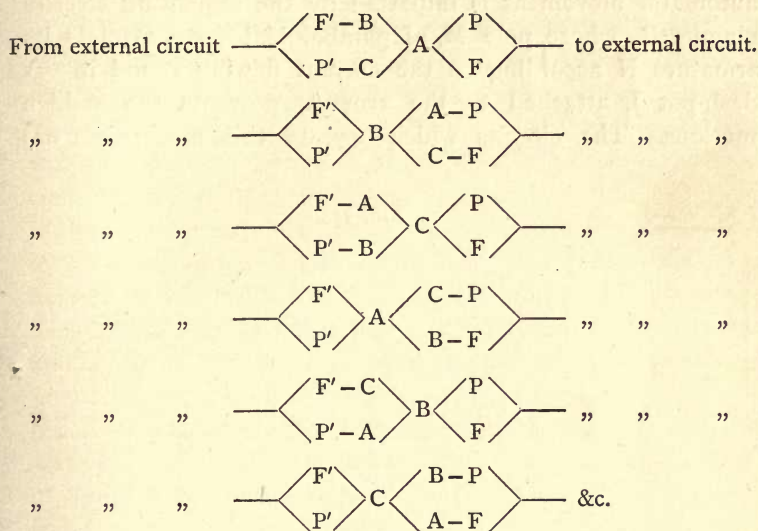

Now suppose the current to become too strong owing to reduction of number of lamps in circuit, the following brushes are made to recede. This will shorten the time during which any single coil in passing through the maximum position is throwing its whole electromotive-force into the circuit, and will hasten the moment when it is put in parallel with a comparatively idle coil. During such movements of regulation the whole machine is momentarily short-circuited six times during each revolution by F receding so far towards P' and F' receding so far towards P as that both touch the same segment of the commutator at one instant. The action is assisted by the slight advance of P and P', but the main object of this advance is to lessen the sparking. If the current is too weak, then the pairs of brushes must be made to close up, thereby reducing the time during which the most active coils are in parallel with those that are less active. This motion of advance and retreat is accomplished

by the simple mechanism shown in Fig. 170. The brushes are fixed to levers $Y Y$ and $Y_2 Y_2$ united by a third lever l . The automatic movement is imparted by the regulating electro-magnet R , whose pole M , of paraboloidal form, attracts its armature N according to the current flowing round it. A dash-pot J , attached to the arm A , prevents too sudden motions. The circuits which operate this mechanism are

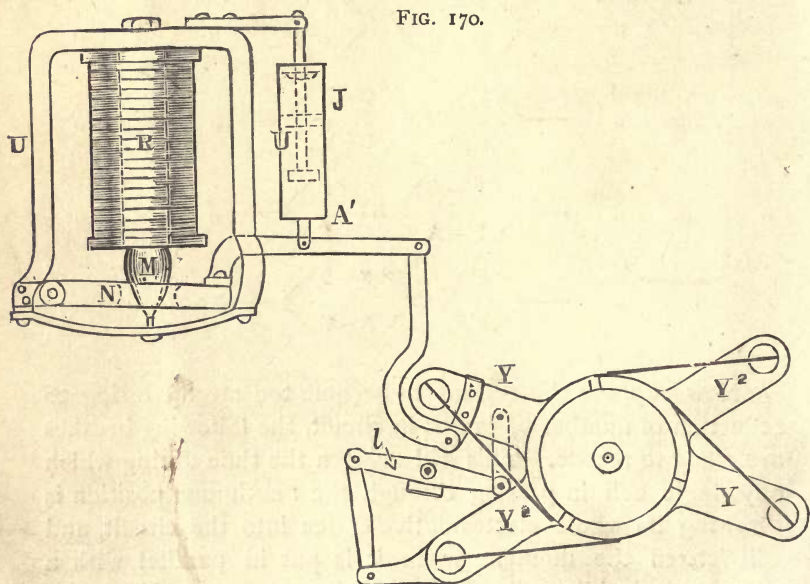

FIG. 170.

REGULATING MAGNET AND GEAR OF THOMSON-HOUSTON SYSTEM.

further shown in Fig. 171. Normally the electro-magnet R is short-circuited through a by-pass circuit, and only acts when this circuit is opened. At some convenient point of the main circuit two solenoids are introduced, their cores being supported by a spring; and the yoke of the cores operates the contact lever S . If the current becomes too strong this contact is opened, and the regulating magnet R raises the arm A . During running the lever S is continually vibrating up and down, and so altering the brushes to the require-

ments of the circuit. A carbon shunt of high resistance r is added to minimize the destructive spark at S.

It might be expected that with only three parts to the commutator, the sparks occurring as the segments pass under

FIG. 171.

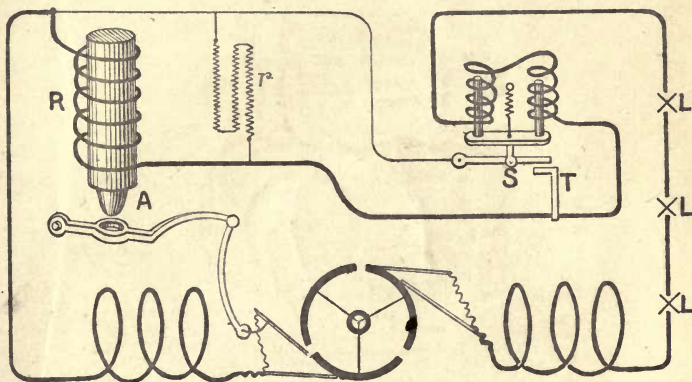
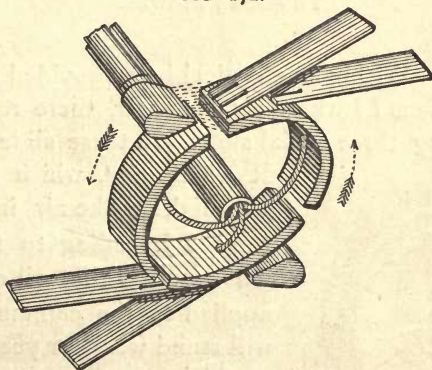

FIG. 172.



COMMUTATOR, BRUSHES, AND BLAST-NOZZLES.

the brushes would speedily destroy the surface. This difficulty has been met by Prof. Thomson in the boldest manner. He blows out the sparks by an air blast delivered exactly at the right place and time. The three segments of the commutator are separated by gaps; and in front of each of the leading brushes (as shown in Fig. 172) there projects a nozzle

which discharges a blast (alternately) three times in each revolution. The blast is itself supplied by a very small, simple, and ingenious blower, fixed upon the shaft immediately behind the commutator. The blower is shown in Figs.

FIG. 173.

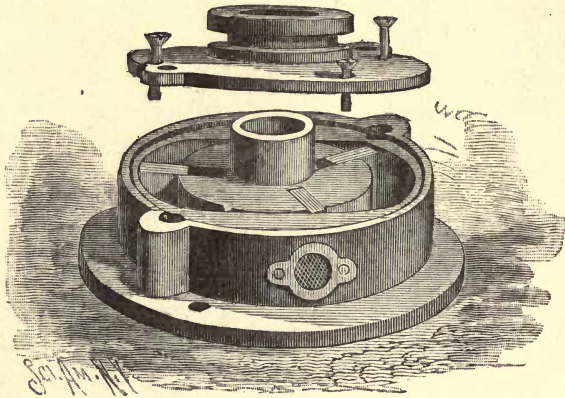

THOMSON'S BLOWER.

173 and 174. Within an elliptical box, provided at the sides with perforations I I where air can enter, there rotates a steel disk H having three radial slots. In these slide three wings

R of ebonite, which as they fly round drive the air into the apertures J J leading to the nozzles. The result is that oil can be freely applied to the commutator, which will stand wear for years.

FIG. 174.

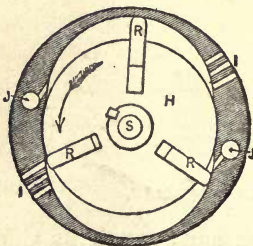
THOMSON'S BLOWER
(Section).

a single circuit, with an electromotive-force of 3000 volts. The ordinary machine supplying 34 arc lamps at 45 to 46 volts each with a current of 9.6 ampères, has an internal resistance

of 10·5 ohms in the armature and 10·5 ohms in the field magnets. The armature is $23\frac{1}{8}$ inches in external diameter; its wire being of 0·081 inch gauge. That of the field magnets is 0·128 inch gauge. The usual speed is 850 revolutions per minute; but the peculiar arrangements for automatic regulation render the machine nearly independent of irregularities in the speed. There is in the armature about 1 yard of wire for every 0·53 volt of the induced electromotive-force. The ratio of weight of copper to iron in these dynamos is very high compared with that of many machines, being 1 of copper to 2·25 of iron.

Professor E. Thomson has more recently designed, for supplying large currents at low potential, a form of dynamo which is outwardly of similar structure to the machine described above. But in this new machine, which is intended for incandescent lamps in parallel, the spherical armature is wound as a closed-coil in sixteen sections. The field magnets are much more massive, and the output of the machine more than five times as great in proportion to its size. It is compound-wound; the series coils being nearest to the armature, with the shunt coils behind them.

Newton's Dynamo.—This machine has an armature somewhat resembling that of Weston, being built up of cast-iron cogged disks. The winding is, however, entirely different. There are only eight circuits, each of fifty-six turns of wire united in parallel, and the eight circuits are coupled in four twos. These are independently connected to two commutators, as in the smaller Brush machines, but the commutators differ in being obliquely cut. One pair of brushes presses on both commutators.

Sir W. Thomson's Mousemill Dynamo.—Several points in this machine—the form of its field magnets and their coils, and the internal electro-magnets, have been noticed in other chapters. The armature is a hollow cylinder made up of parallel copper bars, arranged like the bars of a mousemill (whence the name of the machine). These bars are insulated from each other, but are connected all together at one end. At the other, they serve as collector bars and deliver up the

currents generated in them to the "brushes," which in this case are rotating disks of springy copper. All the bars are therefore cut out of circuit except the two which are at the moment in contact with the brushes. As the armature is a hollow barrel, with fixed electro-magnets within, it cannot be rotated on a spindle, but runs on friction rollers. In spite of its great originality, this form of machine has not shown itself to be a practical one.

Sir W. Thomson's Wheel Dynamo.—This machine also is an experimental form, necessitating too high a speed to be practical. The armature is a flat wheel, very like a flattened bicycle wheel. The radial arms or spokes, in which the currents are induced, are all connected at their outer ends to a copper rim; but at their inner ends they are carefully insulated and connected each to a segment of an ordinary collector. This wheel is made to rotate between two closely approximated field magnets. All the spokes are out of circuit except the pair which are passing the brushes. The complete machine was figured in the first edition of this work.

Other Open-coil Dynamos.—Other forms of open-coil dynamo have been proposed by Bain and by Dr. Hammerl. The armature of the latter consists of a Gramme ring wound in sections, but having the inner ends of all the sections united together at a common junction, and their outer ends brought each to a separate bar of a collector.

Advantages of Open-coil Dynamos.—The two great typical open-coil dynamos—those of Brush and of Thomson-Houston, appear to have certain qualities which render them specially applicable as constant current dynamos for arc lighting. Three quarters of all the arc lights in the world are run by one or other of these machines. It would seem that the closed-coil dynamos, whether of the ring or of the drum type are not so well adapted for furnishing the very high electromotive-forces needed for this work. The collector, which is the indispensable adjunct of the closed-coil armature; with its many segments insulated with mica or asbestos, rapidly deteriorates when exposed to the inevitable sparking and wide alterations of lead which are inseparable from the

constant-current method of working (see p. 79). For this method of distribution of electric energy, nothing will stand wear and tear so well as the simple air-insulated commutators described in this chapter. As a partial set off against these advantages may be reckoned the fluctuations in the currents which arise from the employment of so few coils or groups of coils.

Fluctuations of Current in Open-coil Armatures.—The calculations of the fluctuation given on pages 254 to 258, for closed-coil armatures are also applicable to open-coil armatures, provided there is no cutting out of coils. When idle coils are cut out, the fluctuations are less marked, but the calculations are less simple. That such fluctuations exist is abundantly verified by the interference of arc-light circuits with neighbouring telephone lines in which they induce buzzing noises. Rapidly fluctuating currents are also affected, in the manner of alternating currents, by self-induction of electro-magnets in the circuit, but to a less extent.

CHAPTER IX.

TYPES OF MACHINES (*continued*).**Dynamos of Class II.**

IN the dynamos of the second class the coils are carried round to different parts of a magnetic field such that either the intensity differs in different regions, or the lines of force run in opposite directions in different parts of the field. Fig. 13 (p. 13) illustrates this principle; and we shall now consider how it is carried out in practice. In the early machine of Pixii a single pair of coils was mounted so as to pass in this fashion through parts of the field where the magnetic induction was oppositely directed. Such a machine, therefore, gives alternate currents, unless a commutator be affixed to the rotating axis. Niaudet's dynamo, which may be regarded as a compound Pixii machine, having the separate armature coils united as those of Gramme and Siemens into one continuous circuit, is furnished with a radial collector instead of a cylindrical one. In the Wallace-Farmer dynamo is very nearly realised the condition of field of Fig. 13, there being, as shown in Fig. 175, a pair of poles at the top arranged so that the N. faces the S. pole, and another pair at the bottom where the S. faces the N. pole. The coils are carried round, their axis being always parallel to the axis of rotation, upon a disk; there being two sets of coils on opposite faces of two disks of iron set back to back. They are united (see Fig. 176) precisely as in Niaudet's dynamo, and each disk has its own collector. Each bar of the collector is, moreover, connected, as in the dynamos of Pacinotti, Gramme, Siemens, &c., with the end of one coil and the beginning of the next. In fact, the Wallace-Farmer machine is merely a

double Niaudet dynamo with cylindrical collectors. There is a serious objection to the employment of solid iron disks such as these. In a very short time they grow hot from the internal eddy currents engendered in them as they rotate. This waste reduces the efficiency of the dynamo. Several other inventors, including Lane-Fox, Brockie, and Leipner, have essayed dynamos on this type. There seems,

FIG. 175.

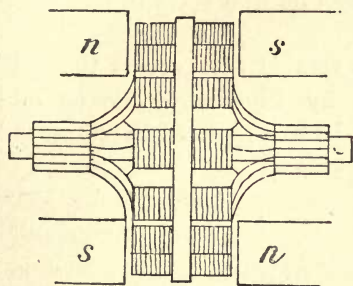

WALLACE-FARMER DYNAMO.

FIG. 176.

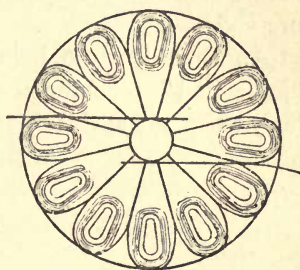

WALLACE-FARMER DYNAMO.

however, to be some difficulty in constructing dynamos with armatures of this kind; possibly on account of the fact that when two adjacent sections are having similar polarity induced in them, the currents in the wires of the two sections are flowing in opposite directions in the space between the adjacent cores; possibly also because the reversals of magnetism in the separate cores are sudden, and cause deleterious internal inductions. Hefner Alteneck, however, succeeded in converting into a continuous-current machine the alternate-current Siemens dynamo described below. This he has accomplished by the device of employing a disk armature, in which the number of coils differed by two, or some other even number, from those of the field, and by the employment of a multiple bar-collector with complicated cross connexions.

In the dynamo of Hopkinson and Muirhead, shown at the Paris Exhibition of 1881, the armature takes a more reason-

able shape of a disk. Instead of a solid plate of iron to support the coils, there is a disk built up of a thin iron strip wound spirally round a wooden centre. The coils, of approximately quadrangular shape, and flat form, are wound upon the sides of this compound disk. The separate coils are connected to one another, and to a collector of ordinary type. Hopkinson and Muirhead's dynamo was wound with strip copper instead of ordinary wire.

The dynamo of Ball (the so-called "Arago-disk" machine) is similar in many respects, but has no iron cores to the armature coils.

Another dynamo belonging to this category is the "oblique-coiled" machine devised by Professors Ayrton and Perry (Fig. 177); this dynamo, which must not be confounded

FIG. 177.

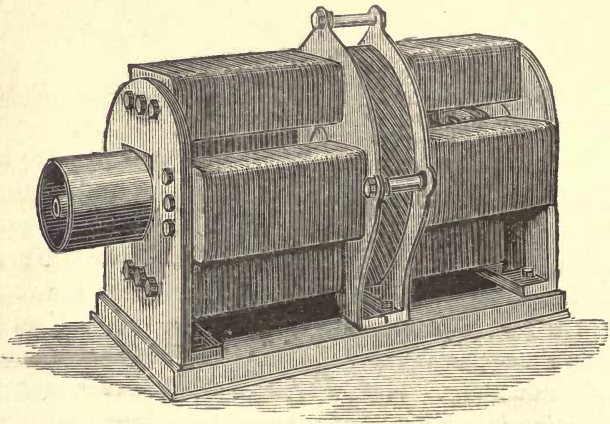

AYRTON AND PERRY'S OBLIQUE-COILED DYNAMO.

with an earlier machine of Professor Perry which had oblique coils on a phosphor-bronze core, is a 4-pole machine, the ring passing successively through four regions, in two of which the lines of force pass from right to left, and in the alternate two from left to right. The ring is of wood, having iron pieces thrust through it, as shown in section in Figs. 178

and 179, and the wire is so coiled that each turn passes radially up one face of the ring, thence obliquely along its periphery for about 90°, then radially inwards along the other face, and back obliquely. The separate sections overlap. They are

FIG. 178.

FIG. 179.

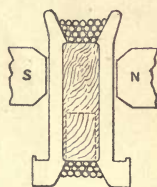
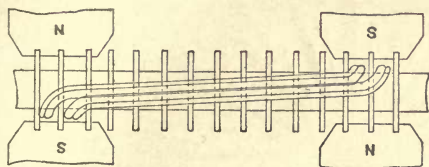

PLAN AND SECTION OF WINDING OF AYRTON AND PERRY'S ARMATURE.

connected to one another and to the collector in the usual way, but there are four brushes. A very similar disk-armature dynamo has been suggested by Messrs. Elphinstone and Vincent.

Another machine of this category, having a disk armature, is due to the indefatigable Mr. Edison (Fig. 180), who built up an armature of radial bars connected at the outer ends by

FIG. 180.

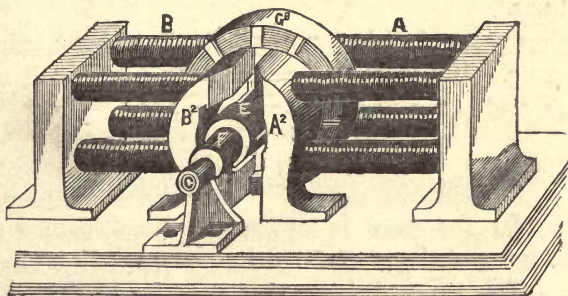

EDISON'S DISK DYNAMO.

concentric hoops, and at the inner by plates or washers. The general arrangement of the disk is indicated in Fig. 181. Each radial bar communicates through one of the hoops

with the bar opposite to it; and the disk thus built up is rotated between the cheeks or pole-pieces A^1 , A^2 , and B^1 , B^2 ,

FIG. 181.

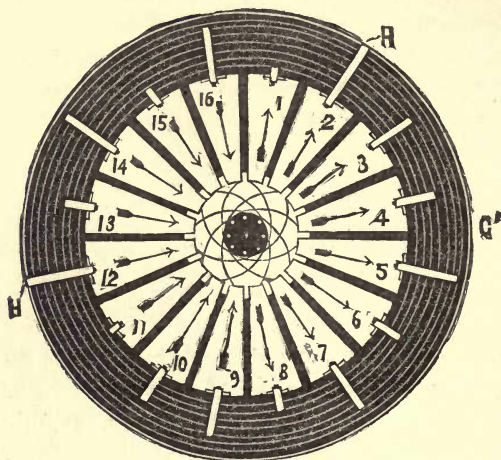

ARMATURE OF EDISON DISK DYNAMO.

of powerful field magnets, which very nearly meet, and which therefore yield an enormously powerful field. I cannot hear of any of these disk dynamos having yet come into practical use.

Another type of disk armature has been invented by Sir W. Thomson. It belongs, however, to the open-coil class of armatures, and is briefly described on p. 202.

Alternate-current Dynamos.

But by far the most important of the dynamos of this second class are those usually known as *alternate-current machines*. This type of dynamo is an old one, having for its early examples the machines of Stöhrer, Nollet, Holmes, and the so-called "Alliance" machine, in all of which permanent steel magnets were employed. The more modern type, with electro-magnets, was created by Wilde, in 1867. The field magnets consist of two crowns of fixed coils, with iron cores

arranged so that their free poles are opposite to one another, with a space between them sufficiently wide to admit the armature (Fig. 206, p. 232). The poles taken in order round each crown are alternately of N. and S. polarity, and opposite a N. pole of one crown faces a S. pole of the other crown. This description will apply to the magnets of the alternate-current machines of Wilde and Siemens, to the so-called Ferranti machine, and, with certain reservations, to the machines of

FIG. 182.

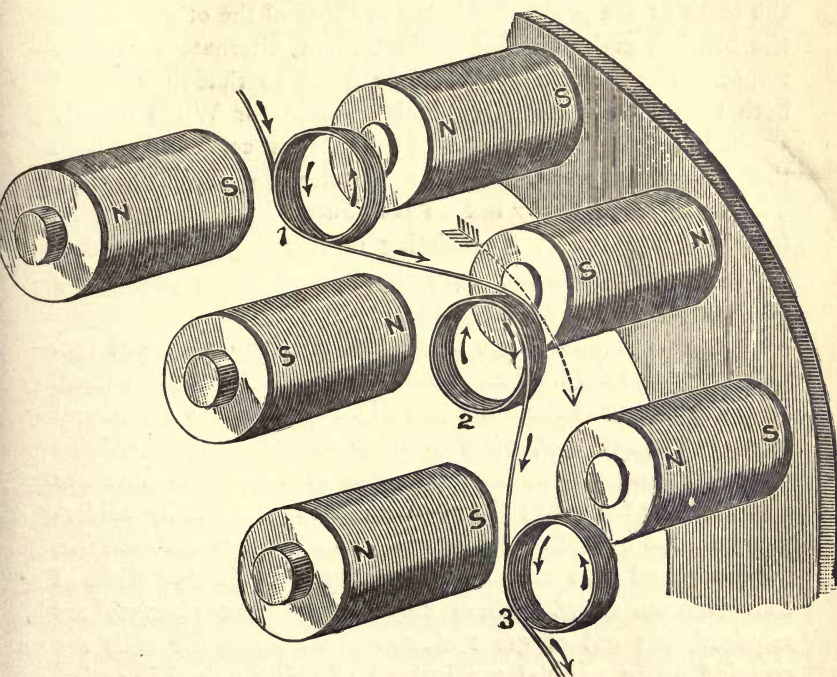

Lachaussée and of Gordon. The armature in almost all machines of this type consists of a *disk*, bearing at its periphery a number of coils, whose axes are parallel to the axis of rotation. The principle will be best understood by reference to Fig. 182, which gives a general view of the arrangement. Since the lines of force run in opposite directions between the fixed coils, which are alternately S.—N.,

N.—S., as described above, the moving coils will necessarily be traversed by alternating currents ; and as the alternate coils of the armature will be traversed by currents in opposite senses, it is needful to connect them up, as shown in the figure, so that they shall not oppose one another's action.

In Wilde's dynamo, the armature coils have iron cores, and the machine is provided with a commutator on the same principle as that used by Jacobi in his famous motor of 1838, consisting of two metal cylinders, cut like crown wheels, having the teeth of one projecting between those of the other, so that the brushes make contact against them alternately as they rotate. The brushes are, of course, fixed, so that they do not both touch the same part. This commutator Wilde usually applied to a few, or only one, of the rotating coils, and utilised the current thus obtained to magnetise the field magnets. The main current was not so commuted, but was led away from a simple collector, consisting of two rings connected to the two ends of the armature circuit, each being pressed by one brush. See Fig. 196, p. 221.

Siemens prefers to use a separate continuous-current machine to excite the field magnets of alternate-current dynamos. In the armature of the latter (see Fig. 183), the coils are wound usually without iron, upon wooden cores. Copper ribbons insulated from one another by strips of vulcanised fibre are also used for the coils ; the connexions being made by soldering the strips with silver solder. In some forms of the machine, the individual coils are enclosed between perforated disks of thin German silver. When currents of great strength are required, but not of great electromotive-force, the coils are coupled up in parallel arc, instead of being united in series. In Fig. 183 a small continuous-current machine of vertical pattern, such as was described on p. 156, is shown in action as an exciting machine to furnish the magnetising currents to the stationary field magnets of the alternate-current machine.

In a dynamo by Lachaussée, which very strikingly resembles the preceding one, there is iron in the cores of the

rotating coils. But the main difference is that the rotating coils are the field magnets, excited by a separate Gramme dynamo, whilst the coils, which are fixed in two crowns on either side, act as armature coils in which currents are induced.

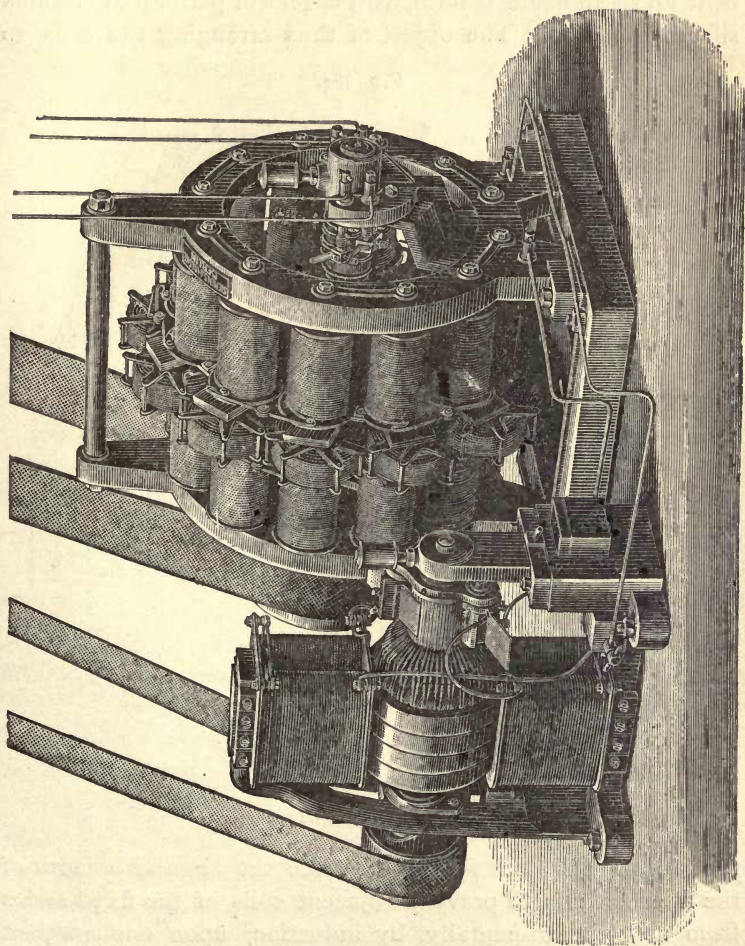

FIG. 183.

SIEMENS ALTERNATE-CURRENT MACHINE, WITH ITS EXCITER.

Gordon's dynamo, the largest yet constructed (Fig. 184), is designed on the same lines as the Lachaussée machine ; but with many important improvements. In the first place, there

are twice as many coils in the fixed armatures as in the rotating magnets, there being 32 on each side of the rotating disk, or, in all, 64 moving coils ; while there are 64 on each of the fixed circles, or 128 stationary coils in all. The latter are of an elongated shape, wound upon a bit of iron boiler-plate, bent up to an acute V form, with cheeks of perforated German silver as flanges. The object of thus arranging the coils, so

FIG. 184.

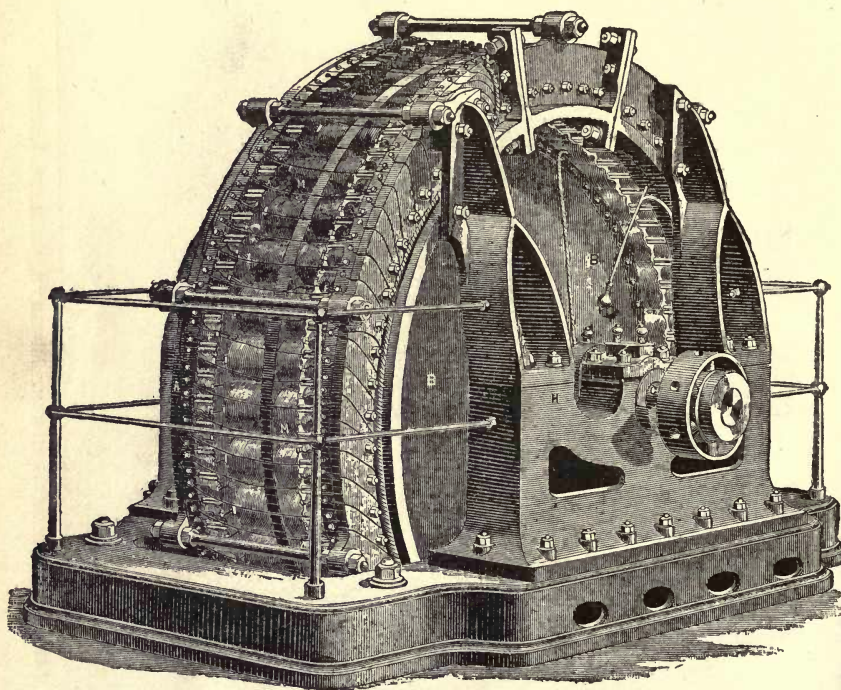

GORDON'S DYNAMO.

that the moving ones shall have twice the angular breadth of the fixed ones, is to prevent adjacent coils of the fixed series from acting detrimentally, by induction, upon one another. The alternate coils of the fixed series are united together in parallel arcs, so that there are two distinct circuits, in either or both of which lamps can be placed ; or they can be coupled up together. Great care appears to have been taken, in the

construction of this large machine, to guard against the appearance of eddy currents, by arranging the cores, frames, and coils, so that all metal parts of any size shall be slit, or otherwise structurally divided at right angles to the direction of the induced electromotive-force.*

An alternate-current machine having a pole armature was invented by Lontin. A skeleton diagram is given in Fig. 185. In this machine the field magnet (separately excited with a

FIG. 185.

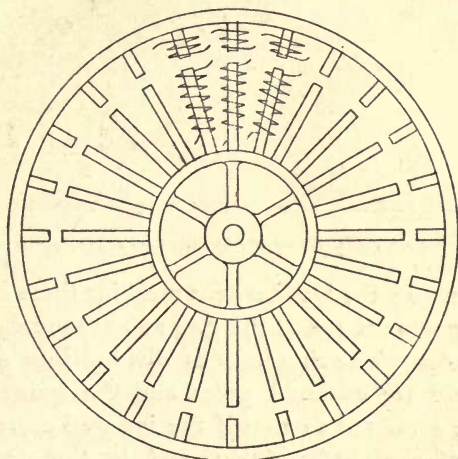

DIAGRAM OF PRINCIPLE OF LONTIN'S MACHINE.

continuous current) consisted of a set of radiating poles, and it rotated within an outer set of coils which served as a fixed armature. Figs. 186 and 187 show the arrangements of the actual machine, including the brushes by which the exciting current entered the rotating field magnets, and the terminals and switches for connecting the separate armature coils in any desired manner. This machine, which has long since been superseded, had many defects, not the least of which was the great mass of iron in which so many internal eddy currents were induced that the machine was very prone to become overheated. Indeed, it required more power to drive it on

* For further details of the Gordon dynamo, see Mr. Gordon's *Practical Treatise on Electric Lighting* (1884), p. 162.

open circuit than when the machine was supplying its maximum number of lamps.

Ring armatures, specially modified for the purpose, have been used in alternate-current machines by De Meritens and

FIG. 186.

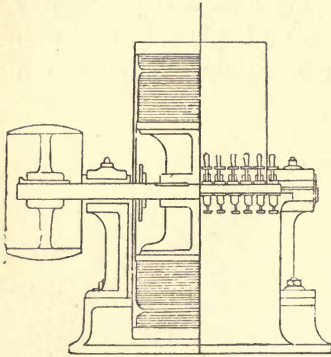
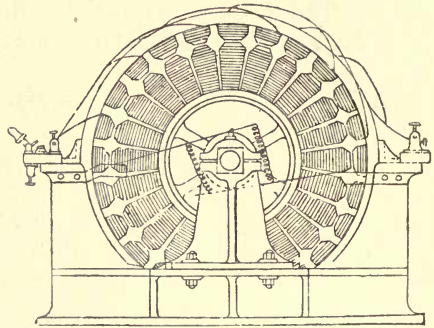

FIG. 187.



LONTIN'S ALTERNATE-CURRENT DYNAMO.

by Gramme. In the De Meritens machine there are a number of steel magnets set round the ring so as to present a crown of alternate poles. The ring itself is divided into as many sections as there are external poles, and the connexions of the sections are arranged so that if the induced current circulates in one section right-handedly, and in the next one left-handedly (as is the case when one of the sections approaches a N. pole while the next section is approaching a S. pole), the whole of the currents at any instant shall flow through the armature without opposing each other. A somewhat similarly connected ring is to be found in a type of alternate-current machine devised by Gramme. The field magnet of the radiating pole type, as in Lontin's machine, rotates within the ring and induces rapidly alternating currents in its sections, which are either wound or else connected alternately right-handedly and left-handedly. A diagram of the Gramme alternate-current machine is shown in Fig. 188. In each section of the ring a current is produced by the approach of a pole, and a current in the reverse sense by the recession of the pole.

A convenient machine in which the alternate-current dynamo and its exciter are combined in one, has been devised by Gramme for the purpose of supplying the currents required by Jablochhoff's electric candles. This machine is

FIG. 188.

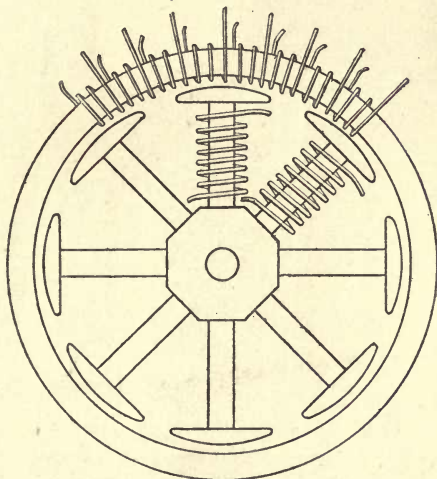

shown in Fig. 189. The exciter consists of an ordinary ring armature revolving (as seen in perspective) between 4 poles (as in Fig. 94), arranged like a St. Andrew's cross. This ring armature supplies current to a set of field magnets which rotate on the same shaft at its further end within an external cylindrical ring.

A very large alternate-current machine, having many points in common with that of Lontin, was shown at the late Electrical Exhibition at Vienna, by Messrs. Ganz, of Buda-Pesth. It was capable of furnishing light for 1200 Swan lamps (20 candle-power each). This dynamo, which in some respects resembled Gordon's machine, was constructed according to the Mechwart-Zipernowsky system. The thirty-six bobbins of the field magnet were set concentrically on an iron frame, and rotated within an outer circle of thirty-six armature bobbins. The field-magnet coils were, in fact, the fly-wheel of the high-pressure compound engine which drove the dynamo and its

exciter. The diameter of the rotating part was $2\frac{1}{2}$ mètres. A salient feature of this machine is the fact that any one of the coils, either of armature or field magnets, can be removed from

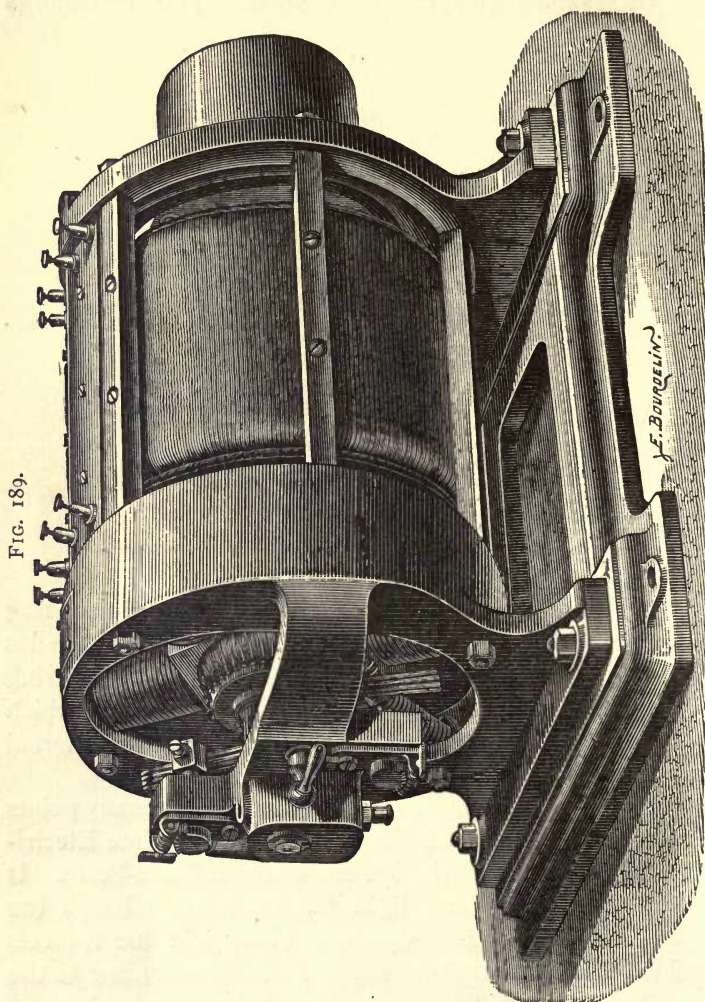

FIG. 189.

GRAMME'S "AUTO-EXCITATRICE" ALTERNATE-CURRENT DYNAMO.

the side of the machine, in case such are needed. The whole fly-wheel can, in this way, be taken down by one man in a few minutes. An electrical efficiency of 85 per cent. is claimed for this machine.

Another alternate-current dynamo, identical in many respects with the Siemens alternate-current dynamo, has been brought out, under the name of the Ferranti machine, which, in its most recent form, is shown in Fig. 190. As in the machines of Wilde and Siemens, the electro-magnets form

FIG. 190.

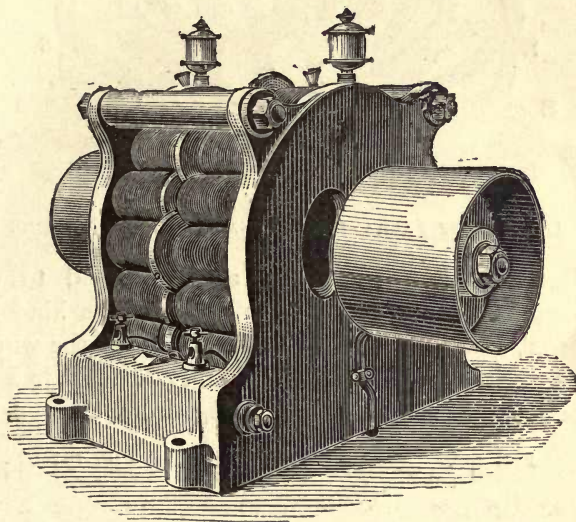

FERRANTI-THOMSON DYNAMO ("THOUSAND LIGHT").

two crowns with opposing poles. The point of difference is the armature, which, like that of Siemens, has no iron cores in its coils; but which, unlike that of Siemens, is not made up of coils wound round cores, but consists of zigzags of strip copper folded upon one another. There are eight loops in the zigzag (as shown in Fig. 191, which depicts half only of the arrangement), and on each side are sixteen magnet poles; so that, as in Gordon's dynamo, the moving parts are twice the angular breadth of the fixed parts. Fig. 190, which gives a general view of this machine, should be compared with the Siemens machine of Fig. 183 (p. 211). The advantage of the armature of zigzag copper lies in its simplicity of construction. Sir W. Thomson, who is one of the inventors of this

armature, proposed originally that the copper strips should be wound between projecting teeth on a wooden wheel,

FIG. 191.

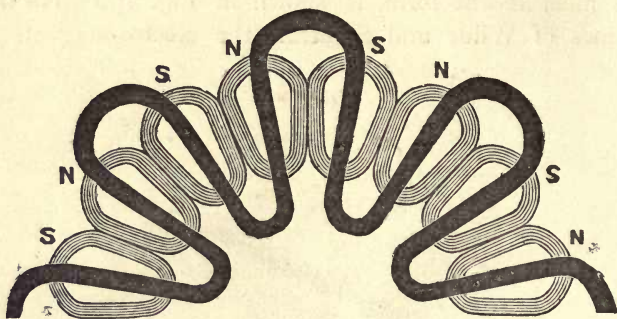

DIAGRAM OF FERRANTI ALTERNATE-CURRENT DYNAMO.

as indicated in Fig. 192. He also proposed to use as field magnets a form of electro-magnet of the kind known as Roberts', and also used by Joule, in which the wires that bring the exciting current are passed up and down, in a zigzag form, between iron blocks projecting from an iron frame.

FIG. 192.

SIR W. THOMSON'S ZIGZAG WINDING
OF ARMATURE FOR ALTERNATE-
CURRENT DYNAMO.

FIG. 193.

SIR W. THOMSON'S PROPOSED
FIELD MAGNETS.

Fig. 193 shows the form, as indicated in the specification, the conducting strips being wound round between wrought-iron projections screwed to a cast-iron frame. The framework of the machine is now cast in two halves, which are afterwards bolted together. Fig. 194 shows one half of the carcass

of the machine with its projecting circle of magnet cores C, which receive the field-magnet coils. The armature, originally

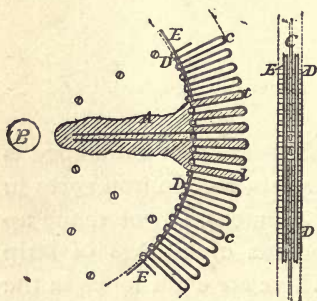
FIG. 194.

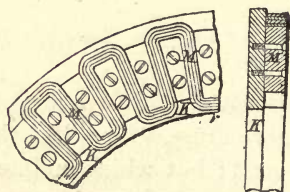
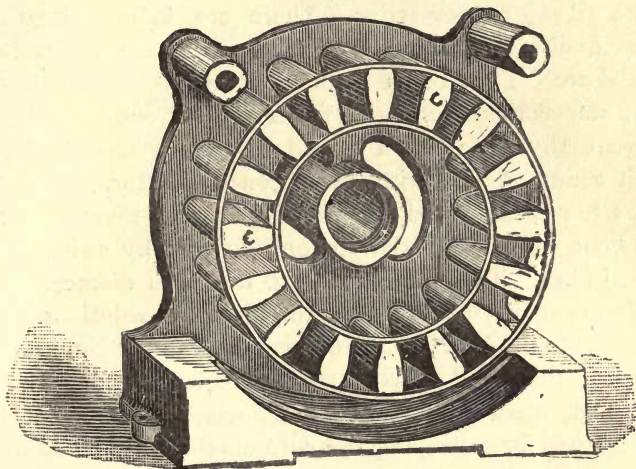

HALF-CARCASE OF FERRANTI DYNAMO.

FIG. 195.

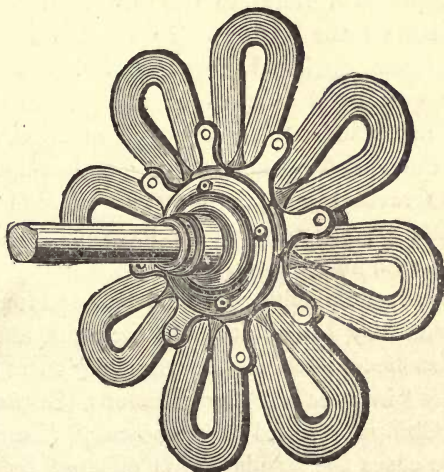

ARMATURE OF FERRANTI DYNAMO.

a single zigzag piece of copper, has assumed the form shown in Fig. 195, in which it may be seen that the convolu-

tions are multiplied, and are held in their places by bolts through a star-shaped piece of brass, which also serves to carry to one of the two collectors the connexion with one of the zigzag copper strips. There are, in fact, three complete circuits of copper strips in the armature connected in parallel arc. They begin at three of the alternate four bolts of the star-shaped piece, and, folding round one another, they all eventually unite with a second and inner star-shaped piece, which communicates with the second collector. Each strip makes ten turns round the zigzags, so that there are thirty layers, all well insulated from one another by strips of vulcanised fibre. This armature is 30 inches in diameter, and a little more than $\frac{1}{2}$ inch thick in the upper convolutions, so that the opposite poles of the field magnets can be brought very close together, and a very powerful field produced. The entire armature weighs only 96 lbs. Several arrangements have been essayed for conveying the currents to the external circuit. The axle usually carries on either side of the armature an insulated collector ring of bronze, to which the afore-mentioned star-shaped pieces are respectively connected. Instead of brushes, solid pieces of metal, in the form of hooks, have been employed to collect the current. In another recent machine mercurial contacts enclosed in cavities in insulated steel bearings are employed instead of the collectors described above. The machine requires a speed of 1400, and weighs $1\frac{1}{2}$ ton. M. Ferranti has also designed a slow-speed dynamo to run at 300 revolutions per minute, and feed 500 lamps. Dynamos with zigzag conductors have been designed by Rapieff, Matthews, and others.

Alternate-current machines have been used for lighting arc lamps "in series" by Jablochhoff, by Siemens, and by Lontin. They have also been used for distributing currents to incandescent lamps "in parallel" by Siemens, Gordon, Ferranti (Hammond Company), and Zipernowsky (Ganz and Co). In all of these cases the regulation is effected by varying the strength of the current supplied to the field magnets by a separate exciter; and practically this involves a hand-regulation by an attendant in every case. A peculiar method

of distribution of alternate currents by means of induction-coils termed "secondary-generators" has been brought into notice by Messrs. Gaulard and Gibbs.

The usual method of collecting the currents from alternate-current dynamos is shown in diagram in Fig. 196. Two undivided metal rings, forming the terminals of the armature coil, slide each under a single collecting-brush.

FIG. 196.

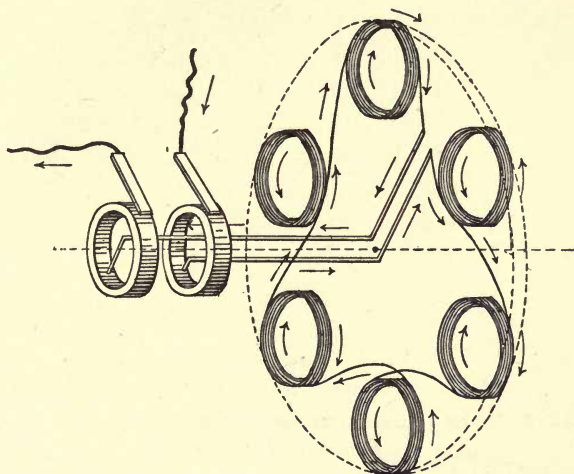

COLLECTING-RINGS OF ALTERNATE-CURRENT DYNAMO.

As was mentioned previously, there are two ways of coupling up the coils of alternate-current dynamos. For lighting incandescent lamps from parallel mains it is usual to unite the coils in parallel, as shown in Fig. 197, so as to reduce the internal resistance. For arc-lighting, where high electro-motive-force is required, the more usual mode of connecting is to join the several coils in series, as in Figs. 182, 196, and 198.

It may, in the present state of electric engineering be doubted whether, except perhaps in the matter of prime cost, any dynamo that yields alternate currents can compete with continuous-current machines. For the purpose of a general system of distribution, where more than one dynamo must be available, and also for the purpose of supplying motors,

alternate-current machines are not yet practically available. For, if the distribution is to be made at constant potential by branching mains and sub-mains, the difficulty inevitably comes in that alternating currents do not distribute themselves according to the resistance of the circuit, but according to the ratio of the self-induction to the resistance. And if the dis-

FIGS. 197, 198.

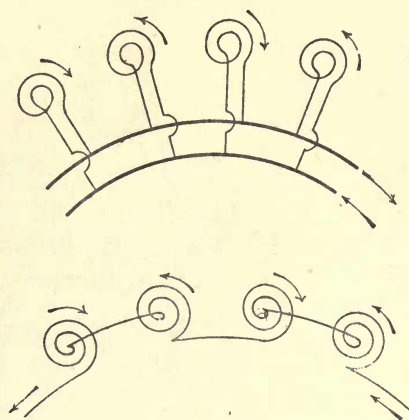

DIFFERENT MODES OF COUPLING UP ARMATURE-COILS OF ALTERNATE-CURRENT DYNAMO.

tribution is to be with a "constant current," there arises the difficulty that two alternate-current machines cannot be united in series to supply the circuit with the requisite enormous electromotive-force; for if so united they are found to work against one another, one driving the other as a motor. The risk of personal danger from alternate-current machines is also greater.

Calculations relating to alternate-current machines will be found in Chapter XVIII., p. 325.

CHAPTER X.

TYPES OF MACHINES—(continued).

Dynamos of Class III.

THE third class of dynamos comprises those in which rotation of a conductor effects a continuous increase in the number of lines of force cut, by the device of arranging one part of the conductor to slide on or round the magnet.

The earliest machine which has any right to be called a dynamo was, in fact, of this class. Barlow and Sturgeon had shown that a copper disk, placed between the poles of a magnet (Fig. 199) rotates in the magnetic field when traversed by an electric current from its axis to its periphery, where

FIG. 199.

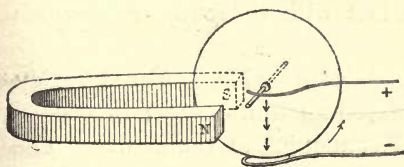

STURGEON'S WHEEL.

FIG. 200.

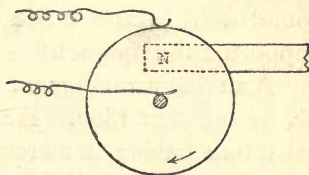

FARADAY'S DISK DYNAMO.

there is a sliding contact. Faraday, in 1831, showed that by rotating a similar disk mechanically between the poles of a magnet, continuous currents were obtained. These he drew off by collecting springs of copper or lead, one of which touched the axis (see Fig. 200), whilst the other pressed against the amalgamated periphery. He was thus "able to construct a new electrical machine."* "Here, therefore, was

* *Experimental Researches*, § 83.

demonstrated the production of a permanent [i. e. continuous] current of electricity of ordinary magnets." But Faraday did not stop short with ordinary magnets ; he went on to employ the principle of separate excitement of his field magnets. "These effects were also obtained from *electro-magnetic poles*, resulting from the use of copper helices or spirals, either alone or with iron cores. The directions of the motions were precisely the same ; but the action was much greater when the iron cores were used, than without."* The invention of the dynamo dates, therefore, from 1831, and Faraday was its inventor, though he left to others to reap the fruits of his splendid discovery.† Such a machine, however, is impracticable, for several reasons ; the peripheral friction is inadmissible on any but a small scale ; moreover, the disposition of the field magnets necessarily evokes wasteful eddy currents in the disk, which, even if slit radially, would not be an appropriate form of armature for such a limited magnetic field.

Another method of obtaining a continuous cutting of the lines of force is indicated in Fig. 201, where a sliding conductor travels round the pole of a magnet. Faraday even generated continuous currents by rotating a magnet with a sliding connexion at its centre, from which a conductor ran round outside, and made contact with the end-pivots which supported the magnet.

A similar arrangement was devised by Mr. S. Alfred Varley about the year 1862. He rotated an iron magnet in a vertical frame having a mercurial connexion at the centre. The current which flowed from both ends of the magnet toward the centre was, in this machine, made to return to the machine, and to pass through coils surrounding the poles of the rotating magnet, thus anticipating the self-exciting principle of later

* *Experimental Researches*, § III.

† *Experimental Researches*, § 158 :—"I have rather, however, been desirous of discovering new facts and new relations dependent on magneto-electric induction, than of exalting the force of those already obtained, being assured that the latter would find their full development hereafter." Can any passage be found in the whole range of science more profoundly prophetic, or more characteristically philosophic, than these words, with which Faraday closed this section of his researches?

date. Mr. Varley also proposed to use an external electro-magnet to increase the action.

Quite recently, the same fundamental idea has been worked upon by Messrs. Siemens and Halske, who have produced a

FIG. 201.

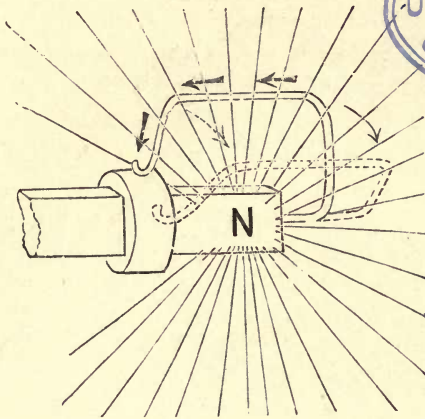

CONDUCTOR SLIDING ROUND POLE OF MAGNET AND CUTTING LINES OF FORCE.

so-called "unipolar" machine,* depicted in Fig. 202. In this remarkable dynamo there are two cylinders of copper, both slit longitudinally to obviate eddy currents, each of which rotates round one pole of a U-shaped electro-magnet. A second electro-magnet, placed between the rotating cylinders, has protruding pole-pieces of arching form, which embrace the cylinders above and below. Each cylinder, therefore, rotates between an internal and an external pole of opposite polarity, and consequently cuts the lines of force continuously by sliding upon the internal pole. The currents from this machine are of very great strength, but of only a few volts of electromotive-force. To keep down the resistance, many collecting brushes

* This sounds like a *lucus a non lucendo*, for the machine has two poles. But the name is derived from the term "unipolar induction," which Continental electricians give to the induction of currents by the process of "continuous cutting" which we are now dealing with. I do not adopt the term, as it is needlessly mystifying.

press on each end of each cylinder. This dynamo has been used at Oker for electro-plating. Other unipolar machines have been designed by Mr. Floyd Delafield, by Mr. J. Rapieff, by Mr. E. L. Voice, and by Signor Ferraris. No details of their performances are known.

FIG. 202.

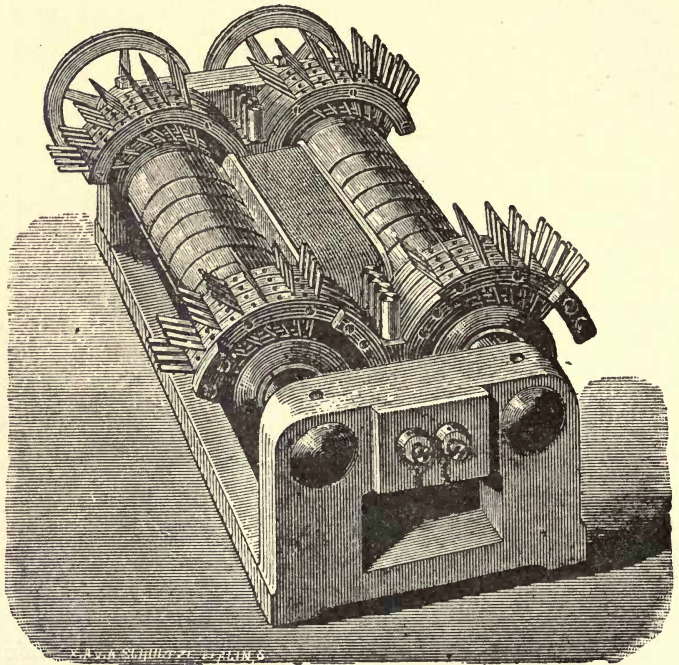

SIEMENS' "UNIPOLAR" DYNAMO.

Much attention has been paid lately to machines of this type, and the author has himself designed such a machine, in which two Faraday disks coupled at their peripheries outside an internal stationary pole-piece, rotate in a symmetrically-uniform magnetic field. Mr. S. A. Varley has also worked in the same direction. Still more recently Mr. Willoughby Smith has shown that if an iron disk be used instead of a copper disk in the Faraday apparatus, a much more powerful effect is obtained, and the electromotive-force is more nearly proportional to the speed than is the case with a copper disk.

Forbes' Dynamo.—Prof. George Forbes has constructed a very remarkable machine of this class. Originally he began by employing an iron disk which rotated between two cheeks of opposite polarity, the current being drawn from its periphery. He then doubled the parts, as shown in sectional diagram in Fig. 203, where D, D represent the iron disks mounted on a common shaft, and enclosed within a mass of iron *s s s*, which serves as field magnet, and is excited by coils C, C contained in hollow rings of trapezoidal section surrounding the peripheries of the disks. The current traverses these radially, from

FIG. 203.

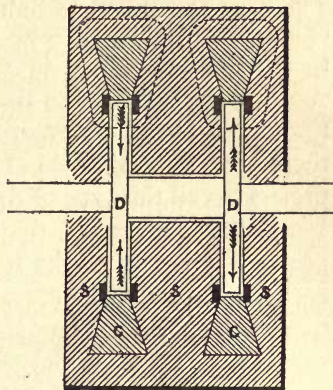

SECTION OF FORBES' DOUBLE-DISK NON-POLAR DYNAMO.

FIG. 204.

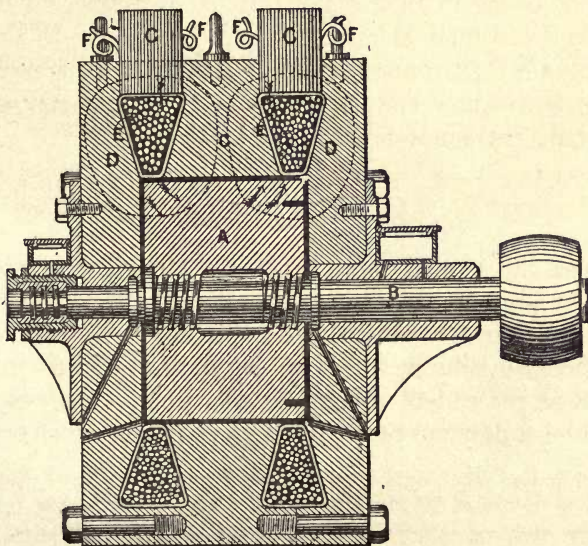

SECTION OF FORBES' NON-POLAR DYNAMO.

periphery to axle in one, from axle to periphery in the other. A rubbing contact—for which purpose Prof. Forbes now uses carbon “brushes”—is maintained at the peripheries. The next stage was to unite the two disks into one common cylinder, as shown at A in Fig. 204. Here the coils lying in their cases are shown in section as before, the dotted lines showing the direction of the lines of magnetic force induced in the iron. These are practically closed on themselves so that there is no external field at all. For this reason the inventor prefers to call this type of dynamo “non-polar.” A view of the complete “non-polar” dynamo is given in Fig. 205. The protruding strips at the top are the terminals. One of the earlier forms of machine, with a single disk 18 inches in diameter, gave 3117 ampères at a potential of 5·8 volts when running at 1500 revolutions per minute. One of the later machines, in which the “armature” is a cylinder of iron 9 inches in diameter and 8 inches long, is designed to give, at 1000 revolutions per minute, a current of 10,000 ampères at a potential of one volt. These machines have a very high efficiency owing to their small internal resistance: but, from the lowness of their electromotive-force, they are as yet suitable only for electro-metallurgical work. Their electromotive-force increases, however, as the square of the diameter. These results are extremely hopeful and suggestive.*

Unclassed Dynamos.

There are two or three other new designs for machines, which at present can hardly be called anything but curiosities. There is, for example, the absurd tuning-fork dynamo suggested by Edison, which was to wave to and fro a couple of coils at the end of prongs 3 yards long. There is also a design for a dynamo by Sir Charles Bright, in which the field-

* For further information respecting the “unipolar” type of dynamo, see Ferraris in *Zeitschrift des elektrotechnischen Vereins in Wien*, vol. i., October 1883; de Tromelin in *l'Électricité*, December 15, 1883, p. 594; *La Lumière Électrique*, May 1884, p. 307, and September 1884, p. 309; *Centralblatt für Elektrotechnik*, Bd. vii., 1884, p. 327 and p. 402.

magnet coils and armature stand still, but in which the iron cores and the brushes rotate. Mr. C. Lever has designed

FIG. 205.

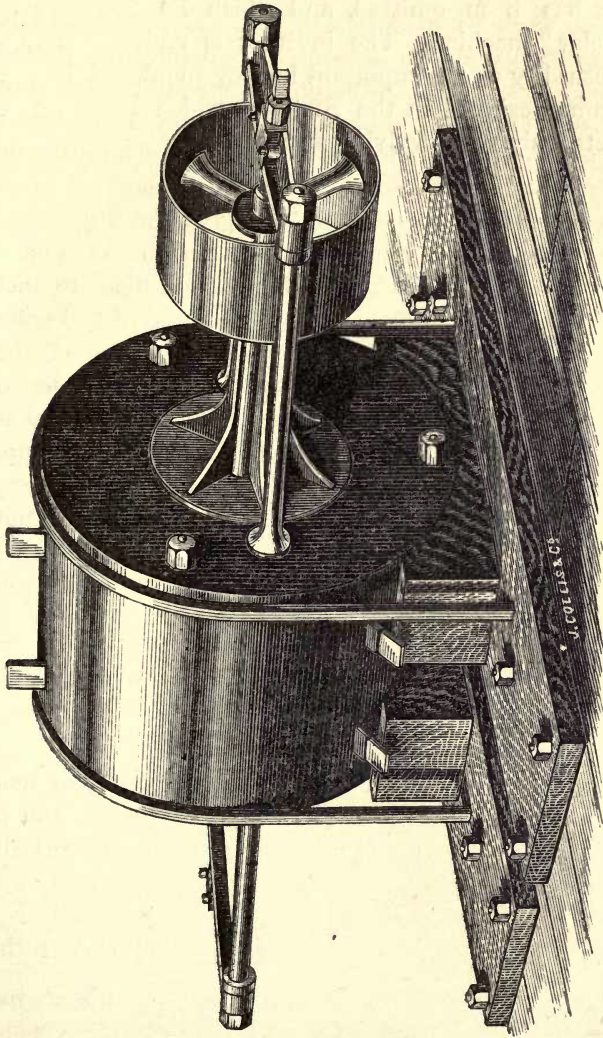

FORBES' NON-POLAR DYNAMO.

a machine on somewhat similar principles to the foregoing. I have myself essayed an alternate-current machine, in which

both armature and field magnets stand still, while laminated pole-pieces alone revolve. An American, Ball, has constructed a Gramme dynamo from which one of the two pole-pieces has been omitted, and which he therefore calls a "unipolar" machine. The inventor is understood to regard this absurdity as an important improvement. I hear also of a dynamo designed in the States in which there are no field magnets, only two revolving armatures.

CHAPTER XI.

DYNAMOS FOR ELECTROPLATING AND ELECTRO-METALLURGY.

SPECIAL forms of dynamo are needed for the work of electroplating, electrotyping, and the electrolytic treatment of ores and purification of metals. In general, very low electromotive-forces and very large currents are requisite, for the quantity of metal deposited in the bath depends upon the quantity of ampères of current only, and not on the number of volts of electromotive-force. And though a few volts are requisite to drive the requisite current through the resistances of the circuit, the number is in every case small. To decompose water electrolytically requires less than two volts. To deposit metal in a bath in which the anode is of the same metal requires a very small fraction of a volt. In general, if too great an electromotive-force is employed, or if the density of current (i. e. the number of ampères per unit of area of kathode surface) is permitted, the metallic deposits will be uneven or pulverulent. All these circumstances point to the construction of dynamos having at most but four or five volts of electromotive-force, but so designed as to have an exceedingly low internal resistance.

The first application of a dynamo to the purpose of electroplating is due to Mr. J. S. Woolwich, who in 1842 patented this use of a magneto-electric machine.

Wilde's Dynamos.—Wilde, however, was the first to construct machines really fitted for the purpose, when he invented the principle of using a large dynamo the field magnets of which were separately excited by the currents of a smaller magneto machine. His first machines, which were used for many years by Messrs. Elkington, had small excitors of the

old Siemens type (Fig. 19), mounted upon electro-magnets of the form shown in Fig. 3. Both armatures were of the old shuttle-form introduced by Siemens, and the larger one required to be kept cool by streams of water. About the year 1867 Wilde introduced another type of machine, to which reference was made on p. 208. In this dynamo (Fig. 206) the arma-

FIG. 206.

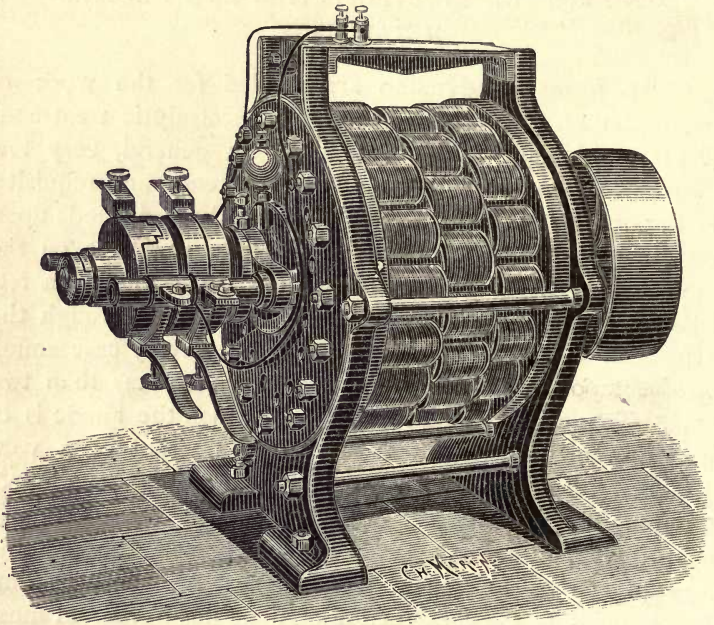

WILDE'S DYNAMO.

ture consists of sixteen coils rotating between two crowns of opposed electro-magnets, each also consisting of sixteen coils. This machine is sometimes arranged (and indeed is so shown in the figure) as an alternate-current machine, having two collecting rings with a brush pressing against each. It is made to excite itself by the device of leading the currents from one of the armature coils (which is disconnected from the rest) to a separate commutator—fixed on the axle in front of the collecting rings—which “rectifies” the currents from

this coil. When the machine is used for electro-metallurgical work, the pair of collecting rings are replaced by a second rectifying commutator. The armature coils (save the one used for feeding the field magnets) are connected in parallel in the manner shown in Fig. 197. There are iron cores in the armature coils of this machine, which is, in consequence, prone to heat.

Weston's Dynamo.—The field magnet of this machine (Fig. 207) consists of a cast-iron cylinder, having six inter-

FIG. 207.

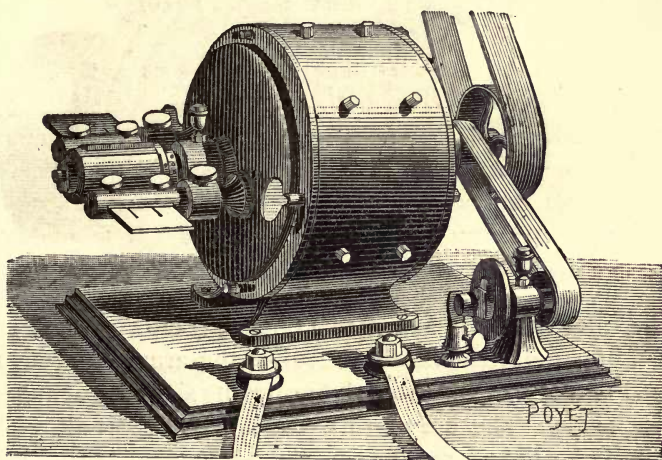

WESTON'S ELECTROPLATING MACHINE.

nally projecting electro-magnets of alternate polarity with steel cores. The armature is a six-pole arrangement, resembling Fig. 31, but differently connected, the six coils being joined in parallel (as in Fig. 197). The commutator merely rectifies the alternating currents. There is added a small centrifugal cut-off to break the circuit when the speed is less than that which will provide the requisite electromotive-force. The object of this device, as well as that of the steel cores, is to prevent the machine from having its polarity reversed by a back-current arising from polarisation in the baths.

Elmore's Dynamo.—Elmore has devised several forms of dynamo for electrolytic purposes. Fig. 208 shows one of the

FIG. 208.

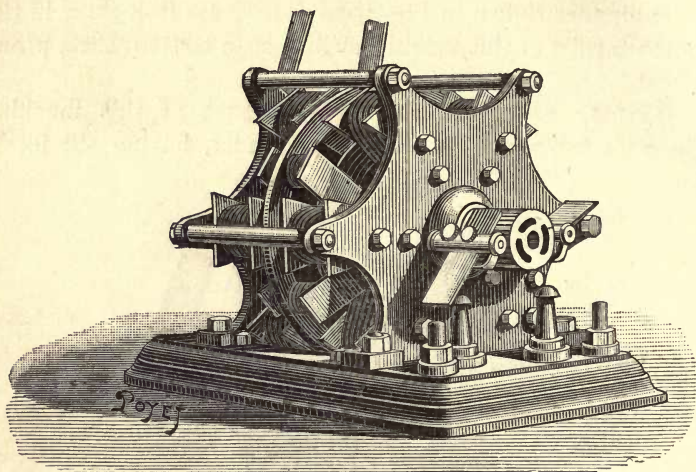

ELMORE'S DYNAMO.

smaller machines. Between two opposing crowns, each consisting of six electro-magnets, revolves the armature, which is formed of a hollow cast-iron plate carrying six electro-magnets on each side. The use of this cast-iron frame is altogether bad, as it heats and requires special arrangements to keep it cool. The shaft is perforated, and in the larger machines a supply of cold water is caused to circulate through the armature. Such a circumstance is sufficient to condemn the design of the armature. The commutator merely rectifies the currents (p. 24), without rendering them continuous. It resembles the collector used in the majority of closed-coil dynamos, in being made of a number of parallel bars; but these are connected together into two sets, Nos. 1, 3, 5, &c., being joined into one set, and Nos. 2, 4, 6, &c., into another set. This arrangement is of course equivalent to the crown-wheel commutator used by Jacobi and by Wilde (see p. 210). The armature coils are in most of these machines grouped together

in pairs (in series), and the separate pairs are then united in parallel, one end of the wire of each pair being connected to the odd-number set, the other end to the even-number set, of the commutator bars. The two brushes are so set that while one touches a bar of one set the other touches a bar of the other set. There are as many bars in the commutator as there are electro-magnets in each "crown" of the field. The largest Elmore dynamos, for copper refining, have eighteen electro-magnets in each crown, and yield a current of 3000 ampères at a potential of seven to eight volts. Such a machine will deposit over 25 lbs. of copper per hour, and is worked with a current density of about three ampères per square foot of depositing surface.* The field magnets are included in series with the main circuit. This is a mistake. All electroplating dynamos should be either shunt-wound or else compound-wound.

Gramme's Dynamo.—When the Gramme dynamo is used for electrolytic purposes, the armature is modified so as to reduce its resistance. The armature shown in Fig. 94, built up of copper strips, is suitable for this purpose. Fig. 209 illustrates a machine built in 1873 for the Hamburg copper-refining works. The cylindrical "ring" is constructed in forty sections, each consisting of seven strips of copper 3 millimetres thick and 10 millimetres wide; twenty of the sections being connected to a collector at one end, the alternate twenty to a second collector at the other end of the shaft. The field magnets are wound with thirty-two turns of sheet copper, and are in series with the main circuit. When the two armatures are used in parallel, the machine gives 1500 ampères with an electromotive-force of eight volts. The machine weighs about one ton, of which about one-third is copper, two-thirds iron.

Siemens' Dynamo.—A special form of machine suitable for very strong currents and low electromotive-forces has been

* The student is referred to a paper by Captain H. D. Sankey, R.E., in *Journal Soc. Electr. Engin. and Electr.*, vol. xiv., No. 55, p. 28, for an account of experiments in electrotyping with an Elmore dynamo.

FIG. 209.

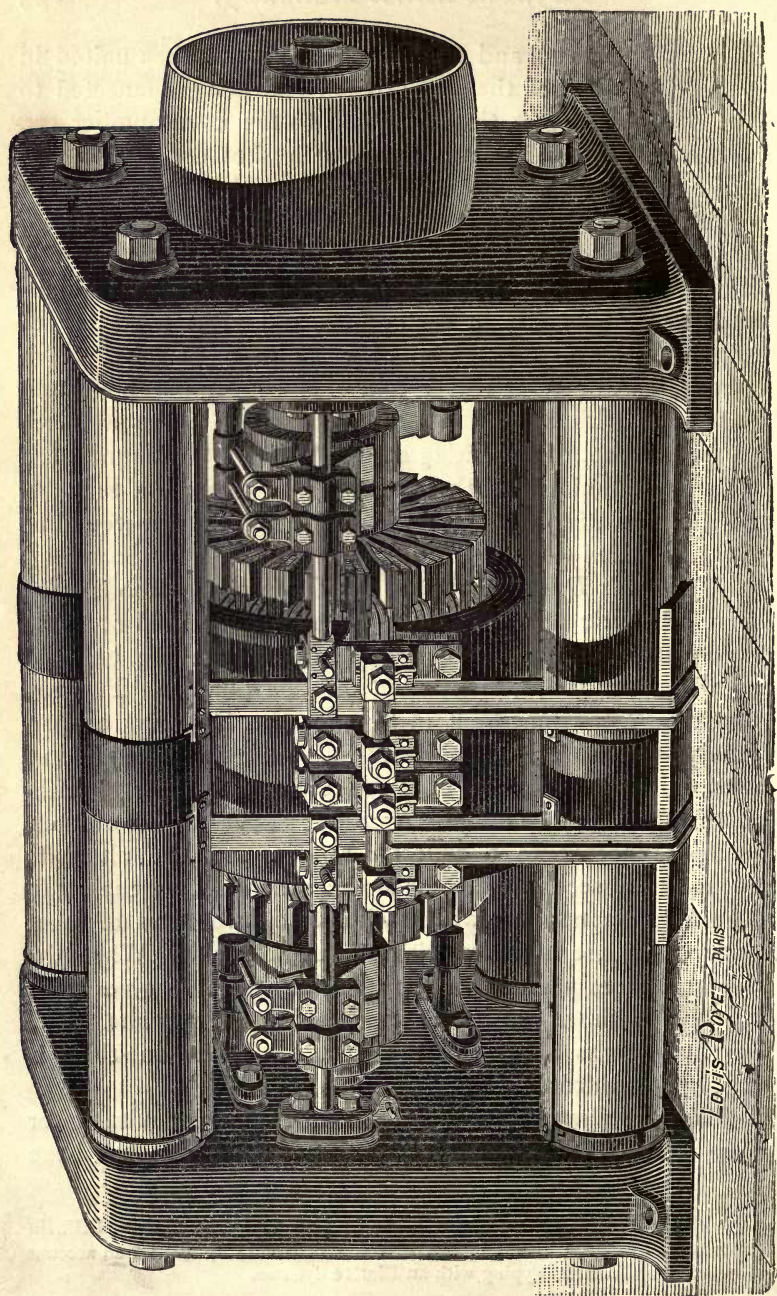

GRAMME DYNAMO FOR ELECTRO-METALLURGY (1873).

LOUIS POYET PARIS

constructed by the firm of Siemens. Both armature and field magnets are formed of bar copper of large cross-section insu-

FIG. 210.

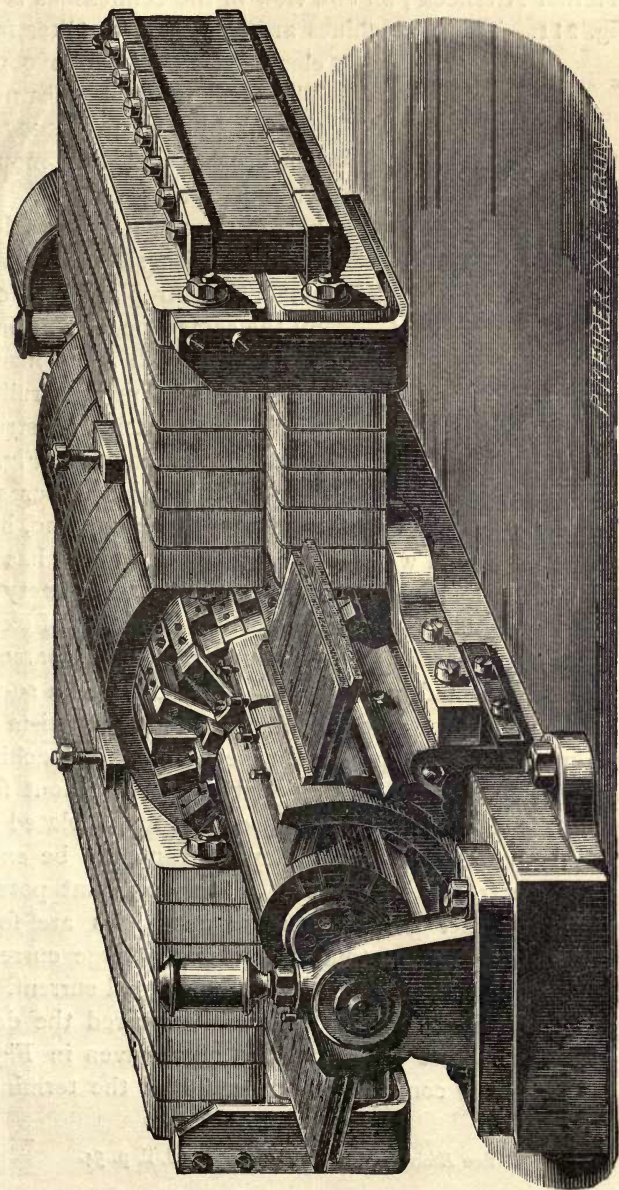

SIEMENS DYNAMO FOR ELECTRO-METALLURGY.

lated by air-spaces which admit of free circulation of air. The armature is connected up in the manner devised by von Hefner Alteneck ; an end view of the connexions is given in Fig. 211. These machines are employed at Oker for the electrolytic treatment of copper.*

FIG. 211.

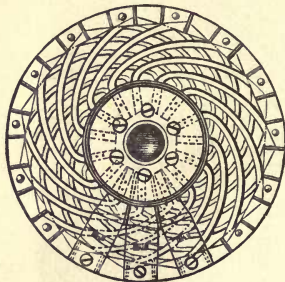

ARMATURE OF SIEMENS
DYNAMO.

The total internal resistance of this machine is but 0.0007 ohm. The brushes are solidly mounted without spring contacts. The bars of the armature are soldered together with silver solder. In smaller electroplating machines by the same firm, the armatures are wound with stout insulated wires joined four in parallel, as being more easily constructed. The unipolar machine (Fig. 202)

was specially designed for electro-metallurgical purposes.

Brush Dynamo.—A variety of the Brush dynamo, having the armature wound with coils of a low resistance, has been used for electroplating purposes. It was for this type of machine that Brush made the important invention of exciting the field magnets with a compound winding ; coarse wire coils being connected in series, with the addition of a so-called “teazer” coil of finer wire to maintain the magnetism when the main circuit was opened, thus enabling the machine to do either a large or a small amount of work without fear of reversing the current. When objects are to be plated in an electrolytic bath, regularity of deposit can only be ensured when the electrodes are kept at a fairly constant potential, no matter whether a large number of articles are for the moment undergoing treatment, requiring a large current, or whether the number be small, requiring a small current. The compound winding adopted by Brush answered the desired end with remarkable success. The curve given in Fig. 212 shows how nearly constant the potential at the terminals of

* See *Elektrotechnische Zeitschrift*, vol. ii. p. 54.

this machine is. It varied only from 3·3 to 4·1 volts, whilst the current varied from 300 ampères to zero.

FIG. 212.

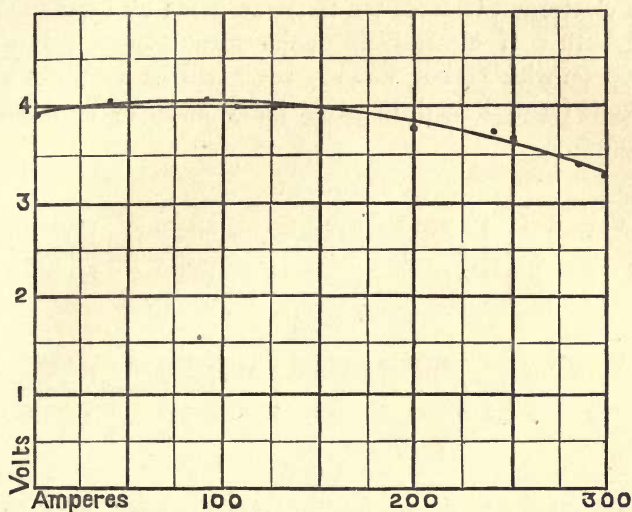

CURVE OF POTENTIAL AT TERMINALS OF BRUSH DYNAMO FOR ELECTROPLATING.

Forbes' Dynamo.—The simplicity and very low resistance of this machine, Fig. 205, appear to make it pre-eminently suitable for electrolytic work of all kinds. It is fully described on page 227.

NUMERICAL STATISTICS ON ELECTRO-METALLURGY.

The following data are useful for reference in deciding what the electrical capacity of a dynamo must be in order that it may deposit metal in any desired quantity.

Copper.

Current	1 ampère	deposits	0·000326 grammes	per second.
"	1 "	"	0·01957 "	per minute.
"	1 "	"	1·1739 "	per hour.
"	851·8 "	"	1 kilogramme	per hour.
"	386·4 "	"	1 pound	per hour.

To deposit 100 lbs. of copper in a working day of ten hours will require 3864 ampères of current flowing all the time ; or, if conducted in ten baths in series with one another will require 386.4 ampères, but in that case the dynamo will require to be of an electromotive-force ten times as great as for one single large bath. If electrolysis of the crude copper solution is carried on with carbon anodes, there will be required about 1.2 volts for each bath in series, or, at most, 15 volts for the ten baths.

Silver.

Current of	1	ampère	deposits	4.025	grammes	per hour.
"	"	248.5	"	"	1	kilogramme per hour.
"	"	112.7	"	"	1	pound per hour.

Gold.

Current of	1	ampère	deposits	2.441	grammes	per hour.
"	"	409.7	"	"	1	kilogramme per hour.
"	"	185.8	"	"	1	pound per hour.

Nickel.

Current of	1	ampère	deposits	1.099	grammes	per hour.
"	"	910.1	"	"	1	kilogramme per hour.
"	"	412.8	"	"	1	pound per hour.

CHAPTER XII.

ALGEBRAIC THEORY OF THE DYNAMO.

IN the following chapters algebraical expressions are found for the electromotive-force, the current, and the economic coefficient of the principal types of dynamo. As an introduction to the subject, an expression is found for the average electromotive-force induced in a simple coil rotating in a uniform magnetic field. This naturally leads to the consideration of magneto-dynamos in which the field is due to permanent magnets of steel. The step to dynamos the field magnets of which are separately excited by currents from an independent source, is an easy one. Then follows the ordinary or series-wound dynamo, and after that the shunt dynamo. Lastly, come the various kinds of compound machines, devised so as to give either a constant electromotive-force, or else a constant current.

It may be well to point out that in this and the succeeding chapters the following symbols are used in the following significations:—

- | | | |
|---------------|--|-------------------------------------|
| A | armature-coefficient, expressed in <i>square centimetres</i> (see p. 246 and p. 248). | |
| <i>b</i> | number of turns of wire in a coil or section. | |
| β | angular breadth of a section of armature coil or of segment of collector. | |
| <i>c</i> | number of segments of collector or commutator. | |
| E | entire electromotive-force generated in an armature, | } expressed
in
<i>volts</i> . |
| ϵ | difference of potential from brush to brush, | |
| <i>e</i> | difference of potential from terminal to terminal, | |
| \mathcal{E} | electromotive-force of some external supply of electricity, | |
| η | economic coefficient (see p. 268). | |
| F | force (i. e. push or pull), expressed in either <i>dynes</i> , <i>poundals</i> , <i>grammes'</i> weight, or <i>pounds'</i> weight. | |

- G a geometric coefficient, pertaining to field magnets, and depending only on their size and shape, or on the size and shape of their coils and pole-pieces (see Note on p. 286).
- H intensity of magnetic field, expressed in *gausses* (see Note 3, p. 246).
- i current in external circuit,
- i_a current in armature,
- i_s current in shunt coil,
- i_m current in series coil of field magnet,
- κ coefficient of magnetic permeability of iron.
- L coefficient of self-induction.
- λ average length of one turn of wire in a coil.
- N number of lines of magnetic force.
- n number of revolutions *per second*.
- ω angular velocity (expressed in *radians-per-second*).
- R resistance of external circuit,
- r_a resistance of armature coils,
- r_s resistance of shunt coils,
- r_m resistance of series coil on field magnets,
- r internal resistance of dynamo; equal to $r_a + r_m$ or to $r_a + r_s$ according to circumstances,
- ρ resistance per unit of length,
- S number of turns of wire in field-magnet coil in series with armature.
- σ saturation-coefficient of iron (see p. 284).
- T torque, or turning-moment, or angular force, or couple, or "effort statique," or "statisches Moment," expressed in *dyne-centimetres*, *gramme-centimetres*, *kilogramme-metres*, or *pound-feet*, according to circumstances.
- T is also used in the section on alternate-current dynamos for the periodic time of the alternating current, measured in *seconds*.
- t time, measured in *seconds*.
- W } activity, or work-per-second, expressed in *watts* or in *horse-*
 w } *power*.
- Z number of turns of wire in shunt field-magnet coil.

} expressed
in
ampères.

} expressed
in
ohms.

Ideal Simple Dynamo.

Consider a single loop of wire, bent in either a circular or a rectangular form, rotated about an axis in its own plane in a uniform magnetic field. Fig. 213 will help us to realise the case.

We calculate the *average electromotive-force* as follows:—
 We know that if the coil in rotating cuts the lines of force

so as to add a certain number of lines of force to those already passing through the circuit, the electromotive-force induced thereby will be numerically equal to the number so enclosed divided by the time taken to enclose them. We will

FIG. 213.

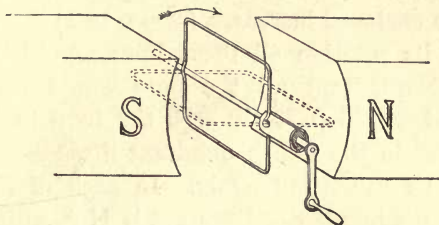

IDEAL SIMPLE DYNAMO.

for the sake of simplicity call the rate of thus enclosing additional lines of force, the rate of "cutting" the lines. If we represent the number of additional lines of force so enclosed by the symbol N , and the time (expressed in seconds) occupied in the process by t , then we may write :—

$$\text{Average rate of cutting} = \frac{N}{t}.$$

Or, remembering that this is the same thing as the average electromotive-force thereby induced, we may write, using the symbol E for the electromotive-force:—

$$(\text{Average}) E = \frac{N}{t}.$$

Now, in our ideal case, how must we compute the number N ? Suppose the rotating loop circuit to have an area which, measured in square centimetres, we denote by the letter A . Also suppose that the intensity of the magnetic field is denoted by the symbol H . This means that there will be H lines of force to every square centimetre on a cross-sectional surface through the field. Then obviously the greatest actual number of lines of force that can at any one time pass through the loop from one side to the other is HA . If the loop

occupy the vertical position shown in Fig. 213, it will enclose $H A$ lines of force. In any other position it would enclose fewer. If laid parallel to the lines of force, as in the position indicated by the dotted lines, no lines of force will be enclosed. If it started from this position, and were rotated through a quadrant until it assumed the vertical position, the number of lines of force enclosed increases from 0 to $H A$. In the next quadrant of its rotation all these lines would be taken out. In the third quadrant all the lines would be once more enclosed, and would pass through the loop in the negative direction; and in the fourth quadrant these negative lines of force would be taken out again. In each of the four quadrants, then, the number of lines cut is $H A$, either positively or negatively; and if a simple split-tube commutator be applied to the loop in connexion with a pair of metal springs or brushes, the electromotive-forces during each of the four quadrants of the rotation may be made to send currents in the same direction through the external circuit. If T be the time of one whole revolution, it follows that:—

$$(\text{Average}) E = \frac{4 H A}{T}.$$

If the speed is quick, T will be a small fraction of a second. Call it $\frac{1}{n}$ of a second; or in other words, let there be n revolutions per second. Then we may write n instead of the fraction $\frac{1}{T}$, so that our formula becomes:—

$$(\text{Average}) E = 4 n H A. \quad [I.]$$

Now for many purposes it is more convenient to have the formula in a term of the angular velocity. Let the symbol ω represent angular velocity.

Then,

$$\omega = 2 \pi n,$$

for in each revolution, the angle described is 2π radians or

360°. Consequently $n = \frac{\omega}{2\pi}$; which brings the formula to

$$(\text{Average}) E = \frac{4 H A \omega}{2 \pi},$$

which reduces to the final form,

$$(\text{Average}) E = \frac{2}{\pi} \omega H A. \quad [\text{Ia.}]$$

Note (1).—It will be observed that this electromotive-force is simply an average, and that the electromotive-force in reality fluctuates between zero and a maximum. Calling the lowest point of the rotating loop in its vertical position 0°, then the position on the left of the dotted line will be 90°, if we reckon the angle of rotation in the clockwise direction. The top point will be 180°, and the point on the extreme right 270°. Then the induced electromotive-force will be a maximum as the coil passes through 0° and 180°, and zero as the coil passes through 90° and 270°, for the *rate* of enclosing will be a *maximum* when the *actual number* of lines enclosed is a *minimum*, and *vice versa*. (See p. 54.)

Note (2).—At any intermediate angle, the actual number of lines of force enclosed is proportional to the cosine of the angle through which the coil has turned from its zero position, and the electromotive-force will be proportional to the sine of that angle. Strictly speaking, we ought to take the sine with a *negative* value to represent the electromotive-force, because as usually defined the induced electromotive-force is proportional to the rate of *decrease* in the number of lines of force enclosed. We need not, however, trouble about signs, because, if the commutator is properly set, all the induced electromotive-forces are thereby made to act in the same direction through the external circuit. The actual electromotive-force in the loop at the moment when it has rotated through an angle θ *might* therefore with propriety be written :—

$$E = \omega H A \sin \theta, \quad [\text{II.}]$$

and this expression would have values fluctuating between 0 and $\omega H A$, as θ varied from the beginning to the end of a quadrant of the rotation. Now, since the average value of $\sin \theta$, between the limits $\theta = 0$ and $\theta = 90^\circ$, is $= \frac{2}{\pi}$, the *average* electromotive-force may be obtained by substituting this value, which gives us as before

$$\text{(Average) } E = \frac{2}{\pi} \omega H A.$$

Note (3).—If A is expressed in square centimetres, and it is desired that E shall be expressed in volts, then H must not be expressed in the usual units of magnetic field-intensity of the centimetre-gramme-second system; for in that system the unit of electromotive-force is only the hundred-millionth part of 1 volt. The volt being 10^8 C.G.S. units of electromotive-force, the corresponding unit of field-intensity of magnetism would be 10^8 of the C.G.S. units. Such a unit of field-intensity might be called “one *gauss*.” If H be expressed in *gausses* and A in square centimetres, then $4\pi H A$ will be the average electromotive-force in *volts*.

Simple Armature of many Turns. (No iron.)

Hitherto we have considered an armature consisting of one turn only. Suppose, however, that the armature consists of a coil of b turns, all of the same area, and that all these turns are wound side by side on a core of wood or some non-magnetic material, the ends of the coil being brought as before to a simple split-tube 2-part commutator (see Figs. 17, p. 22, and 216, p. 252). The induced electromotive-force will clearly be b times as great as if there were but one turn. Owing to the fact that the resistance is also greater, it is clear that the current generated in the whole circuit would not be b times as great as if but one turn were used. We are not here, however, concerned with the current, but only with the electromotive-force. Moreover, in practice, if the wire were wound in several layers over the core, the area of each turn

could not be alike, as the outer turns of the coil would be larger. If, however, we could ascertain the average area, and call this a , then the whole effect of the coil of b turns, each of average area a , would be b times that due to coil of area a , or would be equal to that which might be produced by a single large turn of area $b \times a$. We might then write the effect in the form

$$\text{(Average) } E = 4 n H a b.$$

But we may just as easily use the symbol A for the equivalent area of b times a , and then the old formula

$$\text{(Average) } E = 4 n H A$$

will still hold good, provided we remember that A now means the total area of all the separate turns added together. If the armature coil consist of two sets of coils connected in parallel arc (as in Figs. 23 and 24, p. 24), the electromotive-force due to the two sets will be no greater than that due to one set; but, on the other hand, the internal resistance will be halved. In this case A will be equal to only one-half of ab , so far as the power of the armature to induce electromotive-force is concerned.

Simple Armature with Iron Core.

Suppose now our armature to be provided with an iron core to the coil. What difference will this make? In the first place, the magnetic field will be no longer uniform, unless we specially curve the pole-pieces to make it so. That is, however, the usual practice, and though the field is not ever actually uniform, the rule still holds good that the *average* electromotive-force will be found by dividing the total number of additional lines of force enclosed by the time taken to enclose them. But the point that is really important is this: iron is so much more highly permeable to magnetic induction than air or wood is, that more lines of force are induced through it than would be induced by the same field magnets through a core of non-magnetic stuff.

An iron core draws more lines of force through itself than a core of non-magnetic matter: the coil with an iron core acts like a coil many times as large an area without an iron core. The number of times that the iron core multiplies the effect might be symbolised by the letter κ ; and then we might say a coil of b turns of average area a , with an iron core, has an effect equal to κ times that of a coil of b turns of average area a without iron. The number symbolised by κ might be as much as twenty or thirty, or even fifty, if the iron were very pure and soft. If it were merely cast iron, κ might, perhaps, not be worth more than two or three. Its value depends on the quality, grain, and shape of the core and on its cross-section, it depends also on the magnetic intensity of the field, whether it is able to saturate the iron or not. We might, then, write the formula:—

$$\text{(Average) } E = 4 n H \kappa a b ;$$

but there is no reason why we should not extend the meaning of our old symbol A , and make it mean henceforth an area equal to κ times as great as an area b times as great as the average area a of one turn. We may call A the "equivalent area" to the coil with its many turns and its multiplying iron core, and so, with this new signification, our old formula still holds good, as

$$\text{(Average) } E = 4 n H A.$$

This is the formula which would be used with the old shuttle-wound Siemens armature of 1856.

Any Armature.

The value of A , the "equivalent area," might be found by experiment as follows:—Lay the armature horizontally, with the axis in the magnetic meridian, and with the turns horizontal, so that the earth's lines of magnetic force run vertically through the iron core. Connect the ends of the coil by wires to a circuit in which there is included a slow-beat reflecting galvanometer and a "standard" coil of the following kind. The standard coil with which the armature is to be compared will consist of a coil of well-insulated wire, wound on a circular frame so as to have the form of a hoop of a good many turns. Measure the area a' (in square centimetres) of the hoop (or the average area of the turns), and count the

number of turns b' . If there are b' turns each of area a' , then we know that the equivalent area of this coil is exactly $a' b'$, and therefore we may use it as a standard. Having connected the armature and the standard coil in circuit with the galvanometer, lay the standard coil flat on the table. Then suddenly turn it over on to its other face (it is best to turn it in the east-and-west direction, not the north-and-south), and observe the throw imparted to the galvanometer. Then, leaving the coil still, turn the armature likewise through half a revolution with a single rapid movement, and again note the throw of the galvanometer. Calculate the equivalent area A of the armature by a simple rule-of-four sum. Calling the throw due to the standard coil δ_1 and that due to the armature δ_2 , then we get

$$\delta_1 : \delta_2 :: a' b' : A.$$

For very exact work the sine of half the angle of the first swing of the galvanometer should be taken, instead of the mere throw.

This process of finding the "equivalent area" may be applied to every closed-coil armature. But a caution is needed here. If the armature be one in which the wire coils are not all in one group as in the simple old shuttle-wound Siemens, but are arranged symmetrically in sections, as in the ring armatures of Gramme or Pacinotti, or in the drum armatures of Siemens (Altneck) and Edison, then, if connexions are made with the circuit at two opposite points of the entire combination of coils (say by soldering wires to two opposite segments of the collector), the galvanometer throw will *not* be proportional to A , because in this case the separate turns of the coils are not all horizontal before and after the half-revolution is made. The individual turns, indeed, generate currents in proportion to the sine of the angle through which they are turned. And as they all turn through 180° , the effect will be proportional to the average value of the sine between 0° and 180° , namely to $\frac{2}{\pi}$, and further, as there are two paths through the two halves of the windings from brush to brush, the induced electromotive-force will be but half of what it would be if there were only one path; that is to say, A will really be twice the value that we obtain by getting the electromotive-force due to two sets of coils united in parallel, as they are in these armatures. The throw will, in fact, be proportional to $\frac{2}{\pi} A$, not to A ; and the value as deduced by the rule-of-four calculation will therefore require to be multiplied by $\frac{\pi}{2}$ to give the true value of A .

Note.—When a dynamo is doing full work and a strong current is being generated in its armature coils, the "equivalent area" is no longer exactly of the same value as when the armature is standing still, for, as we have seen, the symbol A includes a factor κ , representing the multiplying effect of the iron core. But iron cores, when the magnetising current round them is strong, tend to get saturated, and then their multi-

plying effect is diminished. When in full work, the equivalent area A' will be more nearly represented as $A' = \frac{A}{1 + \beta i}$, where i is the strength of the current running in the armature coil, and β a small (fractional) constant depending on the saturation of the iron of the core. A hot core also has a less magnetic permeability than a cool one. Armatures when heated act as if they were of a smaller size: their "equivalent area" is less than when cold.

We might proceed to consider the more complicated forms of armatures. Those of the "ring" type are in general easier to construct than those of the "drum" type: but the calculations for the latter are more simple. Hence we take them first. But in order to understand the real advantage of the more complicated forms, it will be well to understand the nature of the fluctuations of the electromotive-force for which we have found only the average value.

Fluctuations of Electromotive-force in a One-coil Armature.

As previously explained, the actual induced electromotive-force is proportional to the sine of the angle through which the coil has turned, or

$$E = \omega H A \sin \theta.$$

As θ increases from 0° to 360° , the value of the sine goes from 0 to 1, then from 1 to 0, from 0 to -1 and from -1 back to 0.

FIG. 214.

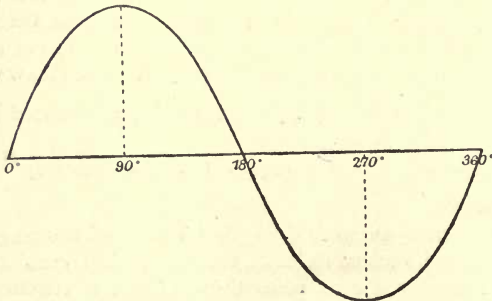

The values of the sine are depicted in Fig. 214. The same curve may serve then to show how the electromotive-force

would fluctuate if there were no commutator. But the action of the commutator is to commute the negative inductions into positive ones: the brushes being so arranged as to slide from one part of the commutator to the other at the moment when the inverse induction begins. This gives the curve the form of Fig. 215, which therefore represents how the current

FIG. 215.

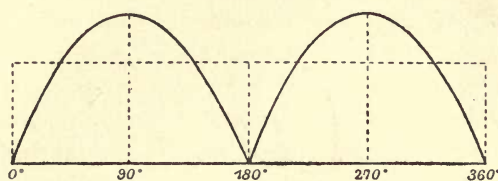

pulsates in the circuit of a simple old-fashioned shuttle-wound Siemens armature. Now if we could level these hills, and change our undulating induction into a steady one, we should get a single straight line, shown in Fig. 215 as a dotted line, enclosing below it a rectangular area equal to the sum of the areas enclosed by the sinuous curves, and therefore at a height which is the average of the heights of all the points along the curves: in fact, since each sinuous curve is part of a curve of sines, the *average* height will be $\frac{2}{\pi}$, or about $\frac{2}{11}$ of the maximum height.

Fluctuations in a Closed-coil Armature divided into Sections.

As shown in the argument on pp. 23 and 24, it is, for reasons of construction, usual to wind armature coils in two sets connected in parallel arc. The two halves of the Pacinotti ring, the two halves of the windings on the Siemens drum, meet at the brushes in parallel arc. If each of the two coils consisted of 100 turns, their joint effect in inducing electromotive-force will be no greater than that of either of them separately, but the internal resistance of the armature will be halved. From this point onwards in the argument it will be assumed that the armature windings consist of *pairs* of coils.

Thus, instead of one coil of 200 turns as shown in Fig. 216, we shall take it that there is a pair of coils each of 100 turns as in Fig. 217.

Now suppose that, in order to get a less fluctuating effect, we divide each of our original single pair of coils into two parts, and set these at right angles to one another. To take a numerical case, suppose there were originally 100 turns in

FIG. 216.

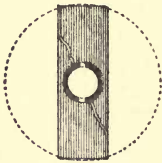

FIG. 217.

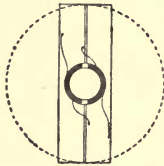
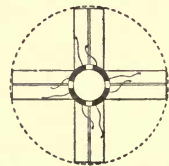
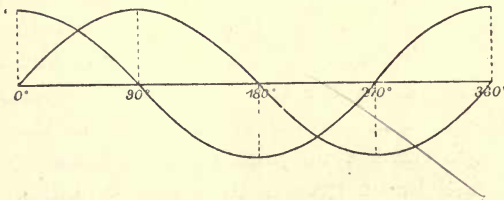

FIG. 218.



each coil and we split each into two coils of fifty turns, but set them across one another so that one comes into the best position in the field as the other is going out of it. (This arrangement is indicated in Fig. 218 which may be contrasted with Fig. 217 representing the undivided coil.) In this case we shall have two sets of overlapping curves—each of them will have to be but half as high as before because the equivalent area of each coil is only half what it was for the whole coil. Then, if there were no commutator, the induced electromotive-force in the two sets of coils would fluctuate as shown by the two curves of Fig. 219. But if the ends of the two “sections”

FIG. 219.



of the coil are joined to a proper commutator or collector, all the “inverse” inductions will be commuted into “direct” ones by the sliding of the brushes at the right moment, and

the two curves would then become as in Fig. 220. The next process is to ascertain what the joint result of these overlapping electromotive-forces will be : it is evident that

FIG. 220.

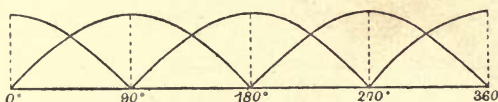

from 0° and 90° the two inductive actions are assisting one another, and that at 45° they are equal. The nett result here is therefore double either of them ; and, in fact, the curve representing the *sum* of the two curves is given in Fig. 221. This curve shows at once a step towards *conti-*

FIG. 221.

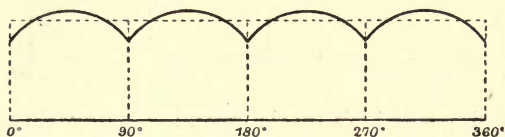

nunity, as the fluctuations are far less than those of the single coil, Fig. 215. If, as before, we level the undulating tops by a dotted line, we get precisely the same height as before. The *total* amount of induction (the total number of lines of force cut) is the same, and the *average* electromotive-force is the same. There is no gain, then, in the total electric work resulting from rearranging the armature coils in two sets at right angles to each other : but there is a real gain in the greater continuity and smoothness of the current.

If we again split our coils and arrange them as shown in Fig. 222 at angles of 45° , in four sets of pairs of coils of twenty-five turns each, and connect them up to a proper commutator, we shall get an effect which is very easily represented by constructing two curves, each similar to the

FIG. 222.

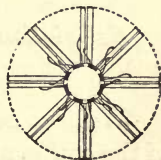

last but each of half the height, and compounding them together (Fig. 223). One of them will of course have the maximum heights of crests occurring 45° further along than

FIG. 223.

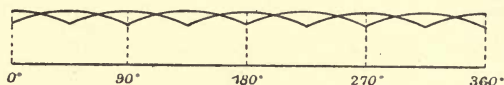

those of the other curve; and when these are compounded together we get for a resultant a curve shown in Fig. 224, which has exactly the same *average* height as before, but which has still less of fluctuation. It is easily conceived that this process

FIG. 224.

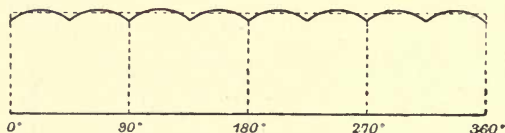

of dividing the coil into sections, and spacing these sections out at equal angles symmetrically, would give us a result approaching as near as we choose to an absolutely continuous one. If our original pair of coils of 100 turns each were split into twenty sets of pairs of five turns each, or even into ten sets of pairs of ten turns each, the approach to continuity would be very nearly truly attained. It only remains to calculate the continuity algebraically; which, though not difficult, is rather tedious.

Calculation of Fluctuations of the Electromotive-force in Closed-coil Armatures.

We have seen in Chap. III. that in every armature a section of the coil connected with any two commutator-bars is undergoing at every instant an inductive effect exactly similar, but opposite in sign, to that going on in the section connected with the two bars on the side of the commutator diametrically

opposite. We likened the two sets of coils in the two halves of the armature to two sets of galvanic cells arranged in parallel. Suppose the armature had in all thirty-six sections, then in reality there are two sets of eighteen, and the electromotive-force induced in each set is alike. Let the symbol c stand for the total number of sections of coils in the armature. There will be therefore $\frac{c}{2}$ sections in each half of the armature from brush to brush. Let each section consist of b turns of wire. The whole armature will consist of bc turns. If these c sections are set symmetrically round, the angle between the plane of each section and the next one to it will be $\frac{360}{c}$ degrees or $\frac{2\pi}{c}$ radians. This may for some purposes be written $\frac{\pi}{\frac{1}{2}c}$; and for shortness we will call this angle $= \beta$. We will then calculate the total electromotive-force induced in one set of sections, that is to say in one of the rows of $\frac{1}{2}c$ sections of coils extending half round the armature and commutator from one brush to the other. Referring to equation [I.] we see that in the first section, when it has turned through angle θ , the induced electromotive-force e_1 will be

$$e_1 = \omega H A_1 b \sin \theta,$$

where ω is the angular velocity, H the intensity of the field, and A_1 the equivalent area of one turn of the coil. In the second section the electromotive-force will be

$$e_2 = \omega H A_1 b \sin (\theta + \beta),$$

because this section has a position differing by an angle β from the first section. In the third section we have similarly

$$e_3 = \omega H A_1 b \sin (\theta + 2\beta);$$

and so on, until we come to the last section of the set, for which the electromotive-force will be

$$e_{\frac{1}{2}c} = \omega H A_1 b \sin (\theta + \overline{\frac{1}{2}c - 1} \beta).$$

But the whole electromotive-force of the set is the sum of all these separate electromotive-forces ; so we have

$$E = \omega H A_1 b \times$$

$$\left\{ \sin \theta + \sin (\theta + \beta) + \sin (\theta + 2\beta) + \dots \dots \dots \sin (\theta + \overline{\frac{1}{2}c - 1} \beta) \right\}.$$

We can get, however, no information with respect to the maximum and minimum values of this fluctuating electromotive-force as long as the expression for E is in the form of a long series of values. This series within the brackets we must proceed to sum. Call its sum S. Then, in order to get its separate terms added together, we will multiply each by $2 \sin \frac{\beta}{2}$; so that

$$\sin \theta \quad \times 2 \sin \frac{\beta}{2} = \cos \left(\theta - \frac{\beta}{2} \right) \quad - \cos \left(\theta + \frac{\beta}{2} \right),$$

$$\sin (\theta + \beta) \times 2 \sin \frac{\beta}{2} = \cos \left(\theta + \frac{\beta}{2} \right) \quad - \cos \left(\theta + 3 \frac{\beta}{2} \right),$$

$$\sin (\theta + 2\beta) \times 2 \sin \frac{\beta}{2} = \cos \left(\theta + 3 \frac{\beta}{2} \right) - \cos \left(\theta + 5 \frac{\beta}{2} \right),$$

&c.

&c.

&c.

$$\sin (\theta + \overline{\frac{1}{2}c - 1} \beta) \times 2 \sin \frac{\beta}{2} = \dots \dots \dots - \cos \left(\theta + \overline{\frac{1}{2}c - 1} \beta + \frac{\beta}{2} \right).$$

It will be noticed that on adding up the terms on the right-hand side they cancel out in pairs, leaving only the first and last, thus—

$$S \times 2 \sin \frac{\beta}{2} = \cos \left(\theta - \frac{\beta}{2} \right) - \cos \left(\theta + \overline{\frac{1}{2}c - 1} \beta + \frac{\beta}{2} \right).$$

But $\frac{1}{2} c \beta = \pi$, and $\overline{\frac{1}{2}c - 1} \beta = \pi - \beta$; and therefore the last term may be written $-\cos \left(\theta + \pi - \frac{\beta}{2} \right)$, which is same as $+\cos \left(\theta - \frac{\beta}{2} \right)$.

Then the expression becomes

$$S \times 2 \sin \frac{\beta}{2} = 2 \cos \left(\theta - \frac{\beta}{2} \right)$$

and

$$S = \frac{\cos \left(\theta - \frac{\beta}{2} \right)}{\sin \frac{\beta}{2}}.$$

Inserting this value, we get at once

$$E = \omega H A b \frac{\cos \left(\frac{\beta}{2} - \theta \right)}{\sin \frac{\beta}{2}}.$$

The amount of fluctuation implied in this formula depends on how the brushes are set. They slide, of course, from one bar of the commutator to another while the commutator moves through the angle β . So, if $\theta = 0$ at the beginning, when the commutator-bar is just beginning to touch the brush, then $\theta = \beta$ just as the bar leaves contact with the brush. And when the brush touches the middle of the bar $\theta = \frac{\beta}{2}$. Now the cosine is a maximum when the angle is a minimum. Therefore E will be a maximum when $\frac{\beta}{2} = \theta$, i.e. when $\frac{\beta}{2} - \theta = 0$: and E will be a minimum when either $\theta = 0$, or $\theta = \beta$. We have, consequently, the following results as the bar of the commutator passes under the brush:—

(1.) At beginning ($\theta = 0$),

$$\begin{aligned} E \text{ (a minimum)} \dots &= \omega H A b \frac{\cos \frac{\beta}{2}}{\sin \frac{\beta}{2}} \\ &= \omega H A b \cotan \frac{90^\circ}{\frac{1}{2}\beta} \end{aligned}$$

(2.) At middle of bar ($\theta = \frac{\beta}{2}$),

$$\begin{aligned} E \text{ (a maximum)} \quad \dots &= \omega H A b \frac{1}{\sin \frac{\beta}{2}} \\ &= \omega H A b \operatorname{cosec} \frac{90^\circ}{\frac{1}{2}c}. \end{aligned}$$

(3.) At end ($\theta = \beta$),

$$\begin{aligned} E \text{ (again a minimum)} &= \omega H A_1 b \frac{\cos \frac{\beta}{2}}{\sin \frac{\beta}{2}} \\ &= \omega H A_1 b \cotan \frac{90^\circ}{\frac{1}{2}c}. \end{aligned}$$

The greatest fluctuation therefore that can occur, will be the difference between $\operatorname{cosec} \frac{90^\circ}{\frac{1}{2}c}$ and $\cotan \frac{90^\circ}{\frac{1}{2}c}$; and, since each bar as it passes under the brushes comes into the position just occupied by the bar preceding it, there will be as many fluctuations in every revolution as there are bars in the commutator or sections in the armature, namely c . Further than this, if we could increase the number of sections indefinitely, so that $\frac{90^\circ}{\frac{1}{2}c}$ or $\frac{\beta}{2}$ was practically = 0° , then both $\operatorname{cosec} \frac{90^\circ}{\frac{1}{2}c}$, and $\cotan \frac{90^\circ}{\frac{1}{2}c}$ would be equal, and would be equal to $\frac{c}{\pi}$; for $\frac{90^\circ}{\frac{1}{2}c} = \frac{\pi}{c}$, and for small angles the arc is sensibly equal to either the sine or the tangent. We will, however, calculate the actual amount of fluctuation in certain cases. Many dynamos are built with armatures having a 36-part collector, and thirty-six sections in the armature coil. We want to know the fluctuations in this case, and in other cases with fewer or more segments. The following table gives the results of the calculations; the number of sections of the armature and commutator being given in the first column,

and their angular breadth in the second. The fluctuation is the difference between columns 3 and 4 :—

c	β	$\frac{\operatorname{cosec} \frac{\beta}{2}}{c}$	$\frac{\operatorname{cotan} \frac{\beta}{2}}{c}$	The Fluctuation.	Percentage Fluctuation.
2	180°	·5	0·	·5	±50·00
4	90	·3479	·2500	·0979	14·04
10	36	·3236	·3077	·0159	2·38
12	30	·3220	·3110	·0110	1·70
15	24	·3206	·3136	·0070	1·10
20	18	·3196	·3157	·0039	·61
24	15	·3192	·3165	·0027	·42
30	12	·3189	·3171	·0018	·28
36	10	·3187	·3175	·0012	·19
40	9	·3186	·3177	·0009	·14
45	8	·31857	·31780	·00077	·12
60	6	·31846	·31802	·00044	·07
90	4	·31838	·31819	·00019	·03
360	1	·31832	·31830	·00002	·003
5400	0° 4'	·3183099	·3183098	·0000001	·00001

From these figures it is apparent that the fluctuations become practically insignificant when the number of sections is increased ; as indeed the curves of Figs. 148 to 153 showed. With a 20-part commutator the fluctuations of the electromotive-force in the armature are less than 1 per cent. of the whole electromotive-force. With a 36-part commutator, they are less than one-fifth of 1 per cent. So far as mere fluctuations are concerned then, it is practically a useless refinement to employ commutators of more than thirty-six parts. But there are other reasons, as we shall see in considering the self-induction in the separate sections, for making the number of sections as great as possible.

Now, assuming that we wind our coil in a large number of sections, so that the fluctuations may be negligible, what will the total electromotive-force be? We may write, as we have seen, $\frac{c}{\pi}$, for either $\operatorname{cosec} \frac{\beta}{2}$ or for $\operatorname{cotan} \frac{\beta}{2}$, giving us

$E = \frac{2}{\pi} \omega H A_1 b \frac{c}{2}$. Now A_1 was the area of one turn, b the number of turns in a section, and $\frac{1}{2} c$ the number of sections

in half the armature (i. e. from brush to brush). Therefore for $A_1 b \frac{c}{2}$, we may write "A," the area of the "equivalent" coil, so that our formula once more becomes

$$E = \frac{2}{\pi} \omega H A,$$

or

$$E = 4 n H A,$$

as before.

Measurement of Fluctuation.

The relative amount of fluctuation in the current furnished by a dynamo may be observed by noticing the inductive effect on a neighbouring circuit. Let a coil be introduced into the circuit, and let a second coil, wholly disconnected from the first, be laid coaxially with it, so that the coefficient of mutual induction between the coils shall be as great as possible. Introduce into the circuit of the second coil a Bell telephone receiver. If the main-circuit current is steady there will be no sound heard. If it fluctuate, each fluctuation will induce a corresponding secondary current in the telephone circuit, and the amount and frequency of the fluctuations may be estimated by the loudness and pitch of the sound in the telephone. The fluctuations of the current of a Brush dynamo are in this manner readily detected. Professor Ayrton has suggested the introduction into the secondary induction circuit of an electro-dynamometer to serve as a "discontinuity-meter."

CHAPTER XIII.

THE MAGNETO-DYNAMO, OR MAGNETO-ELECTRIC
MACHINE.

IN the equations hitherto considered it was assumed that the armature rotated in a magnetic field the intensity of which was specified by the symbol H , meaning thereby the average number of lines of force per square centimetre in the field. Nothing was specified as to the kind of field magnets: and the general formula deduced is of course applicable for all kinds, provided the value of their magnetic field is known. In magneto-dynamos, in which the field is due to permanent magnets of steel, H depends only on the magnetism of the steel, except when a strong current is being generated in the armature coils: in which case the magnetism due to the current in the coils reacts on the field, and alters its intensity and its direction. If the magnetism of the field magnets were so overpoweringly great, as compared with that of the armature coils, that this reaction were insignificantly small, then, since our fundamental formula is

$$E = 4 n H A,$$

E would, for any given magneto machine, be directly proportional to n , the speed of rotation. But we know in practice that this is not the case. Suppose we turn a magneto machine at 600 revolutions per minute ($n = 10$, for then there will be 10 revolutions per second) and get, say, 17 volts of electromotive-force from it, then, if there were no reactions from the armature, turning it at 1200 revolutions per minute ought to give exactly 34 volts. This is never quite attained; though in many machines, as, for

example, in the laboratory-pattern magneto-Gramme machines made by Breguet (Fig. 86), the direct proportion is very nearly attained even with much higher speeds.

Measurement of the Intensity of Field of a Magneto-dynamo.

To measure H is, in reality, a simple matter. The process is somewhat like that recommended for measuring A , but simpler.

Unmount the armature of the machine, and lay it, with its axle, horizontally, in the magnetic meridian, at some place where the value of the vertical component of the earth's magnetic intensity is known. For most places in Great Britain, the value of the vertical intensity of the field may be taken as 0.43 C.G.S. or "absolute" units,* but the value may be very different indeed if care is not taken to select a place far from all magnets and masses of iron. The armature should be connected with a galvanometer having a slow-beat needle, in the manner described above for the measurement of "A." It should be then suddenly turned through an exact half-revolution, and the throw δ_1 of the galvanometer observed. It should then, while still in connexion with the galvanometer, be replaced in the machine, and set so with respect to the lines of force of the magnetic field of the magnets, that those coils which in the first experiment lay horizontal, now lie across the lines of force of the field, or, in other words, that the armature is similarly situated with respect to the direction of the lines of force of the field in the two cases. On again suddenly turning the armature through a half-revolution, the galvanometer will show a throw δ_2 , greater than before in proportion as the field is more intense. And, calling the vertical component of the earth's magnetic intensity V , we get H , the intensity of the field of the machine, by a simple rule-of-four sum:—

$$\delta_1 : \delta_2 :: V : H.$$

Potential at Terminals of Magneto-dynamo.

The potential at terminals of the magneto machine—and indeed of every dynamo—is, when the machine is doing any work, less than E , the total induced electromotive-force, because part of E is employed in driving the current through the resistance of the armature. The symbol e may be conveniently used for the difference of potential between terminals. If the external circuit be open, so that no current whatever is generated, then only $e = E$. It is convenient to

* This is 0.000000043 of a "gauss," as defined in Note 3, p. 246.

have an expression for e in terms of the other quantities, seeing that when any current is being generated it is impossible to measure E directly by a voltmeter or by an electrometer, whereas e can always be so measured.

Let r_a be the internal resistance of the machine, that is to say the resistance of the armature coils, and of everything else in circuit between the terminals; and let R be the resistance of the external circuit. Then, by Ohm's law, if i be the current,

$$E = i (r_a + R).$$

But by Ohm's law also, if e be the difference of potential between the terminals of the part of the circuit whose resistance is R ,

$$e = i R;$$

whence

$$\frac{e}{E} = \frac{R}{r_a + R}; \quad \text{[III.]}$$

from which we have

$$e = \frac{R}{r_a + R} E,$$

or

$$e = \frac{R}{r_a + R} 4n \text{ H A.} \quad \text{[IV.]}$$

It is also convenient to remember that

$$E = \frac{r_a + R}{R} e; \quad \text{[V.]}$$

for this formula enables us to calculate the value of E from observations made of e with a voltmeter.

Relation between whole Electromotive-force and Difference of Potentials at the Terminals.

The essential distinction pointed out above between the whole electromotive-force E , and that part of it which is

available as a difference of potentials at the terminals e , may be further illustrated by the following geometrical demonstration which is due to Herr Ernst Richter.*

In a machine (such as are chiefly dealt with later) in which e is constant, E will not be constant, except in the unattainable case of a machine which has no internal resistance. Let r represent the internal resistance of the machine, including that of the armature and of any magnet-coils that are in the main circuit ($r = r_a + r_m$); then,

$$E = e + i r.$$

If E is constant, then e cannot be constant when i varies; and if e is constant, E cannot be. We have then two cases to consider.

FIG. 225.

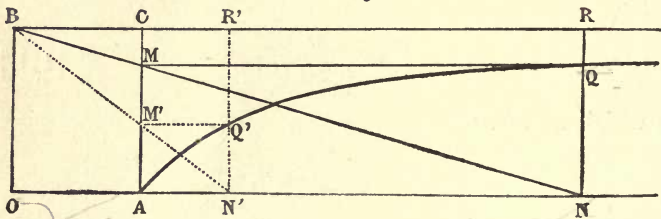

(1) *E constant.* Take resistances as abscissæ and electromotive-forces as ordinates, and plot out (Fig. 225) $OA = r$, $AN = R$, $OB = E$. The line BN represents the fall of potential through the entire circuit. Of the whole electromotive-force OB , a part equal to CM is expended in driving the current through the resistance r , leaving the part AM available as the difference of potentials at the terminals, when the total resistance of the circuit is represented by the length from O to N . Accordingly at N erect a vertical line NQ equal to AM . Take a less external resistance $R' = AN'$, and by a similar process we find that the corresponding value of e is AM' or $N'Q'$. Similarly, any number of points may be determined; they will all lie on the curve AQQ' , which

* *Elektrotechnische Zeitschrift*, iv. p. 161, April 1883.

therefore shows how, as the external resistance is increased, the terminal potential rises, whilst the whole electromotive-force remains constant and is represented by the horizontal line B R. The equation of this curve is given by the condition

$$\frac{E - e}{E} = \frac{r}{R + r}$$

whence $(E - e)(R + r) = E r = \text{constant}$; which equation is the equation of an equilateral hyperbola having O B and O R as asymptotes.

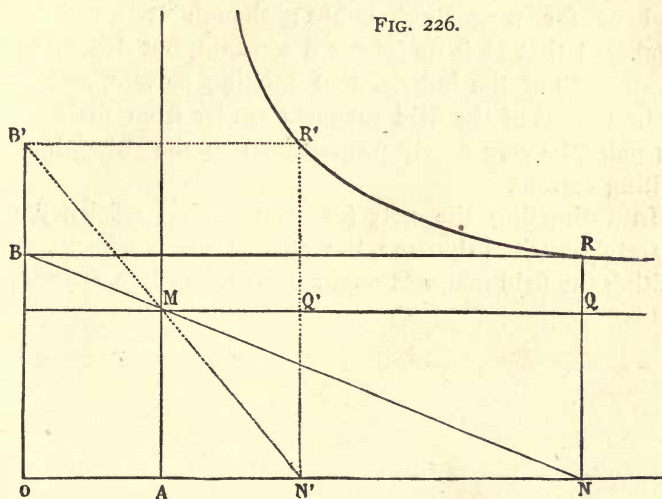

FIG. 226.

(2) *e constant.* As in the preceding case, $O A = r$; $A N = R$; and $A M = e$. From N (Fig. 226) draw the line N M and produce it backwards to B. Then O B represents that value of E which will give e volts at terminals when $R = N M$. Accordingly set off at N the line $N R = O B$. In a precisely similar way draw $N' B'$, to correspond with any other value of R, and make $N' R'$ equal to $O B'$. $N' R'$ represents the value of E when the value of the external resistance R is equal to $A N'$. By determining other values we obtain the successive points of the curve R R', which shows how the whole electromotive-force must vary in order to maintain a

constant difference of potentials at the terminals, as represented by the horizontal line M Q. The equation to this new curve is given by the condition

$$\frac{E - e}{r} = \frac{e}{R}$$

or $(E - e) R = e r = \text{constant}$.

This curve is also an equilateral hyperbola.

The Separately-excited Dynamo.

For separately-excited dynamos the same formulæ hold good as for magneto-dynamos; though it must be remembered that H is no longer a constant, but depends upon the strength of the independent exciting current, and will, if the iron cores of the field magnets are far from their saturation point, be very nearly proportional to the strength of the exciting current.

In estimating the nett (or commercial) efficiency of a separately-excited dynamo, the energy spent per second in exciting the field magnets ought to be taken into account.

CHAPTER XIV.

EFFICIENCY AND ECONOMIC COEFFICIENT OF DYNAMOS.

SUPPOSE that we know the actual mechanical horse-power applied in driving a dynamo. This can be measured directly either by using a "transmission dynamometer," or by taking an indicator diagram from the steam-engine that is driving it, or, in certain special cases where the field magnets can be pivoted or counterpoised, by applying the method originally pursued by the Rev. F. J. Smith, and later described by M. Marcel Deprez and by Professor Brackett, in which the actual mechanical interaction between the armature and field magnets is utilised to measure the horse-power used in driving the machine. If, then, we know the horse-power applied, and if we measure the "activity" of the dynamo, that is to say its rate of giving out electrical energy, or, as some people call it, its output of electrical horse-power, we have by comparing the mechanical power absorbed with the electrical activity developed, a measure of the "efficiency" of the dynamo as an economical converter of mechanical energy into electrical energy. It must, of course, be borne in mind that part of the electrical energy developed is inevitably wasted in the machine itself, in consequence of the unavoidable resistance in the wire of the armature, and, in the case of self-excited dynamos, in the wire of the field-magnet coils. There must, therefore, be drawn a distinction between the gross efficiency of the machine, or as it is sometimes called, its "efficiency of electric conversion," and its nett efficiency, or "useful commercial efficiency."

To express efficiency, whether gross or nett, we must, however, have the means of measuring the electric "activity" of the dynamo, or of any part of its circuit.

As is well known, the energy per second of a current can be expressed, provided two things are known, namely, the number of ampères of current, and the number of volts of potential between the two ends of that part of circuit in which the energy to be measured is being expended. The number of ampères of current is measured by a suitable ampèremeter; the number of volts of potential by a suitable voltmeter. The product of the volts into the ampères expresses the electric energy expended per second in terms of the unit of activity denominated "watts." As 1 horse-power is equal to 746 watts, the number of volt-ampères (i. e. of watts) must be divided by 746 to give the result in horse-power. If i represents the current in ampères, and e the difference of potential in volts, then the "activity" or "electric energy per second," for which we may use the symbol w , may be written

$$w = \frac{ei}{746}.$$

Now we know, in the case of every dynamo, that the electric energy developed usefully in the external circuit is *not* the whole of the electric energy of the machine, part being absorbed (and wasted in heating) in the resistances of the armature and magnet coils. The ratio of the useful electrical energy realised in the external circuit to the total electric energy that is developed is sometimes called, though not very happily, the "electrical efficiency" of the machine. I prefer instead to call this ratio the "economic coefficient" of the machine. It may be expressed algebraically as follows:—If the machine is giving a current of i ampères, and its total electromotive-force be E volts, then its total electric activity will be

$$= E i \text{ watts.}$$

If the electromotive-force between the terminals of the dynamo be e volts, then the useful activity is

$$= e i \text{ watts.}$$

Using the symbol η for the "economic coefficient," or so-called "electrical efficiency," we have

$$\eta = \frac{\text{useful activity}}{\text{total activity}} = \frac{e i}{E i},$$

or,

$$\eta = \frac{e}{E}.$$

But we know that the ratio $\frac{e}{E}$ depends on the relation of the internal and external resistances, for

$$\frac{e}{E} = \frac{R}{r + R} \quad (\text{see equation [III.]},)$$

where R is the resistance of the external circuit, and r the internal resistance (armature, magnets, &c.) of the machine. Hence

$$\eta = \frac{R}{r + R}. \quad \text{[VI.]}$$

Obviously, this coefficient will approach more and more nearly to *unity* the more that the value of r can be diminished. For if a machine could be constructed of *no* internal resistance there would be none of the energy of the current expended in driving the current through the armature and wasted in heating its coils.

We shall see later on how the expression for the economic coefficient η must be modified in the case of series dynamos and shunt dynamos. The above expression suffices both for magneto machines and for separately-excited machines.

Returning now to the real efficiency of the machine, let us use the symbol W for the mechanical work-per-second, or horse-power, actually used in driving the machine. And, remembering that the gross electric activity of the machine is $\frac{E i}{746}$, we have for the *gross efficiency*, or efficiency of electric conversion,

$$\frac{E i}{W \times 746},$$

and for the *nett efficiency*, or useful commercial efficiency,

$$\frac{ei}{W \times 746}$$

It will be seen that, as the first of these expressions contains E , and the second e , the nett efficiency can be obtained from the gross efficiency by multiplying by η , the economic coefficient.

It must be noticed before passing from this topic that since i , the strength of the current, enters into each of the expressions for efficiency as a factor, and as i depends not only on the resistance of the machine itself, but on that of the lamps, or other parts of the system which it is used to feed, it is somewhat misleading to talk of the efficiency of the *dynamo*, as if the efficiency was a property of the dynamo. On the contrary, not only the gross efficiency, but also economic coefficient, and therefore *à fortiori*, the nett efficiency, depend on the external resistance, that is to say on the number of lamps that may happen to be alight! But still there is a sense in which these expressions are justifiable. Every dynamo is designed to furnish a certain quantity of lamps, and therefore to carry a certain average current. Its efficiency and coefficient of economy ought therefore to be expressed in terms of that current (and of that external resistance) which may be considered the fair working load of the machine.

Variation of Economic Coefficient with Current.

It will be noticed that in the case of the series machine considered above, the value of η will be different when R the external resistance is varied. When R is very great compared with r , then the value of η is very nearly = 1; but for small values of R , the value of η diminishes indefinitely. But when R is large the current is small, and when R is small the current is large. It appears, therefore, that a series dynamo has its maximum value for the economic coefficient when it is doing its minimum of work. A curve showing the relation is given in Chapter XX., Fig. 282.

Relation of Size to Efficiency.

Every circumstance which contributes to wasting the energy of the current of a dynamo-electric machine reduces the efficiency of the machine. In the earlier chapters it has been shown what the chief electric sources of waste are, and how they may be avoided. The precautions needful to obviate eddy currents, to avoid reversals of magnetisation, to get rid of needless resistance, to obviate opposing electromotive-forces, have been detailed. Mechanical friction of the moving parts can be minimised also by due mechanical arrangements. But one thing cannot be entirely obviated, because even the best conductors employed have a certain resistance—we cannot prevent the heating of the conducting coils; and the more powerful the current generated by the machine, the more important does this source of waste become. There is but one way to reduce this, and that is by increasing the size of the machines. For some years the author has been the advocate of large dynamo machines, not because he has any admiration for mere bigness, but because, as in steam-engines so in dynamos, the larger machines may be made more efficient than the small, in proportion to their cost. In discussing the relation of size to efficiency, it is assumed for the sake of argument, that the size of any machine can be increased n times in every dimension, and that though the dimensions are increased, the velocity of rotation remains the same, and that the intensity of the magnetic field per square centimetre remains also constant. If the linear dimensions be n times as great in the larger machines as in the smaller, the area it stands on will be increased n^2 times, and its volume and weight n^3 times. The cost will be less than n^3 times but greater than n times. If the same increase of dimensions in the coils be observed (the number of layers and of turns remaining the same as before), there will be in the armature coils a length n times as great, and the area of cross-section of the wire will be n^2 times as great as before. The resistance of these coils will, therefore, be but $\frac{1}{n}$ part of the

original resistance of the smaller machine. If the field-magnet coils are increased similarly, they will offer only $\frac{1}{n}$ of the resistance of those of the smaller machine. Moreover, seeing that while the speed of the machine is the same the area cut through by the rotating coils is increased n^2 times, these coils will in the same time cut n^2 times as many lines of force, or the electromotive-force will be increased n^2 times. Supposing the whole of the circuit to be similarly magnified, its resistance will also be but $\frac{1}{n}$ of the previous value.

If the machine is a "series-wound" dynamo, an electromotive-force, n^2 , working through $\frac{1}{n}$ resistance will give a current n^3 times as great as before. Such a current will, as a matter of fact, much more than suffice to bring up the magnetic field to the required strength, viz. n^2 times the area of surface magnetised to the same average intensity per square centimetre, as stipulated; for the mass of iron being n^3 times as great, it need not be so much saturated as before to give the required field. Here an economy may be effected, therefore, by further reducing the number of coils, and therefore the wasteful resistance of the field-magnet coils, in the proportion of n^2 to n^3 , or to $\frac{1}{n}$, of its already diminished value. Even if this were not done, by the formula for the economic coefficient of a "series" dynamo, the waste, when working through a constant external resistance, will be n -fold less than with the smaller machine. Now, if the current be increased n^3 times, and the electromotive-force n^2 times, the total electric work which is the product of these will be n^5 times greater than in the small machine, and it will consume n^5 times as much power to drive it.* It is clearly an important economy if a machine

* This calculation agrees with the result deduced on entirely different principles by M. Marcel Deprez. M. Deprez considers the mutual reaction, dF , between two elements, ds and ds' , of a system of conductors, which, by Ampère's principle, is

$$dF = C^2 \frac{ds ds'}{r^2} f(a),$$

costing less than n^3 times as much, will do n^5 times as much work (to say nothing of the increased ratio of economy). A machine doubled in all its linear dimensions will not cost eight times as much, and theoretically should be electrically thirty-two times as powerful a machine. In practice this is not attainable, because as the iron has to be magnetised from outside, the larger masses of iron in the larger machines require more electric energy in proportion to magnetise them to an equal degree. It may be taken as a rule that the working power is nearly proportional to the weight of the machine, being rather more than n^3 for a machine of n times the linear dimensions.

Suppose the machine to be "shunt" wound, then to produce the field of force of n^2 times as many square centimetres area, will require (if the electromotive-force be n^2 times as great) that the absolute strength of the current remain the same as before in the field-magnet coils. This can be done by using the same sized wire as before, and increasing its length n^2 times, to allow for n times as many turns, of n times as great a diameter each, in the same number of layers of coils as before. In this case the work done in the shunt being equal

where C is the current, r the distance of the elements apart, and $f(a)$ a certain function of the machine, independent of its size. Writing a for the area, we have

$$\begin{aligned} dF &= \frac{C^2}{a^2} \cdot \frac{a ds \cdot a ds'}{r^2} \cdot f(a), \\ &= \frac{C^2}{a^2} \cdot \frac{dv \cdot dv'}{r^2} \cdot f(a), \end{aligned}$$

which, if the linear dimensions be increased n times, becomes

$$\begin{aligned} dF' &= \frac{C^2}{a^2} \cdot \frac{n^3 dv \cdot n^3 dv'}{n^2 r^2} \cdot f(a), \\ &= n^4 dF, \end{aligned}$$

whence, since this is true for all elements of the circuits, $\frac{F'}{F} = n^4$, which is Deprez's so-called "law of similars," which asserts that for similar machines the "statical effort" increases as the fourth power of the linear dimensions. But work $W = F \times$ distance, and, in the similar machine whose dimensions are increased n times, the available distance through which the force F' can act is also n times greater. Hence $\frac{W'}{W} = n^5$, as above.

to the product of the n^2 -fold electromotive-force into the unaltered current will be only n^2 times as great, while the whole work of the machine is augmented n^5 times. Now if, while augmenting the total work n^5 times, we have increased the waste work, not to n^5 times but only n^2 times, it is clear that the ratio of waste to the total effect is diminished n^3 -fold. There is, therefore, every reason to construct large machines, from the advantage of economy both in relative prime cost and relative efficiency.

Being desirous of testing the correctness of the deduction that the working capacity of a machine of n -fold linear dimensions is n^5 times as great, the author constructed a little instrument, of which a drawing is given in Fig. 227. In this instrument there are two pairs of coils, that on the left being

FIG. 227.

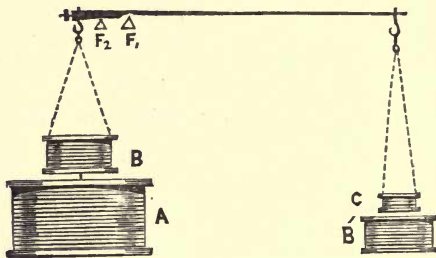

S. P. THOMPSON'S EXPERIMENTAL APPARATUS.

in every way the counterpart of that on the right, but of double linear dimensions. When all four coils were traversed by the same current, the point of equilibrium was $\frac{1}{17}$ of the length of the beam from the extremity; or the attraction of the larger system was sixteen times that of the smaller. Now, it is clear that the larger force can be exerted through double the distance, or that the work-power is 32-fold, and 32 is 2^5 , as theory requires. After the author had constructed his apparatus, he learned that M. Marcel Deprez had made a very similar arrangement, but without the beam, to prove that the statical forces of similar machines are (see footnote *ante*) proportional to the fourth power of the linear dimensions.

M. Deprez's instrument consisted of a modified Joule's current-wreigher, having a coil suspended from a balance, and acted upon by two others, placed axially above and below it (see Fig. 228). The force was measured by directly balancing

FIG. 228.

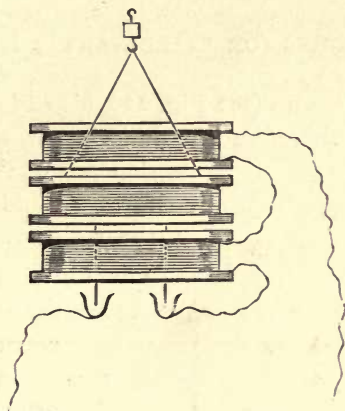

MARCEL DEPREZ'S APPARATUS.

it against weights. Two such arrangements were made, one double the size of the other, and when equal currents were sent through them, M. Deprez found the forces to be as 5·600 to 0·355 kilos., or almost exactly 16 to 1. In these experimental pieces of apparatus there is no iron, and the presence of iron in our dynamos prevents the theoretical law of the fifth power from being realised, moreover large machines cannot be run at so high a speed as small machines. Working with iron that is practically saturated, the magnetic moments are for practical purposes proportional to the masses. In practice a dynamo to yield an output of 20,000 watts must be almost exactly twice as heavy as a similarly-built machine that yields 10,000 watts.

CHAPTER XV.

THE SERIES (OR "ORDINARY") DYNAMO.

IN the series dynamo (see Fig. 229, also Fig. 1), there is but one circuit, and therefore but one current, whose strength i depends on the electromotive force E and on the sum of the resistances in the circuit.

FIG. 229.

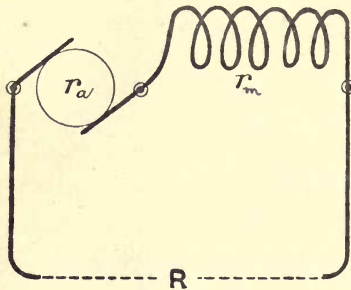

These are :—

R = the external (variable) resistance.

r_a = the resistance of the armature.

r_m = the resistance of the field-magnet coils.

By Ohm's law—

$$E = (R + r_a + r_m) i.$$

Also e , the difference of potential between the terminals of the machine, is

$$e = R i.$$

It is also convenient to find an expression for the difference of potential between the brushes of the machine; the volts measured here being greater than e , because of the resistance of the field magnets; and less than E , because of the resistance of the armature coils. For this difference of potential between brushes we will use the symbol ϵ . Then, by Ohm's law, remembering that the current running through r_m and R is of strength i , we have

$$\epsilon = (R + r_m) i;$$

whence, also,

$$e = E - (r_a + r_m) i.$$

Equations of Series Dynamo deduced from the law of Saturation.

We have the fundamental equation (see p. 244),

$$E = 4 n A H.$$

But H is itself a function of the strength of the current, and therefore depends on E , on the sum of the resistances ($R + r_a + r_m$), and on the quantity and quality of the iron cores of the field magnets, as to whether they are saturated or not saturated with magnetism, and also on the geometrical form and size of the field magnets, and of their coils and pole-pieces. It also depends, though in a secondary sense, upon the magnetism in the armature, and upon the effect which the armature's magnetism has in changing the direction of the united field, and upon the resultant "lead" given to the brushes. At present we are content with a first approximation, in which these secondary matters are temporarily omitted. The equations still remain true, only requiring, when the secondary matters are to be taken into account, a somewhat less simple interpretation of the symbols.

We have, then, to find an expression for H the field, in terms of i the current which excites the field, and of the geometric and magnetic coefficients of the field magnets. We know that for an electro-magnet of given form *when not magnetised to near saturation*, the strength of the field is very nearly proportional to the magnetising current, and to the number of turns in the coil. We know also that because the electro-magnet gets saturated, the strength of the field is for very strong currents nearly a constant. Formulæ in which a saturation term is introduced have been suggested by Robinson, Frölich, and others. If we take the form suggested by Frölich for effective magnetism namely, $M = \frac{a i}{1 + s i}$, where a is a certain constant of magnetisation, and s a small fractional constant depending on the saturation of the core, we shall find it adequate in its general form for our purpose, though it will require developing for the case in point. In fact we will

insert terms which express the additional matters to be taken into consideration. Let S be the number of turns in the coils of the field magnets; then $S i$ will represent the number of ampère-turns, or, in other words, the magnetising power of the current in the coil. The magnetism evoked by the magnetising power depends on the magnetic permeability of the iron of the core, and on its area, &c. Call the magnetic permeability (or "coefficient of magnetic induction") κ , as usual. Now κ is not a constant: it has a certain value to start with, but grows less and less as the magnet gets saturated, and finally becomes reduced to unity. Its effective value is best expressed by introducing a saturation-factor in the following way; divide it by a term which consists of unity + the ampère-turns multiplied by a saturation constant which we will

call σ , and which is a small fraction.* This gives us $\frac{\kappa}{1 + \sigma S i}$ instead of simply κ , as the effective factor of magnetic permeability. We have further to introduce another constant, which we will call G , which is a purely geometrical quantity,† and depends only on the area of cross-section of the core and of the coils, on the length and form of the magnets, and of their pole-pieces. Putting all these things together we therefore get

$$H = G S i \frac{\kappa}{1 + \sigma S i},$$

which gives us for the primary equation for the series dynamo

$$E = 4 n A G S i \frac{\kappa}{1 + \sigma S i}. \quad [\text{VII.}]$$

Now as i is itself a function of E , we must expand and rearrange the equation, and so get

$$E \left(1 + \sigma S \frac{E}{R + r_a + r_m} \right) = 4 n A G \kappa S \frac{E}{R + r_a + r_m};$$

$$\sigma S \frac{E}{R + r_a + r_m} = \frac{4 n A G \kappa S}{R + r_a + r_m} - 1;$$

* See Note, on p. 284, on the saturation coefficient.

† See Note, on p. 286, on the coefficient "G."

whence

$$E = \frac{R + r_a + r_m}{\sigma} \left\{ \frac{4nAG\kappa}{R + r_a + r_m} - \frac{1}{S} \right\}, \quad [\text{VIII.}]$$

which may also be written :—

$$E = \frac{1}{\sigma} \left\{ 4nAG\kappa - \frac{R + r_a + r_m}{S} \right\}. \quad [\text{VIIIa.}]$$

Further, from the values of e and ϵ deduced previously in terms of E , we have

$$\epsilon = \frac{R + r_m}{\sigma} \left\{ \frac{4nAG\kappa}{R + r_a + r_m} - \frac{1}{S} \right\}, \quad [\text{IX.}]$$

and

$$e = \frac{R}{\sigma} \left\{ \frac{4nAG\kappa}{R + r_a + r_m} - \frac{1}{S} \right\}. \quad [\text{X.}]$$

Equation of Current of Series Dynamo.

It is useful to add an expression for the current. Since

$$i = \frac{e}{R} = \frac{E}{R + r_a + r_m}, \text{ we get at once}$$

$$i = \frac{1}{\sigma} \left\{ \frac{4nAG\kappa}{R + r_a + r_m} - \frac{1}{S} \right\}. \quad [\text{XI.}]$$

It follows that either current or electromotive-force can be deduced at once from a knowledge of the constants $A, G, \kappa, S, \sigma, r_a,$ and r_m for any given values of the variables n and R .

Determination of the Constants of the Series Dynamo.

S , the number of turns in the electro-magnet coil should be marked by the maker on the machine, or can be estimated subsequently.

r_a and r_m are resistances which may be tested by the ordinary Wheatstone's bridge method, or by determining the drop of potential between the ends of either of them when traversed by a current of known strength ; for by Ohm's

law, the volts divided by the ampères in the conductor give the resistance in ohms.

- A, the armature constant or area of the equivalent coil can be determined by the method described on p. 248 preceding.
- κ , the magnetic permeability, and σ , the saturation constant, may be determined by the process explained on p. 286.
- G, the geometric constant of the field magnets, may be determined alone, provided κ is known. Or the product $G\kappa$ may be determined together. $G\kappa$ is the same thing as H for one ampère-turn, because that one ampère-turn of magnetising current does not magnetise the magnet anywhere near saturation. For $H = \frac{G\kappa S i}{1 + \sigma S i}$, and therefore for one ampère-turn $H = G\kappa \div (1 + \sigma)$. Now σ is a very small fraction, and may therefore be neglected for such very small magnetising powers as one ampère-turn. Therefore, to ascertain $G\kappa$, send a *very* feeble current round the field magnets, and measure the H thereby set up, by the process described on p. 262. Divide this value of H by the ampère-turns of the feeble magnetising current, and one gets $G\kappa$. Probably a better way in practice to determine $G\kappa$ is to determine all the other constants except G and κ . Then determine either i or e for some value of the current, and calculate $G\kappa$ from the complete equation. As a matter of fact G and κ are never required separately: they may be as well determined together.

Economic Coefficient of Series Dynamo.

From Joule's law of energy of current it follows that the economic coefficient η , which is the ratio of the useful electric energy available in the external circuit to the total electric energy developed, will be

$$\eta = \frac{\text{useful work}}{\text{total work}} = \frac{i^2 R t}{i^2 (R + r_a + r_m) t} = \frac{e}{E},$$

or

$$\eta = \frac{R}{R + r_a + r_m}. \quad [\text{XII.}]$$

This is obviously a maximum when r_a and r_m are *both* very small. Sir W. Thomson recommends that r_m be made a little smaller than r_a . A good proportion is two-thirds.

As an example, the following is taken from the tests made at Munich on a Bürgin-Crompton dynamo of which the economic coefficient varied with the different external resistances from 62.5 to 70.8 per cent.:— $r_a = 2.14$ ohms, $r_m = 1.78$. Here the magnet resistance was about five-sixths of that of the armature.

Experimental Determination, how to Wind Field-magnet Coils.

Suppose a dynamo to have been constructed, and that the armature is already wound, and that the only thing required to be done is the winding of the field magnets. The question to be determined is, how many turns of wire must be put upon the field magnets in order that, with a given speed of driving, and with a given external resistance (for example, a certain number of incandescent lamps), the electromotive-force shall come up to the proper number of volts. A good method is the following, but it requires the employment of some powerful external source of current—say a few good accumulators, or another dynamo. Wind *temporarily* upon the field-magnet cores some coils of wire. The number of turns in this experiment must be accurately counted; but they may be fewer than the machine will ultimately require. Separately excite the magnets through these temporary coils, by means of the accumulators, and introduce into the exciting circuit, an ampère-meter and a suitable variable resistance. Connect to the brushes of the machine resistance wires to represent the lamps, using of course enough wire to bring up the resistance of the circuit to the given value. Drive the armature at the exact given speed at which it is ultimately to be worked. Then turn on the exciting current and gradually increase it until the electromotive-force of the dynamo comes up to the required amount. The number of ampères of the exciting current multiplied by the number of turns in the temporary coils will give *exactly* the requisite number of ampère-turns needed to bring up the cores of the magnets to the requisite degree of magnetisation. Then, from this one experiment, the proper final number of coils can be calculated as follows. The number of ampères of current that are to be supplied to the lamps is known. Divide the number of ampère-turns just found by the number of ampères that the machine is to generate, and the quotient will give the number of turns that must be wound on in the permanent coils. It only remains to determine the gauge of wire to be used. It is a useful rule to remember that the resistance of the field-magnet coils of a series dynamo should be a little less than that of the armature, say two-thirds as great. Then measure the circumference of the field-magnet cores and reckon the average length of one turn of wire

round the core : call this λ . We know that there are to be S turns, each of length λ . The total length of wire is to be $S\lambda$, and its resistance is to be only $\frac{2}{3}r_a$, that is to say it must be a wire of such a gauge that the

$$\text{Resistance per unit of length} = \frac{2r_a}{3S\lambda}.$$

If λ is expressed in feet, then reference to a table of wire gauges (such as all the manufacturers of electric wires supply), in which the resistance per foot of the different gauges is given, will at once show what gauge will give the requisite resistance.

No account has here been taken of the very important fact, that if there are several layers of wire on the magnets, the outer coils are longer (and therefore offer more resistance per turn) and do not magnetise quite so strongly as those that are nearer the core. In such a case the number of turns will have to exceed the number as calculated from the assumption that all the turns have equal magnetising power. Experience will show how to take the average λ so as to give the result as nearly right as possible.

Before leaving this matter it may be pointed out that there is a very important relation between the available electromotive-force e and the number of turns S in the magnet coils. Were there no saturation limit coming in, e would be directly proportional to S , provided S could be increased without altering r_m . But even when the saturation factor is taken into account, and even also when, by putting on more turns upon the magnet, S and r_m are both increased, there is still a gain in the value of e . For it will be seen, by examining equation No. [X.], that if S and r_m were both doubled in value, the second term would be diminished more than the first term, and therefore the value of e would be increased. Any large increase in r_m would however bring down the economic coefficient of the machine.

Importance of the Saturation Coefficient.

The saturation coefficient σ is of immense importance, inasmuch as it is this chiefly which determines how high the electromotive-force of a dynamo with given number of coils, &c., shall rise when the resistances and the speed are given. A reference to the equations of electromotive-force, Nos. [VIII.], [IX.], and [X.], on p. 279, will show that the smaller the σ is, the larger will the electromotive-force be, other things being equal. It is, therefore, of enormous importance not only to build the dynamo of such a form that G shall be large, and of iron so soft that κ shall be large; but to put into it *so much iron* that the saturation coefficient shall be very small: in other words so much iron that it will require

an immense number of ampère-turns to saturate it with magnetism.

Consider what would occur were there no saturation coefficient at all. Suppose the explanation that used to be given fifteen years ago of the action of dynamos, then newly discovered, were true; viz. that the reaction between the field magnet and the armature coils went on at a compound interest rate, the magnet causing the current, the current exalting the magnetism of the magnet, the powerful magnet making the current still more powerful, and so forth. Clearly if no law of saturation were to come in, every dynamo ought, at any given speed of rotation, to show an electromotive-force increasing without limit from zero up to infinity. Again, leave out the saturation term from the primary equation [VII.] on p. 278; it becomes $E = 4 n A G \kappa S i$, which may also be written

$$E = \frac{4 n A G \kappa S E}{R + r_a + r_m},$$

an equation in which the value of E is indeterminate, for it would still hold as an equation if E had any value whatever between $+\infty$ and $-\infty$; which is absurd. Also, we know from experience that in a dynamo constructed without any iron at all, with air spaces within the coils, so that $\kappa = 1$ (so that there is no magnetic saturation at all), the electromotive-force does not rise as high as it would in the very same dynamo if provided with iron. In fact other opposing reactions, the self-inductions in the sections of the armature, the shifting of the resultant field, the greater relative importance of friction, the heating of the resistances, &c., come in and determine a practical limit to the rise of the electromotive-force. Indeed the latter fact alone—the heating of the wires—introduces practically a new saturation term; since the resistance to be taken as a divisor in the equation is not $R + r_a + r_m$, but $(R + r_a + r_m) \times (1 + a\theta)$, where a is the coefficient of increase of resistance per degree of temperature, and θ the temperature to which the wire is warmed by the current, a quantity which is itself a function, not of the cur-

rent but of its square, and therefore a term whose importance increases enormously when the current increases to high values. Experience dictates the use of iron, in spite of the limit to its magnetisation when saturated, simply because to obtain the magnetic field of requisite intensity with iron involves a less expenditure of electric energy in the magnetising coils than if no iron were used. Were no iron used we must have either more turns, or more ampères, or both, in the magnetising coils, and therefore spend more of the energy of the dynamo in exciting itself. Consequently it is of great economic importance to choose an iron for which κ has a high value, to shape it so that G is as high as possible, and further to have so much of it that the saturation coefficient σ is *small*.

NOTE ON THE SATURATION-COEFFICIENT " σ ."

We have found it convenient to represent the degree of magnetisation of the field of an electro-magnet by a modification of Frölich's formula, which we write (p. 278)—

$$H = G S i \frac{\kappa}{1 + \sigma S i},$$

where the term $1 + \sigma S i$, which we call the "saturation term," is put in to express the falling away from proportionality, which appears for the higher values of i , between i and H . If no such falling away occurred; if the iron did not get "saturated," then the equation would simply have been

$$H = G \kappa' S i,$$

where κ' is the coefficient of magnetic permeability throughout. Now, properly speaking, a saturation term cannot be applied to either G , S , or i , for none of these is diminished in value as the iron approaches saturation. Then, the saturation term must belong to κ' only. In fact, if κ' be not a constant, but be represented by the function,

$$\kappa' = \frac{\kappa_0}{1 + \sigma S i},$$

where κ_0 stands for the initial value of κ , when the iron is entirely unsaturated, then the simpler form of expression for H might be still kept, and the complex value of κ inserted. But if we use the saturation term, we must return to the first equation.

The coefficient σ , or "saturation coefficient," plays so important a part in the equations of all dynamos that some further explanation of its meaning is advisable. Examination shows that σ , which is always a small fraction, is the reciprocal of a certain particular number of ampère-turns. If

the original permeability of the iron be κ_0 , then as the iron gets more and more magnetised, its susceptibility to magnetisation decreases, until when $S i$ is very great $\kappa = 1$. There will then be one particular degree of magnetisation at which the permeability is only one-half of its initial value. Let the number of ampère-turns that will bring it to this condition be called $(S i)'$. Then it follows that

$$\frac{\kappa_0}{2} = \frac{\kappa_0}{1 + \sigma (S i)'},$$

whence

$$2 = 1 + \sigma (S i)';$$

and

$$\sigma (S i)' = 1,$$

whence finally

$$\sigma = \frac{1}{(S i)'},$$

or the saturation coefficient is the reciprocal of that number of ampère-turns that will bring the magnet up to such a degree of saturation that its permeability is halved. The matter may be graphically represented

as in Fig. 230. Let ampère-turns be plotted out horizontally, and let either the magnetic moment or the intensity of the magnetisation be plotted vertically. Then the curve of magnetisation rises at first nearly straight at an angle whose tangent is proportional to κ_0 , and if there were no saturation term when the current has reached the value represented by the line $O X$, the magnetism would attain the value represented by the height $X T$. But saturation has begun to set in, and the curve falls away from $O T$. Draw a line $O s$, at an angle having half the tangent of slope, and let it meet the curve at s . Then if $X T$ is drawn through s , the length $O X$ represents $(S i)'$ the number of ampère-turns that will reduce the permeability to half its initial value, and σ is equal to $\frac{1}{O X}$. I have proposed to call the point s at which this state of things is reached the "dia-critical point of saturation" of the magnet. It is easily shown that this dia-critical point is attained when the core is magnetised to exactly half its possible maximum of magnetism. When the iron is half saturated, its permeability is reduced to half its initial value.

FIG. 230.

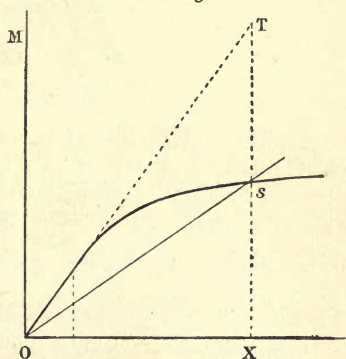

Draw a line $O s$, at an angle having half the tangent of slope, and let it meet the curve at s . Then if $X T$ is drawn through s , the length $O X$ represents $(S i)'$ the number of ampère-turns that will reduce the permeability to half its initial value, and σ is equal to $\frac{1}{O X}$. I have proposed to call the point s at which this state of things is reached the "dia-critical point of saturation" of the magnet. It is easily shown that this dia-critical point is attained when the core is magnetised to exactly half its possible maximum of magnetism. When the iron is half saturated, its permeability is reduced to half its initial value.

Now in the three equations of the series dynamo, Nos. [VIII.] to [X.], p. 279, it is seen that the electromotive-force is in every case proportional,

not to σ , but to the reciprocal of σ , that is to say to $(S i)'$. We may therefore put the matter in the following way:—*The electromotive-force of a dynamo of given construction, when driven at a given speed, and supplying given resistances, is directly proportional to that number of ampère-turns which will magnetise its field magnets to the dia-critical point of half-permeability, or of half-saturation.* This rule holds good also for shunt dynamos in which the number of ampère-turns is $Z i_s$, and also for compound machines in which the number of ampère-turns is $Z i_s + S i$. The value of $\frac{1}{\sigma}$ for the Edison-Hopkinson (shunt) dynamo, tested by Mr. F.

Sprague,* was about 20,880 : or, it required 20,880 ampère-turns of current to bring the field magnets up to the dia-critical point of half-permeability ; which was in fact very nearly the actual degree of magnetisation attained when the machine was lighting its full load of lamps.

To determine σ the magnet should be set to act upon a magnetometer (as in the process sketched out on p. 262), and excited at first with a small number of ampère-turns $S i$, and afterwards with a stronger current affording a large number of ampère-turns $S i'$, and the deflexions θ and θ' respectively obtained on the magnetometer observed. Then it can easily be shown that

$$\sigma = \frac{i' \tan \theta - i \tan \theta'}{(\tan \theta' - \tan \theta) S i i'}$$

NOTE ON THE COEFFICIENT "G."

A little explanation seems advisable concerning the coefficient G which was said to depend on the geometry of the field magnet. It is shown in treatises on magnetism that if a magnet pole of area a have m units of magnetism distributed uniformly over it, the field immediately outside it will be of an intensity $H = 2 \pi \frac{m}{a}$. And for a straight magnet

of length l , the magnetic moment $M = m l$. Whence $H = \frac{2 \pi M}{a l}$. But in an electro-magnet of length l , and cross-section a , the magnetic moment is determined by the formula $M = i S a \kappa$, where i is the strength of the current, S the number of turns in the coil, and κ the coefficient of magnetic permeability of the iron, which may be assumed as a constant only when the iron is far from saturation, and must otherwise be divided by a saturation term similar to that used (viz. $1 + \sigma S i$) in the formulæ of dynamos in this book. Writing in the value of M , we get

$$H = \frac{2 \pi i S}{l} \kappa.$$

* Vide *Electrician*, vol. xi. p. 296, August 11, 1883.

Now we have assumed that we may write for H

$$H = G \kappa i S,$$

whence

$$G = \frac{2\pi}{l},$$

a quantity depending only on the length of the magnet. In the case of curved magnets the expression for G will be much more complicated, but still involving only geometrical quantities.

NOTE ON THE COEFFICIENT OF MAGNETIC PERMEABILITY " κ ."

It was remarked on p. 248 above that the effect of putting iron cores into the coils was to multiply the effect by a certain number, which we symbolise by the letter κ , and which was stated to vary from 2 to 50 according to the quality, &c., of the iron. Much higher figures than this are given in text-books of electricity for the values of magnetic "permeability." But in most cases where experimenters have obtained the higher values—going up to 20,000 in some cases—their figures refer to the permeability not of the magnet as a whole, but of some portion of it—as for example, the middle bit of a long straight bar, or a piece of a closed iron ring. Moreover, it is known from the experiments of Rowland, Stoletow, and others, that the coefficient of permeability is not a constant, but when the magnetising current is small, increases at first, as the magnetising current increases, and then afterwards diminishes. It is also affected by the prior history of the specimen of iron, whether it has been subjected to strain, heating, or to some prior magnetisation. The permeability of closed circuits of iron, and of long thin pieces is enormously greater than that of short pieces. Hence the importance in dynamos that the armature and field magnets should constitute as nearly as possible a closed magnetic circuit. The value of κ in fact depends both on G and on A. It is assumed in the preceding equations that the values of κ for the iron in the armature, and for that in the field magnets may be included under the one symbol. Though not strictly so, no error of importance is thereby introduced because the quantities A, G, and κ usually appear as a single product. According to both Stoletow and Rowland the permeability of iron does not begin (as is assumed in the preceding pages) by being a maximum, and then become steadily less as the degree of magnetisation is raised. According to these authorities the permeability rises at first until a certain stage of the magnetisation, and afterwards falls. Their experiments were chiefly made on a small scale with iron rings. Were this the case in the magnetic circuits, the characteristic curves would not rise in straight lines, but would show a concavity near the origin; and this has been observed in some cases. For all practical purposes our simpler assumption is amply accurate. (See Appendix IV.)

CHAPTER XVI.

THE SHUNT DYNAMO.

IN the shunt dynamo, there are two circuits to be considered ; the main circuit, and the shunt circuit. The symbols used have the following meanings.

FIG. 231.

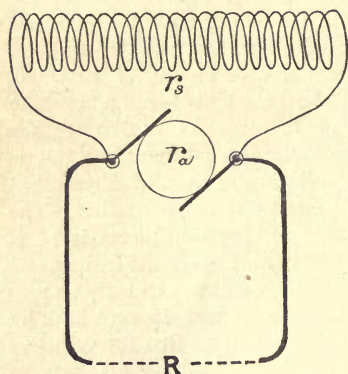

R = resistance of external main circuit (leads, lamps, &c.).

r_a = resistance of armature.

r_s = resistance of the shunt circuit (magnet coils).

i = the current in the external main circuit.

i_a = the current in the armature.

i_s = the current in the shunt circuit.

Then, clearly,

$$i_a = i + i_s;$$

because the current generated in the armature splits into these two parts in the main and shunt circuits, and is equal to their sum.

Also, by Ohm's law, we have for e the electromotive-force between terminals,

$$e = R i,$$

and also

$$e = r_s i_s;$$

because the terminals for the main circuit are also the terminals for the shunt circuit.

Further, since the nett resistance of a branched circuit is

the reciprocal of the sum of the reciprocals of the resistances of its parts, the nett external resistance from terminal to terminal is equal to $\frac{R r_s}{R + r_s}$; and hence it follows that

$$E = \left(r_a + \frac{R r_s}{R + r_s} \right) i_a.$$

We may at the same time find an expression for that part of the whole electromotive-force which is being employed solely to overcome the resistance of the armature, and which is, of course, the difference between E the total electromotive-force, and e the effective electromotive-force between terminals.

Ohm's law at once gives us

$$E - e = r_a i_a,$$

or

$$E - e = r_a (i + i_s).$$

From this we also get

$$e = E - r_a (i + i_s). \quad \text{[XIII.]}$$

We will also find an expression for E in terms of e , and the various resistances. Taking as above

$$E = \left(\frac{R r_s}{R + r_s} + r_a \right) i_a,$$

and writing for i_a its value as $i + i_s$, and for these $\frac{e}{R}$ and $\frac{e}{r_s}$, respectively, we get

$$E = e \left\{ \frac{R r_s + R r_a + r_a r_s}{R + r_s} \times \frac{R + r_s}{R r_s} \right\},$$

or

$$E = e \times r_a \left(\frac{1}{R} + \frac{1}{r_a} + \frac{1}{r_s} \right). \quad \text{[XIII. bis]}$$

Equations of Shunt Dynamo, deduced from the Law of Saturation.

As before, we have, as the fundamental equation of every dynamo,

$$E = 4 n A H ;$$

and we have to express H in a similar manner to that found for the series dynamo, but with the difference that the magnetising current is now i_s , a small portion only of the total current. Let the number of turns of wire in the shunt coils be denominated by the symbol Z ; then we may write

$$H = G Z i_s \frac{\kappa}{I + \sigma Z i_s};$$

where G , κ , and σ , have the same meanings (and, for a dynamo of identical design, the same actual values) as were allotted respectively to those symbols in the case of the series dynamo. Then we have, as the primary equations for the shunt dynamo,

$$E = 4 n A G Z i_s \frac{\kappa}{I + \sigma Z i_s},$$

and, by equation [XIII.],

$$e = 4 n A G Z i_s \frac{\kappa}{I + \sigma Z i_s} - r_a (i + i_s).$$

The latter equation may be transformed as follows:—

$$\{ e + r (i + i_s) \} (I + \sigma Z i_s) = 4 n A G \kappa Z i_s,$$

$$\left\{ e + r_a \left(\frac{e}{R} + \frac{e}{r_s} \right) \right\} \left(I + \sigma Z \frac{e}{r_s} \right) = 4 n A G \kappa Z \frac{e}{r_s},$$

$$\left\{ I + \frac{r_a}{R} + \frac{r_a}{r_s} \right\} \left(I + \sigma Z \frac{e}{r_s} \right) = 4 n A G \kappa Z \frac{I}{r_s},$$

$$r_a \left(\frac{I}{r_a} + \frac{I}{R} + \frac{I}{r_s} \right) \left(I + \sigma Z \frac{e}{r_s} \right) = 4 n A G \kappa Z \frac{I}{r_s},$$

$$\sigma Z \frac{e}{r_s} = \frac{4 n A G \kappa Z}{r_a r_s \left(\frac{I}{R} + \frac{I}{r_a} + \frac{I}{r_s} \right)} - I,$$

whence

$$e = \frac{I}{\sigma} \left\{ \frac{4 n A G \kappa}{r_a \left(\frac{I}{R} + \frac{I}{r_a} + \frac{I}{r_s} \right)} - \frac{r_s}{Z} \right\}, \quad [\text{XIV.}]$$

and, substituting this value in the equation previously obtained for E in terms of e ,

$$E = \frac{I}{\sigma} \left\{ 4nAG\kappa - \frac{r_s r_a \left(\frac{I}{R} + \frac{I}{r_a} + \frac{I}{r_s} \right)}{Z} \right\},$$

or

$$E = \frac{I}{\sigma} \left\{ 4nAG\kappa - \frac{r_s r_a + R r_s + R r_a}{Z R} \right\}. \quad [\text{XV.}]$$

It is instructive to compare equations Nos. [XIV.] and [XV.], with the corresponding set, Nos. [X.] and [VIII.], for the series dynamo. In both cases the electromotive-forces are inversely proportional to the saturation coefficient. In both, the potential at terminals would be proportional to the speed, but for a term to be subtracted, the value of which is the ratio of the resistances that determined the exciting current to the number of the exciting coils. In both, therefore, this deleterious term would disappear, provided the number of exciting coils could be indefinitely increased without increasing the resistances.

Equation of Current of Shunt Dynamo.

The equations for the three currents i , i_s , and i_a may also be added—

$$i = \frac{r_s}{\sigma} \left\{ \frac{4nAG\kappa}{r_a r_s + r_a R + r_s R} - \frac{I}{Z R} \right\}. \quad [\text{XVI.}]$$

$$i_s = \frac{R}{\sigma} \left\{ \frac{4nAG\kappa}{r_a r_s + r_a R + r_s R} - \frac{I}{Z R} \right\} \quad [\text{XVII.}]$$

$$i_a = \frac{R + r_s}{\sigma} \left\{ \frac{4nAG\kappa}{r_a r_s + r_a R + r_s R} - \frac{I}{Z R} \right\}. \quad [\text{XVIII.}]$$

These equations should be compared with No. [XI.],
p. 279.

Determination of the Constants of the Shunt Dynamo.

The only constants in the above equations which are not to be found also in the equations of the series dynamo are Z the number of turns of wire in the shunt coils, and r_s the resistance of the shunt coils. The latter can be measured simply as any resistance is. The former ought to be known, and marked on the machine by the manufacturer. The remark made previously as to the diminished effect of the outermost layers of wire in producing magnetisation applies even more pointedly to shunt coils, in which there are often many layers.

As an example, the following data, deduced from Mr. F. Sprague's tests, are given for an Edison-Hopkinson dynamo intended to feed 200 lamps at 110 volts. $r_a = 0.0325$; $r_s = 37$; $R = .877$ (192 lamps); $Z = 5800$ (estimated); $n = 1157$; $\sigma = 0.00004789$; and $AG\kappa = 0.00000253$. The separate values of A , G , and κ , are not ascertainable from Mr. Sprague's tests.

Economic Coefficient of Shunt Dynamo.

The economic coefficient η , is the ratio of the useful electric energy available in the external circuit to the total electric energy developed.

By Joule's law there is developed in t seconds in the external circuit

$$\text{useful work} = i^2 R t,$$

and in the same time there is wasted on heating,

$$\text{energy spent in shunt} = i_s^2 r_s t,$$

and

$$\text{energy wasted in armature} = i_a^2 r_a t;$$

whence

$$\begin{aligned} \eta &= \frac{\text{useful work}}{\text{total work}} = \frac{i^2 R}{i^2 R + i_s^2 r_s + i_a^2 r_a} \\ &= \frac{I}{I + \frac{R}{r_s} + \frac{i^2 r_a + 2 i i_s r_a + i_s^2 r_a}{i^2 R}} \\ &= \frac{I}{I + \frac{R}{r_s} + \frac{r_a}{R} + 2 \frac{i_s r_a}{i R} + \frac{r_a}{R} \left(\frac{i_s}{i}\right)^2} \\ &= \frac{I}{I + \frac{R}{r_s} + \frac{r_a}{R} + 2 \frac{R}{r_s} \cdot \frac{r_a}{R} + \frac{r_a}{R} \left(\frac{R}{r}\right)^2} \\ &= \frac{I}{I + \frac{R}{r_s} + \frac{r_a}{R} + 2 \frac{r_a}{r_s} + R \frac{r_a}{r_s^2}} \\ &= \frac{I}{I + \frac{R}{r_s} \left(1 + \frac{r_a}{r_s}\right) + \frac{r_a}{R} + 2 \frac{r_a}{r_s}} \end{aligned}$$

Now, for brevity, write for the total internal resistance, $r_a + r_s$, the single symbol r —

$$\eta = \frac{I}{I + \frac{R}{r_s} \cdot \frac{r}{r_s} + \frac{r_a}{R} + 2 \frac{r_a}{r_s}}$$

For this ratio to be a maximum it is clear that,

$$\frac{d \left(I + \frac{R}{r} \cdot \frac{r}{r_s} + \frac{r_a}{R} + 2 \frac{r_a}{r_s} \right)}{d R} \text{ must } = 0,$$

or

$$\frac{r}{r_s^2} - \frac{r_a}{R^2} = 0;$$

whence

$$R^2 = \frac{r_a r_s^2}{r} = r_a r_s \frac{r_s}{r},$$

and

$$R = \sqrt{r_a r_s} \sqrt{\frac{r_s}{r}}, \quad [\text{XIX.}]$$

or

$$R = r_s \sqrt{\frac{r_a}{r}} \quad [\text{XIXa.}]$$

This equation determines what particular resistance of the external main circuit will give the best economy with given internal resistances. Now substitute this value in those terms of the equation for η which contain R , and we get as their values:—

$$\frac{Rr}{r_s^2} = \frac{r}{r_s} \sqrt{\frac{r_a}{r}} = \frac{\sqrt{r_a r}}{r_s},$$

$$\frac{r_a}{R} = \frac{r_a}{r_s} \sqrt{\frac{r}{r_a}} = \frac{\sqrt{r_a r}}{r_s};$$

whence

$$\eta = \frac{\text{useful work}}{\text{total work}} = \frac{I}{I + 2 \frac{\sqrt{r_a r}}{r_s} + 2 \frac{r_a}{r_s}}.$$

This may be still further simplified, for we know that the resistance of the shunt is very high compared with that of the armature, possibly from 300 to 1000 times as great. If, then, $\frac{r_a}{r_s}$ is so small a term in comparison with the other term as to be negligible, we get

$$\eta = \frac{I}{I + 2 \frac{\sqrt{r_a r}}{r_s}}; \quad [\text{XX.}]$$

and, since r_a is small compared with r_s , r is very nearly equal to r_s , so that we may write, as an approximate equality,

$$\eta \doteq \frac{I}{I + 2 \frac{\sqrt{r_a r_s}}{r_s}},$$

or

$$\eta = \frac{1}{1 + 2 \sqrt{\frac{r_a}{r_s}}}, \quad \text{[XXI.]}$$

This latter approximate value is identical with that given by Sir W. Thomson in the report of the British Association for 1881: the equation No. [XX.] is, however, more correct.

It may be pointed out that it follows from equation No. [XIX.] above, that when the resistance of the armature is small compared with that of the shunt, so that r_s may be taken as equal to the value of r (which would be highly desirable if it could be attained in practice), then we should have

$$R = \sqrt{r_a r_s}; \quad \text{[XXII.]}$$

that is to say, when the proportion between r_a and r_s is made as favourable as possible, then the best external resistance to work with from the economic point of view is that resistance which is a geometric mean between the resistances of the armature and of the shunt coils, and any departure from this will diminish the value of the economic coefficient.

Practical Rules for Economic Design.

This affords us some practical information how to apportion the resistances in a shunt dynamo. Let the question be thus stated. Given the resistance of the armature r_a , what must the shunt resistance be so that the dynamo may (under favourable proportions of external resistance R) have an economic coefficient of 90 per cent.? From equation [XXI.] we get

$$\frac{90}{100} = \frac{1}{1 + 2 \sqrt{\frac{r_a}{r_s}}},$$

$$\frac{100}{90} = 1 + 2 \sqrt{\frac{r_a}{r_s}},$$

$$10 = 180 \sqrt{\frac{r_a}{r_s}},$$

$$r_s = (18)^2 r_a,$$

$$r_s = 364 r_a.$$

No shunt machine can give in the external circuit as much as 90 per cent. of its total electric energy unless its shunt has a resistance at least 364 times as great as that of its armature.

A good practical rule would be the following:—Ascertain what number of lamps will be the usual full load: reckon the resistance of them when connected to the mains. Let the armature resistance be one-twentieth of this; and let the shunt resistance be twenty times as great as this. In this case about 4 per cent. will be wasted in the armature, and about 4 per cent. in the shunt, leaving a margin of a little over 90 per cent. for the economic coefficient.

In two Edison machines ("K," 250 lights; and "Z," 60 lights) tested at Munich, the values were:—

	Armature.	Shunt Magnet.	r_s/r_a .	η observed.
"K"	0.0361	13.82	382.8	88.6
"Z"	0.142	40.1	282.4	65.3

An Edison-Hopkinson (200 lights) machine tested by Mr. F. J. Sprague gave:—

Cold	0.026	36.5	1403	} 93.6
Warm	0.0325	37.0	1135	

Experimental Determination how to wind the Shunt Field-magnet Coils.

Suppose the armature and framework to be ready to receive the coils. The question arises—How shall the shunt be wound? How many turns shall be put on, and of what resistance per foot must the wire be? A single preliminary experiment, made after the manner prescribed for the series dynamo on p. 281, will suffice. Wind on the cores of the magnets a temporary coil, which may consist of a comparatively few turns of thick wire. Separately excite the magnets through the temporary coils from some accumulators while the armature is being driven at its proper speed.

Run up the magnetising current until the magnets are just so much magnetised that the electromotive-force of the dynamo comes up to the required value. Observe what number of ampères you have run through the temporary coils and count the number of turns in your temporary coils. Multiply these together, and you will get the number of ampère-turns which your shunt coil must finally give in order to bring up the magnets to the proper power. Call this number P . You must next refer to the formula No. [XXII.] for the economic coefficient, to see what your shunt resistance ought to be. You of course know what r_a is, for your armature is already wound. You know what the value of R , the resistance of the regular load of lamps, will be. Then it follows that the proper value of r_s will be given by the formula

$$r_s = \frac{R^2}{r_a}.$$

Properly r_s ought to be at least 400 times r_a , as already shown. You now know r_s , and you know also what e has got to be. Divide e by r_s , and that tells you what i_s will be when your shunt is working. Divide the number of ampère-turns P , determined in your experiment by i_s , and that will finally give you Z , the number of shunt-turns required. Measure the circumference of the cores, and estimate the *average* value of the length λ , of one turn of wire. There will be Z turns, each on the average of length λ . The total length of wire required will be $Z\lambda$, and its resistance must be r_s . You must therefore select a wire of such a gauge that the

$$\text{Resistance per unit of length} = \frac{r_s}{Z\lambda}.$$

While we are considering from the practical point of view the magnetising effect of the shunt coils, it may be worth while to point out that if we increase Z , and increase r_s in an equal proportion, that is to say lengthen the coil with additional turns of wire, the effect will be to increase the electromotive-force (the same speed of driving being maintained); for a simple reference to equations Nos. [XIV.], [XVI.] and [XVIII.] will show that if Z and r_s are increased in proportion to one another, e , i and i_a are all increased in value. Reference to the equations for the economic coefficient, Nos. [XX.], [XXI.] and [XXII.], will show that if r_s is increased, not only is η increased, but the value of R , for which η is a maximum, is also increased. It is, then, a gain on every hand to increase the resistance of the shunt, provided the number of ampère-turns be not thereby diminished. If,

however, this end be sought to be attained by piling on more layers of shunt wire outside, it will not be successful, because the outer turns have more resistance per turn, and do not have the same magnetising power. If the outer turns are, however, wound with a thicker wire, so that their resistance is less in proportion as their distance from the surface of the iron core increases, the addition of more turns will be advantageous to the machine.

Returning to equation [XIII. *bis*], p. 289, it may be noted that the expression $\left(\frac{I}{\mathbb{R}} + \frac{I}{r_a} + \frac{I}{r_s}\right)$ is the sum of three conductivities of three paths, and is therefore equal to the conductivity of these three paths united in parallel with one another; that is to say, the conductivity as measured from brush to brush with the external circuit and shunt circuit joined up. Or, if we write \mathbb{R} for the resistance of the whole system of machine and circuit, as thus measured from brush to brush, then the equation may be written

$$E = e \times \frac{r_a}{\mathbb{R}};$$

when

$$\eta = \frac{e}{E} = \frac{\mathbb{R}}{r_a}.$$

CHAPTER XVII.

SELF-REGULATING DYNAMOS.

THE theory of the self-regulating dynamo is based upon the assumption, never absolutely attainable in practice, that there is such a quantity of iron in the cores of the field magnets, and that iron of such a quality, that it is not saturated when the dynamo is working at its maximum power. It also assumes that the driving arrangements are so good that the dynamo will run at exactly the same speed no matter whether it is doing its full work or no work at all.

If the above conditions are fulfilled, then, as will be shown, there are a variety of ways of more or less complexity in which the system may be so arranged as to be self-regulating. There are, however, two distinct ends to be attained in self-regulation. For some purposes—as for feeding a system of incandescent lamps in parallel—the current must be supplied to the mains at an absolutely *constant potential*, or, as some popularly phrase it, at a *constant pressure*; that is to say, the difference of potentials between the main terminals of the dynamo must be constant. This, of course, implies that the current delivered by the machine shall vary exactly in a ratio inverse to that of the resistance of the external circuit. For some other purposes, as for maintaining a set of arc lamps connected in a simple series, or for charging a number of sets of accumulators in different houses, or for running a number of motors in different places on one line, it is necessary to maintain in the line an absolutely *constant current*, no matter how many or how few lamps or motors may be at work. This, of course, means that when the resistance of the main circuit is increased the dynamo must of itself put forth a proportionate increase of electromotive-force.

The two ends to be attained by self-regulation, are therefore not only distinct, but incompatible with one another; a dynamo cannot possibly keep its electromotive-force constant, and at the same time vary it in proportion to the varying resistance of the external circuit. The two systems must therefore be kept absolutely apart. They are adapted to entirely different cases of electric distribution. Their theory is different.

But, having said this, it may be pointed out that though the conditions of *constant potential* distribution are distinct from those of *constant-current* distribution, the combinations for attaining either result in the generating machinery are closely similar. The general method of arranging a self-regulating dynamo system for either of the two purposes, consists in adding to the dynamo some arrangement to maintain either an independent magnetism, or an independent electromotive-force, or an independent current, in it or in its circuit, quite irrespective of its own self-excited magnetism, or current, or electromotive-force. And a further modification of the method enables even a self-exciting machine to be very nearly self-regulating, part of the circuit being so disposed as to be practically independent in its reaction.

To obtain a *constant-potential* distribution, one of the following combinations must be made:—

- (i.) Series dynamo + permanent magnets to partly excite the field, with an independent constant magnetisation.
- (ii.) Series dynamo + an independent current circulating in separate coils round the field magnets, to produce an independent constant magnetisation.
- (iii.) Series dynamo + an independent current circulating in the main circuit (and generated either by a battery or by an independent magneto-dynamo) having the effect of partly exciting the field magnets, with an independent constant magnetisation.
- (iv.) Series dynamo + shunt-magnet coils supplied by a portion of the current of the machine itself, thereby partly exciting the field magnets, with an independent and nearly constant magnetisation.

To obtain a *constant-current* distribution, one of the following analogous combinations must be adopted:—

- (i.) Shunt dynamo + permanent magnets, to partly excite the field with an independent constant magnetisation.
- (ii.) Shunt dynamo + independent current circulating in separate coils round field magnets, to produce an independent constant magnetisation.
- (iii.) Shunt dynamo + independent current circulating in the shunt coils along with the shunt current (and generated either by a battery or by an independent magneto dynamo) having the effect of partly exciting the field magnets, with an independent constant magnetisation.
- (iv.) Shunt dynamo + series coils on field magnet supplied by the main circuit current of the machine itself, thereby partly exciting the field magnets, with an independent and constant magnetisation.

The two methods marked (iv.) in each set, are often spoken of as methods of "*compounding*" the dynamo; the term "compound dynamo" having been adopted for a dynamo with mixed series and shunt winding, by analogy with the engineers' term "compound engine" for a steam-engine working with both high- and low-pressure cylinders. The rules for compounding in the two cases will be deduced in their proper place.

Theoretically, several other self-regulating combinations are possible; for example, a series machine with unsaturated magnets combined with a (quasi-independent) series machine with over-saturated magnets on the same shaft; a series machine having two sets of field-magnet poles at different leads, one of the sets of poles being the series-excited set, the other excited independently, or in shunt circuit; &c.

In considering both kinds of distribution we shall have to find expressions for two things: (a) the independent current or potential which produces the independent magnetisation, and (b) the "critical speed," that is to say the particular speed

of driving at which self-regulation holds good. The relation of this critical speed to the characteristic of the dynamo is discussed in the chapter on the Geometrical Theory, p. 382.

Distribution at Constant Potential.

Case (i.). Series Dynamo + Permanent Magnets.—If the field magnets are partly permanently magnetised; or if there are permanent steel magnets in addition to the electromagnets, giving a partial permanent field, independent of that due to the current in the circuit, we may denominate this independent field as H_1 .

Now the fundamental equation of the series dynamo is

$$E = 4 n A H,$$

and the difference of potential between the terminals, otherwise called the pressure, is shown on p. 276 to be

$$e = E - (r_a + r_m) i.$$

But H , the field, is made up of two parts, the permanent independent part H_1 , and a part depending upon the current i , and equal to $G \kappa S i$, where S is the number of turns, κ the magnetic susceptibility, and G the geometrical coefficient, all exactly as for the ordinary series dynamo, except for the omitted saturation term. Then we may write for H ,

$$H = H_1 + G \kappa S i,$$

and we get, as the complete expression for e ,

$$e = 4 n A (H_1 + G \kappa S i) - (r_a + r_m) i,$$

or

$$e = 4 n A H_1 + 4 n A G \kappa S i - (r_a + r_m) i.$$

The expression on the right-hand side of this equation consists of three terms, of which the first contains the speed and three constants as factors. The last two contain a variable, the current, and one of them also contains the speed as a factor. If there be a particular speed at which the dynamo is really self-regulating, clearly at that speed the expression for e will

contain nothing but constants. It is evident therefore that at the critical speed, which we will call n_1 , the last two terms will cancel one another out, or,

$$4 n_1 A G \kappa S i - (r_a + r_m) i = 0.$$

That is to say the speed must be such that

$$4 n_1 A G \kappa S = r_a + r_m. \quad [\text{XXIII.}]$$

This is the equation of condition.

If the condition laid down in this equation is observed, then the last two terms for e disappear, and we have simply,

$$e = 4 n_1 A H_1 = a \text{ constant.}$$

Having thus proved that, at the critical speed, e is a constant, it is worth while to enquire what it is that determines the value of e . Clearly e is directly proportional to H_1 , the independent and permanent field magnetism. Therefore, we can arrange that the dynamo, still driven at the critical speed, shall give any potential we please, provided we alter H_1 in the requisite proportion.

Returning to the equation of condition, we will write it in the second form—

$$4 n_1 A G \kappa S = r_a + r_m,$$

which gives us as the value of the critical speed,

$$n_1 = \frac{r_a + r_m}{S} \cdot \frac{I}{4 A G \kappa}.$$

This shows us that there is another way of getting a higher value of e . If we increase n_1 we know e will also increase proportionally, and we may increase n_1 provided we decrease S at the same time in the inverse proportion. If this is done the critical condition still holds good, as $4 n_1 A G \kappa S$ will still equal $r_a + r_m$.

Lastly, we may write the last equation in the following way,

critical speed = $\frac{\text{total internal resistance}}{\text{number of turns of magnet coil}} \times \text{a constant.}$

This is instructive also. The higher the internal resistance of a dynamo, the higher must be the driving speed if it is to be self-regulating.

Case (ii). *Series Dynamo + Separately-exciting Coils* (see "*Series and Separate*," Fig. 75, p. 96).—In this case there is an independent magnetism due to a current carried round the field magnets in separate coils, and providing a part of

FIG. 232.

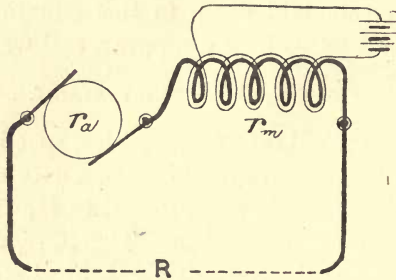

the field magnetism. The connexions are shown in Fig. 232. Let the intensity of field due to the separately-excited coils be called H_1 .

Then, as before,

$$e = E - (r_a + r_m) i,$$

$$E = 4 n A H,$$

$$\text{and } H = H_1 + G \kappa S i,$$

whence, as in the preceding case,

$$e = 4 n A H_1 + 4 n A G \kappa S i - (r_a + r_m) i,$$

and the condition that e becomes constant is, as before, that the speed shall be given such a value n_1 that

$$4 n_1 A G \kappa S = r_a + r_m. \quad [\text{XXIV.}]$$

The same conclusions as before hold good. We can give any value to e we please by altering to the requisite proportion the value of H_1 , the excitement due to the separate source of current. And, as before, the critical speed will be proportional to the total internal resistance.

Practical Process for Determining the Winding of the Main and Separately-exciting Coils.

It may be convenient to give the process for determining the windings for one case, namely, where the separately-exciting coils are supplied by a magneto machine from the same shaft. We will distinguish the auxiliary magneto machine by the letter Y. A temporary coil of known number of turns must be wound upon the field-magnet cores, and some accumulators must be provided to excite the coil during the experiments. First run machine Y at proper speed, and ascertain its electromotive-force, which we will call e_y volts. Then run the dynamo at its proper speed but with circuit open, and with the accumulators separately exciting its magnets, till the pressure at the terminals comes up to the proper value of e volts. Observe how many ampères of current are running through the temporary coil, multiply by the number of turns, and call the number of ampère-turns P. That is, the number of ampère-turns which the machine Y must furnish in the separate coils. For economy these separate coils should have a resistance r_s least twenty times as great as that of the armature of the Y machine. We know then what r_s must be. Divide e_y by $r_s +$ the armature resistance of Y. This will give i_s , the current in the separate coils. Divide P by i_s and this will give the number of turns for the separate coil, call this number Z. Then if λ be the average length of one turn of the coil, $Z\lambda$ is the length of wire required for the separate coils, and its gauge must be such that the resistance per unit of length ρ_s shall be $= \frac{r_s}{Z\lambda}$.

Next, unite the external circuit of the dynamo with a resistance R about equal to that of the full load which it will have in practice, and again separately excite with the accumulators till the potential at the main terminals comes up to e . Call the ampère-turns in this experiment Q. Then the main-circuit coils must be such as to give $Q - P$ ampère-turns of exciting power. If the current running in the last experiment was i , then $\frac{Q - P}{i} = S$, the requisite number of turns. Now, for good economy r_m the resistance of the main-circuit coils on the magnet should be about $\frac{2}{3} r_a$. Therefore, calling ρ_m the resistance per unit length of the wire of these coils, it at once follows that they should be of such wire that the resistance per unit of length $\rho_m = \frac{2 r_a}{3 S \lambda}$, which determines the gauge of wire to be used.

Case (iii.). Series Dynamo + Independent Electromotive-force thrown into the Main Circuit.—This really comprises two cases; where the independent constant electromotive-force is due to a battery, and where it is due to a separate magneto machine driven at a constant speed ("Series and

Magneto," see p. 97). The argument is the same, however, for both cases. Fig. 233 will represent either case.

We have here as the whole electromotive-force of the

FIG. 233.

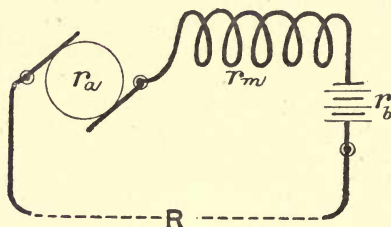

combination E , the electromotive-force of the armature, plus E_b the independent electromotive-force thrown in from the battery or magneto machine. The difference of potential between the terminals A and B , which we have always denominated as e , will be got by subtracting from $E_b + E$ that part of the electromotive-force which is devoted to sending current i through the internal resistances, which are now r_a , r_m , and r_b ; so that we have

$$e = E_b + E - (r_a + r_m + r_b) i.$$

Now $E = 4 n A G \kappa S i$; therefore, in order to make the last two terms cancel one another and leave e a constant, we must give the speed the value n_1 such that

$$4 n_1 A G \kappa S = r_a + r_m + r_b, \quad [\text{XXV.}]$$

which is the equation of condition. In this case,

$$e = E_b.$$

This proves that in this case, too, the constant potential at the terminals is identical with that due to the independent excitation. Of course this does *not* mean that the dynamo does no work. On the contrary, it means this; that when the resistance of the external circuit is infinitely great, so that the dynamo does no work, then the only electromotive-force in the circuit is that due to the independent source. It can be

easily shown that for the case where the external resistance R equals the whole internal ($r_a + r_m + r_b$), that then $E = E_b$ and the work done by the dynamo is exactly equal to that done by the battery or independent magneto. If, however, as economy requires, the resistance of the external circuit be greater than the internal resistance, then the battery or magneto machine will do most of the work. The series dynamo part of the combination is the real regulator, and continually supplements the battery or magneto with enough electric energy to supply the current at the proper electromotive-force through the resistances that may happen to be in the external circuit.

As in case (*i*) we may re-write the equation of condition so as to tell us what circumstances will determine the speed. This gives

$$n_1 = \frac{r_a + r_m + r_b}{S} \frac{I}{4 A G \kappa},$$

or

$$\text{critical speed} = \frac{\text{total internal resistance}}{\text{number of turns of magnet coil}} \times \text{a constant.}$$

The constant $4 A G \kappa$ depends only on the design of the dynamo and quality of its materials. As the total internal resistance is a given quantity, it is clear that we may alter the speed, provided we alter the number of turns in the magnet coils in the inverse proportion.

Practical Process for Determining the Proper Number of Turns to be given to the Magnet Coils.

Suppose we want to arrange a combination of this kind, to work, say, a number of incandescent lamps at a fixed potential of e volts, we must go through a process similar to that previously prescribed, of separately exciting a temporary coil on the field-magnet cores. We will take the case where the independent source is a magneto machine. We know that when running at its proper speed its electromotive-force is E_b . Join the terminals of the dynamo with a resistance R to represent the maximum load of lamps; run the dynamo at its proper speed, then separately excite until e comes up to the requisite number of volts. Call the number of ampère-turns P . Divide P by i (the actual current in the experiment), and this gives S the requisite number of turns to be wound on the cores as a permanency. Then, remembering that in a series dynamo

r_m ought to be about two-thirds of r_a , and that the average length of a turn in the magnet coils is called λ , we have, as the resistance per unit of length of the coils, $\frac{2 r_a}{3 S \lambda}$, which determines the gauge of wire to be selected.

Case (iv.). Series Dynamo + Shunt Exciting Coils: "Compound" Dynamo.—The series dynamo when supplied with a certain number of shunt coils in addition to the main circuit or series coils, becomes very nearly self-regulating: and there is, as in preceding cases, a certain critical speed at which the regulation is most nearly perfect. There are two possible methods of connecting the shunt coils to the dynamo, and the proportions differ slightly in the two cases. The shunt coils may be joined as a shunt to the armature part of the dynamo only, being connected across from brush to brush. This case is denominated in the earlier part of this work as "Series and Shunt" (see Fig. 77, p. 99). In the second method the shunt coils are connected across the terminals of the machine, and may, therefore, be regarded either as a shunt to the external circuit, or as a shunt to the armature and series coils together. This arrangement I have termed "Series and Long Shunt" (see Fig. 78, p. 100). In the former arrangement the current through the shunt is not constant, because the potential at the brushes e is not the same as e ; and though e may remain fairly constant, e does not, but increases when the external circuit's resistance decreases. In the latter arrangement ("long shunt") the current through the shunt is constant if e is constant, and the case becomes one analogous to those already discussed, of an independent constant excitement.

FIG. 234.

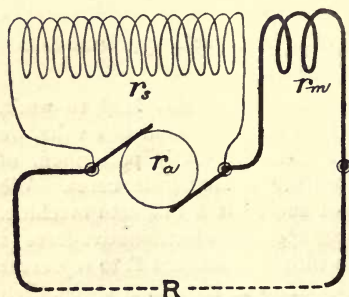

Series and Shunt.

The connexions of this method are indicated in Fig. 234. Using the same symbols as before, and writing S for the

number of turns in the main circuit or series coil, and Z for the number of turns in the shunt coil, we have

$$\begin{aligned} E &= 4 n A H ; \\ H &= G \kappa (Z i_s + S i) ; \\ i &= i_a - i_s ; \\ e &= E - r_a i_a - r_m i ; \end{aligned}$$

whence we get

$$\begin{aligned} e &= 4 n A G \kappa Z i_s + 4 n A G \kappa S (i_a - i_s) - r_a i_a - r_m i_a + r_m i_s, \\ e &= 4 n A G \kappa (Z - S) i_s + r_m i + 4 n A G \kappa S i_a - (r_a + r_m) i_a. \end{aligned}$$

The last two terms on the right-hand side will cancel one another out, provided that the speed be given such a value n_1 that

$$4 n_1 A G \kappa S = r_a + r_m, \quad [\text{XXVI.}]$$

which is, therefore, one of the *two* equations of condition. It may also be written—

$$4 n_1 A G \kappa = \frac{r_a + r}{S}.$$

We then get, at the critical speed n_1 ,

$$e = \left\{ 4 n_1 A G \kappa (Z - S) + r_m \right\} i_s.$$

Now if the dynamo is truly self-regulating, it will give a constant potential e even when the external circuit is opened. In that case the only current will be that which is generated in the armature and runs round the shunt. Into the equations of this combination neither S nor r_m can enter, as there is no current through the series coils, and the potential e will be the same as the potential at the brushes. In fact, under these conditions the arrangement may be regarded either as a series dynamo in which for the usual resistances R and r_m the resistance r_s has been substituted, or as a shunt dynamo in which R has become infinite. We may, therefore, at once refer either to equation [IX.] of series dynamo or equation [XIV.] of shunt dynamo, and, making the above substitutions, write

$$e = \frac{I}{\sigma} \left\{ 4 n_1 A G \kappa \frac{r_s}{r_s + r_a} - \frac{r_s}{Z} \right\}.$$

But we have already found a value for $4 n_1 A G \kappa$; and, inserting that value, we get

$$e = \frac{1}{\sigma} \left\{ \frac{r_s (r_a + r_m)}{S (r_s + r_a)} - \frac{r_s}{Z} \right\} = \text{a constant.}$$

Now this equation is to be true even if the dynamo have so much iron that it is never near to being saturated; that is to say, even if σ is excessively small. But if σ is excessively small, $\frac{1}{\sigma}$ will be excessively large: and if $\frac{1}{\sigma}$ is excessively large, it is clear that the term within the brackets must be also excessively small. In fact, it is, if the magnets are nowhere near saturation, practically zero. We may therefore write

$$\frac{r_s (r_a + r_m)}{S (r_s + r_a)} = \frac{r_s}{Z};$$

or

$$\frac{S}{Z} = \frac{r_a + r_m}{r_s + r_a}, \quad [\text{XXVII.}]$$

which is the *second* equation of condition.

This translated into words is as follows:—*The number of series turns must be to the number of shunt turns as the sum of the resistances of the armature and series coils is to the sum of the resistances of the armature and shunt coils.*

Practical Determination of the Winding of the Magnet Coils.

As in previous cases, we may now sketch out a method of determining by experiment the proper winding. Temporary coils of a known number of turns must be wound on the field-magnet cores, and some accumulators provided as described in the previous cases. The dynamo must be driven at its proper speed, and then the magnets must be excited until the potential e comes up to the proper number of volts. This must be done firstly on open circuit to determine Z , and then calculate S by equation [XXVII.], or S may be determined by a second experiment made when a resistance R representing the full working load of lamps is intercalated in the external circuit. The ampères circulating in the temporary coil in the two cases must be noted, and multiplied by the number of turns in the coil. Let the number of ampère-turns required to excite the magnets when on open circuit be called P , and the number required when

working through external resistance R be called Q ; then we can deduce the rule as follows:—We know that $P = Zi_s$, where $i_s = \frac{e}{r_s}$. Now for good economy r_s must, in an ordinary shunt machine, be at least 400 times r_a , and in a machine that has series coils as well, should be much more—say 1000 to 1500 times r_a . We know r_a , so we know r_s ; hence also we can calculate what i_s should be. So finally Z is determined, as

$$Z = \frac{P r_s}{e}. \quad [\text{XXVIII.}]$$

The value of S may then be calculated from equation [XXVII.]

To determine S by experiment is the better process, though a little more intricate, because the current through the shunt is not constant, but increases with the increase of current in the series coils. But we know that

$$Q = Zi'_s + Si,$$

where i'_s denotes the current in the shunt at the moment when the current in the external circuit has the value i . Now i'_s is the same thing as $\frac{\epsilon}{r_s}$, where ϵ is the difference of potential between the brushes, and as

$$\epsilon : e = R + r_m : R,$$

it follows that

$$\begin{aligned} Q &= Z \frac{e}{r_s} + Z \frac{e r_m}{R r_s} + Si, \\ &= P \left(1 + \frac{r_m}{R} \right) + Si. \end{aligned}$$

Now as r_m is only two-thirds of r_a , and r_a is small compared with R , we may neglect the term $\frac{r_m}{R}$, which leaves the matter,

$$Q - P = Si;$$

whence

$$S = \frac{Q - P}{i} = \frac{(Q - P) R}{e}. \quad [\text{XXIX.}]$$

This shows that all the additional excitement required when there is an external current i to be maintained, must be derived from the main-circuit coils. In the second experiment the number of ampères i were observed, hence S can be at once calculated.

It only remains to deduce the gauge of wire to be used. There are to be S turns, and the total resistance of r_m is to be two-thirds that of r_a . Hence if λ be the length of one turn of wire, we must select it of such a gauge that the resistance per unit of length shall be

$$\rho_m = \frac{2 r_a}{3 S \lambda}.$$

The shunt wire may be similarly calculated. There are to be Z turns of

total resistance r_s . If they are going to be wound on (as is usual) outside the series coils, the average length of one turn will be longer than λ —call it λ' . Then the wire must be of such a gauge that the resistance per unit of length is

$$\rho_s = \frac{r_s}{Z \lambda'}$$

A practical process for determining the winding, the invention of Mr. C. Watson, has been used for some months by the Anglo-American Brush Corporation. The details of this process are not public; but as it involves a preliminary experiment with a separately-excited coil it doubtless resembles more or less that which is here sketched out.

Series and Long Shunt.

FIG. 235.

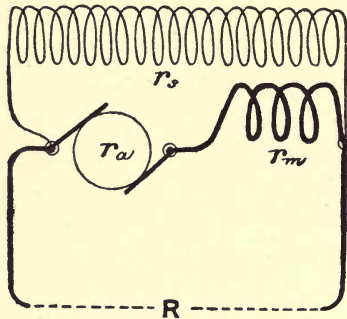

Here the connexions are as shown in Fig. 235.

The symbols are the same as in the preceding case, but the calculations are slightly different. For we have

$$E = 4 n A H ;$$

$$H = G \kappa (Z i_s + S i_a) ;$$

$$e = E - (r_a + r_m) i_a ;$$

whence

$$e = 4 n A G \kappa Z i_s + 4 n A G \kappa S i_a - (r_a + r_m) i_a .$$

The first of the three right-hand terms is a constant if the current through the shunt is a constant, as it must be *ex hypothesi*, and therefore e is a constant provided that the speed be such that

$$4 n_1 A G \kappa S = r_a + r_m ; \quad [\text{XXX.}]$$

which is the *first* equation of condition as before. But this would leave e indeterminate. To determine e , suppose an experiment made with the external circuit open. Then the current i_s would run through the shunt, and the same current would also run through the series coils, so that the actual excitement of the magnet will be $(Z + S) i_s$ ampère-turns,

instead of $Z i_s$, and the dynamo under these conditions is a pure series dynamo with r_a , r_m and r_s for the resistances of the circuit.

Whence it follows from equation [IX.], p. 279, that

$$e = \frac{I}{\sigma} \left\{ \frac{4 n_1 A G \kappa}{I + \frac{r_a + r_m}{r_s}} - \frac{r_s}{Z + S} \right\}.$$

The term $\frac{r_a + r_m}{r_s}$, being small, may be omitted ; and, writing in the value of $4 n A G \kappa$, we get

$$e = \frac{I}{\sigma} \left\{ \frac{r_a + r_m}{S} - \frac{r_s}{Z + S} \right\}.$$

Here, as before, because of the smallness of σ , we may write

$$\frac{r_a + r_m}{S} - \frac{r_s}{Z + S} = 0,$$

which is the *second* equation of condition. It immediately results that

$$\frac{Z}{S} = \frac{r_s - r_a - r_m}{r_a + r_m}, \quad \text{[XXXI.]}$$

which gives the proportionate number of coils.

Practical Determination of the Winding of the Magnet Coils.

The process is identical with that described above, but the calculations are not quite the same. Let P represent the ampère-turns required to excite the magnet to the requisite point when on open circuit, and Q the number required when working through external resistance R.

Then

$$S = \frac{Q - P}{i} = \frac{(Q - P) R}{e} \text{ as before,} \quad \text{[XXXII.]}$$

and

$$Z = \frac{P}{i_s} - S. \quad \text{[XXXIII.]}$$

Dr. Frölich has raised the objection to the author's equations, and specially to the rule in italics on p. 310 which expresses the condition implied in equation [XXVII.], that they are incorrect because they are based upon the assumption that the saturation term may be omitted. Dr. Frölich's more complicated formulæ will be found in Appendix IV. But the author may fairly claim that his equations only professed to be first approximations, which, however incomplete in themselves, led him to discover *the true practical process* for winding the coils that gives more accurate results than any other.

Practical Effect of the Saturation Term in Compound-wound Machines.

It will have been observed that in each of the preceding cases, after obtaining the first equation of condition, we considered the effect of running the machine on open circuit, and determined the fundamental value of e by recurring to the equation No. [IX.] of a series dynamo, which was itself deduced from equations involving a saturation term. In fact, were there no saturation term, the electromotive-force instead of being constant would be indeterminate. But there is another way in which the effect of the saturation term comes in. If the dynamo were wound according to equation [XXVII.], after a single experiment made on open circuit, when the field magnets are comparatively feebly excited, it would be found that on full work there would not be quite enough series coils (unless these were wound inside the shunt coils to give them a slight advantage) to keep up e to its proper value, owing to the partial saturation of the iron. If, on the other hand, the value of S has been determined by an experiment made when the dynamo is generating its average maximum current, it will be found that though e will be the same with maximum current as with no current, there will be a slight *rise* of e when the current is less than the maximum. The cause will be apparent by referring to Fig. 275, p. 383. The characteristic PQ is never precisely a straight line, it always is slightly convex in the upper part. Consequently, though QJ , the potential between the terminals of the external circuit when there is maximum current, may be exactly equal to OP , the

potential on open circuit, the potential at an intermediate point, as, for example, a E will be slightly greater. This is actually observed in the best compound-wound dynamos. The reader should examine the characteristics given in Fig. 277, p. 385, in proof of this matter.

Effect of Armature Reaction.

The current in the armature reacts as we know on the field magnets, tending partially to magnetise them with a polarity opposite to that of the armature itself, and proportional to the armature current. In fact, in some shunt machines the reaction of the armature produces an effect akin to that of a series coil, and makes the machine approach toward self-regulation. This effect has been noticed in an Edison-Hopkinson dynamo, but it is partly also due to the small resistance of the armature relatively to that of the external circuit.

Distribution with Constant Current.

This system of distribution has more limited application, hence we shall not devote so much space to establishing the equations. Here we must find expressions for i the current in the external circuit, and having found them, deduce such equations of condition as will make their values constant.

Case (i). Shunt Dynamo + Permanent Magnets.—The fundamental expressions are

$$\begin{aligned} E &= 4nAH, \\ H &= H_1 + G\kappa Zi_s, \end{aligned}$$

where H_1 is the field due to the permanent part of the magnetism ;

$$E = 4nAH_1 + 4nAG\kappa Zi_s.$$

Now we know that E is equal to the sum of the electromotive-forces in the armature part and in the shunt part of the circuit respectively ; or

$$E = r_s i_s + r_a i_a ;$$

for these form a closed circuit on themselves. Now

$$i_a = i_s + i,$$

$$\therefore E = r_s i_s + r_a i_s + r_a i.$$

Whence

$$4 n A G \kappa Z i_s - (r_s + r_a) i_s + 4 n A H_1 = r_a i.$$

Now if we run the dynamo at such a speed n_1 that the terms involving i_s cancel out, we must write

$$4 n_1 A G \kappa Z = r_s + r_a$$

as the equation of condition. If this be fulfilled, this leaves

$$4 n_1 A H_1 = r_a i,$$

or

$$i = \frac{4 n_1 A H_1}{r_a}. \quad [\text{XXXIV.}]$$

This is a constant, no matter what the value of R may be. Also it is clear that

$$n_1 = \frac{r_s + r_a}{Z} \frac{I}{4 A G \kappa}, \quad [\text{XXXV.}]$$

or the critical speed is proportional to the resistance of the dynamo when running on the shunt alone with the main circuit open. We may in fact write

$$\text{critical speed} = \frac{\text{total internal resistance}}{\text{number of turns in the shunt coil}} \times \text{a constant.}$$

It will also be noticed that the constant is equal to that current which would be generated by the armature running at critical speed in the field with no other resistance than that of r_a , and no other excitement of the field magnets beyond their permanent magnetism. *The practical method of determining the proper winding is based on this fact.*

Practical Method of Ascertaining the Winding of the Coil.

First short-circuit the armature through an ampère-meter of inappreciable resistance, and vary the speed of the machine till it gives the requisite current. This gives the critical speed. Now run it at that speed

when the terminals are connected by the largest external resistance R with which the machine will be usually worked, and a temporary shunt of resistance r_s connected. What r_s must be is a question of economy. If the machine is to be truly economical (see p. 296), R should be at least twenty times as great as r_a , and r_s should be at least 400 times r_a . The machine must then be separately excited by a temporary coil, until, while running at the critical speed, it gives a current equal to i . Then i_s can be at once calculated. Let Q be the number of ampère-turns needful to excite the temporary coil, $Q \div i_s = Z$, the required number of turns, and the gauge must be such that $Z\lambda = r_s$; λ being the average length of one turn.

Case (ii). Shunt Dynamo + Separately-exciting Coils (see "Shunt and Separate," Fig. 79, p. 102).—In this case the independent excitement is due to a current i_s' running through a separate coil of Z' turns. See Fig. 236. Here, therefore,

$$H = G \kappa (Z i_s + Z' i_s').$$

We may write for $G \kappa Z' i_s'$ the separate symbol H_1 , as it is immaterial to the action of the machine whether the independent field is due to a separate current or to permanent magnets.

The conditions are, therefore, precisely the same as in Case (i) preceding; the critical speed being

$$n_1 = \frac{r_s + r_a}{Z} \frac{I}{4 A G \kappa},$$

and the critical current

$$i = \frac{4 n_1 A H_1}{r_a} = \frac{4 n_1 A G \kappa Z' i_s'}{r_a}.$$

Now we may write $4 n_1 A H_1 = E'$, the electromotive-force due to $Z' i_s'$ in the field magnets; in which case

$$i = \frac{E'}{r_a}, \quad [\text{XXXVI.}]$$

FIG. 236.

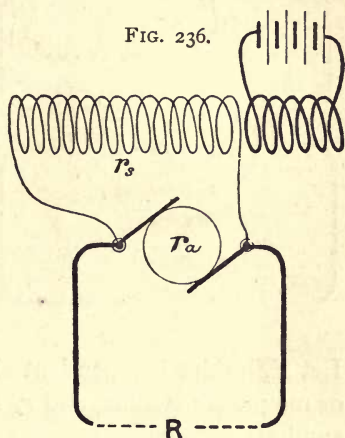

showing that the critical current is equal to the current that would be sent through the armature by the electromotive-force due to the independently-excited part of the field only. The practical experiment for determination of the coil is identical with the preceding case; but in this case the amount of the current at critical speed can be varied at will by varying either Z' or i_s .

Case (iii.). Shunt Dynamo + Independent Electromotive-force Thrown into the Circuit.—This really includes two

cases: (a) where the electromotive-force of a battery or magneto-machine is thrown into the armature part; (b) where the electromotive-force is thrown into the shunt part of the circuit.

The connexions for Case (iii.), (a), are shown in Fig. 237. Here we have

$$E = 4 n A H$$

$$H = G \kappa Z i_s.$$

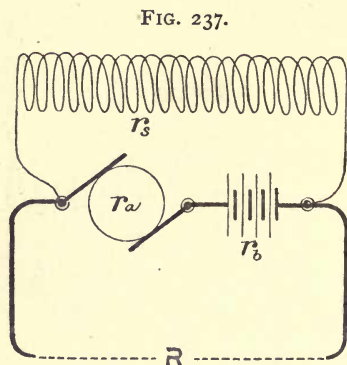

Let E_b be the independent electromotive-force of the battery or magneto machine, and r_b the resistance of the same; other symbols as before.

Then we have

$$E + E_b = r_s i_s + (r_a + r_b) i_a;$$

and

$$i_a = i_s + i;$$

whence

$$4 n A G \kappa Z i_s + E_b = (r_s + r_a + r_b) i_s + (r_a + r_b) i;$$

$$\left\{ 4 n A G \kappa Z - (r_s + r_a + r_b) \right\} i_s + E_b = (r_a + r_b) i.$$

In order that i shall be constant the term containing the variable i_s must vanish; or the speed must be given a value n_1 such that

$$4 n_1 A G \kappa Z = r_s + r_a + r_b,$$

which is the equation of condition. This may be written

$$n_1 = \frac{r_s + r_a + r_b}{Z} \frac{I}{4 A G \kappa},$$

or, as in previous cases,

$$\text{critical speed} = \frac{\text{total internal resistance}}{\text{number of turns in shunt coil}} \times \text{a constant.}$$

It follows that at the critical speed

$$E_b = (r_a + r_b) i$$

whence

$$i = \frac{E_b}{r_a + r_b}; \quad [\text{XXXVII.}]$$

or the constant current is equal to that which the independent electromotive-force could send through the resistances of the armature part of the circuit; and this is constant, however R may vary.

FIG. 238.

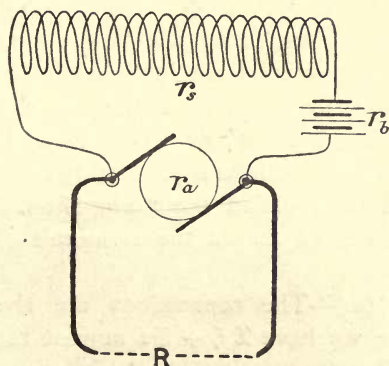

The connexions for Case (iii.), (b), are given in Fig. 238. See also Fig. 80, p. 103.

Here we have

$$\begin{aligned} E + E_b &= (r_s + r_b) i_s + r_a i_a, \\ &= (r_s + r_a + r_b) i_s + r_a i; \end{aligned}$$

whence

$$\{4 n A G \kappa Z - (r_s + r_a + r_b)\} i_s + E_b = r_a i_s.$$

Put $4 n_1 A G \kappa Z = r_s + r_a + r_b$, and we get, as before,

$$i = \frac{E_b}{r_a}. \quad [\text{XXXVIII.}]$$

Practical Determination of the Winding.

To determine the coil in either of these cases, short-circuit the battery or magneto (driven at proper speed) through $r_a + r_b$ and observe the current i . Then connect the terminals with a resistance $R =$ at least twenty times r_a , and join up also a temporary shunt of resistance r_s at least 400 times r_a . Also wind a temporary coil on the field magnets, and excite them up, while the machine revolves at speed n_1 , until i attains its proper value. Notice how many ampère-turns are being thus used to produce requisite magnetism: call the number Q . Then, from r_s , r_b , R , and i , all of which are known, calculate i_s . Then, dividing Q , the requisite number of ampère-turns by i_s , the shunt current, will give Z the requisite number of shunt turns; and the gauge of wire to be employed may be calculated as in previous cases.

Case (iv.). Shunt Dynamo + Series-exciting Coils: "Compound" Dynamo.—Here again are two cases, according to whether (a) the series coils are included in the main circuit outside the shunt, in which case the shunt is simply connected across the brushes; or whether (b) the series coils are included in the armature part of the circuit, in which case, which we have called the "long-shunt" arrangement, the shunt is connected across the terminals of the external circuit:—

Case (iv.). (a.)—The connexions are the same as in Fig. 234. Here we have $Z i_s + S i$ ampère-turns in the exciting coils. Therefore,

$$E = 4 n A G \kappa Z i_s + 4 n A G \kappa S i.$$

But also,

$$E = r_a i_a + r_s i_s,$$

and

$$i_a = i_s + i;$$

whence,

$$\{4 n A G \kappa Z - (r_a + r_s)\} i_s = (r_a - 4 n A G \kappa S) i.$$

Now if the term involving the variable i_s is to disappear, we must make the speed of a value n_1 such that

$$4 n_1 A G \kappa Z = r_a + r_s,$$

which is the *first* equation of condition ; and gives us also,

$$n_1 = \frac{r_a + r_s}{Z} \frac{1}{4 A G \kappa},$$

or

$$\text{critical speed} = \frac{\text{net internal resistance}}{\text{number of shunt turns}} \times \text{a constant,}$$

as in previous cases. And we also have

$$4 n_1 A G \kappa = \frac{r_a + r_s}{Z}.$$

But if this condition is fulfilled, then

$$(r_a - 4 n_1 A G \kappa S) i = 0,$$

that is to say, either $(r_a - 4 n_1 A G \kappa S)$, or else i , is zero, and the other of the two is indeterminate. Now we know that i is not zero, and we know, moreover, that though in this particular expression i may be indeterminate, we can get a determinate expression at once by introducing a saturation term. Clearly then we must have as a *second* equation of condition,

$$r_a - 4 n_1 A G \kappa S = 0,$$

whence,

$$4 n_1 A G \kappa = \frac{r_a}{S}.$$

Comparing this with the previous value found for $4 n_1 A G \kappa$, we get

$$\frac{Z}{S} = \frac{r_a + r_s}{r_a} \quad [\text{XXXIX.}]$$

as the proportion to be observed between the number of shunt turns, and the number of series turns. Now we know that for good economy r_s should be at least 400 times r_a ; which shows that we are justified in regarding this arrangement as a shunt dynamo plus a few exciting coils in series. It will be profitable to compare this case with the compound dynamo as arranged to yield a constant potential at the terminals (see p. 246).

Case (iv.). (b) Long Shunt + Series-regulating Coils.—The connexions are same as Fig. 235, p. 312. The equations now become

$$E = 4 n A G \kappa Z i_s + 4 n A G \kappa S i_a,$$

$$E = r_s i_s + (r_a + r_m) i_a,$$

$$i_a = i_s + i;$$

whence

$$\left\{ 4 n A G \kappa (Z + S) - (r_s + r_a + r_m) \right\} i_s = \\ \left\{ (r_a + r_m) - 4 n A G \kappa S \right\} i,$$

giving, as in the paragraph above, at critical speed n_1 , two equations of condition and the result

$$\frac{Z}{S} = \frac{r_s}{r_a + r_m}. \quad [\text{XL.}]$$

Practical Determination of the Winding.

As in previous cases, two experiments, one made on short circuit, the other with a resistance R representing the usual working load of lamps in the circuit, will determine the winding.

Equations of Compound-wound Dynamos, deduced from the law of Saturation.

In all the preceding formulæ it has been frankly assumed that the saturation term might be neglected. This is not strictly true, for in practice the dynamo is worked at a point beyond that at which the magnetism is proportional to the number of ampère-turns of excitation. One consequence of this is that in the constant-potential machines a larger number of series-turns are required, in proportion to the shunt,

than is indicated in equation [XXVII.], p. 310. A Siemens' compound dynamo "g D₁₇" tested by Dr. Frölich gave the following values:—

$$\frac{Z}{S} = 17.7; \quad \frac{r_s + r_a}{r_a + r_m} = 61.9,$$

which by theory should be equal if the iron is quite unsaturated. These figures show that the formulæ require extending to take into account the case where, when the full current is on, the iron shows a less proportion of magnetism than at lower degrees of excitement. But the figures also show two other things: namely, that this dynamo was badly designed and of low efficiency. Unless the quantity and quality of the iron was insufficient, or unless the shunt and series coils were wound in the wrong place, there could be no such inequality between the two ratios. Further $r_s + r_a$ ought to have been some hundreds of times as great as $r_a + r_m$, if the dynamo was to have a high efficiency; whereas it was only 61.9 times as great.

If we introduce the saturation term, as was done for series machines on p. 278, and for shunt machines on p. 226, the expressions become very complicated. Omitting the intermediate steps, we get the following results for the potential at terminals.

Shunt and Series.

$$e = \frac{I}{\sigma} \left\{ 4 n A G \kappa \frac{R r_s}{R (r_a + r_s) + r_s r_a + r_a r_m + r_m r_s} - \frac{R r_s}{S r_s + Z (R + r_m)} \right\};$$

Series and Long-Shunt.

$$e = \frac{I}{\sigma} \left\{ 4 n A G \kappa \frac{R r_s}{R r_s + (r_a + r_m) (R + r_s)} - \frac{R r_s}{Z R + S (R + r_s)} \right\}.$$

These expressions are unmanageable without further assumptions.

Students desiring further information on compound winding of dynamos, are referred to a series of articles in the *Electrician*, in 1883, by Mr. Gisbert Kapp, and another in the *English Mechanic*, in 1884, by Mr. W. B. Esson, also to two articles by Mr. Esson in the *Electrician* of June 1885. Articles by M. Hospitalier in *L'Électricien*, and by Herr Uppenborn in the *Centralblatt für Elektrotechnik*, should also be consulted; and the student should above all read the series of papers published by Dr. Frölich in the *Elektrotechnische Zeitschrift* for 1885, and a still more remarkable paper by Professor Rücker in the *Philosophical Magazine* of June 1885. Some account of these is given in Appendix IV.

Economic Coefficient of any Compound Dynamo.

The following formula covers all the cases of self-regulating dynamos, provided the currents and resistances of all the separate parts of the circuits are known :—

$$\eta = \frac{\text{useful work}}{\text{total work}} = \frac{i^2 R}{i^2 R + i_a^2 r_a + i_m^2 r_m + i_s^2 r_s}. \quad [\text{XLI.}]$$

Here i_m and r_m stand respectively for the current in and the resistance of the main-circuit magnet coils ; and i_s and r_s for those of the shunt or separate coils. The value of η in the constant-potential compound dynamo is very constant, and is nearly the same for all values of R within the limits of working.

Dr. V. Pierre has recently published some rules concerning compound dynamos. Some of these points are already set forth in this chapter, but others are novel. He finds that η is greatest when r_a , r_m , and r_s are so proportioned that (r_a and r_m being as small as possible relatively to r_s), the external resistance R is a mean proportional between $r_a + r_m$ and $r_m + r_s$. Also, if R is given, η depends only on the ratios $r_a : r_s$ and $r_a + r_m : r_s$. The smaller the fraction $r_a + r_m : r_s$, the more thoroughly is the difference of potentials at the terminals independent of the variations of R .

CHAPTER XVIII.

ALTERNATE-CURRENT DYNAMOS.

IN all the alternate-current dynamos the electromotive-force rises and falls in a rapid periodic fashion, a wave of electricity being forced through the circuit first in one direction, then in the other, with very great rapidity. To calculate this rise and fall we must remember that the motions of the rotating coils are supposed to take place with a uniform speed, and that the induced electromotive-force will be proportional to the rate of change in the number of lines of force induced through the circuit. To get a complete account of the action we must take into consideration the number of lines of force *induced by the circuit on itself*.

Consider a simple loop of wire traversed by a current. Every portion of the loop will be surrounded by a whirl of lines of force similar to those of Fig. 9, and those belonging to the current in one-half of the loop tend to influence the current in the other half. Such influence or tendency of the current's lines of force to influence the other parts of the circuit is, however, only manifested when the strength of the current or the shape of the circuit is changing. We know that any increase in the number of lines of force that thread through a circuit (as, for example, by poking a magnet pole into it) tends to set up a current that will oppose the motion. Any increase in the strength of the current in the loop will increase the number of lines of force through the loop, and that increase will of itself tend to set up an opposing current. On the other hand, any decrease in the current in a circuit, by reducing the number of lines of force which thread through the circuit, tends to oppose the reduction of the current. A current, in fact, acts as if it had inertia, and tends to keep the number of its lines

of force constant. This inertia of the current in a circuit is also known as the induction of the circuit on itself, or, briefly its self-induction. The self-induction in a circuit, which, as we have seen, is the number of lines of force threaded through the circuit itself by the current flowing in it, is always made up of two factors. When discussing the earlier case of the induction of a current in a loop by rotating it in an external magnetic field we neglected self-induction and considered the number of lines of force which crossed the loop (which number we called N) as being the product of two factors, viz. the area A of the loop, and the intensity H of the magnetic field in which the loop was placed. In the case of self-induction the two factors will be different. The number of lines of force induced on itself by the current in a loop will be proportional to the strength of the current i . The number will, for a simple circular loop, be also proportional to the area of the loop. But for loops that are not circular, and for loops that consist of many turns, and for loops that have iron in them, a much more complicated investigation would be required than could be undertaken here if it were not for one fortunate circumstance. Suffice it to say that for a loop of many turns the coefficient of self-induction is proportional to the *square* of the number of turns. A loop of two turns is, for self-inductive purposes, equal to a single loop of four times the area. A loop of many turns, and with an iron core at its centre, acts, whatever its shape may be, simply as a larger loop. If we could find by experiment the area of the simple large circular loop which would for self-inductive purposes have the same effects, then it would be a simple matter to express the self-induction in terms of the current and the area only. As a matter of fact, the two factors chosen are current i , and a quantity symbolised by the letter L , and called "*the coefficient of self-induction*," which represents the number of lines of force which the circuit would possess or induce on itself if the current flowing in it were one "absolute unit." It follows at once that if a current of i units flow through a circuit whose coefficient of self-induction is L , the whole self-induction of the circuit will be equal to L times i ; and the product $L i$ will represent the

total number of lines of force belonging to the circuit itself. It will also be evident that if a current begins from strength 0 and grows until its strength is i , the *average* self-induction in the circuit will be $\frac{1}{2} L i$.

Returning now to the case of a loop of area A , placed in a field whose intensity is H at an angle θ (measured from the initial position as in Fig. 14, where it stands right across the field), we see that the expression assumed hitherto for the total number N of lines of force which cross it is incomplete. When we omit all account of self-induction, we may write

$$N = A H \cos \theta.$$

We now know that if there is a current i in the circuit, we ought to write the equation in full—

$$N = A H \cos \theta + L i. \quad [\text{XLII.}]$$

Our omission of the self-induction term in all the previous equations was only justifiable on the assumptions,—firstly, that the field magnets so overpowered the armature as to make the second term negligible; secondly, that the equations we obtained were the equations for *steady* currents.

Now we know that any variation in N will set up induced electromotive-force, and that at any moment the electromotive-force will have the value

$$E = - \frac{dN}{dt};$$

where we use the negative sign to show that an increase in N will produce an inverse or negative electromotive-force. We are obliged to take note henceforth of the signs of the various quantities. Any change in N , from whatever source arising, will set up electromotive-force. We cannot well alter A , the “equivalent area” of our armature, unless the armature be reduced to the ideal case of a single loop. H can be altered; though in most alternate-current machines, it is arranged that H , the intensity of the field, shall be constant while the dynamo is at work, the field magnets of the alternate-current

machine being separately excited by a constant current from a smaller dynamo, called the "exciter" (see Fig. 183, p. 211). Neither can we, while the dynamo is at work, alter L the coefficient of self-induction, as that depends on the size, shape, coiling, and coring of the armature. The only quantities that are really important in respect of the variations they will undergo—the only quantities whose variations contribute to the variations of N —are, then, θ and i . The angle of position θ varies from 0 to 2π (radians); that is to say, from 0° right round to 360° , and then recurs; and its cosine therefore fluctuates between 1 and -1 . The current i varies also from a certain maximum value $+i_{max.}$ to an equal negative value $-i_{max.}$. We will neglect all the variations of the other quantities, not because these variations would not be instructive—for that would be quite untrue—but because of their lesser practical importance. Then we have

$$E = -\frac{dN}{dt} = -\frac{d(AH \cos \theta + Li)}{dt}.$$

Now suppose that while the armature loop has turned through the angle θ , the time occupied—a small fraction of a second—is t . Also take T to represent the time taken for one revolution; so that if there were n revolutions per second, T will be $\frac{1}{n}$ of a second. Then obviously θ will be the $\frac{t}{T}$ part of a whole revolution, and as there are 2π radians in a circle, the angle expressed in radians will be

$$\theta = 2\pi \frac{t}{T}.$$

Inserting this value, and performing the differentiation, we get

$$E = \frac{2\pi AH}{T} \sin \frac{2\pi t}{T} - L \frac{di}{dt}. \quad [\text{XLIII.}]$$

Consider this equation carefully. It shows us that if there were an open circuit, so that there could be no i , then self-

induction would not come in at all. Also if the motion were so slow that the rate of change of i were inappreciable, then the second term might be neglected. The negative sign also indicates that that part of the electromotive-force which is due to self-induction opposes the other part. Suppose we pause for a moment to consider the case of slow motion, and neglect the self-induction term ; remember that $\frac{1}{T}$ is the same thing as n , and we get

$$E = 2 \pi n A H \sin \theta,$$

as we did long ago. Also, since the average value of the sine between 0° and 90° is $\frac{2}{\pi}$,* we get, as the average value of E ,

$$E \text{ (average)} = 4 n A H.$$

Also it is important to notice, that with slow rotation, if the resistance of the circuit be R , the current will be at any moment

$$i = 2 \pi \frac{A H}{R T} \sin \theta,$$

and the *average* value of the current

$$i \text{ (average)} = 4 \frac{A H}{R T}.$$

This average value of i being found, we are now able to entertain the case where the rotation is so quick that we must take in the self-induction term. Remember that $E = R i$; and we may write

$$R i = \frac{2 \pi A H}{T} \sin \frac{2 \pi t}{T} - L \frac{d i}{d t}.$$

* Or more strictly

$$\frac{1}{\theta} \int_0^\theta \sin \theta \, d\theta = \frac{1 - \cos \theta}{\theta},$$

whence, if $\theta = \frac{\pi}{2}$, the average is $\frac{2}{\pi}$.

Here is a differential equation requiring to be solved. Its solution is

$$i = \frac{2\pi A H}{T} \cdot \frac{\sin\left(\frac{2\pi t}{T} - \frac{2\pi \tau}{T}\right)}{\sqrt{\left(\frac{2\pi L}{T}\right)^2 + R^2}} + C \epsilon^{-\frac{R}{L}t};$$

or

$$i = \frac{2\pi A H}{T} \cdot \frac{\sin(\theta - \phi)}{\sqrt{\left(\frac{2\pi L}{T}\right)^2 + R^2}} + C \epsilon^{-\frac{R}{L}t}, \quad [\text{XLIV.}]$$

where ϕ is called the retardation or angle of lag, and is determined by the condition,

$$\frac{2\pi L}{R T} = \tan \phi = \tan \frac{2\pi \tau}{T}.$$

Here the symbol τ stands for the short interval corresponding to the time-retardation. The symbol ϵ is used here in its common mathematical sense to represent the number 2.7182 which is the base of the Napierian logarithms; it has nothing to do with the potential at the brushes, for which we happen to have used the same symbol elsewhere; and C is a constant of integration. It may be pointed out that of the two terms, the second may be neglected, because it relates only to the momentary growth of the current and dies out after a very short interval. The first of the two terms may also be written more simply. Remembering that $\frac{1}{T} = n$, we have

$$i = \frac{2\pi n A H}{\sqrt{\left(\frac{2\pi L}{T}\right)^2 + R^2}} \sin(\theta - \phi). \quad [\text{XLV.}]$$

This shows us that our current is virtually due to an electromotive-force of the value $2\pi n A H \sin(\theta - \phi)$, acting through a resistance of the value $\sqrt{\left(\frac{2\pi L}{T}\right)^2 + R^2}$. Now when there was no self-induction to take into account, the electromotive-force was (see p. 329) $2\pi n A H \sin \theta$, and the resistance simply R . The effect of self-induction is then to

retard the rise and fall of the current, so that it attains its maximum not when $\theta = 90^\circ$, but when $\theta = 90^\circ + \phi$, the latter symbol standing for the angle of lag. Looking at the value of

ϕ stated above, we see that its tangent is $\frac{2\pi L}{RT}$, or $2\pi n \frac{L}{R}$.

From this we learn that the retardation will increase with increased speed, and that it depends on the ratio between the self-induction and the resistance. There will be less lag therefore if the machine is so designed that it can be driven at a slow speed, and if the coefficient of self-induction is small compared with the resistance of the circuit. This indicates that the number of turns of the coils in the armature part should be kept as small as possible, and the magnetic field made enormously powerful: a rule which applies equally to continuous-current dynamos. It may also be noticed that the resistance is apparently increased from R to $\sqrt{(2\pi n L)^2 + R^2}$, the apparent increase depending both on speed and self-induction. Both speed and self-induction tend, therefore, to retard the oscillations of the electromotive-force, and to diminish the available amount of current. High speeds are, therefore, both mechanically and electrically bad.

To find the amount of work-per-second W done by the alternate-current machine, we may remember that

$$W = i^2 R \text{ (watts),}$$

and that for i^2 we must take the *average square** of the values of i . Since the average value of the *square* of the sine of any angle between 0° and 90° is $\frac{1}{2}$, we thus obtain

$$W = \frac{2 R \pi^2 A^2 H^2}{R^2 T^2 + 4 \pi^2 L^2},$$

and this expression, by a well-known algebraic formula, is a maximum for variations of R , when the two terms in its denominator are equal, that is when

$$R = \frac{2\pi L}{T} = 2n\pi L,$$

* The student will not forget that the average of the square of any variable quantity is different from (and greater than) the square of the average value of that same quantity.

or when the apparent resistance is such that its square is double the square of the real resistance. If the speed be such that this relation between resistance and self-induction is observed, then also $\tan \phi$ will = 1, and the retardation is 45° . These calculations are taken from the investigations of M. Joubert. In the preceding argument we have supposed the machine to consist of a simple armature rotating in a simple field. But in the majority of alternate-current machines (see pp. 208 to 222), the field is complex, and the coils of the armature pass a series of poles set symmetrically round a circle. In this case all the alternations of induction will recur several times in a revolution. If, as in the Siemens alternate-current dynamo, there are sixteen sets of poles, of which eight are N. poles, and the intermediate eight S. poles,

FIG. 239.

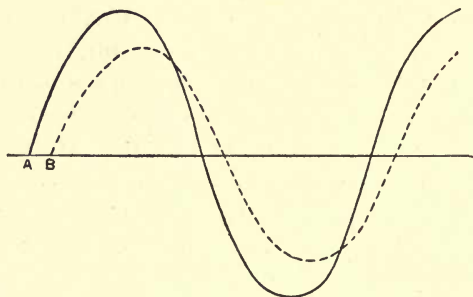

eight times in every revolution all the periodic fluctuations in the induction will recur. Notwithstanding this additional complication, the electromotive-force is found to follow the sine law fairly well, and therefore the preceding remarks still apply, provided we alter slightly the meaning of some of the symbols. In this case we must take n to represent the number of alternations per second, or eight times the number of revolutions per second. Also θ must be understood to be not the actual angle of position of the coil at any moment, but equal to the $\frac{t}{T}$ part of 2π ; T being the period, not of one revolution, but of *one alternation*.

Two of the most important of M. Joubert's results may be summed up in a diagram, Fig. 239. Let the curve A represent

the rise and fall of the induced current, as it would be if there were no self-induction. Then, since the effect of self-induction in the armature circuit is both to retard the rise and fall of the effective electromotive-force, and to increase the apparent resistance, it will have the effect of causing the current to rise and fall like the curve B, which has a smaller amplitude and is shifted along.

It may be remarked that mere retardation does not waste any of the power, nor does the mere introduction into the circuit of the opposing electromotive-forces of self-induction. If induction could be limited to these two effects, it would not be very prejudicial, it would simply make the machine act as a smaller machine. But, unfortunately, induction cannot be so limited. It occurs in every moving mass of metal in the armature. It occurs in the iron cores and even in the driving shaft. Also, in the continuous-current machines, it operates most prejudicially in the separate sections at the moment when they are short-circuited by passing the brushes, as explained in Chapter V., and at that moment the section that is short-circuited does not electrically belong to the circuit. All these inductive effects are attended with waste of power, because the currents generated in any conductor that does not form an actual part of the circuit simply degenerate into heat. A curious case occurred with Lontin's alternate-current machine, which had solid iron cores. When the coils of the armature were actually supplying the circuit, the currents were generated in them, and also to some extent in the cores. But when the circuit was open, so that no current could be generated in the coils, then currents were generated instead in the cores. Two results followed. Whenever the machine ran on an open circuit, the cores heated up to a destructive point, *and it required more power to drive the machine when it was doing no work than when it was lighting its maximum number of lamps.*

It has been shown by Dr. Hopkinson* that two alternate-

* *Proceedings of Inst. Civil Engineers*, April 1883, "Some Points in Electric Lighting," and *Journ. Soc. Teleg.-Eng. and Electr.*, vol. xiii. p. 496.

current machines, independently driven, so as to have the same periodic alternation and the same electromotive-force, cannot well be connected in series, otherwise they will tend to annul one another's currents: but that they may be coupled in parallel to one another (see Chapter XIX.).

It may be pointed out that owing to the great self-induction in the coils of any electro-dynamometer constructed of fine wire, it is impracticable to use such an instrument as a voltmeter for measuring the average difference of potential between two points of an alternate-current circuit, and, even if practicable, its indications would be false, as they would depend, not alone on the average potential, resistance, and self-induction, but also on the frequency of the alternations. In such cases it is better either to use a voltmeter depending on the stretching of a long thin wire heated by the current, completely enclosed in a tube having the same coefficient of thermal expansion, as suggested by Cardew, or else to apply a quadrant electrometer in the manner suggested in 1880 by M. Joubert. In this latter case the difficulty is to calibrate the scale-readings. This is best done by taking readings first with a continuous current on some portion of the circuit in which there is little or no self-induction, such as a straight thin wire, and comparing these readings with others obtained *on the same wire* when the alternate current is passed through it. Another method is to measure in a delicate calorimeter the heat evolved from a thin wire of high resistance used as a shunt.

The student is referred for further reading to Maxwell, *Phil. Mag.*, s. iv. vol. i. pp. 474-479, 1867; Mascart, *Journal de Physique*, t. vi. pp. 203 and 297; Meyer and Auerbach, *Wied. Ann.* Bd. viii. p. 494; Joubert, *Journal de Physique*, s. ii. t. ii. p. 293, 1883; and particularly to the paper of Dr. Hopkinson in Vol. XIII. of the *Journal of the Society of Telegraph-Engineers and Electricians* (with the discussion which followed).

CHAPTER XIX.

ON COUPLING TWO OR MORE DYNAMOS IN
ONE CIRCUIT.

IT is sometimes needful to couple two or more dynamos together so that they may supply to a circuit a larger quantity of electric energy than either could do singly. Thus it may occur that two dynamos, neither of which can safely carry a greater current than 10 ampères, are required to supply jointly a 20-ampère current: or two machines, each of which can run at 60 volts, are required to furnish an electromotive-force of 120 volts. Simple as these cases may seem, it is not so easy to carry them out, because it depends upon the construction of the machine, and especially upon the mode of excitation of the field magnets, whether they can be coupled together without interfering with each other's running. For it may, and does, occur that if not rightly arranged, one machine will absorb energy from the other and be driven as a motor instead of adding anything to the energy of the circuit.

Coupling Machines in Series.—Series-wound dynamos may be united in series with one another for the purpose of doubling the electromotive-force. Thus two Brush machines, each working at 10 ampères, and each capable of working 6 arc-lamps, may be joined in one circuit with 12 arc-lamps in series. The only needful precaution is to see that the + terminal of one machine is joined to the - terminal of the other, precisely as with cells of a battery. Shunt-wound dynamos may also be coupled in series, though the arrangement is not good unless the two shunt coils are also put in series with one another, so as to form one long shunt across the circuit. Compound-wound dynamos may be connected

in series with one another, provided the shunt parts of the two are connected as a single shunt, which may extend simply across the two armatures (double short-shunt), or may be a shunt to the external circuit (double long-shunt), or may be a mixture of long and short shunt. The same considerations apply to more than two machines. The coupling of alternate-current dynamos is considered later.

Coupling Dynamos in Parallel.—Two series dynamos cannot be coupled in parallel in a circuit without a slight re-arrangement, otherwise they interfere. For, suppose one of them to fall a little in speed, so that the electromotive-force of one machine is higher than that of the other machine with which it is in parallel. The machine having the higher electromotive-force will then drive a current in the wrong direction through the other machine, reversing the polarity of its field magnets and driving it as a motor. To obviate this, Gramme made the suggestion that the machines should be coupled in parallel at the brushes as well as at the terminals. This is shown in Fig. 240. The terminals T_1 T_1

FIG. 240.

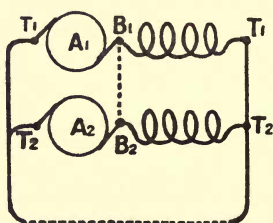

COUPLING OF TWO SERIES DYNAMOS IN PARALLEL.

of one machine are respectively joined to T_2 T_2 of the second machine, and a third wire joins B_1 with B_2 . If both machines are doing precisely equal work, there will be no current through the wire B_1 B_2 . If either machine falls behind, part of the current from the other machine will flow through B_1 B_2 and help to maintain the excitement of the magnets of the weaker machine. This effectually prevents reversals.

In the case of shunt machines there is no great difficulty in

running them in parallel, as indeed is done on a large scale with the eight dynamos of Edison's New York lighting station. The chief precaution to be taken is that, whenever an additional dynamo has to be switched into circuit, its field must be turned on, and it must be run at full speed before its armature is switched into connexion with the mains, otherwise the current from the mains will flow back through it and overpower the driving force.* Another method of coupling two series machines is to cause each to excite the other's field magnetism. This equalises the work between the two machines.

Coupling of Compound Dynamos in Parallel Circuit.—It has been stated on high authority that there is difficulty in working compound dynamo machines in parallel circuit, chiefly on account of the tendency possessed by any particular dynamo, which from any cause may temporarily be doing more work than the other, or others, in parallel circuit with it, to do still more work. It is stated that the exaltation of the field strength in such a case, due to the increase of the current traversing the series circuit, raises the electromotive-force of the machine, and causes it not only to do more than its due share of the work, but even to send current through the machine which is connected with it, which on account of its reduced electromotive-force becomes merely a part of the external circuit of the more powerful generator. There is no doubt that such an action may, and does, take place; and if unavoidable would render compound dynamos unsuitable for employment in many situations where their self-regulating powers must render them very useful. Mr. W. M. Mordey, to whom the author is indebted for the paragraphs which follow, has, however, pointed out that the difficulty may be overcome by connecting the parallel machines in such a way that not only are the shunt portions of the field magnets in parallel circuit, but the series circuits of the field magnets are also a shunt on one another; in other words,

* See Burstyn in the *Zeitschrift für angewandten Electricitätslehre*, 1881, p. 339, also Schellen (2nd Edition), p. 717.

by connecting the brushes, as well as the terminals, in parallel circuit, precisely as Gramme has done for series-wound machines. This mode of connexion is shown by the accompanying diagram (Fig. 241).

FIG. 241.

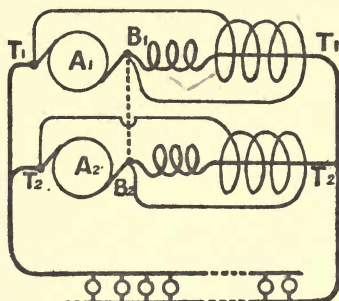

COUPLING OF TWO COMPOUND DYNAMOS IN PARALLEL.

A_1 A_2 are the armatures of two compound dynamos, T_1 T_1 and T_2 T_2 are the terminals; the wire B_1 B_2 acting in conjunction with the lead T_1 T_2 on the right, puts the armatures in parallel. When compound dynamos are connected in this way, they work quite satisfactorily, and exercise a considerable power of mutual adjustment. No necessity exists for driving by clutch or other "positive" connexion, ordinary belt driving being quite admissible, even when the belts have different percentages of slip—as may happen when they are not alike in tightness or character.

This mutual adjustment extends also to the case of slight differences in the sizes of the driving or driven pulleys where a single steam-engine or other motor is driving both or all of the machines, as well as to the case of separate engines being employed to drive separate machines. Of course the power of mutual adjustment must not be unduly strained by trusting to it to remedy inequalities of a serious nature.

The *rationale* of this adjustment is very simple. Taking the case of two exactly similar compound dynamos, connected as described above, it will be evident that as the shunt fields as well as the series fields are similar, and are respectively in

parallel circuit, the strength of the magnetic fields in the two dynamos will be alike. Then at the same speed their electromotive-forces will be equal, and they will absorb power equally, and will do equal work. But if from any cause one of them begin ever so slightly to lag behind the other in speed, its electromotive-force will become slightly lower, and it will absorb proportionately less power. The power being thus unequally distributed, the slow machine will tend to "race," while the fast one will tend to slow down. In this way the two dynamos will exercise a continual mutual adjustment, resulting in an equal division of the work between them.

And not only does this control exist with similar compound dynamos, but it may be relied on when the dynamos are unlike in size, power, and speed.

For instance, large and powerful machines may be worked in parallel circuit with smaller machines of various power, and each will do its proper share of the work.

In such a case, however, it is necessary to observe an additional precaution. Not only should the various dynamos be connected together, and to the external circuit, according to the plan described above, but such a proportion should be observed between the resistances of the series coils of the various connected machines that with the varying resistance of the external circuit the fall of potential in all the series coils may be similar. This is the case when the respective resistances of the series coils are inversely proportional to the full (or any equal proportion of the full) current intended to be generated by each dynamo.

When the resistances of the series fields of the parallel dynamos are thus inversely proportional to their currents, they will work satisfactorily in parallel circuit, and will possess the desired power of adjustment under any circumstances likely to arise in practice where ordinary care and skill are exercised.

The examination of the subject does not, of course, cover all the details of the actions connected with the working of compound dynamos in parallel circuit. A fuller inquiry

reveals a theoretical necessity for giving an exactly similar formation to the characteristic curves of all the connected machines. For practical purposes, however, the foregoing precautions will generally be found sufficient.

A method of connecting the machines, differing from the above, has been suggested. It is very similar to that which has been used, as mentioned above, with Gramme dynamos, consisting in employing the current of one machine A to excite the fields of a second machine B, while the current of B in turn is made to magnetise the fields of A. This is a perfectly practicable plan. With compound dynamos the series coils will alone require to be operated in this way. But there are some objections to such an arrangement. It can only be used when the dynamos are exact copies of each other, and is therefore out of the question when it is desired to utilise machines of various sizes and speeds to operate one circuit. Another objection is that with such a method it is always necessary to have at least two machines working, even when one is sufficient or more than sufficient for the requirements of the moment. In such a case when it may be desired to use one machine only, an arrangement of switches, always more or less unsatisfactory, must be adopted; while the making of the involved change could scarcely be effected, while the machines were working, without causing some interruption to the external current—an event, however momentary, to be carefully avoided in practical work. Again, an accident to one machine would incapacitate not only that machine, but also the second one which relied on the former for its field excitation.

The plan suggested by Mr. Mordey appears the more satisfactory one, and may be used in a lighting station, or in any situation where the varying requirements of the circuit render it desirable to bring additional machines into operation as the work increases, and to disconnect them from the mains as the demand for current falls off.

Coupling of Alternate-current Dynamos.—The chief principles governing the working of two or more alternate-current machines on the same circuit were experimentally

discovered by Wilde and described by him in a paper published in the *Philosophical Magazine* as far back as January 1869. In the midst of the labour devoted during succeeding years to the development of direct-current machines, Wilde's paper appears to have been quite forgotten, and it was not until Dr. Hopkinson independently took up the question and treated it in his lecture on "Electric Lighting" before the Institution of Civil Engineers in 1883, that attention was recalled to the subject. Dr. Hopkinson's method of procedure differed essentially from Wilde's in that he first deduced the behaviour of certain alternate-current dynamos under given conditions from theoretical considerations, and afterwards when opportunity occurred practically tested and verified his theoretical conclusions. In the following remarks we shall chiefly follow the line of argument used by Dr. Hopkinson.

In order that two or more alternate-current machines may work usefully together it is easily seen that the periodic time of the alternations of one machine must be exactly equal to or at least some very small multiple of the periodic time of the other. In practice only the first case has been carried out hitherto. Let us consider then the case of two exactly similar and equal machines A and B, running at the same speed so that the periodic time of the alternations of electromotive-force is the same in each machine. If the phase* of these two machines happens to be exactly the same and they are joined in series, then evidently the two electromotive-forces will be added together and the two machines will behave as one. But such a condition of affairs will be unstable; and if anything happens, such as a slip of one of the driving belts, to slightly alter the exact agreement of phase, the mutual electrical action will *tend* to increase the difference of phase instead of counteracting it. In Fig. 242 let the abscissæ measured along O X represent time and the vertical distances electromotive-force; then the curves A A A and B B B will represent the march of the alternations of electro-

* By the phase being the same we mean that the maximum of positive electromotive-force occurs at *exactly the same instant* in each machine. In any other case the phases differ.

motive-force in the two machines, the curve B B B which lies to the right of A A A being the one corresponding to the machine which lags behind the other in phase. The curve E E E, which is obtained by adding the ordinates of the other two curves, gives the resultant electromotive-force in the circuit at any instant. As shown on p. 331, the current will have the same periodic time as this last electromotive-force, but will lag behind it in phase. It may therefore be represented by the dotted curve I I I, in which the

FIG. 242.

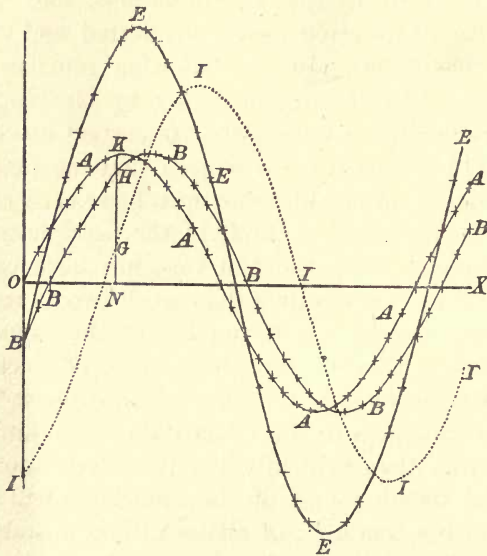

ordinates represent current instead of electromotive-force. Now the rate at which either machine is putting energy into the circuit at any instant is given by the product of the ordinate of I I at that instant by the ordinate of the electromotive-force curve for that machine at the same instant. Thus at the instant N the machine A is doing work at the rate $NK \times NG$, and the machine B at the rate $NA \times NG$. The meaning of the product being sometimes negative is that the machine is at that moment *absorbing*

energy from the circuit. The *total work* done by either machine during a complete alternation of current is obtained by summing up for the whole alternation the above products, each multiplied by the small interval of time dt during which it can be assumed to be constant. This is most readily summed analytically, but may be done graphically as follows. Plot a new set of curves in which the abscissæ are the same as before, but the ordinates are the products of electromotive-force and current for each machine for each instant of time. The result will somewhat resemble Fig. 243, which

FIG. 243.

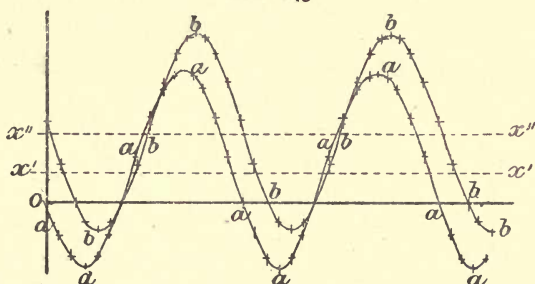

has been obtained thus from Fig. 242. Here the curve *a a a* refers to machine A, and *b b b* to machine B. The total work is obtained by measuring the area included between each curve and the axis of abscissæ, remembering that areas *below* the axis are to be reckoned as *negative* and arithmetically deducted. A moment's inspection of these curves will show that machine B is doing more work than machine A. In fact, the curve *a a a* is symmetrical about the horizontal axis $x'x'$, whereas the curve *b b b* is exactly similar to it, but is symmetrical about the higher axis $x''x''$, and therefore the positive area included between it and the axis of time is necessarily greater than that for the curve *a a a*. The *lagging* machine B has therefore most work thrown upon it and will consequently be retarded; thus the lag will be increased and the resultant electromotive-force and consequently the current thereby diminished. But that the tendency will still be towards

further lagging is shown in Figs. 244, 245, which are drawn in the same way and to the same scale as Figs. 242 and 243, but with increased lag of machine B. The lag will therefore

FIG. 244.

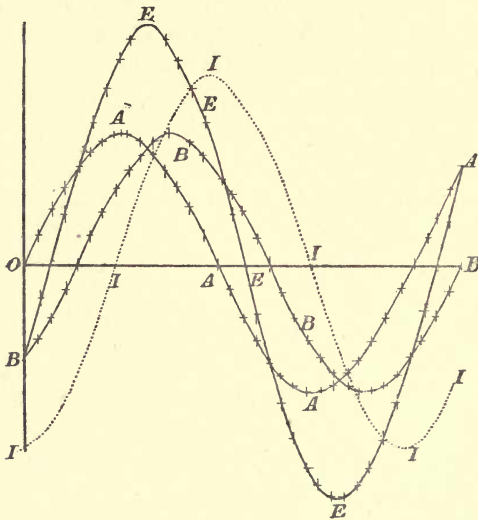
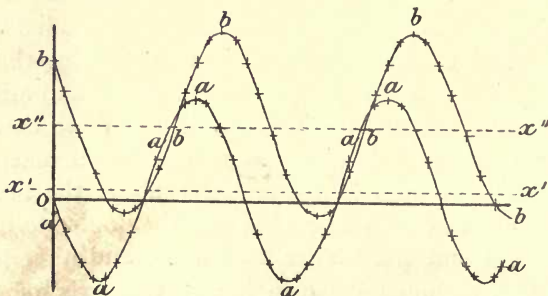

FIG. 245.



continue to increase, and the resultant electromotive-force and current to diminish, until such time as the electromotive-forces of the two machines differ in phase by exactly half a period and therefore directly oppose one another. In this case the

resultant electromotive-force will be continually zero and therefore no current will flow. Figs. 242 and 244 will be reduced to Fig. 246. This condition of affairs is stable, since if anything disturbs the exact opposition of phase the electrical action will tend to re-establish it.

FIG. 246.

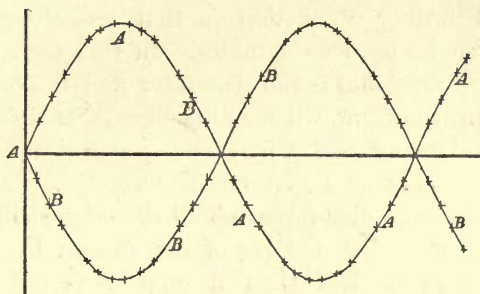

Another deduction from the above proof is that the machines will work perfectly well in parallel. For let $A a$ (Fig. 247) represent the collectors of machine A, and $B b$ those

FIG. 247.

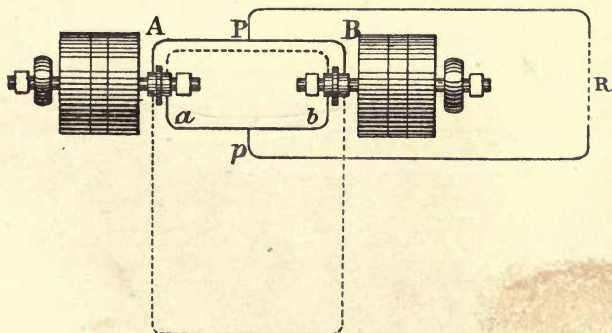

of machine B; then, as shown above, if these are joined, A to B , and a to b , as in the dotted lines of the figure, no current will flow, and if an arc lamp be placed in ba or BA it will not light up. In fact, A and B are both at their maximum

positive potential simultaneously, and at the same instant a and b are at their maximum negative potential. But this is exactly the state of affairs which will enable us to obtain a current through the circuit $P R p$ joined on to the wires $A a$ and $B b$ at the points P and p . With this arrangement the machines are working in parallel through the circuit $P R p$.

A still further deduction is that an alternate-current machine can be used as a motor. In this case machine B (the *lagging* machine) is the generator and is doing positive work upon the current, whereas machine A is doing negative work upon the current, *i. e.* is receiving energy therefrom, and is therefore acting as a motor. The conditions are that the lag of one electromotive-force behind the other shall be greater than a quarter period, the lag of the current being as usual either equal to or less than a quarter period behind the *resultant* electromotive-force. These statements are readily proved by re-drawing Figs. 244 and 245 under the above conditions. Here is the result.

FIG. 248.

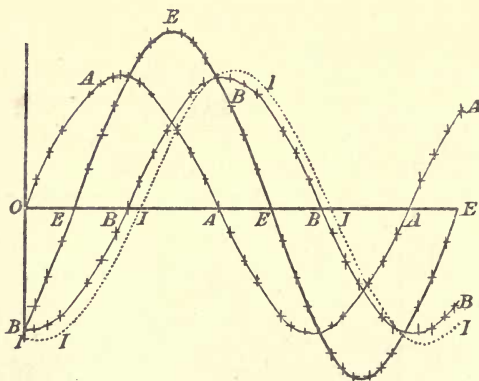

A more curious result still is that A can be driven as a motor by B even if its electromotive-force is greater than that of B . The proof is precisely the same as that just given, and is left for the student to work out for himself as an exercise.

All the curves given are for the same pair of machines running at the same speed throughout and with the same

FIG. 249.

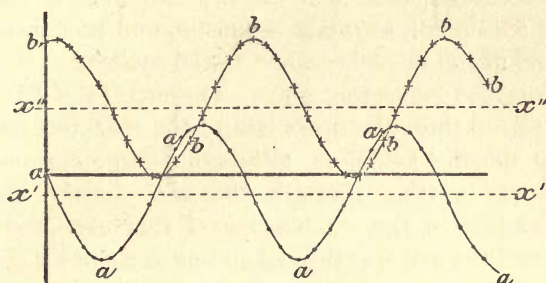

total resistance in the outer circuit. The lag of the current behind the resultant electromotive-force is therefore the same in each case (see p. 331).

It is scarcely necessary to say that the analytical proofs are in perfect accord with the graphic ones. A further result of the analytical method which is not so amenable to graphic treatment is that the energy wasted in Foucault currents in the iron when the machine is *short-circuited* is *less* than when it is running on *open circuit*, and therefore the machine will be cooler when used to generate a current than when allowed to run without doing so. This fact has long been well known in connection with alternating-current machines, and is well illustrated by the following experiments made by Dr. Hopkinson on a De Meritens machine :

Power given to machine as measured on belt	}	3·1	4·8	5·6	6·5	5·4
Electric power developed		0·7	3·4	4·3	5·7	3·4
Power lost		2·4	1·4	1·3	0·8	2·0
Mean current in ampères		7·7	38·6	51·7	73·6	151

It will be noticed that the loss of power is *least* with maximum load.

The above conclusions have been brought by Dr. Hopkinson and Prof. Adams to the test of experiment with the three large De Meritens machines used for the investigation on "Lighthouse Illuminants" at the South Foreland.

Two of the machines were connected in parallel and clutched together until they had attained their usual speed, when they were unclutched and each was driven by its own belt. The electromotive-force on open circuit remained steady, the machines continuing to rotate in unison, and was the same as that of one of the machines when tested by itself. No current passed along the connecting wires. The circuit P R ρ (Fig. 247) was now closed through an arc lamp; the machines continued to run as steadily as before, although a large current of 221 ampères was passing through the arc. Lastly, the lamp circuit was broken, the machines were short-circuited on one another, and the belt was thrown off one of them; it continued to run at the same steady speed, being driven as a motor by the current from the other machine. Other experiments were made, all confirming the theoretical conclusions. These results are summarised in the following table,* some photometric measurements of the arc light being included, as they are interesting in themselves.

	E. M. F. at the Arc.	Current.	Watts in the Arc.	Illumination.	
				By red light.	By blue light.
With one machine	33	175	5,775	8,000	16,000
With two machines .. {	35.5	275	9,750	13,500	23,200
	36	278	10,000		
With three machines .. {	37	300	11,100	16,000	31,000
	42 to 32	300	11,000		
	41 to 37	310	11,600		
With two machines driving the third as a motor }	52 to 41	240 to 285	12,000	17,300	

The governing of the speed of a motor running thus is perfect, but is accompanied by the serious disadvantages (a) that it can only run at one speed which depends on the speed of the generator, (b) that it has to be brought up to this speed by some extraneous means before it can be run as a motor at all, (c) that if any of the conditions (such for instance as the load being too great) are unfavourable it pulls up

* *Journal of Soc. Electr.-Eng. and Electricians*, vol. xiii. p. 524.

altogether. One way of bringing the motor up to the required speed is to drive it by a belt until this speed is attained and then throw the belt off. Another method is to start the generator slowly and turn the motor by hand until it falls into step with the generator ; the speed of the latter may then be increased, when it will be found that the motor also increases its speed, keeping pace exactly with the generator. This of course involves the serious disadvantage of having to stop or at least slow down the generator every time the motor has to be started.

CHAPTER XX.

THE GEOMETRICAL THEORY OF THE DYNAMO.

So many practical problems in the construction of dynamo-electric machines are in the present state of science solved by the use of graphic diagrams, and particularly by the use of certain curves technically called *characteristics*, that the method of constructing and using them forms an important part of the theory of the dynamo. And for certain practical purposes no other method is half so useful.

The characteristic curve stands indeed to the dynamo in a relation very similar to that in which the indicator diagram stands to the steam engine. As the mechanical engineer, by looking at the indicator diagram of a steam engine, can at once form an idea of the qualities of the engine, so the electrical engineer, by looking at the characteristic of the dynamo, can judge of the qualities and performance of the dynamo. The comparison may even be said to reach further than this.

The steam-engine indicator diagram serves two purposes, which though not unconnected with one another are yet distinct. When the scale on which the diagram is drawn is known, it gives direct information as to the horse-power at which the engine is working, depending on the total area enclosed by the curve, and quite irrespective of its form. But even though the actual scale be not known, the details of the form of the curve at its various points give very definite information to the engineer as to the working of the engine, the perfection of the exhaust, the setting of the valves, the efficiency of the cut-off, and the adequacy of the supply pipes and port-holes of the valves.

So also the characteristic curve of the dynamo may serve two functions. When the scale on which it is drawn is known

it tells the horse-power at which the dynamo works; nay can indicate at what horse-power the dynamo may be worked to the greatest profit. But even though the actual scale be not known, the details of the form of the curve afford definite information as to the conditions of the working of the machine; the degree of saturation of its magnets, the sufficiency of the field magnets in proportion to the armature, and the goodness of the design in several respects.

No treatise on dynamo-electric machinery would therefore be complete if it did not explain the nature and properties of the characteristic curve.

As a preliminary study, not without its purposes in the sequel, we will describe the curve which may be drawn to represent the speed of a magneto-electric machine and its electromotive-force. And as a second example of the use of curves we will give the curve which shows the relation between the magnetism of a simple electro-magnet and the current which excites its magnetism. The characteristic curves of the different kinds of dynamos under different conditions will then follow in their natural order.

Curve of Magneto-electric Machine.

Theory indicates that in a magneto-electric machine the electromotive-force induced in the armature should be exactly proportional to the speed of rotation, provided the magnetic field in which the armature rotates is of constant intensity. This is only true in practice if the current in the armature is kept constant by increasing the resistances of the circuit in proportion to the speed, because currents of different strength react unequally on the intensity of the field. In some experiments made by M. Joubert at different speeds the electromotive-force was measured by an absolute electrometer, which allowed no current whatever to pass. The only possible reactions were those due to possible eddy currents in the core: and the theoretical law was almost exactly fulfilled. The observations are given below, and plotted in Fig. 250, in which the straightness of the "curve" shows how nearly truly the theoretical condition was attained.

Speed	500	720	1070	revolutions per minute.
Electromotive-force	103	145	208	volts.

FIG. 250.

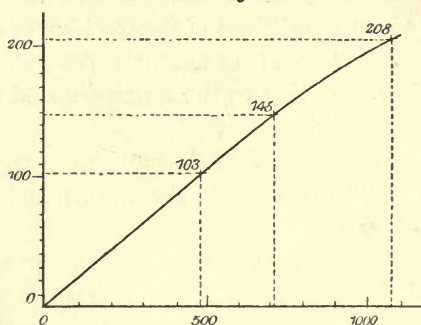

CURVE SHOWING RELATION BETWEEN SPEED AND ELECTROMOTIVE-FORCE.

The student may here with advantage study the lines given in Fig. 160, p. 190.

Saturation Curve of Electro-magnet.

To illustrate still further the use in general of curves we give the following investigation of the relation between the magnetism of a simple electro-magnet and the current which excites its magnetism. The apparatus which is required in addition to the electro-magnet comprises the following pieces: a sufficiently powerful battery; a reliable galvanometer or ampère-meter to measure the strength of the current; a set of adjustable resistances to vary the current; and a tangent magnetometer, or failing this a compass with a short needle having an index moving over a scale of degrees to serve as a magnetometer.

Fig. 251 shows in what manner these pieces may be arranged, the electro-magnet E being placed either due east or due west (magnetically) of the magnetometer, and "end-on" towards it, at a convenient distance. A number of observations are made with different strengths of current, and the corresponding magnetic forces are read off upon the magnetometer. For each particular value of the exciting

current there will correspond a certain value of the magnetic force. These may be plotted out in a graphic diagram, the strength of the current being plotted out horizontally

FIG. 251.

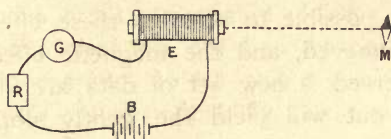

EXPERIMENT ON SATURATION OF ELECTRO-MAGNET.

and the magnetic forces vertically. The curve will take, in general, the form shown in Fig. 252, and is seen to consist of two parts—a part which rises at a more or less steep angle,

FIG. 252.

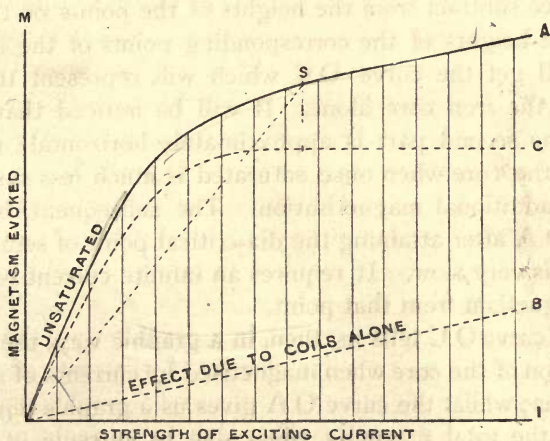

CURVE OF SATURATION OF ELECTRO-MAGNET.

and which for some distance continues nearly straight from the origin, and another part also nearly straight but inclined at a much smaller angle, the two parts being joined by a curved portion. The former part corresponds to the state of things when the iron core is unsaturated, the latter part to the state when the iron core is more than half saturated;

the curved intermediate portion corresponding to the intermediate state when the iron core is approaching saturation. In this curve two effects are in reality simultaneously blended : the effect of the magnetism of the iron core and the effect of the magnetic action of the coils through which the current is flowing. It is possible to separate these effects ; for if the iron core be removed, and the magnetic effect of the coils alone be observed, a new set of data are obtained which when plotted out will yield the gently sloping line O B. From this line two conclusions may be drawn. It slopes at a small angle, for (1) the magnetic effect of the coils is small compared with that of the iron core. It is quite straight, for (2) the magnetic effect of the current in the coil is exactly proportional to the strength of the current in the coil. Having thus found what part of the whole effect is due to the current in the coil alone, we can find what part is due to the core alone. For if we subtract from the heights of the points on the curve O A the heights of the corresponding points of the line O B, we shall get the curve O C which will represent the effect due to the iron core alone. It will be noticed that in this curve the second part is approximately horizontal : in other words, the core when once saturated is much less susceptible to any additional magnetisation. The subsequent rise of the curve O A after attaining the dia-critical point of semi-saturation S, is very slow. It requires an infinite current to double the magnetism from that point.

The curve O C tells us, then, in a graphic way, the state of saturation of the core when magnetised by currents of different strengths ; whilst the curve O A gives us a graphic representation of the total magnetic effect due to currents of various strengths.

It is possible to obtain the curve for the effect due to the core alone by a direct process, by introducing between the electro-magnet and the magnetometer a compensating coil to balance exactly that part of the total effect which is due to the direct magnetic action of the coils. Arrangements of this kind have indeed been made by Weber and by Hughes.

But in an actual dynamo machine we do not want to know what part of the effect is due separately to the core, because the field produced by the field magnets is due to core and coils acting together.

Moreover, in the actual dynamo the important thing to be considered in the magnetisation of the field magnets is not the strength of the exciting current, but the product of that strength into the number of turns of wire in the coil. The magnetising effect of a current of one ampère circulating 1000 times round the core is exactly equal to that of a current of 10 ampères circulating 100 times round the core, always provided the turns of the coil have the same average diameter in the two cases. The important thing to know, in considering the saturation or otherwise of the field magnets, is therefore the number of *ampère-turns* rather than the number of ampères.

The following set of experiments, made with a coil of exactly 500 turns on an iron core 10 centimetres long and 1 centimetre in diameter, illustrate the matter. The figures in the column marked M are the values of the magnetic moment as calculated from the deflexions produced in a magnetometer :—

Ampères.	Ampère-turns.	Magnetic Moment.
i	Si	M
0·00	0	128
0·22	110	1224
0·39	195	1920
0·98	490	4608
1·33	665	5924
3·65	1825	17472
4·6	2300	21088
9·2	4600	27875
9·4	4700	28250

The above values when plotted out give a saturation curve like Fig. 252.

Assuming (see further discussion in Appendix III.) that

these relations may be expressed by an equation of the form

$$M = G \kappa \frac{S i}{1 + \sigma S i},$$

we get as the approximate values of $G \kappa$ and of σ respectively

$$G \kappa = 14 \cdot 8, \quad \sigma = 0 \cdot 000319.$$

It will be noticed that the iron core possessed a slight residual magnetism, for even with no current in the coil there was a small magnetic moment. Whenever there is residual magnetism, the curve will start from a point above the origin O, not from the origin itself.

Characteristic Curves of Dynamos.

The suggestion to represent the properties of a dynamo machine by means of a characteristic curve is due to Dr. Hopkinson, who in 1879 described such curves to the Institution of Mechanical Engineers, and gave the curve of the Siemens dynamo reproduced in Fig. 253. The name of "characteristic" was assigned in 1881 by M. Marcel Deprez* to Hopkinson's curves; and the excellence of the name has been attested by its general adoption.

Dr. Hopkinson's object was to represent the relation subsisting between the electromotive-force and the current; he therefore constructed from observations a curve in which the abscissæ measured horizontally represent the number of ampères of current flowing, and the vertical ordinates the corresponding values of the electromotive-force. The following table (taken with some trifling modifications from Dr. Hopkinson's paper in the *Proceedings of the Institution of Mechanical Engineers*, 1879, p. 249) gives the observed values of i the strength of the current, and E the electromotive-force:—

* Vide *La Lumière Électrique*, Dec. 3, 1881; where, however, Deprez gives a method of observation that is open to the objection that it neglects the armature reactions.

EXPERIMENTS ON SIEMENS DYNAMO AT SPEED OF 720 REVOLUTIONS PER MINUTE.

Current (in amperes). <i>i</i>	Resistance (in ohms). <i>R</i>	Electromotive-force (in volts). <i>E</i>
0.0027	1025	2.72
0.48	8.3	3.95
1.45	5.33	7.73
16.8	4.07	68.4
18.2	3.88	70.6
24.8	3.205	79.5
26.8	3.025	81.1
32.2	2.62	84.4
34.5	2.43	83.8
37.1	2.28	84.6
42.0	2.08	87.4

FIG. 253.

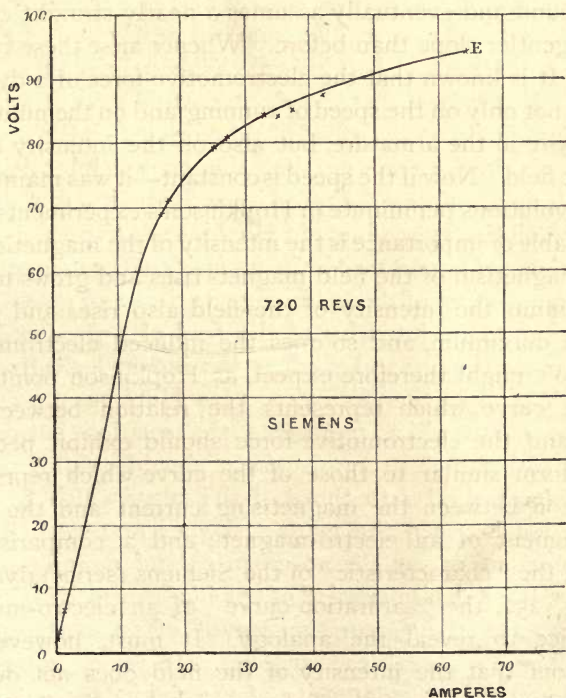

CHARACTERISTIC CURVE OF A SERIES DYNAMO.

It may be remarked that the electromotive-force E is the total electromotive-force generated in the machine, and must not be confounded with e the difference of potential between the terminals as measured by a voltmeter, or other similar instrument. In many cases we now prefer to plot e instead of E ; but that was not Hopkinson's original method. He determined E by measuring i and multiplying it by the total resistance of the circuit; for by Ohm's law $iR = E$. It should also be remarked that the dynamo was a "series dynamo," shunt-wound machines not having at that date come into vogue.

Before entering into other points, it may be worth while to consider the meaning of the curve. It begins at a point a little above the origin. This shows that there was a small amount of residual magnetism remaining permanently in the field magnets. The curve ascends at first at a steep angle, then curves round and eventually assumes a nearly straight course, but at a gentler slope than before. Whence arise these typical forms? It is known that the electromotive-force of a dynamo depends not only on the speed of running and on the number of coils of wire in the armature, but also on the intensity of the magnetic field. Now if the speed is constant—it was maintained at 720 revolutions per minute in Hopkinson's experiments—the only variable of importance is the intensity of the magnetic field. As the magnetism of the field magnets rises and grows toward its maximum, the intensity of the field also rises and grows toward a maximum, and so does the induced electromotive-force. We might therefore expect, as Hopkinson points out, that the curve which represents the relation between the current and the electromotive-force should exhibit peculiarities of form similar to those of the curve which represents the relation between the magnetising current and the magnetic moment of an electro-magnet; and a comparison of Fig. 253, the "characteristic" of the Siemens (series) dynamo, with Fig. 252, the "saturation curve" of an electro-magnet, will suffice to reveal the analogy. It must, however, be pointed out that the intensity of the field does not depend only on the strength of the field magnet, but is affected by

the current that is circulating in the armature coils ; and that further, the electromotive-force induced in the armature depends not only on the intensity of the field, but also on the direction of the lines of force in the field, and this is liable to be changed in consequence of the reaction between the field magnets and armature. Moreover, certain prejudicial effects arising from self-induction in the armature coils come into play with high speeds and strong currents, and prevent the electromotive-force from being proportional to the strength of the field. Hopkinson's statement, that the characteristic of the dynamo may also be taken to represent the intensity of the magnetic field, cannot therefore be accepted except with the reservation that it is true only when these reactions are negligibly small ; which is seldom the case.

It is possible for a dynamo to be made to draw its own characteristic by mechanically moving the pencil relatively to the paper (as in steam indicators) by means of two electromagnets, one of them being excited by the main current, the other being connected as a shunt to the terminals of the machine.

Dr. Hopkinson in the paper alluded to, and in a second one published in the *Proc. Inst. Mech. Engin.*, in April 1880, p. 266, pointed out a great many of the useful deductions to be drawn from a consideration of these curves. Some other deductions have been made by M. Marcel Deprez, for which the reader is referred to *La Lumière Électrique* of Jan. 5th, 1884. Dr. Frölich has also published several important papers on the subject in the *Elektrotechnische Zeitschrift* for 1881 and 1885. Dr. Hopkinson has returned to the subject in a lecture before the Institution of Civil Engineers, "On Some Points in Electric Lighting," April 1882.

Horse-power Characteristics.

As mentioned at the beginning of this chapter, if the characteristic curves are drawn to scale the activity of the dynamo may be read off from them in horse-power. The product of the current into the potential is proportional to the rate at which the electric energy is being evolved. The product of one volt of potential into one ampère of current is sometimes called one *volt-ampère*, and has also been called by the special name of one *watt*. One watt or volt-ampère is

equal to $\frac{1}{746}$ of a horse-power. To calculate the horse-power (electrical) evolved in the circuit when the dynamo is running at any particular speed, with a particular number of lamps in circuit, two measurements have ordinarily to be made—the volts of electromotive-force and the ampères of current. These must then be multiplied together and divided by 746 to obtain the horse-power. But if the characteristic of the dynamo at the particular speed be known, a reference to the curve will show at once what the electromotive-force is that corresponds to any particular current. For example, in the Siemens dynamo examined by Hopkinson, the characteristic of which is given in Fig. 253, p. 354, suppose the dynamo was working through such a resistance as to give 30 ampères when running at 720 revolutions, we see at once that the corresponding electromotive-force is 83. Hence

$$\frac{83 \times 30}{746} = 3.3 \text{ horse-power.}$$

Now to obviate such calculations we may plot out on the diagram some additional curves crossing the characteristics and mapping them out into equal values of horse-power. These "horse-power lines" are nothing else than a set of rectangular hyperbolas. For example, the 1-horse-power line will pass through all the points for which the product of volts and ampères is equal to 746. It will therefore pass through the point corresponding to 74.6 volts and 10 ampères; through 37.3 volts and 20 ampères; through 14.92 volts and 50 ampères, &c., because the products in each of these cases is equal to 746 watts or 1 horse-power. The 2-horse-power line will pass through points whose product values are equal to 746×2 , and the other lines in the same way. Fig. 254 shows the characteristic of the Siemens machine, reproduced from Fig. 253 above, but with the horse-power lines added.

In this case the volts plotted are the total electromotive-force, "E," of the dynamo, and therefore the horse-power represents the total electric energy converted per second in the circuit of the dynamo. If instead of E we had plotted the values of "e," the difference of potentials between

the terminals, we should have had a slightly different curve, representing the amount of electric energy appearing per second in the external circuit and available for useful purposes.

A horse-power characteristic of a shunt-wound dynamo is given further on, in Fig. 267.

In all cases where characteristics are plotted out for the purpose of comparing horse-power, the scale ought to be

FIG. 254.

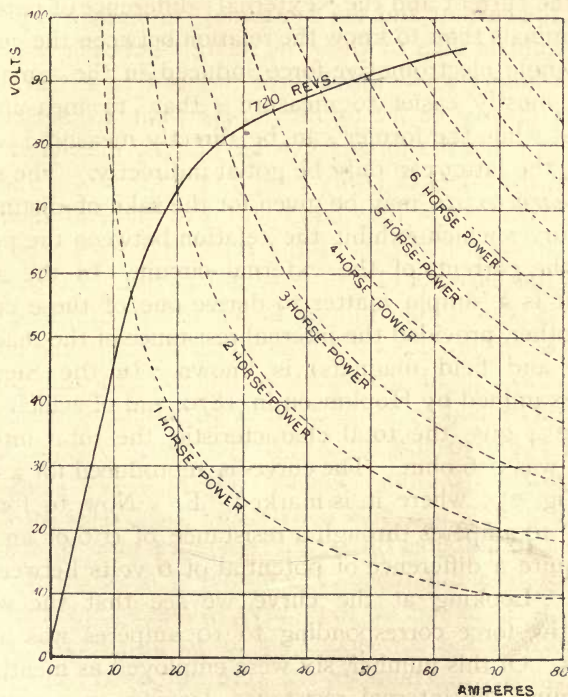

CHARACTERISTIC WITH HORSE-POWER LINES.

taken similarly to the above, that is to say, whatever length is taken vertically to represent 1 volt, an equal length ought to be taken horizontally to represent 1 ampère. If this rule is not observed—and, unfortunately, the importance of such a rule has not been observed in many cases hitherto—comparison between the characteristics of different machines is

not fair. It is possible to make a bad characteristic look good, and *vice versa*, by compressing or distending the scale in one of the two directions—for example by plotting the ampères on twice as large a scale as the volts. Uniformity in this respect is very desirable.

“External” Characteristics or Terminal Potential Curves.

For many purposes it is more useful to know the relation between the current and the “external” difference of potential at the terminals than to know the relation between the current and the whole electromotive-force induced in the armature: and it is mostly easier to measure e than to measure E ; seeing that while the former can be directly measured with a voltmeter, the latter can only be got at indirectly. The name *external characteristic* may be given for the sake of distinction to those curves which exhibit the relation between the potentials and the currents of the external circuit. In the series dynamo it is a simple matter to derive one of these curves from the other, provided the internal resistance of the machine (armature and field magnets) is known. In the Siemens dynamo examined by Hopkinson in 1879, and of which Figs. 253 and 254 give the total characteristic, the total internal resistance was 0.6 ohm. The curve is reproduced for a third time in Fig. 255, where it is marked “E.” Now to force a current of 10 ampères through a resistance of 0.6 of an ohm would require a difference of potential of 6 volts between its terminals. Looking at the curve, we see that the whole electromotive-force corresponding to 10 ampères was about 46.5 volts. Of this number, six were employed as mentioned in overcoming the internal resistance, leaving 40.5 volts as the available potential between terminals. Further, when the current was running at 50 ampères, there must have been no less than 30 volts employed in overcoming the internal resistance of 0.6 ohm; and as the value of E for this current is 90.5 volts, there remain 60.5 volts for e . There are now two ways open to us of representing these matters on our diagram. They are both shown in Fig. 255. The line J is drawn through

the origin, and through the values of 6 volts for 10 ampères and 30 volts for 50 ampères. (The tangent of the slope of the line J is equal to $6 \div 10 = 0.6$. We shall see later that this slope represents the internal resistance.) Then if the heights of the ordinates from the base line up to the line E represent total volts induced, and if the heights of the ordinates from the base line up to the line J represent the corresponding volts

FIG. 255.

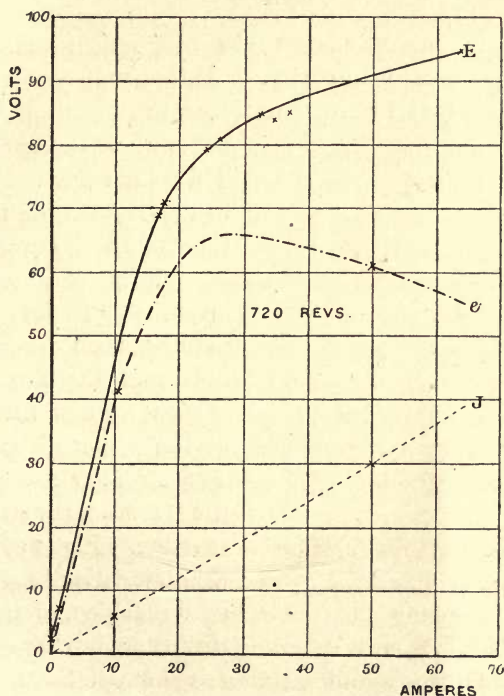

TOTAL AND EXTERNAL CHARACTERISTICS.

used in overcoming internal resistance, it follows that *the difference of potentials at the terminals will be represented by the differences of the ordinates between the lines J and E*. This is the first way of representing those differences of potential. The second way is to cut off from the tops of the ordinates portions equal to those of the line J. This amounts to sub-

tracting the internal volts, which as shown in the algebraic theory are equal to $i(r_a + r_m)$, from E , and so obtaining the values of e . These are plotted out in the curve marked "e" in the figure; and as this curve represents the available electromotive-force in the external circuit it obtains the name of external characteristic or terminal potential curve.

Characteristic of Magneto Machine, and of Separately-excited Dynamo.

In the magneto-dynamo the magnetism of the steel magnets is a fixed quantity. This has given rise to a common idea that in such machines the electromotive-force depends on the speed alone. This is not true. For owing to the reaction of the armature when a current circulates in its coils, the effective intensity of the magnetic field between the field magnets and the armature diminishes when the currents in the armature are strong. The stronger the current in the armature the stronger the reaction. Fig. 256 gives the reaction.

FIG. 256.

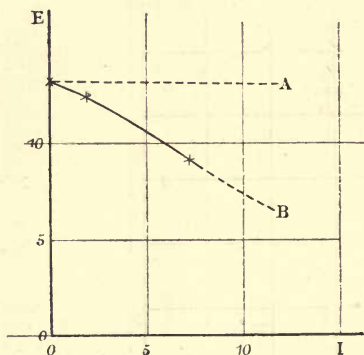

CHARACTERISTIC OF MAGNETO MACHINE.

Fig. 256 gives the characteristic of a small magneto machine, of the laboratory type, having a Gramme ring. It was capable of lighting two small Swan lamps of about 5 candle-power. On open circuit the electromotive-force was 13.1 volts at a speed of 1400 revolutions per minute. The value of E fell from 13.1 to 12.4 volts when a current of 1.8 ampères was taken from the machine; and when it was short-circuited to give 6.1 ampères, the value of E fell to 9.2 volts.

The reaction of the armature current was here very strongly marked. Were there no reaction the characteristic

would follow the dotted line to A instead of dropping down to B.

It ought not to be forgotten that beside the prejudicial reactions in the magnetic field there are prejudicial reactions in the armature coils themselves, due to self-induction between those parts of the coils in which the current is increasing or decreasing in strength and those in which a steady current is flowing.

The characteristics of separately-excited dynamos exhibit a similar decline in the electromotive-force; and the reasons are exactly similar. A careful study of these machines

has lately been made by Mr. W. B. Esson,* who gives the following curve for a separately-excited dynamo having a modified Pacinotti ring armature. The line E (Fig. 257) represents the total electromotive-force if there were no reactions. The line ϵ represents the values of the potential between the brushes of the machine (called ϵ in this book in contradistinction to E the whole electromotive-force) as it would be if there were no reaction. The curved line B gives the actually-observed values of ϵ when different currents were taken from the machine.

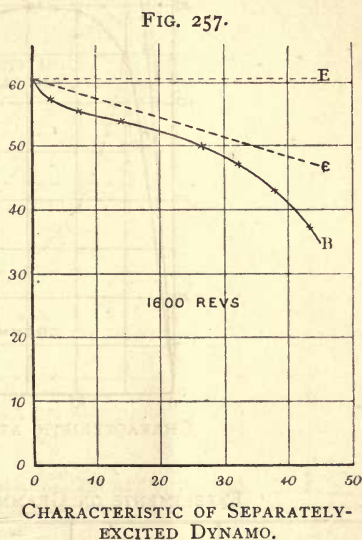

Characteristics of Series Dynamo.

The Siemens dynamo of which the characteristic is given in Fig. 253 was a series dynamo. For the sake of comparison the characteristic is given in Fig. 258 of an "A" Gramme

* *Electrical Review*, vol. xiv. p. 303, April 1884. See also papers by M. Marcel Deprez, *Comptes Rendus*, xciv., 1882, pp. 15 and 86.

FIG. 258.

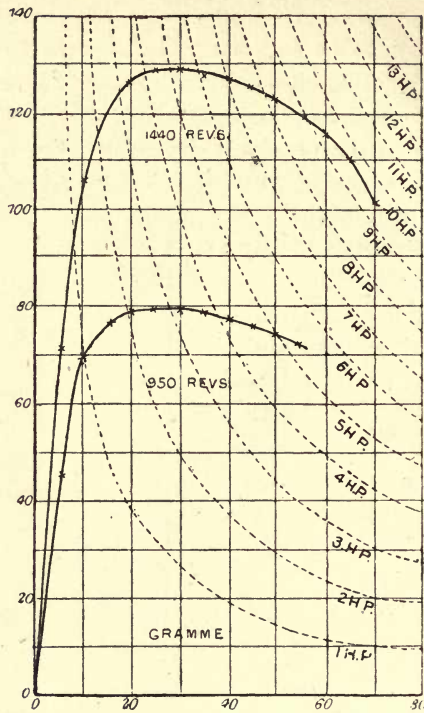

CHARACTERISTIC AT DIFFERENT SPEEDS.

EXPERIMENTS ON GRAMME SERIES-WOUND DYNAMO.

Current (in ampères).	Electromotive-force (in volts).	
	Speed 1440.	Speed 950.
5	72	45
10	107	70
15	122	77
20	127	79
25	129	79
30	128	79
35	128	79
40	127	78
45	125	76
50	123	74
55	120	72
60	116	..
65	110	..
70	101	..

machine also wound in series. This machine had, when measured by M. Marcel Deprez, 0.41 ohm resistance in the armature coils and 0.61 ohm in the coils of the field magnets. Two characteristics are given ; one corresponding to a speed of 1440, the other to a speed of 950 revolutions per minute. The horse-power lines are shown in dot also. The figures are given in the preceding table.

In the series dynamo the magnetisation of the magnets increases with the current, and therefore, at first the electromotive-force increases also, giving the first straight portion of the curve. As the magnets approach saturation the curve turns, and, as the reactions due to the current in the armature now become of relatively great importance, flattens itself and ultimately turns down again.

One more curve of a series-wound dynamo is given in Fig. 259. This is a small Brush machine (intended to supply a single arc light), of the old pattern with solid iron ring, in which, owing to the peculiar arrangement of the coils (see p. 184), the reactions of the armature make themselves known by a very extraordinary down-bending of the characteristic. It will be noticed that the maximum horse-power of this small machine is $1\frac{3}{4}$ horse; and that this value is only obtained when the reactions have already set in. In the former edition of this work this circumstance was alluded to in terms which were needlessly condemnatory. The remarkable diminution in the electromotive-force which takes place when the machine is so treated as to demand from it an output which it was never intended to give, is in practice a real advantage. Should the machine be accidentally short-circuited while running, the reactions of the armature prevent the production of an injuriously large current, which might overheat the coils.

FIG. 259.

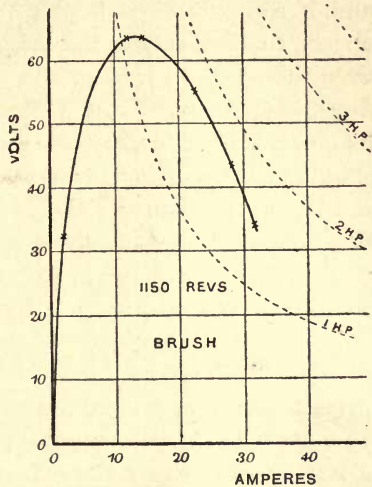

ABNORMAL CHARACTERISTIC.

Relation of Characteristic to Speed.

We know that the electromotive-force generated in a rotating coil or armature, would be strictly proportional to the intensity of the magnetic field, were it not for the reactions of the current in the armature. Now in a series dynamo, the intensity of the field depends on the strength of the current ; and, if the current is kept constant (by adjusting the resistances), the intensity of the magnetic field will also be constant even though the speed of the armature be varied. If therefore the characteristic of a machine be known at any speed, its characteristic for any other speed can be found by the very simple process of increasing the ordinates of the curve in a similar proportion. Take, for example, the case of the Gramme dynamo, of which a characteristic at the speed of 950 revolutions is given in Fig. 258. The characteristic at 1440 could be calculated from it by increasing the ordinates in the proportion of $\frac{1440}{950}$. Thus we see from the lower curve that when the current was 20 ampères the electromotive-force was 79 volts. Then $79 \times 1440 \div 950 = 119.7$ volts. The actual electromotive-force observed at the speed of 1440 and with current at 20 ampères was 127 volts. There is a slight discrepancy here ; and indeed always ; for dynamo machines behave invariably as if a certain number of the revolutions did not count electrically. If the number of "dead turns" were here reckoned as 140, the number of volts calculated by theory would agree very exactly with that observed.

Resistance in the Characteristic.

In the characteristic we have volts plotted vertically and ampères horizontally. Now by Ohm's law, volts divided by ampères give ohms. How can this be represented in the characteristic? Suppose, for example, it is required to represent the resistance of the circuit corresponding to some particular current. Let Fig. 260 be the characteristic of the dynamo in question, and it is desired to know

what is the resistance corresponding to the state of things at the point marked P. Draw the vertical ordinate PM, and join P to the origin O. The line PO has a certain slope, and the angle of its slope is POM. Now PM is equal to the electromotive-force under consideration, and OM is the current. Therefore, by Ohm's law,

$$\text{Resistance} = \frac{\text{electromotive-force}}{\text{current}} = \frac{PM}{OM};$$

but

$$\frac{PM}{OM} = \tan POM;$$

therefore the resistance = $\tan POM$. Put into words, this is:—*The resistance corresponding to any point on the characteristic is represented in the characteristic by the trigonometrical tangent of the angle made by joining the point to the origin.*

An easy way of reckoning these tangents is shown in Fig. 260. At the point on the horizontal line corresponding to 10 ampères erect a vertical line. A line drawn from the origin at an angle whose tangent is = 1 (namely 45°) would cross this vertical line at a point opposite the 10-volt mark. This point may then be called 1 ohm, and equal

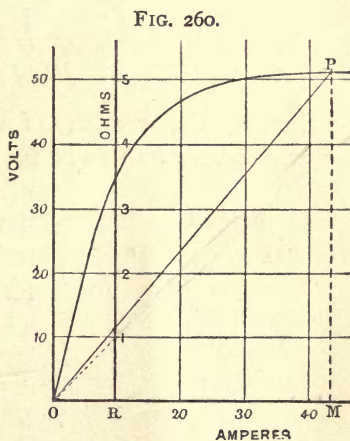

METHOD OF REPRESENTING
RESISTANCE GRAPHICALLY.

distances measured off on this line will constitute it a scale of resistances. In Fig. 260 the resistance corresponding to point P of the characteristic is seen to be about 1.2 ohms on the scale of resistances. Now P is placed at 51.3 volts, and the current is 43.2 ampères. Dividing one by the other, we get 1.18 ohms. Such calculations are then obviated by the graphic construction.

If in the actual dynamo the resistance of the circuit were gradually increased, we should have the point P displaced along the curve backwards towards the origin, the volts and ampères both falling off, and the steepness of the line OP increasing. When OP arrived at a certain steepness it would practically form a tangent to that part of the characteristic which is nearly straight, and then any very small increase in the resistance would cause the dynamo to lose its magnetism, from lack of current to magnetise the magnets. The resistance may be similarly represented on the characteristics of shunt dynamos (see p. 267); but in this case if the characteristic is drawn for the external current and the external difference of potential, then the resistance so represented will be the external resistance.

Relation of Characteristic to Winding of Armature and Field Magnets.

Suppose the armature of a machine to be re-wound with a larger number of turns of proportionally thinner wire. What will be the result when rotated at the same speed as before? The resistance will be increased somewhat, and the electromotive-force also will be higher. Let Fig. 261 represent the characteristic of the machine as it was when there were N turns of wire on the armature. How must it be drawn when the number is increased to N' ? Let P represent a point corresponding to a certain strength of current C . Taking the new armature, let the external resistance be varied until C once more comes to the same value. The magnets are now magnetised exactly as strongly as before; but there are N' turns of wire cutting the lines of magnetic force instead of N .

FIG. 261.

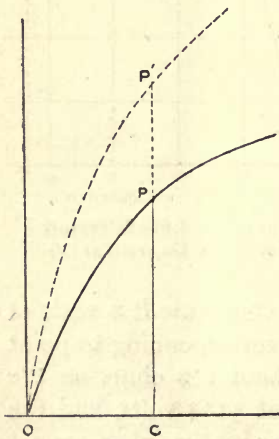

The electromotive-force will therefore also be greater in the proportion of $\frac{N'}{N}$. Draw therefore $P' C$ so as to have the proportion $P' C : P C :: N' : N$. All other points on the new characteristic can be obtained by similarly enlarging the ordinates in the same ratio.

It will be evident from this that increasing the number of turns of wire in the armature has the same effect as increasing the speed of driving. This shows that *slow speed* dynamos (as required for use on ships, &c.) may be made to give the requisite electromotive-force provided the number of turns of wire be relatively increased. This involves, however, a sacrifice of economy because of the increase of resistance in the armature.

The effect of altering the number of turns of wire on the field magnets can also be traced out on the characteristic diagram. Suppose the number of turns in the magnetising coil be S , and that we re-wind the machine, increasing the number to S' turns. What will the result be? In this case we shall get the same electromotive-force when driving at the same speed as before, provided the magnets be equally magnetised. But if the current goes S' times round instead of S we shall want a current only

$\frac{S}{S'}$ as strong as before, to produce the same magnetisation. To get the new characteristic then (see Fig. 262) draw $P E$ horizontally. $P E = C O =$ the current corresponding to electromotive-force E . Find P' such that $P' E : P E :: S : S'$; then the new characteristic will pass through P' . Similarly all other

points of the new characteristic may be determined by reducing their abscissæ in a similar proportion.

It must be noted that these two processes are not admissible for the characteristics of shunt-wound machines.

FIG. 262.

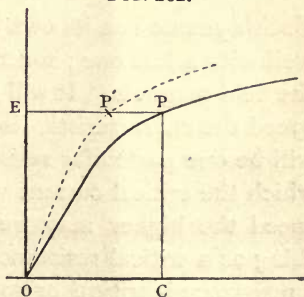

Critical Current of Dynamo.

From the fact that the characteristics for different speeds differ only in the relative scale of the ordinates, an important consequence may be deduced. The first part of every characteristic for any speed is nearly straight up to a point

FIG. 263.

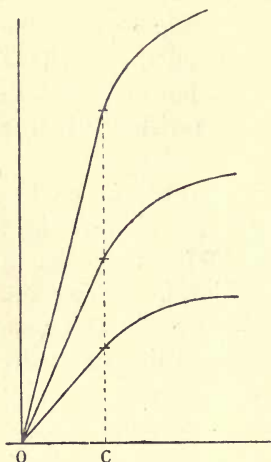

where for that speed the electromotive-force is nearly two-thirds of its maximum value. When the current is such that the electromotive-force has attained to this value, any very small change either in the speed of the engine or in the resistance of the circuit produces a great change in the electromotive-force, and therefore in the current; therefore, since this critical case occurs always with the same current (see Fig. 263), this current—corresponding to the point on all the curves where the straight line begins to turn, may be called the “critical current” of the dynamo.

Each dynamo has its own critical current, and it will not work well with a less one; for a less one will not adequately excite the field magnets. It will further be seen that since with each speed the characteristic rises with a corresponding slope, there will be one particular resistance at each value of the speed, at which the critical current will be obtained, and the higher the speed the higher may be the resistance. There is no such thing as a critical resistance in a series dynamo: for whether a resistance is critical or not depends upon the speed. *Neither is there any such thing per se as a critical speed for a series dynamo*; for whether the speed is critical or not depends on the resistance of the circuit.

Applications of Characteristics.

The following examples of the further use of characteristics are taken from Dr. Hopkinson's paper in the *Proc. Inst. Mech. Engin.* for April 1880.

To Determine Lowest Possible Speed of Dynamo running an Arc Lamp.

It appears that with the ordinary carbons, and at ordinary atmospheric pressure, no arc can exist with a less difference of potential than about 20 volts; and that in ordinary work, with an arc about $\frac{1}{4}$ inch long, the difference of potential is from 30 to 50 volts. Assuming the former result, about 20 volts, for the difference of potential, the use of the curve of electromotive-forces may be illustrated by determining the lowest speed at which a given machine can run and yet be capable of producing a short arc. Taking O as the origin of co-ordinates (Fig. 264), set off

FIG. 264.

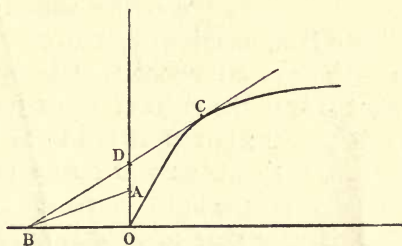

upon the axis of ordinates the distance O A equal to 20 volts; draw A B to intersect at B the negative prolongation of the axis of abscissæ, so that the ratio $\frac{OA}{OB}$ may represent the necessary metallic resistance of the circuit. Through the point B thus obtained draw a tangent to the curve touching it at C, and cutting O A in D. Then the speed of the machine, corresponding to the particular curve employed, must be diminished in the ratio $\frac{OD}{OA}$, in order that an exceedingly small arc may be just possible.

Use of Characteristic to Explain Instability of Arc Light.

The curve may also be employed to put into a somewhat different form the explanation given by Dr. Siemens at the Royal Society respecting the occasional instability of the

electric light as produced by ordinary dynamo-electric machines. The operation of all ordinary regulators is to part the carbons when the current is greater than a certain amount and to close them when it is less; initially the carbons are in contact. Through the origin O (Fig. 265), draw the straight line OA , inclined at the angle representing the

FIG. 265.

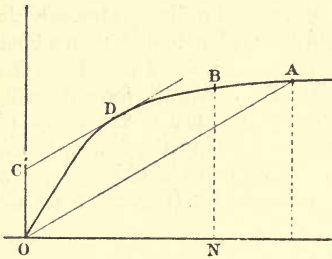

resistances of the circuit other than the arc, and meeting the curve at A . The abscissa of the point A represents the current which will pass if the lamp be prevented from operating. Let ON represent the current to which the lamp is adjusted; then if the abscissa of A be greater than ON , the carbons will part. Through N draw the ordinate BN , meeting the curve in the point B ; and parallel to OA draw a tangent CD , touching the curve at D . If the point B is to the right of D , or further from the origin, the arc will persist; but if B is to the left of D , or nearer to the origin, the carbons will go on parting till the current suddenly fails and the light goes out. If B , although to the right of D , is very near to it, a very small reduction in the speed of the machine will suffice to extinguish the light.

Relation of Characteristic to Size of Machine.

Suppose that a certain dynamo of a given construction has for its characteristic the curve Oa (Fig. 266). What will be the characteristic of a dynamo built of precisely the same type, but with all its linear dimensions doubled? The surfaces will be four times as great, the volume and weight eight times as great. There will be the same number of turns of wire, but the length will be doubled and the cross-section quadrupled, and therefore the internal resistances will be halved. If the resistances were adjusted so as to give the same current as

before, the new machine would have only half the intensity of field of the small one. But if adjusted to give the same intensity of field as before, the current will be doubled.

Now as the area of the rotating coils is increased fourfold, there will be four times as many lines of force cut (at the same speed), and therefore the electromotive-force will be four times as great. But we only wanted the current doubled. That is

FIG. 266.

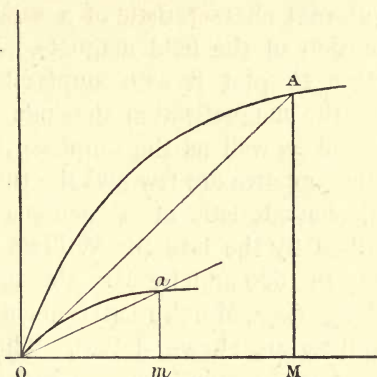

to say, the resistance will have to be doubled if the field is to be of same intensity. To represent this state of things, take the point a on the characteristic of the small machine, and draw the ordinate $a m$. Draw $O M$, double $O m$, and at M erect an ordinate $A M$ four times the length of $a m$. The new characteristic will pass through A . Also the resistance—the slope of $O A$ —will be double that of $O a$. The points a and A are similar points with respect to the saturation of the iron of the magnets; and it is this which determines the practical limits to the economic working of a dynamo of given type at a given speed. Hence we see, with quadrupled electromotive-force and doubled current, the electric energy evolved per second will be eight times as great as with the smaller machine when worked up to an equal saturation limit. These points may be compared with the discussion of the relation of size to efficiency on p. 72.

Characteristic of Shunt Dynamo.

For the shunt dynamo there are two separate characteristics; the *external characteristic*, in which the quantities plotted are the ampères of current in the external circuit and the volts of potential between terminals; and the *internal characteristic*, in which the volts and ampères of the shunt circuit are plotted. The internal characteristic of the shunt dynamo is quite similar to the external characteristic of a series dynamo, and shows the saturation of the field magnets. For many purposes it is better to plot it with ampère-turns instead of ampères, because the magnetisation depends on the number of turns in the coil as well as the ampères, and because in shunt magnets the ampères are few and the turns many.

The external characteristic of a Siemens shunt dynamo (the same described by the late Sir William Siemens before the Royal Society in 1880 and by Mr. Alexander Siemens in the *Journ. Soc. Teleg. Eng.*, March 1880) is given in Fig. 267, and the horse-power lines are shown dotted. The utmost power of this machine at 630 revolutions was just under 2 horse-power with a current of 30 ampères, and an electromotive-force of 47·5 volts.

The curve of the shunt dynamo is curiously different from that of the series dynamo. It begins with a straight or nearly straight portion, which turns up in a curve, and eventually returns nearly horizontally to the axis of electromotive-force. The straight portion represents the unstable state when the shunt current is less than its true critical value. The critical external current, if it can be so called, is that current for which the shunt begins to act fully, and in Fig. 267 is about 30 ampères. From this point the shunt current acts with great power and the electromotive-force here rises very rapidly. The slope of the line which constitutes the first portion of the characteristic represents the resistance which for the particular speed may be termed the critical resistance, and in this case is about 1 ohm. If the resistance of the external circuit becomes in

the least degree altered, the electromotive-force and current will alter enormously. Any less resistance will cause the magnets to lose their magnetism at once. Any greater resistance will at once run the electromotive-force up above the critical value—in this case about 30 or 31 volts. If the

FIG. 267.

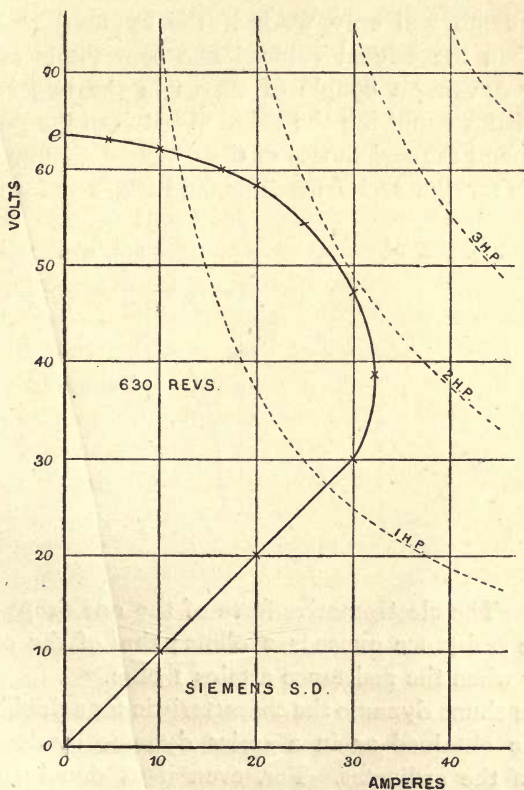

EXTERNAL CHARACTERISTIC OF SHUNT DYNAMO.

resistance be steadily increased (and the slope of the line from O to the curve be increased in steepness) the electromotive-force will go on steadily augmenting, and become a maximum when the external resistance is infinite, that is to say when the circuit is completely opened and the shunt coils receive

the whole of the electromotive-force of the armature. It is instructive to contrast this curve with that of the series dynamo (Fig. 253). In the series dynamo also, the first part of the characteristic is a sloping line, and the tangent of the angle of its slope is also the critical resistance for the given speed. But the series dynamo will only work if the resistance of the external circuit is *less* than the critical value, and the shunt dynamo will only work if the external resistance is *greater* than the critical value. The contrast is even better shown by drawing a couple of curves in the two cases—not characteristics—showing the relation between the potential at terminals and the resistances of the external circuit. Fig. 268 shows this for the series machine, and Fig. 269 for the shunt

FIG. 268.

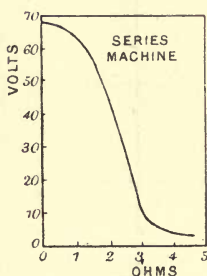
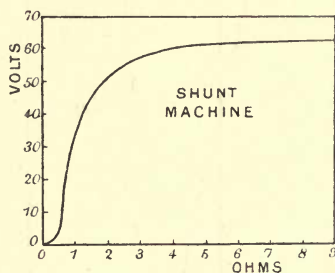

FIG. 269.



machine. The electromotive-force of the one drops suddenly when the resistance exceeds 2 ohms; that of the other rises suddenly when the resistance attains 1 ohm.

In the shunt dynamo the characteristic for a doubled speed cannot be obtained as in a series dynamo by doubling the heights of the ordinates. For, even if at double speed we adjust the external resistances so that the external current is the same as before, we do not get a double electromotive-force because we do not get the same current as before round the shunt-magnet circuit. And if, on the other hand, we adjust resistances so that we get the same shunt current as before, and therefore a double electromotive-force, we do not get the same external current as before. If, however, we alter

the external resistance, taking a larger current externally, so as to reduce the shunt current to its former value, the magnetisation will remain as before. In that case the double speed will produce very nearly a double electromotive-force; but the shunt potential may remain as before, the external current being nearly doubled. This is shown in Fig. 270, where $e a$ represents the external current in the first case, and $e A$ the external current in the second. $O A$ remains a straight line, but at this higher speed the slope is less. From this latter circumstance it may be foreseen that at higher

FIG. 270.

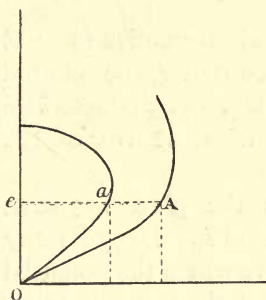
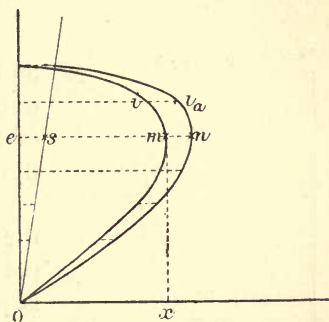

FIG. 271.



speeds the resistance may be reduced to a lower value before the critical state is reached at which the machine “unprimes” itself, i. e. discharges the magnetism from its field magnets.

Curve of Total Current in Armature.

In the shunt dynamo the current in the armature is equal to the sum of the currents in the external circuit and in the shunt circuit; or,

$$i_a = i + i_s.$$

A curve showing the relation between i_a and e is easily obtained. In Fig. 271 let the curve $O m i$ be the “external characteristic” at the given speed. Take any point on it m ; at that point the potential between terminals in volts is

measured by the length of mx or Oe , and the current in ampères is measured by the length Ox or em . Now draw the line sO at such an angle sOx that its tangent is equal to the resistance of the shunt. Then es represents the current that will run through the shunt when the potential is Oe volts. Add on to the end of em a piece mn equal to es ; then the whole line en represents the armature current i_a when the potential has the value Oe . A set of similar points may be found giving the new curve Oni_a required.

Total Characteristic of Shunt Dynamo.

FIG. 272.

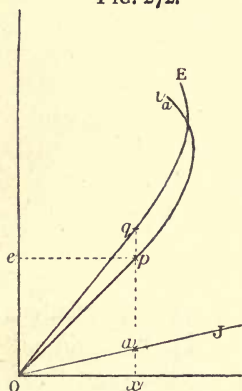

If the total electromotive-force E and the total current i_a be plotted out, we shall obtain the characteristic of the total electrical activity of the dynamo.

Draw, as in the preceding case, the curve for e and i_a . Let p be any point on the curve where the potential is px or Oe and the current ep or Ox . Then draw a line OJ at such an angle aOx that its tangent is equal to the resistance of the armature. Call the point where this cuts px , a . Then ax represents the number of volts required to drive the current Ox through the armature resistance. Add a piece qp equal to ax to the summit of the line px . Then the height qx represents the total electromotive-force E when the current i_a has the value represented by Ox .

Characteristic of Shunt Dynamo, with Permanent Magnetism.

If there is residual magnetism in the field magnets, there will be an electromotive-force induced, even before the shunt circuit is closed. In this case the characteristic would begin

at a point p a small distance above the origin (Fig. 273), and will then pass horizontally for a short distance, as in a magneto machine (see p. 364), until it reaches a point a determined by the line pa meeting the line OJ , drawn so that its slope represents the armature resistance. For if there be no resistance in the external circuit (it being short-circuited) the only resistance will be that of the armature. And as $O\phi$ represents the electromotive-force due to the permanent magnetism, (at the speed for which the curve is drawn) Ox will represent the current which this will generate in the armature when there is no other resistance. From the point a the curve will proceed as in the preceding case, but as if a were the origin instead of O .

FIG. 273.

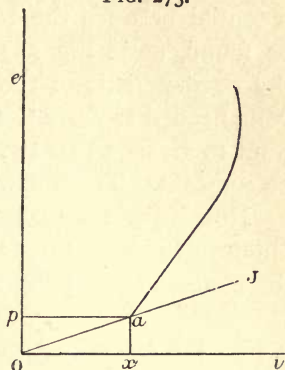

Characteristics of Self-regulating Dynamos.

In the chapter on the Algebraic Theory we consider all the combinations for effecting self-regulation. Those for obtaining a constant potential between the terminals consist of series dynamos *plus* an independent excitation of magnetism by permanent magnets or by independent batteries, or even by shunt circuits. Those for obtaining a constant current consist of shunt dynamos *plus* an independent excitation of magnetism by permanent magnets, or by independent batteries, or by main-circuit coils in series with the armature. The two cases can be represented very simply by means of characteristics. Two points must be kept in mind. *First*, the part of the characteristic corresponding to the unsaturated condition of the field magnets is in all cases *very nearly* a straight line. *Second*, the slope of this straight part of the characteristic can be altered at will by altering the speed of the machine.

Distribution at Constant Potential. (Compare p. 300.)

It was shown on p. 360, that the external difference of potential between the terminals of the series dynamo might be found, as in Fig. 255, by deducting from the ordinates of the characteristic of total electromotive-force the number of volts needed to drive the current through the armature. We want to arrange that the external difference of potential shall be constant. The following argument is due to Deprez.

Now if there is a permanent excitement of magnetism quite independent of that due to the main-circuit coils of the dynamo, the characteristic (Fig. 274) will not start from O, but from

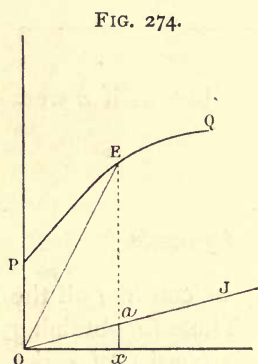

some point above it depending on the amount of independent magnetisation and on the speed. Let the starting point be P. O P is the electromotive-force between terminals when the main circuit is open, but there is no external current until the circuit is closed, and then the characteristic rises in the usual fashion from P to Q. Draw O J at the proper slope to represent the resistance of the armature and series coils together. Now consider a line O E drawn at such an

angle that the tangent of its slope represents the total resistance of the circuit at any particular moment. Then E x is the total electromotive-force at that moment, and a part of this equal to $a x$ will be employed in driving the current O x through the resistance of armature and series coils. The remaining part E a represents the difference of potentials between the terminals of the external circuit. So the problem resolves itself into this: how to arrange matters so that E a shall always be of the same length as O P, no matter how much or how little the line O E may slope. Clearly the only way to do this is so to arrange the speed of the dynamo that the part

from P to Q shall be parallel to O J. If the speed is reduced exactly to the right amount the inclination of the characteristic will be equal to that of the line O J. Then, as shown in Fig. 275, the potential between the terminals will be constant. It will be seen that this agrees with the deductions arrived at in the algebraic treatment of the question : namely, that the critical speed is proportional to the internal resistance ; and that the constant difference of potential $E\alpha$ is equal to that due to the independent magnetisation O P at the critical speed.

It should also be noticed that if the part of the characteristic be not straight, that is to say, if the field-magnet cores are not far from being saturated, the regulation cannot be perfect. If the line P Q be curved, then the potential for large currents will not be equal to that for small currents. If the practical process for winding the magnet coils as prescribed in the chapter on Algebraic Theory has been followed, and the coils have been wound so as to make e the requisite number of volts, both on open circuit (i. e. at O P), and at another point (say at Q J), when the dynamo is feeding its maximum load, then there will in general be a slightly greater potential for intermediate loads, owing to the slight convexity of the curve between P and Q.

The above argument holds good whether the independent excitation be due to permanent magnetism or to a combination with separately-exciting coils (see pp. 96 and 304), or to the machine being "compounded" by the addition of some shunt-regulating coils. In the latter case O P represents the potential at terminals due to shunt circuit alone.

The case of the "compound" dynamo is worth looking at from another point of view also. On p. 378 two curves—not characteristics—are given, showing the relation of electro-motive-force to external resistance in a series machine and in a shunt machine. One begins at a certain height and falls

FIG. 275.

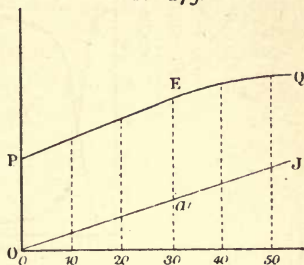

when the resistance has attained a certain value; the other begins low and rises when the resistance has attained a certain value. It is conceivable that if a dynamo were wound with both shunt and series coils so that each worked up to the same potential at the same speed, and so proportioned that the number of ohms at which one fell should be the same as

FIG. 276.

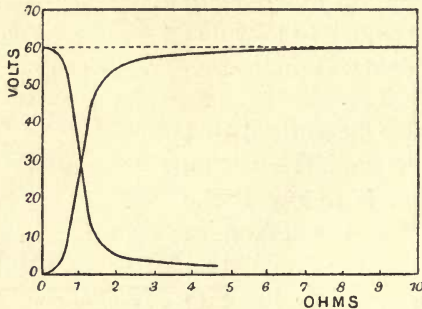

that at which the other rose, then the compound machine should, as indicated in Fig. 276, give as a result of the double-winding, a constant potential. It remains to be seen how far this is attained in practice.

External Characteristics of Self-regulating Dynamos.

Simultaneous observations of the external current i and the external potential e enable us to plot the external characteristic; which in a perfectly self-regulating dynamo would be a horizontal line. The curves given in Fig. 277 relate to a Siemens dynamo,* a Schuckert-Mordey "Victoria" dynamo† (see p. 147), and a Gülcher machine (see p. 142).

Distribution with Constant Current.

For distribution with constant current we need a shunt dynamo combined with a means of inducing an independent constant magnetisation, such, for example, as permanent steel magnets, or an independent current from a separate battery,

* See Richter in *Elektrotechnische Zeitschrift*, April 1883.

† See *Journal Soc. of Arts*, Mar. 7, 1884.

or, lastly, a number of coils in series with the main or external circuit, and therefore carrying a constant current. The cases

FIG. 277.

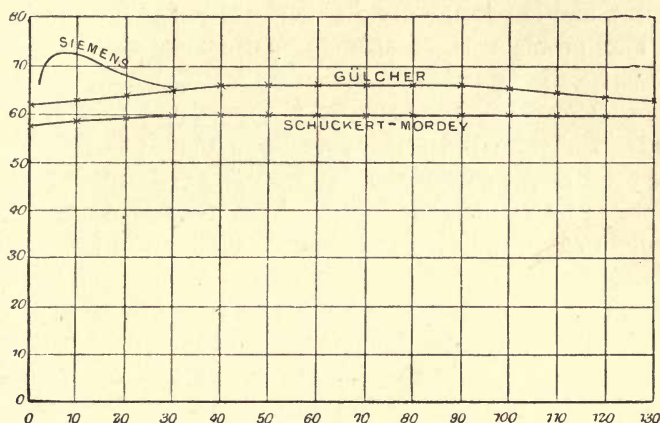

EXTERNAL CHARACTERISTICS OF SELF-REGULATING DYNAMOS.

may all be treated together by the aid of appropriate characteristics.

We have already, on p. 381, treated of the characteristic of a shunt dynamo in which there is an additional and independent magnetisation. Fig. 278 gives us the form of it. The characteristic starts at P instead of O, and runs horizontally to *a*, the length *Pa* representing the current which is sent through the armature-resistance by the electromotive-force due to the independent excitation at that particular speed for which the curve is drawn. From *a* onwards, the characteristic rises slightly curved to Q.

FIG. 278.

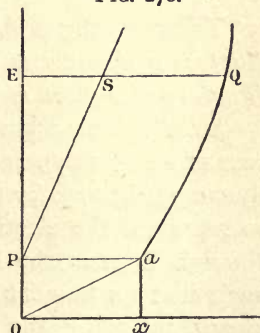

Now, if we draw a horizontal line *E Q*, as in Fig. 270, this will represent the total current through the armature. But we know that this current splits into two parts, one going round the

But we know that this current splits into two parts, one going round the

shunt, the other through the external circuit. We must find what part of $E Q$ goes through the shunt. Accordingly draw $P S$ at an angle whose tangent represents the resistance of the shunt. It cuts $E Q$ in S . The part $E S$ is the shunt current, and the remainder $S Q$ is the external current.

The problem is to arrange matters so that $S Q$ shall always be the same length as $P a$ no matter where Q may be taken. Clearly $S Q$ cannot be always equal to $P a$, unless $Q a$ is parallel to $P S$. Now, we know that it is possible to give the straight part of the characteristic $Q a$ any inclination we please by varying the speed. Vary the speed until $Q a$ is parallel to $P S$, and then the external current will be constant. This agrees with the deductions arrived at algebraically elsewhere, that the critical speed must be proportional to the internal resistance of the dynamo when running with the main circuit open, and that the constant current is equal to that current which would be generated by the armature running at critical speed with no other resistance than that of the armature coils themselves, and no other excitement of the field magnets beyond their independent magnetisation. This problem has not yet met with any practical solution, for when the characteristics are so steep, the magnetism is unstable.

Application of Characteristics to Dynamos used in Charging Accumulators.

The following problem is of great practical importance:—*Suppose a dynamo is used for charging an accumulator, and is driven at a given speed, what current will pass through it?*

Dr. Hopkinson has given a solution of this problem for the case of a series dynamo. Draw the total characteristic of the dynamo (Fig. 279) for the given speed. Along $O Y$ set off $O E$ to represent the electromotive-force of the accumulator, and through E draw the line $C E A$, making an angle with $O X$ such that its tangent represents the resistance of the whole circuit, including the accumulators. This line will cut the characteristic in the points B and A ; and, if the characteristic be repeated backwards, in C also. This negative branch of the characteristic is simply the characteristic of the dynamo

when the current through it is reversed, and its electromotive-force therefore also inverted. Then OL represents the actual current in the circuit: OM represents an unstable current which might exist for a moment, and ON represents the current which would traverse the circuit were the accumulators to overpower the dynamo and reverse it, as indeed frequently happens when series dynamos are so used. For it will be observed that if, as is the case when accumulators are reaching their full charge, their electromotive-force were to rise, or the resistance of the circuit to increase in consequence of heating, the inevitable result would be to diminish

FIG. 279.

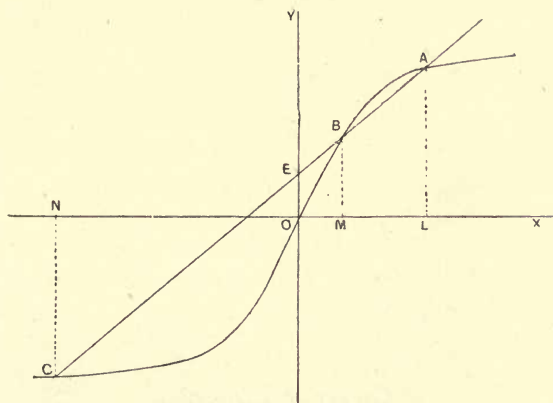

AL , the effective electromotive-force, and to diminish the current OL , so that the magnetism of the field magnets will also drop, and the point A will be brought nearer to the position of instability at the bow of the curve.

With the shunt dynamo the case is different. Let Fig. 280 represent the characteristic of the shunt dynamo, the external current being plotted along OX and the total electromotive-force along OY . Draw the line CEA as before. Then it cuts the positive branch at A , and OL is the current in the main circuit. If, now, either the counter electromotive-force of the accumulators, or the resistance of the circuit increases, the effect will be to move the point A to a higher point on the

curve. The charging current O L may diminish, but the shunt current will increase, for the effective electromotive-force

FIG. 280.

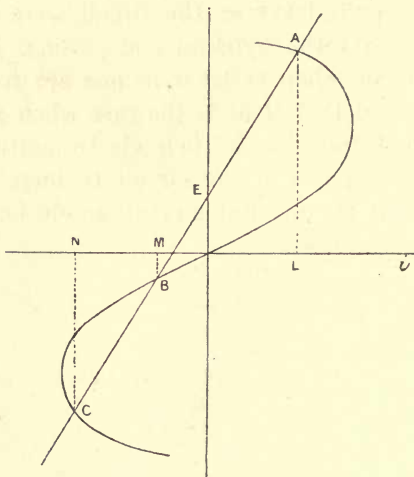

A L will be increased. Therefore with the shunt dynamo there will be no likelihood of the accumulators overpowering and reversing the dynamo.

Curves of Torque.

The torque* or turning-moment is, in a series dynamo, both when used as a generator and when used as a motor, very nearly proportional to the current. On p. 108 it was shown that the work per second of the dynamo or motor may be expressed mechanically as the product of the angular velocity and of the torque, or

$$\omega T = \text{mechanical work per second ;}$$

* Sometimes also called "the couple," the "moment of couple," the "angular force," the "axial force"; also called in Frölich's memoirs the "Zug-kraft"; and in those of Deprez the "effort statique," or the "couple mécanique."

and electrically as the product of volts and ampères, or

$$E i = \text{electrical work per second.}$$

And since in the series dynamo E is very nearly proportional to ω , it followed that T was proportional to i . Frölich has given* curves showing these relations, and has also argued from the law of magnetic saturation that these curves should for small speeds be curved, and for large speeds become nearly straight lines. He has also shown that in a motor, where the armature current helps to magnetise the field magnet, the torque is less nearly proportional to the current than in a generator. The following tables summarise the results of his experiments on a series-wound Siemens dynamo used in both functions:—

Generator—

Current ..	2·83	9·56	14·3	19·8	24·3	36·6	ampères.
Torque ..	5·1	10·61	14·8	21·3	29·6	44·0	kilos.

Motor—

Current ..	13·3	21·0	28·1	36·8	ampères.
Torque ..	10	20	30	40	kilos. at circumference.

These results are plotted out in Fig. 281 for the two cases.

Similar curves have been given by Deprez† for the Gramme machine, and by Ayrton and Perry‡ for a De Meritens motor. It can be shown that the torque is proportional to the square root of the heat-waste in the motor or dynamo. As moreover the current in a motor cannot be maintained without the continual expenditure of energy

FIG. 281.

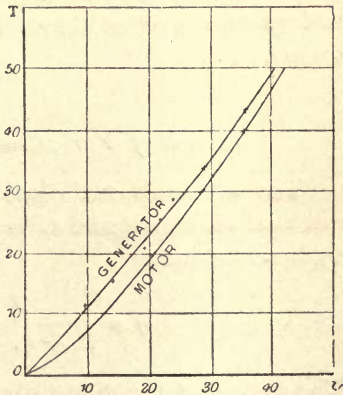

CURVES OF TORQUE.

* *Elektrotechnische Zeitschrift*, vol. iv. p. 61, Feb. 1883.

† *La Lumière Électrique*, t. xi. p. 42, Jan. 5, 1884.

‡ *Journal Soc. Teleg.-Eng. and Electricians*, vol. xii. No. 49, May 1883.

equal to $i^2 r$ watts, it follows that the continuous torque or turning-moment in a motor costs a certain expenditure, which will not only vary with the actual load on the motor, but is different in different types of motor. In a badly-designed motor a strong current running through a high internal resistance (and therefore expending much energy as heat) will produce but a feeble torque. For economy, it is therefore important to know at what cost in heat the torque is attained. The ratio may be expressed algebraically as

$$\frac{T}{\text{heat-waste}} = \frac{E i}{2 \pi n i^2 r} = \frac{E}{2 \pi n i r};$$

where r is the internal resistance, E the total electromotive-force of the dynamo, and n the number of revolutions per second. It is, however, preferable to measure T by a direct dynamometric process. Marcel Deprez, who has given to this important ratio the rather awkward name of the "price of the statical effort," has also given curves showing the variation of this ratio with the speed at which the machine is run. Professors Ayrton and Perry have shown in their memoir on electro-motors, that as the speed increases it requires a greater and greater current through the motor to produce a given torque.

Curve of Variation of Economic Coefficient.

The economic coefficient η (see p. 269) varies when the external resistance and external currents change. In a series dynamo we have

$$\eta = \frac{R}{R + r_a + r_m} = i \frac{R}{E} = \frac{e}{E}.$$

The second of the three expressions for η shows us how to obtain the curve of efficiency from the characteristic. Consider any point on the curve corresponding to a particular value of i . Divide the corresponding value of the external resistance by the whole electromotive-force, and the quotient

is the corresponding value of η . Or η may be obtained by directly measuring e and i and calculating E . Lastly η may be calculated beforehand from the resistance alone. The curve will be of the following kind:—Let $O B$ (Fig. 282) be the total characteristic of the dynamo, and $O J$, the line representing by its slope the armature resistance. Then, with any particular current P , $B P = E$, and $A B = e$, and $\eta = \frac{A B}{B P}$. Taking as unity any convenient height, say the height $O E$, set off $P C$ equal to the fraction $\frac{A B}{B P} \times O E$, giving C as a point on

the required curve. It is clear that this curve will descend from E , where at first it is nearly horizontal, and will terminate at a point on $O i$ opposite J . In a shunt dynamo the calculation is much less easy, but it shows a curve which, for small values of i , has smaller values of η than for large values of i . If, instead of plotting out the relation between η and i , we plot the values

for η and R , we shall find that with small values of R , η is small, and as R increases η increases, until R has the value

$$R = \sqrt{r_a r_s} \sqrt{\frac{r_s}{r_s + r_a}},$$

when η is a maximum, after which the

values of η diminish and become zero when R is infinitely great. In a compound dynamo wound for constant potential the value of η is almost constant, whatever the value of R or i , within the limits of working.

FIG. 282.

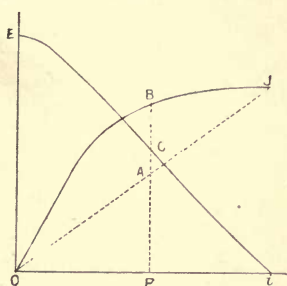

Curve of Horse-power Expended on Maintaining the Field Magnetism.

The energy spent per second in maintaining the magnetism of any magnet may be readily calculated as the product of the square of the magnetising current into the resistance of

the coil. Thus, for a shunt machine the energy spent per second is $i_s^2 r_s$, or $e i_s$, watts, and the electric horse-power

is $i_s^2 r_s \div 746$. It is convenient to exhibit the relation between this expenditure of energy and the current in a curve. Such a curve, taken from tests on an Edison-Hopkinson dynamo, is shown in Fig. 283. The curve would be a parabola if the resistance were constant. This is not so, however, on account of the greater heating effect of the stronger current.

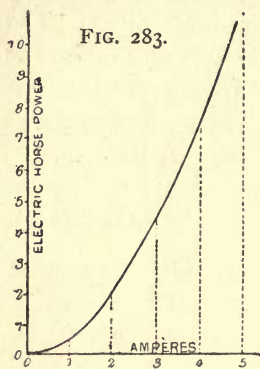

CHAPTER XXI.

THE DYNAMO AS A MOTOR.

IN the first chapter, the definition was laid down that dynamo-electric machinery meant "machinery for converting the energy of mechanical motion into the energy of electric currents, or *vice versâ*." Up to the present point we have treated the dynamo solely in its functions as a generator of electric currents. We now come to the converse function of the dynamo, namely that of converting the energy of electric currents into the energy of mechanical motion.

An electric motor, or, as it was formerly called, an electro-magnetic engine, is one which does mechanical work at the expense of electric energy ; and this is true, no matter whether the magnets which form the fixed part of the machine be permanent magnets of steel or electro-magnets. In fact, any kind of dynamo independently excited, or self-exciting, can be used conversely as a motor, though, as we shall see, some more appropriately than others. But whether the field magnets be of permanently magnetised steel or of temporarily magnetised iron, all these motors are electro-magnetic in principle ; that is to say, there is some part either fixed or moving which is an electro-magnet, and which as such attracts and is attracted magnetically.

Every one knows that a magnet will attract the opposite pole of another magnet, and will pull it round. We know also that every magnet placed in a magnetic field tends to turn round and set itself along the lines of force. As a first illustration of the nature of the forces at work in the magnetic field, let us take the case of Fig. 284. Here there is, in the first place, a simple magnetic field produced between the

poles of two strong magnets, one on the right, the other on the left. Between the two, confined forcibly at right angles to the lines of force, is placed a small magnetic needle. Iron filings sprinkled in the field reveal the actions at work in a most instructive way. Faraday, who first taught us the significance of these mysterious lines of force, has told us that we may reason about them as if they tended to contract or grow shorter. Now a simple inspection of Fig. 284 will show that the shortening of the lines of force must have the effect of rotating the magnetic needle upon its centre, through

FIG. 284.

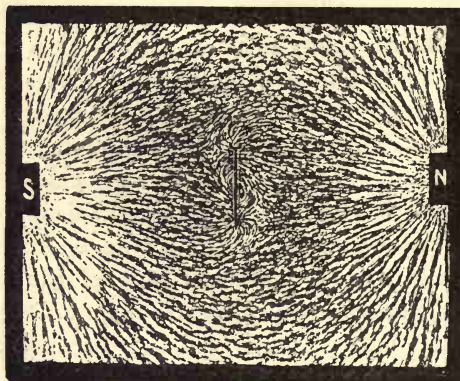

ACTION OF MAGNETIC FIELD ON A MAGNETIC NEEDLE.

an angle of 90° , for the lines stream away on the right hand above, and on the left hand below, in a most suggestive fashion. It is not, therefore, difficult to understand that very soon after the invention of the electro-magnet, which gave us for the first time a magnet whose power was under control, a number of ingenious persons perceived that it would be possible to construct an electro-magnetic engine in which an electro-magnet, placed in a magnetic field, should be pulled round; and, further, that the rotation should be kept up continuously, by reversing the current at an appropriate moment.

As a matter of fact, a mere coil of wire, carrying a current, is acted upon when placed in the magnetic field, and is pulled round as a magnet is. Fig. 285 shows how, in this case, the lines of force reveal the action. The magnetic field is, as before, produced between the ends of two large magnets. The two round spots are two holes drilled in the sheet of glass, where the wire which carried the current came up through the glass and descended again. We shall notice how the lines of iron filings, which would, if there were no current, run simply across from right to left, are bent out of their course. If these lines

FIG. 285.

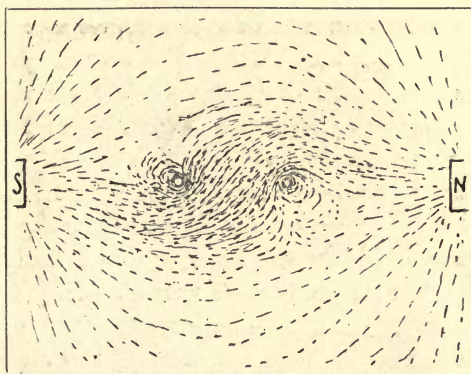

ACTION OF MAGNETIC FIELD ON A WIRE CARRYING A CURRENT.

could shorten themselves, they must, of necessity, twist the loop of wire round, and cause it to set at right angles to its present position. Every circuit traversed by a current tends so to set itself that it shall enclose as many lines of force as possible. It is obvious that to do this the loop used in Fig. 285 must turn at right angles to its present position.

On this very principle was constructed the earliest electric motor of Ritchie, so well known in many forms as a stock piece of electric apparatus, but little better in reality than a toy.

A great step in advance was made by Jacobi, who, in 1838,

constructed the multipolar machine, of which we give a representation in Fig. 286. This motor, which Jacobi designed for his electric boat, had two strong wooden frames, in each of which a dozen electro-magnets were fixed, their poles being set alternately. Between them, upon a wooden disk, were placed another set of electro-magnets, which, by the alternate attraction and repulsion of the fixed poles, were kept in rotation; the current which traversed the

FIG. 286.

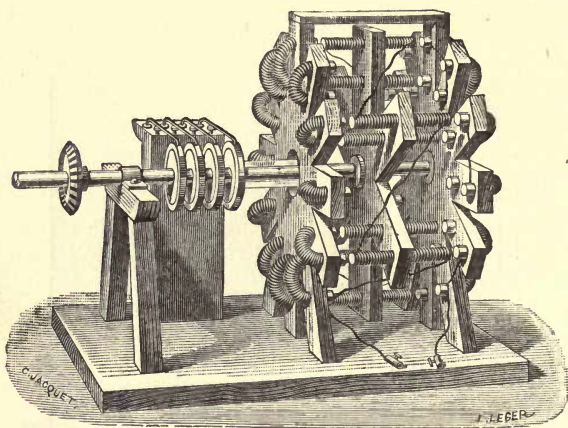

JACOBI'S ELECTRIC MOTOR.

rotating magnets being regularly reversed at the moment of passing the poles of the fixed magnets by means of a commutator, consisting, according to Jacobi's directions, of four brass-toothed wheels having pieces of ivory or wood let in between the teeth for insulation. Jacobi's motor is, in fact, a very advanced type of dynamo, and differs very little in point of design from one of Wilde's most successful forms.*

A still earlier rotating apparatus, and, like Ritchie's motor,

* Wilde's is, however, designed as a generator. Jacobi's, on the contrary, was designed as a motor; though of course it would generate currents if driven round by mechanical power.

a mere toy, was Sturgeon's wheel (Fig. 199, p. 223), described in 1823. This instrument, interesting as being the forerunner of Faraday's disk dynamo, is the representative of an important class of machines, namely, those which have a sliding contact merely and need no commutator.

A fourth class of motors may be named, wherein the moving part, instead of rotating upon an axis, is caused to oscillate backwards and forwards. Professor Henry, to whom^r we owe so much in the early history of electro-magnetism, constructed, in 1831, a motor with an oscillating beam, alternately drawn backwards and forwards by the intermittent action of an electro-magnet. Dal Negro's motor of 1833 was of this class; in it a steel rod was caused to oscillate between the poles of an electro-magnet, and caused a crank to which it was geared to rotate in consequence. A distinct improvement in this type of machine was introduced by Page, who employed hollow coils or bobbins as electro-magnets, which, by their alternate action, sucked down iron cores into the coils, and caused them to oscillate to-and-fro. Motors of this kind form an admirable illustration of one of the laws of electro-magnetics, first formulated by Gauss, but developed later by Maxwell, to the effect that a circuit acts on a magnetic pole in such a way as to make the number of magnetic lines of force that pass through the circuit a maximum. Once more we have recourse to iron filings to illustrate this abstract proposition of electric geometry.

In Fig. 287 the N. pole of a bar magnet is placed opposite a circuit or loop of wire traversed by a current, and which comes up through the glass at the lower hole and descends at the upper hole. The tendency to draw as many as possible of the magnet's lines of force into the embrace of the circuit is unmistakable. If now we reverse the current, what do we find? Fig. 288 supplies the answer; for now we find that the magnet's lines of force, instead of being drawn in, are pushed out. In fact, in one case the pole is attracted, in the other repelled.

Page's suggestion was further developed by Bourbouze,

FIG. 287.

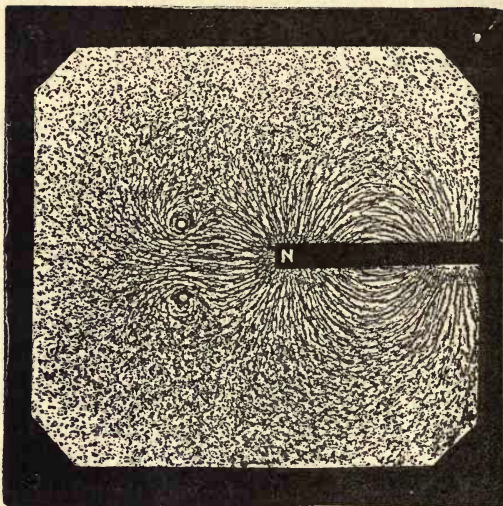

POLE OF MAGNET ATTRACTED INTO A CIRCUIT TRAVERSED BY A CURRENT.

FIG. 288.

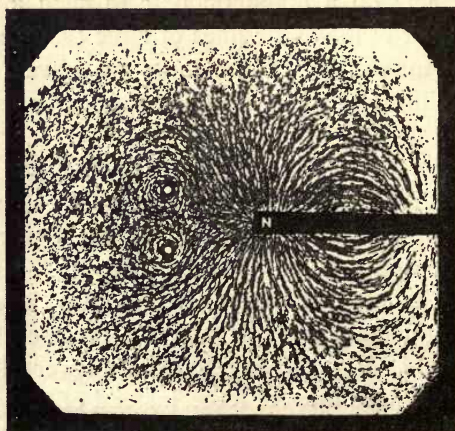

POLE OF MAGNET REPELLED OUT OF THE CIRCUIT WHEN THE CURRENT IS REVERSED.

who constructed the curious motor depicted in Fig. 289,* which looks uncommonly like an old type of steam-engine. We have here a beam, crank, fly-wheel, connecting-rod, and even an eccentric valve-gear and a slide-valve. But for cylinders we have four hollow electro-magnets; for pistons, we have iron cores that are alternately sucked in and drawn

FIG. 289.

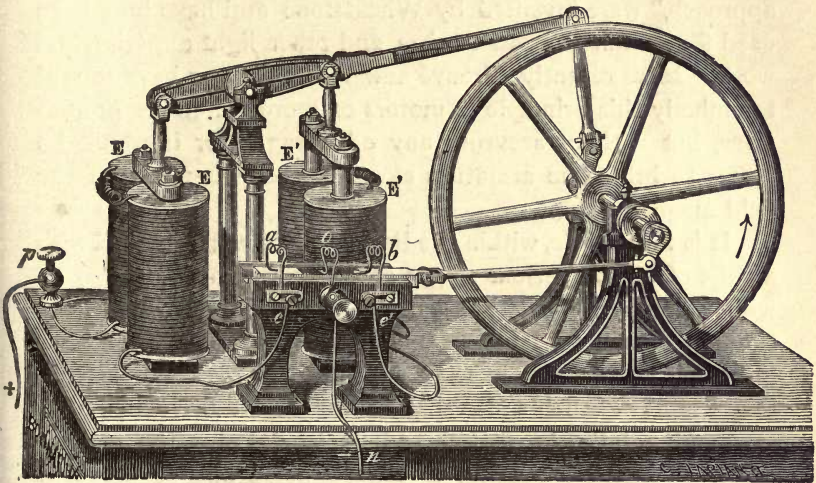

BOURBOUZE'S ELECTRIC MOTOR.

out; and, for slide-valve we have a commutator, which, by dragging a pair of platinum-tipped springs over a flat surface made of three pieces of brass separated by two insulating strips of ivory, reverses at every stroke the direction of the currents in the coils of the electro-magnets. It is really a very ingenious machine, but, in point of efficiency, far behind many other electric motors. Unfortunately it does not do to design dynamo-electric machinery on the same lines as steam-engines.

Yet a fifth class of electric motors owes its existence to

* Taken, by permission of Messrs. Macmillan and Co., from *The Applications of Physical Forces*.

Froment, who, fixing a series of parallel iron bars upon the periphery of a drum, caused them to be attracted, one after the other, by an electro-magnet or electro-magnets, and thus procured a continuous rotation.

Lastly, of the various types of motor we may enumerate a class in which the rotating portion is enclosed in an eccentric frame of iron, so that as it rotates it gradually approaches nearer. Little motors, working on this principle of "oblique approach," were invented by Wheatstone and have long been used for spinning Geissler tubes, and other light experimental work. More recently, Trouvé and Wiesendanger have sought to embody this principle in motors of more ambitious proportions, but without securing any advantage; for it would be better to bring the armature closer to the pole-pieces of the field magnet.

It is impossible, within the limits of this work, to deal with a title of all the various stages of discovery and invention, or with many interesting and curious machines that have from time to time been tried. It might be told how Page, after inventing his machine in 1834, succeeded in 1852 in constructing a motor of such a size that he was able to drive a circular saw and a lathe by it. Time fails to describe the electric motor of Davidson, which, in 1842, enabled him to propel a carriage, at the speed of four miles an hour, between Edinburgh and Glasgow. An engine which was of 10 horse-power was built in 1849, by Soren Hjörth, at Liverpool.

All these early attempts, however, came to nothing, for two reasons. At that time there was no economical method of generating electric currents known. At that time, moreover, the great physical law of the conservation of energy was not recognised, and its all-important bearings upon the theory of electric machinery could not be foreseen.

While voltaic batteries were the only available sources of electric currents, economical working of electric motors was hopeless. For a voltaic battery wherein electric currents are generated by dissolving zinc in sulphuric acid is a very expensive source of power. To say nothing of the cost of the acid, the zinc—the very fuel of the battery—costs more than

twenty times as much as coal, and is a far worse fuel; for whilst an ounce of zinc will evolve heat to an amount equivalent to 113,000 foot-pounds of work, an ounce of coal will furnish the equivalent of 695,000 foot-pounds.

The fact, however, which seemed most discouraging, and which, if rightly interpreted in accordance with the law of conservation of energy, would have been found to be (on the contrary) a most encouraging fact, was the following:—If a galvanometer was placed in the circuit with the electric motor and the battery, it was found that when the motor was running it was impossible to force so strong a current through the wires as that which flowed when the motor was standing still. Now there are only two causes that can stop such a current flowing in a circuit; there must be either an obstructive resistance or else a counter electromotive-force. At first, the common idea was, that when the motor was spinning round, it offered a greater resistance to the passage of the electric current than when it stood still. The genius of Jacobi enabled him, however, to discern that the observed diminution of current was really due to the fact that the motor, by the act of spinning round, began to work as a dynamo on its own account, and tended to set up a current in the circuit in the opposite direction to that which was driving it. The faster it rotated the greater was the counter electromotive-force (or “electromotive-force of reaction”) which was developed. In fact, the theory of the conservation of energy requires that such a reaction should exist.

We know that in the converse case, when we are employing mechanical power to generate currents by rotating a dynamo, directly we begin to generate currents, that is to say directly we begin to do electric *work*, it immediately requires much more power to turn the dynamo than is the case when no electric work is being done. In other words, there is an opposing reaction to the mechanical force which we apply in order to do electric work. An opposing reaction to a mechanical force may be termed a “counter-force.” When, on the other hand, we apply (by means of a voltaic battery, for example) an electromotive-force to do mechanical work,

we find that here again there is an opposing reaction ; and an opposing reaction to an electromotive-force is a "counter electromotive-force."

The experiment of showing the existence of this counter electromotive-force is a very easy one. All one requires is a little motor,* a few cells of battery of small internal resistance, and a galvanometer. They should be connected up in one circuit, and the deflexion of the galvanometer should be observed when the motor is held fast, and when it rotates with small and large loads. In an experiment shown before the Society of Arts by the author, a little motor of his own design was connected with two accumulator cells and with a special galvanometer. When the spindle of the motor was held fast, the galvanometer indicated 44° , when it rotated the needle descended to 23° , and as the speed increased it eventually fell to 15° .

The existence of this counter electromotive-force is of the utmost importance in considering the action of the dynamo as a motor, because upon the existence and magnitude of this counter electromotive-force depends the degree to which any given motor enables us to utilise electric energy that is supplied to it in the form of an electric current. In discussing the dynamo as a generator many considerations were pointed out, the observance of which would tend to improve the efficiency of such generators. It is needless to say that many of these considerations, such as the avoidance of useless resistances, unnecessary iron masses in cores, and the like, will also apply to motors. The freer a motor is from such objections, the more efficient will it be. But the efficiency of a motor in utilising the energy of a current depends not only on its efficiency in itself, but on another consideration, namely the relation between the electromotive-force which it itself generates when rotating, and the electromotive-force—or, as some people call it, the electric pressure—at which the current is supplied to it. A motor which itself in running generates

* One of any ordinary type—a magneto machine or a series-wound motor will answer.

only a *low* electromotive-force cannot, however well designed, be an *efficient* or economical motor when supplied with currents at a *high* electromotive-force. A good low-pressure steam-engine does not become more "efficient" by being supplied with high-pressure steam. Nor can a high-pressure steam-engine, however well constructed, attain a high efficiency when worked with steam at low pressures. Analogous considerations apply to dynamos used as motors. They must be supplied with currents at electromotive-forces adapted to them. Even a perfect motor—one without friction or resistance of any kind—cannot give an "efficient" or economical result if the law of efficiency is not observed in the conditions under which the electric current is supplied to it.

CHAPTER XXII.

THEORY OF ELECTRIC MOTORS.

IT will be shown, mathematically, that the efficiency with which a perfect motor utilises the electric energy of the current, depends upon the ratio between the counter electromotive-force developed in the armature of the motor, and the electromotive-force of the current which is supplied by the battery. No motor ever succeeds in turning into useful work the whole of the currents that feed it, for it is impossible to construct machines without resistance, and whenever resistance is offered to a current, part of the energy of the current is wasted in heating the resistance wire. Let the symbol W stand for the whole electric energy developed per second by a current, and let w stand for that part of the energy which the motor takes up as useful work from the circuit.* All the rest of the energy of the current, or $W - w$, will be wasted in useless heating of the resistances.

But if we want to work our motor under the conditions of greatest economy, it is clear that we must have as little heat-waste as possible; or, in symbols, w must be as nearly as possible equal to W . It will be shown mathematically that the ratio between the useful energy thus appropriated and the total energy spent is equal to the ratio between the counter electromotive-force of the motor and the whole

* The symbol w must be clearly understood to refer to the value of the work taken up by the motor, *as measured electrically*. The whole of this work will not appear as useful mechanical effect however, for part will be lost by mechanical friction, and part also in the wasteful production of eddy currents in the moving parts of the motor. What proportion of w appears as useful mechanical work depends on the efficiency of the motor *per se*, which we are not here considering. In all that follows immediately we shall suppose such causes of loss not to exist, or the motor will be considered as a perfect motor.

electromotive-force of the battery that feeds the motor. (The motor is supposed here to be a magneto motor, as it is not wished here to complicate general considerations by introducing into the expression for the efficiency the energy wasted in heat in the field-magnet coils of the motor.) The proof will be given later. Let us call this whole electromotive-force with which the battery feeds the motor \mathcal{E} , and let us call the counter electromotive-force E . Then the rule is

$$w : W = E : \mathcal{E},$$

or, if we express the efficiency as a fraction,

$$\frac{w}{W} = \frac{E}{\mathcal{E}}.$$

But we may go one stage further. If the resistances of the circuit are constant, the current i , observed when the motor is running, will be less than I , the current while the motor was standing still. But, from Ohm's law, we know that

$$i = \frac{\mathcal{E} - E}{R},$$

where R is the total resistance of the circuit. Hence

$$\frac{I - i}{I} = \frac{E}{\mathcal{E}} = \frac{w}{W}.$$

From which it appears that we can calculate the efficiency at which the motor is working, by observing the ratio between the fall in the strength of the current and the original strength. Now as this mathematical law of efficiency has been known for twenty years,* it is strange that even in many of the accepted text-books it has been ignored or misunderstood. Another law, discovered by Jacobi, not a law of efficiency at all, but a law of maximum work in a given time, has usually been given instead. It is, indeed, frequent to find Jacobi's law of maximum activity stated as the law of maximum efficiency. Yet as a mathematical expression the true law is implicitly

* The true law of efficiency was, however, clearly stated by Thomson in 1851, and is recognised in a paper by Joule at about the same date. See also Rankine's *Steam Engine*, p. 546.

contained in more than one of the memoirs of Joule; it is implied also in more than one passage of the memoirs of Jacobi;* it exists in the *Théorie Mécanique de la Chaleur* of Verdet.† Yet it remained a mere mathematical abstraction until its significance was pointed out three or four years ago by Siemens.

Jacobi's law concerning the maximum work of an electric motor supplied with currents from a source of given electromotive-force, is the following:—The mechanical work given out by a motor is a maximum when the motor is geared to run at such a speed that the current is reduced to half the strength that it would have if the motor was stopped. This, of course, implies that the counter electromotive-force of the motor is

* Jacobi seems very clearly to have understood that his law was a law of maximum working, but not to have understood that it was not a law of true economical efficiency. In one passage (*Annales de Chimie et de Physique*, t. xxxiv. (1852), p. 480), he says:—"Le travail mécanique maximum, ou plutôt l'effet économique, n'est nullement compliqué avec ce que M. Müller appelle les circonstances spécifiques des moteurs électromagnétiques." Yet, though here there is apparently a confusion between the two very different laws, in a preceding part of the very same memoir Jacobi says (p. 466):—"En divisant la quantité de travail par la dépense (de zinc), on obtient une expression très-importante dans la mécanique industrielle: c'est l'effet économique, ou ce que les Anglais appellent *duty*." Here, again, is a singular confusion. The definition is perfect; but "effet économique" is not the same thing as the maximum power. Jacobi's law is not a law of maximum efficiency, but a law of maximum power; and that is where the error creeps in. It is significant, in suggesting the cause of this remarkable conflict of ideas, that throughout this memoir Jacobi speaks of *work* as being the product of force and velocity, not of force and displacement. The same mistake—common enough amongst continental writers—is to be found in the accounts of Jacobi's law given in Verdet's *Théorie Mécanique de la Chaleur*, in Müller's *Lehrbuch der Physik*, and even in Wiedemann's *Galvanismus*. Now the product of force and velocity is not work, but work divided by time, that is to say rate-of-working, or "activity." This may account for the widely-spread fallacy. Jacobi makes another curious slip in the memoir above alluded to (p. 463), by supposing that the strength of the current can only become = 0 when the motor runs *at an infinite speed*. We all know now that the current will be reduced to zero when the counter electromotive-force of the motor equals that of the external supply; and if this is finite, the velocity of the motor, if there is independent magnetism in its magnets, need also only be finite. This error—also to be found in Verdet—seems to have thrown the latter off the track of the true law of efficiency, and to have made him fall back on Jacobi's law.

† See Verdet, *Œuvres*, t. ix. p. 174, where, however, Verdet makes the very mistake so often made, of supposing that the greatest possible efficiency of a motor, working with a given electromotive-force, is 50 per cent., or is the same as its efficiency when working at the maximum rate.

equal to half the electromotive-force furnished by the battery or generator. Now, under these circumstances, only half the energy furnished by the external source is utilised, the other half being wasted in heating the circuit. If Jacobi's law was indeed the law of efficiency, no motor, however perfect in itself, could convert more than 50 per cent. of the electric energy supplied to it into actual work. Now Siemens showed * some years ago, that a dynamo can be, in practice, so used as to give out more than 50 per cent. of the energy of the current. It can, in fact, work more efficiently if it be not expected to do its work so quickly. Dr. Siemens, to whom we owe the honour of having first shown us the true physical signification of the mathematical expressions which, until then, had been regarded as mere abstractions, has, in fact, proved that if the motor be arranged so as to do its work at less than the maximum rate, by being geared so as to do much less work per revolution, but yet so as to run at a higher speed, it will be more efficient ; that is to say, though it does less work, there will also be still less electric energy expended, and the ratio of the useful work done to the energy expended will be nearer unity than before.

The algebraic reasoning is as follows :—If \mathcal{E} be the electromotive-force of the mains supplying the current to the motor when the motor is at rest, and i be the current which flows at any time, the electric energy W expended in unit time will be (as expressed in watts) given by the equation—

$$W = \mathcal{E} i = \mathcal{E} \frac{(\mathcal{E} - E)}{R}. \quad [\text{XLVI.}]$$

Now, when the motor is running, part of this electric energy is being spent in doing work, and the remainder is wasting itself in heating the wires of the circuit. We have already used the symbol w for the useful work (per second) done by the motor. All the energy which is not thus utilised is

* The matter was also very well and clearly put by Prof. W. E. Ayrton in his lecture on "Electric Transmission of Power," before the British Association, in Sheffield in 1879.

wasted in heating the resistances. Let the symbol H represent the heat wasted per second. Its mechanical value will be $H J$, where J stands for Joule's equivalent. Then clearly we shall have

$$W = w + H J.$$

But, by Joule's law, the heat-waste of the current whose strength is i running through resistance R , is expressed by the equation

$$H J = i^2 R.$$

Substituting this value above, we get

$$W = w + i^2 R,$$

whence we get

$$w = W - i^2 R. \quad [\text{XLVII.}]$$

But by equation [XLVI.] preceding, $W = \mathcal{E} i$, whence

$$w = \mathcal{E} i - i^2 R, \quad [\text{XLVIII.}]$$

and, writing for i its value $\frac{\mathcal{E} - E}{R}$, we get

$$w = \frac{(\mathcal{E} - E) \left\{ \mathcal{E} - (\mathcal{E} - E) \right\}}{R},$$

or

$$w = E \frac{\mathcal{E} - E}{R}. \quad [\text{XLIX.}]$$

Comparing equation [XLIX.] with equation [XLVI.], we get the following:—

$$\frac{w}{W} = \frac{E (\mathcal{E} - E)}{\mathcal{E} (\mathcal{E} - E)};$$

or, finally,

$$\frac{w}{W} = \frac{E}{\mathcal{E}}. \quad w = \text{fractional losses} + \text{unsuccessful work} \quad [\text{L.}]$$

This is, in fact, the mathematical law of efficiency, so long misunderstood until Siemens showed its practical significance. We may appropriately call it *the law of Siemens*. Here the

ratio $\frac{w}{W}$ is the measure of the efficiency of the motor, and the equation shows that we may make this efficiency as nearly equal to unity as we please, by letting the motor run so fast that E is very nearly equal to \mathcal{E} : which is the true law of efficiency of a perfect motor supplied with electric energy under the condition of constant external electromotive-force.

Now go back to equation [XLVIII.], which is—

$$w = \mathcal{E} i - i^2 R.$$

In order to find what value of i will give us the maximum value for w (which is the work done by the motor *in unit time*), we must take the differential coefficient and equate it to zero.*

$$\frac{dw}{di} = \mathcal{E} - 2iR = 0,$$

whence we have

$$i = \frac{1}{2} \frac{\mathcal{E}}{R}.$$

But, by Ohm's law, $\frac{\mathcal{E}}{R}$ is the value of the current when the motor stands still. So we see at once that, to get maximum work per second out of our motor, the motor must run at such

* The argument can be proven, though less simply, without the calculus, as follows: write equation [XLVIII.] in the following form:

$$i^2 R - \mathcal{E} i + w = 0.$$

Solving this as an ordinary quadratic equation, in which i is the unknown quantity, we have

$$i = \frac{\mathcal{E} \pm \sqrt{\mathcal{E}^2 - 4Rw}}{2R}.$$

To find from this what value of i corresponds to the greatest value of w , it may be remembered that a negative quantity cannot have a square root, and that therefore the greatest value that w can possibly have will occur when

$$4Rw = \mathcal{E}^2,$$

for then the term under the root sign will vanish. When this condition is observed it will follow that

$$i = \frac{\mathcal{E}}{2R},$$

or the current will be reduced to half its original value.

a speed as to bring down the current to half the value which it would have if the motor were at rest. In fact, we here prove the law of Jacobi for the maximum rate of doing work. But here, since

$$i = \frac{\mathcal{E} - E}{R} = \frac{1}{2} \frac{\mathcal{E}}{R},$$

it follows that

$$\mathcal{E} - E = \frac{1}{2} \mathcal{E},$$

or

$$\frac{E}{\mathcal{E}} = \frac{1}{2};$$

whence it follows also that

$$\frac{w}{W} = \frac{1}{2}.$$

That is to say, the efficiency is but 50 per cent. when the motor does its work at the maximum rate.*

Several graphic constructions have been suggested to convey these facts to the eye; one of these enables us, in one

* It may be worth while to recal a precisely parallel case that occurs in calculating the currents from a voltaic battery. Every one is familiar with the rule for grouping a battery which consists of a given number of cells, that they will yield a maximum current through a given external resistance when so grouped that the internal resistance of the battery shall, as nearly as possible, equal the external resistance. But this rule, which is true for maximum current (and, therefore, for maximum rate of using up the zinc of one's battery), is not the case of greatest economy. For if external and internal resistance are equal, half the energy of the current will be wasted in the heat of the cells, and half only will be available in the external circuit. If we want to get the greatest economy, we should group our cells so as to have an internal resistance much less than the external. We shall not get so strong a current, it is true; and we shall use up our zincs more slowly; but a far greater proportion of the energy will be expended usefully, and a far less proportion will be wasted in heating the battery cells. The maximum economy will, of course, be got by making the external resistance infinitely great as compared with the internal resistance. Then all the energy of the current will be utilised in the external circuit, and none wasted in the battery. But it would take an infinitely long time to get through a finite amount of work in this extreme case. The same kind of reasoning is strictly applicable to dynamos used as generators, the resistance of the rotating part of the circuit being the counterpart of the internal resistance of the battery cells. For good economy the resistance of the armature should be very low as compared with that of the external circuit.

diagram, to exhibit graphically both Jacobi's law of maximum rate of working, and Siemens' law of efficiency.*

Let the vertical line, A B (Fig. 290), represent the electromotive-force \mathcal{E} of the electric supply. On A B construct a square A B C D, of which let the diagonal B D be drawn. Now measure out from the point B, along the line B A, the counter electromotive-force E of the motor. The length of this quantity will increase as the velocity of the motor increases. Let E attain the value B F. Let us inquire what the actual current will be, and what the energy of it; also what the work done by the motor is.

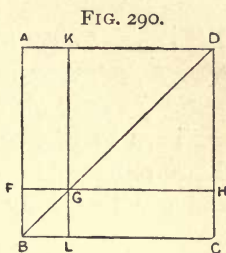

First complete the construction as follows:—Through F draw F G H, parallel to B C, and through G draw K G L, parallel to A B. Then the actual electromotive-force at work in the machine producing a current is $\mathcal{E} - E$, which may be represented by any of the lines A F, K G, G H, or L C. Now the electric energy expended per second is $\mathcal{E} i$; and since $i = \frac{\mathcal{E} - E}{R}$,

$$\frac{\mathcal{E} (\mathcal{E} - E)}{R};$$

and the work absorbed by the motor, *measured electrically*, is

$$\frac{E (\mathcal{E} - E)}{R}.$$

R being a constant, the values of the two may be written respectively

$$\mathcal{E} (\mathcal{E} - E)$$

and

$$E (\mathcal{E} - E).$$

* See paper by the author in the *Philosophical Magazine*, Feb. 1883.

Now the area of the rectangle

$$A F H D = \mathcal{E} (\mathcal{E} - E),$$

and that of the rectangle

$$G L C H = E (\mathcal{E} - E).$$

The ratio of these two areas on the diagram is the efficiency of a perfect motor, under the condition of a given constant electro-motive-force in the electric supply.

Turn to Fig. 291, in which these areas are shaded. This figure represents a case where the motor is too heavily loaded, and can turn only very slowly, so that the counter electro-motive-force E is very small compared with \mathcal{E} . Here the area which represents the energy expended, is very large; while that which represents useful work realised in the motor is very small. The efficiency is obviously very low. Two-thirds or more of the energy is being wasted in heat.

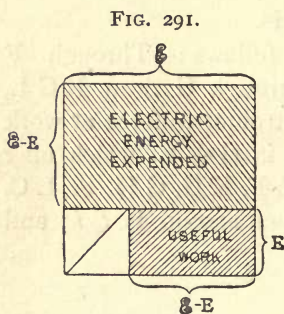

So far we have assumed that the efficiency of a motor (working with a given constant external electromotive-force) is to be measured electrically. But no motor actually converts into useful mechanical effect the whole of the electric energy which it absorbs, since part of the energy is wasted in friction and part in wasteful electro-magnetic reactions between the stationary and moving parts of the motor. If, however, we consider the motor to be a *perfect* engine (devoid of friction, not producing wasteful eddy currents, running without sound, giving no sparks at the collecting-brushes, &c.), and capable of turning into mechanical effect 100 per cent. of the electric energy which it absorbs, then, and then only, may we take the electrical measure of the work of the motor as being a true measure of its performance. Such a "perfect" electric engine would, like the ideal "perfect" heat engine of Carnot, be perfectly reversible. In Carnot's heat engine it is sup-

posed that the whole of the heat actually absorbed in the cycle of operations is converted into useful work ; and in this case the efficiency is the ratio of the heat absorbed to the total heat expended. As is well known, this efficiency of the perfect heat engine can be expressed as a function of two absolute temperatures, namely those respectively of the heater and of the refrigerator of the engine. Carnot's engine is also ideally reversible ; that is to say, capable of reconverting mechanical work into heat.

The mathematical law of efficiency of a perfect electric engine illustrated in the above construction is an equally ideal case. And the efficiency can also be expressed, when the constants of the case are given, as a function of two electromotive-forces. We shall return to this comparison a little later.

The Law of Maximum Activity (Jacobi).

Let us next consider the area $GLCH$ of the diagram (Fig. 290), which represents the work utilised in the motor. The value of this area will vary with the position of the point G , and will be a maximum when G is midway between B and D ; for of all rectangles that can be inscribed in the triangle BCD , the square will have maximum area (Fig. 292). But if G is midway between B and D , the rectangle $GLCH$ will be exactly half the area of the rectangle $A F H D$; or, the useful work is equal to half the energy expended. When this is the case, the counter electromotive-force reduces the current to half the strength it would have if the motor were at rest ; which is Jacobi's law of the efficiency of a motor doing work at its greatest possible rate. Also F will be half-way between B and A , which signifies that $E = \frac{1}{2} \mathcal{E}$.

FIG. 292.

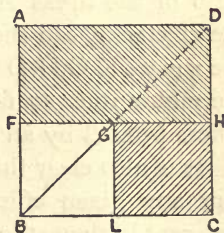

GEOMETRIC ILLUSTRATION OF JACOBI'S LAW OF MAXIMUM ACTIVITY.

Law of Maximum Efficiency (Siemens).

Again, consider these two rectangles when the point G moves indefinitely near to D (Fig. 290). We know from common geometry that the rectangle G L C H is equal to the rectangle A F G K. The area (square) K G H D, which is the excess of A F H D over A F G K, represents therefore the electric energy which is wasted in heating the resistances of the motor. That the efficiency should be a maximum the heat-waste must be a minimum.

FIG. 293.

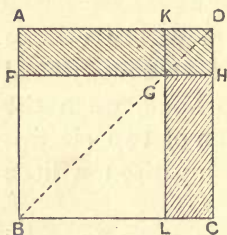

GEOMETRIC ILLUSTRATION
OF SIEMENS LAW OF
MAXIMUM EFFICIENCY.

In Fig. 290 this corner square, which stands for the heat-waste, was enormous. In Fig. 292 it was exactly half the energy. In Fig. 293 it is only about one-eighth. Clearly, we may make the heat-waste as small as we please, if only we will take the point F very near to A. The efficiency will be a maximum when the heat-waste is a minimum. The ratio of the areas A F H D and G L C H, which represents the efficiency, can therefore only become equal to unity when the square K G H D becomes indefinitely small—that is, when the motor runs so fast that its counter electromotive-force E differs from \mathcal{E} by an indefinitely small quantity only.

It is also clear that if our diagram is to be drawn to represent any given efficiency (for example, an efficiency of 90 per cent.), then the point G must be taken so that area G L C H = $\frac{9}{10}$ area A F H D; or, G must be $\frac{9}{10}$ of the whole distance along from B towards D. This involves that E shall be equal to $\frac{9}{10}$ of \mathcal{E} , or that the motor shall run so fast as to reduce the current to $\frac{1}{10}$ of what it would be if the motor were standing still. Thus we verify, geometrically, Siemens' law of efficiency.

Further, if the motor be not a "perfect" one, but one whose intrinsic efficiency, or *efficiency per se*, is known, the

actual mechanical work performed by the motor can be represented on the diagram by simply retrenching from the rectangle $G L C H$ the fraction of work lost in friction, &c. Similarly, in the case where the electric energy expended has been generated in a dynamo-electric machine whose intrinsic efficiency is known, the total mechanical work expended can be represented by adding on to the area $A F H D$ the proportion spent on useless friction, &c. To make the diagram still more expressive, we may divide the area $K G H D$ into slices proportional to the several resistances of the circuit ; and the areas of these several slices will represent the heat wasted in the respective parts of the circuit. These points are exemplified in Fig. 294, which represents the transmission of power between two dynamos, each supposed to have an intrinsic efficiency of 80 per cent., each having 500 ohms resistance, working through a line of 1000 ohms resistance, the electromotive-force of the machine used as generator being 2400 volts, and the counter electromotive-force of the machine used as motor being 1600 volts.

FIG. 294.

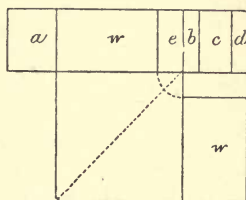

The entire upper area represents the total mechanical work expended. Call this 100. It is expended as follows:—
 $a = 20$, lost by friction, &c., in the generator ; $b = 6\frac{2}{3}$, lost in heating generator ; $c = 13\frac{1}{3}$, lost in heating line-wires ; $d = 6\frac{2}{3}$, lost in heating motor ; $e = 10\frac{2}{3}$, lost in friction in the motor ; $w = 42\frac{2}{3}$ is the percentage realised as useful mechanical work.

It only remains to point out a curious contrast that presents itself between the efficiency of a perfect heat engine and that of a perfect electric engine. We saw that the one could be expressed as a function of two temperatures, whilst the other could be expressed as a function of two electromotive-forces. But in the heat engine the efficiency is the greatest when the difference between the two temperatures is a maximum ; whilst in the electric engine the efficiency is the greatest when the difference between the two electro-

motive-forces is a minimum. The two cases are contrasted in Figs. 295 and 296, Fig. 295 showing the efficiency of a heat engine working between temperatures T and t (reckoned from absolute zero); whilst Fig. 296 shows the efficiency of an electric engine receiving current at an electromotive-force \mathcal{E} ,

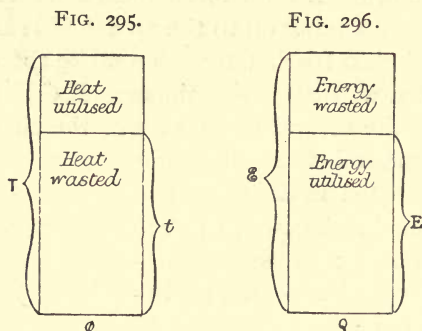

HEAT ENGINE AND ELECTRIC ENGINE CONTRASTED.

its counter electromotive-force being E . Joule's remark, here illustrated, that an electric engine may be readily made to be a far more efficient engine than any steam-engine, is amply justified by all experience. But in spite of this fact, electric engines are, as yet, dearer in practice than heat engines, simply because energy in the form of electric currents supplied at a high potential is, as yet, much more costly to produce than energy in the form of heat supplied at a high temperature.

Electric Transmission of Energy.

In all the preceding discussion, it has been assumed that the motor is to be worked with a supply of current furnished at a constant potential. It is not only convenient, but useful, to make such a condition the basis of the argument, because this is, probably, the condition under which electric power will, in the not very distant future, be distributed over large areas in towns and cities. It would be absurd, in the present stage of electro-technical science, to deal with such a question as the construction and use of motors, without taking

into account the practical conditions under which they will be used. But the condition of having a constant fixed electromotive-force is not the only condition of supply; for, as we have seen in preceding chapters, a generator or system of generators may be worked so as to yield a constant current.

Now the method of distribution by a constant current is, where power is to be transmitted to long distances, a much more economical method than that of distribution with a constant potential, owing to the fact that for the former method thinner and therefore less expensive conducting wires may be employed. We shall therefore, in further discussing the theory of the different windings of motors, have to take both cases into account. Meantime we may discuss two problems bearing upon the transmission of power by motors, problems which are vital to the understanding of the conditions which motors must fulfil.

It is required to determine the relation between the potential at which the current is supplied to the motor, and the heat-waste in the circuit.

Let ΣR stand for the sum of all the resistances in the circuit; then, by Joule's law, the heat-waste is (in mechanical measure)

$$H J = i^2 \Sigma R.$$

And, since $i = \frac{\mathcal{E} - E}{\Sigma R}$, we may write the heat-waste as

$$H J = \frac{(\mathcal{E} - E)^2}{\Sigma R}.$$

Now suppose that without changing the resistances of the circuit we can increase \mathcal{E} , and also increase E , while keeping $\mathcal{E} - E$ the same as before, it is clear that the heat loss will be precisely the same as before. But how about the work done? Let the two new values be respectively \mathcal{E}' and E' . Then the electric energy expended is

$$W = \frac{\mathcal{E}' (\mathcal{E}' - E')}{\Sigma R},$$

and the useful work done is

$$\dot{w} = \frac{\dot{E} (\mathcal{G} - E)}{\Sigma R}.$$

That is to say, with no greater loss in heating, more energy is transmitted, and more work done. Also the efficiency is greater, for

$$\frac{\dot{w}}{\dot{W}} = \frac{\dot{E}}{\mathcal{G}},$$

and this ratio is more nearly equal to unity than $\frac{E}{\mathcal{G}}$, because both \mathcal{G} and E have received an increment arithmetically equal. Clearly, then, it is an economy to work at high electromotive-force. The importance of this matter, first pointed out by Siemens, and later by Marcel Deprez, cannot be overrated. But how shall we obtain this higher electromotive-force? One very simple expedient is that of driving both generator and motor at higher speeds. Another way is to wind the armatures of both machines with many coils of wire having many turns. This expedient has, however, the effect of putting great resistances into the circuit. This circumstance may, nevertheless, be no great drawback, if there is already a great resistance in the circuit—as, for example, the resistance of many miles of wire through which the power is to be transmitted. In this case, doubling the electromotive-force will not double the resistance. Even in the case where the line resistance is insignificant, an economy is effected by raising the electromotive-force. For, as may be deduced from the equations, when $\mathcal{G} - E$ is kept constant, the effect of doubling the electromotive-force is to increase the efficiency, when the resistance of the line is very small as compared with that of the machines, and to double it when the resistance of the line is very great as compared with that of the machines. It is, in fact, worth while to put up with the extra resistance, which we cannot avoid if we try to secure high electromotive-force by the use of coils of fine wire of many turns. It is

true that the useful effect falls off, *cæteris paribus*, as the resistance increases; but this is much more than counter-balanced by the fact that the useful effect increases in proportion to the square of the electromotive-force.

The advantage derived in the case of the electric transmission of energy from the employment of very high electromotive-forces in the two machines is also deducible from the diagram.

Let Fig. 293, given above, be taken as representing the case where \mathcal{E} is 100 volts and E 80 volts. Now suppose the resistances of the circuit to remain the same while \mathcal{E} is increased to 200 volts and E to 180 volts. (This can be accomplished by increasing the speed of both machines to the requisite degrees.) $\mathcal{E} - E$ is still 20 volts, and the current will be the same as before. Fig. 297 represents this state of

FIG. 297.

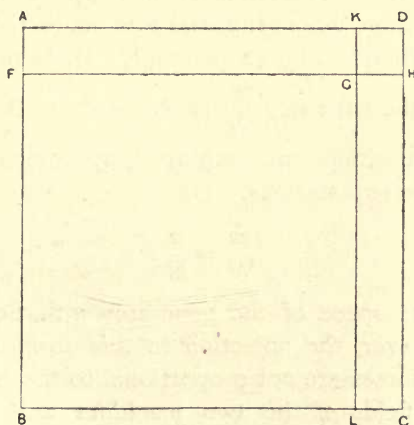

things. The square $KGH D$ which represents the heat-waste is the same size as before; but the energy spent is twice as great, and the useful work done is more than twice as great as previously. High electromotive-force therefore means not only a greater quantity of power transmitted, but a higher efficiency of transmission also. The efficiency of the system in the case of Fig. 293 was 80 per cent.; in the

case of Fig. 297 it is 90 (the dynamos used being supposed "perfect"); and whilst double energy is expended, the useful return has risen in the ratio of 9 to 4.

In the attempt of M. Marcel Deprez to realise these conditions, in the transmission of power from Miesbach to Munich in 1882, through a double line of telegraph wire, over a distance of thirty-four miles, very high electromotive-forces were actually employed. The machines were two ordinary Gramme dynamos, the magnets being series-wound, similar to one another, but their usual low-resistance coils had been replaced by coils of very many turns of fine wire. The resistance of each machine was consequently 470 ohms, whilst that of the line was 950 ohms.* The velocity of the generator was 2100 revolutions per minute; that of the motor, 1400. The difference of potential at the terminals of the generator was 2400 volts; at that of the motor, 1600 volts. According to Professor von Beetz, the President of the Munich Exhibition, where the trial was made, the mechanical efficiency was found to be 32 per cent. M. Deprez has given the rule that the efficiency $\frac{w}{W}$ is obtained, in the case where two identical machines are employed, by comparing the two velocities at the two stations. Or

$$\frac{w}{W} = \frac{n}{N},$$

where N is the speed of the generator, n that of the motor. There is, however, the objection to this formula, that the electromotive-forces are not proportional to the speeds, unless the magnetic fields of the two machines are also equally intense, and the current running through each machine the same. This is not the case if there is any leakage along the line. Moreover, when there are resistances in the line, the ratio of the two electromotive-forces of the machines is not the same as the ratio of the two differences of potentials, as measured between the terminals of the machines.

* These figures, and those which follow, are given on the authority of the President of the Munich Exhibition, Professor von Beetz.

Further, even though the current running through the armatures and field magnets in the generator which creates the current, and in the motor which utilises the current, be absolutely identical, the intensities of the magnetic fields of the two machines are not equal, even though the machines be absolutely identical in build: the reaction between the armature and field magnet is entirely different in the dynamo that is used as a motor from that in the dynamo which is being used as the generator. These reactions are considered below.

Recently M. G. Cabanellas has given an expression for the efficiency of a system for the electric transmission of energy in the following form. Using F as the general symbol for the *fraction* representing the ratio of efficiency, and the suffixes T, G, L, and M as respectively indicating the words *transmission*, *generator*, *line*, and *motor*, then

$$F_T = F_G \times F_L \times F_M.$$

But, using the letters E and e as the electromotive-forces of the generator and motor, and R and r as their internal resistances respectively; and calling the potential at the generator end of the line ϵ and the resistance of the line ρ , we have

$$F_G = \frac{Ei - Ri^2}{Ei}; \quad F_L = \frac{\epsilon i - \rho i^2}{\epsilon i}; \quad F_M = \frac{ei}{ei + ri^2}.$$

Now write for brevity

$$\frac{Ei}{Ri^2} = m; \quad \frac{\epsilon i}{\rho i^2} = m''; \quad \frac{ei}{ri^2} = m',$$

we have

$$F_T = \frac{m-1}{m} \times \frac{m''-1}{m''} \times \frac{m'}{m+1}.$$

This reduces the whole expression for the efficiency of the transmitting system to consideration of three separate quantities of the form $m = \frac{E}{Ri}$ which M. Cabanellas calls the *determinants* of the three parts considered.

Another problem in the electric transmission of power is the following :—Suppose that one were desirous of working a motor, so as to do work at the rate of a specified number of horse-power, and that the wire available to bring the current cannot safely stand more than a certain current, without being in danger of becoming heated unduly. It might be desirable to know what electromotive-force such a motor ought to be capable of giving back, and what electromotive-force must be applied at the transmitting end of the wire. Let P stand for the number of horse-power to be transmitted, and i for the maximum strength of current that the wire will stand (expressed in ampères). Then, by the known rule for the work of a current, since

$$\frac{E i}{746} = P,$$

$$E = \frac{746 P}{i}$$

gives the condition as to what electromotive-force (in volts) the machine must be capable of giving, when run at the speed it is eventually to run at as a motor. Moreover, the primary electromotive-force, \mathcal{E} , must be such that

$$\frac{\mathcal{E} - E}{\Sigma R} = i,$$

where ΣR is the sum of all the resistances in the circuit. Whence

$$\mathcal{E} = E + i \Sigma R.$$

Which is the required condition.

CHAPTER XXIII.

REACTION BETWEEN ARMATURE AND FIELD MAGNETS
IN A MOTOR.

IN Chapter V., pp. 70 to 92, the reactions between the armature and field magnets of a dynamo were considered in detail, but attention was confined solely to that which occurs when the dynamo is used as a generator. In that case the current induced in the armature coils tended to magnetise the armature core in a direction nearly at right angles to the direction in which the field magnets magnetised it, and in consequence there was a resultant magnetisation at an oblique angle. This obliquity compelled a certain angular lead to be given to the brushes in the sense of the rotation ; and the necessary result of the forward lead of the brushes was to cause the polarity of the armature current to tend partially to demagnetise the field magnets. Reference to Fig. 62, p. 71, will show that wherever the brushes are placed there is a tendency to form corresponding poles, and these armature poles tend to produce in the iron pole-pieces of the field magnets an opposite polarity to their own, and therefore to weaken the field. Now in a motor this is not so. A current supplied from an external source magnetises the armature and makes it into a powerful magnet, whose poles would lie, as in the dynamo, nearly at right angles to the line joining the pole-pieces, were it not for the fact that in this case also a lead has to be given to the brushes. Suppose, as in all the drawings in this book, that the S. pole of the field magnets is on the left, and the N. pole on the right. Also that the current so traversed the armature that it caused the highest point to be a S. pole and the lowest point a N. pole. Clearly, in this case, the armature will rotate right-handedly, because the S. pole at the top will be repelled

from the S. pole on the left and attracted toward the N. pole on the right. A still more important effect will be that these two polarities will attract each other. The N. pole on the right tends to induce a S. pole in the part of the armature nearest to it; and there will be a strong resultant S. pole at an oblique position on the right of the highest point. Fig. 298

FIG. 298.

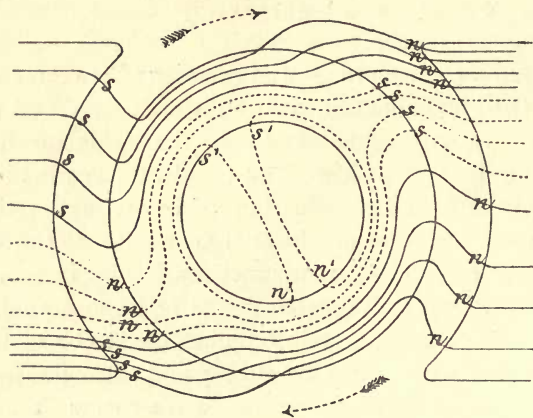

MAGNETIC REACTIONS BETWEEN FIELD MAGNETS AND ARMATURE
IN MOTOR.

shows the course of the lines of force in the mutual field; and shows also how the armature's magnetism reacts on the field magnets, adding to its lines of force (those which are dotted are supposed to be due to the armature), and perturbing its field. Two consequences are at once apparent. The lead to be given to the brushes must be a forward lead* if the proper advantage is to be taken of the mutual strengthening of the two magnetic forces. Also, since the armature polarity strengthens that of the field magnet, it is possible for a motor to be worked without any other means being taken to mag-

* That is to say, in the motor, as in the dynamo, the brushes are displaced a little in the direction of the rotation, if it is desired to get the most powerful rotation, but are displaced a little in the contrary sense if it is desired to work with the least sparking.

netise the field magnets, the armature will induce a pole in the field magnet and then attract itself round toward this induced pole. This principle has been used for many years in small motors, having been apparently first applied by Wheatstone.

But if a forward lead is given to the brushes in order thus to obtain the most powerful torque, then it will be obvious that at the instant that each coil passes the brush it will be actively cutting across the magnetic lines of the mutual field; and there will be much sparking in consequence. If the motor is not to spark, it is essential that there should not be a forward lead, and indeed if the armature's reaction is powerful enough to perturb the magnetism of the field magnets (as in the figure), then there must be given a backward lead if sparking is to be avoided. For, if the armature reaction causes obliquity in the direction of the resultant field, the neutral point will be displaced backwards correspondingly. From this it also follows that if a forward lead is given to the brushes of a motor in order to get a more powerful rotation, the motor will inevitably spark at the brushes. In the former edition of this work, Fig. 298 was given with a forward lead or in the position where the mutual attraction of armature and field magnet was as great as possible: the figure has now been corrected to the position of minimum sparking. In such a position (which is the one that is chosen in practice) the motive power and the efficiency would be small. With a forward lead the motive power and the efficiency would both be much larger, but accompanied by destructive sparking. Minimum of sparking may be reconciled with high efficiency, but only by one way. That way is to design and construct motors so that the armature shall not perturb the magnetic field due to the field magnets. This can only be accomplished by following out the very same principles of design and construction which were found to be correct guides in the case of dynamos used as generators. *The field magnets must be made very powerful in proportion to the armature.* If they are, then there will be no perturbations, no obliquity in the resultant magnetic field, no lead to the brushes, and no sparking. Only for small motors, and in the few cases when

minimum weight is of more importance than high efficiency, can this rule be departed from.

In one respect it is even more important that the rules laid down for the good design of generators should be observed for motors. Eddy-currents must be even more carefully eliminated. In a generator the self-induction in the sections of the armature coil and the eddy-currents in the core are antagonistic; in the motor they tend to increase one another. This remark is due to Mr. Mordey.

A careful comparison should be made between Figs. 64 and 298, which exhibit the magnetic fields of the generator and the motor respectively. In one the armature is mechanically driven round while the magnetic forces in the field tend to pull it back. In the other, the magnetic forces of the field tend to drag it round and it is thereby enabled to do mechanical work. In one case there is an opposing mechanical reaction tending to stop the steam-engine. In the other there is set up an opposing electrical reaction (the induced counter electromotive-force) tending to stop the current.* In both cases the rotation is supposed to be taking place in the same sense—right-handedly. In both the effect is to displace the lines of force of the field, but in the generator the mechanical rotation acts as if it dragged the magnetism round, whilst in the motor, the reciprocal magnetic reactions act as if they tried to drag round the magnetism of the armature and succeeded in producing mechanical rotation. In both drawings there is a lead given to the brushes. In the dynamo as generator we found that the effect of self-induction in the armature was to increase the lead. In the motor, on the contrary, the effect of self-induction is to decrease the lead. If a motor is set with no lead, and if the armature be very powerful relatively to the field magnets, it will run in either direction according

* The law of the electrical reaction resulting in a generator from the mechanical motion is summed up in the well-known law of Lenz, that *the induced current is always such that by virtue of its electro-magnetic effect it tends to stop the motion that generated it.* In the converse case of the mechanical reaction resulting, in a motor, from the flow of electric energy, it is easy to formulate a converse law, viz. that *the motion produced is always such that by virtue of the magneto-electric inductions which it sets up it tends to stop the current.*

as it may be started. If the current be reversed in the *armature part* of the circuit only, the motor will usually reverse its rotation, but will also require the lead to be reversed to run as strongly as before. If instead of reversing the current in the armature the magnetism of the field magnet be reversed, a similar result will follow. If both are reversed at the same time, the motor will go on rotating as if nothing had happened.

Dynamos wound and connected for working as generators of continuous currents may be used in all cases as motors, but with some difference. A series dynamo set to generate currents when run right-handedly (and therefore having a forward right-handed lead), will, when supplied with a current from an external source, run as a motor, but runs left-handedly against its brushes. To set it right for motor purposes requires *either* that the connexions of the armature should be reversed, *or* that those of the field magnet should be reversed (in either of which cases it will run right-handedly), *or* else the brushes must be reversed and given a lead in the other direction (in which case it will run left-handedly). A shunt dynamo set ready to work as a generator will, when supplied with current, run as a motor in the same direction as it ran as a generator; for if the current in the armature part is in the same direction as before, that in the shunt is reversed, and *vice versa*. A compound-wound dynamo, set right to run as a generator, will run as a motor in the reverse sense, against its brushes, if the series part be more powerful than the shunt, and with its brushes if the shunt part be the more powerful. If the connexions are such (as in compound dynamos) that the field magnet receives the sum of the effects of the shunt and series windings when used as a generator, then it will receive the difference between them when used as a motor. There are certain advantages in using a differentially-wound motor, as will appear hereafter.

Some remarks on the action of alternate-current machines as motors are to be found on pages 346 to 349.

CHAPTER XXIV.

SPECIAL FORMS OF MOTOR.

SOME of the earlier typical forms of motor have been described at the beginning of this section. Many of the dynamos described in Chapters VII. to IX. preceding, are used as motors, for example those of Gramme and Siemens; and indeed both Gramme and Siemens dynamos, though designed primarily as generators, make far more efficient motors than any of the earlier electro-magnetic engines of Jacobi, Froment, and Page. Gramme devised about ten years ago a special form

FIG. 299.

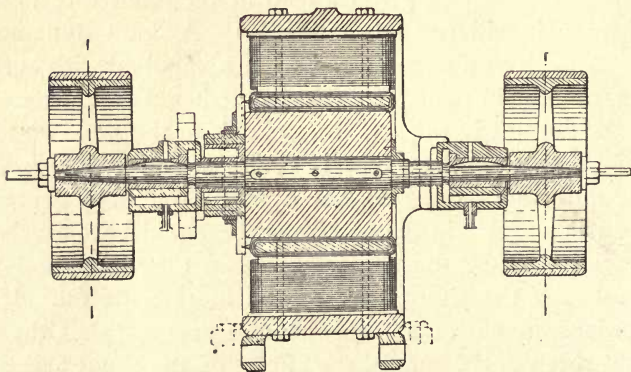

GRAMME'S 4-POLE MOTOR (Section).

of dynamo, represented in Figs. 299 and 300, suitable for the electric transmission of power. It had four pole-pieces surrounding the ring, and four brushes. For special purposes, however, small motors of various types have been introduced in recent years. In 1879 Marcel Deprez introduced a very convenient form of small motor, consisting of a simple shuttle-

wound Siemens armature placed longitudinally between the parallel limbs of a steel magnet. It had a two-part commutator, and consequently had the defect of possessing a dead-

FIG. 300.

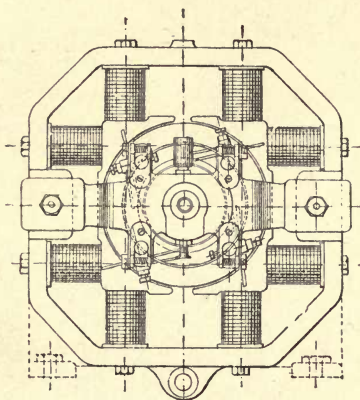

GRAMME'S 4-POLE MOTOR (Elevation).

point. He obviated this defect by employing two armatures, one 90° in advance of the other, so that while one was at the dead-point, the other should be in full action. A very convenient small motor adapted for sewing-machines, has been devised by Griscom (Fig. 301), and is well known both in the United States and in Europe. Like the motor of Deprez, this machine has a simple shuttle armature; but its field magnets are of malleable iron surrounded with coils united in series with the armature. According to Professors Ayrton and Perry a useful power of about $\cdot 015$ horse, with an efficiency of about 13 per cent., is the greatest that the Griscom motor of normal size can maintain.

There is, indeed, such an immense field for useful industrial application of electric motors, so soon as we once have at our disposal regular town supplies of electric currents, that many inventors have turned their attention to this branch. Beside the little motors of Griscom, Howe, Deprez, Cuttriss, and others, adapted to work sewing-machines, and instruments requiring very small power, there are in the market

larger motors, for driving lathes and heavier machinery, though not yet so well known to the public. Messrs. Siemens have brought out an electric lift or elevator, in which a small dynamo, itself running very quickly, drives an endless screw,

FIG. 301.

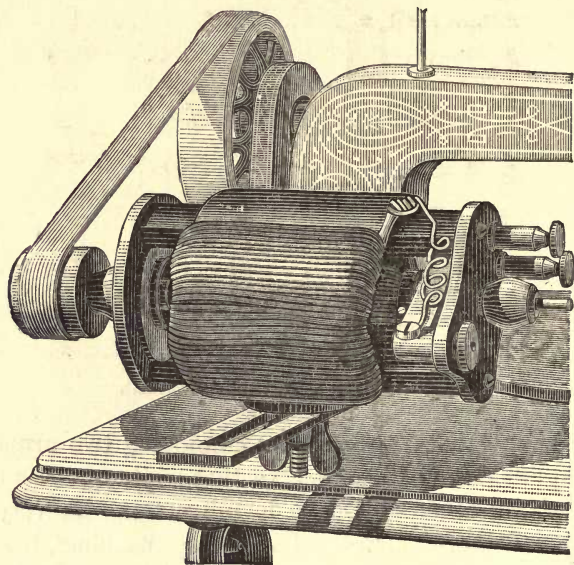

GRISCOM'S ELECTRIC MOTOR.

and communicates a slow, but powerful, motion to a drum, on which the hauling chain is wound. If town supplies of electricity were accomplished facts, such lifts would be multiplied.

Dr. Hopkinson has also invented an electric lift (Fig. 302), in which the armature of the motor, running at a high speed, works the chain of the lift by a train of toothed wheels which reduce the speed. This elevator was shown in operation at the Paris Exposition of 1881.

Another pattern of motor (Fig. 303) has been invented by De Meritens, who employs a ring armature very like that of Gramme, but places it between very compact and light field-magnets, which form a framework to the machine.

A long series of experimental tests of a De Meritens motor

FIG. 302.

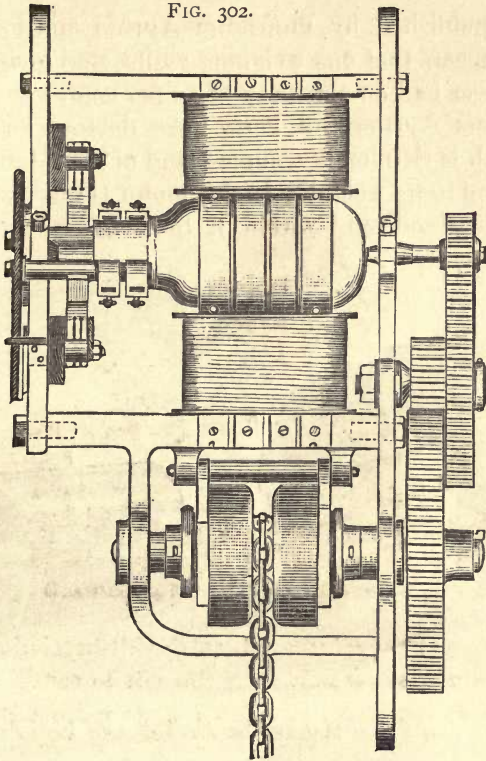

HOPKINSON'S ELECTRIC LIFT.

FIG. 303.

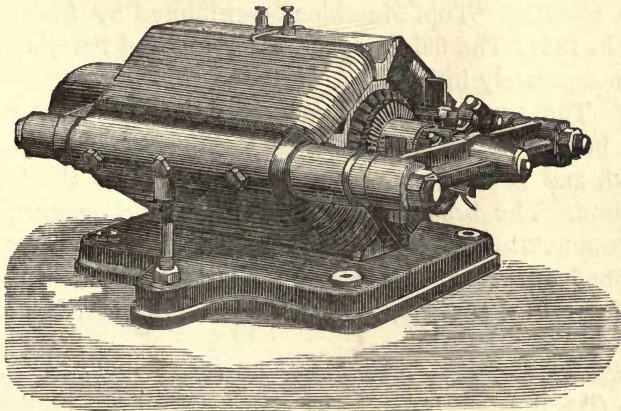

DE MERITENS' ELECTRIC MOTOR.

has been published by Professors Ayrton and Perry,* from which it appears that one weighing 72 lbs. and giving out $\frac{3}{4}$ of a horse-power had an efficiency of 50 per cent.

Professors Ayrton and Perry have devised an ingenious motor which is extremely compact and of considerable power in proportion to its weight. In this motor (Figs. 304, 305) the armature is fixed, and within it the field magnet rotates.

FIG. 304.

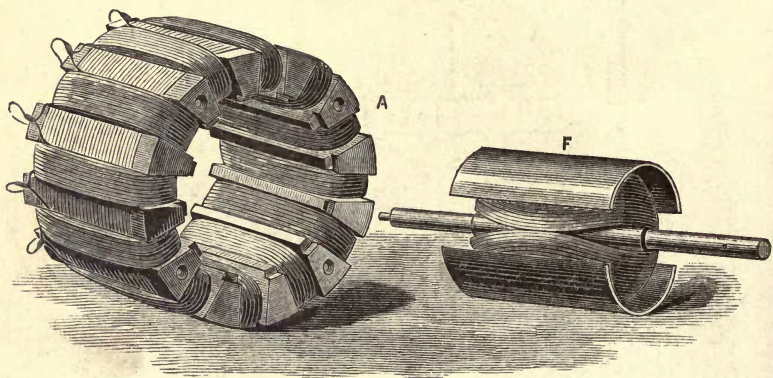

ARMATURE AND FIELD MAGNET OF AYRTON AND PERRY'S MOTOR.

This construction, which permits of the frame being made both light and strong, had previously been attempted in a dynamo—the so-called “Topf-Maschine”—exhibited by Siemens at Paris in 1881. The field magnet of Ayrton and Perry's motor, shown separately in Fig. 304, is of the simple shuttle-wound type. The armature is an enlarged ring of the Pacinotti kind, having protruding teeth, between which the coils are wound, and is built up of flat toothed rings of sheet charcoal iron. The brushes rotate with the field magnet, and the commutator or collector is fixed. The reversing gear described on p. 440 is adapted admirably for use with this machine. Fig. 305 shows one of these motors driving a fan.

* *Journal of the Society of Telegraph-Engineers and Electricians*, vol. xii., No. 49, 1883.

These motors are usually series-wound; but we owe to these indefatigable workers in this field the theory* of adapting the compound-winding for the purpose of making motors self-governing. They have introduced the differential system of winding into a few of their machines. Their motor weighing 37 lbs. and giving out $\frac{1}{2}$ of a horse-power at 1570

FIG. 305.

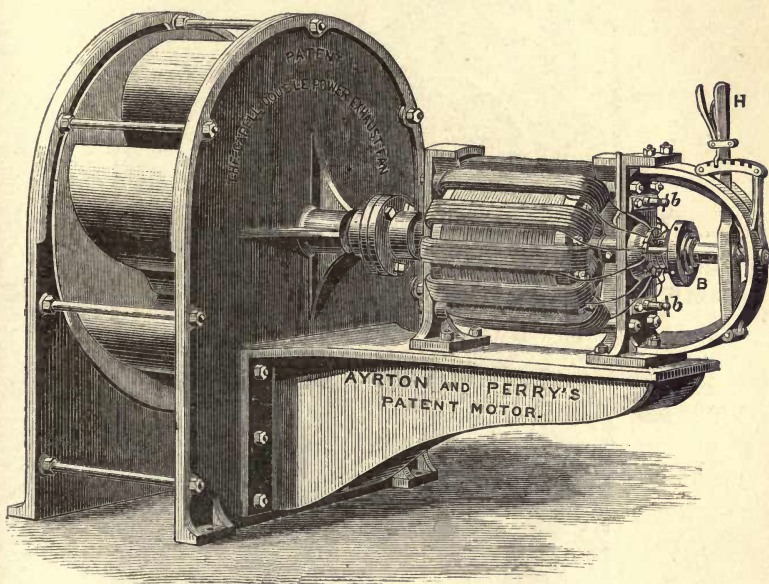

ELECTRIC MOTOR DRIVING VENTILATING FAN.

revolutions per minute showed a nett efficiency of 40 per cent. The armature is made large and powerful relatively to the field magnets in order to utilise their mutual reactions to obtain the most powerful rotation relatively to the weight.

* The theory of Professors Ayrton and Perry includes much more than this, and extends to all the cases mentioned below of shunt or series windings combined with an independent constant magnetism, or with an independent magneto machine on the same axle. Their memoir in the *Journal of the Society of Telegraph Engineers* (May 1883) is a mine of suggestive information. The specification of their British patent includes nearly all the possible combinations for self-regulation, as well as many other methods for governing motors by periodic and centrifugal governors like those of steam-engines.

FIG. 306.

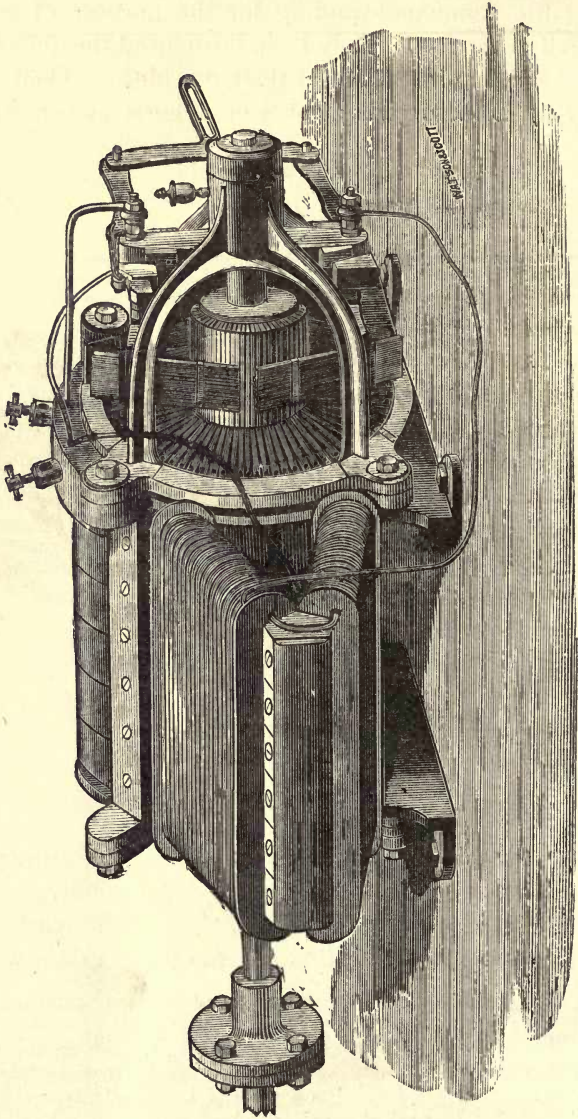

RECKENZAUN'S MOTOR.

The following data are taken from results of tests made on various forms of Ayrton and Perry's motors :—

Weight of Motor in lbs.	Horse-power actually given out at the Rotating Shaft.
37	0·35
55	0·50
75	0·75
96	1·50
125	2·20

Mr. A. Reckenzaun has devised a motor which is both strongly-built and powerful, and at the same time extremely light (Fig. 306). It is well fitted for use in boats and vehicles. The field magnets are constituted by the iron framework. The armature is made of a number of small iron links, from 300 to 3000 according to the size of the machine, wound with wire and united by bolts into a strong, light, polygonal frame, thus securing good ventilation. They are usually fitted with two pairs of brushes and a reversing gear. One of these motors, weighing 124 lbs., series-wound, having a resistance of 0·564 ohm between its terminals, and designed to be run normally with an electromotive-force of 70 volts, gave the following tests :—

Revolutions per Minute.	Current in Ampères.	E.M.F. in Volts.	Horse-power on Dynamometer.
1158	24·8	43·3	0·86
1436	25·6	53·3	1·07
2184	26·2	71·6	1·54
1724	39·4	70	2·13
1554	47·6	76	2·4
1931	50	95	2·87

This is at the normal rate of 558 foot-pounds of work per minute for every pound of dead weight in the motor itself. A similar motor, but wound with finer wire to run at 120 volts, gave 550 foot-pounds per minute per pound of dead weight.

This motor may be compared with a Siemens dynamo weighing 519 lbs., which at 906 revolutions per minute gave,

according to Professors Ayrton and Perry, 4·96 horse-power, with an efficiency of 74·6 per cent. Another Siemens "D₂" machine, employed as a motor in the electric launch shown at the Vienna Exhibition in 1883, gave 7 horse-power on the shaft while absorbing 9 electric horse-power; an efficiency of about 78 per cent. It weighed 658 lbs.; there being 1 lb. of dead weight for each 351 foot-pounds per minute exerted at the shaft.

A compact form of motor, due to M. Gramme, is shown in Fig. 307. The ring armature revolves between the polar

FIG. 307.

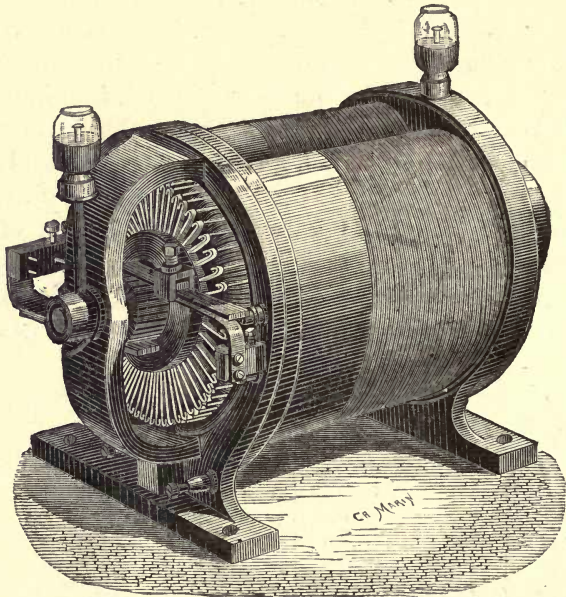

GRAMME'S MOTOR.

ends of an electro-magnet which is constituted by a back plate of cast iron, and two parallel limbs having a D-shaped section. The end of the shaft and the poles of the magnet are received by a front plate of gun-metal. One of these machines wound with wire of 1 millimetre diameter, running at 83·5 volts with 8·1 ampères gave 39 kilogrammetres per

second as its mechanical output. Another motor built more lightly, and weighing 10·4 kilogrammes, gave 40 kilogrammetres per second output, or nearly 800 foot-pounds per minute per pound weight of the machine.

In a very compact motor designed by Bürgin, the armature is spherical, and the field magnets are constructed as an outer spherical shell.

For light work the author has designed a small motor which has some advantages over those of Deprez and of Griscom. The field magnets, which also constitute the bed-plate of the motor, are of malleable cast iron, of a form that can be cast in one or at most two pieces. The form of them is that of a Joule's magnet, with large pole-pieces, and wound with coils, arranged partly in series, partly as a shunt, in certain proportions, so as to give a constant velocity when worked with an external electromotive-force of a certain number of volts. For the armature a simple form is employed which without any unnecessary complication obviates dead-points. This result is attained by modifying the old Siemens armature by embedding, as it were, one of these shuttle-shaped coils within another, at right angles to one another. And having duplicated the coils, the segments of the commutator must also be duplicated, so that it becomes a 4-part collector. There are no solid iron parts in the armature, but the cores are made of thin pieces of sheet iron, stamped out and strung together. For larger motors an armature having a larger number of sections and a greater moment of inertia is preferable. For small motors a 4-part armature suffices. Even if the impulses be intermittent, the mechanical inertia of the moving parts will steady the motion. In the case of generators, we found that to produce steady currents we had to multiply coils on the armature in many separate paths, grouped round a ring or a drum, involving a complicated winding, and a collecting apparatus consisting of many segments. In motors no such necessity exists, provided only we arrange the coils so that there shall be no dead-points. For large motors it may be advisable to multiply the paths and segments for other reasons—as, for example, to obviate

sparking at the collectors—but for securing steady running the inertia of the moving parts spares us—at any rate, in small machines—the complication of parts which was expedient in the generator.

Dynamos of the open-coil class can also be used as motors. Both the Brush and the Thomson-Houston dynamo have been so used.

A great many forms of electric motor have been lately introduced and patented, chiefly in the United States. Few of these possess any originality in principle, save perhaps in the methods of regulation of speed.

For the various applications of electric motors to tram-cars, electric railways, electric launches and other boats, balloons, and other kindred purposes, the reader is referred to the technical journals, and to the following works:— Du Moncel and Gerald's *Electricity as a Motive Power*; Raineri's *La Navigazione Elettrica*; Hospitalier's *Modern Applications of Electricity*; &c.

CHAPTER XXV.

REVERSING GEAR FOR MOTORS.

A MOTOR, as will be seen from the preceding discussion, can be reversed by the operation of reversing the current through the armature, and at the same moment reversing the lead. But reversing the current can also be accomplished by rotating the brushes through 180° . Consequently, both these actions may be accomplished by the single operation of advancing the brushes through $180^\circ - 2\phi$, where ϕ is the original angle of lead. But as the brush would then slant in the wrong direction, it is better to provide a second set of brushes. This is, indeed, Hopkinson's method of reversing. He employs two pairs of brushes, each pair being capable of moving about a common pivot, so that either the pair having a lead in one direction, or the pair having a lead in the other direction can be let down upon the collector. A reversing gear designed by Mr. A. Reckenzaun for the motors of the launch *Electricity* is shown in Fig. 3c8. In it there are two pairs of brushes; the two upper are fixed to a common brush-holder, which turns on a pivot, and can be tilted by pressing a lever handle to right or to left. The two lower brushes are also fixed to a holder. Against each brush-holder presses a little ebonite roller, at the end of a bent steel spring, fixed at its middle to the handle. The result of this arrangement is that, by moving the lever, the brushes can be made to give a lead in either direction, and so starting the motor rotating in either direction. Such a reversing gear is obviously a most useful adjunct for industrial applications of motors, and if the difficulties of sparking at the brushes caused by the sudden removals of them from the collector be obviated, must prove much better than any mechanical device to reverse the

motion by transferring it from the axle of the motor through a train of gearing to some other axle. One great advantage of electric motors is, that they can be easily fixed directly

FIG. 308.

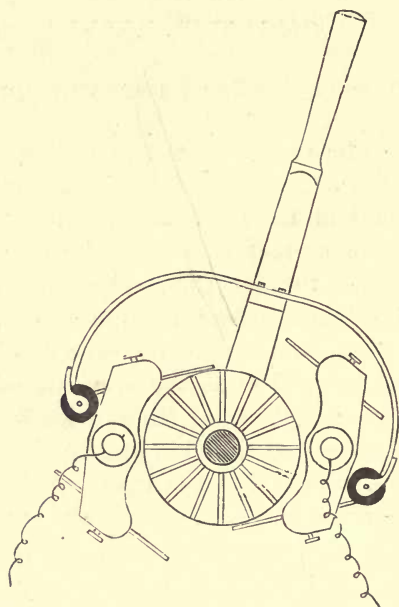

REVERSING GEAR FOR ELECTRIC MOTOR.

on the spindle of the machine which they are to drive; an advantage not lightly to be thrown away.

Another form of reversing gear has been designed by Professors Ayrton and Perry. It consists of a double collar upon the spindle of the motor; in one, the inner collar, having a pin fitting into a spiral groove in the spindle, and being free to move relatively to the spindle. Any displacement along the spindle given to the inner collar through the outer one causes the pin in the former to move along the groove, and the collar rotates through a certain angle. This collar in Ayrton and Perry's motor carries the brush-holders, and therefore by rotating alters the lead. The motor shown in Fig. 305

is fitted with this gear, though useless for driving a fan. Other forms of reversing gear for small motors have been designed by the author, who cuts the segments of the collector or commutator spirally, and therefore obtains a change of lead by simply sliding the brushes forward or backward parallel to the axle of the motor.

In Reckenzaun's motor (Fig. 306) the reversing gear consists of two pairs of brushes which are mounted so as to slide on guides or ways; reversal being accomplished by shifting a lever which slides forward one pair whilst it draws the other pair back.

It is also theoretically possible to construct a motor which shall reverse by simply reversing the current in the armature part; for this end, the pole-pieces must be so shaped that when no angular lead is given to the brushes, the angle between the diameter of commutation and the effective pole in the pole-piece shall be that required for steady running. If this can be found, then merely reversing the polarity of either part will reverse the motor.

If the field magnets of a motor are so powerful relatively to the armature that no lead has to be given to the brushes, the rotation can be reversed by reversing the polarity of either part.

CHAPTER XXVI.

RELATION OF SPEED AND TORQUE OF MOTORS TO THE CURRENT SUPPLIED.

CERTAIN very important relations subsist between the condition of the electric supply and the speed and turning-moment of a motor.

As mentioned in the paragraphs on p. 108, concerning the governing of generators, the power transmitted along a shaft is the product of two factors, the speed and the torque (or turning-moment). If ω stands for the angular velocity and T for the torque,* then

$$\omega T = \text{mechanical work per second, or "activity,"}$$

and this, measured electrically, is equal (save for the fraction lost in friction, &c.) to the electric energy absorbed per second, or, if E is the electromotive-force of the motor, and i the current through its armature,

$$E i = \text{electric work per second (in watts †).}$$

* If n be the number of revolutions per second, then $2\pi n = \omega$. Also if F be the transmitted pull on the belt (or rather the difference between the pull in that part of the belt which is approaching the driving pulley and the pull in that part which is receding from the driving pulley) in pounds' weight, and r be the radius of the pulley, $F r$ = the turning-moment or torque = T , then $\omega T = 2\pi n r F$ = the number of foot-pounds per second transmitted by the belt. This may also be proved as follows: Horse-power is product of the force into the velocity. The circumference of the pulley is $2\pi r$, and it turns n times per second, therefore the circumferential velocity is $2\pi r n$, and this, multiplied by F , gives the work per second. If F is expressed in grammes' weight, and r in centimetres, then $2\pi r n F$ will give the activity in gramme-centimetres, and must be divided by 7.6×10^6 to bring it to horse-power, and must be multiplied by 981×10^{-7} to bring it to watts.

† Since 1 volt = 10^8 C.G.S. units, and 1 ampère = 10^{-1} C.G.S. units, 1 watt (or volt-ampère) will be = 10^7 C.G.S. units of work per second = 10^7 ergs per second = $10^7 \div 981$ gramme-centimetres per second.

Now we know that if the current running through a series dynamo be constant, the electromotive-force it develops is almost exactly proportional to its speed. It therefore follows that if E is proportional to ω , T will be proportional to i . This is abundantly verified in the case of a series motor by experiments. When a Siemens series dynamo was arranged to lift a load of 56 lbs. on a hoist, it lifted this load at the rate of 212 feet per minute, developing a counter electromotive-force of 108.81 volts. The applied electromotive-force was 111 volts and the resistance of the circuit was 0.3 ohm. The effective electromotive-force was therefore 2.19 volts and the current 7.3 ampères. When the resistance of the circuit was increased to 2.2 ohms the speed fell to 169 feet per minute, the counter electromotive-force to 94.94; the effective electromotive-force, $\mathcal{E} - E$, was therefore 16.06 volts and the current 7.3 ampères as before. When 4.8 ohms were inserted the speed fell to 141 feet per minute, and E to 76 volts. $\mathcal{E} - E$ was 35 volts, and the current 7.3 ampères as before. *With the same load, the same current, whatever the speed.* The figures given on p. 435, relative to the Reckenzaun motor also illustrate this point. The speed of a given series-wound motor depends solely on the electromotive-force of the generator and on the resistance of the circuit.

The fact that the torque of a series motor depends only on the current is of advantage in the application of motors to propulsion of vehicles (such as tram-cars) which at starting require for a few seconds a power greatly in excess of that needed when running. To start, a large current must be turned on. One convenient way of arranging this is to use two motors, coupled habitually in series. When starting, they are, by moving a commutator, coupled in parallel. This doubles the electromotive-force for each, and at the same time halves the resistance. For a few seconds a very strong current flows—much stronger than that which the motors would stand for any prolonged work—and so provides the needful additional torque.

In the series motor, when supplied at constant potential E is not proportional to the speed, because the field magnetism

is not constant, but falls off as E increases, being (if unsaturated) nearly proportional to $\mathcal{G} - E$. It therefore will not run at a constant speed. Neither will it run at a constant speed if supplied with a constant current.

In the case of the shunt motor, if supplied at constant potential, its field magnetism is constant, and E will be very nearly proportional to the speed. But $\mathcal{G} - r_a i_a = E$; and if r_a is (as it should be) very small, E will be very nearly equal to \mathcal{G} , and therefore will be nearly constant. Hence the speed also will be nearly constant. If supplied with a constant current, the speed of the shunt motor increases with the load. This was incorrectly stated in the former edition.

CHAPTER XXVII.

GOVERNMENT OF MOTORS.

IT is extremely important that electric motors should be so arranged as to run at a uniform speed, no matter what their load may be. For example, in driving a lathe, and indeed many kinds of machinery, it is essential that the speed should be regular, and that the motor should not "run away" as soon as the stress of the cutting tool is removed.

One of the earliest attempts to secure an automatic regulation of the speed, was that of M. Marcel Deprez, who in 1878 applied an ingenious method of interrupting the current at a perfectly regular rate by introducing a vibrating brake into the circuit. The motor employed had a simple 2-part commutator whose rotation timed itself to the makes-and-breaks of the current. One of Deprez's motors thus governed was shown in Paris some four or five years ago. It ran at a perfectly uniform speed, quite irrespective of the work it was doing. Whether it was lifting a load of 5 kilogrammes from the ground, or was letting this load run down to the ground, or ran without any load at all, the speed was the same. This method is however inapplicable to large motors.

Centrifugal Governing.

Another suggestion, equally impracticable on the large scale, was to adopt a centrifugal governor to open the circuit whenever the motor exceeded a certain speed. A motor so governed runs spasmodically fast and slow. It is also possible for a centrifugal governor to be employed to vary the resistance of a part of the circuit; for example, to work an automatic adjustment to shunt part of the current of a series machine

from its field magnets (resembling the automatic regulator of the Brush dynamo, p. 97), or to introduce additional resistance into the field-magnet coils of a shunt-wound machine, in proportion to the speed.

Professors Ayrton and Perry have also proposed several forms of "periodic" centrifugal governor, a device by which in every revolution power is supplied during a portion of the revolution only, the proportion of the time in every revolution during which the power is supplied being made to vary according to the speed. The main difficulty with such governors is to prevent sparking. But there is a still more radical defect in all centrifugal governors; they all work too late. They do not perform their functions until the speed has changed. The perfect governor will not wait for the speed to change.

Dynamometric Governing.

The author has devised another kind of governor which is not open to this objection. He proposes to employ a dynamometer on the shaft of the motor to actuate a regulating apparatus which may consist either of a periodic regulator to shunt or interrupt the current during a portion of each revolution, or of an adjustable resistance connected in part of the circuit. The dynamometric part may take the form of a belt dynamometer (such as Alteneck's) or of a pulley dynamometer (such as Morin's or Smith's). In the latter case, which is the more convenient, a loose pulley runs on the motor shaft and is connected by a spring arrangement with a fixed pulley. The rotation of the motor will drag round the fixed pulley in advance of the loose pulley, and the angular advance will be proportional to the turning moment or torque. The amount of such angular advance determines the action of the regulating part. The regulator in this case is therefore worked, not according to the speed of the motor, but according to the load it is carrying. Any change in the load will instantly act on the dynamometric governor before the speed has time to change.

Electric Governing.

Another method of governing, not requiring any rotating parts, has been proposed by the author. He uses as field magnets a double set of poles, set at different angles with respect to the brushes of the motor. One pair of magnetic poles, having a certain lead, is actuated by series coils, the other pair, having a different lead, by shunt coils. When both shunt and series are working, there will, of course, be a resultant pole having some intermediate lead. If the load of the motor is diminished, it will tend to run faster, increasing the current in the shunt part, decreasing it in the series part, and therefore altering the effective lead and preventing the increase of speed.

In 1880 a motor was patented by Mr. G. G. André in which the field magnets were wound in two separate circuits, one of thick and the other with thin wire, the current dividing between them, and the armature was connected as a bridge across these circuits, exactly as the galvanometer is connected across the circuits of a Wheatstone's bridge. Motors governed on this principle have more lately been constructed by Mr. F. J. Sprague; they show remarkably good regulation.

Another method of governing, due to Mr. C. F. Brush, consists in building up the field-magnet coils in sections, and by varying the number of sections in circuit, or the mode of their connexion, he proposes to obtain an automatic regulation.

The method of constructing a motor with coils in sections so that a movable internal core may be successively attracted as successive sections are switched in, has been made use of by Deprez in constructing an electric hammer. This principle of construction had been employed by Page in his motors many years previously.

The method of automatic regulation that is most perfect in theory, is undoubtedly that imagined by Professors Ayrton and Perry, and expounded in their paper in the *Journal of the Society of Telegraph Engineers*.* The theory of self-regulation propounded by them demands the most careful

* Vol. xii., May 1883.

attention. It is expounded in the following pages ; but it is only fair to readers to mention that in order not to have any confusion in the use of symbols, the notation of Professors Ayrton and Perry has not been followed : the symbols employed have the same meaning as in the chapters which precede. Neither has the author adopted that part of Professors Ayrton and Perry's argument which regards one part of the motor as acting as a brake to another part. This way of regarding the matter, though doubtless propounded originally with good reasons, does not commend itself to the minds of students generally. The author prefers to regard the use of a shunt winding opposing a series winding—which is the final result of this method of regulation—as simply a differential winding designed to produce a certain result.

Theory of Self-regulating Motors.

In the chapter on Governing Dynamos, and in the algebraic development on pp. 302 to 323, were set forth the methods of solving the problem how to arrange a dynamo so that it shall feed the circuit with electric energy under the condition either of a constant potential or of a constant current, when driven at a constant speed. The solution to that problem consisted in the employment of certain combinations for the field magnets, which gave an initial magnetic field independent of the current that might be flowing in the main circuit.

Now it is not hard to see that this problem may be applied conversely, and that motors may be built with a combination of arrangements for their field magnets, such that, when supplied with currents under one of the two standard conditions of distribution, their speed shall be constant whatever the load. It will be evident without any numerical calculations that the windings must oppose one another—one must tend to demagnetise the field magnet, the other to magnetise. Take the case of a shunt motor supplied at a constant potential \mathcal{E} , and running at a certain speed with a certain load. If the

load is suddenly removed the motor will begin to race, its racing will increase the counter electromotive-force developed, and will partly cut down the armature current. But the decrease of current will not be quite adequate to bring back the speed, because of the internal resistance of the armature which has prevented the whole energy of the armature current from being utilised as work. A demagnetising series coil of appropriate power wound on the field magnet will, however, effect what is wanted, for then with any increase of speed the resulting reduction in the field magnetism will at once bring down the driving power. The combination may, therefore, rightly be regarded as a differential winding.

As the windings of self-regulating motors are different in the two cases of distribution, they will be considered separately.

Supply at Constant Potential.

Case (i). Magneto Motor with Series-regulating Coil.—Using the same notation as previously we have for the counter electromotive-force developed in the armature—

$$E = 4 n A H.$$

Now H is made up of two parts, a *temporary* part, which may be written $G \kappa S i$, because it depends on the current i , on the number of coils S , on the permeability of the iron κ , and on the geometrical constant G of the core and pole-pieces; and a *permanent* part, which may be written H_1 , or $G \kappa M$, where M is a certain constant representing the permanent magnetism. Then

$$H = G \kappa (M - S i),$$

since the temporary magnetism of the series coils is less than, and opposes the permanent magnetism. This gives us—

$$E = 4 n A G \kappa (M - S i),$$

whence,

$$n = \frac{E}{4 A G \kappa (M - S i)}.$$

Now E can be expressed in another way; for, if \mathcal{E} be the constant potential of the supplying mains, and $r_a + r_m$ be the resistance of the motor,

$$i = \frac{\mathcal{E} - E}{r_a + r_m},$$

or

$$E = \mathcal{E} - (r_a + r_m) i,$$

whence

$$n = \frac{\mathcal{E} - (r_a + r_m) i}{4 A G \kappa (M - S i)}, \quad [\text{LI.}]$$

and this is to be a *constant*. This cannot be so unless

$$\frac{\mathcal{E}}{M} = \frac{r_a + r_m}{S}, \quad [\text{LII.}]$$

which is the condition of self-regulation. If this condition is observed, then the constant velocity of the motor will be defined by the equation

$$n = \frac{\mathcal{E}}{4 A H_1} = \frac{r_a + r_m}{S} \cdot \frac{I}{4 A G \kappa}. \quad [\text{LIII.}]$$

This velocity, which is the critical velocity for the potential \mathcal{E} , can be ascertained by experiment, for it is *that speed at which the motor, driven as a dynamo on open circuit* (i. e. when the only magnetism is the permanent part), *will yield an electromotive-force equal to that of the supply at the mains*. It is evident therefore that by making the permanent magnetism stronger, the critical speed can be reduced to any desired value.

*Practical Determination of the Proper Potential and Winding
for Given Motor.**

Suppose a motor having a certain steel magnet and a certain armature be given, and let it be required to determine the potential at which it will give a certain constant speed, and the winding that must be adopted for the demagnetising coil. Two experiments are needful. First, run the motor on open circuit as a generator at the given speed, and observe the

* It should be pointed out that this process differs from that suggested by Professors Ayrton and Perry in their paper on electromotors, in *Journ. Soc. Telegr. Eng.*, May 1883. Their method depends on the volume left on the bobbins of the field magnets, which is assumed to be constant.

potential at its terminals. That is the number of volts \mathcal{E} with which it must be supplied. Secondly, connect in series with the armature a resistance a little less than r_a (say five-sixths as great) to represent r_m . Prepare some accumulators to give the proper potential \mathcal{E} of supply. Wind a temporary coil of S turns on the field magnet by which to excite these temporarily with a demagnetising power from some separate source of current that can be varied. Provide an ampère-meter to measure this exciting current and a second ampère-meter to observe the armature current. Then by means of a suitable dynamometric brake, put on the axle of the motor its normal maximum load. Supply its armature with current at potential \mathcal{E} , and vary the magnetisation in the temporary coil until the proper speed is once more attained: note the actual armature current i_a and the temporary exciting current i'_m . Then it is clear that the number of turns required will be

$$S = \frac{S' i'_m}{i_a},$$

and it only remains to choose a wire such that S turns will have a resistance equal to r_m .

Case (ii). Shunt Motor with Series-regulating Coil.—This really includes two cases: where the shunt is a shunt to the armature only, and where the shunt is a “long shunt” placed across the terminals of the machine (as in Fig. 235, p. 312). The latter case, which is the best in practice, is the one chosen for calculation here. Then

$$E = 4 n A G \kappa (Z i_s - S i_a),$$

and

$$E = \mathcal{E} - (r_a + r_m) i_a,$$

and

$$\mathcal{E} = r_s i_s;$$

whence

$$n = \frac{r_s i_s - (r_a + r_m) i_a}{4 A G \kappa (Z i_s - S i_a)};$$

and this is to be constant. Whence we get as the necessary condition,*

$$\frac{S}{Z} = \frac{r_a + r_m}{r_s}, \quad [\text{LIV.}]$$

* Or, if the magnetisation due to the reaction of the armature be taken into account, as on p. 455, we must write $\frac{S - A'}{Z}$, instead.

and the speed n is determined by the equation

$$n = \frac{r_s}{4 A G \kappa Z}$$

$$n = \frac{\mathcal{E}}{4 A G \kappa Z i_s} \quad \text{[LV.]}$$

In other words Z and r_s must be such that if the motor be driven on open circuit at the desired speed n , the terminal potential generated will be equal to \mathcal{E} .

Determination of the Windings.

As in the preceding case, a temporary coil must be wound and separately excited, a resistance equal to the future r_m being added to the armature resistance. Two experiments are required. Run the motor first with no load at the brake, using the proper potential \mathcal{E} , and excite the temporary coil, observing the number of ampère-turns that are needful to bring the speed down to the required n . The number of ampère-turns in this case—call them P —is equal to $Z i_s - S i_a$, where i_s is the current which economy dictates should be used in the shunt, and i_a the actual current observed in the armature during the experiment. Secondly, run the motor with its fullest load at the brake, and again excite the field magnet with such a number of ampère-turns Q , that the speed is constant at n . The current i'_a observed will now be different. We have then—

$$P = Z i_s - S i_a$$

$$Q = Z i_s - S i'_a$$

$$\frac{P - Q}{P - Q} = S (i'_a - i_a)$$

whence

$$S = \frac{P - Q}{i'_a - i_a};$$

and Z can be determined from the ratio given in equation [LIV.].

There is, however, one serious difficulty presented in the working of the differentially wound motors constructed on the theory of Professors Ayrton and Perry. If the current is suddenly turned on to start them, seeing that the armature is standing still, and is not developing a counter electromotive-force, the greater part of the current runs through the armature and series coil, and very little through the shunt. The result is that the shunt coil which ought to provide the chief part of the magnetism is less powerful than the demagnet-

ising series coil, and the motor starts wrong way. The defect might be remedied by cutting out the series coil until the motor has got up speed, or by starting the motor by hand and then turning on the current.

Supply with Constant Current.

If the condition of supply is that of a constant current, independent of the work of the motor, the case is different. The chief of the possible combinations are :—

- (a.) Magneto motor with shunt-regulating coils.
- (b.) Series motor with shunt-regulating coils.
- (c.) Series motor with long-shunt regulating coils.

The latter two, with differential winding, are the only important cases.

Case (i.). Series Motor with Shunt-regulating Coils.—

$$E = 4 n A G \kappa (S i - Z i_s);$$

$$E = r_s i_s - r_a i_a;$$

$$i_a = i - i_s; \text{ (} i \text{ being the constant current);}$$

whence

$$n = \frac{(r_s + r_a) i_s - r_a i}{4 A G \kappa (S i - Z i_s)},$$

giving as the equation of condition

$$\frac{Z}{S} = \frac{r_s + r_a}{r_a}, \quad \text{[LVI.]}$$

and as the critical speed

$$n = \frac{r_a i}{S i} \cdot \frac{1}{4 A G \kappa}. \quad \text{[LVII.]}$$

Now $r_a i$ is that electromotive-force which is competent to send a current equal to the given current through the armature resistance. Therefore it follows that the critical speed is such that the motor when run as a dynamo at that speed will give an electromotive-force equal to $r_a i$ when the only magnetising power is that due to the constant current i running through the series coil of S turns.

Determination of the Windings.

The following process determines the windings. Connect across the brushes a temporary resistance equal to what r_s will be, and insert an ampère-meter in this shunt. Put temporary coil of known number of turns on field magnet, and excite independently, observing the number of ampère-turns. Send a current equal to the constant current i through the shunted armature, and vary the excitement until the speed n is obtained. Observe first, the number of ampère-turns P required to excite when there is no load on the motor, the shunt current observed being i'_s . Secondly, observe the ampère-turns Q required to excite when the motor has maximum load, shunt current being now i''_s . Then

$$P = S i - Z i'_s;$$

$$Q = S i - Z i''_s;$$

$$Q - P = Z (i'_s - i''_s),$$

whence

$$\frac{Q - P}{i'_s - i''_s} = Z.$$

And then S can be determined by the equation [LVI.], or from P .

Case (ii). Series Motor with Long-shunt Regulating Coils.—

$$E = 4 n A G \kappa (S i_a - Z i_s);$$

$$E = r_s i_s - (r_a + r_m) i_a;$$

$$i_a = i - i_s;$$

$$n = \frac{(r_a + r_m) i_a - r_s i_s}{4 A G \kappa (S i_a - Z i_s)},$$

which cannot be constant unless also the condition is fulfilled that

$$\frac{Z}{S} = \frac{r_s}{r_a + r_m}. \quad \text{[LVIII.]}$$

The practical process for determining the winding will be similar to the last, and is left to the student to think out.

In all the preceding equations no account is taken of the reaction of the armature's magnetism upon the field magnets.

In motors, however, this reaction, which has the effect of strengthening the magnetising coils of the field, is by no means negligible; especially in those motors in which the armature part is large and powerful is this effect important. It would

be possible, moreover, to take into account the magnetising effect of the armature by introducing into the expression for H a term proportional to the current in the armature i_a and to the armature coefficient A . For example, the first equation of the last preceding case will become,

$$E = 4 n A G \kappa (S i_a + A' i_a - Z i_s),$$

where A' is the new term. The equation of condition No. [LVIII.] would then become

$$\frac{Z}{S + A'} = \frac{r_s}{r_a + r_m}.$$

A special experiment would be required for each motor to determine the value of A' .

Moreover, all questions of self-induction have been left out, as we have assumed here, as in the case of dynamos used as generators, that though self-induction is in every case deleterious, its deleterious effects can be diminished to a very small quantity by proper designing of the machine.*

The efficiency of a differentially-wound motor cannot be expected to be as high as that of one which is non-differentially wound, since the energy expended in the former case in magnetising the field magnets is greater, relatively to the amount of magnetisation produced.

A further suggestion for governing motors is due to Mr. W. M. Mordey and Mr. C. Watson. They wind an armature with two coils having separate commutators. The brushes of one are connected as a shunt to the terminals of the machine; those of the other are joined in series with the series coil of the field magnet, and the currents traverse them differentially.

Still more important is the discovery by Mr. Mordey that if a pure shunt motor is constructed upon perfect designs,—that is to say, having very small resistance of armature and very large resistance of shunt, and having also field magnets which are very powerful relatively to the armature, and an

* Some elaborate observations upon compound-wound motors, when worked with constant potentials and constant currents, have been published by Dr. Frölich in the *Elektrotechnische Zeitschrift* for June 1885.

armature properly laminated and sectioned so as to reduce eddy-currents and self-induction to a minimum,—such a shunt dynamo if supplied from mains at a constant potential will run at a constant speed, whatever the load.* The following tests showed a constancy to within $1\frac{1}{2}$ per cent. for all loads within working limits.

Potential at Terminals.	Current (Ampères).	Horse-power at Brake.	Revolutions per Minute.
68·4	44	1·1	1125
68·4	126	7·4	1120
68·4	165·5	10·36	1115
68·4	180	11·14	1110

With a lower electromotive-force the same motor regulated almost equally well, but at a lower speed. It was observed that, especially when the motor was giving out small horse-power, that the speed was increased by *weakening* the field.

* This might have been foreseen from the equations of p. 451, in which if $r_a + r_m = 0$, the condition of regulation will give $S = 0$.

CHAPTER XXVIII.

MOTOR PROBLEMS SOLVED BY GRAPHIC METHODS.

OF the following problems, the first two relate to series motors, and are due to Dr. E. Hopkinson and to Mr. Alexander Siemens.*

Given a system of distributing mains supplying electricity at a constant potential \mathcal{E} , it is required to construct a motor which when working with a given load shall make n revolutions per minute.

Taking, in Fig. 309, as usual, the currents as abscissæ, and the electromotive-forces as ordinates, draw OM to represent the potential \mathcal{E} of the main in volts. Now, makers of dynamos know from experience what percentage of the electrical

FIG. 309.

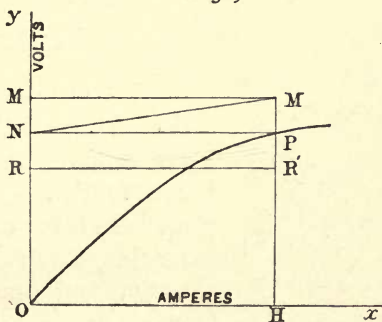

energy supplied to a machine of the type they make is absorbed in maintaining the magnetic field. Take a point N in OM such that $NM \div OM$ represents this percentage. Also it is known what percentage of the energy thus taken up by the armature, and converted into mechanical work, is

* *Journal of the Society of Arts*, April 1883.

coefficient of the machine of the type that is to be used as generator. Then the proper generator will be that which when running at the proper speed will have a characteristic running through O and Q; and the tangent of the angle $M' M Q$ represents the resistance of the armature and field magnet of the generator.

The following problem is due to Dr. J. Hopkinson:—

Given the characteristic of the generator, it is required to determine the maximum work which can be transmitted when the electromotive-force of the generator depends on the current passing through its armature.

This problem arises from the failure of Jacobi's law of maximum activity to take into account the reactions in the magnetism of the field arising from the armature. Were it not for these reactions the activity of the motor would be greatest when the counter electromotive-force of the motor

FIG. 310*.

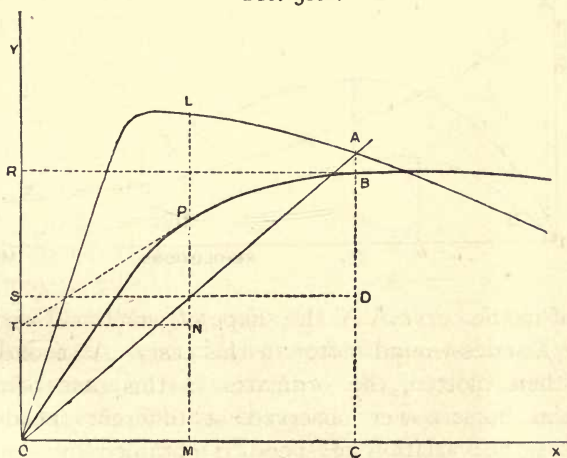

was equal to half that of the generator. Let $O P B$ (Fig. 310*) be the characteristic of the generator. From this curve another must be derived in the following manner. Take any

very little current passes. Between these two extremes there will be a point b , corresponding to a certain speed $O b$, for which the activity is a maximum. Next divide the values of the mechanical work B , by those of the electrical energy spent E at the corresponding speed. These quotients will of course be the commercial efficiency at different speeds. These values are plotted out to an arbitrary scale in the curve ff , which shows that the maximum efficiency is attained at the speed corresponding to the point c .



CHAPTER XXIX.

TESTING DYNAMOS AND MOTORS.

TESTS to be applied to dynamos are of two kinds, viz. those which relate to the design and construction of the machines, and those which relate to their performance. Under the former are included tests of the resistance of the various coils and connexions, and of the insulation of the working parts. Under the latter are comprised the tests of efficiency under various loads, and of electrical output or activity at different speeds.

The resistance of the various parts of the armature coils, of the field-magnet coils, and of the various connexions, may be tested in the ordinary manner, by means of a Wheatstone's bridge, or by one of the recognised galvanometer methods. The only point of difficulty lies in measuring such small resistances as those of armatures and of series coils, which are often very small fractions of an ohm. In this case probably the best method of proceeding is the following. By means of a few cells of accumulators send a strong current through the coil or armature whose resistance is to be measured, interposing in the circuit an ampère-meter. While this current is passing, measure, by means of a sensitive voltmeter, the fall of potential between the two ends of the coil. By Ohm's law, the number of volts of fall of potential divided by the number of ampères of current will give the resistance in ohms. Additional accuracy may be secured by connecting in the circuit a strip of stout German silver, as recommended by Lord Rayleigh, of known resistance, and comparing the fall of potential between the two ends of the strip with the fall

of potential in the coil. The ratio of the two falls of potential will equal the ratio of the resistances.

It ought on no account to be forgotten that the internal resistance of a dynamo when warm after working for a few hours is considerably higher than when it is cold. Tests of resistance ought therefore to be made both before and after the dynamo has been running.

The insulation resistance of the various parts should be tested with care, and should be repeated at intervals. In particular, measurements should be made of the insulation resistance between the terminals of the machine and its metal bed-plate, and between the segments of the collector and the axle. Nowhere is the insulation more likely to deteriorate than at the collector. Occasionally a dynamo, which otherwise may appear to be in good condition, will mysteriously lose its power of furnishing the usual current, in consequence of invisible short-circuiting having occurred in the layers of insulating matter between the segments of the collector. A film of charred oil, possibly with the assistance of small particles of metal worn off the brushes, will afford a ready passage to the current, which will thus leak away instead of being delivered in full strength to the circuit. It is for this reason advisable that armatures should be so constructed that the collector-bars can be detached from their corresponding sections of the armature coil, enabling the engineer to test the insulation of any one bar.

The testing of the efficiency and working capacity of a dynamo, whether working as generator or as motor, is a more serious matter, and involves both electrical and dynamometrical measurements.

In the case of the dynamo generating currents, measurements must be made (*a*) of the horse-power expended, and (*b*) of the energy of the electric currents realised.

In the case of the motor doing work, measurements must be made (*a*) of the electric energy consumed, and (*b*) of the mechanical horse-power realised.

Measurement of Horse-power.

There are four general methods of measuring mechanical power :—

(a.) *Indicator Method.*—By taking an indicator diagram from the steam-engine which supplies the power.

(b.) *Brake Method.*—By absorbing the power delivered by the machine, at a friction brake such as that of Prony, Poncelet, Appold, Raffard, or Froude.

(c.) *Dynamometer Method.*—By measuring in a transmission dynamometer or ergometer, such as that of Morin, Alteneck, Ayrton and Perry, or of F. J. Smith, the actual mechanical power of the shaft or belt.

(d.) *Balance Method.*—By balancing the dynamo or motor on its own pivots and making it into its own ergometer.

Indicator Method.—The operation of taking an indicator diagram of the work of a steam-engine is too well known to engineers to need more than a passing reference. This method is, however, not always applicable, for in many cases the steam-engine has to drive other machinery, and heavy shafting for other machinery. In such cases the only remedy is to take two sets of indicator diagrams, one when the dynamo is at work, the other when the dynamo is thrown out of gear, the difference being assumed to represent the horse-power absorbed by the dynamo.

Brake Method.—The friction-brake of Prony is well known to engineers, but the same can hardly be said of the more recent forms of friction dynamometers. Various improvements have been introduced in detail from time to time by Poncelet, Appold and Deprez. In Prony's method the work is measured by clamping a pair of wooden jaws round a pulley on the shaft; the torque on the jaws being measured directly by hanging weights on a projecting arm with a sufficient moment to prevent rotation. If p is the weight which at a distance l from the centre balances the tendency to turn, then the friction-force f multiplied by the radius r of the pulley will equal p multiplied by l .

This may be written,

$$\text{Torque} = fr = pl.$$

From which it follows that

$$f = \frac{pl}{r}.$$

If n be the number of revolutions *per second*, then $2\pi n$ is the number of radians per second, or in other words the angular velocity for which we use the symbol ω , and $2\pi nr$ is the linear velocity v at the circumference. Now the work per second, or "activity," is the product of the force at the circumference into the velocity at the circumference, or

$$w = fv = \frac{pl}{r} \cdot 2\pi nr = 2\pi npl.$$

If p is measured in pounds' weight, and l in feet, then, remembering that 550 foot-pounds per second go to one horse-power, we have

$$\text{Horse-power absorbed} = \frac{2\pi npl}{550};$$

or, if p is expressed in grammes, and l in centimetres, it must be divided by 7.6×10^6 to bring it to horse-power.

The later improvements imported into the Prony brake are of great importance. Poncelet added a rigid rod at right angles to the lever, and attached the weights at the lower end. Appold substituted for the wooden jaws a steel strap giving a more equable friction, and therefore having less tendency to vibration. Raffard* substituted a belt differing in breadth, and therefore offering a variable coefficient of friction, according to the amount wrapped round the pulley. Further modifications of this kind of brake dynamometer have been made by Professor James Thomson, Professor Unwin, M. Carpentier, and by Professors Ayrton and Perry. The

* For further accounts of these instruments the reader is referred to Weisbach's *Mechanics of Engineering*; Spons' *Dictionary of Engineering*, Article "Dynamometer"; Smith's *Work-measuring Machines*; a series of articles in the *Electrician*, 1883-4, by Mr. Gisbert Kapp; *Proc. Inst. Mech. Eng.*, 1877, p. 237 (Mr. Froude); *Rep. Brit. Assoc.*, 1883 (Prof. Unwin); *Journ. Soc. Electr.-Eng. and Electr.*, xlix., vol. xii. p. 346 (Profs. Ayrton and Perry).

friction of a turbine wheel was also applied as a dynamometer brake by the late W. Froude.

As all these brake dynamometers measure the work by destroying it, it will be seen that though they are admirably adapted to measure the work furnished by a motor, they cannot, except indirectly, be applied to measure the work supplied to a dynamo. Some experience in working with these machines is essential if reliable results are to be obtained ; but with the more modern forms of instrument, such as those of Poncelet and Raffard, the results are very good. The great secret of success is to keep the friction surfaces well lubricated with an abundant supply of soap and water.

Dynamometer Method.—The Prony brake was styled above a brake dynamometer ; but the true dynamometer for measuring transmitted power does not destroy the power which it measures. Transmission dynamometers may be divided into two closely allied categories: those which measure the power transmitted along a belt, and those which measure power transmitted by a shaft.

In the case of transmitting power by a belt, the actual force which drives is the difference between the tension* or pull in the two parts of the belt. If F' is the pull in the slack part of the belt before reaching the driven pulley, and F the pull in the tight part of the belt after leaving the driven pulley, then $F - F'$ represents the nett pull at the circumference, and $(F - F') \times r$ is the torque T , or turning moment. Then if n is the number of revolutions *per second*, the angular velocity ω will be equal to $2\pi n$. This gives us as the work per second, or activity,

$$w = \omega T = fv = 2\pi nr(F - F').$$

As before, if F is expressed in pounds' weight and r in feet, the expression must be divided by 550 to bring to horsepower: or must be divided by 7.6×10^6 if the quantities are expressed in grammes' weight and centimetres.

* The word tension, though used by engineers as synonymous with "pulling force," ought not to be so used; it ought to be confined to the exact meaning of force per unit of area of cross-section.

A dynamometer which can be applied to a driving belt, and actually measures the difference $F - F'$ in the tight and slack parts of the belt, has been designed by Von Hefner Alteneck, and is commonly known as Siemens' dynamometer.* Other forms have been devised by Sir F. J. Bramwell, W. P. Tatham, W. Froude, T. A. Edison, and others. Nearly all of these instruments introduce additional pulleys into the transmitting system, causing additional friction.

Much more satisfactory are those transmission dynamometers which measure the power transmitted by a shaft. In nearly all instruments of this class there is a fixed pulley keyed to the shaft, and beside it a loose pulley connected with it by some kind of spring arrangement so set that the elongation or bending of the spring measures the angular advance of the one pulley relatively to the other; this angular advance of one pulley relatively to the other being proportional to the transmitted angular force or torque. To this class of instrument belongs the well-known dynamometer of Morin, in which the displacement of the loose pulley is resisted by a straight bar spring, the centre of which is attached to the driving shaft. Modifications of the Morin instrument have been devised by Easton and Anderson, Heinrichs,† Ayrton and Perry,‡ and the Rev. F. J. Smith. The dynamometer of Mr. Smith claims special notice on account of its completeness and accuracy. In this instrument, a sketch of which is given in Fig. 312, there are as before two pulleys, the front one fixed to the shaft, the hinder one running loose upon it. But the displacement of the loose pulley is measured in a different manner from the methods of the earlier constructors. The loose pulley carries a bevel-wheel (not shown) which gears into two other bevel-wheels,§ which of

* One form of the Siemens dynamometer is described by Hopkinson, *Proc. Inst. Mech. Eng.*, 1879. A more modern form is described by Schröter, *Bayerischen Industrie-und Gewerbeblatt*, 1883.

† See *Engineering*, May 2, 1884, and *Electrical Review*, April 26, 1884, for an excellent account of a series of tests carried out with great care and ability for Mr. Heinrichs, by Messrs. Alabaster, Gatehouse and Co.

‡ *Journ. Soc. Telegr.-Eng. and Electr.*, vol. xii. p. 163, 1883.

§ Similar devices of geared cog-wheels had been applied, though in an entirely different way, in the dynamometers of Hachette and of White.

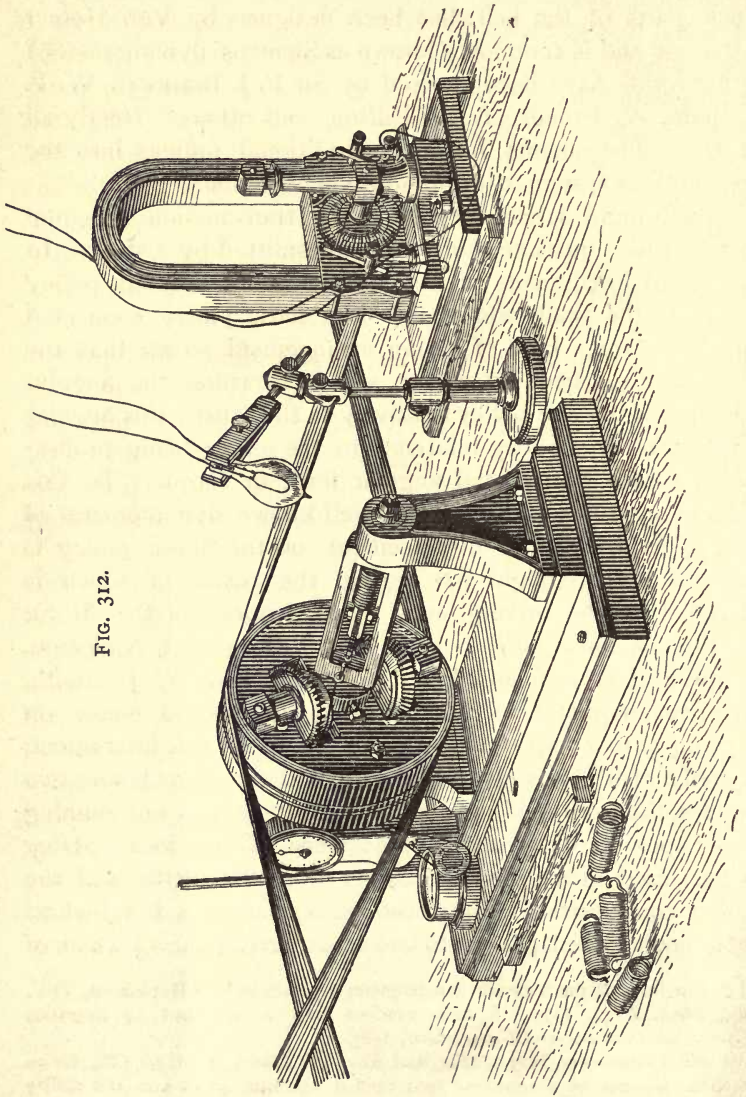

FIG. 312.

F. J. SMITH'S TRANSMISSION DYNAMOMETER.

necessity move in proportion to the angular displacement. Each of these two bevel-wheels is furnished with a shallow cylindrical drum, over which is coiled a gut or steel tape attached to a cross-head. The shaft is of forged Whitworth steel, tubular at its ends and link-shaped between; the cross-head passing through the link, and being attached to a spring. Any displacement of the loose pulley will cause the steel tapes to be wound up on the drums, and will extend the spring. A light rod of steel passing through the hinder end of the link, through the shaft, actuates the pointer of a dial, thus enabling the transmitted torque to be read off directly. A speed-counter is also attached. Mr. Smith has also added to this machine an integrating apparatus which traces on a drum a continuous record of the work done; the speed of rotation of the recording drum, having a known ratio to the speed of driving, and the displacement of the recording pen, which writes the ordinates, being proportional to the torque. The position of the spring, coincident with the axis of the dynamometer, obviates all fear of error arising from centrifugal force. Mr. Smith has suggested a novel method of calibrating the readings of the dynamometer, which appears to have some advantages over the common method of hanging weights to the loose pulley. It is as follows:—Let the transmission dynamometer be driven by some steady prime mover—a water-wheel is probably the steadiest of all—and let the dynamometer itself drive another shaft on which a Prony brake or Appold brake is applied. Then if the work done against friction at the brake is measured, and the speed is known also, it is known what the transmitted torque is. Every transmission dynamometer ought to be similarly calibrated.

Balance Method.—The following method was devised by Mr. Smith when testing some small Trouvé motors at the Paris Exposition of 1881. With small motors there arises the difficulty that the ordinary means of measuring the work they perform introduce relatively large amounts of extraneous friction. The motor to be tested is placed with its armature spindle between centres, or on friction wheels, and the weight

of the field magnets and frame is very carefully balanced with counterpoise weights. In Fig. 313, B D represents the field magnets and frame of the motor duly counterpoised, and E is the armature. When the current is turned on, the armature tends to rotate in one direction, and the field magnets in the other; the angular reaction being of course

FIG. 313.

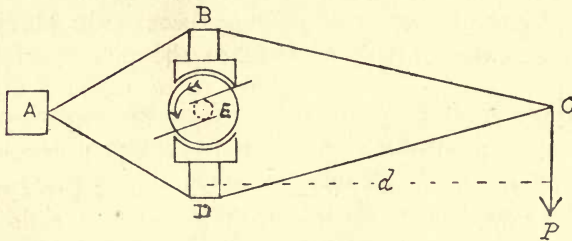

SMITH'S METHOD OF TESTING MOTORS.

equal to the angular action. If the reaction which tends to drive the field magnets round, be balanced by applying a force P (for example that of a spring balance) at the point C of the frame $A B C D$, then the moment of this force $P d$ measures the torque, exactly as in the Prony brake. Hence it will be seen that the motor has become its own dynamometer, the magnetic friction between the armature and the field magnet being substituted for the mechanical friction between the pulley and the jaws.

More recently M. Deprez and Professor C. F. Brackett have proposed to apply the balance method to dynamos in action. Professor Brackett places the dynamo in a sort of cradle, and measures the angular reaction-force or torque between the armature and field magnets, and multiplying this by the angular velocity $2 \pi n$ obtains the value of the power transmitted to the armature. It may seem incredible that the invisible magnetic field in the narrow space between the armature and the pole-pieces should exercise a powerful drag like the drag of a friction-brake, but it is nevertheless true. This mechanical drag exists in every dynamo. For example, the Crompton-Kapp dynamo described on p. 113 absorbed

about thirty horse-power. It ran at 1000 revolutions per minute, and the radius of the armature was 4 inches. The circumferential drag was therefore about equal to 300 pounds' weight! No wonder with such a brake-power acting on the armature, the "coils," consisting of drawn copper rods of 0.3 square centimetre section, were found, after the first run, to be raked out of their places by the drag of the magnetic field upon them. This undesirable result was only prevented from recurring by the insertion of boxwood wedges kept in their places by an external strap of thin brass wires.

All these several dynamometric methods necessitate the use of a speed indicator to count the number of revolutions n , which enters as a factor into the calculation of horse-power. Too great care cannot be taken, especially in testing *small* machines, that no unnecessary friction be thereby introduced. A flexible connexion, such as a piece of dentist's spring, between the axle of the machine and the axle of the counter appears to be desirable. The number of revolutions *per second* n being known, the angular velocity $\omega = 2\pi n$ can be calculated. This only requires to be multiplied by the torque $T = Fr$ to give the activity or work-per-second w . And if T is expressed in pound-feet, then,

$$\text{Horse-power} = \frac{2\pi n Fr}{550} = \frac{\omega T}{550}.$$

For detailed accounts of tests on dynamos the student is referred to the following sources:—*Report of Committee of Franklin Institution*, 1878; *Crystal Palace Exhibition* 1882, *Report*, by Lieut. F. J. Sprague, United States Commissioner; also see the Inaugural Address of Prof. W. G. Adams in *Journal Soc. Electr.-Engin. and Electr.*, 1884; Thesis of J. W. Howell on tests made at Stevens Institute, reprinted in a volume on *Incandescent Electric Lighting* published New York, 1883, by Messrs. Van Nostrand; *Official Report of Munich Electric Exhibition*, 1882; also the tests made by Messrs. Alabaster, Gatehouse, and Co., reported in *Engineering*, May 2, 1884, and *Electrical Review*, April 26, 1884; also *Report of Jurors, Cincinnati Industrial Exposition* 1883; also Prof. W. G. Adams' Inaugural Address, *Journal of Society of Telegraph-Engineers and Electricians*, vol. xiv. p. 4, 1885; also Reports of Electrical Exhibition at Philadelphia 1884, published in *Journal of the Franklin Institution*, 1885.

APPENDICES.

APPENDIX I.

MEASUREMENT OF THE COEFFICIENT OF SELF-INDUCTION OF A COIL.

THIS may be done either by the process mentioned in Maxwell's *Electricity*, vol. ii., art. 757, or by the method of M. Joubert. The former requires only the ordinary Wheatstone's bridge, but is not a sensitive method. Joubert's method is as follows: Provide an alternate current (generated say by rotating coil in magnetic field) whose period is T . Unite the coil to be measured in series with a resistance wire, having preferably a resistance somewhat higher than that of the coil, and pass the alternate current through both at once. This wire must be either straight, or else doubled on itself before winding so as to have no self-induction. Then with a high-resistance electro-dynamometer or other volt-meter capable of working with alternate currents, measure the difference of potential between the ends of the coil, and of the wire. Call the respective deflexions d and d' . Then if R is the resistance of the coil, and R' that of the wire, the coefficient of self-induction of the coil is given by the formula—

$$L = \frac{T}{2\pi} \sqrt{R'^2 \frac{d}{d'} - R^2}.$$

APPENDIX II.

MEASUREMENT OF MUTUAL INDUCTION OF TWO COILS.

WHEN a moving coil passes in front of a stationary one through which a current is flowing, the magnetic lines of the latter pass through the former. If currents are flowing in both coils, each tends to send lines of magnetic force through the other. The number of lines of force which each sends through the other, and which are

therefore common to the two coils, is termed their "mutual induction." It is obvious that the closer the coils approach, the greater is their mutual induction. It is usual to specify the matter in terms of a "coefficient of mutual induction" M , which is nothing else than the number of lines of force common to the two coils when each carries unit current. If the two currents are respectively i_1 and i_2 units, then clearly the (total) mutual induction will be $M i_1 i_2$. Now M for any given pair of coils, at their closest point of approach, will be different, in general, from M for any other pair of coils at their closest point of approach. It is useful in certain instances to know which combination or pair of coils will have the highest value of M . For example, considering the field magnet of a dynamo as a coil, and the armature as another coil, that dynamo will, *ceteris paribus*, be the most powerful which has the highest coefficient of mutual induction between its two parts.

The only practical method for measuring M the coefficient of mutual induction, is that due to Maxwell, who gives* a method of comparing the value of M with that of M' for another pair of coils. This method, which depends on the production of transient currents in a circuit including one coil of each pair, is, however, inapplicable to the case where the coils have themselves large coefficients of self-induction, as is the case where there are solid iron cores. Maxwell's process is as follows: Let two coils A and B have coefficient of mutual induction M , and let the other pair C and D have the coefficient M' . Join the coils A and C in series in circuit with a battery and a key. Join the coils B and D in parallel with a galvanometer. On making circuit with the key, the primaries A and C will induce currents in the secondaries B and D, which, if they are properly united, will tend to neutralise one another, but will generally not be equal; giving a resultant throw to the galvanometer needle. Now let additional resistance be added to the coil that acts the more powerfully until there is no throw in the galvanometer on depressing the key of the primary. If this additional resistance be called r , and if B and D express the resistances of their respective coils, then the condition of no galvanometer current is

$$M : M' :: B : D + r,$$

from which the ratio of M and M' is known.

* Maxwell, *Electricity and Magnetism*, vol. ii., art. 755.

APPENDIX III.

ON THE FORMULÆ USED FOR ELECTRO-MAGNETS.

MANY suggestions have been made for equations connecting the strength of an electro-magnet, or its magnetic moment, with the strength of the current which excites it. Most of these are purely empirical. Only those of Weber and of Lamont are based upon abstract theories of magnetism, and Weber's does not represent the actual facts so satisfactorily as some of the other arbitrary formulæ. Space only admits of very brief enumeration of the various suggestions.

1. *Lenz and Jacobi's Formula.*—According to the experiments of these early investigators (1839), the magnetism of the electro-magnet is simply proportional to the strength of the current and to the number of turns of wire in the coil. This may be written as :

$$m = k S i,$$

where i is the strength of the current, S the number of turns in the coil, k a constant depending on shape and quality of iron, and m the strength of the pole. Joule (1839) showed this rule to be incorrect, and that as the iron became saturated, m ceased to be proportional to $S i$.

2. *Müller's Formula.*—Müller* gave the formula

$$S i = A d^{\frac{3}{2}} \tan \frac{m}{B d^2},$$

in which i is the strength of the current, d the diameter of the iron core, m the strength of the pole produced in the core, and A and B constants. The equation may be transformed into the more useful form—

$$m = B d^2 \tan^{-1} \frac{S i}{A d^{\frac{3}{2}}}.$$

3. *Von Waltenhofen's Formula.*—Müller's formula introduced into the expression the diameter of the core. Von Waltenhofen has rewritten the formula to make it apply to the case where the weight of the core is given. In this formula g is the weight in grammes and a

* See Wiedemann's *Die Lehre von der Elektrizität*, vol. iii. p. 414; also see Müller-Pouillet's *Lehrbuch der Physik*, vol. iii. p. 482 (ed. 1881); and S. P. Thompson's *Electricity and Magnetism*, art. 328.

and β constants. M is now the magnetic moment of the core, and x the magnetic moment of the coil.

$$M = \beta g \tan^{-1} \frac{x}{a g^{\frac{1}{2}}}.$$

From this equation it follows that, when x is indefinitely great, the magnetic moment of the saturated bar is proportional to its weight.

Similar formulæ of the general form

$$M = b \cdot \tan^{-1} \frac{S i}{a}$$

have been used by Dub, Cazin, and Breguet, but they are only varieties of Müller's equation. The defect of all these "arc-tangent" formulæ is, that they lend themselves so little conveniently to use in the equations of dynamos. Moreover, they do not accord with the observations of Lenz, Jacobi, Scoresby, Sturgeon, and hundreds of others, that for small values of the magnetising current the magnetism evoked is very exactly proportional to the strength of the current. In the saturation curve, such as is drawn in Fig. 169, p. 273, the first part of the curve is for a long way nearly straight. But if this "arc-tangent" rule were true, this portion of the curve would be very decidedly convex.

4. *Weber's Formula.*—Weber's formula* is framed on the supposition that in every unit of volume of the iron there exist n molecules, each of magnetic moment m ; so that the magnetic moment of unit volume (which numerically equals the intensity of magnetism), if all were set with axis parallel, would be $I = m n$. It also supposes that every molecule is set in a certain arbitrary direction, and tends to remain there, under the coercion of a molecular force, the value of which is called D . If X , the magnetising force, act on a molecule at an angle u , the effective magnetic moment of that molecule will become

$$m' = m \left(\frac{X + D \cos u}{\sqrt{D^2 + X^2 + 2 D X \cos u}} - \cos u \right).$$

This formula was duly integrated and developed by Weber. Maxwell has reduced it to simpler forms for particular cases, according to the relative magnitudes of X and D . In the equations, I stands for magnetic moment per unit volume.

* *Elektrodynamische Maasbestimmungen*, p. 572, where a saturation curve is also given; see also Maxwell, *Electricity and Magnetism* (2nd edition), vol. ii. p. 78, for a discussion of Weber's theory.

When X is *less* than D ,

$$I = mn \left(1 - \frac{1}{3} \right) \frac{X}{D};$$

When X *equals* D ,

$$I = mn \left(1 - \frac{1}{3} \right);$$

When X is *greater* than D ,

$$I = mn \left(1 - \frac{1}{3} \frac{D^2}{X^2} \right);$$

When X is infinitely great,

$$I = mn.$$

Maxwell gives the results of these formulæ in curves, which also fail to agree with the observed facts.

5. *Frölich's Formula*.—Frölich* uses an interpolation formula to express the effective magnetism M of a dynamo-machine in terms of the current i , and of a set of arbitrary constants, a , b , and c . His most complete form was

$$M = \frac{i}{a + bi + ci^2}.$$

Finding the term in i^2 unnecessary, he adopted the simpler form

$$M = \frac{i}{a + bi}.$$

Here b equals the reciprocal of the maximum value of M ; as will be seen by assigning to i any very large value.

A very similar formula had been used twenty-five years previously by Robinson† to express the lifting power of electro-magnets. Similar formulæ have been used by Lamont, Oberbeck‡ Fromme,§ Deprez, Clausius, Ayrton and Perry, and by Rücker. The advantage of the formula is its adaptability to use in other equations. A modification of it, as explained on p. 214, is used in this book for expressing the intensity of the field due to the electro-magnet, viz. :—

$$H = G \frac{\kappa S i}{1 + \sigma S i};$$

where G is a coefficient depending only on the geometrical form of the magnet and the position of the place where H is measured, κ the

* Frölich, *Elektrotechnische Zeitschrift*, 1881, pp. 90, 139, 170; and 1882, p. 73.

† Robinson, *Trans. Roy. Irish Academy*, vol. xxii. p. 1, 1855.

‡ Oberbeck, *Pogg. Ann.*, cxxxv. pp. 74-98, 1868.

§ Fromme, *Pogg. Ann.*, clv. p. 305, 1875.

coefficient of initial magnetic permeability of the core, σ the saturation coefficient, and S the number of turns in the coil.

6. *Sohncke's Formula.*—Professor Sohncke* has lately proposed an exponential formula which expresses the facts very accurately, though it is not so convenient as the preceding. It is

$$M = \frac{I}{a} i \cdot \epsilon^{-bi}.$$

7. *Lamont's Formula.*—Lamont deduces † a formula of great value from certain theoretical considerations which are of special significance. He assumes that for every bar there is a certain maximum of magnetisation to which it would attain only under the influence of an infinitely great magnetising force; and that the permeability of the bar is at every stage of the magnetisation proportional to the difference between the actual magnetisation and the possible maximum magnetisation. This is, in other words, as if in every bar there were room for only a certain limited number of magnetic lines of force, and that when any lesser number have been induced in it, the susceptibility of the bar to the introduction of additional lines is proportional to the room yet left for them in the bar. A very similar hypothesis has lately been put forward by Mr. R. H. M. Bosanquet.‡ Lamont's theory may be expressed as follows. Let the magnetism present at any stage be called m , and let the maximum magnetism be called M . Then the amount of magnetism which the bar can still take up is

$M - m$; and the permeability $\frac{dm}{dx}$ is proportional to $M - m$. Here

x may be understood as the number of ampère-turns (or $S i$), in the exciting current; and we may write

$$\frac{dm}{dx} = k(M - m),$$

where k is a constant depending on the units employed. This equation we may arrange as

$$\frac{dm}{M - m} = k dx,$$

and, integrating

$$\log_e (M - m) = - kx,$$

or,

$$M - m = A \epsilon^{-kx};$$

* *Elektrotechnische Zeitschrift*, April 1883, p. 160.

† Lamont, *Handbuch des Magnetismus*, 1867, p. 41.

‡ *Philosophical Magazine*, S. v. vol. xix. p. 85, Feb. 1885. See also Bosanquet, in *Electrician*, Feb. 14, 1885.

where A is a constant of integration. But when $x = 0$, $m = 0$ also; hence $A = M$, giving us the formula

$$m = M (1 - e^{-kx}).$$

This formula is probably much more nearly true for soft-iron electromagnets than any of the preceding.

Lamont further points out that this expression may be expanded in terms containing ascending powers of kx as

$$m = M kx \left(1 - \frac{kx}{1 \cdot 2} + \frac{k^2 x^2}{1 \cdot 2 \cdot 3} - \&c. \dots \right).$$

If the magnetising force x is small, we may neglect all terms after the first; which virtually reduces the formula to that of Lenz and Jacobi, the magnetism being simply proportional to the ampère-turns. Lamont also points out that a first approximation to the formula above is given by an expression of the form

$$m = \frac{M kx}{1 + kx},$$

which is identical with the formulæ of Fromme, Oberbeck, Frölich, and Clausius. This formula when expanded becomes

$$m = M kx (1 - kx + k^2 x^2 - \&c. \dots).$$

The corresponding expansion of the "arc-tangent" formula is

$$m = M kx \left(1 - \frac{k^2 x^2}{3} + \frac{k^4 x^4}{5} - \&c. \dots \right).$$

The student should compare these with Lamont's expression.

None of these formulæ account for a phenomenon observed in the magnetisation of many pieces of iron and steel, and especially in closed rings of iron and steel, namely, that there is an apparent increase in the permeability after a certain early stage in the magnetisation has been reached. Lenz first noticed this in 1854. Wiedemann, Dub, Stoletow, Rowland, Chwolson, Bosanquet, and Siemens have all investigated the matter; Rowland and Bosanquet in particular having given many careful numerical determinations of the variations of permeability under varying degrees of ascending magnetisation. The researches of Chwolson and of Siemens seem, however, to show that the apparent increase of the permeability is due to the want of homogeneity in the iron, and to the presence of a certain proportion of particles having the properties of hard steel and requiring a certain minimum of magnetising force to be applied before they become sensibly magnetised, there being an apparent

more rapid growth of the magnetism when this stage is reached. According to this view the permeability due to temporary magnetism begins by being a maximum, and diminishes as the magnetising force is increased; whilst the permeability due to permanent magnetism is zero at first and until a certain stage, when it rises rapidly to a maximum of its own, and thereafter dies gradually away. That which Stoletow, Rowland, and Bosanquet have measured with so much care, is the sum of these two effects. Siemens makes the valuable remark that the harder the piece of iron or steel, the later is the stage at which this apparent maximum of magnetic permeability is observed.

The result of this superposition of effects in the dynamo machine is that when the "characteristic" is taken *with ascending strengths of current*, there may be observed—and this is not marked, save in dynamos in which the iron constitutes very nearly a closed circuit on itself—a concavity in the first part of the characteristic, which, as explained on p. 353, is usually taken as an oblique straight line. But if the characteristic is taken with descending strengths of current, no such concavity is observed, the magnetism of the field magnets, and also the electromotive-force, having values considerably higher, for the same value of exciting current, than in the ascending curve. The presence of permanent magnetism in the core is therefore detrimental to the steadiness of the field. Even with the softest Swedish iron, differences may be observed in the electromotive-force, with the same speed and same exciting current, before and after the exciting current has been increased to a high degree. For this reason the approximate formula known as Frölich's is probably quite as near to the truth as the more perfect formula of Lamont. Neither of them take into account the presence of the apparent increase in permeability or the retardation of the apparent maximum in cores having greater coercitivity. For further information on the differences between the ascending and descending curves of magnetism, the reader is referred to the researches of Warburg, Ewing, and Hopkinson.

APPENDIX IV.

RECENT ADVANCES IN THE THEORY OF THE DYNAMO.

SINCE the publication of the original edition of this work, several important additions have been made to the theory of the dynamo. Dr. Frölich, upon whose work of 1881 the theory propounded in Chapters XII. to XVII. was avowedly based, has published a series of fresh articles in the *Elektrotechnische Zeitschrift* for 1885. These deal chiefly with the question of compound-wound self-regulating machines, but incidentally discuss many points of theoretical as well as practical interest. Professor Rücker, F.R.S., has also published in the *Philosophical Magazine* for June 1885 a paper on the theory of the compound self-regulating dynamo, previously read by him at the Physical Society of London, in which the mathematical theory of the machine is treated in a much more generalised manner than heretofore. As this theory is also based upon Frölich's earlier work of 1881, it may be convenient to give here an abstract of Frölich's theory, as well as a *résumé* of his more recent studies.

Frölich's Theory.—This theory is based upon (1) Faraday's law of induction, (2) Ohm's law, (3) a curve expressing certain results of experiments made with a series-wound dynamo.

The electromotive-force E is proportional to the number of revolutions per second n and to the "effective magnetism" M of the machine; so that

$$E = M n. \quad [1]$$

By the "effective magnetism" Frölich understands what we should term "the number of magnetic lines of force cut in one revolution," a quantity which depends on the construction and number of coils of the armature, as well as on the construction and degree of excitation of the field magnet.

By Ohm's law the current i is equal to the electromotive-force E divided by the whole resistance in the circuit R .

$$i = \frac{E}{R};$$

whence

$$i = \frac{M n}{R}. \quad [2]$$

But since, in a given dynamo, M is a function of i and not directly of n or R , if we divide both sides of this equation by M , we obtain on the left a function of i only, and on the right n/R . The current then depends only on the *ratio* between the speed and the resistance. It then remains for experiment to determine whether the current is or is not proportional to the values of this ratio. Accordingly experiments are made at different speeds and with different resistances, and the results are examined by plotting out as ordinates the values of i and as abscissæ the corresponding values of n/R . The curve so obtained—and which Frölich names as the *current-curve*—is depicted in Fig. 314. It will be seen that with

FIG. 314.

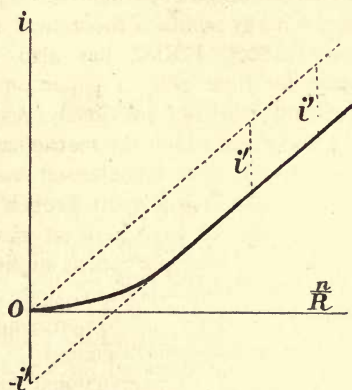

FRÖLICH'S CURRENT CURVE.

small values of n/R the current is inappreciable; but that when n/R has reached a certain value the corresponding values of i increase regularly from that point, the curve consisting of an oblique line, which, however, does not pass through the origin, but, if prolonged backwards, crosses the vertical axis at a point marked $-i'$. In other words, i is a simple linear function of n/R ,* and its values may be represented by an equation of the form

$$i = c \frac{n}{R} - d, \quad [3]$$

where c and d are constants, the nature of which will be discussed

* This is true for the series dynamo only, not for shunt dynamos or compound dynamos.

later. We have now to compare equation [2] which expresses well-established theory, with equation [3] which merely expresses certain observed facts. They both contain the quantity $\frac{n}{R}$ and may be re-written as follows :

$$\frac{i}{M} = \frac{n}{R};$$

$$\frac{d+i}{c} = \frac{n}{R};$$

whence

$$\frac{d+i}{c} = \frac{i}{M}$$

and

$$M = \frac{ci}{d+i}$$

now form two new constants, $a = \frac{d}{c}$, and $b = \frac{1}{c}$, and we may write the last expression as

$$M = \frac{i}{a + b}.$$

This equation, giving the "effective magnetism" in terms of the current and the two constants a and b , is nothing more or less than the equation of an electro-magnet such as is discussed in the preceding appendix. It comes out here, however, as the result of applying the laws of Faraday and Ohm to the observed facts of a series dynamo.*

Frölich next remarks that if the values of a and b are deduced from experiments made on different machines, they are different in different cases because into each of them the number and size of coils

* It is extremely interesting and suggestive to see how Dr. Frölich arrived thus at the equation that has formed the basis of so much work of later date. It was on finding that so simple an equation for the magnetism of an electro-magnet was adequate to express the facts in the case of the series-wound dynamo, that induced the author of this book to apply an equation of the same form to build up the equations of the shunt dynamo in Chapter XVI. It should also be remarked that the equations for the series dynamo in Chapter XV. are similarly built up from the law of the electro-magnet, and are not deduced from the "current-curve" which forms the starting-point in Frölich's way of stating his theory. He deduces the law of the electro-magnet from observations on the dynamo. I have built up the law of the dynamo from the law of the electro-magnet. Though my method is more logical, Frölich's is the original one, and has the merit not only of being anterior, but of being anterior in a field where others, including such names as Mascart, Schwendler, Herwig, Meyer and Auerbach, had sought in vain for a feasible solution. The utmost credit is therefore due to Dr. Frölich.

in the armature comes in as an element. M , in fact, as used up to this point by Frölich, corresponds to the product $4HA$ as those symbols are used in Chapters XII. to XVII. of this book; and Frölich's a is the reciprocal of S the number of turns of wire on the field magnet, and his b is analogous to the saturation-constant σ . It may be remarked incidentally that the reciprocal of b is numerically the maximum value to which M can attain, when i is indefinitely increased.

Frölich now makes the remark—with which the author of this work entirely disagrees—that it is better to express the effective magnetism of a dynamo as a relative, and not as an absolute quantity: and he therefore proceeds to so modify the formula that the maximum magnetism for each individual machine shall be called $= 1$ when saturated. Accordingly we write $b = 1$, and the expression may then be still further modified by writing m for $\frac{1}{a}$, giving us:

$$M = \frac{i}{a + i} = \frac{\frac{1}{a}i}{1 + \frac{1}{a}i} = \frac{mi}{1 + mi}. \quad [4]$$

Here m is the number of turns of wire on the field magnet (or some power of that number). The product mi represents the number of ampère-turns. If values are assigned to mi , and the corresponding values of M are calculated and plotted out, we get the "characteristic" curve of that electro-magnet, or, as Frölich calls it, the "curve of magnetism."

Now substitute in equation [2] the value of M as expressed in equation [4], and we get:

$$i = f \frac{n}{R} - \frac{1}{m}, \quad [5]$$

which is the equation for the current of a series dynamo. The symbol f stands for a constant "the introduction of which," says Dr. Frölich, "is necessitated by the removal of constant b ."*

The term $\frac{1}{m}$ which relates to the power of the field-magnet coils to magnetise, acts on the machine in such a way as to cause the

* That it should be needful to reintroduce the constant b under this form shows that b ought not to have been removed—in other words, that Dr. Frölich's plan of taking relative instead of actual values for the magnetism is a mistake. Further, if b has to be introduced under this form it ought to be multiplied into both terms of the expression.

current to be less than it would otherwise be at the given speed. We see also that, if R is given there will be a certain minimum speed below which the machine will give no current. For this reason Dr. Frölich gave the name of "the dead turns" to the quantity $\frac{I}{m}$. (A better name would have been "dead current," for it is equal to i' in Fig. 314.)

So far we have been following the theory as propounded by Dr. Frölich in 1880-1. That which follows has been only published so recently as 1885.

Each of the two terms in the right-hand half of the equation [5] possesses a physical meaning: both of them are particular values of current. The first, $f \frac{n}{R}$, is the maximum current which the machine could give with given speed n and resistance R , when the field magnet was saturated to magnetism = 1. This may be seen from the "current-curve," Fig. 314. If in this diagram we draw a line through the origin parallel to the "current-curve," the equation of that line will be

$$I = f \frac{n}{R},$$

or it is the line of maximum current for the given value of n/R . The value of the actual current for any given value of n/R is obtained by subtracting from the corresponding value of I the quantity i' , which has the value

$$i' = \frac{I}{m}.$$

Now, as will be seen by reference to equation [4], i' or $\frac{I}{m}$ is that value of current which will excite the field magnet to the degree $M = \frac{1}{2}$.*

Dr. Frölich then asserts that a similar division into two terms will occur in the expressions for electromotive-force and for potential at terminals, not of series-wound dynamos only, but also of shunt and compound dynamos: and he formulates this rule:—In order to find

* This corresponds partially to the anterior proposition of the author that the saturation-coefficient was the reciprocal of that number of ampère-turns that would saturate the field magnet to the "diacritical point" of half-permeability; a proposition of extreme importance, which the author showed to be applicable to all cases of dynamos, series, shunt, and compound wound.

the value of any electrical quantity (except electric energy) for a machine of given winding, consider the machine under two different circumstances (without altering the given speed or given resistance): 1st, when the field magnets are independently excited to saturation ($M = 1$); 2nd, when the currents in the field-magnet coils have such values as will evoke half-magnetism ($M = \frac{1}{2}$); calculate the desired electric quantities for both these circumstances, *the difference between the two values is then equal to the real value which was to be found.*

Following out this principle, Dr. Frölich gives (March 1885), but without proofs, the following resulting expressions. [The notation has been here adapted to agree with that used in Chapters XII. to XVII.]

Series Dynamo.

$$i_a = i = \frac{fn}{r_a + r_m + R} - \frac{I}{S}$$

$$E = fn - \frac{I}{S}(r_a + r_m + R).$$

$$e = \frac{fn}{1 + \frac{r_a + r_m}{R}} - \frac{R}{S}$$

Compound Dynamo (Short Shunt).

$$i = \frac{fn}{r_a + (R + r_s) \frac{r_a + r_s}{r_s}} - \frac{\frac{I}{R + r_m}}{\frac{Z}{r_s} + \frac{S}{R + r_m}}$$

$$e = \frac{fn}{\left(1 + \frac{r_m}{R}\right) \left(1 + \frac{r_a}{r_s}\right) + \frac{r_a}{R}} - \frac{\frac{R}{R + r_m}}{\frac{Z}{r_s} + \frac{S}{R + r_m}}$$

Shunt Dynamo.

$$i_a = \frac{fn}{r_a + \frac{r_s R}{R + r_s}} - \frac{I}{Z} \frac{R + r_s}{R}$$

$$i_s = \frac{fn}{r_a \frac{R + r_s}{R} + r_s} - \frac{I}{Z}$$

$$i = \frac{fn}{r_a \frac{R + r_s}{r_s} + R} - \frac{I}{Z} \frac{r_s}{R}$$

$$E = fn - \frac{I}{Z} \left(r_a \frac{R + r_s}{R} + r_s \right)$$

$$e = \frac{fn}{1 + r_a \left(\frac{1}{r_s} + \frac{1}{R} \right)} - \frac{r_s}{Z}$$

Compound Dynamo (Long Shunt).

$$i = \frac{fn}{r_a + r_m + R \left(1 + \frac{r_a + r_m}{r_s} \right)} - \frac{\frac{I}{R}}{\frac{Z}{r_s} + S \left(\frac{1}{R} + \frac{1}{r_s} \right)}$$

$$e = \frac{fn}{1 + (r_a + r_m) \left(\frac{1}{R} + \frac{1}{r_s} \right)} - \frac{I}{\frac{Z}{r_s} + S \left(\frac{1}{R} + \frac{1}{r_s} \right)}$$

Dr. Frölich regards the latter formulæ for compound winding (the sufficiency of which he has proved by finding them to agree exactly with the results of observation of Siemens' dynamos) as marking an essential step forward. [They are undoubtedly an

advance upon the approximate equations of Chapter XVII., which, however, led the author to entirely correct practical deductions.]

Dr. Frölich was led by his theory to discover a method of compound winding giving "a fairly constant current" in the external circuit, the machine being wound as a shunt machine with a few turns of series coil connected so as to be traversed by the current in the opposite sense—a differential compound winding.

The next portion of Dr. Frölich's work is devoted to the application of the theory to winding machines so as to produce a constant potential at terminals. He points out that in both kinds of compound winding, the potential at terminals may be expressed in the form

$$e = A \frac{R}{R + a} - B \frac{R}{R + \beta}.$$

He then shows that if $\beta > a \frac{A}{B}$, e will be a maximum with small values of R , and that if $\beta < a \frac{A}{B}$, e will be a maximum with large values of R ; giving the conclusion that the condition of self-regulation is

$$\beta = a \frac{A}{B}.$$

For the further deductions the reader is referred to the *Elektrotechnische Zeitschrift*, April 1885.

Dr. Frölich next considers the case of compound-wound motors, and shows that because the magnetism is not proportional to the current, machines constructed according to the theory of Professors Ayrton and Perry, with differential windings, will not realise the condition of running at a constant speed. He considers that for working from mains supplied at a constant potential, electric motors should be shunt-wound rather than differentially-wound; and that it is even preferable in practice to add a few turns of series winding to add to the magnetism given by the shunt coils, though, according to him, neither of these will give a really constant speed.

Finally Frölich returns to the "current-curve" from which he started, and shows that if the residual magnetism of the core be taken into account and equation [4] is written as

$$M = \frac{\mu + m i}{1 + m i},$$

the expression for i which results when this new value is introduced into equation [2], gives, when plotted out, the precise form of the current curve.

Rücker's Theory.—Professor Rücker employs a very convenient generalised diagram of the dynamo, Fig. 315. Three points A X Y are joined by three straight lines representing resistances, and three curves representing magnetising coils. X Y represents the armature of the machine, the current flowing from X to Y. Y is the positive brush or terminal. Either Y A or A X may represent the external resistance. Let the difference of potential between Y and A be called e_1 and that between A and X e_2 . The currents in r_1 and ρ_1 may be represented by i_1 and γ_1 ; and similarly for the other currents. Let the resistances of the multiple arcs between Y A and A X be called respectively R'_1 and R'_2 . All existing forms of dynamo can then be represented by leaving out some of the conductors of this generalised system.

FIG. 315.

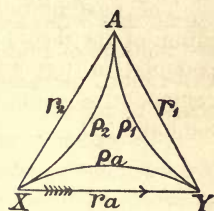

GENERALISED DIAGRAM OF DYNAMO.

For example, the ordinary series machine (with the notation used in Chapters XII. to XVII.) will be as shown in Fig. 316. There is an

FIG. 316.

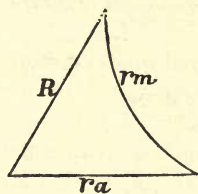

SERIES MACHINE.

FIG. 317.

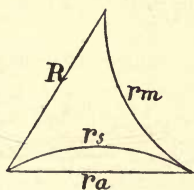

COMPOUND MACHINE. SHORT SHUNT.

FIG. 318.

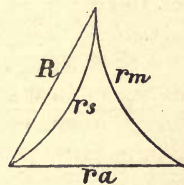

COMPOUND MACHINE. LONG SHUNT.

advantage in this generalised diagram and in Rücker's notation in one respect. The shunt in the compound dynamo may be either a shunt to the armature alone ρ_a , Fig. 315 [r_s of this book], or it may be a shunt to the external circuit ρ_2 of Fig. 315 [r'_s of Fig. 318, the accent being used here to distinguish it from the short shunt]. If it is agreed that r_2 of Fig. 315 shall always represent the external resistance (r_1 being in any practical case infinite), then ρ_1 represents the series-coils [r_m of this work] and ρ_2 the long-shunt coil.

Adopting Frölich's equation for magnetism (see preceding account), Rücker then writes :

$$E = \frac{n M (s_a \gamma_a + s_1 \gamma_1 + s_2 \gamma_2)}{1 + \sigma (s_a \gamma_a + s_1 \gamma_1 + s_2 \gamma_2)}$$

where M is a constant of the machine [= 4 A G κ of this book], s_a, s_1, s_2 , the numbers of turns of wire in the respective magnetising spirals, and σ the usual saturation constant. The products $s_a \gamma_a$, &c., are numbers of ampère-turns due to the magnetising currents. Were there initial permanent magnetism, an additional fictitious term $s_0 \gamma_0$ might be added.

The reader is referred to Prof. Rücker's paper for the steps of the argument by which (neglecting residual magnetism and reactions of armature) he arrives at the following expressions for potential and current in one of the two kinds of compound dynamo, viz. the short shunt.

$$e = \frac{I}{\sigma} \left\{ \frac{n M R r_s}{R (r_a + r_s) + r_m (r_a + r_s) + r_a r_s} - \frac{R r_s}{R Z + (Z r_m + S r_s)} \right\}$$

$$i = \frac{I}{\sigma} \left\{ \frac{n M r_s}{R (r_a + r_s) + r_m (r_a + r_s) + r_a r_s} - \frac{r_s}{R Z + (Z r_m + S r_s)} \right\}$$

Now simplify by grouping as follows:—

$$P_1 = \frac{n M r_s}{\sigma \{ r_m (r_a + r_s) + r_a r_s \}}, \quad A_1 = \frac{r_a + r_s}{r_m (r_a + r_s) + r_a r_s}$$

$$Q_1 = \frac{r_s}{\sigma (Z r_m + S r_s)}, \quad B_1 = \frac{Z}{Z r_m + S r_s}, \quad x_1 = \frac{1}{R}$$

$$P_2 = \frac{n M r_s}{\sigma (r_a + r_s)}, \quad A_2 = \frac{r_m (r_a + r_s) + r_a r_s}{r_a r_s}$$

$$Q_2 = \frac{r_s}{\sigma Z}, \quad B_2 = \frac{Z r_m + S r_s}{Z}, \quad x_2 = R$$

and we get

$$e = \frac{P_1}{A_1 + x_1} - \frac{Q_1}{B_1 + x_1}$$

$$i = \frac{P_2}{A_2 + x_2} - \frac{Q_2}{B_2 + x_2}$$

It will be noted that x_1 which appears in the expression for potential is the conductivity, and x_2 which appears in that for current is the resistance of the external circuit.

The equations for long-shunt machines are similarly treated by

Prof. Rücker, their symbols grouped and generalised, and expressions of similar form are deduced.

It is therefore clear that we may represent in a general equation of the form

$$\phi = P/(A + x) - Q/(B + x),$$

either the current or the potential at terminals of any compound dynamo; the quantities A, B, P, and Q being independent of the variable external resistance, and x being either the resistance or else the conductivity (according whether we are expressing current or potential) of the external part of the circuit.

The constant A is always either the resistance (or else the reciprocal of the resistance that the machine would offer when at rest, to the current of a battery placed in the external circuit. B is also either a resistance or the reciprocal of one. P is always either a current or an electromotive-force, and is proportional to the speed and to the maximum magnetism of the field magnet. Q is also either a current or an electromotive-force, and depends upon the currents requisite to circulate in the magnetising coils in order to magnetise them to the [diacritical] point of half-saturation.

Starting from this generalised formula, Rücker then investigates the conditions of efficiency, of maximum power, and of self-regulation. It is impossible to give an abstract of the mathematical argument; but certain results may be stated.

If ϕ represent potential at terminals, then $P/Q >$ or < 1 according as the speed is greater or less than the critical speed for the resistance of the circuit when $R = 0$.

If ϕ represent external current, then $P/Q >$ or < 1 according as the speed is greater or less than the critical speed when $R = \infty$.

A large value of A is favourable to good self-regulation.

For a given usual value of R, a high maximum efficiency is favourable to a large value of A in the case where ϕ represents ϵ ; but is favourable to a small value of A where ϕ represents i .

Hence it is more difficult to combine high efficiency of a machine with an approximately constant current than with an approximately constant potential.

Esson's Observations.—Some observations by Mr. W. B. Esson in the *Electrician* of June 1885 are worthy of consideration in connexion with recent theory. Mr. Esson asks why is it that compound dynamos wound so as to be self-regulating for a given speed, regulate fairly well at any speed within considerably wide limits? To explain this peculiarity he observes that in no dynamo is the quantity or

quality of the iron such that the saturation effect can be neglected. If the magnetism were strictly proportional to the ampère-turns of excitation, there would be literally a critical speed. The rule $\frac{S}{Z} = \frac{r_a + r_m}{r_s}$ always gives the number of series coils much too low, for when the shunt coil has already excited a certain degree of magnetisation, the series coil cannot produce its proportionate increase. In a series machine (designed to give a current of 20 ampères), the electromotive-force added to the machine by increasing the exciting current from 5 to 10 ampères is much greater than the electromotive-force added by increasing the current from 10 to 15 ampères. Again, a 100-volt machine (self-regulating) in which therefore the shunt gave excitement enough for 100 volts on open circuit had series coils upon it which were able, when the shunt was removed and the full current on, to give 60 volts between terminals. The value of the series coil to excite magnetism is diminished as the excitation due to the shunt is increased. From this it follows that a certain relation must subsist between the speed of the machine and the degree to which the magnets are excited by the shunt coil. Now the magnetism furnished by the shunt coil itself depends on the speed and increases with it. If, therefore, at one speed this relation is such as to produce self-regulation, the relation will be almost equally true at other speeds. At the high speed the relative value of the series coils is less, and at the low speeds it is greater; but the product of the two effects may be constant. At speeds lower than the normal speed, the potential is lower when there is a large resistance in circuit than where there is a small resistance in circuit. At speeds higher than the normal, the potential falls as the resistance is diminished. Mr. Esson deduces from the foregoing considerations certain practical hints as to how to improve the regulation of a dynamo whose potential rises either when many or when few lamps are in circuit.

APPENDIX V.

ON THE ALLEGED MAGNETIC LAG.

IT is often stated on high authority that the cause of the lead which must be given to the brushes of a dynamo is due to a sluggishness in the demagnetisation of the iron core of the armature. The pole induced in the iron core when the armature is standing still is exactly opposite the inducing pole of the field magnet. The pole induced in the core as it rotates when the dynamo is at work is not immediately opposite the field-magnet pole, but is observed to be a little in advance, apparently dragged round by the rotation. Those who take the view—the erroneous view as I shall show—propounded above, maintain that the induced pole is displaced by reason of a lag in the magnetism of the iron, which they say is due to the slowness with which the iron demagnetises.

Now, as a matter of fact, the sluggishness which is well known to take place in the magnetising and demagnetising of an ordinary electro-magnet (with a solid iron core) is not due to any slowness in the magnetism itself, but to the fact that in the mass of the iron eddy currents are set up whenever the magnetising current is turned off or on; and these eddy currents, while they last, oppose the change in the magnetisation. If the iron core be built up of a bundle of thin varnished iron wires, so that no such eddy currents can be set up, then there is no sluggishness or lag in the magnetising or demagnetising. In fact, this is how the cores are constructed for induction coils in which rapid changes in the magnetism are essential.

Now, for the sake of obviating wasteful eddy currents, the armature cores of all dynamos are built up either of wires or thin laminae of iron. If there are no eddy currents we should expect no lag. The displacement of the induced pole cannot, then, be due to this cause.

Moreover, it is well known that iron demagnetises more rapidly than it magnetises. If there is no greater delay in demagnetising than in magnetising, the explanation given of an alleged lag ceases to have any meaning in its application to the displacement in the induced pole.

With the view of arriving at a more accurate knowledge of this matter, a number of experiments, some of which will be briefly narrated, have been made from time to time. The author is also indebted to Mr. W. M. Mordey for a set of most valuable notes on the movement of the neutral point, which are, on account of their

importance, printed, with Mr. Mordey's kind permission, *entire* in Appendix VI.

The author took a short iron cylinder and placed it between the poles of a magnet. The intervening magnetic field was then examined by means of iron filings. It resembled Fig. 54, p. 64. The cylinder was then rotated rapidly by a multiplying gear: but no change in the lines of force, nor any displacement in the induced polarity could be detected.

It is of significance to remark that in dynamos built, as some have been, without iron in the armature, it is still found necessary, when they are running and feeding a circuit, to give a forward lead to the brushes. It is certain that in this case the displacement is not due to magnetic lag.

Mr. F. M. Newton has made some hitherto unpublished experiments on one of his dynamos. The field magnets were separately excited from an independent source, and the armature was driven round at a moderate speed. A piece of cardboard having a hole to admit the passage of the axle, was placed against the pole-pieces, covering one face of the armature. Iron filings were then sprinkled against the card, and arranged themselves along the lines of force. So long as the circuit was open, the pattern delineated by the filings resembled Fig. 54, p. 64, the field being quite straight. But when the circuit was closed so that a current traversed the armature circuit, immediately the lines of filings took up positions resembling Fig. 67, p. 78, the induced poles being displaced in the direction of the rotation. There could be no clearer proof wanted than this that the lead is not due to sluggishness in the demagnetisation of the iron, but that it is due to the diagonal direction of the resultant magnetisation as explained on p. 76.

Lastly, in some recent experiments of Mr. Willoughby Smith* upon the induction of electromotive-force in disks of iron and copper set to rotate between the poles of a magnet, it was found that whilst with disks of copper and silver there was a considerable lag, the point of maximum electromotive-force being considerably in advance of the position opposite the inducing poles, there was with an iron disk a far higher electromotive-force and no lag at all.

Experiments made by MM. Bichat and Blondlot (*Comptes Rendus*, 1882) showed that the magnetic lag if it existed at all must be less than 0·00033 sec. in duration.

It would be useless to discuss the question further.

* Willoughby Smith, *Volta- and Magneto-Electric Induction*. A lecture delivered at the Royal Institution, June 6th, 1884, see *Electrical Review*, xv. p. 83.

APPENDIX VI.

MOVEMENT OF NEUTRAL POINT.

Notes by MR. W. M. MORDEY.

Experiments with a Victoria Dynamo.

1. Ran at a steady speed of 1100 revolutions per minute—this being the normal speed for this particular machine. Separately excited the fields. Circuit of armature open. Placed the brushes on collector in usual way, moving them till total absence of sparking indicated that they were in the neutral position. Found that this position indicated *no lead*—as far as it was possible to ascertain with the necessarily rough conditions. Width of brush and of “neutral point” made it impossible to be sure of perfect accuracy; but as far as it went there was found no evidence of *lead*. No current was collected.

The exciting current was now varied—slowly, quickly, gradually, every way, between 4 and 13.7 ampères—the normal exciting current being 6.4 under ordinary working conditions, but no change whatever could be detected in the position of neutral point, speed kept steady at 1100 revolutions throughout.

The experiments were repeated with small brushes and a voltmeter, always with same results.

2. Brushes as in (1). Current in fields (separately excited) steady at 6.4 ampères. No current collected. Speed varied, up and down, from 250 to 1300 revolutions per minute. Could find nothing to indicate any movement of neutral point.

3. The brushes were then moved a little, first forward, then back, so that they were just off the neutral points, and a very slight sparking was perceptible.

Still keeping exciting current steady, the speed was varied as above, the object being to see whether the alteration of speed would bring the neutral point *up to*, or take it further *away from* the brushes. No alteration occurred, except a very slight increase of sparking at higher speeds, caused probably *not* by an alteration in the position of the neutral point, but by the increase of electromotive-force and larger current as the brush left the segments.

Experiment 3 repeated with constant speed and varying field. Result the same.

The previous notes refer to the case of an armature revolving in a magnetic field, but without the generation of current.

When Current is being Generated.

5. *Experiment.* (a). A "Victoria" machine made for 150 volts and 48 ampères was separately excited with a steady current in the fields, and run at full (normal) speed on three equal groups of 50 volt lamps, the groups being in *series*.

(b). One group was short-circuited, and the speed was reduced to get the same current and 100 volts on two groups of lamps.

(c). Another group was short-circuited, and speed again reduced till the machine gave 50 volts and 48 ampères.

The position of the brushes was the same in all three cases, and the neutral point was evidently the same throughout.

Character of Spark.

The character of the spark at the commutator of a Brush machine affords, to a practised eye, a very accurate index to the correctness of the position of the brushes.

In this machine the coils which are traversing the neutral point are out of circuit, and if the brushes are even slightly out of the proper position the coils which traverse the neutral position are cut out of circuit a little too soon, or too late, as the case may be; and this causes an alteration in the length and character of the spark.

6. *Experiment:* An ordinary No. 7 (16-light) Brush machine was run on a circuit consisting of resistance coils of suitable size; the current was kept constant at 10 ampères by switching in resistance as the speed rose; the speed was gradually increased from 160 revolutions to 1400 revolutions (the normal speed being 800). The difference of potential at the terminals rose from 90 to 1000. It was found that no change whatever was required in the position of the brushes, and that consequently the alteration of speed did not affect the neutral point.

7. When a Brush machine is run with less than its full complement of lamps, and is made to give the ordinary current, by having its speed reduced, the position of the brushes is always the same. This is the case even with a 40-light machine, throughout its whole working range.

The foregoing notes are of simple experiments made without any special apparatus or precautions, the object being to find whether there is any *practical* movement of the neutral line

produced by speed. The conclusions to which they appear to point are:—

1. When no current is being generated, neither speed nor strength of field have any effect on the position of the neutral point, which is the same (sensibly) whether the armature is at rest or revolving.
2. When the strength of the field, and the current in the armature, are constant, the position of the neutral line is likewise constant, speed having no effect on it. This is even the case with a cast-iron armature, like that of the Brush machine.
3. The eddy currents do not appear to have the effect that might have been expected.

APPENDIX VII.

ON THE FORMS OF FIELD MAGNETS.

IN Chapter III., on the organs of dynamos, much was said about the general principles which should be followed in the design of field magnets. The reader will doubtless have noted in the descriptive matter which followed, how these principles were observed, and how also many of them were violated, in the actual forms of machines which are to be found in commerce. A brief review of the leading forms will present the matter in a clearer light. That which is desired in the field magnets is that the iron core and its coils shall be so disposed as to give with a minimum expenditure of energy the maximum of effective magnetism in that region where the armature coils are moved. To promote this desirable end it has been pointed out many times over that there should be as far as possible a closed magnetic circuit; the iron core of the armature completing the circuit between the field-magnet poles: the only gaps in the circuit being the spaces which are absolutely necessary for the movement of the conducting wires of the armature. Further, that the iron should be of the best possible quality in respect of its power to conduct magnetic lines of force, that is to say of high permeability, and also of sufficient cross-section, for the reason that the magnetic conductivity of a bar is proportional to its area of cross-section. It has been pointed out by Rowland that theoretically it is better that there should be one such magnetic circuit than that there should be

two: though for practical structural reasons the author thinks the double circuit preferable in many cases. These points should be

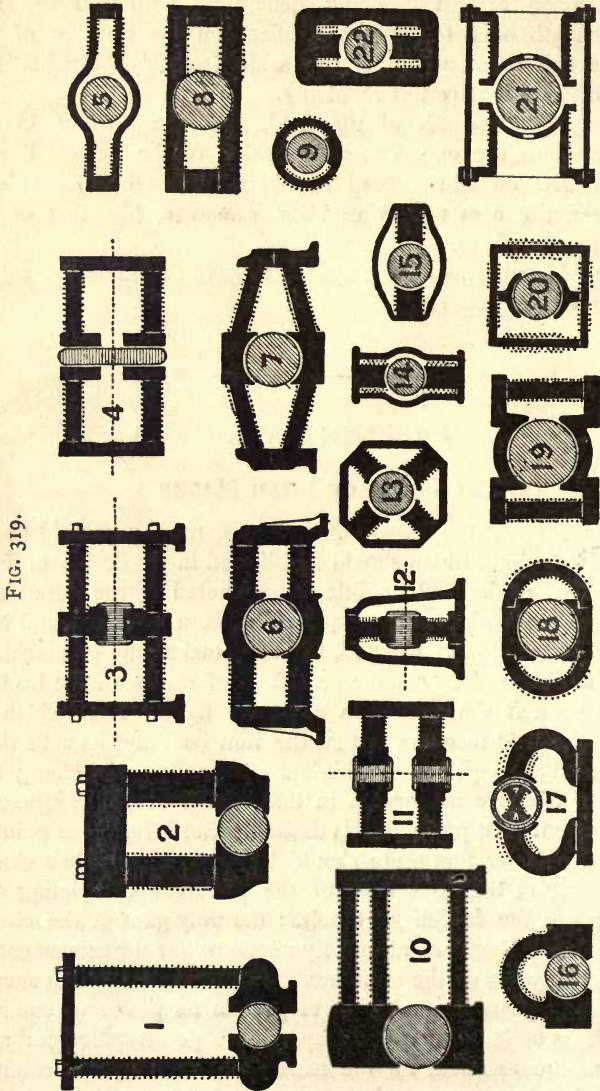

FIG. 319.

TYPICAL FORMS OF FIELD MAGNETS.

borne in mind in considering the forms depicted in the accompanying figure, and which relate almost exclusively to dynamos of Class I.,

that is to say those in which the armature rotates in a simple field. No. 1 of these illustrations shows the form adopted by Wilde for use with the shuttle-wound armature of Siemens. Two slabs of iron are connected at the top by a yoke, and are bolted below to two massive pole-pieces. There are four joints in the magnetic-circuit, in addition to the armature-gaps, and the yoke is insufficient. No. 2 shows the form adopted in the latest Edison dynamos (American pattern). The upright cores are stout cylinders. The yoke is of immense thickness: the pole-pieces are massive, but their useless corners are cut away. There are as many joints as in Wilde's form; but such a circuit would possess a far higher magnetic conductivity than Wilde's owing to the greater cross-section. One difficulty with such single-circuit forms is how to mount them upon a suitable bed-plate. If mounted on a bed-plate of iron, a considerable fraction of the magnetism will be short-circuited away from the armature, even though an intermediate bed-plate of zinc some inches deep be interposed. In the larger form No. 10, used by Edison in his steam-dynamos, this difficulty is only partially obviated by turning the magnets on one side. In a recent and excellent machine of the *Tecnomasio italiano* of Milan, designed by Sig. Cabella, the magnets resemble No. 2 inverted.*

The favourite type of field magnet, having a double magnetic circuit with consequent poles, is represented in No. 3; it was introduced by Gramme. It may be looked upon as the combination of two such forms as No. 1, with common pole-pieces. Nos. 3 to 9 may be looked upon as modifications of a single fundamental idea. No. 4 gives the form used in the Brush dynamo (plan), the two magnetic circuits being separated by the ring armature. The diagram will serve equally for many forms of flat-ring machine; but in most of these the poles at the two flanks of the ring are joined by a common hollow pole-piece, embracing a portion of the periphery of the ring. No. 5 shows the well-known form of Siemens, with arched ribs of wrought iron, having consequent poles at the arch. The circuit is here of insufficient cross-section. No. 6 depicts the form adopted by Weston: and very similar forms have been used by Crompton,

* [Note added Nov. 25, 1885.] Since the above account was set up in type, a remarkable paper has just been communicated by Mr. Gisbert Kapp to the *Institute of Civil Engineers*, in which he describes some dynamos of his own design having also field magnets like No. 2 inverted. Mr. Kapp also gives a sheet of figures closely resembling that on p. 496, but prepared in entire independence of the author. In Mr. Kapp's paper there is further a valuable contribution to the theory of the magnetic circuit.

and by Paterson and Cooper. There is a better cross-section here. No. 7 is a form used by Bürgin and Crompton, and differs but slightly from the last. It has one advantage—that the number of joints in the circuit is reduced. No. 8 is a form used by Crompton, Kapp, and by Paterson and Cooper. No. 9 is the form adopted in the little Griscom motor. No. 18 is a further modification due to Kapp. No. 19, which also has consequent poles, is used by McTighe, by Joel, and by Hopkinson ('Manchester' dynamo), but with slight differences in proportions of the details. The main difference between No. 19 and No. 6 lies in the position selected for placing the coils, No. 19 requiring two, No. 6 four. No. 20, which is the design of Elwell and Parker, is a further modification of No. 3, and would be improved by having a greater cross-section. In No. 3 (Gramme) it is usual to cast the pole-pieces and end-plates, but to use wrought iron for the longitudinal cores. The requisite polar surface must be got by some means, and when the core was made thin, the two courses open were either to fasten upon the core a massive pole-piece (Nos. 1, 3, 4, 6, 7, 19, 20), or else to arch the core No. 5 so that its lateral surface was available as a pole. Now, however, that it is known that massive cores are of advantage, the requisite polar surface can be obtained without adding any polar expansion or "piece," but by merely shaping the core to the requisite form (No. 8). This must not be regarded as a mere thinning of the magnet; for though mere reduction of cross-section at any part of the circuit would reduce the magnetic conductivity, reduction of the thickness for the purpose of bringing the armature more closely into the circuit will have quite the opposite effect. Nos. 11 to 15 illustrate forms of field magnet having *salient*, as distinguished from *consequent* poles. No. 11 is the double Gramme machine designed by Deprez. Nos. 12 and 13 are two of the innumerable patterns due to Gramme himself. These are both of cast iron; and it will be noticed that in No. 13 there are no joints, it being cast in one piece. No. 14 is the form used by Hochhausen, and is practically identical with 21 save in the position of the axis of rotation. The iron flanks of No. 14 tend to produce a certain short-circuiting of the magnetism by their proximity to the poles; and their sectional area is insufficient. No. 15, used by Van de Poele, is similar. No. 16 is the form used by the author in small motors, and is cast in one piece. The semi-circular form adopted for the core was intended to reduce the magnetic circuit to a minimum length. No. 17 illustrates the form used by Jürgensen, having salient poles reinforced by other electro-magnets within the

armature. No. 21 shows in section the double tubular magnets of the Thomson-Houston dynamo, the spherical armature being placed, as in Nos. 12, 14 and 15, between two salient poles. There is a curious analogy between Nos. 21 and 19; but they entirely differ in the position of the coils. No. 22 is a design by Kapp, in which there are two salient poles of similar polarity, and two consequent poles between them, one pair of coils sufficing to magnetise the whole quadruple circuit.

It was stated by the author, on p. 36, that theoretically the best cross-section for field-magnet cores was circular, as this gave the greatest area for least periphery, and therefore presumably would for a given length of wire in the coil give the largest amount of iron to be magnetised. This, of course, means that if the length of wire and the number of turns be given, a core of this section will, of all possible shapes of core, take the greatest number of ampères to bring it to the diacritical point of semi-saturation. Now, it was the author's discovery, in 1884, that either the electromotive-force or the current of every dynamo is proportional to that number of ampère-turns which will bring it to this diacritical point. This discovery renders it more than ever needful in designing dynamos to adhere as closely as possible to the author's previous advice to make the core of circular section whenever the construction will admit of it. Again, as was pointed out by Hopkinson, it is a mistake to construct a field-magnet with two or more parallel cores uniting at a common pole-piece; for not only is the wire between the two cores useless, it is worse, because it offers wasteful resistance. To divide the iron that might be in one solid cylindrical core into two parallel cylindrical cores, implies, of course, that for every turn of wire two turns must be used, each of which is more than half as long as the original one, the total length being increased as $\sqrt{2} : 1$, while the magnetising power is actually reduced. The following calculations are therefore added, which show the area (in square centimetres) enclosed in a number of different forms of section, the total periphery of each being one metre.

Circle	796
Square	625
Rectangle, 2 : 1	555
,, 3 : 1	469
,, 4 : 1	400
,, 10 : 1	236
Oblong, made of square between 2 semicircles	675
,, ,, 2 squares	548

Two circles (section of 2 parallel cores as in Edison "L" and Siemens "F. 34" machines	398
" " but assuming wire to be wound right around both cores at once	594
Three circles (section of 3 parallel cores, as in Edison "K" and early Weston dynamo)	265
Four circles (section of 4 parallel cores, as in Gramme vertical dynamo, Fig. 93)	199
Eight circles (section of 8 parallel cores, as in Edison's steam dynamo, Fig. 133)	99

It will be convenient to point out here the law of the induction of magnetic lines of force in magnetic circuits, resembling the law of Ohm for electric circuits, and which has been more or less clearly stated by Bosanquet,* by Rowland,† and by Kapp.‡ According to this law the flux of magnetic lines of force N will vary directly as the magnetomotive-force P , and inversely as the magnetic resistance Y of the circuit. Or, in symbols,

$$N = \frac{P}{Y}.$$

The magnetomotive-force P is here proportional to the number of ampère-turns of excitation. The magnetic resistance will be the sum of all the magnetic resistances of the magnetic circuit. Rowland gives it in the following form :

$$Y = \frac{L_m}{A_m \kappa} + \frac{L_a}{A_a} + p,$$

where L_m and L_a are the respective lengths of iron-core and air-gap which the magnetic lines have to traverse; A_m and A_a the cross-section of iron magnet and of air-gap (i. e. area of polar surface) respectively; κ the permeability; and p a number depending on the leakage of lines of force across the edges of the field. Some such law is greatly needed in treating the magnetic problems of the dynamo.

* Bosanquet, *Philos. Magaz.*, Series V., vol. xv., March 1883, and vol. xix., February 1885, also *Electrician*, vol. xiv., Feb. 14, 1885.

† Rowland, *Philos. Magaz.*, Series IV., vol. xvi., 1873, see also *Electrician*, vol. xiv., Oct. 25, 1884, and *Electrical Review*, vol. xv., Nov. 8, 1884.

‡ Kapp, *Electrician*, vol. xiv. p. 345, Mar. 7, 1885.

APPENDIX VIII.

ON THE INFLUENCE OF POLE-PIECES.

THERE exists a singular dynamo which is best described as a kind of perverted Gramme machine, being, in fact, a double machine with two Gramme rings, each of which, however, has only one pole-piece to furnish it with the requisite magnetic field. Its inventor, Mr. Ball, calls it a unipolar dynamo, and considers it a great improvement to omit one of the pole-pieces from each armature. Quite apart from the question whether this particular machine may or may not be well constructed in itself, is the more important general question whether or not the omission of one pole-piece or polar surface adds to the power or efficiency of the machine. All the evidence goes the other way. The omission of the pole-piece—leaving not even a polar face

FIG. 320.

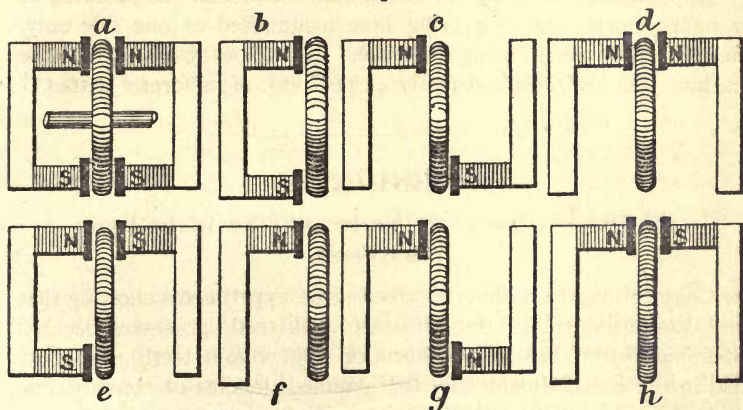

EXPERIMENTS ON INFLUENCE OF POLE-PIECES.

to concentrate the lines of magnetic force—always diminishes the strength of the magnetic field, and increases the tendency to useless scattering of the magnetism. An ordinary 2-pole Gramme dynamo, tested by Mr. C. Lever, gave at a speed of 1250 revolutions per minute, 20 ampères at 150 volts, i. e. 3000 watts. When the lower pole-piece and magnet core were removed, it gave at the same speed and with the same resistances only 14 ampères at 90 volts, i. e. 1260 watts.

A set of experiments made two years back by Mr. Mordey, with a Schuckert dynamo, are still more conclusive. Eight different arrangements of poles were tried, as indicated in Fig. 320.

The speed was maintained constant at 1180 revolutions per minute. The field magnets in all cases were separately excited by a current of 4·73 ampères, being the ordinary working field-current of that machine. The external circuit was throughout of 2·2 ohms resistance. The eight results were as follow :—

Experiment.	Potential at Terminals (volts).	Current (ampères).	Watts in External Circuit.
<i>a</i>	69·8	31·22	2179
<i>b</i>	54·5	24·8	1155
<i>c</i>	46·6	21·3	994
<i>d</i>	46·3	21·2	982
<i>e</i>	22·	10·	220
<i>f</i>	21·7	9·9	215
<i>g</i>	1·4	0·6	0·9
<i>h</i>	0	0	0

Experiment *d* corresponds to the case which Ball has patented as an improvement, the ring being here magnetised at one side only, the south pole-pieces being removed. It will be observed that the machine thus *improved* gives only 45 per cent. of its former output !

APPENDIX IX.

ON THE INFLUENCE OF PROJECTING TEETH IN RING-ARMATURES.

IN Chapter IV., the author described some experiments showing that the Pacinotti form of ring-armature with teeth possesses decided advantages over the Gramme form of ring without teeth, remarking that in those experiments he had assumed the cost of construction, the liability to heat, and other circumstances of a practical kind to be equal in the two cases.

In Chapter V., the author shows how the employment of armatures with projecting teeth may give rise to wasteful eddy-currents in the field magnet. It might have been concluded from this that toothed armatures are on this account to be condemned for practical purposes.

But the advantage possessed by the toothed armatures in affording excellent paths for the magnetic lines of force, and thus reducing the magnetic resistance of the gap between armature-core and field magnet, is one not lightly to be thrown away ; and additional information on the subject confirms the original opinion of the general superiority of the Pacinotti construction.

Mr. Crompton found, in experimenting with armatures of Burgin's kind with protruding corners of iron (p. 129), and with armatures of his own later pattern (p. 130), that the Burgin form was preferable when the field magnets were relatively weak; for with a weak field the projecting corners of iron appeared to gather up and concentrate the magnetic lines of force. With strong field-magnets he found little difference. Mr. Esson, in working upon the "Phoenix" dynamo (p. 137), found a similar result—namely, that with an unsaturated field the toothed armature gives a higher electromotive-force than a smooth armature. He has also found that the tendency of the projecting teeth to generate eddy-currents may be to some extent overcome by making the teeth numerous, and is fully overcome by increasing slightly the clearance between the armature and the polar surface. The gain in using teeth more than compensates for any loss entailed in the use of a wider air-gap; while, at the same time, ventilation is improved, and there is less risk of damage to the coils. The presence of teeth is also a gain from the point of view of ventilation, as they help to radiate from the interior of the coil the heat that would otherwise be confined.

Lastly, in view of the great peripheral drag (p. 470) exerted by the magnetic field on the coils of the armature, tending to drag them round on the core, the existence of iron teeth projecting between the coils is a pure gain; though, of course, proper precautions must be taken to prevent any short-circuiting between the coils and core by the interposition of suitable insulation of a durable kind.

The effect of the teeth in concentrating the magnetism of the field magnet more when the latter is unsaturated than when it is well saturated, has the effect of causing the characteristic curve to be more bent than it would otherwise be, and renders the machine a little less easy to "compound." But here the effect only differs in degree from the effect produced in general by increasing the magnetic capacity of the armature in any dynamo. Increasing the capacity of the armature, *per se*, has the effect of enabling the field-magnet coils to saturate the magnetic circuit to any given degree of saturation with a less current than before. Now, compounding is easier when the "diacritical" number of ampère-turns is very high, for the characteristic is then straighter. Increasing the conductivity of the magnetic circuit by altering the form of the armature reduces this number, and therefore augments the difficulty of obtaining perfect self-regulation. The difficulty may at least to some extent be met by giving greater attention to the proper positions for the coils, as laid down on p. 104.

APPENDIX X.

ELECTRIC GOVERNORS.

THE subject of electric governors for steam engines was briefly alluded to in Chapter VI. No centrifugal governor attached to the steam-engine can keep the speed of the dynamo truly constant; for it does not act until the speed has become either a little greater or a little less than the normal value. Few mechanical governors will keep the speed within 5 per cent. of its proper value, under sudden changes of load. Hence the suggestion

FIG. 321.

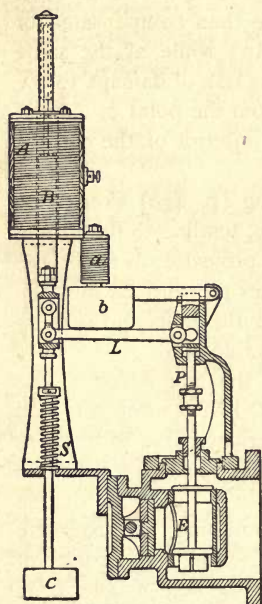

RICHARDSON'S ELECTRIC GOVERNOR.

which underlies all electrical governors, that the admission of steam from the boiler to the engine should be controlled by the electric current itself, the speed of driving being varied according to the demands of the circuit. Numerous suggestions of a more or less practical nature have been made by Lane-Fox, Andrews, Richardson, and others. The three forms which will here be described are those which are in practical use.

Richardson's Governor.—This governor is used to maintain either a constant current or a constant potential. In the former case its coils are included in the main circuit and are of thick wire: in the latter they are arranged as a shunt to the mains and are of fine wire. The arrangements are shown in Fig. 321.

The valve which admits steam to the engine is a double-beat equilibrium valve *E*; its stalk passes upwards and is acted upon by a plunger *P*, which is pressed down by the shorter end of a lever *L*, which is in turn connected with a long vertical spindle having a weight *C* at its lower end, and at its upper end carrying the iron core *B*, surrounded by the solenoid *A*. A spring *S* counterpoises the slight upward pressure of the steam on the valve. When the current passes through the solenoid *A*, it lifts the core *B* to a certain height, and admits to the engine a sufficient quantity of steam to drive the

engine at the speed requisite to maintain the current. Should the resistance of the circuit be increased by the introduction of additional lamps, the core B will fall a little, thereby turning on more steam, until the speed has risen to that now necessary. For additional safety a separate electro-magnet *a* is added, which when in action holds up the heavy iron block *b*. Should the circuit from any cause be broken, the block *b* instantly descends and cuts off the steam. In some experiments made at Lincoln in 1883 in the author's presence on a Brush 16-light machine fitted with a Richardson's governor, the following results were attained:—Seventeen arc lamps being alight, six were suddenly switched off: in four seconds the speed of the engine came down from 138 to 107, and the current which was 10·2 ampères had returned to exactly the same value. Seventeen lamps being again alight, the whole were short-circuited, leaving the current running only through the governor and the field magnets of the dynamo. The engine pulled up in less than one stroke, and in fourteen seconds the speed had come down to 24, the engine just crawling round at a speed sufficient to keep the magnets charged. In another experiment the circuit of the whole seventeen lamps was suddenly broken, the engine running at 140. In fifty-five seconds it had stopped, the steam having been cut off in less than a quarter of a second. No centrifugal governor could have so instantaneously shut off steam: it would not have acted until the engine began to race. With the electric governor the steam was cut off before racing could even begin. At all speeds from 25 up to 146 revolutions per minute, and with any number of lamps from none to seventeen alight, the current was practically kept at a constant value in a most efficient manner. Another of these governors connected with an incandescent-light system working at 92 volts was found to keep the potential correctly to within 1 per cent., even though the number of lamps was varied from 91 to 31, and the boiler-pressure from 32 to 55 lbs. per square inch. It also maintained an absolutely constant potential when but one lamp was alight, though the boiler-pressure was purposely varied from 31 to 55 lbs. per sq. inch.

Willans' Governor.—This instrument has been applied with great success at Victoria Station and elsewhere. In common with Richardson's governor, it employs the attraction exerted by a solenoid on an iron core to actuate an equilibrium valve; but the action is indirect, the solenoid core operating on the small valve which controls a hydraulic piston, the latter in turn controlling the large steam valve. The arrangement is shown in Fig. 322, where T is the large piston throttle-valve. The throttle-valve spindle passes downwards

and is connected direct to the piston of the hydraulic relay. The solenoid A attracts its core B suspended on a spring. The position of B determines that of the lever X, which is connected at one point to the spindle of the throttle-valve and at another to that of the small controlling valve. If the potential at the mains falls, less current flows

FIG. 322.

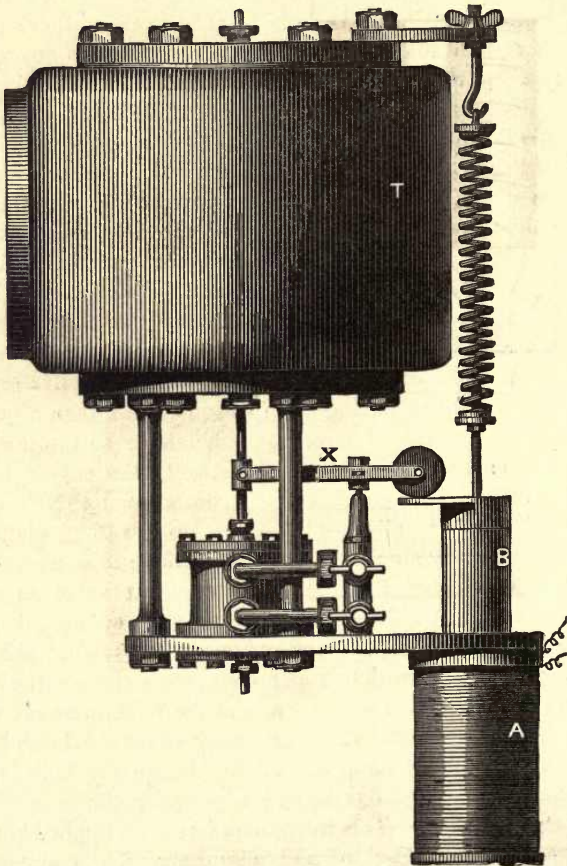

WILLANS' GOVERNOR.

round A, in consequence B rises, and its projecting ear-piece raises the lever X, admitting more water above the controlling piston, which consequently sinks, drawing down the throttle-valve with great power and admitting more steam to the driving engine. A compara-

tively small solenoid, actuated by but 0.3 ampère of current and absorbing only about 32 watts of power, may thus bring a force of many pounds to bear upon the steam valve, and will control with ease a 60 horse-power engine.

FIG. 323.

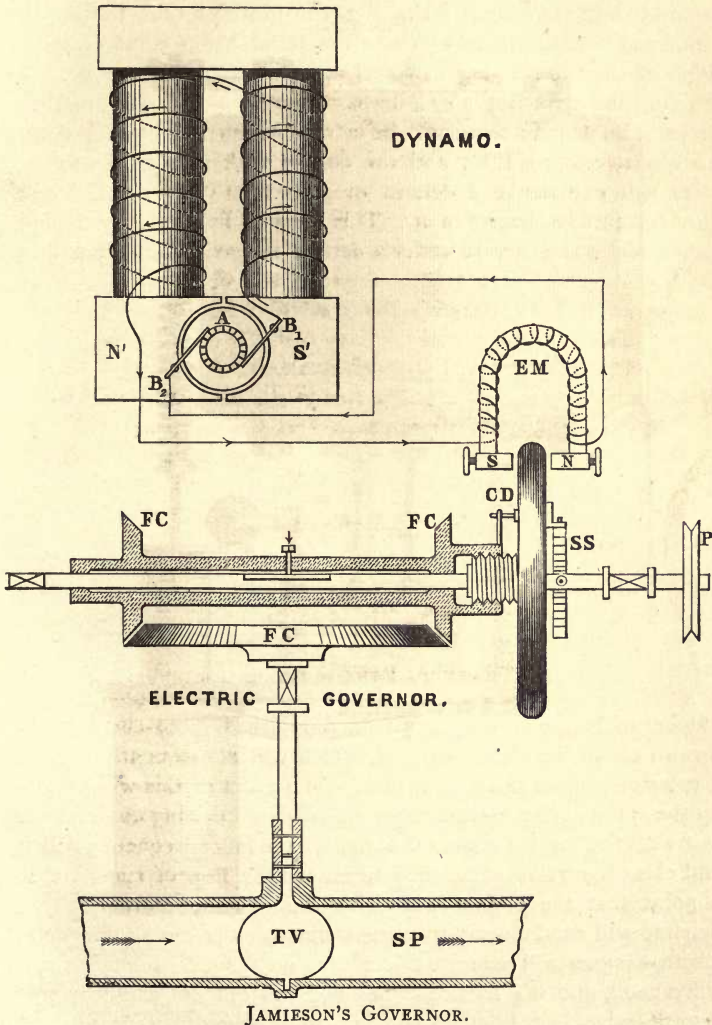

Jamieson's Governor. — This consists of a copper disk CD (Fig. 323) revolving between the poles of a small electro-magnet

EM, and actuating a throttle-valve, TV, by means of a spring and a cone gearing. The pulley P is driven by a band from the dynamo shaft. Its spindle passes loose through the copper disk, to which its motion is communicated through the spiral spring SS. The disk has projecting at one side a screw which engages in a sliding sleeve having two friction-cones FC. Between these is a third friction-cone connected with the throttle-valve: the latter being turned whenever either of the two rotating cones is pressed against third cone. The action of this governor is as follows. Suppose the normal number of lamps to be alight: there will be a certain current flowing through the electro-magnet EM, and the copper disk rotating between its poles will experience a certain drag owing to the reaction of the eddy-currents generated in it. This drag is balanced by the spiral spring, which is therefore under a certain normal strain. Should the

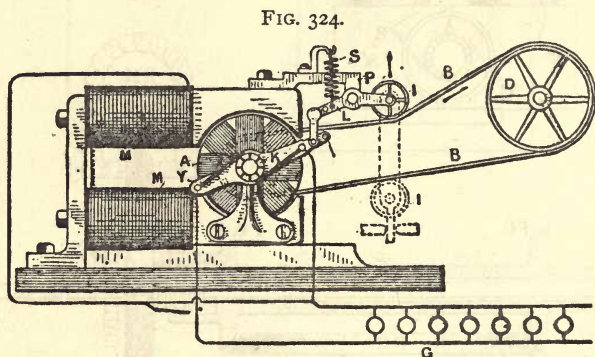

ELIHU THOMSON'S DYNAMOMETRIC GOVERNOR.

number of lamps on the circuit be diminished, more current will be thrown round the electro-magnet, which will consequently exercise a greater drag upon the copper disk. The effect of this will be to coil up the spiral spring and to bring the left-hand driving cone into contact with the large horizontal cone, which in consequence will turn and close the valve sufficiently to reduce the flow of steam to such a point that the engine will drive the dynamo more slowly, the dynamo will send a smaller current through the electro-magnet, the electro-magnet will exercise a less drag on the disk, the spiral spring will uncoil, and the friction-cones will fall out of gear, leaving the throttle-valve in its latest position until some further change is needed.

Elihu Thomson's Dynamometric Governor.—This is a dynamo-

metric governor, which alters the lead of the brushes in correspondence with any change which may occur in the driving force. The belt B which passes from the driving pulley D to the dynamo is under unequal tension in its two parts, the difference of tension between the upper and lower portions being greater according to the torque on the shaft of the dynamo. With greater tension, there will be a greater upward force exerted upon the small pulley P, the rise of which will shift the brushes forward. No information as to the practical working of this interesting form of governor is yet to be obtained.

Further information respecting electric governors and their actual applications in various installations of electric lights may be found in the following papers:—A. Jamieson, *Electric Lighting for Steamships*, Proc. Inst. Civil Engineers, vol. lxxix., Session 1884-5, part i.; P. W. Willans, *The Electric Regulation of the Speed of Steam Engines*, Proc. Inst. Civil Engineers, vol. lxxxi., Session 1884-5, part iii.

APPENDIX XI.

STATISTICS OF SOME RECENT DYNAMOS.

IT is not always easy to obtain statistical information of a precise character concerning dynamos. The following data are therefore given, not because these particular machines are better than all others; probably there are many machines by the same and by other makers, that are at least as good in design and performance. The data given are the best that are accessible to the author at the current date.

CROMPTON DYNAMO (25-unit).

Revolutions per minute, 440.

Volts, 110.

Ampères, 229.

Armature: diameter, 12 inch; length, 28 inch; radial depth of ring-core, $2\frac{1}{2}$ inch.

Field Magnet: length, 42 inch; breadth, 24 inch; depth of core, $4\frac{1}{2}$ inch. Excitation of field magnet at full load, 24,000 ampère-turns.

EDISON-HOPKINSON DYNAMO (34-unit).

Revolutions per minute, 800.

Volts, 115.

Ampères, 300.

Total weight of copper in machine, 260 lbs.

Watts per lb. copper, 127.

Armature: diameter of core-disks, 9.68 inch; length, 10 inch. Winding, 40 turns of 16-strand .069 in. gauge wire; $r_a = 0.009$; weight of copper, 55 lbs.; watts per lb. copper, 619; 40-part collector; current-density, 2570 ampères per sq. in.; watts lost in armature, 847.

Field Magnet: core length, 24 inch each limb; core section, 18 in. \times 9½ in. = 171 sq. in.; shunt coils, 8 layers of 193 turns each of .095 in. gauge wire; $r_s = 16$ ohms; $Z = 3080$; $i_s = 6.88$ ampères; excitation, $Zi_s = 21,300$ ampère-turns; watts lost in shunt, 784; weight of copper in shunt, 205 lbs.; current-density in shunt, 970 ampères per sq. in.

KAPP'S DYNAMO (17-unit, slow speed).

Revolutions, 340 per minute.

Volts, 110.

Ampères, 155.

Total weight of copper in machine, 510 lbs.

Watts per lb. copper, 33.4.

Armature: diameter, 16 inch; length, 24 inch; winding, 200 turns of .165 inch square conductor; $r_a = 0.07$ ohm; weight of copper, 90 lbs.; watts per lb. copper, 190; current-density, 2840 ampères per sq. in.

Field Magnet: core section, 20 in. \times 3.5 in. = 70 sq. in.; shunt coil of 0.083 in. gauge wire; $r_s = 22$ ohms; $i_s = 5$ ampères; series coil of 0.160 gauge, 6 in parallel; $r_m = 0.023$ ohm; total excitation, 24,000 ampère-turns; current-density in shunt, 925 ampères per sq. in.

KAPP'S DYNAMO (4½-unit, arc lighting).

Revolutions, 1150 per minute.

Volts at terminals, 300.

Ampères, 15.

Armature: diameter, 8.5 inch; length, 11.5 inch; winding, 36 sections, each 16 turns of 0.057 gauge; total length, 1245 feet, or about 4 feet per volt.

Field Magnet: vertical; cross-section, 8 in. \times 2 in. = 16 sq. in.

PHENIX DYNAMO (PATERSON AND COOPER) (65-unit).

Revolutions, 800 per minute.

Volts at terminals, 105.

Ampères, 620.

Weight of copper in machine, 1275 lbs.

Watts per lb. copper, 51.

Armature: weight of iron in core, 530 lbs.; weight of copper in coil, 175 lbs.; length of coil, 240 feet; $r_a = 0.0055$ ohm; watts per lb. copper, 372; current-density, 2100 ampères per sq. in.; volts per yard copper, 1.31.

Field Magnet: core section, 9 in. \times 9 in. = 81 sq. in.; $r_m = 0.004$ ohm; $r_s = 10.00$ ohms; total excitation = 80,000.

MANCHESTER DYNAMO (MATHER AND HOPKINSON) (24-unit).

Revolutions, 1050 per minute.

Volts, 110.5.

Ampères, 220.

Total weight of copper in machine, 242 lbs.

Watts per lb. copper, 100.

Armature: diameter core, 12 inch; length core, 12 inch; winding, 120 turns of 0.203 in. gauge wire; volts per yard copper, 1; $r_a = 0.023$ ohm; weight of copper, 42 lbs.; current-density, 2270 ampères per sq. in.; watts per lb. copper, 576.

Field Magnet: cores cylindrical, 7.5 in. diam., 12.5 in. length; shunt winding, 1680 turns of 0.065 gauge wire; $r_s = 19.36$ ohms; weight of copper in shunt, 100 lbs.; series winding, 42 turns of treble 0.203 wire; $r_m = 0.012$ ohm; weight of copper in series coil, 100 lbs.; total excitation, 21,400 ampère-turns. Current-density in shunt, 1750 ampères per sq. in.

Several points in the foregoing statistics are noteworthy. Of primary importance is the number of watts of output per pound weight of copper. In no respect more than this have the recent machines advanced beyond the older forms. The old-pattern Brush machine gave only about 59 watts per pound of copper on the armature: the new-pattern Brush armature with the same field magnets gives about 90. If the field magnets were remodelled, and their cores made of soft wrought-iron, the number of watts per pound of copper in the armature might be raised to 200 or more, and the old forty-light machine which as now improved supplies

sixty arc lights might then yield current for over 100 lights. The "A" Gramme manufactured in France gave only about 70 watts per pound of copper; a very good "A" Gramme by Emmerson and Murgatroyd gave 87 watts per pound; but in some recent modified Gramme dynamos by Messrs. Goolden and Trotter with more substantial field magnets and iron disk-cores instead of wire cores in the armature, the output is no less than 306 watts per pound of copper. Even this figure is far surpassed by three of the dynamos mentioned above, and there is no reason to think that finality has yet been reached. Another important point in comparing dynamos is the relation between the output and the total weight of copper in the machine. The number of volts of electromotive-force per yard of copper in the armature is important, because, for equal speeds of driving, this is a measure of the effective magnetism of the field magnets. In the modern dynamos with powerful field magnets it is believed that one volt per foot length of rotating conductor has not yet been attained, at any practical speed of driving, save perhaps in the exceptional case of Forbes' dynamo, which, however, is unsuitable for electric lighting. Further data on these points are eminently desirable for a basis of comparison of machines.

INDEX.

	PAGE
ACTIVITY	108, 132, 268, 405, 465
" Maximum, of Motor	406, 461, 465
Adams, W. Grylls ; Cantor Lectures	128
" " Tests made at Crystal Palace Exhibition	471
" " Inaugural Address	471
" " On Alternate-current Dynamo	347
Accumulators, Charging of	386
Air Blast	46, 199
Algebraic Theory	241
Allan's Armature	30
"Alliance" Dynamo	208
Alteneck, Von Hefner	152, 205, 467
Alternate-current Dynamos	208, 325, 340
Ampère's Rule	7, 272
<i>Ampère</i> , the, Unit of Current	111
Ampère-turns	113, 278, 355, 477
Angle of Lead	70, 75, 423, 426, 439, 493
Angle of Lag	330, 342, 491
Angular Velocity	108, 242, 244, 465
Arago Disk (<i>see</i> Ball).	
Arc, Voltaic	373
Armature Coefficient	241, 248
Armatures, Balancing of	34
" Classification of	23, 28
" Construction of	30
" Coils of	31
" " Method of securing	33
" Cores of	30
" Disk	28, 205
" Drum	26, 28, 152
" Pole	28, 30
" Ring	25, 28, 66, 113, 502
" Closed Coil	25, 113

	PAGE
Armatures, Open Coil	27, 175
" Brush's	188
" Crompton's	129
" Edison's	164
" Ferranti's	218, 219
" Gramme's	115, 119, 124
" Heating of	33
" Induction in	49
" Kapp's	136
" Pacinotti's	69, 113, 502
" Reactions due to	70, 423
" Siemens'	152
" Thomson-Houston's	192
" Ventilation of	49
" Weston's	170
" Winding of	31, 125, 181
Automatic Regulator (<i>see</i> Governors).	
Average Electromotive-force	242
Ayrton and Perry Dynamo	206
" Dynamometer	465, 467
" Motor	432
" Theory of Governing Motors	447
" on Measurement of Discontinuity	260
" on Apparent Resistance of Armature	82
" on alleged Magnetic Lag	72

B.

BALANCING of Armature	34
Ball's Dynamos	206, 230, 501
Barlow's Wheel	223
Board of Trade Unit	111
Bosanquet, R. H. M.	90, 101, 477, 478, 500
Bobbin (<i>see</i> Armature).	
Bourbouze's Motor	399
Boys, C. V., Integrator	59
Brackett, Cyrus F.	470
Breguet, Antoine	5, 73
Breguet-Gramme Dynamo	122
Bright, Sir C., Dynamo	228
Brockie's Dynamo	205
Brush's Armature	188
" Automatic Regulator	105
" Commutator	184

	PAGE
Brush's Dynamo :	180
" Dynamo, Characteristic of	367
" Teaser Circuit	99, 180, 238
Brushes, the	21, 47, 53
" Automatic Adjustment	79, 107, 124, 196, 509
" Difference of Potential at	53, 264, 279
" Lead of	21, 70, 75, 423, 426, 439, 493
Bürgin (<i>see</i> Crompton).	
" Motor	437

C.

CABANELLAS, G., on Transmission of Power	421
" " on Apparent Resistance of Armatures	82
Cabella's Armature	124
Capacity of Machines	III, 511
Cardew's Winding of Dynamos	108
" Voltmeter	334
Centrifugal Governors of Dynamo	108
" " of Motor	445
Characteristic Curves	350, 356, 359, 457
Charging Accumulators	386
Circuit, Electric	8
" Magnetic	xii, 38, 287, 495
" Open	27, 175
" Teaser	99, 180, 238
Classification of Machines	15, 218
" of Armatures	28
Clausius, R.	xi, 73, 476
Collector (<i>see</i> Commutator).	
" of Alternate-current Dynamo	221
Combination Methods of Windings	94, 300, 448
Commutator	21, 26, 44, 128, 184, 199
" Insulation of	46
" Potential at	53, 187
" Brush's	184
" Thomson's	199
" Ventilation of	46, 199
Compound Winding	99, 103, 151, 156
" " Best Method of	104
" " Theory of	104, 301, 308, 312, 448, 485, 488, 489
" " Anglo-American Company's	48, 312
" " Brush's	99
" " Crompton's	129, 151

	PAGE
Compound Winding, Esson on	489
" " Frölich on	485
" " Gülcher's	142
" " Rücker on	488
" " Schuckert's	142
" " Siemens'	104, 156
" " Watson's	312
Constants of Dynamo	279, 481, 509
Constant-current Distribution	101, 315
Constant-potential Distribution	96, 300, 302
Construction, Principles of	17, 30
Continuity of Currents	25, 203, 251, 259
Copper, Deposition of	239
" Quality and Quantity of	32, 33, 112, 511
" in Armature, Weight of	112, 511
Cores	30, 36, 354, 499
Couple (<i>see</i> Torque).	
Coupling of Dynamos	335
Cost of Field Magnetism	42, 390, 391
Crompton-Bürgin Dynamo	128, 281, 498
Crompton-Kapp Dynamo	101, 129, 509
Crompton's Armature	130
Cunynghame	5
Current, Constant, Distribution with	101, 315
" " Arrangements for	79, 101, 202
" " Motors supplied with	444, 453
" " Economy of	202, 417
" Critical, of Machine	372, 376
" Diacritical, of Electro-magnet	285, 484
" Alternations of	14, 24, 332
" Continuity of	25, 203, 251, 259
" Equations of, in Series Machines	279, 481, 485
" " " in Shunt	291, 485
" " " in Compound	308, 485
" " " Frölich's	480
" " " Rücker's	488
Current Density	33, 510
Currents, Eddy	30, 40, 85, 88, 146, 168, 426
" Foucault's (<i>see</i> Eddy).	
" Parasitical (<i>see</i> Eddy).	
Curves of Magnetism	352
" of Torque	389
" of Potential at Collector	53, 147
" Characteristic	356, 457
" Frölich's, of Current	481
Cuttriss's Motor	429

D.

	PAGE
DAL NEGRO'S Motor	397
Dead Turns	83, 368, 484
Definition of Dynamo-machine	4
Davidson's Motor	400
De Meritens' Dynamo	214, 347
" Motor	431
Deprez, Marcel, Brake	464
" " Characteristic Curves	356, 359
" " Dynamo	39, 119
" " Experiments on Transmission of Power	420
" " on Field Magnets	39, 119, 151, 498
" " Law of Similars	273
" " on Self-Regulating Combinations	87
" " Method of Governing Dynamo	108, 504
" " Motors	428
Derivation (<i>see</i> Shunt).	
Diacritical Point (<i>see</i> Saturation).	
Diameter of Commutation	21, 73, 77, 493
Difference of Potential	94, 263
" " Constant	94, 302, 449
" " " Combinations for	96, 302
Discharge of Magnetism	370, 379
Discontinuity of Currents	25, 203, 251, 259, 260
Disk Armatures	28, 206
Disk Dynamo, Edison's	208
" " Faraday's	223
Dredge, James	8
Drum Armatures	26, 28, 152
Du Moncel, Count	5, 41
Dynamo, Name of	1, 4
" Classification of	15, 28, 91, 113
" Organs of	20
" Alternate-current	208, 325
" Open-coil	175
" Electroplating	231
" Non-polar	228
" Unipolar	225, 230
Dynamometer	109, 464, 466
Dynamometric Governing	108, 446, 508

E.

ECONOMIC Coefficient	267, 324, 391
Economy of Transmission	417
" Law of Maximum	414

	PAGE
Eddy Currents	30, 40, 85, 88, 146, 168, 426
" " Heating due to	88, 503
Edelmann's Dynamo	151
Edison's Dynamo	161
" " Armature of	164
" " Brushes of	47, 169
" " Field Magnets of	166, 497
" Disk Dynamo	208
" Tuning-fork Dynamo	228
Edison-Hopkinson Dynamo	168, 497, 510
Efficiency of Dynamo	267, 324, 463
" Transmission of Power	417
" " " Maximum	414
" Edison Dynamo	168
" Heinrichs' Dynamo	140
" Schuckert-Mordey Dynamo	148
" Motors	408, 469
Electro-magnets, Formulæ for	278, 356, 474
" Construction of	34, 95
" Cores of	36, 43, 133, 495
" Forms of	37, 43, 495
" Rules for Winding	40, 104, 281, 296, 310, 452
" Internal	37, 64, 126, 172
" Heating of	85
" Ventilation of	156
" Curve of Saturation of	353
Electro-metallurgy	231
Electromotive Force, of Dynamo	7, 51, 242, 480
" " and Difference of Potential	263
" " Average	242
" " Fluctuations of	25, 259
Electro-plating, Dynamos for	32, 92, 155, 231
Elmore's Dynamos	30, 234
Elphinstone, Lord, and Vincent, C. W.	16, 39, 172
Emmerson and Murgatroyd's Gramme Dynamo	512
Energy, Electric	1, 111, 268, 463
" Expended	82, 411, 416
" Utilised	402, 416, 463
" Transmission of	416, 420
Equations of Dynamo	241, 279, 291, 330, 480
" " Frölich's	485
" " Rücker's	488
" of Electro-magnets	356, 474
" of Motors	449
Esson, W. B., on Separately-excited Machines	365
" " on Self-regulating Machines	489
" " on Teeth of Armature	503

	PAGE
Excitation of Field Magnets, Methods of	91
" Electro-magnet, Law of	356, 474
Exciter, Separate, use of Machine as	3, 91, 210, 328

F.

FARADAY'S Invention of the Dynamo	1, 3, 223
" Principle	3, 243, 480
" Disk Machine	223
" Rotating Magnet	224
Fein's Dynamo	151
Ferranti's Dynamo	217
Field, Magnetic	8, 10, 64, 78, 262, 394
" " Measurement of	262
Field Magnets, Construction of	34, 281, 495
" " Coils for	40, 104, 499
" " Forms of	37, 43, 156, 495
" " Formulæ for	278, 356, 474
" " Heating of	85
" " Proper Resistance of	41, 281, 295, 323, 510
" " Rules for Winding	{ 41, 281, 296, 305, 307, 310, 313, 316, 320, 322, 450, 452, 454, 499
Figures, Magnetic	9, 10, 64, 78, 492
Fitzgerald's Dynamo	151
Flat-ring Armatures	140
" " Advantages of	150
Fluctuations of Current	25, 203, 251, 259
" " Measurement of	260
Forbes' Dynamo	227
Forms of Electro-magnets	37, 43, 156, 495
Formulæ for Electro-magnets	278, 356, 474
Foucault Currents (<i>see</i> Eddy Currents).	
Friction, Magnetic	471, 492
Frölich, Dr. O.	277, 314, 323, 359, 388, 389, 455, 476, 480
" " Curve of Current	481
" " Equations of Dynamo	485
" " Recent Researches	480
Froment's Motors	400, 428
Fuller-Gramme Dynamo	118

G.

GANZ (<i>see</i> Zipernowsky).	
Gaugain, J. M., on Curves of Induction	69
Gauss, the, as Magnetic Unit	242, 246
Generator, the Dynamo as	5, 389
Geometric Theory of Dynamo	350

	PAGE
Gordon's Dynamo	212
Governing Dynamos	91, 504
" Motors	445
Governors, Automatic, Brush's	105, 108
" " Dynamometric	108
" " Edison's	106
" " Hochhausen's	107
" " Jamieson's	507
" " Lane-Fox's	107
" " Maxim's	107
" " Richardson's	504
" " Thomson-Houston's	198, 509
" " Willans'	505
Gramme's Dynamo, Armature of	115, 116, 124
" " Characteristic of	366
" " Potential at Collector of	53
" " as Motor	428, 436
" " Multipolar	149
" " Alternate-current	214
" " Auto-excitatrice	216
" " for Transmission of Power	428
Griscom's Motor	429, 498
Gülcher's Dynamo	142
" " Characteristic of	385
" " Compound Winding	142

H.

HAMMOND (<i>see</i> Ferranti).	
Heating of Armatures	33, 137, 165, 168, 213
" Cores	31, 85
" Magnets	85
" Pole-pieces	87
Heinrich's Dynamo	140
Henry's Motor	397
Higgs, Paget	93, 104
Hjörth, Soren, his Combined Dynamo	99
" " his Motor	400
Hochhausen's Dynamo	126, 498
Holmes's Dynamo	208
Hopkinson, Dr. Edward, on Curves of Motors	457
" " " Field Magnets of Dynamo	139, 498
" " " and Dr. J. Hopkinson, Armature	139
Hopkinson, Dr. John, on Reactions in Armature	74
" " " Applications of Characteristics	356, 373, 386, 459
" " " Discovery of Curves afterwards called Characteristics	356

	PAGE
Hopkinson, Dr. John, Reversing Gear	439
" " " Electric Lift	431
" " " on Coupling of Dynamos	341
" " " Modification of Edison Dynamo	166
" " " and A. Muirhead, their Dynamo	205
Horse-power of Dynamos	III, 360, 464
Hospitalier, E.	101
Houston-Thomson (<i>see</i> Thomson-Houston).	

I.

INDICATOR Diagrams	350, 359, 464
Inertia, Electric (<i>see</i> Self-Induction)	80
" Magnetic	84, 490
" Mechanical	80, 437
Induction, Process of	7, 49
" Magnetic	39, 278, 287
" Curves of	38, 58, 250
" False	58
" Self-	8, 80, 82, 84, 326, 333, 426, 472
" Mutual	83, 212, 472
Instability of Magnetism	376, 387
" of Arc-light	373
Insulation of Coils	33, 181
" of Collector	46, 128, 139, 161, 463
" Testing of	463
Integration of Curves	51, 58
Iron, Importance of Quality and Quantity of	36, 38, 43, 133, 134
" Permeability of	39, 277, 287, 478
" Saturation of	277, 282, 284, 352, 474
Isenbeck, Dr. Aug., Researches by	56

J.

JABLOCHKOFF, P.	28, 220
Jamieson's Electric Governor	507
Jacobi's Motor	396, 401
" Law of Electro-magnet	474
" Law of Maximum Activity	405, 413
" Commutator	210, 396
" Electric Boat	396
Joel's Dynamo	139
Joubert, J., on Self-induction	332
" " on Speed of Machines	351
Joule, J. P., on Electric Motor	405, 416
" " Form of Electro-magnet	218, 437
" " Law of	474
Jürgensen's Dynamo	126, 498

K.

	PAGE
KAPP, Gisbert, on Compound Winding	101
" " Dynamo	134, 497, 510
" " Formula for Dynamo	133
" " Graphic Diagram for Motors	460
" " (<i>see</i> Crompton and Kapp).	

L.

LACHAUSSÉE'S Dynamo	209, 211
Lag, alleged Magnetic	84, 490
Lamination of Cores and Pole-pieces	31, 44, 87, 134, 188, 206, 491
Lamont's Formula for Electro-magnet	477
Lane-Fox's Dynamo	205
Lead of Brushes	21, 45, 73, 77, 85, 107, 196, 424
Leipner's Dynamo	205
Lenz, Law of Induction	426
" and Jacobi (<i>see</i> Jacobi).	
Lever's Dynamo	229
Line, Neutral	54, 77, 79, 493
Lines of Magnetic Force	5, 7, 8, 9, 10, 64, 78, 243, 492
Lodge, Oliver J., Calculation of Fluctuations	<i>See</i> Preface and p. 255
" " on Spurious Resistance	82
Lontin's Dynamo	30, 213
Lorenz (<i>see</i> Jürgensen).	
Lumley's Dynamo	137, 172

M.

MAGNETIC Circuit	38, 495, 500
" Field	8, 10, 64, 78, 262, 394, 495
" Induction, Coefficient of	39, 278, 287
Magnetisation	474
" Resultant	70, 424
" Saturation of	352, 474
" Methods of	91
" Residual	380
Magneto-electric Machine	4, 261, 364
Magnets (<i>see</i> Field Magnets).	
Mascart on Dynamo	334
Mather and Hopkinson's Dynamo	139
Maxim's Dynamo	124
Maxwell, J. Clerk	334, 397, 475
Mechwart (<i>see</i> Zipernowsky).	

	PAGE
Moorsom, W. M (<i>see</i> Preface).	
Mordey, W. M., on Distribution of Potential	53
" " Improvements in Schuckert Dynamo	56, 144
" " on Movement of Neutral Point	493
" " on Coupling of Dynamos	337
" " on Influence of Pole-pieces	144, 501
" " on Eddy-currents in Motors	426
" " on Governing Motors	455
Motors, Theory of	404
" Efficiency of	402, 404, 414
" Government of	445
Müller's Formula	474
Munich, Tests at	420

N.

NAME "Dynamo-electric"	1, 4
Neutral Point	54, 77, 79, 493
Newton, F. M., Dynamo	201
" " Experiments on alleged Magnetic Lag	492
Niaudet, Alfred	5, 64
" " his Dynamo	204
" " his Armature	31, 83, 204
" " on Gramme Dynamo	64, 116
Notation, Algebraic	241

O.

OHM, Dr. G. S., Law of	7, 288, 405, 480
<i>Ohm</i> , the, Unit of Resistance	148, 168
Open-coil Dynamos	27, 175, 202
Organs of Dynamos	20
Output of Dynamos	111, 511

P.

PACINOTTI'S Dynamo	113
" Armature	66, 114, 502
" Commutator	114
Page's Motor	397, 447
Parallel-Arc, Coupling of Dynamos in	336
" Coupling of Coils in	23, 221
Paterson and Cooper's Dynamo	136, 498, 502
Permeability of Iron	39, 278, 287, 478

	PAGE
Perry, John, his Dynamo	29
,, Self-regulating Combinations	97, 102
,, (see Ayrton and Perry).	
Phoenix Dynamo (see Paterson and Cooper).	
Pixii's Dynamo	30, 204
Point, Diacritical, of Saturation	285, 286, 354, 484, 499
,, Dead, of Motor	429, 437
,, Neutral	54, 77, 79, 493
,, " Shifting of	79, 493
Pole-armatures	30, 33, 213, 233
Pole-pieces	40, 498, 501
,, Form of	40, 63, 498
,, Heating of	87
Poles	8, 38, 495
,, Consequent	38, 497
,, Salient	121, 498
,, Resultant	77, 424
Pollard, J., Experiment by	110
Potential, Curves of Distribution of	53, 147
,, Constant, Combinations for	96, 300
,, " Distribution with	96, 300, 302, 449
,, Difference of, at Terminals	262, 264
R.	
RADIAN, Unit of Angle	242, 244
Rapieff's Zigzag Armature	220
Reactions of Armature and Field Magnet in Dynamo	70
,, " " in Motor	423
Reckenzaun's Motor	435, 439
Regulation, Automatic (see Governors).	
Regulators (see Governors).	
Resistance	7, 31, 41, 94, 105, 106, 410
,, of Circuit	242, 269
,, of Dynamo	242, 363, 369, 372
,, spurious, of Armature	81, 331
,, in the Characteristic	369
,, Unit of, the <i>Ohm</i>	242
,, Insulation	33, 463
,, Magnetic	39, 500
Retardation of Phase in Alternate-current Dynamos	330, 341
Reversing Gear	439
Richter, Ernst, on Siemens' Dynamos	157
,, " on Difference of Potential	284
Ring Armatures	28, 66, 70, 113, 188, 502
Ritchie's Motor	395
Rowland, Henry A., on Magnetism	495, 500

S.		PAGE
SATURATION, Magnetic, Effects of	36, 277, 282, 284, 310, 314, 324, 352,	383, 474, 489, 503
" " " " " " " "	Formulae for	277, 352, 474
" " " " " " " "	Diacritical Point of	285, 353, 484, 489, 499
Saturation, Magnetic, Curve of	353
Scharnweber (<i>see</i> Schwerd).		
Schellen, H.	5, 152
Schuckert's Dynamo	140
Schuckert-Mordey Dynamo	144
Schwerd's Dynamo	151
Self-induction	8, 80, 82, 84, 326, 333, 426, 472
" " " " " " " "	Coefficient of	326, 472
Self-governed Motors	448
Self-regulating Dynamos	94, 299
Separately-excited Dynamo	3, 91, 266, 365
Series, Coupling Dynamos in	335
Series Dynamo	1, 91, 276, 357
Short Circuit	33, 81
" " " " " " " "	Magnetic	40, 495, 500
Shunt Dynamo	2, 92, 288, 376, 455
Siemens, Dynamo (old)	22, 152
" " " " " " " "	(new)	152, 160
" " " " " " " "	Field Magnet of	38, 161
" " " " " " " "	Winding of Armature	153, 155
" " " " " " " "	Alternate-current	210
" " " " " " " "	for Electroplating	32, 155, 237
" " " " " " " "	"Topf-Maschine"	152, 432
" " " " " " " "	Unipolar	225
" " " " " " " "	New Types	159, 161
" " " " " " " "	Compound, Winding of	156, 323
" " " " " " " "	Characteristics of	357, 377, 385
Siemens, Werner, Shuttle-wound Armature	22
" " " " " " " "	Invents Name of Dynamo	I
Siemens, Sir William, Law of Efficiency of Motors	414
" " " " " " " "	on Transmission of Power	418
" " " " " " " "	on Shunt Dynamo	376
" " " " " " " "	on Instability of Arc Light	373
Siemens, Alexander, on Compound Winding	101
" " " " " " " "	on Torque of Motors	443
" " " " " " " "	Graphic Constructions	457
Slow-speed Dynamos	132, 134, 148, 220, 371
Smith, Frederick J., Dynamometer	109, 446, 467
" " " " " " " "	Testing Motors	469
Smith, Willoughby, Induction Experiment	492
Sohncke, Formula for Electro-magnet	477
Sparking, Cause of	60, 79, 425

	PAGE
Sparkng, Prevention of	79, 85, 425
Speed, Critical, of Dynamo	97, 302, 372
" " " Esson on 489
" " of Motor 448, 450
" in Relation to Power 17, 275
Sprague, F. J., Tests of Edison-Hopkinson Dynamo ..	168, 292, 392
" on Regulation of Motors 447
Stöhrer's Dynamo 208
Sturgeon's Disk 223, 397
Symbols, List of 241
Swan, Joseph W. 101
Swinburne, J. 101

T.

TEAZER Circuit	99, 180, 238
Testing Dynamos and Motors 462
Theory of Dynamo, Physical 7
" " Algebraic 241
" " Geometrical 350
" " Alternate-current 325
" " Series-wound 276
" " Shunt-wound 288
" " Compound-wound 308, 320
" " Recent Advances in 480
" Motors 404, 448
" Transmission of Power 414
Thomson-Houston Dynamo 190
" " " Armature of 192
" " " Automatic Regulator 199
" " " Commutator 193
" " " Air-blast 199
" " " Field Magnets	190, 499
Thomson, Elihu (<i>see</i> Thomson-Houston).	
" " Automatic Regulator 509
Thomson, Sir William, Alternate-current Dynamo 217
" " Mousemill Dynamo 201
" " Rotating Brushes 47, 202
" " Rules for Winding Dynamos	41, 295
" " Wheel Dynamo 202
Thury's Dynamo 174
Topf Maschine 152, 432
Torque	108, 242, 388, 442, 465
Transmission Dynamometer	109, 464, 466, 509
Transmission of Power 416
Trouvé's Motor 400

U.

	PAGE
UNBUILDING of Dynamo	370, 379
Unipolar Dynamo	225
Uni-pole-piece Dynamo	230, 501
Unit of Electromotive-force	246
„ of Intensity of Magnetic Field	246
„ of Output (Board of Trade Unit)	111

V.

VARLEY, S. Alfred, Rotating Brushes	47
„ „ Unipolar Dynamo	224
Ventilation of Armature	33, 129, 130, 135, 139, 151, 165
„ Commutator	46, 199
„ Field Magnets	156
Victoria Dynamo (<i>see</i> Schuckert-Mordey).	
Vincent, C. W. (<i>see</i> Elphinstone and Vincent).	
Voice's Dynamo	226
Volt, the, Unit of Electromotive-force	246
Volt-ampère (<i>see</i> Watt).	

W.

WALLACE-FARMER Dynamo	204
„ „ Armature	31, 205
Watt, the, Unit of Electric Activity	111
Weston's Dynamo	170, 233
„ „ Field Magnets of	171, 497
Wheatstone's, Sir Charles, Shunt Dynamo	2
„ „ Motors	400
Wheel Dynamo (Thomson's)	202
Wiesendanger's Motor	400
Wilde's Dynamos	3, 208, 231
„ Researches on Coupling of Dynamos	341
Willans' Electric Governor	505

Z.

ZIPERNOWSKY'S Dynamo	174, 220
------------------------------	----------

191

LONDON:
PRINTED BY WILLIAM CLOWES AND SONS, LIMITED,
STAMFORD STREET AND CHARING CROSS.



as

a

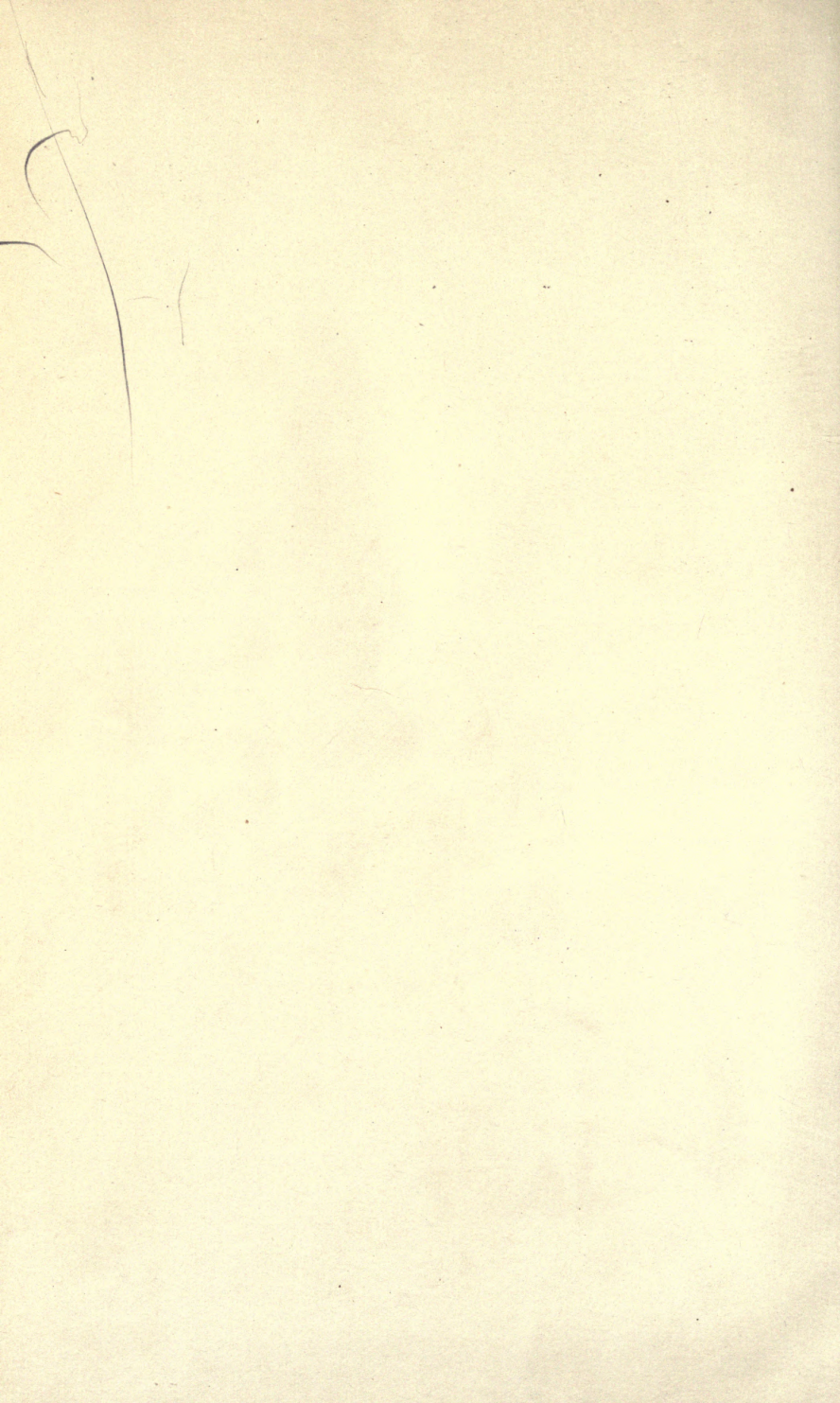

THIS BOOK IS DUE ON THE LAST DATE
STAMPED BELOW

AN INITIAL FINE OF 25 CENTS
WILL BE ASSESSED FOR FAILURE TO RETURN
THIS BOOK ON THE DATE DUE. THE PENALTY
WILL INCREASE TO 50 CENTS ON THE FOURTH
DAY AND TO \$1.00 ON THE SEVENTH DAY
OVERDUE.

FEB 21 1941 M

JUN 05 1990

LD 21-100m-7,'39 (402s)

YU 15822

U.C. BERKELEY LIBRARIES

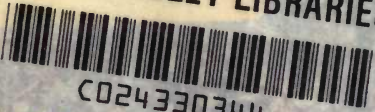

C024330344

TK2181

T4

Thompson

30264

